

# ETSI TS 134 122 V9.5.0 (2011-08)



**Universal Mobile Telecommunications System (UMTS);  
Terminal conformance specification;  
Radio transmission and reception (TDD)  
(3GPP TS 34.122 version 9.5.0 Release 9)**



---

Reference

RTS/TSGR-0534122v950

---

Keywords

UMTS

**ETSI**

650 Route des Lucioles  
F-06921 Sophia Antipolis Cedex - FRANCE

Tel.: +33 4 92 94 42 00 Fax: +33 4 93 65 47 16

Siret N° 348 623 562 00017 - NAF 742 C  
Association à but non lucratif enregistrée à la  
Sous-Préfecture de Grasse (06) N° 7803/88

---

**Important notice**

Individual copies of the present document can be downloaded from:

<http://www.etsi.org>

The present document may be made available in more than one electronic version or in print. In any case of existing or perceived difference in contents between such versions, the reference version is the Portable Document Format (PDF). In case of dispute, the reference shall be the printing on ETSI printers of the PDF version kept on a specific network drive within ETSI Secretariat.

Users of the present document should be aware that the document may be subject to revision or change of status.

Information on the current status of this and other ETSI documents is available at

<http://portal.etsi.org/tb/status/status.asp>

If you find errors in the present document, please send your comment to one of the following services:

[http://portal.etsi.org/chaicor/ETSI\\_support.asp](http://portal.etsi.org/chaicor/ETSI_support.asp)

---

**Copyright Notification**

No part may be reproduced except as authorized by written permission.  
The copyright and the foregoing restriction extend to reproduction in all media.

© European Telecommunications Standards Institute 2011.

All rights reserved.

DECT™, PLUGTESTS™, UMTS™ and the ETSI logo are Trade Marks of ETSI registered for the benefit of its Members.  
3GPP™ and LTE™ are Trade Marks of ETSI registered for the benefit of its Members and  
of the 3GPP Organizational Partners.

GSM® and the GSM logo are Trade Marks registered and owned by the GSM Association.

---

## Intellectual Property Rights

IPRs essential or potentially essential to the present document may have been declared to ETSI. The information pertaining to these essential IPRs, if any, is publicly available for **ETSI members and non-members**, and can be found in ETSI SR 000 314: *"Intellectual Property Rights (IPRs); Essential, or potentially Essential, IPRs notified to ETSI in respect of ETSI standards"*, which is available from the ETSI Secretariat. Latest updates are available on the ETSI Web server (<http://ipr.etsi.org>).

Pursuant to the ETSI IPR Policy, no investigation, including IPR searches, has been carried out by ETSI. No guarantee can be given as to the existence of other IPRs not referenced in ETSI SR 000 314 (or the updates on the ETSI Web server) which are, or may be, or may become, essential to the present document.

---

## Foreword

This Technical Specification (TS) has been produced by the ETSI 3<sup>rd</sup> Generation Partnership Project (3GPP).

The present document may refer to technical specifications or reports using their 3GPP identities, UMTS identities or GSM identities. These should be interpreted as being references to the corresponding ETSI deliverables.

The cross reference between GSM, UMTS, 3GPP and ETSI identities can be found under <http://webapp.etsi.org/key/queryform.asp>.

# Contents

Intellectual Property Rights .....	2
Foreword.....	2
Foreword.....	42
1 Scope .....	43
2 References .....	43
3 Definitions, abbreviations and equations .....	44
3.1 Definitions .....	44
3.2 Abbreviations .....	45
3.3 Equations.....	46
4 Frequency bands and channel arrangement.....	46
4.1 General .....	46
4.2 Frequency bands.....	46
4.3 TX–RX frequency separation.....	46
4.3.1 3,84 Mcps TDD Option .....	46
4.3.2 1,28 Mcps TDD Option .....	46
4.3.3 7,68 Mcps TDD Option .....	47
4.4 Channel arrangement.....	47
4.4.1 Channel spacing.....	47
4.4.1.1 3,84 Mcps TDD Option.....	47
4.4.1.2 1,28 Mcps TDD Option.....	47
4.4.1.3 7,68 Mcps TDD Option.....	47
4.4.2 Channel raster .....	47
4.4.3 Channel number .....	47
4.4.4 UARFCN (3,84 Mcps TDD Option) .....	47
4.4.4A UARFCN (1.28 Mcps TDD Option) .....	47
4.4.5 UARFCN (7,68 Mcps TDD Option) .....	48
5 Transmitter Characteristics.....	48
5.1 General .....	48
5.2 User Equipment maximum output power.....	49
5.2.1 Definition and applicability .....	49
5.2.2 Minimum Requirements .....	49
5.2.2.1 3.84 Mcps TDD option .....	49
5.2.2.2 1.28 Mcps TDD option .....	49
5.2.2.3 7.68 Mcps TDD option .....	50
5.2.3 Test purpose.....	50
5.2.4 Method of test .....	51
5.2.4.1 Initial conditions .....	51
5.2.4.1.1 3,84 Mcps TDD Option.....	51
5.2.4.1.2 1,28 Mcps TDD Option.....	51
5.2.4.1.3 7,68 Mcps TDD Option.....	52
5.2.4.2 Procedure .....	52
5.2.5 Test Requirements .....	52
5.2.5.2 1.28 Mcps TDD Option.....	53
5.2.5.3 7.68 Mcps TDD Option.....	53
5.2A User Equipment maximum output power with E-DCH.....	54
5.2A.1 Definition and applicability .....	54
5.2A.2 Minimum Requirements .....	54
5.2A.2.1 3.84 Mcps TDD option .....	54
5.2A.2.2 1.28 Mcps TDD option .....	54
5.2A.2.3 7.68 Mcps TDD option .....	54
5.2A.3 Test purpose.....	54
5.2A.4 Method of test .....	55
5.2A.4.1 Initial conditions .....	55

5.2A.4.1.1	3,84 Mcps TDD Option .....	55
5.2A.4.1.2	1,28 Mcps TDD Option .....	55
5.2.4.1.3	7,68 Mcps TDD Option .....	55
5.2A.4.2	Procedure .....	55
5.2A.5	Test requirements .....	56
5.2A.5.1	3.84 Mcps TDD Option .....	56
5.2A.5.2	1.28 Mcps TDD Option .....	56
5.2A.5.3	7.68 Mcps TDD Option .....	56
5.2B	User Equipment maximum output power with HS-SICH and DPCH .....	56
5.2B.1	Definition and applicability .....	56
5.2B.2	Minimum Requirements .....	57
5.2B.2.1	3.84 Mcps TDD option .....	57
5.2B.2.2	1.28 Mcps TDD option .....	57
5.2B.2.3	7.68 Mcps TDD option .....	57
5.2B.3	Test purpose .....	57
5.2B.4	Method of test .....	57
5.2B.4.1	Initial conditions .....	57
5.2B.4.2	Procedure .....	57
5.2B.5	Test requirements .....	58
5.2B.5.1	3.84 Mcps TDD Option .....	58
5.2B.5.2	1.28 Mcps TDD Option .....	58
5.2B.5.3	7.68 Mcps TDD Option .....	58
5.3	UE frequency stability .....	58
5.3.1	Definition and applicability .....	58
5.3.2	Minimum Requirements .....	59
5.3.3	Test purpose .....	59
5.3.4	Method of test .....	59
5.3.4.1	Initial conditions .....	59
5.3.4.1.1	3,84 Mcps TDD Option .....	59
5.3.4.1.2	1,28 Mcps TDD Option .....	59
5.3.4.1.3	7,68 Mcps TDD Option .....	59
5.3.4.2	Procedure .....	60
5.3.5	Test Requirements .....	60
5.4	Output Power Dynamics .....	60
5.4.1	Uplink power control .....	60
5.4.1.1	Initial accuracy (3,84 Mcps TDD Option) .....	60
5.4.1.1.1	Definition and applicability .....	60
5.4.1.1.2	Minimum requirements .....	60
5.4.1.1.3	Test purpose .....	60
5.4.1.1.4	Method of test .....	61
5.4.1.1.5	Test requirements .....	61
5.4.1.2	Differential accuracy, controlled input (3,84 Mcps TDD Option) .....	62
5.4.1.2.1	Definition and applicability .....	62
5.4.1.2.2	Minimum requirements .....	62
5.4.1.2.3	Test purpose .....	62
5.4.1.2.4	Method of test .....	62
5.4.1.2.5	Test requirements .....	63
5.4.1.2A	Differential accuracy, controlled input .....	64
5.4.1.3	Open loop power control (1,28 Mcps TDD Option) .....	64
5.4.1.3.1	Definition and applicability .....	64
5.4.1.3.2	Minimum requirements .....	64
5.4.1.3.3	Test purpose .....	64
5.4.1.3.4	Method of test .....	64
5.4.1.3.5	Test requirements .....	65
5.4.1.4	Closed loop power control (1,28 Mcps TDD Option) .....	66
5.4.1.4.1	Definition and applicability .....	66
5.4.1.4.2	Minimum requirements .....	66
5.4.1.4.3	Test purpose .....	66
5.4.1.4.4	Method of test .....	66
5.4.1.4.5	Test requirements .....	67
5.4.1.5	Initial accuracy (7,68 Mcps TDD Option) .....	68
5.4.1.5.1	Definition and applicability .....	68

5.4.1.5.2	Minimum requirements .....	68
5.4.1.5.3	Test purpose .....	68
5.4.1.5.4	Method of test.....	68
5.4.1.5.4.1	Initial conditions .....	68
5.4.1.5.4.2	Procedure .....	69
5.4.1.5.5	Test requirements .....	69
5.4.2	Minimum output power .....	69
5.4.2.1	Definition and applicability.....	69
5.4.2.2	Minimum Requirements.....	69
5.4.2.2.1	3,84Mcps TDD Option.....	69
5.4.2.2.2	1,28Mcps TDD Option.....	69
5.4.2.2.3	7,68Mcps TDD Option.....	70
5.4.2.3	Test purpose .....	70
5.4.2.4	Method of test .....	70
5.4.2.4.1	Initial conditions .....	70
5.4.2.4.2	Procedure.....	70
5.4.2.5	Test requirements.....	70
5.4.2.5.1	3,84 Mcps TDD Option.....	70
5.4.2.5.2	1,28 Mcps TDD Option.....	70
5.4.2.5.3	7,68 Mcps TDD Option.....	70
5.4.3	Transmit OFF power.....	71
5.4.3.1	Definition and applicability.....	71
5.4.3.2	Minimum Requirements.....	71
5.4.3.3	Test purpose .....	71
5.4.3.4	Method of test .....	71
5.4.3.5	Test requirements.....	71
5.4.4	Transmit ON/OFF Time mask.....	71
5.4.4.1	Definition and applicability.....	71
5.4.4.2	Minimum requirements .....	71
5.4.4.2.1	3,84Mcps TDD Option.....	71
5.4.4.2.2	1,28Mcps TDD Option.....	72
5.4.4.2.3	7,68Mcps TDD Option.....	72
5.4.4.3	Test Purpose .....	73
5.4.4.4	Method of test .....	73
5.4.4.4.1	Initial conditions .....	73
5.4.4.4.2	Procedure.....	73
5.4.4.5	Test requirements .....	73
5.4.5	Out-of-synchronisation handling of output power for continuous transmission.....	74
5.4.5.1	Definition and applicability.....	74
5.4.5.2	Minimum Requirement .....	74
5.4.5.2.1	3,84 Mcps TDD Option.....	74
5.4.5.2.2	1,28 Mcps TDD Option.....	75
5.4.5.2.3	7,68 Mcps TDD Option.....	76
5.4.5.3	Test purpose .....	77
5.4.5.4	Method of test .....	78
5.4.5.4.1	Initial conditions .....	78
5.4.5.4.2	Procedure.....	78
5.4.5.5	Test Requirements.....	79
5.4.6	Out-of-synchronisation handling of output power for discontinuous transmission .....	79
5.4.6.1	Definition and applicability.....	79
5.4.6.2	Minimum Requirement .....	80
5.4.6.2.1	3,84 Mcps TDD Option.....	80
5.4.6.2.2	1,28 Mcps TDD Option.....	81
5.4.6.2.3	7,68 Mcps TDD Option.....	82
5.4.6.3	Test purpose .....	83
5.4.6.4	Method of test .....	84
5.4.6.4.1	Initial conditions .....	84
5.4.6.4.2	Procedure.....	84
5.4.6.5	Test Requirements.....	85
5.5	Output RF spectrum emissions.....	85
5.5.1	Occupied bandwidth .....	85
5.5.1.1	Definition and applicability.....	85

5.5.1.2	Minimum Requirements.....	85
5.5.1.2.1	3,84Mcps TDD Option.....	85
5.5.1.2.2	1,28Mcps TDD Option.....	85
5.5.1.2.3	7,68Mcps TDD Option.....	86
5.5.1.3	Test purpose.....	86
5.5.1.4	Method of test.....	86
5.5.1.4.1	Initial conditions.....	86
5.5.1.4.2	Procedure.....	86
5.5.1.5	Test requirements.....	86
5.5.1.5.1	3,84 Mcps TDD Option.....	86
5.5.1.5.2	1,28 Mcps TDD Option.....	87
5.5.1.5.3	7,68 Mcps TDD Option.....	87
5.5.2	Out of band emission.....	87
5.5.2.1	Spectrum emission mask.....	87
5.5.2.1.1	Definition and applicability.....	87
5.5.2.1.1.1	3,84 Mcps TDD Option.....	87
5.5.2.1.1.2	1,28 Mcps TDD Option.....	87
5.5.2.1.1.3	7,68 Mcps TDD Option.....	87
5.5.2.1.2	Minimum Requirements.....	87
5.5.2.1.2.1	3,84 Mcps TDD Option.....	87
5.5.2.1.2.2	1,28 Mcps TDD Option.....	88
5.5.2.1.2.3	7,68 Mcps TDD Option.....	88
5.5.2.1.3	Test purpose.....	89
5.5.2.1.4	Method of test.....	89
5.5.2.1.5	Test requirements.....	90
5.5.2.1.5.1	3,84 Mcps TDD Option.....	90
5.5.2.1.5.2	1,28 Mcps TDD Option.....	91
5.5.2.1.5.3	7,68 Mcps TDD Option.....	92
5.5.2.1A	Spectrum emission mask.....	92
5.5.2.1A.1	Definition and applicability.....	92
5.5.2.1A.2	Minimum Requirements.....	92
5.5.2.1A.3	Test purpose.....	93
5.5.2.1A.4	Method of test.....	93
5.5.2.1A5	Test requirements.....	94
5.5.2.1B	Spectrum emission mask.....	94
5.5.2.1B.1	Definition and applicability.....	94
5.5.2.1B.2	Minimum Requirements.....	95
5.5.2.1B.3	Test purpose.....	95
5.5.2.1B.4	Method of test.....	95
5.5.2.1B5	Test requirements.....	96
5.5.2.2	Adjacent Channel Leakage power Ratio (ACLR).....	96
5.5.2.2.1	Definition and applicability.....	96
5.5.2.2.2	Minimum Requirements.....	97
5.5.2.2.2.1	3,84Mcps TDD Option.....	97
5.5.2.2.2.2	1,28Mcps TDD Option.....	97
5.5.2.2.2.3	7,68Mcps TDD Option.....	97
5.5.2.2.3	Test purpose.....	97
5.5.2.2.4	Method of test.....	98
5.5.2.2.5	Test requirements.....	98
5.5.2.2.5.1	3,84 Mcps TDD Option.....	98
5.5.2.2.5.2	1,28 Mcps TDD Option.....	98
5.5.2.2.5.3	7,68 Mcps TDD Option.....	99
5.5.2.2A	Adjacent Channel Leakage power Ratio (ACLR) with E-DCH.....	99
5.5.2.2A.1	Definition and applicability.....	99
5.5.2.2A.2	Minimum Requirements.....	99
5.5.2.2A.2.1	3,84Mcps TDD Option.....	99
5.5.2.2A.2.2	1,28Mcps TDD Option.....	99
5.5.2.2A.2.3	7,68Mcps TDD Option.....	100
5.5.2.2A.3	Test purpose.....	100
5.5.2.2A.4	Method of test.....	100
5.5.2.2A.5	Test requirements.....	100
5.5.2.2A.5.1	3,84 Mcps TDD Option.....	100

5.5.2.2A.5.2	1,28 Mcps TDD Option .....	100
5.5.2.2A.5.3	7,68 Mcps TDD Option .....	101
5.5.2.2B	Adjacent Channel Leakage power Ratio (ACLR) with HS-SICH and DPCH .....	101
5.5.2.2B.1	Definition and applicability .....	101
5.5.2.2B.2	Minimum Requirements .....	101
5.5.2.2B.2.1	3,84Mcps TDD Option .....	101
5.5.2.2B.2.2	1,28Mcps TDD Option .....	101
5.5.2.2B.2.3	7,68Mcps TDD Option .....	101
5.5.2.2B.3	Test purpose .....	101
5.5.2.2B.4	Method of test.....	102
5.5.2.2B.5	Test requirements .....	102
5.5.2.2B.5.1	3,84 Mcps TDD Option .....	102
5.5.2.2B.5.2	1,28 Mcps TDD Option .....	102
5.5.2.2B.5.3	7,68 Mcps TDD Option .....	102
5.5.3	Spurious emissions .....	102
5.5.3.1	Definition and applicability.....	102
5.5.3.2	Minimum Requirements.....	103
5.5.3.2.1	3,84 Mcps TDD Option.....	103
5.5.3.2.2	1,28Mcps TDD Option.....	103
5.5.3.2.3	7,68 Mcps TDD Option.....	104
5.5.3.3	Test purpose .....	105
5.5.3.3.1	3,84 Mcps Option .....	105
5.5.3.3.2	1,28 Mcps Option .....	105
5.5.3.3.3	7,68 Mcps Option .....	105
5.5.3.4	Method of test .....	105
5.5.3.4.1	Initial conditions .....	105
5.5.3.4.2	Procedure.....	105
5.5.3.5	Test requirements.....	106
5.5.3.5.1	3,84 Mcps TDD Option.....	106
5.5.3.5.2	1,28 Mcps TDD Option.....	106
5.5.3.5.3	7,68 Mcps TDD Option.....	107
5.6	Transmit Intermodulation.....	108
5.6.1	Definition and applicability .....	108
5.6.2	Minimum Requirements .....	108
5.6.2.1	3,84 Mcps TDD Option.....	108
5.6.2.2	1,28 Mcps TDD Option.....	108
5.6.2.3	7,68 Mcps TDD Option.....	109
5.6.3	Test purpose.....	109
5.6.4	Method of test .....	109
5.6.4.1	Initial conditions .....	109
5.6.4.2	Procedure .....	109
5.6.4.2.1	3,84 Mcps TDD Option.....	109
5.6.4.2.2	1,28 Mcps TDD Option.....	110
5.6.4.2.3	7,68 Mcps TDD Option.....	110
5.6.5	Test requirements.....	110
5.6.5.1	3,84 Mcps TDD Option.....	110
5.6.5.2	1,28 Mcps TDD Option.....	110
5.6.5.3	7,68 Mcps TDD Option.....	111
5.7	Transmit Modulation.....	111
5.7.1	Error Vector Magnitude.....	111
5.7.1.1	Definition and applicability.....	111
5.7.1.2	Minimum Requirements.....	111
5.7.1.3	Test purpose .....	111
5.7.1.4	Method of test .....	111
5.7.1.4.1	Initial conditions .....	111
5.7.1.4.2	Procedure.....	112
5.7.1.5	Test requirements.....	112
5.7.1A	Error Vector Magnitude with E-DCH16QAM .....	112
5.7.1A.1	Definition and applicability.....	112
5.7.1A.2	Minimum Requirements.....	112
5.7.1A.4	Method of test .....	112
5.7.1A.4.1	Initial conditions.....	112



5.7.1A.4.2	Procedure.....	113
5.7.1A.5	Test requirements.....	113
5.7.1B	Error Vector Magnitude with HS-SICH and DPCH.....	113
5.7.1B.1	Definition and applicability.....	113
5.7.1B.2	Minimum Requirements.....	113
5.7.B1.3	Test purpose.....	114
5.7.1B.4	Method of test.....	114
5.7.1B.4.1	Initial conditions.....	114
5.7.1B.4.2	Procedure.....	114
5.7.1B.5	Test requirements.....	114
5.7.2	Peak code domain error.....	114
5.7.2.1	Definition and applicability.....	114
5.7.2.2	Minimum Requirement.....	115
5.7.2.3	Test purpose.....	115
5.7.2.4	Method of test.....	115
5.7.2.4.1	Initial conditions.....	115
5.7.2.4.1.1	3,84 Mcps TDD Option.....	115
5.7.2.4.1.2	1,28 Mcps TDD Option.....	115
5.7.2.4.1.3	7,68 Mcps TDD Option.....	115
5.7.2.4.2	Procedure.....	116
5.7.2.5	Test requirements.....	116
6	Receiver Characteristics.....	116
6.1	General.....	116
6.2	Reference sensitivity level.....	117
6.2.1	Definition and applicability.....	117
6.2.2	Minimum Requirements.....	117
6.2.2.1	3,84 Mcps TDD Option.....	117
6.2.2.2	1,28 Mcps TDD Option.....	117
6.2.2.3	7,68 Mcps TDD Option.....	117
6.2.3	Test purpose.....	118
6.2.4	Method of test.....	118
6.2.4.1	Initial conditions.....	118
6.2.4.2	Procedure.....	118
6.2.5	Test requirements.....	118
6.2.5.1	3,84 Mcps TDD Option.....	118
6.2.5.2	1,28 Mcps TDD Option.....	119
6.2.5.3	7,68 Mcps TDD Option.....	119
6.2A	Reference sensitivity level (IMB).....	119
6.2A.1	Definition and applicability.....	119
6.2A.2	Minimum Requirements.....	119
6.2A.3	Test purpose.....	120
6.2A.4	Method of test.....	120
6.2A.4.1	Initial conditions.....	120
6.2A.4.2	Procedure.....	120
6.2A.5	Test requirements.....	120
6.3	Maximum Input Level.....	121
6.3.1	Definition and applicability.....	121
6.3.2	Minimum requirements.....	121
6.3.2.1	3,84 Mcps TDD Option.....	121
6.3.2.2	1,28 Mcps TDD Option.....	121
6.3.2.3	7,68 Mcps TDD Option.....	122
6.3.3	Test purpose.....	122
6.3.4	Method of test.....	122
6.3.4.1	Initial conditions.....	122
6.3.4.2	Procedure.....	122
6.3.5	Test requirements.....	122
6.3A	Maximum Input Level for HS-PDSCH Reception (16QAM).....	122
6.3A.1	Definition and applicability.....	122
6.3A.2	Minimum requirements.....	122
6.3A.3	Test purpose.....	123
6.3A.4	Method of test.....	123

6.3A.4.1	Initial conditions .....	123
6.3A.4.2	Procedure .....	123
6.3A.5	Test requirements.....	123
6.3B	Maximum Input Level for HS-PDSCH Reception (64QAM) .....	124
6.3B.1	Definition and applicability .....	124
6.3B.2	Minimum requirements.....	124
6.3B.3	Test purpose.....	124
6.3B.4	Method of test .....	124
6.3B.4.1	Initial conditions .....	124
6.3B.4.2	Procedure .....	125
6.3B.5	Test requirements.....	125
6.3C	Maximum Input Level (IMB).....	125
6.3C.1	Definition and applicability .....	125
6.3C.2	Minimum requirements.....	125
6.3C.3	Test purpose.....	125
6.3C.4	Method of test .....	125
6.3C.4.1	Initial conditions .....	125
6.3C.4.2	Procedure .....	126
6.3C.5	Test requirements.....	126
6.4	Adjacent Channel Selectivity (ACS).....	126
6.4.1	Definition and applicability .....	126
6.4.2	Minimum Requirements .....	126
6.4.2.1	3,84 Mcps TDD Option.....	126
6.4.2.2	1,28 Mcps TDD Option.....	127
6.4.2.3	7,68 Mcps TDD Option.....	127
6.4.3	Test purpose.....	127
6.4.4	Method of test .....	127
6.4.4.1	Initial conditions .....	127
6.4.4.2	Procedure .....	128
6.4.5	Test Requirements .....	128
6.4.5.1	3,84 Mcps TDD Option.....	128
6.4.5.2	1,28 Mcps TDD Option.....	128
6.4.5.3	7,68 Mcps TDD Option.....	129
6.4A	Adjacent Channel Selectivity (ACS) (IMB).....	129
6.4A.1	Definition and applicability .....	129
6.4A.2	Minimum Requirements .....	129
6.4A.3	Test purpose.....	130
6.4A.4	Method of test .....	130
6.4A.4.1	Initial conditions .....	130
6.4A.4.2	Procedure .....	130
6.4A.5	Test Requirements .....	131
6.5	Blocking Characteristics.....	131
6.5.1	Definition and applicability .....	131
6.5.2	Minimum Requirements .....	131
6.5.2.1	3,84 Mcps TDD Option.....	131
6.5.2.2	1,28 Mcps TDD Option.....	132
6.5.2.3	7,68 Mcps TDD Option.....	134
6.5.3	Test purpose.....	135
6.5.4	Method of test .....	135
6.5.4.1	Initial conditions .....	135
6.5.4.2	Procedure .....	135
6.5.5	Test requirements.....	136
6.5.5.1	3,84 Mcps TDD Option.....	136
6.5.5.2	1,28 Mcps TDD Option.....	137
6.5.5.3	7,68 Mcps TDD Option.....	137
6.5A	Blocking Characteristics (IMB) .....	138
6.5A.1	Definition and applicability .....	138
6.5A.2	Minimum Requirements .....	138
6.5A.3	Test purpose.....	139
6.5A.4	Method of test .....	139
6.5A.4.1	Initial conditions .....	139
6.5A.4.2	Procedure .....	140

6.5A.5	Test requirements.....	140
6.6	Spurious Response .....	141
6.6.1	Definition and applicability .....	141
6.6.2	Minimum Requirements .....	141
6.6.2.1	3,84 Mcps TDD Option.....	141
6.6.2.2	1,28 Mcps TDD Option.....	142
6.6.2.3	7,68 Mcps TDD Option.....	142
6.6.3	Test purpose.....	142
6.6.4	Method of test.....	142
6.6.4.1	Initial conditions .....	142
6.6.4.2	Procedure .....	142
6.6.5	Test requirements.....	143
6.6.5.1	3,84 Mcps TDD.....	143
6.6.5.2	1,28 Mcps TDD.....	143
6.6.5.3	7,68 Mcps TDD.....	143
6.6A	Spurious Response (IMB) .....	144
6.6A.1	Definition and applicability .....	144
6.6A.2	Minimum Requirements .....	144
6.6A.3	Test purpose.....	144
6.6A.4	Method of test.....	144
6.6A.4.1	Initial conditions .....	144
6.6A.4.2	Procedure .....	145
6.6A.5	Test requirements.....	145
6.7	Intermodulation Characteristics.....	145
6.7.1	Definition and applicability .....	145
6.7.2	Minimum Requirements .....	146
6.7.2.1	3,84 Mcps TDD Option.....	146
6.7.2.2	1,28 Mcps TDD Option.....	146
6.7.2.3	7,68 Mcps TDD Option.....	146
6.7.3	Test purpose.....	147
6.7.4	Method of test.....	147
6.7.4.1	Initial conditions .....	147
6.7.4.2	Procedure .....	147
6.7.5	Test requirements.....	147
6.7.5.1	3,84 Mcps TDD Option.....	147
6.7.5.2	1,28 Mcps TDD Option.....	147
6.7.5.3	7,68 Mcps TDD Option.....	148
6.7A	Intermodulation Characteristics (IMB) .....	148
6.7A.1	Definition and applicability .....	148
6.7A.2	Minimum Requirements .....	148
6.7A.3	Test purpose.....	149
6.7A.4	Method of test.....	149
6.7A.4.1	Initial conditions .....	149
6.7A.4.2	Procedure .....	149
6.7A.5	Test requirements.....	150
6.8	Spurious Emissions .....	150
6.8.1	Definition and applicability .....	150
6.8.2	Minimum Requirements .....	150
6.8.2.1	3,84 Mcps TDD Option.....	150
6.8.2.2	1,28 Mcps TDD Option.....	150
6.8.2.3	7,68 Mcps TDD Option.....	151
6.8.3	Test purpose.....	151
6.8.4	Method of test.....	152
6.8.4.1	Initial conditions .....	152
6.8.4.2	Procedure .....	152
6.8.5	Test requirements.....	152
6.8.5.1	3,84 Mcps TDD Option.....	152
6.8.5.2	1,28 Mcps TDD Option.....	153
6.8.5.3	7,68 Mcps TDD Option.....	153
7	Performance Requirements .....	155
7.1	General .....	155

7.1.2	Definition of Additive White Gaussian Noise (AWGN) Interferer .....	155
7.2	Demodulation in static propagation conditions .....	155
7.2.1	Demodulation of DCH .....	155
7.2.1.1	Definition and applicability .....	155
7.2.1.2	Minimum requirements .....	155
7.2.1.2.1	3,84 Mcps TDD Option .....	155
7.2.1.2.2	1,28 Mcps TDD Option .....	156
7.2.1.2.3	7,68 Mcps TDD Option .....	156
7.2.1.3	Test purpose .....	157
7.2.1.4	Method of test .....	157
7.2.1.4.1	Initial conditions .....	157
7.2.1.4.2	Procedure .....	157
7.2.1.5	Test requirements .....	157
7.2.1.5.1	3.84Mcps TDD Option .....	157
7.2.1.5.2	1.28Mcps TDD Option .....	158
7.2.1.5.3	7.68Mcps TDD Option .....	158
7.3	Demodulation of DCH in multipath fading conditions .....	158
7.3.1	Multipath fading Case 1 .....	158
7.3.1.1	Definition and applicability .....	158
7.3.1.2	Minimum requirements .....	158
7.3.1.2.1	3,84 Mcps TDD Option .....	158
7.3.1.2.2	1,28 Mcps TDD Option .....	159
7.3.1.2.3	7,68 Mcps TDD Option .....	160
7.3.1.3	Test purpose .....	160
7.3.1.4	Method of test .....	160
7.3.1.4.1	Initial conditions .....	160
7.3.1.4.2	Procedure .....	161
7.3.1.5	Test requirements .....	161
7.3.1.5.1	3.84Mcps TDD Option .....	161
7.3.1.5.2	1.28Mcps TDD Option .....	161
7.3.1.5.3	7.68Mcps TDD Option .....	161
7.3.2	Multipath fading Case 2 .....	161
7.3.2.1	Definition and applicability .....	161
7.3.2.2	Minimum requirement .....	162
7.3.2.2.1	3,84 Mcps TDD Option .....	162
7.3.2.2.2	1,28 Mcps TDD Option .....	162
7.3.2.2.3	7,68 Mcps TDD Option .....	163
7.3.2.3	Test purpose .....	163
7.3.2.4	Method of test .....	164
7.3.2.4.1	Initial conditions .....	164
7.3.2.4.2	Procedure .....	164
7.3.2.5	Test requirements .....	164
7.3.2.5.1	3.84Mcps TDD Option .....	164
7.3.2.5.2	1.28Mcps TDD Option .....	164
7.3.2.5.3	7.68Mcps TDD Option .....	164
7.3.3	Multipath fading Case 3 .....	165
7.3.3.1	Definition and applicability .....	165
7.3.3.2	Minimum requirements .....	165
7.3.3.2.1	3,84 Mcps TDD Option .....	165
7.3.3.2.2	1,28 Mcps TDD Option .....	165
7.3.3.2.3	7,68 Mcps TDD Option .....	166
7.3.3.3	Test purpose .....	167
7.3.3.4	Method of test .....	167
7.3.3.4.1	Initial conditions .....	167
7.3.3.4.2	Procedure .....	167
7.3.3.5	Test requirements .....	167
7.3.3.5.1	3.84Mcps TDD Option .....	167
7.3.3.5.2	1.28Mcps TDD Option .....	167
7.3.3.5.3	7.68Mcps TDD Option .....	168
7.3A	Demodulation of DCH in High speed train conditions .....	168
7.3A.1	Definition and applicability .....	168
7.3A.1.1	3,84 Mcps TDD Option .....	168

7.3A.1.2	1,28 Mcps TDD Option.....	168
7.3A.1.3	3,84 Mcps TDD Option.....	168
7.3A.2	Minimum requirements.....	168
7.3A.2.1	3,84 Mcps TDD Option.....	168
7.3A.2.2	1,28 Mcps TDD Option.....	168
7.3A.2.3	7,68 Mcps TDD Option.....	169
7.3A.3	Test purpose.....	169
7.3A.4	Method of test.....	169
7.3A.4.1	Initial conditions.....	169
7.3A.4.2	Procedure.....	169
7.3A.5	Test requirements.....	169
7.3A.5.1	3.84Mcps TDD Option.....	169
7.3A.5.2	1.28Mcps TDD Option.....	169
7.3A.5.3	7.68Mcps TDD Option.....	170
7.4	Base station transmit diversity mode for 3,84 Mcps TDD Option.....	170
7.4.1	Demodulation of BCH in SCTD mode.....	170
7.5	Power control in downlink.....	170
7.5.1	Definition and applicability.....	170
7.5.2	Power control in downlink for 3,84 Mcps TDD option, constant BLER Target.....	170
7.5.2.1	Minimum requirements.....	170
7.5.2.2	Test purpose.....	171
7.5.2.3	Method of test.....	171
7.5.2.3.1	Initial conditions.....	171
7.5.2.3.2	Procedure.....	171
7.5.2.4	Test Requirements.....	171
7.5.3	Power control in downlink for 1,28 Mcps TDD option, constant BLER Target(Release 6 and earlier)...	171
7.5.3.1	Definition and applicability.....	171
7.5.3.2	Minimum requirements.....	172
7.5.3.3	Test purpose.....	172
7.5.3.4	Method of test.....	172
7.5.3.4.1	Initial conditions.....	172
7.5.3.4.2	Procedure.....	173
7.5.3.5	Test Requirements.....	173
7.5.3A	Power control in downlink for 1,28 Mcps TDD option, constant BLER Target(Release 7 and later).....	173
7.5.3A.1	Definition and applicability.....	173
7.5.3A.2	Minimum requirements.....	173
7.5.3A.3	Test purpose.....	174
7.5.3A.4	Method of test.....	174
7.5.3A.4.1	Initial conditions.....	174
7.5.3A.4.2	Procedure.....	174
7.5.3A.5	Test Requirements.....	174
7.5.4	Power control in the downlink for 1,28 Mcps TDD option, wind up effects.....	175
7.5.4.1	Definition and applicability.....	175
7.5.4.2	Minimum requirements.....	175
7.5.4.3	Test purpose.....	175
7.5.4.4	Method of test.....	176
7.5.4.5	Test Requirements.....	176
7.6	Uplink Power Control.....	176
7.6.1	Definition and applicability.....	176
7.6.2	Minimum requirements.....	176
7.6.3	Test purpose.....	177
7.6.4	Method of test.....	177
7.6.4.1	Initial conditions.....	177
7.6.4.2	Procedure.....	178
7.6.5	Test Requirements.....	178
7.7	Demodulation of DCH in moving conditions.....	179
7.7.1	Definition and applicability.....	179
7.7.1.1	3,84 Mcps TDD Option.....	179
7.7.1.2	1,28 Mcps TDD Option.....	179
7.7.1.3	7,68 Mcps TDD Option.....	179
7.7.2	Minimum requirements.....	179
7.7.2.1	3.84 Mcps TDD Option.....	179

7.7.2.2	1.28 Mcps TDD Option.....	179
7.7.2.3	7.68 Mcps TDD Option.....	179
7.7.3	Test purpose.....	180
7.7.4	Method of test.....	180
7.7.4.1	Initial conditions .....	180
7.7.4.2	Procedure .....	180
7.7.5	Test Requirements .....	180
7.7.5.1	3.84 Mcps option.....	180
7.7.5.2	1.28 Mcps option.....	180
7.7.5.3	7.68Mcps option.....	181
7.8	Demodulation of DCH in birth-death conditions .....	181
7.8.1	Definition and applicability .....	181
7.8.1.1	3,84 Mcps TDD Option.....	181
7.8.1.2	1,28 Mcps TDD Option.....	181
7.8.1.3	7,68 Mcps TDD Option.....	181
7.8.2	Minimum requirements.....	181
7.8.2.1	3.84 Mcps TDD Option.....	181
7.8.2.2	1.28 Mcps TDD Option.....	182
7.8.2.3	7.68 Mcps TDD Option.....	182
7.8.3	Test purpose.....	182
7.8.4	Method of test.....	182
7.8.4.1	Initial conditions .....	182
7.8.4.2	Procedure .....	182
7.8.5	Test Requirements .....	183
7.8.5.1	3.84 Mcps option.....	183
7.8.5.2	1.28 Mcps option.....	183
7.8.5.3	7.68 Mcps option.....	183
8	Requirements for Support of RRM .....	184
8.1	General .....	184
8.2	Idle Mode Tasks .....	184
8.2.1	RF Cell Selection Scenario .....	184
8.2.1.1	Introduction.....	184
8.2.2	Cell Re-Selection .....	184
8.2.2.1	Scenario 1: Cell re-selection to intra frequency TDD cell .....	184
8.2.2.1.1	Definition and applicability .....	184
8.2.2.1.1.1	3,84 Mcps TDD Option .....	184
8.2.2.1.1.2	1,28 Mcps TDD Option .....	184
8.2.2.1.1.3	7,68 Mcps TDD Option .....	184
8.2.2.1.2	Minimum requirement .....	184
8.2.2.1.2.1	3,84 Mcps TDD Option .....	184
8.2.2.1.2.2	1,28 Mcps TDD Option .....	185
8.2.2.1.2.3	7,68 Mcps TDD Option .....	185
8.2.2.1.3	Test purpose .....	185
8.2.2.1.4	Method of test.....	185
8.2.2.1.4.1	3,84 Mcps TDD Option .....	185
8.2.2.1.4.1.1	Initial conditions.....	185
8.2.2.1.4.1.2	Procedure.....	188
8.2.2.1.4.2	1,28 Mcps TDD Option .....	188
8.2.2.1.4.3	7,68 Mcps TDD Option .....	190
8.2.2.1.4.3.1	Initial conditions.....	190
8.2.2.1.4.3.2	Procedure.....	192
8.2.2.1.5	Test Requirements .....	192
8.2.2.1.5.1	3,84 Mcps TDD Option .....	192
8.2.2.1.5.2	1,28 Mcps TDD Option .....	192
8.2.2.1.5.3	7,68 Mcps TDD Option .....	192
8.2.2.2	Scenario 2: Cell re-selection to inter-frequency TDD cell .....	193
8.2.2.2.1	Definition and applicability .....	193
8.2.2.2.1.1	3,84 Mcps Option .....	193
8.2.2.2.1.2	1,28 Mcps Option .....	193
8.2.2.2.1.3	7,68 Mcps Option .....	193
8.2.2.2.2	Minimum requirement.....	193

8.2.2.2.2.1	3,84 Mcps Option .....	193
8.2.2.2.2.2	1,28 Mcps Option .....	193
8.2.2.2.2.3	7,68 Mcps Option .....	194
8.2.2.2.3	Test purpose .....	194
8.2.2.2.4	Method of test.....	194
8.2.2.2.4.1	3,84 Mcps Option .....	194
8.2.2.2.4.1.1	Initial conditions.....	194
8.2.2.2.4.1.2	Procedure.....	196
8.2.2.2.4.2	1,28 Mcps Option .....	196
8.2.2.2.4.3	7,68 Mcps Option .....	198
8.2.2.2.4.3.1	Initial conditions.....	198
8.2.2.2.4.3.2	Procedure.....	200
8.2.2.2.5	Test Requirements .....	200
8.2.2.2.5.1	3,84 Mcps Option .....	200
8.2.2.2.5.2	1,28 Mcps Option .....	200
8.2.2.2.5.3	7,68 Mcps Option .....	200
8.2.2.2A	Scenario 2A: 3,84 Mcps TDD cell re-selection for 1,28 Mcps TDD UE.....	201
8.2.2.2B	Scenario 2B: 1,28 Mcps TDD cell re-selection for 3,84 Mcps TDD UE.....	201
8.2.2.2C	Scenario 2C: 3,84 Mcps TDD cell re-selection for 7,68 Mcps TDD UE.....	201
8.2.2.2C.1	Definition and applicability .....	201
8.2.2.2C.2	Minimum requirement.....	201
8.2.2.2C.3	Test purpose .....	201
8.2.2.2C.4	Method of test.....	201
8.2.2.2C.4.1	Initial conditions .....	201
8.2.2.2C.4.2	Procedure .....	202
8.2.2.2C.5	Test Requirements .....	203
8.2.2.2D	Scenario 2D: 7,68 Mcps TDD cell re-selection for 3,84 Mcps TDD UE.....	203
8.2.2.2D.1	Definition and applicability .....	203
8.2.2.2D.2	Minimum requirement.....	203
8.2.2.2D.3	Test purpose .....	203
8.2.2.2D.4	Method of test.....	203
8.2.2.2D.4.1	Initial conditions.....	203
8.2.2.2D.4.2	Procedure.....	204
8.2.2.2D.5	Test Requirements .....	205
8.2.2.3	Scenario 3: TDD/FDD Cell re-selection .....	205
8.2.2.3.1	Definition and applicability .....	205
8.2.2.3.1.1	3,84 Mcps Option .....	205
8.2.2.3.1.2	1,28 Mcps Option .....	205
8.2.2.3.1.3	7,68 Mcps Option .....	205
8.2.2.3.2	Minimum requirements .....	205
8.2.2.3.3	Test purpose .....	206
8.2.2.3.4	Method of test.....	206
8.2.2.3.4.1	3,84 Mcps Option .....	206
8.2.2.3.4.1.1	Initial conditions .....	206
8.2.2.3.4.1.2	Procedure .....	207
8.2.2.3.4.2	1,28 Mcps Option .....	208
8.2.2.3.4.3	7,68 Mcps Option .....	209
8.2.2.3.4.3.1	Initial conditions .....	209
8.2.2.3.4.3.2	Procedure .....	210
8.2.2.3.5	Test requirements .....	210
8.2.2.4	Scenario 4: inter RAT cell re-selection .....	211
8.2.2.4.1	Definition and applicability .....	211
8.2.2.4.1.1	3,84 Mcps Option .....	211
8.2.2.4.1.2	1,28 Mcps Option .....	211
8.2.2.4.1.3	7,68 Mcps Option .....	211
8.2.2.4.2	Minimum requirement.....	211
8.2.2.4.2.1	3,84 Mcps Option .....	211
8.2.2.4.2.2	1,28 Mcps Option .....	211
8.2.2.4.2.3	7,68 Mcps Option .....	212
8.2.2.4.3	Test purpose .....	212
8.2.2.4.4	Method of Test .....	212
8.2.2.4.4.1	3,84 Mcps Option .....	212

8.2.2.4.4.1.1	Initial conditions .....	212
8.2.2.4.4.1.2	Procedure .....	213
8.2.2.4.4.2	1,28 Mcps Option .....	214
8.2.2.4.4.3	7,68 Mcps Option .....	215
8.2.2.4.5	Test Requirements .....	216
8.2.2.4.5.1	3,84 Mcps Option .....	216
8.2.2.4.5.2	1,28 Mcps Option .....	216
8.2.2.4.5.3	7,68 Mcps Option .....	216
8.2.2.5	Scenario 4A: inter RAT cell acquisition and re-selection .....	216
8.2.2.5.1	Definition and applicability .....	216
8.2.2.5.1.1	3,84 Mcps Option .....	216
8.2.2.5.1.2	1,28 Mcps Option .....	217
8.2.2.5.1.3	7,68 Mcps Option .....	217
8.2.2.5.2	Minimum requirement .....	217
8.2.2.5.2.1	3,84 Mcps Option .....	217
8.2.2.5.2.2	1,28 Mcps Option .....	217
8.2.2.5.2.3	7,68 Mcps Option .....	217
8.2.2.5.3	Test purpose .....	217
8.2.2.5.4	Method of Test .....	217
8.2.2.5.4.1	3,84 Mcps Option .....	217
8.2.2.5.4.2	1,28 Mcps Option .....	217
8.2.2.5.4.2.1	Initial conditions .....	217
8.2.2.5.4.2.2	Procedure .....	218
8.2.2.5.4.3	7,68 Mcps Option .....	219
8.2.2.5.5	Test Requirements .....	219
8.2.2.5.5.1	3,84 Mcps Option .....	219
8.2.2.5.5.2	1,28 Mcps Option .....	219
8.2.2.5.5.3	7,68 Mcps Option .....	219
8.2.2.5A	Scenario 4B: UTRAN to GSM Cell Re-Selection: HCS with only UTRA level changed .....	219
8.2.2.5A.1	Definition and applicability .....	219
8.2.2.5A.1.1	3,84 Mcps Option .....	219
8.2.2.5A.1.2	1,28 Mcps Option .....	219
8.2.2.5A.1.3	7,68 Mcps Option .....	219
8.2.2.5A.2	Minimum requirement .....	219
8.2.2.5A.2.1	3,84 Mcps Option .....	219
8.2.2.5A.2.2	1,28 Mcps Option .....	219
8.2.2.5A.2.3	7,68 Mcps Option .....	220
8.2.2.5A.3	Test purpose .....	220
8.2.2.5A.4	Method of Test .....	220
8.2.2.5A.4.1	3,84 Mcps Option .....	220
8.2.2.5A.4.2	1,28 Mcps Option .....	220
8.2.2.5A.4.2.1	Initial conditions .....	220
8.2.2.5A.4.2.2	Procedure .....	221
8.2.2.5A.4.3	7,68 Mcps Option .....	222
8.2.2.5A.5	Test Requirements .....	222
8.2.2.5A.5.1	3,84 Mcps Option .....	222
8.2.2.5A.5.2	1,28 Mcps Option .....	222
8.2.2.5A.5.3	7,68 Mcps Option .....	222
8.2.2.6	Scenario 5: TDD/E-UTRA cell re-selection .....	222
8.2.2.6.1	UTRA to E-UTRA TDD cell reselection: E-UTRA is of higher priority .....	222
8.2.2.6.1.5.2	1,28 Mcps Option .....	225
8.2.2.6.1.5.3	7,68 Mcps Option .....	226
8.2.2.6.2	UTRA to E-UTRA TDD cell reselection: E-UTRA is of lower priority .....	226
8.2.2.6.2.5	Test requirement .....	229
8.2.2.7	Scenario 6: Inter-band Cell Re-selection for 1.28 Mcps TDD UE .....	229
8.2.2.7.1	Definition and applicability .....	229
8.2.2.7.2	Minimum requirement .....	229
8.2.2.7.3	Test purpose .....	229
8.2.2.7.4	Method of test .....	229
8.2.2.7.4.1	Initial conditions .....	229
8.2.2.7.4.2	Procedure .....	232
8.2.2.7.5	Test Requirements .....	232



8.3	UTRAN Connected Mode Mobility .....	232
8.3.1	TDD/TDD Handover for 3,84 Mcps Option.....	232
8.3.1.1	Handover to intra-frequency cell.....	232
8.3.1.1.1	Definition and applicability .....	232
8.3.1.1.2	Minimum requirement.....	232
8.3.1.1.3	Test purpose .....	233
8.3.1.1.4	Method of test.....	233
8.3.1.1.5	Test requirements .....	240
8.3.1.2	Handover to inter-frequency cell.....	240
8.3.1.2.1	Definition and applicability .....	240
8.3.1.2.2	Minimum requirement.....	240
8.3.1.2.3	Test purpose .....	241
8.3.1.2.4	Method of test.....	241
8.3.1.2.5	Test requirements .....	247
8.3.1A	TDD/TDD Handover for 1,28 Mcps Option.....	247
8.3.1A.1	Handover to intra-frequency cell.....	247
8.3.1A.1.1	Scenario 1 .....	247
8.3.1A.1.2	Scenario 2 .....	255
8.3.1A.2	Handover to inter-frequency cell.....	261
8.3.1A.2.1	Scenario 1 .....	261
8.3.1A.2.2	Scenario 2 .....	267
8.3.1A.3	Handover to inter-band cell.....	274
8.3.1A.3.1	Scenario 1 .....	274
8.3.1A.3.2	Scenario 2 .....	281
8.3.1A.3.3	Scenario 3 .....	287
8.3.1B	TDD/TDD Handover for 7,68 Mcps Option.....	293
8.3.1B.1	Handover to intra-frequency cell.....	293
8.3.1B.1.1	Definition and applicability .....	293
8.3.1B.1.2	Minimum requirement.....	293
8.3.1B.1.3	Test purpose .....	293
8.3.1B.1.4	Method of test.....	293
8.3.1B.1.5	Test requirements .....	300
8.3.1B.2	Handover to inter-frequency cell.....	300
8.3.1B.2.1	Definition and applicability .....	300
8.3.1B.2.2	Minimum requirement.....	300
8.3.1B.2.3	Test purpose .....	301
8.3.1B.2.4	Method of test.....	301
8.3.1B.2.5	Test requirements .....	307
8.3.2	TDD/FDD Handover for 3,84 Mcps Option.....	307
8.3.2.1	Definition and applicability .....	307
8.3.2.2	Minimum requirement.....	307
8.3.2.3	Test purpose .....	308
8.3.2.4	Method of test.....	308
8.3.2.5	Test requirements .....	314
8.3.2A	TDD/FDD Handover for 1,28 Mcps Option.....	314
8.3.2A.1	Definition and applicability.....	314
8.3.2A.2	Minimum requirement .....	314
8.3.2A.3	Test purpose .....	315
8.3.2A.4	Method of test .....	315
8.3.2A.4.1	Initial conditions.....	315
8.3.2A.4.2	Procedure.....	317
8.3.2A.5	Test requirements.....	321
8.3.2B	TDD/FDD Handover for 7,68 Mcps Option.....	321
8.3.2B.1	Definition and applicability .....	321
8.3.2B.2	Minimum requirement.....	321
8.3.2B.3	Test purpose .....	322
8.3.2B.4	Method of test.....	322
8.3.2B.5	Test requirements .....	328
8.3.3	TDD/GSM Handover.....	328
8.3.3.1	Definition and applicability.....	328
8.3.3.1.1	3,84 Mcps option.....	328
8.3.3.1.2	1,28 Mcps option.....	328

8.3.3.1.3	7,68 Mcps option .....	329
8.3.3.2	Minimum requirement .....	329
8.3.3.2.1	3,84 Mcps option .....	329
8.3.3.2.2	1,28 Mcps option .....	329
8.3.3.2.3	7,68 Mcps option .....	329
8.3.3.3	Test purpose .....	329
8.3.3.3.1	3,84 Mcps option .....	329
8.3.3.3.2	1,28 Mcps option .....	329
8.3.3.4	Method of test .....	329
8.3.3.4.1	3,84 Mcps option .....	329
8.3.3.4.2	1,28 Mcps option .....	333
8.3.3.4.3	7,68 Mcps option .....	338
8.3.3.5	Test requirements .....	342
8.3.3.5.1	3,84 Mcps option .....	342
8.3.3.5.2	1,28 Mcps option .....	342
8.3.3.5.3	7,68 Mcps option .....	342
8.3.3a	UTRA TDD to E-UTRA FDD Handover .....	342
8.3.3a.1	Definition and applicability .....	343
8.3.3a.1.1	3,84 Mcps option .....	343
8.3.3a.1.2	1,28 Mcps option .....	343
8.3.3a.1.3	7,68 Mcps option .....	343
8.3.3a.2	Minimum requirement .....	343
8.3.3a.2.1	3,84 Mcps option .....	343
8.3.3a.2.2	1,28 Mcps option .....	343
8.3.3a.2.3	7,68 Mcps option .....	344
8.3.3a.3	Test purpose .....	344
8.3.3a.3.1	3,84 Mcps option .....	344
8.3.3a.3.2	1,28 Mcps option .....	344
8.3.3a.3.3	7,68 Mcps option .....	344
8.3.3a.4	Method of test .....	344
8.3.3a.4.1	3,84 Mcps option .....	344
8.3.3a.4.2	1,28 Mcps option .....	344
8.3.3a.4.3	7,68 Mcps option .....	349
8.3.3a.5	Test Requirments .....	349
8.3.3a.5.1	3,84 Mcps option .....	349
8.3.3a.5.2	1,28 Mcps option .....	349
8.3.3a.5.3	7,68 Mcps option .....	349
8.3.3b	UTRA TDD to E-UTRA TDD Handover .....	349
8.3.3b.1	Definition and applicability .....	350
8.3.3b.1.1	3,84 Mcps option .....	350
8.3.3b.1.2	1,28 Mcps option .....	350
8.3.3b.1.3	7,68 Mcps option .....	350
8.3.3b.2	Minimum requirement .....	350
8.3.3b.2.1	3,84 Mcps option .....	350
8.3.3b.2.2	1,28 Mcps option .....	350
8.3.3b.2.3	7,68 Mcps option .....	351
8.3.3b.3	Test purpose .....	351
8.3.3b.3.1	3,84 Mcps option .....	351
8.3.3b.3.2	1,28 Mcps option .....	351
8.3.3b.3.3	7,68 Mcps option .....	351
8.3.3b.4	Method of test .....	351
8.3.3b.4.1	3,84 Mcps option .....	351
8.3.3b.4.2	1,28 Mcps option .....	351
8.3.3b.4.3	7,68 Mcps option .....	356
8.3.3b.5	Test Requirments .....	356
8.3.3b.5.1	3,84 Mcps option .....	356
8.3.3b.5.2	1,28 Mcps option .....	356
8.3.3b.5.3	7,68 Mcps option .....	356
8.3.3c	TDD/GSM Handover: non-synchronization target cell .....	356
8.3.4	Cell Re-selection in CELL_FACH .....	359
8.3.4.1	Scenario 1: TDD/TDD cell re-selection single carrier case .....	359
8.3.4.1.1	Definition and applicability .....	359

8.3.4.1.1.1	3,84 Mcps TDD option .....	359
8.3.4.1.1.2	1,28 Mcps TDD option .....	359
8.3.4.1.1.3	7,68 Mcps TDD option .....	360
8.3.4.1.2	Minimum requirement.....	360
8.3.4.1.2.1	3,84 Mcps TDD option .....	360
8.3.4.1.2.2	1,28 Mcps TDD option .....	360
8.3.4.1.2.3	7,68 Mcps TDD option .....	360
8.3.4.1.3	Test purpose .....	360
8.3.4.1.4	Method of test.....	360
8.3.4.1.4.1	3,84 Mcps TDD option .....	360
8.3.4.1.4.2	1,28 Mcps TDD option .....	364
8.3.4.1.4.3	7,68 Mcps TDD option .....	366
8.3.4.1.5	Test Requirements .....	370
8.3.4.1.5.1	3,84 Mcps TDD option .....	370
8.3.4.1.5.2	1,28 Mcps TDD option .....	370
8.3.4.1.5.3	7,68 Mcps TDD option .....	370
8.3.4.2	Scenario 2: TDD/TDD cell re-selection multi carrier case .....	371
8.3.4.2.1	Definition and applicability .....	371
8.3.4.2.1.1	3,84 Mcps TDD option .....	371
8.3.4.2.1.2	1,28 Mcps TDD option .....	371
8.3.4.2.1.3	7,68 Mcps TDD option .....	371
8.3.4.2.2	Minimum requirement.....	371
8.3.4.2.2.1	3,84 Mcps TDD option .....	371
8.3.4.2.2.2	1,28 Mcps TDD option .....	371
8.3.4.2.2.3	7,68 Mcps TDD option .....	371
8.3.4.2.3	Test purpose .....	371
8.3.4.2.4	Method of test.....	372
8.3.4.2.4.1	3,84 Mcps TDD option .....	372
8.3.4.2.4.2	1,28 Mcps TDD option .....	375
8.3.4.2.4.3	7,68 Mcps TDD option .....	378
8.3.4.2.5	Test Requirements .....	382
8.3.4.2.5.1	3,84 Mcps TDD option .....	382
8.3.4.2.5.2	1,28 Mcps TDD option .....	382
8.3.4.2.5.3	7,68 Mcps TDD option .....	383
8.3.4.3	Scenario 3: TDD/GSM cell re-selection .....	383
8.3.4.3.1	Definition and applicability .....	383
8.3.4.3.1.1	3,84 Mcps TDD option .....	383
8.3.4.3.1.2	1,28 Mcps TDD option .....	383
8.3.4.3.1.3	7,68 Mcps TDD option .....	383
8.3.4.3.2	Minimum requirement.....	383
8.3.4.3.2.1	3,84 Mcps TDD option .....	383
8.3.4.3.2.2	1,28 Mcps TDD option .....	384
8.3.4.3.2.3	7,68 Mcps TDD option .....	384
8.3.4.3.3	Test purpose .....	384
8.3.4.3.4	Method of test.....	384
8.3.4.3.4.1	3,84 Mcps TDD option .....	384
8.3.4.3.4.2	1,28 Mcps TDD option .....	384
8.3.4.3.4.3	7,68 Mcps TDD option .....	387
8.3.4.3.5	Test Requirements .....	387
8.3.4.3.5.1	3,84 Mcps TDD option .....	387
8.3.4.3.5.2	1,28 Mcps TDD option .....	387
8.3.4.3.5.3	7,68 Mcps TDD option .....	388
8.3.4A	Cell Re-selection in Enhanced CELL_FACH.....	388
8.3.4A.1	Scenario 1: Cell Re-selection to Intra-Frequency TDD cell.....	388
8.3.5	Cell Re-selection in CELL_PCH .....	396
8.3.5.1	Scenario 1: TDD/TDD cell re-selection single carrier case .....	396
8.3.5.1.1	Definition and applicability .....	396
8.3.5.1.1.1	3,84 Mcps TDD option .....	396
8.3.5.1.1.2	1,28 Mcps TDD option .....	396
8.3.5.1.1.3	7,68 Mcps TDD option .....	396
8.3.5.1.2	Minimum requirement.....	396
8.3.5.1.2.1	3,84 Mcps TDD option .....	396

8.3.5.1.2.2	1,28 Mcps TDD option .....	397
8.3.5.1.2.3	7,68 Mcps TDD option .....	397
8.3.5.1.3	Test purpose .....	397
8.3.5.1.4	Method of test.....	397
8.3.5.1.4.1	3,84 Mcps TDD option .....	397
8.3.5.1.4.2	1,28 Mcps TDD option .....	400
8.3.5.1.4.3	7,68 Mcps TDD option .....	403
8.3.5.1.5	Test Requirements .....	406
8.3.5.1.5.1	3,84 Mcps TDD option .....	406
8.3.5.1.5.2	1,28 Mcps TDD option .....	406
8.3.5.1.5.3	7,68 Mcps TDD option .....	407
8.3.5.2	Scenario 2: TDD/TDD cell re-selection multi carrier case .....	407
8.3.5.2.1	Definition and applicability .....	407
8.3.5.2.1.1	3,84 Mcps TDD option .....	407
8.3.5.2.1.2	1,28 Mcps TDD option .....	407
8.3.5.2.1.3	7,68 Mcps TDD option .....	407
8.3.5.2.2	Minimum requirement.....	407
8.3.5.2.2.1	3,84 Mcps TDD option .....	407
8.3.5.2.2.2	1,28 Mcps TDD option .....	407
8.3.5.2.2.3	7,68 Mcps TDD option .....	408
8.3.5.2.3	Test purpose .....	408
8.3.5.2.4	Method of test.....	408
8.3.5.2.4.1	3,84 Mcps TDD option .....	408
8.3.5.2.4.1.1	Initial conditions .....	408
8.3.5.2.4.2	1,28 Mcps TDD option .....	410
8.3.5.2.4.2.1	Initial conditions .....	410
8.3.5.2.4.3	7,68 Mcps TDD option .....	413
8.3.5.2.4.3.1	Initial conditions .....	413
8.3.5.2.5	Test Requirements .....	415
8.3.5.2.5.1	3,84 Mcps TDD option .....	415
8.3.5.2.5.2	1,28 Mcps TDD option .....	415
8.3.5.2.5.3	7,68 Mcps TDD option .....	416
8.3.6	Cell Re-selection in URA_PCH.....	416
8.3.6.1	Scenario 1: TDD/TDD cell re-selection single carrier case .....	416
8.3.6.1.1	Definition and applicability .....	416
8.3.6.1.1.1	3,84 Mcps TDD option .....	416
8.3.6.1.1.2	1,28 Mcps TDD option .....	416
8.3.6.1.1.3	7,68 Mcps TDD option .....	416
8.3.6.1.2	Minimum requirement.....	416
8.3.6.1.2.1	3,84 Mcps TDD option .....	416
8.3.6.1.2.2	1,28 Mcps TDD option .....	416
8.3.6.1.2.3	7,68 Mcps TDD option .....	417
8.3.6.1.3	Test purpose .....	417
8.3.6.1.4	Method of test.....	417
8.3.6.1.4.1	3,84 Mcps TDD option .....	417
8.3.6.1.4.1.1	Initial conditions .....	417
8.3.6.1.4.1.2	Procedure .....	419
8.3.6.1.4.2	1,28 Mcps TDD option .....	419
8.3.6.1.4.2.1	Initial conditions .....	419
8.3.6.1.4.2.2	Procedure .....	422
8.3.6.1.4.3	7,68 Mcps TDD option .....	422
8.3.6.1.4.3.1	Initial conditions .....	422
8.3.6.1.4.3.2	Procedure .....	425
8.3.6.1.5	Test Requirements .....	425
8.3.6.1.5.1	3,84 Mcps TDD option .....	425
8.3.6.1.5.2	1,28 Mcps TDD option .....	425
8.3.6.1.5.3	7,68 Mcps TDD option .....	426
8.3.6.2	Scenario 2: TDD/TDD cell re-selection multi carrier case .....	426
8.3.6.2.1	Definition and applicability .....	426
8.3.6.2.1.1	3,84 Mcps TDD option .....	426
8.3.6.2.1.2	1,28 Mcps TDD option .....	426
8.3.6.2.1.3	7,68 Mcps TDD option .....	426

8.3.6.2.2	Minimum requirement .....	426
8.3.6.2.2.1	3,84 Mcps TDD option .....	426
8.3.6.2.2.2	1,28 Mcps TDD option .....	426
8.3.6.2.2.3	7,68 Mcps TDD option .....	427
8.3.6.2.3	Test purpose .....	427
8.3.6.2.4	Method of test .....	427
8.3.6.2.4.1	3,84 Mcps TDD option .....	427
8.3.6.2.4.1.2	Procedure .....	429
8.3.6.2.4.2	1,28 Mcps TDD option .....	429
8.3.6.2.4.3	7,68 Mcps TDD option .....	431
8.3.6.2.4.3.2	Procedure .....	434
8.3.6.2.5	Test Requirements .....	434
8.3.6.2.5.1	3,84 Mcps TDD option .....	434
8.3.6.2.5.2	1,28 Mcps TDD option .....	434
8.3.6.2.5.3	7,68 Mcps TDD option .....	435
8.3.7	Serving HS-DSCH cell change .....	435
8.3.7.1	3.84 Mcps option (duplication) .....	435
8.3.7.2	1.28 Mcps option .....	435
8.3.7.2.1	Definition and applicability .....	435
8.3.7.2.2	Minimum requirement .....	435
8.3.7.2.3	Test purpose .....	435
8.3.7.2.4	Method of test .....	435
8.3.7.2.4.1	Initial conditions .....	435
8.3.7.2.5	Test Requirements .....	438
8.3.7.3	7.68 Mcps option .....	443
8.3.8	Inter-RAT cell change order from UTRAN TDD to GSM(GPRS) .....	443
8.3.8.1	Definition and applicability .....	443
8.3.8.1.1	3,84 Mcps option .....	443
8.3.8.1.2	1,28 Mcps option .....	443
8.3.8.1.3	7,68 Mcps option .....	443
8.3.8.2	Minimum requirement .....	443
8.3.8.2.1	3,84 Mcps option .....	443
8.3.8.2.2	1,28 Mcps option .....	443
8.3.8.2.3	7,68 Mcps option .....	444
8.3.8.3	Test Purpose .....	444
8.3.8.3.1	3,84 Mcps option .....	444
8.3.8.3.2	1,28 Mcps option .....	444
8.3.8.3.3	7,68 Mcps option .....	444
8.3.8.4	Method of test .....	444
8.3.8.4.1	3,84 Mcps option .....	444
8.3.8.4.2	1,28 Mcps option .....	444
8.3.8.4.3	7,68 Mcps option .....	446
8.3.8.5	Test requirement .....	446
8.3.8.5.1	3,84 Mcps option .....	446
8.3.8.5.2	1,28 Mcps option .....	446
8.3.8.5.3	7,68 Mcps option .....	447
8.4.1	RRC re-establishment delay .....	447
8.4.1.1	3,84 Mcps TDD option .....	447
8.4.1.1.1	RRC re-establishment delay to a known target cell .....	447
8.4.1.1.1.1	Definition and applicability .....	447
8.4.1.1.1.2	Minimum requirement .....	447
8.4.1.1.1.3	Test purpose .....	447
8.4.1.1.1.4	Method of test .....	448
8.4.1.1.1.4.1	Initial conditions .....	448
8.4.1.1.1.4.2	Procedure .....	449
8.4.1.1.1.5	Test requirements .....	449
8.4.1.1.2	RRC re-establishment delay to an unknown target cell .....	449
8.4.1.1.2.1	Definition and applicability .....	449
8.4.1.1.2.2	Minimum requirement .....	449
8.4.1.1.2.3	Test purpose .....	450
8.4.1.1.2.4	Method of test .....	450
8.4.1.1.2.4.1	Initial conditions .....	450

8.4.1.1.2.4.2	Procedure.....	451
8.4.1.1.2.5	Test requirements.....	452
8.4.1.2	1,28 Mcps TDD option .....	452
8.4.1.2.1	RRC re-establishment delay to a known target cell.....	452
8.4.1.2.1.1	Definition and applicability .....	452
8.4.1.2.1.2	Minimum requirement .....	452
8.4.1.2.1.3	Test purpose.....	453
8.4.1.2.1.4	Method of test .....	453
8.4.1.2.1.5	Test requirements.....	455
8.4.1.2.2	RRC re-establishment delay to an unknown target cell.....	455
8.4.1.2.2.1	Definition and applicability .....	455
8.4.1.2.2.2	Minimum requirement .....	455
8.4.1.2.2.3	Test purpose.....	455
8.4.1.2.2.4	Method of test .....	456
8.4.1.2.2.5	Test requirements.....	457
8.4.1.3	7,68 Mcps TDD option .....	457
8.4.1.3.1	RRC re-establishment delay to a known target cell.....	457
8.4.1.3.1.1	Definition and applicability .....	457
8.4.1.3.1.2	Minimum requirement .....	457
8.4.1.3.1.3	Test purpose.....	458
8.4.1.3.1.4	Method of test .....	458
8.4.1.3.1.4.1	Initial conditions.....	458
8.4.1.3.1.4.2	Procedure.....	459
8.4.1.3.1.5	Test requirements.....	459
8.4.1.3.2	RRC re-establishment delay to an unknown target cell.....	460
8.4.1.3.2.1	Definition and applicability .....	460
8.4.1.3.2.2	Minimum requirement .....	460
8.4.1.3.2.3	Test purpose.....	460
8.4.1.3.2.4	Method of test .....	460
8.4.1.3.2.4.1	Initial conditions.....	460
8.4.1.3.2.4.2	Procedure.....	461
8.4.1.3.2.5	Test requirements.....	462
8.4.1A	Random Access .....	462
8.4.1A.1	3,84 Mcps TDD option .....	462
8.4.1A.2	1,28 Mcps TDD option .....	462
8.4.1A.2.1	Correct behaviour when receiving FPACH.....	462
8.4.1A.2.1.1	Definition and applicability .....	462
8.4.1A.2.1.2	Minimum requirement .....	462
8.4.1A.2.1.3	Test purpose.....	463
8.4.1A.2.1.4	Method of test .....	463
8.4.1A.2.1.5	Test requirements.....	464
8.4.1A.2.2	Correct behaviour when reaching maximum allowed UL transmit power.....	464
8.4.1A.2.2.1	Definition and applicability .....	464
8.4.1A.2.2.2	Minimum requirement .....	464
8.4.1A.2.2.3	Test purpose.....	464
8.4.1A.2.2.4	Method of test .....	464
8.4.1A.2.2.5	Test requirements.....	465
8.4.1A.3	7.68 Mcps TDD option .....	465
8.4.2	Transport Format Combination selection in UE .....	466
8.4.2.1	Interactive or Background, PS, UL: 64 kbps.....	466
8.4.2.1.1	Definition and applicability .....	466
8.4.2.1.1.1	3,84 Mcps TDD option .....	466
8.4.2.1.1.1A	1,28 Mcps TDD option .....	466
8.4.2.1.1.2	7,68 Mcps TDD option .....	466
8.4.2.1.2	Minimum requirements .....	466
8.4.2.1.2.1	3,84 Mcps TDD option .....	466
8.4.2.1.2.1A	1,28 Mcps TDD option .....	467
8.4.2.1.2.2	7,68 Mcps TDD option .....	468
8.4.2.1.3	Test purpose .....	469
8.4.2.1.3.1	3,84 Mcps TDD option .....	469
8.4.2.1.3.1A	1,28 Mcps TDD option .....	470
8.4.2.1.3.2	7,68 Mcps TDD option .....	470

8.4.2.1.4	Method of test.....	470
8.4.2.1.4.1	Initial conditions .....	470
8.4.2.1.4.1.1	3,84 Mcps TDD option.....	470
8.4.2.1.4.1.1A	1,28 Mcps TDD option.....	471
8.4.2.1.4.1.2	7,68 Mcps TDD option.....	472
8.4.2.1.4.2	Procedure .....	474
8.4.2.1.4.2.1	3,84 Mcps TDD option.....	474
8.4.2.1.4.2.1A	1,28 Mcps TDD option.....	474
8.4.2.1.4.2.2	7.68 Mcps TDD option.....	475
8.4.2.1.5	Test requirements .....	475
8.4.2.1.5.1	3,84 Mcps TDD option .....	475
8.4.2.1.5.1A	1,28 Mcps TDD option .....	475
8.4.2.1.5.2	7,68 Mcps TDD option .....	475
8.4.3	E-TFC selection in UE.....	476
8.4.3.1	3.84 Mcps option.....	476
8.4.3.2	1.28 Mcps option.....	476
8.4.3.2.1	5ms TTI E-DCH E-TFC selection.....	476
8.4.3.2.1.1	Definition and applicability .....	476
8.4.3.2.1.2	Minimum requirements .....	476
8.4.3.2.1.3	Test Purpose .....	476
8.4.3.2.1.4	Method of test.....	476
8.4.3.2.1.5	Test Requirements .....	478
8.4.3.3	7.68 Mcps option.....	480
8.5	Timing Characteristics .....	480
8.5.1	UE Timing Advance .....	480
8.5.1.1	3,84 Mcps TDD Option.....	480
8.5.1.1.1	Definition and applicability .....	480
8.5.1.1.2	Minimum requirement.....	480
8.5.1.1.3	Test purpose .....	480
8.5.1.1.4	Method of test.....	480
8.5.1.1.5	Test requirements .....	482
8.5.1.2	1,28 Mcps TDD Option.....	482
8.5.1.2.1	Definition and applicability .....	482
8.5.1.2.2	Minimum requirement.....	482
8.5.1.2.3	Test purpose .....	483
8.5.1.2.4	Method of test.....	483
8.5.1.2.5	Test requirements .....	484
8.5.1.3	7,68 Mcps TDD Option.....	484
8.5.1.3.1	Definition and applicability .....	484
8.5.1.3.2	Minimum requirement.....	484
8.5.1.3.3	Test purpose .....	484
8.5.1.3.4	Method of test.....	484
8.5.1.3.5	Test requirements .....	486
8.5.2	UE Transmit Timing.....	486
8.5.3	UE Uplink Synchronization.....	486
8.5.3.1	3,84 Mcps TDD option .....	486
8.5.3.2	1,28 Mcps TDD option .....	487
8.5.3.2.2	Uplink synchronization control during handover .....	489
8.5.3.2.2.1	Scenario 1: Handover to intra-frequency cell .....	489
8.5.3.2.2.1.1	Definition and applicability.....	489
8.5.3.2.2.1.2	Minimum requirement.....	489
8.5.3.2.2.1.3	Test purpose .....	489
8.5.3.2.2.1.4	Initial conditions.....	489
8.5.3.2.2.1.5	Procedure.....	491
8.5.3.2.2.1.6	Test requirements .....	496
8.5.3.2.2.2	Scenario 2: Handover to inter-frequency cell .....	497
8.5.3.2.2.2.1	Definition and applicability.....	497
8.5.3.2.2.2.2	Minimum requirement.....	497
8.5.3.2.2.2.3	Test purpose .....	497
8.5.3.2.2.2.4	Initial conditions.....	497
8.5.3.2.2.2.5	Procedure.....	499
8.5.3.2.2.2.6	Test requirements .....	504

8.5.3.3	7.68 Mcps TDD option .....	505
8.6	UE Measurements Procedures.....	505
8.6.1	TDD intra frequency measurements .....	505
8.6.1.1	Event 1G triggered reporting in AWGN propagation conditions.....	505
8.6.1.1.1	Definition and applicability .....	505
8.6.1.1.1.1	3,84 Mcps TDD Option .....	505
8.6.1.1.1.2	1,28 Mcps TDD Option .....	505
8.6.1.1.1.3	7,68 Mcps TDD Option .....	505
8.6.1.1.2	Minimum requirement.....	505
8.6.1.1.2.1	3,84 Mcps TDD Option .....	505
8.6.1.1.2.2	1,28 Mcps TDD Option .....	506
8.6.1.1.2.3	7,68 Mcps TDD Option .....	506
8.6.1.1.3	Test purpose .....	506
8.6.1.1.3.1	3,84 Mcps TDD Option .....	506
8.6.1.1.3.2	1,28 Mcps TDD Option .....	506
8.6.1.1.3.3	7,68 Mcps TDD Option .....	507
8.6.1.1.4	Method of test.....	507
8.6.1.1.4.1	3,84 Mcps TDD Option .....	507
8.6.1.1.4.1.1	Initial conditions.....	507
8.6.1.1.4.1.2	Procedure.....	508
8.6.1.1.4.2	1,28 Mcps TDD Option .....	510
8.6.1.1.4.3	7,68 Mcps TDD Option .....	516
8.6.1.1.4.3.1	Initial conditions.....	516
8.6.1.1.4.3.2	Procedure.....	517
8.6.1.1.5	Test requirements .....	520
8.6.1.1.5.1	3,84 Mcps TDD Option .....	520
8.6.1.1.5.2	1,28 Mcps TDD Option .....	520
8.6.1.1.5.3	7,68 Mcps TDD Option .....	520
8.6.1.2	Event 1H and 1I triggered reporting in AWGN propagation condition .....	521
8.6.1.2.1	Definition and applicability .....	521
8.6.1.2.1.1	3,84 Mcps TDD Option .....	521
8.6.1.2.1.2	1,28 Mcps TDD Option .....	521
8.6.1.2.1.3	7,68 Mcps TDD Option .....	521
8.6.1.2.2	Minimum requirement.....	521
8.6.1.2.2.1	3,84 Mcps TDD Option .....	521
8.6.1.2.2.2	1,28 Mcps TDD Option .....	521
8.6.1.2.2.3	7,68 Mcps TDD Option .....	521
8.6.1.2.3	Test purpose .....	522
8.6.1.2.3.1	3,84 Mcps TDD Option .....	522
8.6.1.2.3.2	1,28 Mcps TDD Option .....	522
8.6.1.2.3.3	7,68 Mcps TDD Option .....	522
8.6.1.2.4	Method of test.....	522
8.6.1.2.4.1	3,84 Mcps TDD Option .....	522
8.6.1.2.4.1.1	Initial conditions.....	522
8.6.1.2.4.1.2	Procedure.....	525
8.6.1.2.4.2	1,28 Mcps TDD Option .....	529
8.6.1.2.4.3	7,68 Mcps TDD Option .....	535
8.6.1.2.4.3.1	Initial conditions.....	535
8.6.1.2.4.3.2	Procedure.....	537
8.6.1.2.5	Test requirements .....	542
8.6.1.2.5.1	3,84 Mcps TDD Option .....	542
8.6.1.2.5.2	1,28 Mcps TDD Option .....	542
8.6.1.2.5.3	7,68 Mcps TDD Option .....	542
8.6.1.3	Correct reporting of neighbours in fading propagation conditions .....	543
8.6.1.3.1	3,84 Mcps TDD Option.....	543
8.6.1.3.1.1	Definition and applicability .....	543
8.6.1.3.1.2	Minimum requirement .....	543
8.6.1.3.1.3	Test purpose.....	543
8.6.1.3.1.4	Method of test .....	543
8.6.1.3.1.4.1	Initial conditions.....	543
8.6.1.3.1.4.2	Procedure.....	544
8.6.1.3.1.5	Test requirements.....	546



8.6.1.3.2	1,28 Mcps TDD Option .....	546
8.6.1.3.3	7,68 Mcps TDD Option .....	546
8.6.1.3.3.1	Definition and applicability .....	546
8.6.1.3.3.2	Minimum requirement .....	546
8.6.1.3.3.3	Test purpose .....	546
8.6.1.3.3.4	Method of test .....	546
8.6.1.3.3.4.1	Initial conditions .....	546
8.6.1.3.3.4.2	Procedure .....	547
8.6.1.3.3.5	Test requirements .....	549
8.6.2	TDD inter frequency measurements .....	549
8.6.2.1	Correct reporting of neighbours in AWGN propagation condition .....	549
8.6.2.1.1	Definition and applicability .....	549
8.6.2.1.1.1	3,84 Mcps TDD Option .....	549
8.6.2.1.1.2	1,28 Mcps TDD Option .....	549
8.6.2.1.1.3	7,68 Mcps TDD Option .....	549
8.6.2.1.2	Minimum requirement .....	549
8.6.2.1.2.1	3,84 Mcps TDD Option .....	549
8.6.2.1.2.2	1,28 Mcps TDD Option .....	550
8.6.2.1.2.3	7,68 Mcps TDD Option .....	551
8.6.2.1.3	Test purpose .....	551
8.6.2.1.3.1	3,84 Mcps TDD Option .....	551
8.6.2.1.3.2	1,28 Mcps TDD Option .....	551
8.6.2.1.3.3	7,68 Mcps TDD Option .....	551
8.6.2.1.4	Method of test .....	552
8.6.2.1.4.1	3,84 Mcps TDD Option .....	552
8.6.2.1.4.1.1	Initial conditions .....	552
8.6.2.1.4.1.2	Procedure .....	553
8.6.2.1.4.2	1,28 Mcps TDD Option .....	555
8.6.2.1.4.3	7,68 Mcps TDD Option .....	559
8.6.2.1.4.3.1	Initial conditions .....	559
8.6.2.1.4.3.2	Procedure .....	560
8.6.2.1.5	Test requirements .....	563
8.6.2.1.5.1	3,84 Mcps TDD Option .....	563
8.6.2.1.5.2	1,28 Mcps TDD Option .....	563
8.6.2.1.5.3	7,68 Mcps TDD Option .....	564
8.6.3	FDD measurements .....	564
8.6.3.1	Correct reporting of FDD neighbours in AWGN propagation condition .....	564
8.6.3.1.1	Definition and applicability .....	564
8.6.3.1.1.1	3,84 Mcps TDD Option .....	564
8.6.3.1.1.2	1,28 Mcps TDD Option .....	564
8.6.3.1.1.3	7,68 Mcps TDD Option .....	564
8.6.3.1.2	Minimum requirement .....	564
8.6.3.1.2.1	3,84 Mcps TDD Option .....	564
8.6.3.1.2.2	1,28 Mcps TDD Option .....	565
8.6.3.1.2.3	7,68 Mcps TDD Option .....	565
8.6.3.1.3	Test purpose .....	566
8.6.3.1.3.1	3,84 Mcps TDD Option .....	566
8.6.3.1.3.2	1,28 Mcps TDD Option .....	566
8.6.3.1.3.3	7,68 Mcps TDD Option .....	566
8.6.3.1.4	Method of test .....	566
8.6.3.1.4.1	3,84 Mcps TDD Option .....	566
8.6.3.1.4.1.1	Initial conditions .....	566
8.6.3.1.4.1.2	Procedure .....	567
8.6.3.1.4.2	1,28 Mcps TDD Option .....	570
8.6.3.1.4.2.1	Test Procedure .....	571
8.6.3.1.4.3	7,68 Mcps TDD Option .....	574
8.6.3.1.4.3.1	Initial conditions .....	574
8.6.3.1.4.3.2	Procedure .....	575
8.6.3.1.5	Test requirements .....	578
8.6.3.1.5.1	3,84 Mcps TDD Option .....	578
8.6.3.1.5.2	1,28 Mcps TDD Option .....	578
8.6.3.1.5.3	7,68 Mcps TDD Option .....	579

8.6.4	GSM measurements .....	579
8.6.4.1	Correct reporting of GSM neighbours in AWGN propagation condition .....	579
8.6.4.1.1	3,84 Mcps TDD option .....	579
8.6.4.1.2	1,28 Mcps TDD option .....	579
8.6.4.1.2.1	Definition and applicability .....	579
8.6.4.1.2.2	Minimum requirement .....	579
8.6.4.1.2.3	Test purpose .....	579
8.6.4.1.2.4	Method of test .....	579
8.6.4.1.2.5	Test Procedure .....	582
8.6.4.1.2.6	Test requirements .....	587
8.6.4.1.3	7,68 Mcps TDD option .....	587
8.6.4.2	Combined UTRA TDD inter-frequency and GSM Cell search under AWGN propagation condition .....	591
8.6.4.2.2	1.28 Mcps TDD option .....	592
8.6.4.2.2.4	Method of test .....	592
8.6.5	E-UTRA measurements .....	598
8.6.5.1	UTRA TDD to E-UTRA FDD cell search under fading propagation conditions .....	598
8.6.5.1.1	Definition and applicability .....	598
8.6.5.1.1.1	3,84 Mcps TDD Option .....	598
8.6.5.1.1.2	1,28 Mcps TDD Option .....	598
8.6.5.1.1.3	7,68 Mcps TDD Option .....	598
8.6.5.1.2	Minimum requirement .....	598
8.6.5.1.2.1	3,84 Mcps TDD Option .....	598
8.6.5.1.2.2	1,28 Mcps TDD Option .....	598
8.6.5.1.2.3	7,68 Mcps TDD Option .....	599
8.6.5.1.3	Test purpose .....	599
8.6.5.1.3.1	3,84 Mcps TDD Option .....	599
8.6.5.1.3.2	1,28 Mcps TDD Option .....	599
8.6.5.1.3.3	7,68 Mcps TDD Option .....	599
8.6.5.1.4	Method of test .....	599
8.6.5.1.4.1	3,84 Mcps TDD Option .....	599
8.6.5.1.4.2	1,28 Mcps TDD Option .....	599
8.6.5.1.4.2.1	Initial conditions .....	599
8.6.5.1.4.3	7,68 Mcps TDD Option .....	603
8.6.5.1.5	Test requirements .....	603
8.6.5.1.5.1	3,84 Mcps TDD Option .....	603
8.6.5.1.5.2	1,28 Mcps TDD Option .....	603
8.6.5.1.5.3	7,68 Mcps TDD Option .....	603
8.6.5.2	UTRA TDD to E-UTRA TDD cell search under fading propagation conditions .....	603
8.6.5.2.1	Definition and applicability .....	603
8.6.5.2.1.1	3,84 Mcps TDD Option .....	603
8.6.5.2.1.2	1,28 Mcps TDD Option .....	603
8.6.5.2.1.3	7,68 Mcps TDD Option .....	603
8.6.5.2.2	Minimum requirement .....	603
8.6.5.2.2.1	3,84 Mcps TDD Option .....	603
8.6.5.2.2.2	1,28 Mcps TDD Option .....	603
8.6.5.2.2.3	7,68 Mcps TDD Option .....	605
8.6.5.2.3	Test purpose .....	605
8.6.5.2.3.1	3,84 Mcps TDD Option .....	605
8.6.5.2.3.2	1,28 Mcps TDD Option .....	605
8.6.5.2.3.3	7,68 Mcps TDD Option .....	605
8.6.5.2.4	Method of test .....	605
8.6.5.2.4.1	3,84 Mcps TDD Option .....	605
8.6.5.2.4.2	1,28 Mcps TDD Option .....	605
8.6.5.2.4.2.1	Initial conditions .....	605
8.6.5.2.4.3	7,68 Mcps TDD Option .....	609
8.6.5.2.5	Test requirements .....	609
8.6.5.2.5.1	3,84 Mcps TDD Option .....	609
8.6.5.2.5.2	1,28 Mcps TDD Option .....	609
8.6.5.2.5.3	7,68 Mcps TDD Option .....	609
8.6.5.3	Combined UTRA TDD inter-frequency and E-UTRA FDD cell search under fading propagation conditions .....	609

8.6.5.3.1	Definition and applicability .....	609
8.6.5.3.1.1	3,84 Mcps TDD Option .....	609
8.6.5.3.1.2	1,28 Mcps TDD Option .....	609
8.6.5.3.1.3	7,68 Mcps TDD Option .....	609
8.6.5.3.2	Minimum requirement .....	609
8.6.5.3.2.1	3,84 Mcps TDD Option .....	609
8.6.5.3.2.2	1,28 Mcps TDD Option .....	609
8.6.5.3.2.3	7,68 Mcps TDD Option .....	610
8.6.5.3.3	Test purpose .....	610
8.6.5.3.3.1	3,84 Mcps TDD Option .....	610
8.6.5.3.3.2	1,28 Mcps TDD Option .....	610
8.6.5.3.3.3	7,68 Mcps TDD Option .....	610
8.6.5.3.4	Method of test.....	610
8.6.5.3.4.1	3,84 Mcps TDD Option .....	610
8.6.5.3.4.2	1,28 Mcps TDD Option .....	610
8.6.5.3.4.2.1	Initial conditions.....	610
8.6.5.3.4.2.3	7,68 Mcps TDD Option .....	614
8.6.5.3.5	Test requirements .....	614
8.6.5.3.5.1	3,84 Mcps TDD Option .....	614
8.6.5.3.5.2	1,28 Mcps TDD Option .....	614
8.6.5.3.5.3	7,68 Mcps TDD Option .....	615
8.7	Measurements Performance Requirements .....	615
8.7.1	P-CCPCH RSCP .....	615
8.7.1.1	Intra frequency measurement accuracy for 3,84 Mcps TDD Option .....	615
8.7.1.1.1	Absolute accuracy requirement .....	615
8.7.1.1.2	Relative accuracy requirement .....	618
8.7.1.1A	Intra frequency measurement accuracy for 1,28 Mcps TDD Option .....	619
8.7.1.1A.1	Absolute accuracy requirement .....	619
8.7.1.1A.2	Relative accuracy requirement .....	624
8.7.1.1A.3	Absolute accuracy requirement with two neighbouring cells.....	625
8.7.1.1B	Intra frequency measurement accuracy for 7,68 Mcps TDD Option .....	630
8.7.1.1B.1	Absolute accuracy requirement .....	630
8.7.1.1B.2	Relative accuracy requirement .....	633
8.7.1.2	Inter frequency measurement accuracy for 3,84 Mcps TDD Option .....	634
8.7.1.2.1	Relative accuracy requirement .....	634
8.7.1.2A	Inter frequency measurement accuracy for 1,28 Mcps TDD Option .....	639
8.7.1.2A.1	Relative accuracy requirement .....	639
8.7.1.2A.2	Absolute accuracy requirement .....	644
8.7.1.2B	Inter frequency measurement accuracy for 7,68 Mcps TDD Option .....	649
8.7.1.2B.1	Relative accuracy requirement .....	649
8.7.1.3	Local cell accuracy for 3.84 Mcps TDD option .....	652
8.7.1.3A	Local cell accuracy for 1.28 Mcps TDD option .....	653
8.7.1.3A.1	Absolute accuracy requirement .....	653
8.7.1.3B	Local cell accuracy for 7.86 Mcps TDD option.....	656
8.7.1.4	Local cell absolute accuracy in white noise for 3.84 Mcps TDD.....	656
8.7.1.4A	Local cell absolute accuracy in white noise for 1.28 Mcps TDD.....	656
8.7.1.4A.1	Absolute accuracy requirement .....	656
8.7.1.4B	Local cell absolute accuracy in white noise for 3.84 Mcps TDD.....	660
8.7.2	CPICH measurements (FDD) .....	660
8.7.2.1	CPICH RSCP .....	660
8.7.2.1.1	Absolute measurement accuracy for 3,84 Mcps TDD Option.....	660
8.7.2.1.1.1	Definition and applicability .....	660
8.7.2.1.1.2	Minimum Requirements .....	660
8.7.2.1.1.3	Test purpose.....	660
8.7.2.1.1.4	Method of test .....	661
8.7.2.1.1.4.1	Initial conditions.....	661
8.7.2.1.1.4.2	Procedure.....	661
8.7.2.1.1.5	Test requirements.....	662
8.7.2.1A.1	Absolute measurement accuracy for 1,28 Mcps TDD Option.....	662
8.7.2.1A.1.1	Definition and applicability .....	662
8.7.2.1A.1.2	Minimum Requirements .....	663
8.7.2.1A.1.3	Test purpose.....	663

8.7.2.1A.1.4	Method of test .....	663
8.7.2.1A.1.4.1	Initial conditions .....	663
8.7.2.1A.1.4.2	Procedure .....	664
8.7.2.1.1.5	Test requirements .....	665
8.7.2.1B.1	Absolute measurement accuracy for 7,68 Mcps TDD Option .....	665
8.7.2.1B.1.1	Definition and applicability .....	665
8.7.2.1B.1.2	Minimum Requirements .....	666
8.7.2.1B.1.3	Test purpose .....	666
8.7.2.1B.1.4	Method of test .....	666
8.7.2.1B.1.4.1	Initial conditions .....	666
8.7.2.1B.1.4.2	Procedure .....	667
8.7.2.1B.1.5	Test requirements .....	668
8.7.2.2	CPICH Ec/Io .....	668
8.7.3	Timeslot ISCP .....	669
8.7.3.1	Intra frequency measurement accuracy for 3,84 Mcps TDD Option .....	669
8.7.3.1.1	Absolute accuracy requirement .....	669
8.7.3.1A	Intra frequency measurement accuracy for 1,28 Mcps TDD Option .....	672
8.7.3.1A.1	Absolute accuracy requirement .....	672
8.7.3.1A.1.1	Definition and applicability .....	672
8.7.3.1A.1.2	Minimum Requirements .....	672
8.7.3.1A.1.3	Test Purpose .....	673
8.7.3.1A.1.4	Method of test .....	673
8.7.3.1A.1.4.1	Initial conditions .....	673
8.7.3.1A.1.4.2	Procedure .....	674
8.7.3.1A.1.5	Test requirements .....	677
8.7.3.1B	Intra frequency measurement accuracy for 7,68 Mcps TDD Option .....	677
8.7.3.1B.1	Absolute accuracy requirement .....	677
8.7.4	UTRA carrier RSSI .....	681
8.7.4.1	Absolute measurement accuracy for 3,84 Mcps TDD Option .....	681
8.7.4.1.1	Definition and applicability .....	681
8.7.4.1.2	Minimum Requirements .....	681
8.7.4.1.3	Test Purpose .....	681
8.7.4.1.4	Method of test .....	681
8.7.4.1.4.1	Initial conditions .....	681
8.7.4.1.4.2	Procedure .....	682
8.7.4.1.5	Test requirements .....	683
8.7.4.1A	Absolute measurement accuracy for 1,28 Mcps TDD Option .....	684
8.7.4.1A.1	Definition and applicability .....	684
8.7.4.1A.2	Minimum Requirements .....	684
8.7.4.1A.3	Test Purpose .....	684
8.7.4.1A.4	Method of test .....	684
8.7.4.1A.4.1	Initial conditions .....	684
8.7.4.1A.4.2	Procedure .....	685
8.7.4.1A.5	Test requirements .....	687
8.7.4.1B	Absolute measurement accuracy for 7,68 Mcps TDD Option .....	688
8.7.4.1B.1	Definition and applicability .....	688
8.7.4.1B.2	Minimum Requirements .....	688
8.7.4.1B.3	Test Purpose .....	688
8.7.4.1B.4	Method of test .....	688
8.7.4.1B.4.1	Initial conditions .....	688
8.7.4.1B.4.2	Procedure .....	689
8.7.4.1B.5	Test requirements .....	690
8.7.4.2	Relative measurement accuracy for 3,84 Mcps TDD Option .....	691
8.7.4.2.1	Definition and applicability .....	691
8.7.4.2.2	Minimum Requirements .....	691
8.7.4.2.3	Test Purpose .....	691
8.7.4.2.4	Method of test .....	691
8.7.4.2.4.1	Initial conditions .....	691
8.7.4.2.4.2	Procedure .....	691
8.7.4.2.5	Test requirements .....	692
8.7.4.2A	Relative measurement accuracy for 1,28 Mcps TDD Option .....	692
8.7.4.2A.1	Definition and applicability .....	692

8.7.4.2A.2	Minimum Requirements .....	692
8.7.4.2A.3	Test Purpose .....	692
8.7.4.2A.4	Method of test.....	693
8.7.4.2A.4.1	Initial conditions .....	693
8.7.4.2A.4.2	Procedure .....	694
8.7.4.2A.5	Test requirements .....	694
8.7.4.2B	Relative measurement accuracy for 7,68 Mcps TDD Option .....	694
8.7.4.2B.1	Definition and applicability .....	694
8.7.4.2B.2	Minimum Requirements .....	695
8.7.4.2B.3	Test Purpose .....	695
8.7.4.2B.4	Method of test.....	695
8.7.4.2B.4.1	Initial conditions .....	695
8.7.4.2B.4.2	Procedure .....	695
8.7.4.2B.5	Test requirements .....	696
8.7.5	GSM carrier RSSI.....	696
8.7.5.1.1	RSSI (RX_LEV) 3,84 Mcps TDD Option.....	696
8.7.5.1A.1	RSSI (RX_LEV) 1,28 Mcps TDD Option.....	696
8.7.5.1A.1.1	Definition and applicability .....	696
8.7.5.1A.1.2	Minimum Requirements .....	696
8.7.5.1A.1.3	Test purpose .....	696
8.7.5.1A.1.4	Method of test .....	697
8.7.5.1A.1.4.1	Initial conditions.....	697
8.7.5.1A.1.4.2	Procedure.....	697
8.7.2.1.1.5	Test requirements.....	698
8.7.5.1B.1	RSSI (RX_LEV) 7,68 Mcps TDD Option.....	699
8.7.5.1B.1.1	Definition and applicability .....	699
8.7.5.1B.1.2	Minimum Requirements .....	699
8.7.5.1B.1.3	Test purpose.....	699
8.7.5.1B.1.4	Method of test .....	699
8.7.5.1B.1.4.1	Initial conditions.....	699
8.7.5.1B.1.4.2	Procedure.....	700
8.7.5.1B.1.5	Test requirements.....	701
8.7.6	SIR.....	701
8.7.7	Transport Channel BLER .....	701
8.7.8	SFN-SFN observed time difference.....	702
8.7.8.1	SFN-SFN observed time difference type 1 .....	702
8.7.8.1.1	Measurement accuracy for 3,84 Mcps TDD Option.....	702
8.7.8.1.1.1	Definition and applicability .....	702
8.7.8.1.1.2	Minimum requirements.....	702
8.7.8.1.1.3	Test purpose.....	702
8.7.8.1.1.4	Method of test .....	703
8.7.8.1.1.4.1	Initial conditions.....	703
8.7.8.1.1.4.2	Procedure.....	703
8.7.8.1.1.5	Test requirements.....	704
8.7.8.1.1A	Measurement accuracy for 1,28 Mcps TDD Option.....	705
8.7.8.1.1B	Measurement accuracy for 7,68 Mcps TDD Option.....	705
8.7.8.1.1B.1	Definition and applicability .....	705
8.7.8.1.1B.2	Minimum requirements.....	705
8.7.8.1.1B.3	Test purpose.....	705
8.7.8.1.1B.4	Method of test .....	706
8.7.8.1.1B.4.1	Initial conditions.....	706
8.7.8.1.1B.4.2	Procedure.....	706
8.7.8.1.1B.5	Test requirements.....	707
8.7.8.2	SFN-SFN observed time difference type 2 .....	708
8.7.9	Observed time difference to GSM cell .....	708
8.7.10	UE GPS Timing of Cell Frames for UP.....	708
8.7.11	SFN-CFN observed time difference .....	708
8.7.11.1	Intra frequency measurement requirement for 3,84 Mcps option .....	708
8.7.11.1.1	Definition and applicability .....	708
8.7.11.1.2	Minimum requirements .....	708
8.7.11.1.3	Test Purpose .....	709
8.7.11.1.4	Method of test.....	709

8.7.11.1.5	Test requirements .....	711
8.7.11.1A	Intra frequency measurement requirement for 1,28 Mcps option .....	711
8.7.11.1B	Intra frequency measurement requirement for 7,68 Mcps option .....	712
8.7.11.1B.1	Definition and applicability .....	712
8.7.11.1B.2	Minimum requirements .....	712
8.7.11.1B.3	Test Purpose .....	712
8.7.11.1B.4	Method of test.....	712
8.7.11.1B.5	Test requirements .....	714
8.7.11.2	Inter frequency measurement requirement for 3,84 Mcps option .....	715
8.7.11.2.1	Definition and applicability .....	715
8.7.11.2.2	Minimum requirements .....	715
8.7.11.2.3	Test purpose .....	715
8.7.11.2.4	Method of test.....	715
8.7.11.2.5	Test requirements .....	717
8.7.11.2A	Inter frequency measurement requirement for 1,28 Mcps option .....	717
8.7.11.2B	Inter frequency measurement requirement for 7,68 Mcps option .....	718
8.7.11.2B.1	Definition and applicability .....	718
8.7.11.2B.2	Minimum requirements .....	718
8.7.11.2B.3	Test purpose .....	718
8.7.11.2B.4	Method of test.....	718
8.7.11.2B.5	Test requirements .....	720
8.7.12	UE transmitted power .....	720
8.7.12.1	UE transmitted power for 3.84 Mcps TDD Option.....	720
8.7.12.1A	UE transmitted power for 1.28 Mcps TDD Option.....	721
8.7.12.1A.1	Definition and applicability .....	721
8.7.12.1A.2	Minimum requirements .....	721
8.7.12.1A.3	Test purpose .....	721
8.7.12.1A.4	Method of test.....	721
8.7.13	UE Transmission Power Headroom.....	725
8.7.13.1	UPH for 3.84Mcps TDD Option.....	725
8.7.13.1A	UPH for 1.28Mcps TDD Option.....	725
8.7.13.1A.1	Definition and applicability.....	725
8.7.13.1A.2	Minimum Requirements.....	725
8.7.13.1A.3	Test purpose .....	726
8.7.13.1A.4	Method of test.....	726
8.7.13.1B	UPH for 7.68Mcps TDD Option.....	730
8.7.14	E-UTRAN FDD RSRP .....	730
8.7.14.1	Definition and applicability.....	730
8.7.14.2	Minimum Requirements.....	730
8.7.14.3	Test purpose .....	731
8.7.14.4	Method of test .....	731
8.7.14.5	Test requirements.....	735
8.7.15	E-UTRAN TDD RSRP .....	738
8.7.15.1	Definition and applicability.....	738
8.7.15.2	Minimum Requirements.....	738
8.7.15.3	Test purpose .....	739
8.7.15.4	Method of test .....	739
8.7.15.5	Test requirements.....	742
8.7.16	E-UTRAN FDD RSRQ .....	743
8.7.16.1	Definition and applicability.....	743
8.7.16.2	Minimum Requirements.....	744
8.7.16.3	Test purpose .....	744
8.7.16.4	Method of test .....	744
8.7.16.5	Test requirements.....	748
8.7.17	E-UTRAN TDD RSRQ .....	751
8.7.17.1	Definition and applicability.....	751
8.7.17.2	Minimum Requirements.....	751
8.7.17.3	Test purpose .....	752
8.7.17.4	Method of test .....	752
8.7.17.5	Test requirements.....	755
9	Performance requirements for HSDPA .....	758

9.1	General .....	758
9.2	Performance requirement for 3.84 Mcps TDD option.....	758
9.2.1	HS-DSCH throughput for Fixed Reference Channels .....	758
9.2.1.1	Definition and applicability.....	758
9.2.1.2	Minimum requirements.....	758
9.2.1.3	Test purpose .....	760
9.2.1.4	Method of test .....	760
9.2.1.5	Test Requirements.....	761
9.2.2	HS-DSCH throughput for Variable Reference Channels.....	761
9.2.2.1	Definition and applicability.....	761
9.2.2.2	Minimum requirements.....	761
9.2.2.3	Test purpose .....	762
9.2.2.4	Method of test .....	762
9.2.2.5	Test Requirements.....	763
9.2.3	Reporting of HS-DSCH Channel Quality Indicator.....	763
9.2.3.1	Definition and applicability.....	763
9.2.3.2	Minimum requirements.....	763
9.2.3.3	Test purpose .....	763
9.2.3.4	Method of test .....	764
9.2.3.5	Test Requirements.....	764
9.2.4	HS-SCCH Detection Performance.....	764
9.2.4A	HS-SCCH Detection Performance.....	764
9.2.4.1	Definition and applicability.....	764
9.2.4.2	Minimum requirements.....	765
9.2.4.3	Test purpose .....	765
9.2.4.4	Method of test .....	765
9.2.4.5	Test Requirements.....	766
9.3	Performance requirements for 1.28 Mcps TDD option .....	766
9.3.1	HS-DSCH throughput for Fixed Reference Channels .....	766
9.3.1A	HS-DSCH throughput for Fixed Reference Channels 0.5 Mbps UE class QPSK.....	766
9.3.1A.1	Definition and applicability.....	766
9.3.1A.2	Minimum requirements.....	766
9.3.1A.3	Test purpose .....	767
9.3.1A.4	Method of test .....	767
9.3.1A.4.1	Initial conditions.....	767
9.3.1A.4.2	Procedure.....	768
9.3.1A.5	Test Requirements.....	768
9.3.1B.1	Definition and applicability.....	768
9.3.1B.2	Minimum requirements.....	768
9.3.1B.3	Test purpose .....	769
9.3.1B.4	Method of test .....	769
9.3.1B.4.1	Initial conditions.....	769
9.3.1B.4.2	Procedure.....	770
9.3.1B.5	Test Requirements.....	770
9.3.1C	HS-DSCH throughput for Fixed Reference Channels 1.6 Mbps UE class QPSK/16QAM.....	770
9.3.1C.1	Definition and applicability.....	770
9.3.1C.2	Minimum requirements.....	770
9.3.1C.3	Test purpose .....	771
9.3.1C.4	Method of test .....	771
9.3.1C.4.1	Initial conditions.....	771
9.3.1C.4.2	Procedure.....	772
9.3.1C.5	Test Requirements.....	772
9.3.1D	HS-DSCH throughput for Fixed Reference Channels 2.2 Mbps UE class QPSK/16QAM.....	772
9.3.1D.1	Definition and applicability.....	772
9.3.1D.2	Minimum requirements.....	772
9.3.1D.3	Test purpose .....	773
9.3.1D.4	Method of test .....	773
9.3.1D.4.1	Initial conditions.....	773
9.3.1D.4.2	Procedure.....	774
9.3.1D.5	Test Requirements.....	774
9.3.1E	HS-DSCH throughput for Fixed Reference Channels 2.8 Mbps UE class QPSK/16QAM.....	774
9.3.1E.1	Definition and applicability.....	774

9.3.1E.2	Minimum requirements .....	774
9.3.1E.3	Test purpose .....	775
9.3.1E.4	Method of test .....	775
9.3.1E.4.1	Initial conditions .....	775
9.3.1E.4.2	Procedure.....	776
9.3.1E.5	Test Requirements.....	776
9.3.1F	HS-DSCH throughput for Fixed Reference Channels Categories 16-18- 64QAM.....	776
9.3.1F.1	Definition and applicability.....	776
9.3.1F.2	Minimum requirements .....	776
9.3.1F.3	Test purpose .....	777
9.3.1F.4	Method of test .....	777
9.3.1F.4.1	Initial conditions .....	777
9.3.1F.4.2	Procedure.....	777
9.3.1F.5	Test Requirements.....	778
9.3.1G	HS-DSCH throughput for Fixed Reference Channels – Categories 19-21 64QAM.....	778
9.3.1G.1	Definition and applicability.....	778
9.3.1G.2	Minimum requirements .....	778
9.3.1G.3	Test purpose .....	779
9.3.1G.4	Method of test .....	779
9.3.1G.4.1	Initial conditions .....	779
9.3.1G.4.2	Procedure.....	779
9.3.1G.5	Test Requirements.....	780
9.3.1H	HS-DSCH throughput for Fixed Reference Channels – Categories 22-24 64QAM.....	780
9.3.1H.1	Definition and applicability.....	780
9.3.1H.2	Minimum requirements .....	780
9.3.1H.3	Test purpose .....	781
9.3.1H.4	Method of test .....	781
9.3.1H.4.1	Initial conditions .....	781
9.3.1H.4.2	Procedure.....	781
9.3.1H.5	Test Requirements.....	782
9.3.1I	HS-DSCH throughput for Fixed Reference Channels –MIMO UE Category 25 .....	782
9.3.1I.1	Definition and applicability.....	782
9.3.1I.2	Minimum requirements .....	782
9.3.1I.3	Test purpose .....	783
9.3.1I.4	Method of test .....	783
9.3.1I.4.1	Initial conditions .....	783
9.3.1I.4.2	Procedure.....	784
9.3.1I.5	Test Requirements.....	784
9.3.1J	HS-DSCH throughput for Fixed Reference Channels –MIMO UE Category 26 .....	784
9.3.1J.1	Definition and applicability.....	784
9.3.1J.2	Minimum requirements .....	784
9.3.1J.3	Test purpose .....	785
9.3.1J.4	Method of test .....	785
9.3.1J.4.1	Initial conditions .....	785
9.3.1J.4.2	Procedure.....	786
9.3.1J.5	Test Requirements.....	786
9.3.1K	HS-DSCH throughput for Fixed Reference Channels –MIMO UE Category 27 .....	786
9.3.1K.1	Definition and applicability.....	786
9.3.1K.2	Minimum requirements .....	786
9.3.1K.3	Test purpose .....	787
9.3.1K.4	Method of test .....	787
9.3.1K.4.1	Initial conditions .....	787
9.3.1K.4.2	Procedure.....	788
9.3.1K.5	Test Requirements.....	788
9.3.1L	HS-DSCH throughput for Fixed Reference Channels –MIMO UE Category 28 .....	788
9.3.1L.1	Definition and applicability.....	788
9.3.1L.2	Minimum requirements .....	788
9.3.1L.3	Test purpose .....	789
9.3.1L.4	Method of test .....	789
9.3.1L.4.1	Initial conditions .....	789
9.3.1L.4.2	Procedure.....	790
9.3.1L.5	Test Requirements.....	790



9.3.1M	HS-DSCH throughput for Fixed Reference Channels –MIMO UE CategoriesCategory 29 .....	790
9.3.1M.1	Definition and applicability.....	790
9.3.1M.2	Minimum requirements .....	790
9.3.1M.3	Test purpose .....	791
9.3.1M.4	Method of test .....	791
9.3.1M.4.1	Initial conditions.....	791
9.3.1M.4.2	Procedure.....	792
9.3.1M.5	Test Requirements.....	792
9.3.1N	HS-DSCH throughput for Fixed Reference Channels –MIMO UE CategoriesCategory 30 .....	792
9.3.1N.1	Definition and applicability.....	792
9.3.1N.2	Minimum requirements .....	792
9.3.1N.3	Test purpose .....	793
9.3.1N.4	Method of test .....	793
9.3.1N.4.1	Initial conditions .....	793
9.3.1N.4.2	Procedure.....	794
9.3.1N.5	Test Requirements.....	794
9.3.2	HS-DSCH throughput for Variable Reference Channels.....	794
9.3.2A	HS-DSCH throughput for Variable Reference Channels 0.5 Mbps UE class.....	794
9.3.2A.1	Definition and applicability.....	794
9.3.2A.2	Minimum requirements .....	794
9.3.2A.3	Test purpose .....	795
9.3.2A.4	Method of test .....	795
9.3.2A.4.1	Initial conditions .....	795
9.3.2A.4.2	Procedure.....	796
9.3.2A.5	Test Requirements.....	796
9.3.2B	HS-DSCH throughput for Variable Reference Channels 1.1 Mbps UE class.....	796
9.3.2B.1	Definition and applicability.....	796
9.3.2B.2	Minimum requirements .....	796
9.3.2B.3	Test purpose .....	797
9.3.2B.4	Method of test .....	797
9.3.2B.4.1	Initial conditions .....	797
9.3.2B.4.2	Procedure.....	798
9.3.2B.5	Test Requirements.....	798
9.3.2C	HS-DSCH throughput for Variable Reference Channels 1.6 Mbps UE class.....	798
9.3.2C.1	Definition and applicability.....	798
9.3.2C.2	Minimum requirements .....	798
9.3.2C.3	Test purpose .....	799
9.3.2C.4	Method of test .....	799
9.3.2C.4.1	Initial conditions.....	799
9.3.2C.4.2	Procedure.....	800
9.3.2C.5	Test Requirements.....	800
9.3.2D	HS-DSCH throughput for Variable Reference Channels 2.2 Mbps UE class.....	800
9.3.2D.1	Definition and applicability.....	800
9.3.2D.2	Minimum requirements .....	800
9.3.2D.3	Test purpose .....	801
9.3.2D.4	Method of test .....	801
9.3.2D.4.1	Initial conditions .....	801
9.3.2D.4.2	Procedure.....	802
9.3.2D.5	Test Requirements.....	802
9.3.2E	HS-DSCH throughput for Variable Reference Channels 2.8 Mbps UE class.....	802
9.3.2E.1	Definition and applicability.....	802
9.3.2E.2	Minimum requirements .....	802
9.3.2E.3	Test purpose .....	803
9.3.2E.4	Method of test .....	803
9.3.2E.4.1	Initial conditions .....	803
9.3.2E.4.2	Procedure.....	804
9.3.2E.5	Test Requirements.....	804
9.3.3	Reporting of HS-DSCH Channel Quality Indicator.....	804
9.3.3A	Reporting of HS-DSCH Channel Quality Indicator-0.5Mbps UE class .....	804
9.3.3A.1	Definition and applicability.....	804
9.3.3A.2	Minimum requirements .....	804
9.3.3A.3	Test purpose .....	805

9.3.3A.4	Method of test .....	805
9.3.3A.4.1	Initial conditions .....	805
9.3.3A.4.2	Procedure.....	805
9.3.3A.5	Test Requirements.....	806
9.3.3B	Reporting of HS-DSCH Channel Quality Indicator-1.1Mbps UE class .....	806
9.3.3B.1	Definition and applicability.....	806
9.3.3B.2	Minimum requirements .....	806
9.3.3B.3	Test purpose .....	806
9.3.3B.4	Method of test .....	807
9.3.3B.4.1	Initial conditions .....	807
9.3.3B.4.2	Procedure.....	807
9.3.3B.5	Test Requirements.....	807
9.3.3C	Reporting of HS-DSCH Channel Quality Indicator-1.6Mbps UE class .....	807
9.3.3C.1	Definition and applicability.....	807
9.3.3C.2	Minimum requirements .....	808
9.3.3C.3	Test purpose .....	808
9.3.3C.4	Method of test .....	808
9.3.3C.4.1	Initial conditions .....	808
9.3.3C.4.2	Procedure.....	808
9.3.3C.5	Test Requirements.....	809
9.3.3D	Reporting of HS-DSCH Channel Quality Indicator-2.2Mbps UE class .....	809
9.3.3D.1	Definition and applicability.....	809
9.3.3D.2	Minimum requirements .....	809
9.3.3D.3	Test purpose .....	810
9.3.3D.4	Method of test .....	810
9.3.3D.4.1	Initial conditions .....	810
9.3.3D.4.2	Procedure.....	810
9.3.3D.5	Test Requirements.....	810
9.3.3E	Reporting of HS-DSCH Channel Quality Indicator-2.8Mbps UE class .....	811
9.3.3E.1	Definition and applicability.....	811
9.3.3E.2	Minimum requirements .....	811
9.3.3E.3	Test purpose .....	811
9.3.3E.4	Method of test .....	811
9.3.3E.4.1	Initial conditions .....	811
9.3.3E.4.2	Procedure.....	812
9.3.3E.5	Test Requirements.....	812
9.3.3F	Reporting of HS-DSCH Channel Quality Indicator – 64QAM UE capability categories 16 - 18 .....	812
9.3.3F.1	Definition and applicability.....	812
9.3.3F.2	Minimum requirements .....	812
9.3.3F.3	Test purpose .....	813
9.3.3F.4	Method of test .....	813
9.3.3F.4.1	Initial conditions .....	813
9.3.3F.4.2	Procedure.....	813
9.3.3F.5	Test Requirements.....	814
9.3.3G	Reporting of HS-DSCH Channel Quality Indicator – 64QAM UE capability categories 19 - 21 .....	814
9.3.3G.1	Definition and applicability.....	814
9.3.3G.2	Minimum requirements .....	814
9.3.3G.3	Test purpose .....	815
9.3.3G.4	Method of test .....	815
9.3.3G.4.1	Initial conditions .....	815
9.3.3G.4.2	Procedure.....	815
9.3.3G.5	Test Requirements.....	815
9.3.3H	Reporting of HS-DSCH Channel Quality Indicator – 64QAM UE capability categories 22 - 24 .....	816
9.3.3H.1	Definition and applicability.....	816
9.3.3H.2	Minimum requirements .....	816
9.3.3H.3	Test purpose .....	816
9.3.3H.4	Method of test .....	816
9.3.3H.4.1	Initial conditions .....	816
9.3.3H.4.2	Procedure.....	817
9.3.3H.5	Test Requirements.....	817
9.3.3I	Reporting of HS-DSCH Channel Quality Indicator – category 25 MIMO .....	817
9.3.3I.1	Definition and applicability.....	817

9.3.3I.2	Minimum requirements .....	817
9.3.3I.3	Test purpose .....	818
9.3.3I.4	Method of test .....	818
9.3.3I.4.1	Initial conditions .....	818
9.3.3I.4.2	Procedure .....	818
9.3.3I.5	Test Requirements .....	819
9.3.3J	Reporting of HS-DSCH Channel Quality Indicator – category 26 MIMO .....	819
9.3.3J.1	Definition and applicability .....	819
9.3.3J.2	Minimum requirements .....	819
9.3.3J.3	Test purpose .....	820
9.3.3J.4	Method of test .....	820
9.3.3J.4.1	Initial conditions .....	820
9.3.3J.4.2	Procedure .....	820
9.3.3J.5	Test Requirements .....	820
9.3.3K	Reporting of HS-DSCH Channel Quality Indicator – category 27 MIMO .....	820
9.3.3K.1	Definition and applicability .....	820
9.3.3K.2	Minimum requirements .....	821
9.3.3K.3	Test purpose .....	821
9.3.3K.4	Method of test .....	821
9.3.3K.4.1	Initial conditions .....	821
9.3.3K.4.2	Procedure .....	821
9.3.3K.5	Test Requirements .....	822
9.3.3L	Reporting of HS-DSCH Channel Quality Indicator – category 28 MIMO .....	822
9.3.3L.1	Definition and applicability .....	822
9.3.3L.2	Minimum requirements .....	822
9.3.3L.3	Test purpose .....	823
9.3.3L.4	Method of test .....	823
9.3.3L.4.1	Initial conditions .....	823
9.3.3L.4.2	Procedure .....	823
9.3.3L.5	Test Requirements .....	823
9.3.3M	Reporting of HS-DSCH Channel Quality Indicator – category 29 MIMO .....	823
9.3.3M.1	Definition and applicability .....	823
9.3.3M.2	Minimum requirements .....	823
9.3.3M.3	Test purpose .....	824
9.3.3M.4	Method of test .....	824
9.3.3M.4.1	Initial conditions .....	824
9.3.3M.4.2	Procedure .....	824
9.3.3N	Reporting of HS-DSCH Channel Quality Indicator – category 30 MIMO .....	824
9.3.3N.1	Definition and applicability .....	824
9.3.3N.2	Minimum requirements .....	825
9.3.3N.3	Test purpose .....	825
9.3.3N.4	Method of test .....	825
9.3.3N.4.1	Initial conditions .....	825
9.3.3N.4.2	Procedure .....	825
9.3.3N.5	Test Requirements .....	825
9.3.4	HS-SCCH Detection Performance .....	826
9.3.4.1	Definition and applicability .....	826
9.3.4.2	Minimum requirements .....	826
9.3.4.3	Test purpose .....	826
9.3.4.4	Method of test .....	827
9.3.4.4.1	Initial conditions .....	827
9.3.4.4.2	Procedure .....	827
9.3.4.5	Test Requirements .....	827
9.4	Performance requirement for 7.68 Mcps TDD option .....	828
9.4.1	HS-DSCH throughput for Fixed Reference Channels .....	828
9.4.1.1	Definition and applicability .....	828
9.4.1.2	Minimum requirements .....	828
9.4.1.3	Test purpose .....	830
9.4.1.4	Method of test .....	830
9.4.1.5	Test Requirements .....	831
9.4.2	HS-DSCH throughput for Variable Reference Channels .....	831
9.4.3	Reporting of HS-DSCH Channel Quality Indicator .....	831

9.4.4	HS-SCCH Detection Performance.....	831
9.4.4.1	Definition and applicability.....	831
9.4.4.2	Minimum requirements.....	831
9.4.4.3	Test purpose.....	832
9.4.4.4	Method of test.....	832
9.4.4.5	Test Requirements.....	832
10	Performance requirements (MBMS).....	833
10.1	Demodulation of MCCH.....	833
10.1.1	Definition and applicability.....	833
10.1.1.1	3.84 Mcps TDD Option.....	833
10.1.1.2	7.68 Mcps TDD Option.....	833
10.1.2	Minimum requirement.....	833
10.1.2.1	3.84 Mcps TDD Option.....	833
10.1.2.2	7.68 Mcps TDD Option.....	833
10.1.3	Test Purpose.....	834
10.1.4	Method of test.....	834
10.1.4.1	Initial conditions.....	834
10.1.4.2	Procedure.....	834
10.1.5	Test Requirements.....	835
10.2	Demodulation of MTCH.....	835
10.2.1	Definition and applicability.....	835
10.2.1.1	3.84 Mcps TDD Option.....	835
10.2.1.2	1.28 Mcps TDD Option.....	835
10.2.1.3	7.68 Mcps TDD Option.....	835
10.2.2	Minimum requirement.....	835
10.2.2.1	3.84 Mcps TDD Option.....	835
10.2.2.2	1.28 Mcps TDD Option.....	836
10.2.2.3	7.68 Mcps TDD Option.....	836
10.2.3	Test Purpose.....	837
10.2.4	Method of test.....	837
10.2.4.1	Initial conditions.....	837
10.2.4.2	Procedure.....	837
10.2.5	Test Requirements.....	837
10.2A	Demodulation of MTCH-for MBSFN capable UE.....	838
10.2A.1	Definition and applicability.....	838
10.2A.1.1	Void.....	838
10.2A.1.2	1.28 Mcps TDD Option.....	838
10.2A.1.3	Void.....	838
10.2A.2	Minimum requirement.....	838
10.2A.2.1	Void.....	838
10.2A.2.2	1.28 Mcps TDD Option.....	838
10.2A.2.3	Void.....	839
10.2A.3	Test Purpose.....	839
10.2A.4	Method of test.....	839
10.2A.4.1	Initial conditions.....	839
10.2A.4.2	Procedure.....	839
10.2A.5	Test Requirements.....	839
10.3	Demodulation of MTCH and cell identification.....	839
10.3.1	1.28Mcps TDD option.....	839
10.3.1.1	Definition and applicability.....	839
10.3.1.2	Minimum requirements.....	840
10.3.1.3	Test purpose.....	840
10.3.1.4	Method of test.....	840
10.3.1.5	Test requirements.....	841
10.4	Demodulation of MCCH for a MBSFN capable UE.....	842
10.4.1	Definition and applicability.....	842
10.4.1.1	3.84 Mcps TDD Option.....	842
10.4.1.2	7.68 Mcps TDD Option.....	842
10.1.2	Minimum requirement.....	842
10.1.4.1	3.84 Mcps TDD Option.....	842
10.4.2.2	7.68 Mcps TDD Option.....	843

10.4.3	Test Purpose.....	843
10.4.4	Method of test .....	843
10.4.4.1	Initial conditions .....	843
10.4.4.2	Procedure .....	844
10.4.5	Test Requirements .....	844
10.5	Demodulation of MTCH for a MBSFN capable UE.....	844
10.5.1	Definition and applicability .....	844
10.5.1.1	3.84 Mcps TDD Option.....	844
10.5.1.2	7.68 Mcps TDD Option.....	844
10.5.2	Minimum requirement .....	845
10.5.2.1	3.84 Mcps TDD Option.....	845
10.5.2.2	7.68 Mcps TDD Option.....	845
10.5.3	Test Purpose.....	845
10.5.4	Method of test .....	846
10.5.4.1	Initial conditions .....	846
10.5.4.2	Procedure .....	846
10.5.5	Test Requirements .....	846
10.5A	Demodulation of MTCH for a IMB capable UE.....	846
10.5A.1	Definition and applicability .....	846
10.5A.2	Minimum requirement .....	846
10.5A.3	Test Purpose.....	847
10.5A.4	Method of test .....	847
10.5A.4.1	Initial conditions .....	847
10.5A.4.2	Procedure .....	847
10.5A.5	Test Requirements .....	848
10.6	MBSFN TDD and FDD same platform sharing.....	848
10.6.1	Definition and applicability .....	848
10.6.1.1	3.84 Mcps TDD Option.....	848
10.6.1.2	7.68 Mcps TDD Option.....	848
10.6.2	Minimum requirement .....	848
10.6.2.1	3.84 Mcps TDD Option.....	848
10.6.2.3	7.68 Mcps TDD Option.....	849
10.6.3	Test Purpose.....	850
10.6.4	Method of test .....	850
10.6.4.1	Initial conditions .....	850
10.6.4.2	Procedure .....	850
10.6.5	Test Requirements .....	850
11	Performance requirement (E-DCH) .....	851
11.1	Detection of E-DCH HARQ ACK Indicator Channel (E-HICH).....	851
11.1.1	Definition and applicability .....	851
11.1.1.1	3.84 Mcps TDD Option.....	851
11.1.1.2	1.28 Mcps TDD Option.....	851
11.1.1.3	7.68 Mcps TDD Option.....	851
11.1.2	Minimum requirement .....	851
11.1.2.1	3.84 Mcps TDD Option.....	851
11.1.2.2	1.28 Mcps TDD Option.....	852
11.1.2.3	7.68 Mcps TDD Option.....	852
11.1.3	Test Purpose.....	852
11.1.4	Method of test .....	852
11.1.4.1	Initial conditions .....	852
11.1.4.1.1	3.84Mcps TDD Option.....	852
11.1.4.1.2	1.28Mcps TDD Option.....	853
11.1.4.1.3	7.68Mcps TDD Option.....	853
11.1.4.2	3.84Mcps TDD Option.....	854
11.1.4.2.2	1.28Mcps TDD Option.....	854
11.1.4.2.3	7.68Mcps TDD Option.....	855
11.1.5	Test Requirements .....	856
11.2	Demodulation of E-DCH Absolute Grant Channel (E-AGCH) .....	856
11.2.1	Definition and applicability .....	856
11.2.2.1	3.84 Mcps TDD Option.....	856
11.2.2.2	1.28 Mcps TDD Option.....	856

11.2.2.3	7.68 Mcps TDD Option.....	856
11.2.2	Minimum requirement .....	856
11.2.2.1	3.84 Mcps TDD Option.....	856
11.2.2.2	1.28Mcps TDD Option.....	857
11.2.2.3	7.68 Mcps TDD Option.....	857
11.2.3	Test Purpose.....	857
11.2.4	Method of test .....	858
11.2.4.1	Initial conditions .....	858
11.2.4.2	Procedure .....	859
11.2.5	Test Requirements .....	859
<b>Annex A (informative): Connection Diagrams .....</b>		<b>861</b>
<b>Annex B (normative): Global In-Channel TX-Test .....</b>		<b>867</b>
B.1	General .....	867
B.2	Definition of the process .....	867
B.2.1	Basic principle.....	867
B.2.2	Output signal of the TX under test .....	867
B.2.3	Reference signal .....	867
B.2.4	void.....	868
B.2.5	Classification of measurement results .....	868
B.2.6	Process definition to achieve results of type "deviation".....	868
B.2.7	Process definition to achieve results of type "residual" .....	869
B.2.7.1	Error Vector Magnitude (EVM) .....	869
B.2.7.2	Peak Code Domain Error (PCDE) .....	870
B.3	Notes.....	870
<b>Annex C (normative): Measurement channels.....</b>		<b>873</b>
C.1	General .....	873
C.2	UL Reference measurement channels .....	873
C.2.1	UL reference measurement channel (12,2 kbps) .....	873
C.2.1.1	3,84 TDD Option .....	873
C.2.1.2	UL reference measurement channel (12,2 kbps) for 1,28 Mcps TDD Option .....	875
C.2.1.3	7,68 TDD Option .....	876
C.2.2	UL multi code reference measurement channel (12,2 kbps) .....	877
C.2.2.1	3,84 Mcps TDD Option .....	877
C.2.2.2	UL multi code reference measurement channel (12,2 kbps) for 1,28 Mcps TDD Option .....	879
C.2.2.2a	UL multi code( HS-SICH and DPCH) reference measurement channel for 1,28 Mcps TDD Option .....	880
C.2.2.3	7,68 Mcps TDD Option .....	883
C.2.3	UL reference measurement channel (64 kbps) .....	884
C.2.3.1	3.84 Mcps TDD Option .....	884
C.2.3.2	1.28 Mcps TDD Option .....	886
C.2.3.3	7.68 Mcps TDD Option .....	887
C.2.4	UL reference measurement channel (144 kbps) .....	890
C.2.4.1	3.84 Mcps TDD Option .....	890
C.2.4.2	1.28 Mcps TDD Option .....	891
C.2.4.3	7.68 Mcps TDD Option .....	892
C.2.5	UL reference measurement channel (384 kbps) .....	895
C.2.5.1	3.84 Mcps TDD Option .....	895
C.2.5.2	1.28 Mcps TDD Option .....	897
C.2.5.3	7.68 Mcps TDD Option .....	898
C.3	DL Reference measurement channels .....	900
C.3.1	DL reference measurement channel (12,2 kbps) .....	900
C.3.1.1	3,84 Mcps TDD Option .....	900
C.3.1.2	DL reference measurement channel (12,2 kbps) for 1,28 Mcps TDD Option .....	901
C.3.1.3	7,68 Mcps TDD Option .....	902
C.3.2	DL reference measurement channel (64 kbps) .....	904
C.3.2.1	3,84 Mcps TDD Option .....	904

C.3.2.2	DL reference measurement channel (64 kbps) for 1,28 Mcps TDD Option .....	906
C.3.2.3	7,68 Mcps TDD Option .....	907
C.3.3	DL reference measurement channel (144 kbps) .....	909
C.3.3.1	3,84 Mcps TDD Option .....	909
C.3.3.2	DL reference measurement channel (144 kbps) for 1,28 Mcps TDD Option .....	912
C.3.3.3	7,68 Mcps TDD Option .....	913
C.3.4	DL reference measurement channel (384 kbps) .....	915
C.3.4.1	3,84 Mcps TDD Option .....	915
C.3.4.2	DL reference measurement channel (384 kbps) for 1,28 Mcps TDD Option .....	917
C.3.4.3	7,68 Mcps TDD Option .....	918
C.3.5	BCH reference measurement channel .....	920
C.3.5.1	3,84 Mcps TDD Option .....	920
C.3.5.2	BCH reference measurement channel (12.3 kbps) for 1,28 Mcps TDD Option .....	920
C.3.5.3	7,68 Mcps TDD Option .....	921
C.3.6	DL reference measurement channel (2 Mbps) for 3,84 Mcps TDD Option .....	922
C.3.7	DL reference measurement channel (2 Mbps) for 7,68 Mcps TDD Option .....	925
C.3.8	DL reference measurement channel for MBSFN only UEs (28kbps) .....	927
C.3.8.1	3,84 Mcps TDD IMB Option.....	927
C.4	HSDPA reference measurement channels.....	929
C.4.1	HSDPA reference measurement channels for 3,84 Mcps TDD option .....	929
C.4.1.1	Reference measurement channels for 7,3 Mbps – Category 8 - UE .....	929
C.4.1.1.1	QPSK modulation scheme for test 1, 2, 3 .....	929
C.4.1.1.2	QPSK modulation scheme for test 4 .....	930
C.4.1.1.3	16QAM modulation scheme for test 1, 2, 3 .....	931
C.4.1.1.4	16QAM modulation scheme for test 4 .....	932
C.4.2	HSDPA reference measurement channels for 1.28 Mcps TDD option .....	933
C.4.2.1	Reference measurement channels for 0.5Mbps UE class .....	933
C.4.2.1.1	QPSK modulation scheme .....	933
C.4.2.2	Reference measurement channels for 1.1Mbps UE class .....	933
C.4.2.2.1	QPSK modulation scheme .....	933
C.4.2.2.2	16QAM modulation scheme .....	934
C.4.2.3	Reference measurement channels for 1.6Mbps UE class .....	935
C.4.2.3.1	QPSK modulation scheme .....	935
C.4.2.3.2	16QAM modulation scheme .....	936
C.4.2.4	Reference measurement channels for 2.2Mbps UE class .....	936
C.4.2.4.1	QPSK modulation scheme .....	936
C.4.2.4.2	16QAM modulation scheme .....	937
C.4.2.5	Reference measurement channels for 2.8Mbps UE class .....	938
C.4.2.5.1	QPSK modulation scheme .....	938
C.4.2.5.2	16QAM modulation scheme .....	939
C.4.2.6	Reference measurement channels for Category 16-24 UE .....	940
C.4.2.6.1	Reference measurement channel for category 16-18 UE .....	940
C.4.2.6.2	Reference measurement channel for category 19-21 UE .....	941
C.4.2.6.3	Reference measurement channel for category 22-24 UE .....	942
C.4.2.7	Reference measurement channels for Category 25 UE.....	943
C.4.2.7.1	QPSK modulation scheme .....	943
C.4.2.7.2	16QAM modulation scheme .....	945
C.4.2.8	Reference Measurement Channel for category 26 UE.....	947
C.4.2.8.1	QPSK modulation scheme .....	947
C.4.2.8.2	16QAM modulation scheme .....	949
C.4.2.9	Reference Measurement Channel for category 27 UE.....	951
C.4.2.9.1	QPSK modulation scheme .....	951
C.4.2.9.2	16QAM modulation scheme .....	953
C.4.2.10	Reference Measurement Channel for category 28 UE.....	955
C.4.2.10.1	64QAM modulation scheme .....	955
C.4.2.11	Reference Measurement Channel for category 29 UE.....	957
C.4.2.11.1	64QAM modulation scheme .....	957
C.4.2.12	Reference Measurement Channel for category 30 UE.....	959
C.4.2.12.1	64QAM modulation scheme .....	959
C.4.2A	HSDPA reference measurement channels for 7,68 Mcps TDD option .....	961
C.4.2A.1	Reference measurement channels for 5,3 Mbps - Category 8 - UE.....	961

C.4.2A.1.1	QPSK modulation scheme for test 1, 2, 3 & 4 .....	961
C.4.2A.1.2	16QAM modulation scheme for test 1, 2, 3 & 4 .....	962
C.4.3	Variable Reference Channel definition for 3,84 Mcps and 1,28 Mcps TDD options.....	963
C.5	Downlink reference parameters for MBMS tests .....	963
C.5.1	MCCH .....	963
C.5.1.1	3.84 Mcps TDD Option .....	963
C.5.1.2	1.28 Mcps TDD Option .....	964
C.5.1.3	7.68 Mcps TDD Option .....	964
C.5.2	MTCH .....	965
C.5.2.1	3.84 Mcps TDD Option (non-IMB).....	965
C.5.2.1A	3.84 Mcps TDD Option (IMB).....	965
C.5.2.2	1.28 Mcps TDD Option .....	966
C.5.2.3	7.68 Mcps TDD Option .....	967
C.6	E-DCH Reference measurement channels .....	968
C.6.1	E-DCH Fixed Reference Channels.....	968
C.6.1.1	3.84 Mcps TDD Option .....	968
C.6.1.1.1	Fixed Reference Channel 1 (FRC1) .....	968
C.6.1.1.2	Fixed Reference Channel 2 (FRC2) .....	969
C.6.1.1.3	Fixed Reference Channel 3 (FRC3) .....	970
C.6.1.2	1.28Mcps TDD Option .....	971
C6.1.2.1	E-DCH Fixed reference channel 1(FRC1) .....	971
C6.1.2.2	Fixed reference channel 2(FRC2) .....	972
C6.1.2.3	Fixed reference channel 3(FRC3) .....	973
C.6.1.3.1	Fixed Reference Channel 1 (FRC1) .....	974
C.6.1.3.2	Fixed Reference Channel 2 (FRC2) .....	975
C.6.1.3.3	Fixed Reference Channel 3 (FRC3) .....	976
<b>Annex D (normative):</b>	<b>Propagation conditions.....</b>	<b>978</b>
D.1	Test Environments.....	978
D.2	Propagation Conditions .....	978
D.2.1	Static propagation condition.....	978
D.2.2	Multi-path fading propagation conditions .....	978
D.2.2.1	3.84 Mcps TDD Option .....	978
D.2.2.2	1.28 Mcps TDD Option .....	979
D.2.2.3	7.68 Mcps TDD Option .....	981
D.2.3	Moving propagation conditions.....	983
D.2.4	Birth-Death propagation conditions .....	984
D.2.4A	High speed train condition.....	984
D.2.5	Multi-path fading propagation conditions .....	985
D.2.5.1	3.84 Mcps TDD Option .....	985
D.2.5.1	1.28 Mcps TDD Option .....	985
D.2.5.1.1	MIMO Dual Stream Static Orthogonal Conditions.....	986
D.2.5.1	7.68 Mcps TDD Option .....	986
<b>Annex E (normative):</b>	<b>Common RF test conditions.....</b>	<b>987</b>
E.1	General .....	987
E.2	Connection Set-up .....	987
E.3	During connection .....	987
E.3.1	Measurement of Tx Characteristics.....	987
E.3.2	Measurement of Rx Characteristics.....	988
E.3.3	Measurement of Performance requirements.....	988
<b>Annex F (normative):</b>	<b>General test conditions and declarations.....</b>	<b>989</b>
F.1	Acceptable uncertainty of Test System .....	989
F.1.1	Measurement of test environments.....	989
F.1.2	Measurement of transmitter.....	990
F.1.3	Measurement of receiver.....	991
F.1.4	Performance requirement .....	991



F.1.5	Requirements for support of RRM .....	991
F.1.6	Performance requirement (HSDPA).....	992
F.2	Test Tolerances (This clause is informative).....	992
F.2.1	Transmitter .....	993
F.2.2	Receiver.....	993
F.2.3	Performance requirements.....	994
F.2.4	Requirements for support of RRM .....	994
F.2.4.1	TDD/TDD Cell Reselection on intra-frequency cells .....	994
F.2.4.1.1	3,84 Mcps TDD Option.....	994
F.2.4.1.2	1,28 Mcps Option.....	994
F.2.4.1.3	7,68 Mcps TDD Option.....	994
F.2.5	Performance requirements (HSDPA).....	995
F.3	Interpretation of measurement results .....	995
F.4	Derivation of Test Requirements (This clause is informative).....	995
F.4.1	3.84Mcps TDD Option.....	996
F.4.2	1.28Mcps TDD Option.....	1000
F.4.2.1	Transmitter.....	1000
F.4.2.2	Receiver .....	1003
F.4.2.3	Performance requirement.....	1005
F.4.2.4	Performance of HSDPA.....	1006
F.4.3	7.68Mcps TDD Option.....	1007
F.5	Acceptable uncertainty of Test Equipment (This clause is informative) .....	1010
F.5.1	Transmitter measurements.....	1011
F.5.2	Receiver measurements .....	1011
F.5.3	Performance measurements.....	1011
F.5.5	Performance measurements (HSDPA) .....	1012
F.6	General rules for statistical testing .....	1012
F.6.1	Statistical testing of receiver BER/BLER performance .....	1012
F.6.1.1	Error Definition .....	1012
F.6.1.2	Test Method.....	1012
F.6.1.3	Test Criteria .....	1012
F.6.1.4	Calculation assumptions .....	1013
F.6.1.4.1	Statistical independence .....	1013
F.6.1.4.2	Applied formulas.....	1013
F.6.1.4.3	Test procedure.....	1013
F.6.1.5	Definition of good pass fail decision .....	1013
F.6.1.6	Good balance between testtime and statistical significance.....	1014
F.6.1.7	Pass fail decision rules.....	1015
F.6.1.8	Test conditions for BER,BLER tests .....	1016
F.6.1.9	Practical Use (informative).....	1018
F.6.2	Statistical testing of RRM delay performance.....	1019
F.6.2.1	Test Method.....	1019
F.6.2.2	Bad Delay Ratio (ER).....	1019
F.6.2.3	Test Criteria .....	1019
F.6.2.4	Calculation assumptions .....	1020
F.6.2.4.1	Statistical independence .....	1020
F.6.2.4.2	Applied formulas.....	1020
F.6.2.4.3	Approximation of the distribution.....	1020
F.6.2.5	Definition of good pass fail decision. ....	1020
F.6.2.6	Good balance between test-time and statistical significance .....	1021
F.6.2.7	Pass fail decision rules.....	1021
F.6.2.8	Test conditions for RRM delay tests.....	1022
F.6.2.9	Practical Use (informative).....	1024
F.6.3	Statistical Testing of HSDPA Receiver Performance .....	1025
F.6.3.1	Definition.....	1025
F.6.3.2	Mapping throughput to block error ratio.....	1025
F.6.3.3	Bad DUT factor .....	1026
F.6.3.3.1	Bad DUT factor, range of applicability.....	1027
F.6.3.4	Minimum Test time .....	1028

F.6.3.5	Pass fail decision rules .....	1028
<b>Annex G (normative):</b>	<b>Environmental conditions .....</b>	<b>1038</b>
G.1	General .....	1038
G.2	Environmental requirements .....	1038
G.2.1	Temperature .....	1038
G.2.2	Voltage .....	1038
G.2.3	Vibration.....	1039
G.2.4	Specified frequency range .....	1039
<b>Annex H (normative):</b>	<b>Terminal Baseline and Service Implementation Capabilities (TDD)....</b>	<b>1040</b>
H.1	Baseline Implementation Capabilities of 3.84 Mcps TDD.....	1040
H.1A	Baseline Implementation Capabilities of 1.28 Mcps TDD.....	1040
H.1B	Baseline Implementation Capabilities of 7.68 Mcps TDD.....	1041
H.2	Service Implementation Capabilities: .....	1041
<b>Annex I (normative):</b>	<b>Default Message Contents .....</b>	<b>1042</b>
<b>Annex J (informative):</b>	<b>Change history .....</b>	<b>1047</b>
History .....		1053

---

# Foreword

This Technical Specification (TS) has been produced by the 3<sup>rd</sup> Generation Partnership Project (3GPP).

The contents of the present document are subject to continuing work within the TSG and may change following formal TSG approval. Should the TSG modify the contents of the present document, it will be re-released by the TSG with an identifying change of release date and an increase in version number as follows:

Version x.y.z

where:

x the first digit:

- 1 presented to TSG for information;
- 2 presented to TSG for approval;
- 3 or greater indicates TSG approved document under change control.

y the second digit is incremented for all changes of substance, i.e. technical enhancements, corrections, updates, etc.

z the third digit is incremented when editorial only changes have been incorporated in the document.

---

# 1 Scope

This present document specifies the measurement procedure for the conformance test of the mobile station that contain transmitting characteristics, receiving characteristics and performance requirements in addition to requirements for support of RRM (Radio Resource Management) in both UTRATDD modes. The two options are the 3,84 Mcps TDD Option and 1,28 Mcps TDD Option, respectively.

The requirements are listed in different clauses only if the corresponding parameters deviate. More generally, tests are only applicable to those mobiles that are intended to support the appropriate functionality. To indicate the circumstances in which tests apply, this is noted in the "definition and applicability" part of the test.

For example only release 5 and later UE declared to support HSDPA shall be tested for this functionality. In the event that for some tests different conditions apply for different releases, this is indicated within the text of the test itself.

---

# 2 References

The following documents contain provisions which, through reference in this text, constitute provisions of the present document.

- References are either specific (identified by date of publication, edition number, version number, etc.) or non-specific.
- For a specific reference, subsequent revisions do not apply.
- For a non-specific reference, the latest version applies. In the case of a reference to a 3GPP document (including a GSM document), a non-specific reference implicitly refers to the latest version of that document *in the same Release as the present document*.

- [1] 3GPP TS 25.102 (V4.0.0): "UTRA (UE) TDD; Radio Transmission and Reception (TDD)".
- [2] 3GPP TS 25.123: "Requirements for Support of Radio Resource Management (TDD)".
- [3] 3GPP TS 34.108 "Common Test Environments for User Equipment (UE) Conformance Testing"
- [4] 3GPP TS 34.109: "Terminal logical test interface; Special conformance testing functions".
- [5] 3GPP TS 25.224: "Physical Layer Procedures (TDD)".
- [6] 3GPP TR 21.905: "Vocabulary for 3GPP Specifications".
- [7] 3GPP TR 25.990: "Vocabulary".
- [8] ITU-R Recommendation SM.328-9: "Spectra and bandwidth of emissions".
- [9] 3GPP TS 25.331: "Radio Resource Control (RRC) Protocol Specification".
- [10] 3GPP TS 25.433 "UTRAN Iub Interface NBAP Signalling".
- [11] ITU-R Recommendation SM.329: "Spurious emissions".
- [12] 3GPP TS 25.304: "UE Procedures in Idle Mode and Procedures for Cell Reselection in Connected Mode".
- [13] 3GPP TS 25.303: "Interlayer Procedures in Connected Mode".
- [14] 3GPP TS 25.321: "Medium Access Control (MAC) protocol specification".
- [15] 3GPP TS 25.223: "Spreading and modulation (TDD)".
- [16] ETSI ETR 273-1-2: "Improvement of radiated methods of measurement (using test sites) and evaluation of the corresponding measurement uncertainties; Part 1: Uncertainties in the measurement of mobile radio equipment characteristics; Sub-part 2: Examples and annexes".
- [17] 3GPP TR 25.926: "UE Radio Access Capabilities".

- [18] 3GPP TR 21.904: "UE capability requirements".
- [19] 3GPP TS 25.221: "Physical channels and mapping of transport channels onto physical channels (TDD)".
- [20] 3GPP TS 45.008: "Digital cellular telecommunications system (Phase 2+); Radio subsystem link control".
- [21] 3GPP TS 34.123-1: "User Equipment (UE) Conformance Specification; Part 1: Protocol Conformance Specification".
- [22] 3GPP TS 25.225: "Physical Layer – Measurements (TDD)".
- [23] 3GPP TS 51.010-1: " Mobile Station (MS) conformance specification; Part 1: Conformance specification".
- [24] 3GPP TS 25.306: "UE Radio Access capabilities definition".
- [25] ITU-T recommendation O.153: "Basic parameters for the measurement of error performance at bit rates below the primary rate".
- [26] 3GPP TS 36.133: "Requirements for support of radio resource management"
- [27] 3GPP TS 36.101: "User Equipment (UE) radio transmission and reception"

---

## 3 Definitions, abbreviations and equations

For the purposes of the present document, the definitions, symbols, abbreviations and equations used in the present document are listed in TR 21.905 [6] and TR 25.990 [7].

### 3.1 Definitions

For the purpose of the present document, the following definition applies:

**Power Spectral Density:** The units of Power Spectral Density (PSD) are extensively used in this document. PSD is a function of power versus frequency and when integrated across a given bandwidth, the function represents the mean power in such a bandwidth. When the mean power is normalised to (divided by) the chip-rate it represents the mean energy per chip. Some signals are directly defined in terms of energy per chip, (DPCH\_Ec, Ec, and P-CCPCH\_Ec) and others defined in terms of PSD (Io, Ioc, Ior and I<sub>or</sub>). There also exist quantities that are a ratio of energy per chip to PSD (DPCH\_Ec/I<sub>or</sub>, Ec/I<sub>or</sub> etc.). This is the common practice of relating energy magnitudes in communication systems.

It can be seen that if both energy magnitudes in the ratio are divided by time, the ratio is converted from an energy ratio to a power ratio, which is more useful from a measurement point of view. It follows that an energy per chip of X dBm/3,84 MHz (3,84 Mcps TDD option) or X dBm/1,281,28 MHz (1,281,28 Mcps TDD option) can be expressed as a mean power per chip of X dBm. Similarly, a signal PSD of Y dBm/3,84 MHz (3,84 Mcps TDD option) or Y dBm/1,281,28 MHz (1,281,28 Mcps TDD option) can be expressed as a signal power of Y dBm.

**Maximum Output Power:** This is a measure of the maximum power the UE can transmit (i.e. the actual power as would be measured assuming no measurement error) in a bandwidth of at least  $(1 + \alpha)$  times the chip rate of the radio access mode. The period of measurement shall be a transmit timeslot excluding the guard period.

**Mean Power:** When applied to a CDMA modulated signal this is the power (transmitted or received) in a bandwidth of at least  $(1 + \alpha)$  times the chip rate of the radio access mode. The period of measurement shall be a transmit timeslot excluding the guard period unless otherwise stated.

**Output power:** The mean power of the UE delivered to a load with resistance equal to the nominal load impedance of the transmitter.

**RRC Filtered Mean Power:** The mean power as measured through a root raised cosine filter with roll-off factor  $\alpha$  and a bandwidth equal to the chip rate of the radio access mode.

**Nominal Maximum Output Power:** This is the nominal power defined by the UE power class. The period of measurement shall be a transmit timeslot excluding the guard period.

**Received Signal Code Power (RSCP):** Given only signal power is received, the RRC filtered mean power of the received signal after despreading and combining.

**Interference Signal Code Power (ISCP):** Given only interference power is received, the RRC filtered mean power of the received signal after despreading to the code and combining. Equivalent to the RSCP value but now only interference is received instead of signal.

The following two definitions are applicable for LCR TDD multi-frequency operation.

**Inter-frequency cell:** In idle, CELL-FACH, CELL-PCH and URA-PCH state, inter-frequency cell is defined as the cell of which the primary frequency is different from the user's current frequency. In CELL-DCH state, inter-frequency cell is defined as the cell of which the frequency to be measured in that cell is different from the operating frequency for single carrier operation or is different from the associated DPCH operating frequency for multi-carrier operation.

**Intra-frequency cell:** In idle, CELL-FACH, CELL-PCH and URA-PCH state, intra-frequency cell is defined as the cell of which the primary frequency is the same as the user's current frequency. In CELL-DCH state, intra-frequency cell is defined as the cell of which the frequency to be measured in that cell is the same as the operating frequency for single carrier operation or is the same as the associated DPCH operating frequency for multi-carrier operation.

NOTE 1: The RRC filtered mean power of a perfectly modulated CDMA signal is 0.246 dB lower than the mean power of the same signal.

NOTE 2: The roll-off factor  $\alpha$  is defined in section 6.8.1 of [1].

## 3.2 Abbreviations

For the purpose of the present document, the following abbreviations apply.

ACLR	Adjacent Channel Leakage power Ratio
ACS	Adjacent Channel Selectivity
AFC	Automatic Frequency Control
ATT	Attenuator
CW	Continuous wave (unmodulated signal)
DPCH	Dedicated physical channel
DPCH_Ec	Average energy per PN chip for DPCH
EVM	Error Vector Magnitude
FFS	For Further Study
Fuw	Frequency of unwanted signal. This is specified in bracket in terms of an absolute frequency(s) or frequency offset from the assigned channel frequency.
HYB	Hybrid
$I_{BTS}$	Interference signal power level at BTS in dBm, which is broadcasted on BCH
IMB	Integrated Mobile Broadcast
$I_{oac}$	The power spectral density of the adjacent frequency channel as measured at the UE antenna connector.
$I_{oc}$	The power spectral density (integrated in a noise bandwidth equal to the chip rate and normalized to the chip rate) of a band limited white noise source (simulating interference from cells which are not defined in a test procedure) as measured at the UE antenna connector.
$I_{or}$	The total transmit power spectral density (integrated in a bandwidth of $(1+\alpha)$ times the chip rate and normalized to the chip rate) of the downlink signal at the BS antenna connector
$\hat{I}_{or}$	The received power spectral density (integrated in a bandwidth of $(1+\alpha)$ times the chip rate and normalized to the chip rate) of the downlink signal as measured at the UE antenna connector
$I_{owc}$	Unwanted signal power level
OBW	Occupied Bandwidth
OCNS	Orthogonal Channel Noise Simulator, a mechanism used to simulate the users or control signals on the other orthogonal channels of a downlink.
PCDE	Peak Code Domain Error
PPM	Parts Per Million
PRBS	Pseudo Random Bit Sequence
RRC	Root-Raised Cosine

SCTD	Space Code Transmit Diversity
SIR	Signal to Interference ratio
SS	System Simulator
TBD	To Be Defined
TPC	Transmit Power Control
TS	Time Slot

### 3.3 Equations

For the purpose of the present document, the following additional equations apply:

$\frac{DPCH\_Ec}{I_{or}}$	The ratio of the average energy per PN chip of the DPCH to the total transmit power spectral density of the downlink at the BS antenna connector
$\frac{\sum DPCH\_Ec}{I_{or}}$	The ratio of the sum of DPCH_Ec for one service in case of multicode to the total transmit power spectral density of the downlink at the BS antenna connector

## 4 Frequency bands and channel arrangement

### 4.1 General

The information presented in this clause is based on the chip rates of 3,84 Mcps TDD Option, 1,28 Mcps TDD Option and 7.68 Mcps Option.

### 4.2 Frequency bands

UTRA/TDD is designed to operate in the following bands;

- a) 1 900 – 1 920 MHz: Uplink and downlink transmission  
2 010 – 2 025 MHz: Uplink and downlink transmission
- b) 1 850 – 1 910 MHz: Uplink and downlink transmission  
1 930 – 1 990 MHz: Uplink and downlink transmission
- c) 1 910 – 1 930 MHz: Uplink and downlink transmission
- d) 2 570 - 2 620 MHz: Uplink and downlink transmission
- e) 2300—2400 MHz: Uplink and downlink transmission
- f) 1880 - 1920 MHz: Uplink and downlink transmission

Deployment in existing or other frequency bands is not precluded.

### 4.3 TX–RX frequency separation

#### 4.3.1 3,84 Mcps TDD Option

No TX-RX frequency separation is required as Time Division Duplex (TDD) is employed. Each TDMA frame consists of 15 timeslots where each timeslot can be allocated to either transmit or receive.

The IMB option is only applicable for dedicated carrier operations in which all TDD slots of the radio frame are configured in the downlink direction

#### 4.3.2 1,28 Mcps TDD Option

No TX-RX frequency separation is required as Time Division Duplex (TDD) is employed. Each subframe consists of 7 main timeslots where all main timeslots (at least the first one) before the single switching point are allocated DL and all main timeslots (at least the last one) after the single switching point are allocated UL.

### 4.3.3 7,68 Mcps TDD Option

No TX-RX frequency separation is required as Time Division Duplex (TDD) is employed. Each TDMA frame consists of 15 timeslots where each timeslot can be allocated to either transmit or receive.

## 4.4 Channel arrangement

### 4.4.1 Channel spacing

#### 4.4.1.1 3,84 Mcps TDD Option

The nominal channel spacing is 5 MHz, but this can be adjusted to optimise performance in a particular deployment scenario.

#### 4.4.1.2 1,28 Mcps TDD Option

The nominal channel spacing is 1,6 MHz, but this can be adjusted to optimise performance in a particular deployment scenario.

#### 4.4.1.3 7,68 Mcps TDD Option

The nominal channel spacing is 10 MHz, but this can be adjusted to optimise performance in a particular deployment scenario.

### 4.4.2 Channel raster

The channel raster is 200 kHz, which means that the carrier frequency must be a multiple of 200 kHz.

### 4.4.3 Channel number

The carrier frequency is designated by the UTRA absolute radio frequency channel number (UARFCN). The value of the UARFCN in the IMT2000 band is defined as follows:

$N_t = 5 * F$	$0,0 \text{ MHz} \leq F \leq 3276,6 \text{ MHz}$	where F is the carrier frequency in MHz
---------------	--	---

### 4.4.4 UARFCN (3,84 Mcps TDD Option)

The following UARFCN range shall be supported for each band.

**Table 4.4.1: UTRA Absolute Radio Frequency Channel Number**

Frequency Band	Frequency Range	UARFCN Uplink and Downlink transmission
For operation in frequency band as defined in subclause 5.2 (a)	1900-1920 MHz 2010-2025 MHz	9512 to 9588 10062 to 10113
For operation in frequency band as defined in subclause 5.2 (b)	1850-1910 MHz 1930-1990 MHz	9262 to 9538 9662 to 9938
For operation in frequency band as defined in subclause 5.2 (c)	1910-1930 MHz	9562 to 9638

### 4.4.4A UARFCN (1.28 Mcps TDD Option)

The following UARFCN range shall be supported for each band.



**Table 4.4.1A: UTRA Absolute Radio Frequency Channel Number**

Frequency Band	Frequency Range	UARFCN Uplink and Downlink transmission
For operation in frequency band as defined in subclause 5.2 (a)	1900-1920 MHz 2010-2025 MHz	9504 to 9596 10054 to 10121
For operation in frequency band as defined in subclause 5.2 (b)	1850-1910 MHz 1930-1990 MHz	9254 to 9546 9654 to 9946
For operation in frequency band as defined in subclause 5.2 (c)	1910-1930 MHz	9554 to 9646
For operation in frequency band as defined in subclause 5.2 (d)	2570-2620 MHz	12854 to 13096
For operation in frequency band as defined in subclause 5.2 (e)	2300-2400 MHz	11504 to 11996
For operation in frequency band as defined in subclause 5.2 (f)	1880-1920 MHz	9404 to 9596

#### 4.4.5 UARFCN (7,68 Mcps TDD Option)

The following UARFCN range shall be supported for each band.

**Table 4.4.2: UTRA Absolute Radio Frequency Channel Number**

Frequency Band	Frequency Range	UARFCN Uplink and Downlink transmission	Additional UARFCN Uplink and Downlink transmission
For operation in frequency band as defined in subclause 4.2 (a)	1900-1920 MHz 2010-2025 MHz	9512 to 9588 10062 to 10113	-
For operation in frequency band as defined in subclause 4.2 (b)	1850-1910 MHz 1930-1990 MHz	9262 to 9538 9662 to 9938	-
For operation in frequency band as defined in subclause 4.2 (c)	1910-1930 MHz	9562 to 9638	-
For operation in frequency band as defined in subclause 4.2 (d)	2570-2620 MHz	12874 to 13076	-

## 5 Transmitter Characteristics

### 5.1 General

Transmitting performance test of the UE is implemented during communicating with the SS via air interface. The procedure is uses normal call protocol until the UE is communicating on traffic channel basically. (Refer to TS 34.108 [3] Common Test Environments for User Equipment (UE) Conformance Testing) On the traffic channel, the UE provides special function for testing that is called Logical Test Interface and the UE is tested using this function. (Refer to TS 34.109 [4] Logical Test Interface; Special conformance testing functions).

Unless detailed the transmitter characteristic are specified at the antenna connector of the UE. For UE with integral antenna only, a reference antenna with a gain of 0 dBi is assumed. Transmitter characteristics for UE(s) with multiple antennas/antenna connectors are for further study.

The UE antenna performance has a significant impact on system performance, and minimum requirements on the antenna efficiency are therefore intended to be included in future versions of the present document. It is recognized that different requirements and test methods are likely to be required for the different types of UE.

The common RF test conditions are defined in annex E, and each test conditions in this Clause should refer annex E. Individual test conditions are defined in the paragraph of each test.

## 5.2 User Equipment maximum output power

### 5.2.1 Definition and applicability

The nominal maximum output power and its tolerance are defined according to the Power Class of the UE.

The requirements in this test apply to all UTRA – TDD- UEs

Notes copied from TS 25.102 clause 6.2.1:

NOTE 1: For multi-code operation the nominal maximum output power will be reduced by the difference of peak to average ratio between single and multi-code transmission.

NOTE 2: The tolerance allowed for the nominal maximum power applies even at the multi-code transmission mode

NOTE 3: For UE using directive antennas for transmission, a class dependent limit will be placed on the maximum EIRP (Equivalent Isotropic Radiated Power).

### 5.2.2 Minimum Requirements

#### 5.2.2.1 3.84 Mcps TDD option

The error of the UE maximum output power shall not exceed the tolerance shown in tables 5.2.2 1.a and b for single and multi-code for 3.84Mcps TDD option.

**Table 5.2.2.1.a: Maximum Output Power single code**

Power Class	Nominal maximum output power	Tolerance
1	+30 dBm	+1dB/-3dB
2	+24 dBm	+1dB/-3dB
3	+21 dBm	+2dB/-2dB
4	+10 dBm	+4dB/-4dB

**Table 5.2.2.1.b: Maximum Output Power multi code**

Power Class	Nominal maximum output power	Tolerance
1	+27 dBm (note)	+1dB/-3dB
2	21 dBm (note)	+1dB/-3dB
3	18 dBm (note)	+2dB/-2dB
4	+7 dBm (note)	+4dB/-4dB
NOTE:	<p>These figures are not mentioned in 25.102. Instead there is a note, saying: "For multi-code operation the maximum output power will be reduced by the difference of peak to average ratio between single and multi-code transmission."</p> <p>The figures are calculated from maximum output power single code (table 5.2.2.1.a) and UL multicode reference measurement channel (12,2 kbit/s) (annex C.2.2.1 for the 3,84 TDD Option) containing two code signals with equal level.</p>	

The normative reference for this requirement is TS 25.102 [1] clause 6.2.1.

#### 5.2.2.2 1.28 Mcps TDD option

The error of the UE maximum output power shall not exceed the tolerance shown in tables 5.2.2 2.a and b for single and multi-code for 1.28Mcps TDD option.

**Table 5.2.2.2.a: Maximum Output Power single code**

Power Class	Nominal maximum output power	Tolerance
1	+33 dBm	+1dB/-3dB
2	+24 dBm	+1dB/-3dB
3	+21 dBm	+2dB/-2dB
4	+27 dBm	+1dB/-3dB

**Table 5.2.2.2.b: Maximum Output Power multi code**

Power Class	Nominal maximum output power	Tolerance
1	+30 dBm (note)	+1dB/-3dB
2	22 dBm (note)	+1dB/-3dB
3	18 dBm (note)	+2dB/-2dB
4	+24 dBm (note)	+1dB/-3dB

NOTE: These figures are not mentioned in 25.102. Instead there is a note, saying: "For multi-code operation the maximum output power will be reduced by the difference of peak to average ratio between single and multi-code transmission."  
The figures are calculated from maximum output power single code (table 5.2.2.a) and UL multicode reference measurement channel (12,2 kbit/s) (annex C.2.2.2 for the 1,28 Mcps TDD Option) containing two code signals with equal level.

The normative reference for this requirement is TS 25.102 [1] clause 6.2.1.

### 5.2.2.3 7.68 Mcps TDD option

The error of the UE maximum output power shall not exceed the tolerance shown in tables 5.2.2 1.a and b for single and multi-code for 7.68Mcps TDD option.

**Table 5.2.2.1.a: Maximum Output Power single code**

Power Class	Nominal maximum output power	Tolerance
1	+30 dBm	+1dB/-3dB
2	+24 dBm	+1dB/-3dB
3	+21 dBm	+2dB/-2dB
4	+10 dBm	+4dB/-4dB

**Table 5.2.2.1.b: Maximum Output Power multi code**

Power Class	Nominal maximum output power	Tolerance
1	+27 dBm (note)	+1dB/-3dB
2	21 dBm (note)	+1dB/-3dB
3	18 dBm (note)	+2dB/-2dB
4	+7 dBm (note)	+4dB/-4dB

NOTE: These figures are not mentioned in 25.102. Instead there is a note, saying: "For multi-code operation the maximum output power will be reduced by the difference of peak to average ratio between single and multi-code transmission."  
The figures are calculated from maximum output power single code (table 5.2.2.1.a) and UL multicode reference measurement channel (12,2 kbit/s) (annex C.2.2.3 for the 7.68 TDD Option) containing two code signals with equal level.

The normative reference for this requirement is TS 25.102 [1] clause 6.2.1.

## 5.2.3 Test purpose

For the following reasons:

Limit interference.

Verify that the maximum output power is achievable.

It is the purpose of the test to verify that the UE's maximum output power is within its tolerance limits under all environmental conditions.

## 5.2.4 Method of test

### 5.2.4.1 Initial conditions

Test environment: normal, TL/VL, TL/VH, TH/VL, TH/VH; see clauses G.2.1 and G.2.2.

Frequencies to be tested: low range, mid range, high range; see clause G.2.4.

- 1) Connect the SS to the UE antenna connector as shown in figure A.1.
- 2) Calls are set up according to the Generic call setup procedure using parameters as specified in tables 5.2.4.1.1a and b for the 3,84 Mcps TDD Option and in tables 5.2.4.1.2a and b for the 1,28 Mcps TDD Option, respectively.
- 3) Enter the UE into loopback test mode and start the loopback test.

#### 5.2.4.1.1 3,84 Mcps TDD Option

**Table 5.2.4.1.1a: Test parameters for Maximum Output Power single code (3,84 Mcps TDD Option)**

Parameter	Value/description
UL Reference measurement channel	12,2 kbps, according to annex C.2.1.1
Uplink Power Control	SS level and signalling values such that UE transmits maximum power.
Data content	real life (sufficient irregular)

**Table 5.2.4.1.1b: Test parameters for Maximum Output Power multicode (3,84 Mcps TDD Option)**

Parameter	Value/description
Reference measurement channel	Multicode 12,2 kbps, according to annex C.2.2.1
Uplink Power Control	SS level and signalling values such that UE transmits maximum power
Data content	real life (sufficient irregular)

#### 5.2.4.1.2 1,28 Mcps TDD Option

**Table 5.2.4.1.2a: Test parameters for Maximum Output Power single code (1,28 Mcps TDD Option)**

Parameter	Value/description
UL Reference measurement channel	12,2 kbps, according to annex C.2.1.2.
Uplink Power Control	SS level and signalling values such that UE transmits maximum power.
Data content	real life (sufficient irregular)

**Table 5.2.4.1.2b: Test parameters for Maximum Output Power multicode (1,28 Mcps TDD Option)**

Parameter	Value/description
Reference measurement channel	Multicode 12,2 kbps, according to annex C.2.2.2
Uplink Power Control	SS level and signalling values such that UE transmits maximum power
Data content	real life (sufficient irregular)

### 5.2.4.1.3 7,68 Mcps TDD Option

**Table 5.2.4.1.3a: Test parameters for Maximum Output Power single code (7,68 Mcps TDD Option)**

Parameter	Value/description
UL Reference measurement channel	12,2 kbps, according to annex C.2.1.3
Uplink Power Control	SS level and signalling values such that UE transmits maximum power.
Data content	real life (sufficient irregular)

**Table 5.2.4.1.3b: Test parameters for Maximum Output Power multicode (7,68 Mcps TDD Option)**

Parameter	Value/description
Reference measurement channel	Multicode 12,2 kbps, according to annex C.2.2.3
Uplink Power Control	SS level and signalling values such that UE transmits maximum power
Data content	real life (sufficient irregular)

### 5.2.4.2 Procedure

- 1) Measure the mean power of the UE output signal.
- 2) Run step 1) for RF channels Low / Mid / High.

## 5.2.5 Test Requirements

5.2.5.1 3,84 Mcps TDD Option The output power, measured in step 2) of clause 5.2.4.2, shall not exceed the prescribed tolerance in table 5.2.5 a and b.

**Table 5.2.5.1.a: Maximum Output Power single code**

Power Class	Nominal maximum output power	Tolerance
1	+30 dBm	+1,7 dB / -3,7 dB
2	+24 dBm	+1,7 dB / -3,7dB
3	+21 dBm	+2,7 dB / -2,7dB
4	+10 dBm	+4,7 dB / -4,7dB

**Table 5.2.5.1.b: Maximum Output Power multi code**

Power Class	Nominal maximum output power	Tolerance
1	27 dBm	+1,7 dB / -3,7 dB
2	21 dBm	+1,7dB / -3,7 dB
3	18 dBm	+2,7dB / -2,7 dB
4	7 dBm	+4,7 dB / -4,7 dB

NOTE 1: If the above Test Requirement differs from the Minimum Requirement then the Test Tolerance applied for this test is non-zero. The Test Tolerance for this test is defined in annex F clause F.2 and the explanation of how the Minimum Requirement has been relaxed by the Test Tolerance is given in annex F clause F.4.

NOTE 2: Concerning multicode transmission this test applies only for UE power classes 2 and 3. It is intended, that additional test requirements for UE power classes 1 and 4 in this case are part of a later version of the present document.

### 5.2.5.2 1.28 Mcps TDD Option

The output power, measured in step 2) of clause 5.2.4.2, shall not exceed the prescribed tolerance in table 5.2.5.2 a and b.

**Table 5.2.5.2.a: Maximum Output Power single code**

Power Class	Nominal maximum output power	Tolerance
1	+33dBm	+1,7 dB / -3,7 dB
2	+24 dBm	+1,7 dB / -3,7dB
3	+21 dBm	+2,7 dB / -2,7dB
4	+27 dBm	+1,7 dB / -3,7 dB

**Table 5.2.5.2.b: Maximum Output Power multi code**

Power Class	Nominal maximum output power	Tolerance
1	30 dBm	+1,7 dB / -3,7 dB
2	22 dBm	+1,7dB / -3,7 dB
3	18 dBm	+2,7dB / -2,7 dB
4	24 dBm	+1,7 dB / -3,7 dB

NOTE 1: If the above Test Requirement differs from the Minimum Requirement then the Test Tolerance applied for this test is non-zero. The Test Tolerance for this test is defined in annex F clause F.2 and the explanation of how the Minimum Requirement has been relaxed by the Test Tolerance is given in annex F clause F.4.

NOTE 2: Concerning multicode transmission this test applies only for UE power classes 2 and 3. It is intended, that additional test requirements for UE power classes 1 and 4 in this case are part of a later version of the present document.

### 5.2.5.3 7.68 Mcps TDD Option

The output power, measured in step 2) of clause 5.2.4.2, shall not exceed the prescribed tolerance in table 5.2.5.3 a and b.

**Table 5.2.5.3.a: Maximum Output Power single code**

Power Class	Nominal maximum output power	Tolerance
1	+33dBm	+1,7 dB / -3,7 dB
2	+24 dBm	+1,7 dB / -3,7dB
3	+21 dBm	+2,7 dB / -2,7dB
4	+27 dBm	+1,7 dB / -3,7 dB

**Table 5.2.5.3.b: Maximum Output Power multi code**

Power Class	Nominal maximum output power	Tolerance
1	30 dBm	+1,7 dB / -3,7 dB
2	21 dBm	+1,7dB / -3,7 dB
3	18 dBm	+2,7dB / -2,7 dB
4	24 dBm	+1,7 dB / -3,7 dB

NOTE 1: If the above Test Requirement differs from the Minimum Requirement then the Test Tolerance applied for this test is non-zero. The Test Tolerance for this test is defined in annex F clause F.2 and the explanation of how the Minimum Requirement has been relaxed by the Test Tolerance is given in annex F clause F.4.

NOTE 2: Concerning multicode transmission this test applies only for UE power classes 2 and 3. It is intended, that additional test requirements for UE power classes 1 and 4 in this case are part of a later version of the present document.

## 5.2A User Equipment maximum output power with E-DCH

### 5.2A.1 Definition and applicability

The maximum output power with E-DCH and its tolerance are defined according to the UE Maximum Power Reduction (MPR) for the nominal maximum output power.

The requirements and this test apply for Release 7 and later releases to all types of UTRA for the TDD UE that support HSUPA.

### 5.2A.2 Minimum Requirements

#### 5.2A.2.1 3.84 Mcps TDD option

[FFS]

#### 5.2A.2.2 1.28 Mcps TDD option

The UE Maximum Power Reduction (MPR) for the nominal maximum output power shall be within the value and tolerance specified in table 5.2A.2.2.a

**Table 5.2A.2.2.a: UE maximum output power with E-DCH**

UE transmit channel configuration	CM (dB)	MPR (dB)
E-DCH and E-UCCH	$0 \leq CM \leq 1.5$	CM

Where Cubic Metric (CM) is based on the UE transmit channel configuration and is given by

$$CM = [20 * \log_{10} ((v_{\text{norm}}^3)_{\text{rms}}) - 20 * \log_{10} ((v_{\text{norm\_ref}}^3)_{\text{rms}})] / k$$

Where

- $v_{\text{norm}}$  is the normalized voltage waveform of the input signal
- $v_{\text{norm\_ref}}$  is the normalized voltage waveform of the reference signal (12.2 kbps AMR Speech)
- $k$  is 1.94
- $20 * \log_{10} ((v_{\text{norm\_ref}}^3)_{\text{rms}}) = 1.22$  dB

The normative reference for this requirement is TS 25.102 clause 6.2.2.

#### 5.2A.2.3 7.68 Mcps TDD option

[FFS]

### 5.2A.3 Test purpose

To verify that the error of the UE maximum output power with E-DCH does not exceed the range prescribed by the maximum output power and tolerance in table 5.2A.5.2.a.

An excess maximum output power may interfere with other channels or other systems. A small maximum output power decreases the coverage area.

## 5.2A.4 Method of test

### 5.2A.4.1 Initial conditions

Test environment: normal, TL/VL, TL/VH, TH/VL, TH/VH; see clauses G.2.1 and G.2.2.

Frequencies to be tested: low range, mid range, high range; see clause G.2.4.

- 1) Connect the SS (node B emulator) to the UE antenna connector as shown in figure A.1.
- 2) The Fixed Reference Channels (FRC 3, 16QAM) are specified C.6.1.2.3.
- 3) An E-DCH call is set up according to TS 34.108 [3] 7.3.9
- 4) Enter the UE into loopback test mode 1 looping back both the 12.2kbps RMC and HSUPA to E-DCH, and start the loopback test.

See TS 34.109 [4] clauses 5.3.2.3 and 5.3.2.6 for details regarding loopback test mode for HSDPA and E-DCH.

#### 5.2A.4.1.1 3,84 Mcps TDD Option

[FFS]

#### 5.2A.4.1.2 1,28 Mcps TDD Option

**Table 5.2A.4.1.2a: Test parameters for Maximum Output Power single code (1,28 Mcps TDD Option)**

Parameter	Value/description
UL Reference measurement channel	12,2 kbps, according to annex C.2.1.2.
Uplink Power Control	SS level and signalling values such that UE transmits maximum power.
Data content	real life (sufficient irregular)

**Table 5.2A.4.1.2b: Test parameters for Maximum Output Power multicode (1,28 Mcps TDD Option)**

Parameter	Value/description
Reference measurement channel	Multicode 12,2 kbps, according to annex C.2.2.2
Uplink Power Control	SS level and signalling values such that UE transmits maximum power
Data content	real life (sufficient irregular)

#### 5.2.4.1.3 7,68 Mcps TDD Option

[FFS]

### 5.2A.4.2 Procedure

- 1) The SS starts transmitting and the UE loops the received data back on E-DCH.
- 2) Measure the mean power of the UE. The mean power shall be averaged over at least one timeslot.



## 5.2A.5 Test requirements

### 5.2A.5.1 3.84 Mcps TDD Option

[FFS]

### 5.2A.5.2 1.28 Mcps TDD Option

The maximum output power with E-DCH, derived in step 7), shall not exceed the range prescribed by the maximum output power and tolerance in table 5.2A.5.2.a.

**Table 5.2A.5.2.a: Maximum Output Powers with E-DCH for test**

UE transmit channel configuration	Power Class1	
	Nominal maximum output power	Tolerance
E-DCH and E-UCCH	FFS	FFS

UE transmit channel configuration	Power Class2	
	Nominal maximum output power	Tolerance
E-DCH and E-UCCH	22.5dBm	+3.2dB / -5.2dB

UE transmit channel configuration	Power Class3	
	Nominal maximum output power	Tolerance
E-DCH and E-UCCH	FFS	FFS

UE transmit channel configuration	Power Class4	
	Nominal maximum output power	Tolerance
E-DCH and E-UCCH	FFS	FFS

NOTE 1: If the above Test Requirement differs from the Minimum Requirement then the Test Tolerance applied for this test is non-zero. The Test Tolerance for this test is defined in annex F clause F.2 and the explanation of how the Minimum Requirement has been relaxed by the Test Tolerance is given in annex F clause F.4.

NOTE2: The test procedure will result in a power slightly below the maximum, and therefore the lower limits in Table 5.2A.5.2.a are made lower by 1.5 dB.

### 5.2A.5.3 7.68 Mcps TDD Option

[FFS]

## 5.2B User Equipment maximum output power with HS-SICH and DPCH

### 5.2B.1 Definition and applicability

The maximum output power with HS-SICH and DPCH and its tolerance are defined according to the UE Maximum Power Reduction (MPR) for the nominal maximum output power.

The requirements and this test apply for Release 5 and later releases to all types of UTRA for the TDD UE that support HSDPA.

## 5.2B.2 Minimum Requirements

### 5.2B.2.1 3.84 Mcps TDD option

[FFS]

### 5.2B.2.2 1.28 Mcps TDD option

The UE Maximum Power Reduction (MPR) for the nominal maximum output power shall be within the value and tolerance specified in table 5.2B.2.2.b

**Table 5.2B.2.2.b: UE maximum output power with HS-SICH and DPCH**

UE transmit channel configuration	CM (dB)	MPR (dB)
HS-SICH and DPCH	$0 \leq \text{CM} \leq 2.5$	CM

Where Cubic Metric (CM) is based on the UE transmit channel configuration and is given by

$$\text{CM} = [20 * \log_{10} ((v_{\text{norm}})^3)_{\text{rms}} - 20 * \log_{10} ((v_{\text{norm\_ref}})^3)_{\text{rms}}] / k$$

Where

- $v_{\text{norm}}$  is the normalized voltage waveform of the input signal
- $v_{\text{norm\_ref}}$  is the normalized voltage waveform of the reference signal (12.2 kbps AMR Speech)
- $k$  is 1.68
- $20 * \log_{10} ((v_{\text{norm\_ref}})^3)_{\text{rms}} = 1.22$  dB

The normative reference for this requirement is TS 25.102 clause 6.2.2.

### 5.2B.2.3 7.68 Mcps TDD option

[FFS]

## 5.2B.3 Test purpose

To verify that the error of the UE maximum output power with HS-SICH and DPCH does not exceed the range prescribed by the maximum output power and tolerance in table 5.2B.2.2b.

An excess maximum output power may interfere with other channels or other systems. A small maximum output power decreases the coverage area.

## 5.2B.4 Method of test

### 5.2B.4.1 Initial conditions

Test environment: normal, TL/VL, TL/VH, TH/VL, TH/VH; see clauses G.2.1 and G.2.2.

Frequencies to be tested: low range, mid range, high range; see clause G.2.4.

- 1) Connect the SS (node B emulator) to the UE antenna connector as shown in figure A.1.
- 2) The Reference Measurement Channels are specified C.2.2.2a.
- 3) An HSDPA call is set up according to TS 34.108 [3] 7.3.6
- 4) Enter the UE into loopback test mode in the presence of HSDPA and start the loopback test.

See TS 34.108 [3] and TS 34.109 [4] for details regarding loopback test mode for HSDPA

### 5.2B.4.2 Procedure

- 1) The SS starts transmitting HSDPA data.

- 2) Set SS-level and signalling values such that the power level of both DPCH and HS-SICH are between 12.5-14dBm
- 3) Send power control bits continuously to give TPC\_cmd = +1 command to DPCH and HS-SICH simultaneously.
- 4) Measure the mean power of the UE. The mean power shall be averaged over at least one timeslot.

## 5.2B.5 Test requirements

### 5.2B.5.1 3.84 Mcps TDD Option

[FFS]

### 5.2B.5.2 1.28 Mcps TDD Option

The maximum output power with HS-SICH and DPCH, derived in step 7), shall not exceed the range prescribed by the maximum output power and tolerance in table 5.2B.5.2b.

**Table 5.2A.5.2b.: Maximum Output Powers with HS-SICH and DPCH for test**

UE transmit channel configuration	Power Class1	
	Nominal maximum output power	Tolerance
For some combinations of; HS-SICH and DPCH	FFS	FFS

UE transmit channel configuration	Power Class2	
	Nominal maximum output power	Tolerance
For some combinations of; HS-SICH and DPCH	21.5dBm	+4.2 dB / -3.7dB

UE transmit channel configuration	Power Class3	
	Nominal maximum output power	Tolerance
For some combinations of; HS-SICH and DPCH	FFS	FFS

UE transmit channel configuration	Power Class4	
	Nominal maximum output power	Tolerance
For some combinations of; HS-SICH and DPCH	FFS	FFS

NOTE 1: If the above Test Requirement differs from the Minimum Requirement then the Test Tolerance applied for this test is non-zero. The Test Tolerance for this test is defined in annex F clause F.2 and the explanation of how the Minimum Requirement has been relaxed by the Test Tolerance is given in annex F clause F.4.

### 5.2B.5.3 7.68 Mcps TDD Option

[FFS]

## 5.3 UE frequency stability

### 5.3.1 Definition and applicability

The frequency stability is the difference of the modulated carrier frequency between the RF transmission from the UE and the RF transmission from the BS. The UE shall use the same frequency source for both RF frequency generation and chip clocking.

The requirements of this test apply to all types of UTRA- UE.

## 5.3.2 Minimum Requirements

The UE frequency stability, observed over a period of one timeslot, shall be within  $\pm 0,1$  ppm compared to signals received from the BS.

The normative reference for this requirement is TS 25.102 [1] clause 6.3.

## 5.3.3 Test purpose

Reliable frequency stability of the UE's transmitter in certain tolerance limits is prerequisite for connectivity.

This test stresses the ability of the UE's receiver to derive correct frequency information from the received signal for the transmitter.

## 5.3.4 Method of test

### 5.3.4.1 Initial conditions

Test environment: normal, TL/VL, TL/VH, TH/VL, TH/VH, vibration; see clauses G.2.1, G.2.2 and G.2.3.

Frequencies to be tested: low range, mid range, high range; see clause G.2.4.

#### 5.3.4.1.1 3,84 Mcps TDD Option

- 1) Connect the SS to the UE antenna connector as shown in figure A.1.
- 2) A call is set up according to the Generic call setup procedure using parameters as specified in table 5.3.4.1.1.
- 3) Enter the UE into loopback test mode and start the loopback test.

**Table 5.3.4.1.1: Test parameters for Frequency Stability (3,84 Mcps TDD Option)**

Parameter	Value/description
SS level (Ior)	-105 dBm / 3,84 MHz (reference sensitivity)
UL reference measurement channel	12,2 kbps according to annex C.2.1.1.
Data content	real life (sufficient irregular)

#### 5.3.4.1.2 1,28 Mcps TDD Option

- 1) Connect the SS to the UE antenna connector as shown in figure A.1.
- 2) A call is set up according to the Generic call setup procedure using parameters as specified in table 5.3.4.1.2.
- 3) Enter the UE into loopback test mode and start the loopback test.

**Table 5.3.4.1.2: Test parameters for Frequency Stability (1,28 Mcps TDD Option)**

Parameter	Value/description
SS level (Ior)	-108 dBm / 1,28 MHz (reference sensitivity)
UL reference measurement channel	12,2 kbps according to annex C.2.1.2
Data content	real life (sufficient irregular)

#### 5.3.4.1.3 7,68 Mcps TDD Option

- 1) Connect the SS to the UE antenna connector as shown in figure A.1.
- 2) A call is set up according to the Generic call setup procedure using parameters as specified in table 5.3.4.1.3.

- 3) Enter the UE into loopback test mode and start the loopback test.

**Table 5.3.4.1.3: Test parameters for Frequency Stability (7,68 Mcps TDD Option)**

Parameter	Value/description
SS level (Ior)	-102 dBm / 7,68 MHz (reference sensitivity)
UL reference measurement channel	12,2 kbps according to annex C.2.1.3.
Data content	real life (sufficient irregular)

### 5.3.4.2 Procedure

- 1) Measure the frequency error  $\Delta f$  across the TS according to annex B.
- 2) Repeat step 1) for 200 bursts (time slots).
- 3) Run Step 1) and 2) for RF channels Low /Mid/ High.

### 5.3.5 Test Requirements

For all measured bursts (time slots), the frequency error, derived in clause 5.3.4.2, shall not exceed  $\pm(0,1 \text{ ppm} + 10 \text{ Hz})$ .

NOTE: If the above Test Requirement differs from the Minimum Requirement then the Test Tolerance applied for this test is non-zero. The Test Tolerance for this test is defined in annex F clause F.2 and the explanation of how the Minimum Requirement has been relaxed by the Test Tolerance is given in annex F clause F.4

## 5.4 Output Power Dynamics

Power control is used to limit the interference level.

### 5.4.1 Uplink power control

Uplink power control is the ability of the UE transmitter to sets its output power in accordance with measured downlink path loss, values determined by higher layer signalling and path loss weighting parameter  $\alpha$  as defined in TS 25.331 [9]. The output power is defined as the RRC filtered mean power of the transmit timeslot.

#### 5.4.1.1 Initial accuracy (3,84 Mcps TDD Option)

##### 5.4.1.1.1 Definition and applicability

Initial Uplink power control is the ability of the UE transmitter to sets its output power in accordance with measured downlink path loss, and signalling values:  $I_{BTS}$  and Constant value, received from the BCH and applicable for the PRACH.

The requirements and this test apply to all types of UTRA - UEs.

##### 5.4.1.1.2 Minimum requirements

The UE power control, initial accuracy, is given in table 5.4.1.1.2.

**Table 5.4.1.1.2: Initial uplink power control tolerance (3,84 Mcps TDD Option)**

Normal conditions	$\pm 9 \text{ dB}$
Extreme conditions	$\pm 12 \text{ dB}$

The reference for this requirement is TS 25.102 [1] clause 6.4.1.1.1.

##### 5.4.1.1.3 Test purpose

The power of the received signal at the UE and the BCH information control the power of the transmitted UE signal with the target to transmit at lowest power, acceptable for proper communication.

The test stresses the ability of the receiver to measure the received power over the receiver dynamic range and to derive from this correct transmitter-power.

#### 5.4.1.1.4 Method of test

##### 5.4.1.1.4.1 Initial conditions

Test environment: normal, TL/VL, TL/VH, TH/VL, TH/VH; see clauses G.2.1 and G.2.2.

Frequencies to be tested: low range, mid range, high range; see clause G.2.4.

Connect the SS to the MS antenna connector as shown in figure A.1.

A call is set up according to the generic call setup procedure [3] using parameters as specified in table 5.4.1.1.4. The RACH procedure within the call setup is used for the test.

**Table 5.4.1.1.4: Test parameters for uplink Power Control (3,84 Mcps TDD Option)**

	<b>RX-Upper dynamic end</b>	<b>RX-middle</b>	<b>RX-Sensitivity level</b>
SS transmit power	-25 dBm/3,84 MHz	-65 dBm/3,84 MHz	-105 dBm/3,84 MHz
Broadcasted transmit-power PCCPCH	35 dBm	35 dBm	24 dBm
Simulated path loss = Broadcasted TX – SS TX Power	60 dB	100 dB	129 dB
I <sub>BTS</sub> (UL interference)	-75 dBm	-100 dBm	-110 dBm
Constant value	-10 dB	-10 dB	-10 dB
Nominal expected UE TX power	-25 dBm	-10 dBm	+9 dBm (note 2)
NOTE 1: While the SS transmit power shall cover the UE receiver input dynamic range, the logical parameters: broadcasted transmit power, I <sub>BTS</sub> , and RACH constant value are chosen to achieve a UE TX power, located within the TX output power dynamic range of a class 3 UE.			
NOTE 2: Nominal TX output power 9 dBm allows to check the uplink power control algorithm within the entire tolerance range (9 dBm +-12 dB: 9 dBm +12 dB =21 dBm = max power class 3).			

##### 5.4.1.1.4.2 Procedure

- 1) Set the SS transmit power according to table 5.4.1.1.4.
- 2) Measure the RACH output power of the UE according to annex B.
- 3) Repeat the test for all SS transmit powers and parameters in table 5.4.1.1.4.

#### 5.4.1.1.5 Test requirements

The deviation with respect to the nominal expected UE TX power (table 5.4.1.1.2), derived in step 2, shall not exceed the prescribed tolerance in table 5.4.1.1.5.

**Table 5.4.1.1.5: Test parameters for uplink Power Control**

Expected UE TX power, normal conditions	-25 dBm ±10 dB	-10 dBm±10 dB	+9 dBm ±10 dB
Expected UE TX power, extreme conditions	-25 dBm ±13 dB	-10 dBm±13 dB	+9 dBm ±13 dB

NOTE: If the above Test Requirement differs from the Minimum Requirement then the Test Tolerance applied for this test is non-zero. The Test Tolerance for this test is defined in annex F clause F.2 and the explanation of how the Minimum Requirement has been relaxed by the Test Tolerance is given in annex F clause F.4.

## 5.4.1.2 Differential accuracy, controlled input (3,84 Mcps TDD Option)

### 5.4.1.2.1 Definition and applicability

Uplink power control, differential accuracy, is the ability of the UE transmitter to sets its output power in accordance with measured downlink path loss, and the signalling values:  $I_{BTS}$ ,  $SIR_{Target}$ , Constant Value, received from higher layers and applicable for the DPCH.

Specifically, the uplink power control, differential accuracy, controlled input, is defined as the error in the UE transmitter power step as a result of a step in  $SIR_{TARGET}$ ,  $I_{BTS}$  or DPCH Constant Value when the path loss weighting parameter  $\alpha=0$ .

The requirements of this test apply to all types of UTRA -UE.

### 5.4.1.2.2 Minimum requirements

The step in  $SIR_{TARGET}$  shall be rounded to the closest integer dB value. The power control error resulting from a change in  $SIR_{TARGET}$ ,  $I_{BTS}$  or DPCH Constant Value shall not exceed the values in table 5.4.1.2.2.

**Table 5.4.1.2.2: Transmitter power step tolerance as a result of control power step (3,84 Mcps TDD Option)**

$\Delta SIR_{TARGET}$ [dB]	Transmitter power step tolerance [dB]
$\Delta SIR_{TARGET} \leq 1$	$\pm 0,5$
$1 < \Delta SIR_{TARGET} \leq 2$	$\pm 1$
$2 < \Delta SIR_{TARGET} \leq 3$	$\pm 1,5$
$3 < \Delta SIR_{TARGET} \leq 10$	$\pm 2$
$10 < \Delta SIR_{TARGET} \leq 20$	$\pm 4$
$20 < \Delta SIR_{TARGET} \leq 30$	$\pm 6$
$30 < \Delta SIR_{TARGET}$	$\pm 9$ (note)
NOTE: Value is given for normal conditions. For extreme conditions value is $\pm 12$ .	

The reference for this requirement is TS 25.102 [1] clause 6.4.1.1.2.

### 5.4.1.2.3 Test purpose

It is verified if the UE sets correct uplink power steps in response to steps in the signalling value  $SIR_{Target}$  and DPCH Constant Value, signalled via the downlink to the UE, under the following conditions: keeping the other signalling parameters constant and deactivating any influence due to varying pathloss.

### 5.4.1.2.4 Method of test

#### 5.4.1.2.4.1 Initial conditions

Test environment: normal; see clauses G.2.1 and G.2.2.

Frequencies to be tested: mid range; see clause G.2.4.

- 1) Connect the SS to the MS antenna connector as shown in figure A.1.
- 2) A call is set up according to the generic call setup procedure using parameters as specified in table 5.4.1.2.4.

**Table 5.4.1.2.4 : Test parameters for Uplink Power Control, Differential Accuracy, Controlled Input (3,84 Mcps TDD Option)**

Parameter	Value/description
UL reference measurement channel	12,2 kbps according to annex C clause C.2.1.1
BS Transmit to UE Transmit delay	7 TSS--> $\alpha=0$
SSTransmit power	-65 dBm
Reference transmit power broadcast on BCH	35 dBm
IBTS	-100
Constant value	-10
Data content	real life (sufficient irregular)

#### 5.4.1.2.4.2 Procedure

Using a combination of  $SIR_{Target}$  and DPCH constant value signaled in the downlink, cover the UE-transmitter dynamic range by commanding the UEs power with the signalling value  $SIR_{Target}$  in a step resolution (positive and negative direction) of:

- |                  |                                       |
|------------------|---------------------------------------|
| 1 dB             | approx. 68 steps up and 68 steps down |
| 2 dB             | approx. 34 steps up and 34 steps down |
| 3 dB             | approx. 22 steps up and 22 steps down |
| 10 dB            | approx. 7 steps up and 7 steps down   |
| 20 dB            | approx. 3 steps up and 3 steps down   |
| 30 dB            | approx. 2 step up and 2 step down     |
| maximum stepsize | 1 step up and 1 step down             |

Measure the power according to annex B.

#### 5.4.1.2.5 Test requirements

For the UE output power laying between

Max Power minus tolerance and Min Power

the step response shall not exceed the prescribed tolerance in table 5.4.1.2.5.

**Table 5.4.1.2.5: Transmitter power step tolerance as a result of control power step**

$\Delta SIR_{TARGET}$ [dB]	Transmitter power step tolerance [dB]
$\Delta SIR_{TARGET} \leq 1$	$\pm 0,6$
$1 < \Delta SIR_{TARGET} \leq 2$	$\pm 1,15$
$2 < \Delta SIR_{TARGET} \leq 3$	$\pm 1,7$
$3 < \Delta SIR_{TARGET} \leq 10$	$\pm 2,5$
$10 < \Delta SIR_{TARGET} \leq 20$	$\pm 4,7$
$20 < \Delta SIR_{TARGET} \leq 30$	$\pm 6,7$
$30 < \Delta SIR_{TARGET}$	$\pm 10$

NOTE: If the above Test Requirement differs from the Minimum Requirement then the Test Tolerance applied for this test is non-zero. The Test Tolerance for this test is defined in annex F clause F.2 and the explanation of how the Minimum Requirement has been relaxed by the Test Tolerance is given in annex F clause F.4.



### 5.4.1.2A Differential accuracy, controlled input

This is not tested.

### 5.4.1.3 Open loop power control (1,28 Mcps TDD Option)

#### 5.4.1.3.1 Definition and applicability

Open loop power control is the ability of the UE transmitter to sets its output power to a specific value. The open loop power control tolerance is given in table 5.4.1.3.2.

The requirements and this test apply to all types of 1.28 Mcps TDD UE.

#### 5.4.1.3.2 Minimum requirements

The UE open loop power is defined as the average power in a timeslot or ON power duration, whichever is available, and they are measured with a filter that has a Root-Raised Cosine (RRC) filter response with a roll off  $\alpha = 0.22$  and a bandwidth equal to the chip rate of 1,28 Mcps. The open loop power control tolerance is given in table 5.4.1.3.2.

**Table 5.4.1.3.2: Open loop power control tolerance (1,28 Mcps TDD Option)**

Normal conditions	$\pm 9$ dB
Extreme conditions	$\pm 12$ dB

The reference for this requirement is TS 25.102 [1] clause 6.4.1.2.1.1.

#### 5.4.1.3.3 Test purpose

The power of the received signal and the BCCH information control the power of the transmitted signal with the target to transmit at lowest power acceptable for proper communication.

The test stresses the ability of the receiver to measure the received power correctly over the receiver dynamic range.

The test purpose is to verify that the UE open loop power control tolerance does not exceed the described value shown in table 5.4.1.3.2.

An excess error of the open loop power control decreases the system capacity.

#### 5.4.1.3.4 Method of test

##### 5.4.1.3.4.1 Initial conditions

Test environment: normal, TL/VL, TL/VH, TH/VL, TH/VH; see clauses G.2.1 and G.2.2.

Frequencies to be tested: low range, mid range, high range; see clause G.2.4.

- 1) Connect the SS to the UE antenna connector as shown in figure A.1.
- 2) A call is set up according to the Generic call setup procedure, and RF parameters are set up according to table 5.4.1.3.4a. The transmit power level by a UE on the UpPTS is measured. The network signals on BCH a power increment that is applied only for the access procedure. At each new transmission of a UpPTS burst during the access procedure, the transmit power level can be increased by this power increment. According to the test purpose this power increment is set to zero.

See TS 34.108 [3] for details regarding generic call setup procedure.

**Table 5.4.1.3.4a: Test parameters for Open Loop Power Control (UE) (1,28 Mcps TDD Option)**

Parameter	Level / Status	Unit
$\hat{I}_{or}$	See table 5.4.1.3.4b	dBm / 1,28 MHz

**Table 5.4.1.3.4b: Test parameters for Open Loop Power Control (SS) (1,28 Mcps TDD Option)<sup>1)</sup>**

Parameter	RX Upper dynamic end	RX-middle	RX-Sensitivity level
SS transmit power $\hat{I}_{or}$	-25 dBm / 1,28 MHz	- 66 dBm / 1,28 MHz	- 108 dBm / 1,28 MHz <sup>3)</sup>
broadcasted Primary CCPCCH transmit power on BCH	+35 dBm	+24 dBm	+11 dBm
Simulated path loss = broadcasted TX – SS TX power	+60 dB	+90 dB	+119 dB
PRXUpPCHdes	-85 dBm	-100 dBm	-110 dBm
$P_{w_{ramp}}$ (Power Ramping Step)	0 dB	0 dB	0 dB
I (Max SYNC_UL Transmissions)	1	1	1
Expected nominal UE TX power <sup>5)</sup>	-25 dBm	-10 dBm	+9 dBm <sup>2)</sup>

NOTE 1: While the SS transmit power shall cover the receiver input dynamic range, the logical parameters: broadcasted TX power, Desired UpPCH RX power at the BS receiver and Power Ramp step are chosen to achieve a UE TX power, located within the TX output power dynamic range of a class 3 UE.

NOTE 2: Nominal TX output power 9 dBm allows to check the open loop power algorithm within the entire tolerance range (9 dBm  $\pm$  12 dB; 9 dBm + 12 dB = 21 dBm = max power class 3)

NOTE 3: The reference for this requirement is TS 25.102 [1] clause 7.3.1.2.

NOTE 4: This test applies only for max UE power classes 3. It is intended, that additional test requirements for UE power class 4 are part of a later release.

NOTE 5: The Expected nominal UE TX power is calculated by using the equation in the clause 8.5.7 Open Loop Power Control of [9]

#### 5.4.1.3.4.2 Procedure

- 1) Set the TX output level of the SS to obtain  $\hat{I}_{or}$  at the UE antenna connector.  $\hat{I}_{or}$  shall be according to table 5.4.1.3.4b (-25 dBm / 1,28 MHz).
- 2) Measure the UpPCH TX mean power of UE.
- 3) Repeat the above measurement for all SS levels in table 5.4.1.3.4b.

#### 5.4.1.3.5 Test requirements

The measured UE TX power in step 2), shall not exceed the prescribed tolerance given in table 5.4.1.3.5.

**Table 5.4.1.3.5: Test parameters for open loop power control (1,28 Mcps TDD Option)**

Expected UE TX power, normal conditions	-25 dBm $\pm$ 10 dB	-10 dBm $\pm$ 10 dB	+9 dBm $\pm$ 10 dB
Expected UE TX power, extreme conditions	-25 dBm $\pm$ 13 dB	-10 dBm $\pm$ 13 dB	+9 dBm $\pm$ 13 dB

NOTE: If the above Test Requirement differs from the Minimum Requirement then the Test Tolerance applied for this test is non-zero. The Test Tolerance for this test is defined in annex F clause F.2 and the explanation of how the Minimum Requirement has been relaxed by the Test Tolerance is given in annex F clause F.4.

#### 5.4.1.4 Closed loop power control (1,28 Mcps TDD Option)

##### 5.4.1.4.1 Definition and applicability

Closed loop power control in the Uplink is the ability of the UE transmitter to adjust its output power in accordance with one or more TPC commands received in the downlink.

The power control step is the change in the UE transmitter output power in response to a single TPC command, TPC\_cmd, arrived at the UE.

The requirements and this test apply to all types of 1.28 Mcps TDD UE.

##### 5.4.1.4.2 Minimum requirements

The UE transmitter shall have the capability of changing the output power with a step size of 1, 2 and 3 dB according to the value of  $\Delta_{\text{TPC}}$  in the slot immediately after the TPC\_cmd can be arrived.

- a) The transmitter output power step due to closed loop power control shall be within the range shown in table 5.4.1.4.2a.
- b) The transmitter average output power step due to closed loop power control shall be within the range shown in table 5.4.1.4.2b. Here a TPC\_cmd group is a set of TPC\_cmd values derived from a corresponding sequence of TPC commands of the same duration.

The closed loop power is defined as the relative power differences between RRC filtered mean power of original (reference) timeslot and RRC filtered mean power of the target timeslot without transient duration.

**Table 5.4.1.4.2a: Transmitter power control range**

TPC_cmd	Transmitter power control range					
	1 dB step size		2 dB step size		3 dB step size	
	Lower	Upper	Lower	Upper	Lower	Upper
Up	+0,5 dB	+1,5 dB	+1 dB	+3 dB	+1,5 dB	+4,5 dB
Down	-0,5 dB	-1,5 dB	-1 dB	-3 dB	-1,5 dB	-4,5 dB

**Table 5.4.1.4.2b: Transmitter average power control range**

TPC_cmd group	Transmitter power control range after 10 equal TPC_cmd groups					
	1 dB step size		2 dB step size		3 dB step size	
	Lower	Upper	Lower	Upper	Lower	Upper
Up	+8 dB	+12 dB	+16 dB	+24 dB	+24 dB	+36 dB
Down	-8 dB	-12 dB	-16 dB	-24 dB	-24 dB	-36 dB

##### 5.4.1.4.3 Test purpose

The purpose of this test is

- to verify that the UE inner loop power control size and response is meet to the described value shown in clause 5.4.1.4.2; and
- to verify that the TPC\_cmd is correctly derived from received TPC commands.

##### 5.4.1.4.4 Method of test

###### 5.4.1.4.4.1 Initial conditions

Test environment: normal; see clauses G.2.1 and G.2.2.

Frequencies to be tested: mid range; see clause G.2.4.

- 1) Connect the SS to the UE antenna connector as shown in figure A.1.
- 2) A call is set up according to the Generic call setup procedure.

- 3) Enter the UE into loopback test mode and start the loopback test.

See TS 34.108 [3] and TS 34.109 [4] for details regarding generic call setup procedure and loopback test.

#### 5.4.1.4.4.2 Procedure

- 1) Before proceeding with paragraph (2) (Step A) below, set the output power of the UE, measured at the UE antenna connector, to be in the range  $-10 \pm 9$  dBm. This may be achieved by setting the downlink signal ( $\hat{I}_{or}$ ) to yield an appropriate open loop output power and/or by generating suitable downlink TPC commands from the SS.
- 2) Step A: Configure the uplink channel to set the TPC step size to 1 dB. When the Configuration is complete, transmit a sequence of TPC commands with the value 1 until the UE output power is above the maximum power threshold.
- 3) Step B: Transmit a sequence of 68 (note) TPC commands with the value 0.
- 4) Step C: Transmit a sequence of 68 (note) TPC commands with the value 1.
- 5) Step D: Reconfigure the uplink channel to set the TPC step size to 2 dB. When the reconfiguration is complete, transmit a sequence of TPC commands with the value 1 until the UE output power is above the maximum power threshold. Transmit a sequence of 34 (note) TPC commands with the value 0.
- 6) Step E: Transmit a sequence of 34 (note) TPC commands with the value 1.
- 7) Step F: Reconfigure the uplink channel to set the TPC step size to 3 dB. When the reconfiguration is complete, transmit a sequence of TPC commands with the value 1 until the UE output power is above the maximum power threshold. Transmit a sequence of 22 (note) TPC commands with the value 0.
- 8) Step G: Transmit a sequence of 22 (note) TPC commands with the value 1.

NOTE: These numbers of TPC commands are given as examples. The actual number of TPC commands transmitted in these steps shall be sufficient to ensure that the UE reaches the relevant maximum or minimum power threshold.

#### 5.4.1.4.5 Test requirements

- a) During Step B, the difference in mean output power between adjacent slots shall be within the prescribed range given in table 5.4.1.4.2a for a TPC\_cmd of  $-1$  and step size of 1 dB, until the output power reaches (Minimum power threshold  $+0,5$  dB).
- b) During Step B, the change in mean output power over 10 consecutive slots shall be within the prescribed range for a TPC\_cmd group of  $-1$ , and step size of 1 dB as given in table 5.4.1.4.2b, until the output power reaches (Minimum power threshold  $+0,5$  dB).
- c) During Step C, the difference in mean output power between adjacent slots shall be within the prescribed range given in table 5.4.1.4.2a for a TPC\_cmd of  $+1$  and step size of 1 dB, until the output power reaches (Maximum power threshold  $-0,5$  dB).
- d) During Step C, the change in mean output power over 10 consecutive slots shall be within the prescribed range for a TPC\_cmd group of  $+1$ , and step size of 1 dB as given in table 5.4.1.4.2b, until the output power reaches (Maximum power threshold  $-0,5$  dB).
- e) During Step D, the difference in mean output power between adjacent slots shall be within the prescribed range given in table 5.4.1.4.2a for a TPC\_cmd of  $-1$  and step size of 2 dB, until the output power reaches (Minimum power threshold  $+1$  dB).
- f) During Step D, the change in mean output power over 10 consecutive slots shall be within the prescribed range for a TPC\_cmd group of  $-1$ , and step size of 2 dB as given in table 5.4.1.4.2b, until the output power reaches (Minimum power threshold  $+1$  dB).
- g) During Step E, the difference in mean output power between adjacent slots shall be within the prescribed range given in table 5.4.1.4.2a for a TPC\_cmd of  $+1$  and step size of 2 dB, until the output power reaches (Maximum power threshold  $-1$  dB).

- h) During Step E, the change in mean output power over 10 consecutive slots shall be within the prescribed range for a TPC\_cmd group of +1, and step size of 2 dB as given in table 5.4.1.4.2b, until the output power reaches (Maximum power threshold -1 dB).
- i) During Step F, the difference in mean output power between adjacent slots shall be within the prescribed range given in table 5.4.1.4.2a for a TPC\_cmd of -1 and step size of 3 dB, until the output power reaches (Minimum power threshold +1 dB).
- j) During Step F, the change in mean output power over 10 consecutive slots shall be within the prescribed range for a TPC\_cmd group of -1, and step size of 3 dB as given in table 5.4.1.4.2b, until the output power reaches (Minimum power threshold +1 dB).
- k) During Step G, the difference in mean output power between adjacent slots shall be within the prescribed range given in table 5.4.1.4.2a for a TPC\_cmd of +1 and step size of 3 dB, until the output power reaches (Maximum power threshold -1 dB).
- l) During Step G, the change in mean output power over 10 consecutive slots shall be within the prescribed range for a TPC\_cmd group of +1, and step size of 3 dB as given in table 5.4.1.4.2b, until the output power reaches (Maximum power threshold -1 dB).

### 5.4.1.5 Initial accuracy (7,68 Mcps TDD Option)

#### 5.4.1.5.1 Definition and applicability

Initial Uplink power control is the ability of the UE transmitter to set its output power in accordance with measured downlink path loss, and signalling values:  $I_{BTS}$  and Constant value, received from the BCH and applicable for the PRACH.

The requirements and this test apply to all types of UTRA - UEs.

#### 5.4.1.5.2 Minimum requirements

The UE power control, initial accuracy, is given in table 5.4.1.5.2.

**Table 5.4.1.5.2: Initial uplink power control tolerance (7,68 Mcps TDD Option)**

Normal conditions	$\pm 9$ dB
Extreme conditions	$\pm 12$ dB

The reference for this requirement is TS 25.102 [1] clause 6.4.1.3.1.

#### 5.4.1.5.3 Test purpose

The power of the received signal at the UE and the BCH information control the power of the transmitted UE signal with the target to transmit at lowest power, acceptable for proper communication.

The test stresses the ability of the receiver to measure the received power over the receiver dynamic range and to derive from this correct transmitter-power.

#### 5.4.1.5.4 Method of test

##### 5.4.1.5.4.1 Initial conditions

Test environment: normal, TL/VL, TL/VH, TH/VL, TH/VH; see clauses G.2.1 and G.2.2.

Frequencies to be tested: low range, mid range, high range; see clause G.2.4.

Connect the SS to the MS antenna connector as shown in figure A.1.

A call is set up according to the generic call setup procedure [3] using parameters as specified in table 5.4.1.5.4. The RACH procedure within the call setup is used for the test.

**Table 5.4.1.5.4: Test parameters for uplink Power Control (7,68 Mcps TDD Option)**

	<b>RX-Upper dynamic end</b>	<b>RX-middle</b>	<b>RX-Sensitivity level</b>
SS transmit power	-25 dBm/7,68 MHz	-65 dBm/7,68 MHz	-102 dBm/7,68 MHz
Broadcasted transmit-power PCCPCH	35 dBm	35 dBm	24 dBm
Simulated path loss = Broadcasted TX – SS TX Power	60 dB	100 dB	126 dB
I <sub>BTS</sub> (UL interference)	-75 dBm	-100 dBm	-107 dBm
Constant value	-10 dB	-10 dB	-10 dB
Nominal expected UE TX power	-25 dBm	-10 dBm	+9 dBm (note 2)
NOTE 1: While the SS transmit power shall cover the UE receiver input dynamic range, the logical parameters: broadcasted transmit power, I <sub>BTS</sub> , and RACH constant value are chosen to achieve a UE TX power, located within the TX output power dynamic range of a class 3 UE.			
NOTE 2: Nominal TX output power 9 dBm allows to check the uplink power control algorithm within the entire tolerance range (9 dBm +12 dB: 9 dBm +12 dB =21 dBm = max power class 3).			

#### 5.4.1.5.4.2 Procedure

- 1) Set the SS transmit power according to table 5.4.1.1.4.
- 2) Measure the RACH output power of the UE according to annex B.
- 3) Repeat the test for all SS transmit powers and parameters in table 5.4.1.5.4.

#### 5.4.1.5.5 Test requirements

The deviation with respect to the nominal expected UE TX power (table 5.4.1.5.2), derived in step 2, shall not exceed the prescribed tolerance in table 5.4.1.5.5.

**Table 5.4.1.5.5: Test parameters for uplink Power Control**

Expected UE TX power, normal conditions	-25 dBm ±10 dB	-10 dBm±10 dB	+9 dBm ±10 dB
Expected UE TX power, extreme conditions	-25 dBm ±13 dB	-10 dBm±13 dB	+9 dBm ±13 dB

NOTE: If the above Test Requirement differs from the Minimum Requirement then the Test Tolerance applied for this test is non-zero. The Test Tolerance for this test is defined in annex F clause F.2 and the explanation of how the Minimum Requirement has been relaxed by the Test Tolerance is given in annex F clause F.4.

## 5.4.2 Minimum output power

### 5.4.2.1 Definition and applicability

The minimum controlled output power of the UE is when the power is set to a minimum value. The minimum output power is defined as the mean power in one time slot excluding the guard period.

The normative requirements of this test apply to all types of UTRA- UE.

### 5.4.2.2 Minimum Requirements

#### 5.4.2.2.1 3,84Mcps TDD Option

The minimum output power shall be lower than or equal to -44 dBm.

The normative reference for this requirement is TS 25.102 [1] clause 6.4.2.1.1.

#### 5.4.2.2.2 1,28Mcps TDD Option

The minimum output power shall be better than -49 dBm.

The normative reference for this requirement is TS 25.102 [1] clause 6.4.2.1.2.

#### 5.4.2.2.3 7,68Mcps TDD Option

The minimum output power shall be lower than or equal to  $-41$  dBm.

The normative reference for this requirement is TS 25.102 [1] clause 6.4.2.1.3.

#### 5.4.2.3 Test purpose

The test purpose is to verify the ability of the UE to reduce its output power to a specified value.

#### 5.4.2.4 Method of test

##### 5.4.2.4.1 Initial conditions

Test environment: normal, TL/VL, TL/VH, TH/VL, TH/VH; see clauses G.2.1 and G.2.2.

Frequencies to be tested: low range, mid range, high range; see clause G.2.4.

- 1) Connect the SS to the UE antenna connector as shown in figure A.1.
- 2) A call is set up according to the Generic call setup procedure using parameters as specified in table E.3.1.2.
- 3) Enter the UE into loopback test mode and start the loopback test.

##### 5.4.2.4.2 Procedure

- 1) Configure the UE transmitter to enable power control steps of size 1 dB.
- 2) Set and send Down power control commands to the UE. The sequence shall be sufficiently long so that the UE output signal reached its minimum power.
- 2) Measure the mean power of the UE output signal according to annex B.

NOTE: Annex B returns the power in the decision points (displayed as reference power and power offset). This is equivalent to thermal power at the air-interface. Insofar 5.4.2.2.1 minimum output power for 3,84 Mcps TDD Option and 5.4.2.2.2 minimum output power for 1,28 Mcps TDD Option is consistent with 5.2 maximum output power.

- 3) Configure the UE transmitter to enable power control steps of 2 dB and of 3 dB, respectively, and repeat step 2).
- 4) Run step 2) for RF channels Low Mid and High.

#### 5.4.2.5 Test requirements

##### 5.4.2.5.1 3,84 Mcps TDD Option

For all measurements, the minimum output power derived in step 3) and 4) of 5.4.2.4.2 shall be below  $-43$  dBm.

##### 5.4.2.5.2 1,28 Mcps TDD Option

For all measurements, the minimum output power derived in step 3) and 4) of 5.4.2.4.2 shall be below  $-48$  dBm.

NOTE: If the above Test Requirement differs from the Minimum Requirement then the Test Tolerance applied for this test is non-zero. The Test Tolerance for this test is defined in annex F clause F.2 and the explanation of how the Minimum Requirement has been relaxed by the Test Tolerance is given in annex F clause F.4.

##### 5.4.2.5.3 7,68 Mcps TDD Option

For all measurements, the minimum output power derived in step 3) and 4) of 5.4.2.4.2 shall be below  $-40$  dBm.

NOTE: If the above Test Requirement differs from the Minimum Requirement then the Test Tolerance applied for this test is non-zero. The Test Tolerance for this test is defined in annex F clause F.2 and the explanation of how the Minimum Requirement has been relaxed by the Test Tolerance is given in annex F clause F.4.

## 5.4.3 Transmit OFF power

### 5.4.3.1 Definition and applicability

Transmit OFF power is defined as the RRC filtered mean power measured over one chip when the transmitter is off. The transmit OFF power state is when the UE does not transmit.

The requirements of this test apply to all types of UTRA-UE.

### 5.4.3.2 Minimum Requirements

The transmit OFF power shall be below  $-65$  dBm.

The normative reference for this requirement is TS 25.102 clause 6.5.1.

### 5.4.3.3 Test purpose

Refer clause 5.4.4.3.

### 5.4.3.4 Method of test

Refer clause 5.4.4.4.

### 5.4.3.5 Test requirements

The transmit OFF power shall be below  $-63.5$  dBm.

NOTE: If the above Test Requirement differs from the Minimum Requirement then the Test Tolerance applied for this test is non-zero. The Test Tolerance for this test is defined in annex F clause F.2 and the explanation of how the Minimum Requirement has been relaxed by the Test Tolerance is given in annex F clause F.4

## 5.4.4 Transmit ON/OFF Time mask

### 5.4.4.1 Definition and applicability

The transmit ON/OFF time mask defines the ramping time allowed for the UE between transmit OFF power and transmit ON power.

This test applies for all UTRA TTD UEs.

### 5.4.4.2 Minimum requirements

#### 5.4.4.2.1 3,84Mcps TDD Option

The transmit power level versus time shall meet the mask specified in figure 5.4.4.2, where the transmission period refers to the burst without guard-period for a single transmission slot, and to the period from the beginning of the burst in the first transmission slot to the end of the burst without guard period in the last transmission timeslot for consecutive transmission slots.

The reference for this requirement is TS 25.102 [1] clause 6.5.2.1.1.



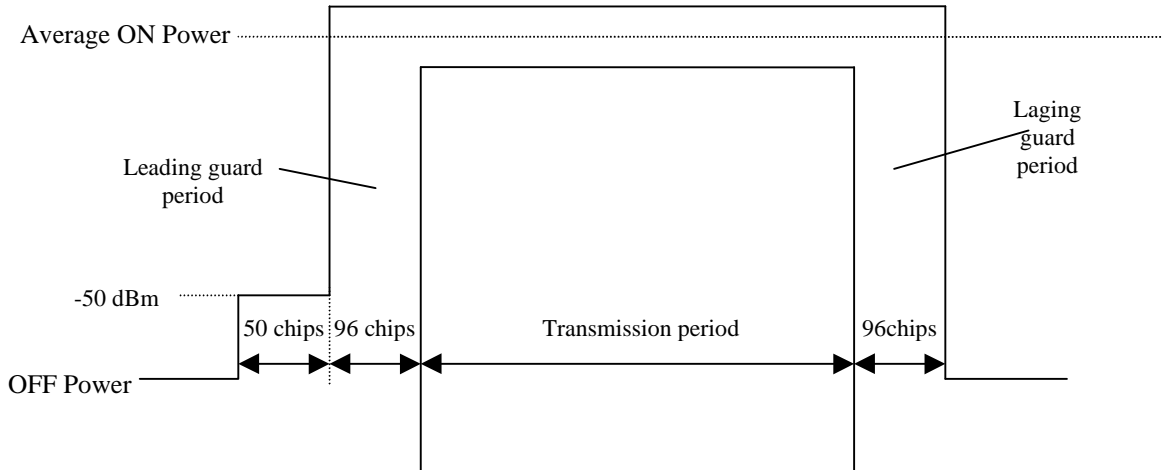
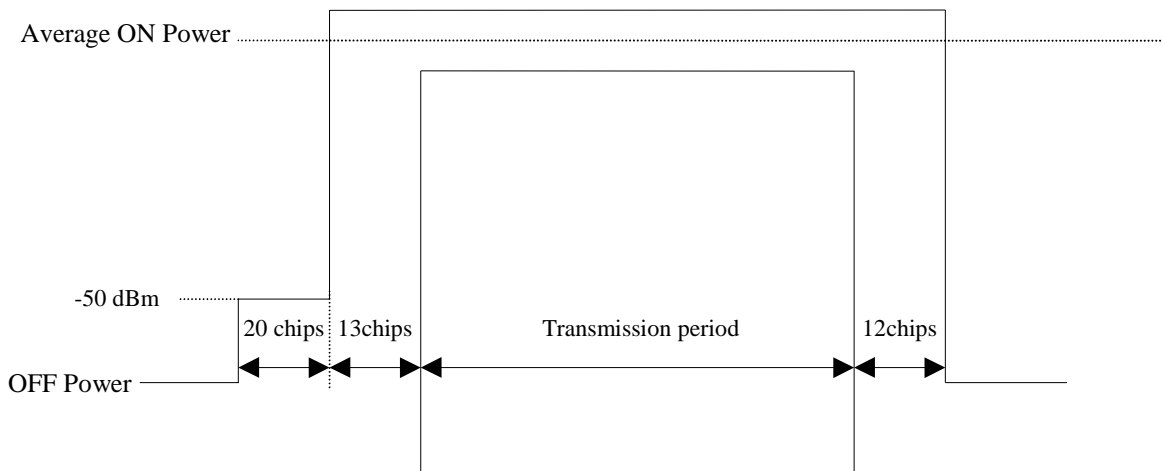

**Figure 5.4.4.2.1: Transmit ON/OFF template for 3,84 Mcps TDD Option**

**5.4.4.2.2 1,28Mcps TDD Option**

The transmit power level versus time shall meet the mask specified in figure 5.4.4.2.2, where the transmission period refers to the burst without guardperiod for a single transmission slot, and to the period from the beginning of the burst in the first transmission slot to the end of the burst without guard period in the last transmission timeslot for consecutive transmission slots.

The reference for this requirement is TS 25.102 [1] clause 6.5.2.1.2.

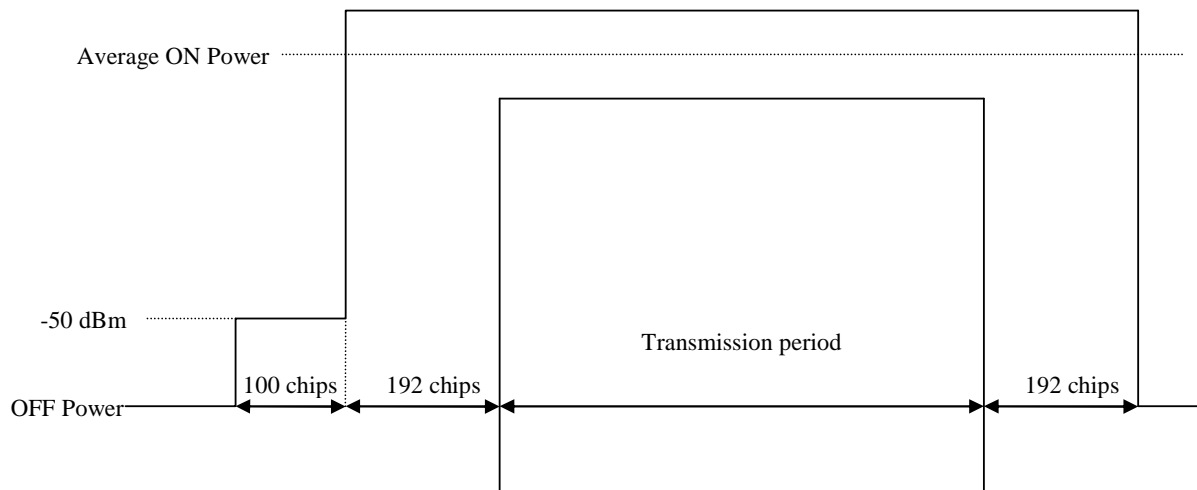

**Figure 5.4.4.2.2: Transmit ON/OFF template for 1,28Mcps TDD Option**

**5.4.4.2.3 7,68Mcps TDD Option**

The transmit power level versus time shall meet the mask specified in figure 5.4.4.2.3, where the transmission period refers to the burst without guard-period for a single transmission slot, and to the period from the beginning of the burst in the first transmission slot to the end of the burst without guard period in the last transmission timeslot for consecutive transmission slots.

The reference for this requirement is TS 25.102 [1] clause 6.5.2.1.3.



**Figure 5.4.4.2.3: Transmit ON/OFF template for 7,68 Mcps TDD Option**

### 5.4.4.3 Test Purpose

It is tested if the UE TX signal uses the guard period for on-to-off and off-to-on transitions, where the time position of guard period is derived from the burst under test itself.

It is further tested, if the UE TX signal is below certain limits outside transmission period and guard periods where the position in time is derived from the burst under test itself.

With this test interference to other UTRA TDD users are limited

### 5.4.4.4 Method of test

#### 5.4.4.4.1 Initial conditions

Test environment: normal, TL/VL, TL/VH, TH/VL, TH/VH; see clauses G.2.1 and G.2.2.

Frequencies to be tested: low range, mid range, high range; see clause G.2.4.

Connect the SS to the UE antenna connector as shown in figure A.1.

A call is set up according to the generic call setup procedure using parameters as specified in table E.3.1.2.

Enter the UE into loopback test mode and start the loopback test.

#### 5.4.4.4.2 Procedure

- 1) The time position of the midamble of the burst under test (TimeSlot  $s$  in Frame  $f$ ) shall be the reference for the time position of the leading and laging guard-periods of the burst under test and, alternatively, for the equivalent guard periods of the next 2 bursts.
- 2) Record the following time periods with at least 2 samples /chip through a matched filter (RRC 0.22, BW equal to the chiprate) : TS  $s-1$  and TS  $s+1$  in frame  $f$  or  $f+1$  or  $f+2$
- 3) Calculate power samples by averaging the recorded samples of one chip duration.

### 5.4.4.5 Test requirements

Each power sample shall be below the limits (off Power (clause 5.4.3) and  $-50$  dBm), indicated in figure 5.4.4.2.1 for 3,84 Mcps TDD Option, figure 5.4.4.2.2 for 1,28 Mcps TDD Option and figure 5.4.4.2.3 for 7,68 Mcps TDD Option, respectively.

NOTE: In this test no power limits apply during guard period.

## 5.4.5 Out-of-synchronisation handling of output power for continuous transmission

### 5.4.5.1 Definition and applicability

The UE shall monitor the DPCH quality in order to detect a loss of the signal on Layer 1, as specified in TS 25.224. [5] The thresholds  $Q_{out}$  and  $Q_{in}$  specify at what DPCH quality levels the UE shall shut its power off and when it shall turn its power on, respectively. The thresholds are not defined explicitly, but are defined by the conditions under which the UE shall shut its transmitter off and turn it on, as stated in this clause.

The requirement of this clause shall apply to all types of UTRA-UE.

### 5.4.5.2 Minimum Requirement

#### 5.4.5.2.1 3,84 Mcps TDD Option

When the UE estimates the DPCH quality over the last 160 ms period to be worse than a threshold  $Q_{out}$ , the UE shall shut its transmitter off within 40 ms. The UE shall not turn its transmitter on again until the DPCH quality exceeds an acceptable level  $Q_{in}$ . When the UE estimates the DPCH quality over the last 160 ms period to be better than a threshold  $Q_{in}$ , the UE shall again turn its transmitter on within 40 ms.

The quality levels at the thresholds  $Q_{out}$  and  $Q_{in}$  correspond to different signal levels depending on the downlink conditions DCH parameters. For the conditions in table 5.4.5.2.1, a signal with the quality at the level  $Q_{out}$  is generated by a  $\Sigma DPCH\_Ec/I_{or}$  ratio of -13 dB, and a signal with  $Q_{in}$  by a  $\Sigma DPCH\_Ec/I_{or}$  ratio of -9 dB. In this test, the DL reference measurement channel (12,2) kbps specified in clause C.3.1, where the CRC bits are replaced by data bits, and with static propagation conditions is used.

**Table 5.4.5.2.1: DCH parameters the of Out-of-synch handling test case test case – 3,84 Mcps TDD option – continuous transmission**

Parameter	Unit	Value
$\hat{I}_{or}/I_{oc}$	dB	1.1
$I_{oc}$	dBm/3,84 MHz	-60
$\frac{\Sigma DPCH\_Ec}{I_{or}}$	dB	See figure 5.4.5.2.1
Information Data Rate	kbps	13
TFCI	-	On

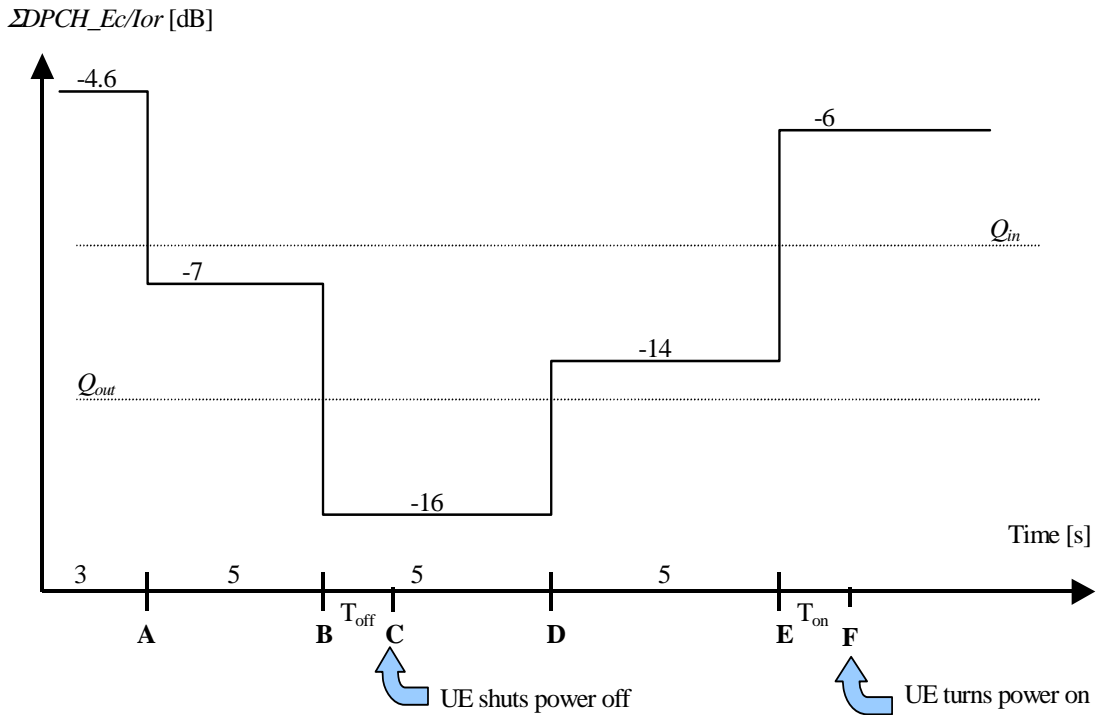

**Figure 5.4.5.2.1: Test case for out-of-synch handling in the UE. Conditions apply for 3,84 Mcps TDD Option – continuous transmission**

The requirements for the UE are that:

- 1) The UE shall not shut its transmitter off before point B.
- 2) The UE shall shut its transmitter off before point C, which is  $T_{off} = 200$  ms after point B
- 3) The UE shall not turn its transmitter on between points C and E.
- 4) The UE shall turn its transmitter on before point F, which is  $T_{on} = 200$  ms after Point E.

The normative reference for this test is TS 25.102 [1] clause 6.4.3.1.1.

**5.4.5.2.2 1,28 Mcps TDD Option**

The parameters in table 5.4.5.2.2 are defined using the DL reference measurement channel (12,2) kbps specified in annex C where the CRC bits are replaced by data bits, and with static propagation conditions.

**Table 5.4.5.2.2: DCH parameters for test of Out-of-synch handling**

Parameter	Unit	Value
$\hat{I}_{or}/I_{oc}$	dB	-1
$I_{oc}$	dBm/1,28 MHz	-60
$\frac{\Sigma DPCH\_E_c}{I_{or}}$	dB	See figure 5.4.5.2.2
Information Data Rate	kbps	12,2
TFCI	-	On

The conditions for when the UE shall shut its transmitter off and when it shall turn it on are defined by the parameters in table 5.4.5.1.2 together with the DPCH power level as defined in figure 5.4.5.1.

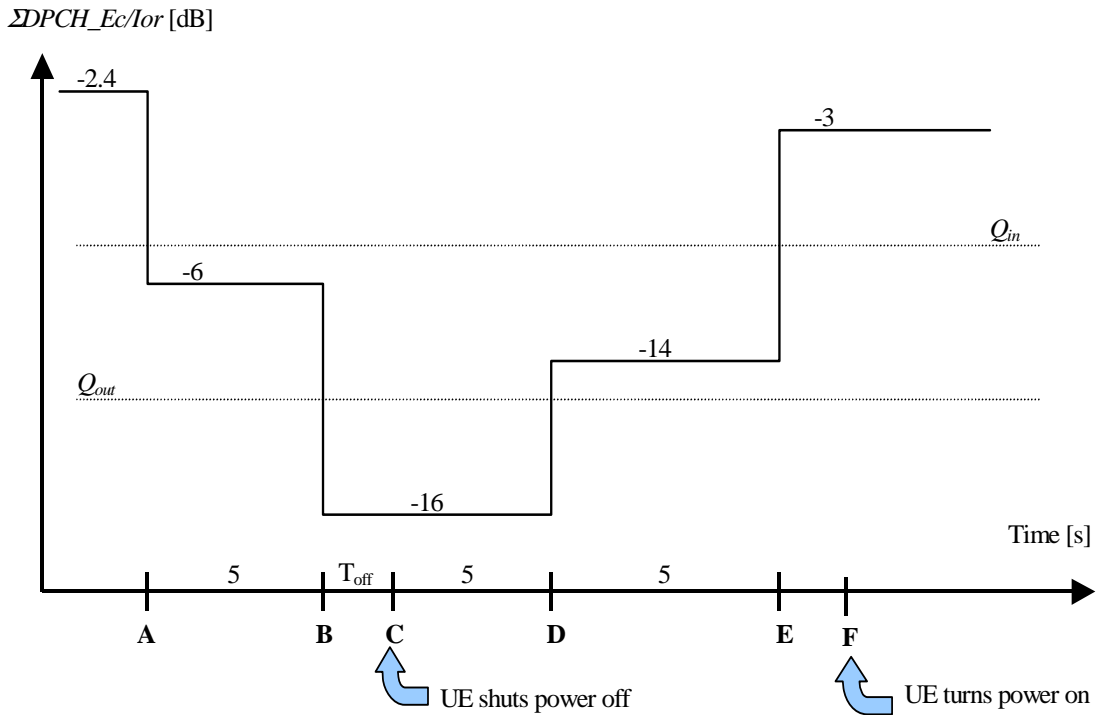

**Figure 5.4.5.2.2: Conditions for out-of-synch handling in the UE. The indicated thresholds  $Q_{out}$  and  $Q_{in}$  are only informative. Conditions apply for 1,28 Mcps TDD Option – continuous transmission**

The requirements for the UE are that:

1. The UE shall not shut its transmitter off before point B.
2. The UE shall shut its transmitter off before point C, which is  $T_{off} = 200$  ms after point B
3. The UE shall not turn its transmitter on between points C and E.
4. The UE shall turn its transmitter on before point F, which is  $T_{on} = 200$  ms after Point E.

The normative reference for this test is TS 25.102 [1] clause 6.4.3.1.2.

### 5.4.5.2.3 7,68 Mcps TDD Option

When the UE estimates the DPCH quality over the last 160 ms period to be worse than a threshold  $Q_{out}$ , the UE shall shut its transmitter off within 40 ms. The UE shall not turn its transmitter on again until the DPCH quality exceeds an acceptable level  $Q_{in}$ . When the UE estimates the DPCH quality over the last 160 ms period to be better than a threshold  $Q_{in}$ , the UE shall again turn its transmitter on within 40 ms.

The quality levels at the thresholds  $Q_{out}$  and  $Q_{in}$  correspond to different signal levels depending on the downlink conditions DCH parameters. For the conditions in table 5.4.5.2.3, a signal with the quality at the level  $Q_{out}$  is generated by a  $\Sigma DPCH\_Ec/Ior$  ratio of -16 dB, and a signal with  $Q_{in}$  by a  $\Sigma DPCH\_Ec/Ior$  ratio of -12 dB. In this test, the DL reference measurement channel (12,2) kbps specified in clause C.3.1.3, where the CRC bits are replaced by data bits, and with static propagation conditions is used.

**Table 5.4.5.2.3: DCH parameters the of Out-of-synch handling test case test case – 7,68 Mcps TDD option – continuous transmission**

Parameter	Unit	Value
$\hat{I}_{or}/I_{oc}$	dB	1.1
$I_{oc}$	dBm/3,84 MHz	-60
$\frac{\Sigma DPCH\_E_c}{I_{or}}$	dB	See figure 5.4.5.2.3
Information Data Rate	kbps	12,2
TFCI	-	On

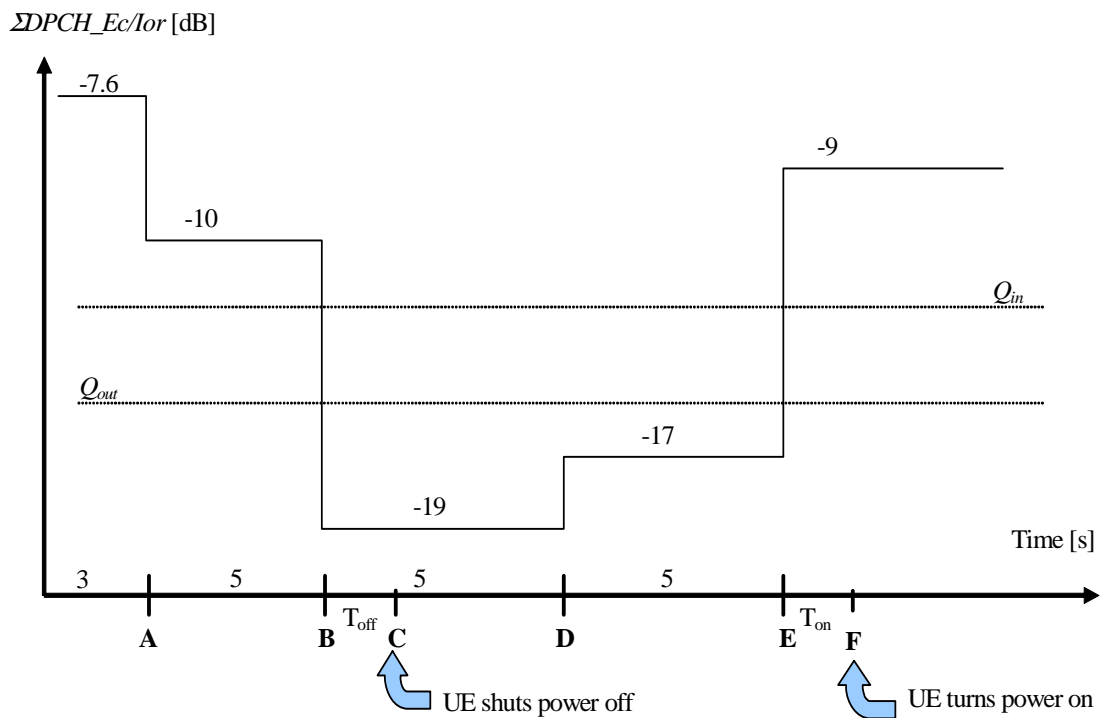

**Figure 5.4.5.2.3: Test case for out-of-synch handling in the UE. Conditions apply for 7,68 Mcps TDD Option – continuous transmission**

The requirements for the UE are that:

- 1) The UE shall not shut its transmitter off before point B.
- 2) The UE shall shut its transmitter off before point C, which is  $T_{off} = 200$  ms after point B
- 3) The UE shall not turn its transmitter on between points C and E.
- 4) The UE shall turn its transmitter on before point F, which is  $T_{on} = 200$  ms after Point E.

The normative reference for this test is TS 25.102 [1] clause 6.4.3.1.3.

### 5.4.5.3 Test purpose

To verify that the UE monitors the DPCH quality and turns its transmitter on or off according to DPCH level diagram specified in figure 5.4.5.1

#### 5.4.5.4 Method of test

##### 5.4.5.4.1 Initial conditions

Test environment: normal; see clauses G.2.1 and G.2.2.

Frequencies to be tested: mid range; see clause G.2.4.

- 1) Connect the SS to the UE antenna connector as shown in figure A.1.
- 2) Calls are set up according to the Generic call setup procedure using parameters as specified in table 5.4.5.1
- 3) Enter the UE into loopback test mode and start the loopback test.
- 4) The handover triggering level shall be set very high [TBD] to ensure that the beacon channel power never exceeds the value of 10dB above it. Therefore the averaging time for signal quality will always be 160 milliseconds.

##### 5.4.5.4.2 Procedure

###### 5.4.5.4.2.1 3,84 Mcps TDD Option

- 1) SS level and signalling values are set that the UE transmits maximum power (see annex E clause E.3.1)

- 2) Set the SS TX signal quality to  $\frac{\Sigma DPCH\_E_c}{I_{or}} = -4.6[+0.4 - 0]$  dB and verify that the UE TX signal is on.

- 3) Set the SS TX signal quality to  $\frac{\Sigma DPCH\_E_c}{I_{or}} = -7[+0.4 - 0]$  dB and verify that the UE TX signal remains on continuously for at least 5 seconds.

- 4) Set the SS TX signal quality to  $\frac{\Sigma DPCH\_E_c}{I_{or}} = -16[+0 - 0.4]$  dB and verify that the UE TX signal turns off 200 ms or earlier with respect to that instant.

- 5) Set the SS TX signal quality to  $\frac{\Sigma DPCH\_E_c}{I_{or}} = -14[+0 - 0.4]$  dB and verify that the UE TX signal remains off continuously for at least 5 seconds.

- 6) Set the SS TX signal quality to  $\frac{\Sigma DPCH\_E_c}{I_{or}} = -6[+0.4 - 0]$  dB and verify that the UE TX signal is switched on 200 ms or earlier with respect to that instant.

###### 5.4.5.4.2.2 1,28 Mcps TDD Option

- 1) The SS sends continuously Up power control commands to the UE until the UE transmitter power reaches maximum level

- 2) Set the SS TX signal quality to  $\frac{\Sigma DPCH\_E_c}{I_{or}} = -2.4 [+0.3 - 0]$  dB and verify that the UE TX signal is on.

- 3) Set the SS TX signal quality to  $\frac{\Sigma DPCH\_E_c}{I_{or}} = -6[+0.3 - 0]$  dB and verify that the UE TX signal remains on continuously for at least 5 seconds.

- 4) Set the SS TX signal quality to  $\frac{\Sigma DPCH\_E_c}{I_{or}} = -16[+0 - 0.3]$  dB and verify that the UE TX signal turns off 200 ms or earlier with respect to that instant.

- 5) Set the SS TX signal quality to  $\frac{\Sigma DPCH - E_c}{I_{or}} = -14[+0 - 0.3]$  dB and verify that the UE TX signal remains off continuously for at least 5 seconds.

- 6) Set the SS TX signal quality to  $\frac{\Sigma DPCH - E_c}{I_{or}} = -3[+0.3 - 0]$  dB and verify that the UE TX signal is switched on 200 ms or earlier with respect to that instant.

#### 5.4.5.4.2.3 7,68 Mcps TDD Option

- 1) SS level and signalling values are set that the UE transmits maximum power (see annex E clause E.3.1)

- 2) Set the SS TX signal quality to  $\frac{\Sigma DPCH - E_c}{I_{or}} = -7.6[+0.4 - 0]$  dB and verify that the UE TX signal is on.

- 3) Set the SS TX signal quality to  $\frac{\Sigma DPCH - E_c}{I_{or}} = -10[+0.4 - 0]$  dB and verify that the UE TX signal remains on continuously for at least 5 seconds.

- 4) Set the SS TX signal quality to  $\frac{\Sigma DPCH - E_c}{I_{or}} = -19[+0 - 0.4]$  dB and verify that the UE TX signal turns off 200 ms or earlier with respect to that instant.

- 5) Set the SS TX signal quality to  $\frac{\Sigma DPCH - E_c}{I_{or}} = -17[+0 - 0.4]$  dB and verify that the UE TX signal remains off continuously for at least 5 seconds.

- 6) Set the SS TX signal quality to  $\frac{\Sigma DPCH - E_c}{I_{or}} = -9[+0.4 - 0]$  dB and verify that the UE TX signal is switched on 200 ms or earlier with respect to that instant.

#### 5.4.5.5 Test Requirements

The UE TX on-criterion including tolerance window is derived from the initial conditions and is verified with the method of 5.4.2.4 minimum transmit power related to minimum requirements according to clause 5.4.2.2.1 for 3,84 Mcps TDD Option, 5.4.2.2.2 for 1,28 Mcps TDD Option and 5.4.2.2.3 for 7.68 Mcps TDD option, respectively. The UE transmitter is considered to be on if the UE transmitted power is higher than the minimum output power.

The UE TX off criterion including tolerance is verified according to clause 5.4.3 of the present document (Transmit off power). The UE transmitter is considered to be off if the UE transmitted power is lower than the transmit OFF power.

To pass the test, steps 1 through 6 of the procedure must be fulfilled.

### 5.4.6 Out-of-synchronisation handling of output power for discontinuous transmission

#### 5.4.6.1 Definition and applicability

Normally the UE monitors the DPCH quality in order to detect a loss of the signal on Layer 1, as specified in TS 25.224. [5] The thresholds  $Q_{out}$  and  $Q_{in}$  specify at what DPCH quality levels the UE shall shut its power off and when it shall turn its power on, respectively. The thresholds are not defined explicitly, but are defined by the conditions under which the UE shall shut its transmitter off and turn it on, as stated in this clause.

However, during DTX, there are periods when the UE will receive no data from the UTRAN. As specified in TS 25.224, in order to keep synchronization, Special Bursts shall be transmitted by the UTRAN during these periods of no data.

During these periods, the conditions for when the UE shall shut its transmitter on or off are defined by the power level of the received Special Bursts.



When the UE does not detect at least one special burst with a quality above a threshold  $Q_{sbout}$  over the last 160 ms period, the UE shall shut its transmitter off within 40 ms. The UE shall not turn its transmitter on again until the special burst quality exceeds an acceptable level  $Q_{sbin}$ . When the UE estimates the special burst quality to be better than a threshold  $Q_{sbin}$  over the last 160 ms, the UE shall again turn its transmitter on within 40 ms.

The requirement of this clause shall apply to all types of UTRA-UE.

### 5.4.6.2 Minimum Requirement

#### 5.4.6.2.1 3,84 Mcps TDD Option

When the UE estimates the DPCH quality over the last 160 ms period to be worse than a threshold  $Q_{out}$ , the UE shall shut its transmitter off within 40 ms. The UE shall not turn its transmitter on again until the DPCH quality exceeds an acceptable level  $Q_{in}$ . When the UE estimates the DPCH quality over the last 160 ms period to be better than a threshold  $Q_{in}$ , the UE shall again turn its transmitter on within 40 ms.

The quality levels at the thresholds  $Q_{out}$  and  $Q_{in}$  correspond to different signal levels depending on the downlink conditions DCH parameters. For the conditions in table 5.4.6.2.1, a signal with the quality at the level  $Q_{out}$  is generated by a  $DPCH_{Ec}/I_{or}$  ratio of -16 dB during special bursts, and a signal with  $Q_{in}$  by a  $DPCH_{Ec}/I_{or}$  ratio of -12 dB.

**Table 5.4.6.2.1: DCH parameters the of Out-of-synch handling test case test case – 3,84 Mcps TDD option – discontinuous transmission**

Parameter	Unit	Value
$\hat{I}_{or}/I_{oc}$	dB	1.1
$I_{oc}$	dBm/3,84 MHz	-60
$\frac{\Sigma DPCH_{Ec}}{I_{or}}$	dB	See figure 5.4.6.2.1
Bits/burst (including TFCI bits)	bits	244
TFCI	-	On

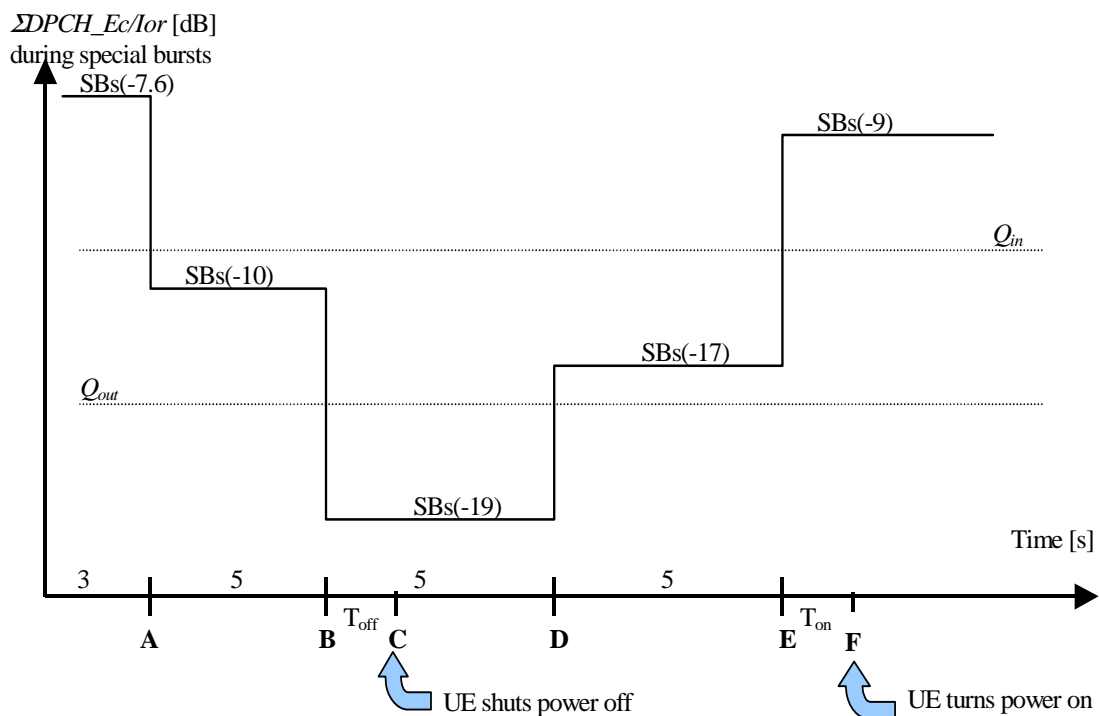

**Figure 5.4.6.2.1: Test case for out-of-synch handling in the UE. Conditions apply for 3,84 Mcps TDD Option – discontinuous transmission**

The requirements for the UE are that:

- 1) The UE shall not shut its transmitter off before point B.
- 2) The UE shall shut its transmitter off before point C, which is  $T_{\text{off}} = 200$  ms after point B
- 3) The UE shall not turn its transmitter on between points C and E.
- 4) The UE shall turn its transmitter on before point F, which is  $T_{\text{on}} = 200$  ms after Point E.

The normative reference for this test is TS 25.102 [1] clause 6.4.3.1.1.

#### 5.4.6.2.2 1,28 Mcps TDD Option

When the UE estimates the DPCH quality over the last 160 ms period to be worse than a threshold  $Q_{\text{out}}$ , the UE shall shut its transmitter off within 40 ms. The UE shall not turn its transmitter on again until the DPCH quality exceeds an acceptable level  $Q_{\text{in}}$ . When the UE estimates the DPCH quality over the last 160 ms period to be better than a threshold  $Q_{\text{in}}$ , the UE shall again turn its transmitter on within 40 ms.

The quality levels at the thresholds  $Q_{\text{out}}$  and  $Q_{\text{in}}$  correspond to different signal levels depending on the downlink conditions DCH parameters. For the conditions in table 5.4.6.2.2, a signal with the quality at the level  $Q_{\text{out}}$  is generated by a  $DPCH\_Ec/I_{\text{or}}$  ratio of -16 dB during special bursts, and a signal with  $Q_{\text{in}}$  by a  $DPCH\_Ec/I_{\text{or}}$  ratio of -12 dB.

**Table 5.4.6.2.2: DCH parameters for test of Out-of-synch handling**

Parameter	Unit	Value
$\hat{I}_{\text{or}}/I_{\text{oc}}$	dB	-1
$I_{\text{oc}}$	dBm/1,28 MHz	-60
$\frac{\Sigma DPCH\_Ec}{I_{\text{or}}}$	dB	See figure 5.4.6.2.2
Bits/burst (including TFCI bits)	bits	88 per subframe
TFCI	-	On

The conditions for when the UE shall shut its transmitter off and when it shall turn it on are defined by the parameters in table 5.4.6.2.2 together with the DPCH power level as defined in figure 5.4.6.2.

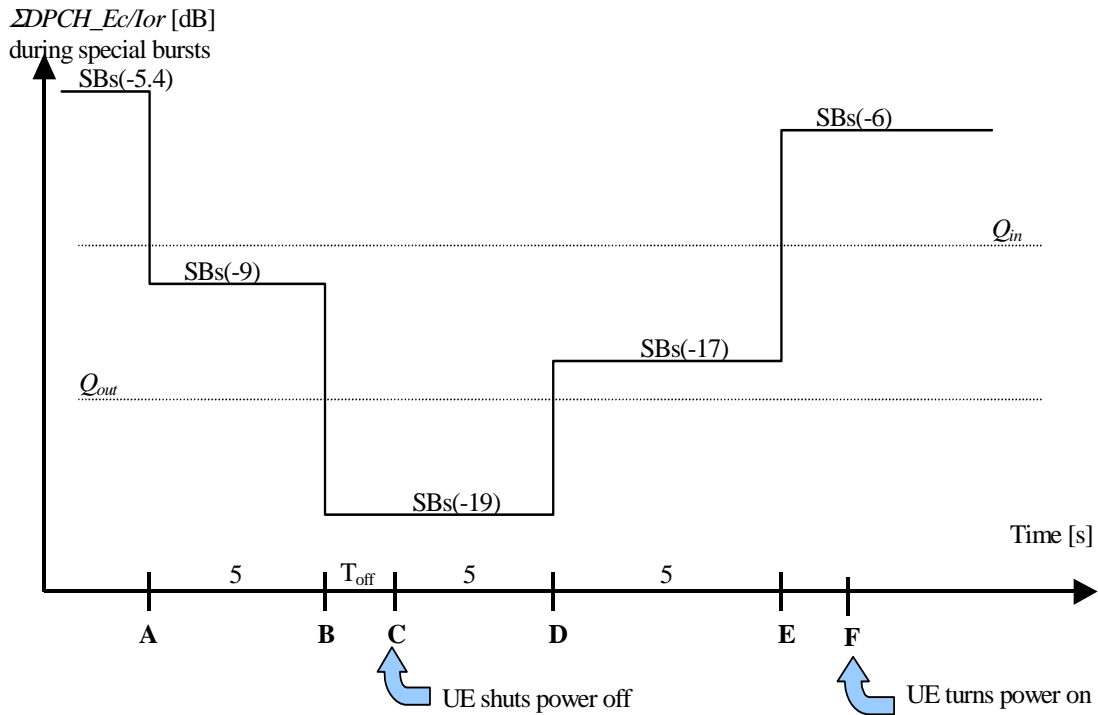

**Figure 5.4.6.2.2: Conditions for out-of-synch handling in the UE. The indicated thresholds  $Q_{out}$  and  $Q_{in}$  are only informative. Conditions apply for 1,28 Mcps TDD Option– discontinuous transmission**

The requirements for the UE are that:

1. The UE shall not shut its transmitter off before point B.
2. The UE shall shut its transmitter off before point C, which is  $T_{off} = 200$  ms after point B
3. The UE shall not turn its transmitter on between points C and E.
4. The UE shall turn its transmitter on before point F, which is  $T_{on} = 200$  ms after Point E.

The normative reference for this test is TS 25.102 [1] clause 6.4.3.1.2.

### 5.4.6.2.3 7,68 Mcps TDD Option

When the UE estimates the DPCH quality over the last 160 ms period to be worse than a threshold  $Q_{out}$ , the UE shall shut its transmitter off within 40 ms. The UE shall not turn its transmitter on again until the DPCH quality exceeds an acceptable level  $Q_{in}$ . When the UE estimates the DPCH quality over the last 160 ms period to be better than a threshold  $Q_{in}$ , the UE shall again turn its transmitter on within 40 ms.

The quality levels at the thresholds  $Q_{out}$  and  $Q_{in}$  correspond to different signal levels depending on the downlink conditions DCH parameters. For the conditions in table 5.4.6.2.3, a signal with the quality at the level  $Q_{out}$  is generated by a DPCH\_Ec/Ior ratio of -19 dB during special bursts, and a signal with  $Q_{in}$  by a DPCH\_Ec/Ior ratio of -15 dB.

**Table 5.4.6.2.3: DCH parameters the of Out-of-synch handling test case test case – 7,68 Mcps TDD option – discontinuous transmission**

Parameter	Unit	Value
$\hat{I}_{or}/I_{oc}$	dB	1.1
$I_{oc}$	dBm/3,84 MHz	-60
$\frac{\Sigma DPCH_{-}E_c}{I_{or}}$	dB	See figure 5.4.6.2.3
Bits/burst (including TFCI bits)	bits	244
TFCI	-	On

The conditions for when the UE shall shut its transmitter off and when it shall turn it on are defined by the parameters in table 5.4.6.2.3 together with the DPCH power level as defined in figure 5.4.6.2.3.

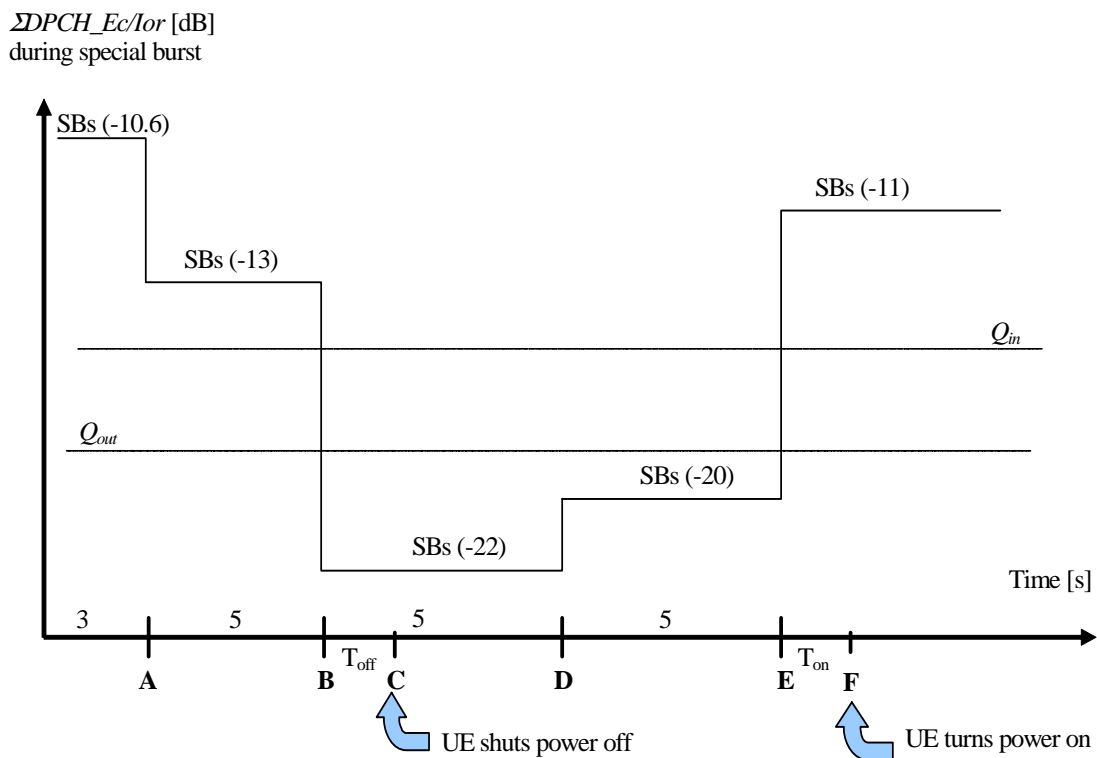

**Figure 5.4.6.2.3: Test case for out-of-synch handling in the UE. Conditions apply for 7,68 Mcps TDD Option – discontinuous transmission**

The requirements for the UE are that:

- 1) The UE shall not shut its transmitter off before point B.
- 2) The UE shall shut its transmitter off before point C, which is  $T_{off} = 200$  ms after point B
- 3) The UE shall not turn its transmitter on between points C and E.
- 4) The UE shall turn its transmitter on before point F, which is  $T_{on} = 200$  ms after Point E.

The normative reference for this test is TS 25.102 [1] clause 6.4.3.1.3.

### 5.4.6.3 Test purpose

To verify that the UE monitors the DPCH quality and turns its transmitter on or off according to DPCH level diagram specified in figure 5.4.6.1

## 5.4.6.4 Method of test

### 5.4.6.4.1 Initial conditions

Test environment: normal; see clauses G.2.1 and G.2.2.

Frequencies to be tested: mid range; see clause G.2.4.

- 1) Connect the SS to the UE antenna connector as shown in figure A.1.
- 2) Calls are set up according to the Generic call setup procedure using parameters as specified in table 5.4.6.1
- 3) Enter the UE into loopback test mode and start the loopback test.
- 4) The handover triggering level shall be set very high [TBD] to ensure that the beacon channel power never exceeds the value of 10dB above it. Therefore the averaging time for signal quality will always be 160 milliseconds.

### 5.4.6.4.2 Procedure

#### 5.4.6.4.2.1 3,84 Mcps TDD Option

- 1) SS level and signalling values are set that the UE transmits maximum power (see annex E clause E.3.1)

- 2) Set the SS TX signal quality to  $\frac{DPCH - E_c}{I_{or}} = -7.6[+0.4 -0]$  dB and verify that the UE TX signal is on.

- 3) Set the SS TX signal quality to  $\frac{DPCH - E_c}{I_{or}} = -10[+0.4 -0]$  dB and verify that the UE TX signal remains on continuously for at least 5 seconds.

- 4) Set the SS TX signal quality to  $\frac{DPCH - E_c}{I_{or}} = -19[+0 -0.4]$  dB and verify that the UE TX signal turns off 200 ms or earlier with respect to that instant.

- 5) Set the SS TX signal quality to  $\frac{DPCH - E_c}{I_{or}} = -17[+0 -0.4]$  dB and verify that the UE TX signal remains off continuously for at least 5 seconds.

- 6) Set the SS TX signal quality to  $\frac{DPCH - E_c}{I_{or}} = -9[+0.4 -0]$  dB and verify that the UE TX signal is switched on 200 ms or earlier with respect to that instant.

#### 5.4.6.4.2.2 1,28 Mcps TDD Option

- 1) The SS sends continuously Up power control commands to the UE until the UE transmitter power reaches maximum level

- 2) Set the SS TX signal quality to  $\frac{DPCH - E_c}{I_{or}} = -5.4[+0.3 - 0]$  dB and verify that the UE TX signal is on.

- 3) Set the SS TX signal quality to  $\frac{DPCH - E_c}{I_{or}} = -9[+0,3-0]$  dB and verify that the UE TX signal remains on continuously for at least 5 seconds.

- 4) Set the SS TX signal quality to  $\frac{DPCH - E_c}{I_{or}} = -19-[+0-0,3]$  dB and verify that the UE TX signal turns off 200 ms or earlier with respect to that instant.

- 5) Set the SS TX signal quality to  $\frac{DPCH - E_c}{I_{or}} = -17-[=0-0,3]$  dB and verify that the UE TX signal remains off continuously for at least 5 seconds.

- 6) Set the SS TX signal quality to  $\frac{DPCH - E_c}{I_{or}} = -6[+0,3-0]$  dB and verify that the UE TX signal is switched on 200 ms or earlier with respect to that instant.

#### 5.4.6.4.2.3 7,68 Mcps TDD Option

- 1) SS level and signalling values are set that the UE transmits maximum power (see annex E clause E.3.1)

- 2) Set the SS TX signal quality to  $\frac{DPCH - E_c}{I_{or}} = -10.6[+0.4 -0]$  dB and verify that the UE TX signal is on.

- 3) Set the SS TX signal quality to  $\frac{DPCH - E_c}{I_{or}} = -13[+0.4 -0]$  dB and verify that the UE TX signal remains on continuously for at least 5 seconds.

- 4) Set the SS TX signal quality to  $\frac{DPCH - E_c}{I_{or}} = -22[+0 -0.4]$  dB and verify that the UE TX signal turns off 200 ms or earlier with respect to that instant.

- 5) Set the SS TX signal quality to  $\frac{DPCH - E_c}{I_{or}} = -20[+0 -0.4]$  dB and verify that the UE TX signal remains off continuously for at least 5 seconds.

- 6) Set the SS TX signal quality to  $\frac{DPCH - E_c}{I_{or}} = -11[+0.4 -0]$  dB and verify that the UE TX signal is switched on 200 ms or earlier with respect to that instant.

#### 5.4.6.5 Test Requirements

The UE TX on-criterion including tolerance window is derived from the initial conditions and is verified with the method of 5.4.2.4 minimum transmit power related to minimum requirements according to clause 5.4.2.2.1 for 3,84 Mcps TDD Option, 5.4.2.2.2 for 1,28 Mcps TDD Option and 5.4.2.2.3 for 7.68Mcps TDD option, respectively. The UE transmitter is considered to be on if the UE transmitted power is higher than the minimum output power.

The UE TX off criterion including tolerance is verified according to clause 5.4.3 of the present document (Transmit off power). The UE transmitter is considered to be off if the UE transmitted power is lower than the transmit OFF power.

To pass the test, steps 1 through 6 of the procedure must be fulfilled.

## 5.5 Output RF spectrum emissions

### 5.5.1 Occupied bandwidth

#### 5.5.1.1 Definition and applicability

Occupied bandwidth is a measure of the bandwidth containing 99 % of the total integrated power for transmitted spectrum and is centered on the assigned channel frequency.

The requirements in this clause shall apply to all types of UTRA - UE.

#### 5.5.1.2 Minimum Requirements

##### 5.5.1.2.1 3,84Mcps TDD Option

The occupied bandwidth shall be less than 5 MHz based on a chip rate of 3,84 Mcps.

The normative reference for this requirement is TS 25.102 [1] clause 6.6.1.1.

##### 5.5.1.2.2 1,28Mcps TDD Option

The occupied channel bandwidth shall be less than 1.6 MHz based on a chip rate of 1,28 Mcps.

The normative reference for this requirement is TS 25.102 [1] clause 6.6.1.2.

#### 5.5.1.2.3 7,68Mcps TDD Option

The occupied bandwidth shall be less than 10 MHz based on a chip rate of 7,68 Mcps.

The normative reference for this requirement is TS 25.102 [1] clause 6.6.1.3.

#### 5.5.1.3 Test purpose

The occupied bandwidth, defined in the Radio Regulations of the International Telecommunication Union ITU, is a useful concept for specifying the spectral properties of a given emission in the simplest possible manner; see also ITU-R Recommendation SM.328-9 [8].

The test purpose is to verify that the emission of the UE is sufficiently concentrated in the bandwidth for the service to be provided and is, therefore, not likely to create interference to other users of the spectrum beyond undue limits.

#### 5.5.1.4 Method of test

##### 5.5.1.4.1 Initial conditions

Test environment: normal; see clauses G.2.1 and G.2.2.

Frequencies to be tested: low range, mid range, high range; see clause G.2.4.

- 1) Connect the SS to the UE antenna connector as shown in figure A.1.
- 2) A call is set up according to the generic call setup procedure using parameters as specified in table E.3.1.2.
- 3) Enter the UE into loopback test mode and start the loopback test.

##### 5.5.1.4.2 Procedure

- 1) Measure the power of the transmitted signal with a measurement filter of bandwidth [30 kHz]. The characteristic of the filter shall be approximately Gaussian (typical spectrum analyzer filter). The center frequency of the filter shall be stepped in contiguous 30 kHz steps from a minimum frequency, which shall be [7,5 – 0,015] MHz for the 3,84 Mcps TDD Option, [2,4 – 0,015] MHz for the 1,28 Mcps TDD Option and [15 - 0,015] MHz for 7.68 Mcps TDD option, respectively, below the assigned channel frequency of the transmitted signal, up to a maximum frequency, which shall be [7,5 – 0,015] MHz for the 3,84 Mcps TDD Option, [2,4 – 0,015] MHz for the 1,28 Mcps TDD Option and [15 - 0,015] MHz for 7.68 Mcps TDD option, respectively, above the assigned channel frequency of the transmitted signal. The step duration shall be sufficient slow to capture the active TS. The measured power shall be recorded for each step.
- 2) Determine the total transmitted power by accumulating the recorded power measurements results of all steps.
- 3) Sum up the power upward from the lower boundary of the measured frequency range in '(2)' and seek the limit frequency point by which this sum becomes 0.5 % of "Total Power" and save this point as "Lower Frequency".
- 4) Sum up the power downward from the upper boundary of the measured frequency range in '(2)' and seek the limit frequency point by which this sum becomes 0.5 % of "Total Power" and save this point as "Upper Frequency".
- 5) Calculate the difference ("Upper Frequency" – "Lower Frequency" = "Occupied Bandwidth") between two limit frequencies obtained in '(4)' and '(5)'.

#### 5.5.1.5 Test requirements

##### 5.5.1.5.1 3,84 Mcps TDD Option

The measured Occupied Bandwidth, derived in step 5), shall not exceed 5 MHz for the 3,84 Mcps TDD Option.

NOTE: If the above Test Requirement differs from the Minimum Requirement then the Test Tolerance applied for this test is non-zero. The Test Tolerance for this test is defined in annex F clause F.2 and the explanation of how the Minimum Requirement has been relaxed by the Test Tolerance is given in annex F clause F.4.

#### 5.5.1.5.2 1,28 Mcps TDD Option

The measured Occupied Bandwidth, derived in step 5), shall not exceed 1.6 MHz for the 1,28 Mcps TDD Option.

NOTE: If the above Test Requirement differs from the Minimum Requirement then the Test Tolerance applied for this test is non-zero. The Test Tolerance for this test is defined in annex F clause F.2 and the explanation of how the Minimum Requirement has been relaxed by the Test Tolerance is given in annex F clause F.4.

#### 5.5.1.5.3 7,68 Mcps TDD Option

The measured Occupied Bandwidth, derived in step 5), shall not exceed 10 MHz for the 7,68 Mcps TDD Option.

NOTE: If the above Test Requirement differs from the Minimum Requirement then the Test Tolerance applied for this test is non-zero. The Test Tolerance for this test is defined in annex F clause F.2 and the explanation of how the Minimum Requirement has been relaxed by the Test Tolerance is given in annex F clause F.4.

### 5.5.2 Out of band emission

Out of band emissions are unwanted emissions immediately outside the nominal channel resulting from the modulation process and non-linearity in the transmitter but excluding spurious emissions. This out of band emission limit is specified in terms of a spectrum emission mask and adjacent channel leakage power ratio (ACLR).

#### 5.5.2.1 Spectrum emission mask

##### 5.5.2.1.1 Definition and applicability

###### 5.5.2.1.1.1 3,84 Mcps TDD Option

The spectrum emission mask of the UE is a requirement that applies to frequencies which are between 2,5 MHz and 12,5 MHz on both sides of the UE centre carrier frequency. The out of channel emission is specified relative to the RRC filtered mean power of the UE carrier.

The requirements of this test apply to all types of UTRA-UE.

###### 5.5.2.1.1.2 1,28 Mcps TDD Option

The spectrum emission mask of the UE applies to frequencies, which are between 0,8 MHz and 4,0 MHz on both sides of the centre carrier frequency. The out of channel emission is specified relative to the RRC filtered mean power of the UE carrier.

The requirements and this test apply to all types of 1.28 Mcps TDD UE.

###### 5.5.2.1.1.3 7,68 Mcps TDD Option

The spectrum emission mask of the UE is a requirement that applies to frequencies which are between 5 MHz and 25 MHz on both sides of the UE centre carrier frequency. The out of channel emission is specified relative to the RRC filtered mean power of the UE carrier.

##### 5.5.2.1.2 Minimum Requirements

###### 5.5.2.1.2.1 3,84 Mcps TDD Option

The power of any UE emission shall not exceed the levels specified in table 5.5.2.1.2.1.

The normative reference for this requirement is TS 25.102 clause 6.6.2.1.1.1.



**Table 5.5.2.1.2.1: Spectrum Emission Mask Requirement (3,84 Mcps TDD Option)**

$\Delta f$ in MHz (note 1)	Minimum requirement	Measurement bandwidth
2.5 - 3.5	$\left\{ -35 - 15 \cdot \left( \frac{\Delta f}{\text{MHz}} - 2.5 \right) \right\} \text{dBc}$	30 kHz (note 2)
3.5 - 7.5	$\left\{ -35 - 1 \cdot \left( \frac{\Delta f}{\text{MHz}} - 3.5 \right) \right\} \text{dBc}$	1 MHz (note 3)
7.5 - 8.5	$\left\{ -39 - 10 \cdot \left( \frac{\Delta f}{\text{MHz}} - 7.5 \right) \right\} \text{dBc}$	1 MHz (note 3)
8.5 - 12.5	-49 dBc	1 MHz
<p>Note 1: <math>\Delta f</math> is the separation between the carrier frequency and the centre of the measuring filter.</p> <p>Note 2: The first and last measurement position with a 30 kHz filter is at <math>\Delta f</math> equals to 2.515 MHz and 3.485 MHz.</p> <p>Note 3: The first and last measurement position with a 1 MHz filter is at <math>\Delta f</math> equals to 4 MHz and 12 MHz. As a general rule, the resolution bandwidth of the measuring equipment should be equal to the measurement bandwidth. To improve measurement accuracy, sensitivity and efficiency, the resolution bandwidth can be different from the measurement bandwidth. When the resolution bandwidth is smaller than the measurement bandwidth, the result should be integrated over the measurement bandwidth in order to obtain the equivalent noise bandwidth of the measurement bandwidth.</p> <p>The lower limit shall be <math>-50\text{dBm}/3,84\text{ MHz}</math> or the minimum requirement presented in this table which ever is the higher.</p>		

## 5.5.2.1.2.2 1,28 Mcps TDD Option

The power of any UE emission shall not exceed the levels specified in table 5.5.2.1.2.2.

The normative reference for this requirement is TS 25.102 clause 6.6.2.1.1.2.

**Table 5.5.2.1.2.2: Spectrum Emission Mask Requirement (1,28 Mcps TDD Option)**

$\Delta f$ (note 1) in MHz	Minimum requirement	Measurement bandwidth
0.8-1.8	$\left\{ -35 - 14 \cdot \left( \frac{\Delta f}{\text{MHz}} - 0.8 \right) \right\} \text{dBc}$	30 kHz (note 2)
1.8-2.4	$\left\{ -49 - 17 \cdot \left( \frac{\Delta f}{\text{MHz}} - 1.8 \right) \right\} \text{dBc}$	30 kHz (note 2)
2.4 - 4.0	-44 dBc	1MHz (note 3)
<p>NOTE 1: <math>\Delta f</math> is the separation between the carrier frequency and the centre of the measuring filter.</p> <p>NOTE 2: The first and last measurement position with a 30 kHz filter is at <math>\Delta f</math> equals to 0.815 MHz and 2.385 MHz.</p> <p>NOTE 3: The first and last measurement position with a 1 MHz filter is at <math>\Delta f</math> equals to 2.9MHz and 3.5MHz. As a general rule, the resolution bandwidth of the measuring equipment should be equal to the measurement bandwidth. To improve measurement accuracy, sensitivity and efficiency, the resolution bandwidth can be different from the measurement bandwidth. When the resolution bandwidth is smaller than the measurement bandwidth, the result should be integrated over the measurement bandwidth in order to obtain the equivalent noise bandwidth of the measurement bandwidth.</p> <p>The lower limit shall be <math>-55\text{dBm}/1,281,28\text{ MHz}</math> or the minimum requirement presented in this table which ever is the higher.</p>		

## 5.5.2.1.2.3 7,68 Mcps TDD Option

The power of any UE emission shall not exceed the levels specified in table 5.5.2.1.2.3.

The normative reference for this requirement is TS 25.102 clause 6.6.2.1.3.1.

**Table 5.5.2.1.2.3: Spectrum Emission Mask Requirement (7,68 Mcps TDD Option)**

$\Delta f^*$ in MHz	Minimum requirement	Measurement bandwidth
5.0 - 5.75	$\left\{ -38 - 10.67 \cdot \left( \frac{\Delta f}{\text{MHz}} - 5.0 \right) \right\} \text{dBc}$	30 kHz **
5.75 - 7.0	$\left\{ -46 - 5.6 \cdot \left( \frac{\Delta f}{\text{MHz}} - 5.75 \right) \right\} \text{dBc}$	30 kHz**
7.0 - 15	$\left\{ -38 - 0.5 \cdot \left( \frac{\Delta f}{\text{MHz}} - 7.0 \right) \right\} \text{dBc}$	1 MHz ***
15.0 - 17.0	$\left\{ -42 - 5.0 \cdot \left( \frac{\Delta f}{\text{MHz}} - 15.0 \right) \right\} \text{dBc}$	1 MHz ***
17.0 - 25.0	-53 dBc	1 MHz ***
<p>* <math>\Delta f</math> is the separation between the carrier frequency and the centre of the measuring filter.  ** The first and last measurement position with a 30 kHz filter is at <math>\Delta f</math> equals to 5.015 MHz and 6.985 MHz  *** The first and last measurement position with a 1 MHz filter is at <math>\Delta f</math> equals to 7.5 MHz and 24.5 MHz. As a general rule, the resolution bandwidth of the measuring equipment should be equal to the measurement bandwidth. To improve measurement accuracy, sensitivity and efficiency, the resolution bandwidth can be different from the measurement bandwidth. When the resolution bandwidth is smaller than the measurement bandwidth, the result should be integrated over the measurement bandwidth in order to obtain the equivalent noise bandwidth of the measurement bandwidth.  Note: The lower limit shall be -47dBm/7.68 MHz or the minimum requirement presented in this table which ever is the higher.</p>		

### 5.5.2.1.3 Test purpose

This test supplements Occupied Bandwidth (verifying the spectral concentration of the UE's emissions) and Adjacent Channel Leakage Ratio (simulating the perception of other UTRA receivers) in a system independent way. It is the purpose of this test to limit interferences to other systems (wideband or narrowband).

### 5.5.2.1.4 Method of test

#### 5.5.2.1.4.1 Initial conditions

Test environment: normal; see clauses G.2.1 and G.2.2.

Frequencies to be tested: low range, mid range, high range; see clause G.2.4.

- 1) Connect the SS to the UE antenna connector as shown in figure A.1.
- 2) A call is set up according to the generic call setup procedure using parameters as specified in table E.3.1.2.
- 3) Enter the UE into loopback test mode and start the loopback test.

#### 5.5.2.1.4.2 Procedure

- 1) Measure the power of the transmitted signal with a measurement filter of bandwidths according to table 5.5.2.1.2.1 for the 3,84 Mcps TDD Option, 5.5.2.1.2.2 for the 1,28 Mcps TDD Option and 5.5.2.1.2.3 for the 7,68 Mcps TDD Option, respectively. The characteristic of the filter shall be approximately Gaussian (typical spectrum analyzer filter). The center frequency of the filter shall be stepped in contiguous steps according to table 5.5.2.1.2.1 for the 3,84 Mcps TDD Option, 5.5.2.1.2.2 for the 1,28 Mcps TDD Option and 5.5.2.1.2.3 for the 7,68 Mcps TDD Option, respectively. The step duration shall be sufficient slow to capture the active TS. The measured power shall be recorded for each step.
- 2) Measure the RRC filtered mean power centered on the assigned channel frequency according to annex B.

3) Display the results of 1) in dBc with respect to 2).

### 5.5.2.1.5 Test requirements

#### 5.5.2.1.5.1 3,84 Mcps TDD Option

The result 5.5.2.1.4.2. step 3) shall fulfil the requirements of table 5.5.2.1.5.1.

**Table 5.5.2.1.5.1: Spectrum Emission Mask Requirement (3,84 Mcps TDD Option)**

$\Delta f$ in MHz (note 1)	Minimum requirement	Measurement bandwidth
2.5 - 3.5	$\left\{ -33.5 - 15 \cdot \left( \frac{\Delta f}{\text{MHz}} - 2.5 \right) \right\} \text{dBc}$	30 kHz
3.5 - 7.5	$\left\{ -33.5 - 1 \cdot \left( \frac{\Delta f}{\text{MHz}} - 3.5 \right) \right\} \text{dBc}$	1 MHz
7.5 - 8.5	$\left\{ -37.5 - 10 \cdot \left( \frac{\Delta f}{\text{MHz}} - 7.5 \right) \right\} \text{dBc}$	1 MHz
8.5 - 12.5	-47.5 dBc	1 MHz
<p>Note 1: <math>\Delta f</math> is the separation between the carrier frequency and the centre of the measuring filter.</p> <p>Note 2: The first and last measurement position with a 30 kHz filter is at <math>\Delta f</math> equals to 2.515 MHz and 3.485 MHz.</p> <p>Note 3: The first and last measurement position with a 1 MHz filter is at <math>\Delta f</math> equals to 4 MHz and 12 MHz. As a general rule, the resolution bandwidth of the measuring equipment should be equal to the measurement bandwidth. To improve measurement accuracy, sensitivity and efficiency, the resolution bandwidth can be different from the measurement bandwidth. When the resolution bandwidth is smaller than the measurement bandwidth, the result should be integrated over the measurement bandwidth in order to obtain the equivalent noise bandwidth of the measurement bandwidth..</p> <p>The lower limit shall be <math>-48.5\text{dBm}/3,84\text{ MHz}</math> or the minimum requirement presented in this table which ever is the higher.</p>		

NOTE: If the above Test Requirement differs from the Minimum Requirement then the Test Tolerance applied for this test is non-zero. The Test Tolerance for this test is defined in Annex F.2 and the explanation of how the Minimum Requirement has been relaxed by the Test Tolerance is given in Annex F.4.

## 5.5.2.1.5.2 1,28 Mcps TDD Option

The result 5.5.2.1.4.2. step 3) shall fulfil the requirements of table 5.5.2.1.5.2.

**Table 5.5.2.1.5.2: Spectrum Emission Mask Requirement (1,28 Mcps TDD Option)**

$\Delta f$ (note 1) in MHz	Minimum requirement	Measurement bandwidth
0.8-1.8	$\left\{ -33.5 - 14 \cdot \left( \frac{\Delta f}{\text{MHz}} - 0.8 \right) \right\} \text{dB}$	30 kHz (note 2)
1.8-2.4	$\left\{ -47.5 - 17 \cdot \left( \frac{\Delta f}{\text{MHz}} - 1.8 \right) \right\} \text{dB}$	30 kHz (note 2)
2.4 – 4.0	-42.5 dBc	1MHz (note 3)
<p>NOTE 1: <math>\Delta f</math> is the separation between the carrier frequency and the centre of the measuring filter.</p> <p>NOTE 2: The first and last measurement position with a 30 kHz filter is at <math>\Delta f</math> equals to 0.815 MHz and 2.385 MHz.</p> <p>NOTE 3: The first and last measurement position with a 1 MHz filter is at <math>\Delta f</math> equals to 2.9MHz and 3.5MHz .As a general rule, the resolution bandwidth of the measuring equipment should be equal to the measurement bandwidth. To improve measurement accuracy, sensitivity and efficiency, the resolution bandwidth can be different from the measurement bandwidth. When the resolution bandwidth is smaller than the measurement bandwidth, the result should be integrated over the measurement bandwidth in order to obtain the equivalent noise bandwidth of the measurement bandwidth.</p> <p>The lower limit shall be <math>-53.5 \text{ dBm}/1,281,28 \text{ MHz}</math> or the minimum requirement presented in this table which ever is the higher.</p>		

NOTE: If the above Test Requirement differs from the Minimum Requirement then the Test Tolerance applied for this test is non-zero. The Test Tolerance for this test is defined in Annex F.2 and the explanation of how the Minimum Requirement has been relaxed by the Test Tolerance is given in Annex F.4.

## 5.5.2.1.5.3 7,68 Mcps TDD Option

The result 5.5.2.1.4.2. step 3) shall fulfil the requirements of table 5.5.2.1.5.3.

**Table 5.5.2.1.5.3: Spectrum Emission Mask Requirement (7,68 Mcps TDD Option)**

$\Delta f^*$ in MHz	Minimum requirement	Measurement bandwidth
5.0 - 5.75	$\left\{ -36.5 - 10.67 \cdot \left( \frac{\Delta f}{\text{MHz}} - 5.0 \right) \right\} \text{dBc}$	30 kHz **
5.75 - 7.0	$\left\{ -44.5 - 5.6 \cdot \left( \frac{\Delta f}{\text{MHz}} - 5.75 \right) \right\} \text{dBc}$	30 kHz**
7.0 - 15	$\left\{ -36.5 - 0.5 \cdot \left( \frac{\Delta f}{\text{MHz}} - 7.0 \right) \right\} \text{dBc}$	1 MHz ***
15.0 - 17.0	$\left\{ -40.5 - 5.0 \cdot \left( \frac{\Delta f}{\text{MHz}} - 15.0 \right) \right\} \text{dBc}$	1 MHz ***
17.0 - 25.0	-51.5 dBc	1 MHz ***
<p>* <math>\Delta f</math> is the separation between the carrier frequency and the centre of the measuring filter.  ** The first and last measurement position with a 30 kHz filter is at <math>\Delta f</math> equals to 5.015 MHz and 6.985 MHz  *** The first and last measurement position with a 1 MHz filter is at <math>\Delta f</math> equals to 7.5 MHz and 24.5 MHz. As a general rule, the resolution bandwidth of the measuring equipment should be equal to the measurement bandwidth. To improve measurement accuracy, sensitivity and efficiency, the resolution bandwidth can be different from the measurement bandwidth. When the resolution bandwidth is smaller than the measurement bandwidth, the result should be integrated over the measurement bandwidth in order to obtain the equivalent noise bandwidth of the measurement bandwidth.  Note: The lower limit shall be -47dBm/7.68 MHz or the minimum requirement presented in this table which ever is the higher.</p>		

NOTE: If the above Test Requirement differs from the Minimum Requirement then the Test Tolerance applied for this test is non-zero. The Test Tolerance for this test is defined in Annex F.2 and the explanation of how the Minimum Requirement has been relaxed by the Test Tolerance is given in Annex F.4.

## 5.5.2.1A Spectrum emission mask

## 5.5.2.1A.1 Definition and applicability

## 5.5.2.1A.1.1 3,84 Mcps TDD Option

[FFS]

## 5.5.2.1A.1.2 1,28 Mcps TDD Option

The spectrum emission mask of the UE applies to frequencies, which are between 0,8 MHz and 4,0 MHz on both sides of the centre carrier frequency. The out of channel emission is specified relative to the RRC filtered mean power of the UE carrier.

The requirements and this test apply for release 7 and later release to all types of UTRA for the TDD UE that support HSUPA.

## 5.5.2.1A.1.3 7,68 Mcps TDD Option

[FFS]

## 5.5.2.1A.2 Minimum Requirements

## 5.5.2.1A.2.1 3,84 Mcps TDD Option

[FFS]

## 5.5.2.1A.2.2 1,28 Mcps TDD Option

The power of any UE emission shall not exceed the levels specified in table 5.5.2.1A.2.2a.

The normative reference for this requirement is TS 25.102 clause 6.6.2.1.1.2.

**Table 5.5.2.1A.2.2a: Spectrum Emission Mask Requirement (1,28 Mcps TDD Option)**

$\Delta f$ (note 1) in MHz	Minimum requirement	Measurement bandwidth
0.8-1.8	$\left\{ -35 - 14 \cdot \left( \frac{\Delta f}{\text{MHz}} - 0.8 \right) \right\} \text{dBc}$	30 kHz (note 2)
1.8-2.4	$\left\{ -49 - 17 \cdot \left( \frac{\Delta f}{\text{MHz}} - 1.8 \right) \right\} \text{dBc}$	30 kHz (note 2)
2.4 – 4.0	-44 dBc	1MHz (note 3)

NOTE 1:  $\Delta f$  is the separation between the carrier frequency and the centre of the measuring filter.  
NOTE 2: The first and last measurement position with a 30 kHz filter is at  $\Delta f$  equals to 0.815 MHz and 2.385 MHz.  
NOTE 3: The first and last measurement position with a 1 MHz filter is at  $\Delta f$  equals to 2.9MHz and 3.5MHz .As a general rule, the resolution bandwidth of the measuring equipment should be equal to the measurement bandwidth. To improve measurement accuracy, sensitivity and efficiency, the resolution bandwidth can be different from the measurement bandwidth. When the resolution bandwidth is smaller than the measurement bandwidth, the result should be integrated over the measurement bandwidth in order to obtain the equivalent noise bandwidth of the measurement bandwidth.  
The lower limit shall be  $-55\text{dBm}/1,281,28 \text{ MHz}$  or the minimum requirement presented in this table which ever is the higher.

#### 5.5.2.1A.2.3 7,68 Mcps TDD Option

[FFS]

#### 5.5.2.1A.3 Test purpose

This test supplements Occupied Bandwidth (verifying the spectral concentration of the UE's emissions) and Adjacent Channel Leakage Ratio in a system independent way. It is the purpose of this test to limit interferences to other systems (wideband or narrowband).

#### 5.5.2.1A.4 Method of test

##### 5.5.2.1A.4.1 Initial conditions

Test environment: normal; see clauses G.2.1 and G.2.2.

Frequencies to be tested: low range, mid range, high range; see clause G.2.4.

- 1) Connect the SS to the UE antenna connector as shown in figure A.1.
- 2) The Reference Measurement Channels(FRC3,16QAM) are specified C.6.1.2.3.
- 3) A HSUPA call is set up according to TS 34.108[3] clause 7.3.9.
- 4) Enter the UE into loopback test mode in the presence of HSUPA and start the loopback test.

##### 5.5.2.1A.4.2 Procedure

- 1) Measure the power of the transmitted signal with a measurement filter of bandwidths according to table 5.5.2.1A.2.2a for the 1,28 Mcps TDD Option. The characteristic of the filter shall be approximately Gaussian (typical spectrum analyzer filter). The center frequency of the filter shall be stepped in contiguous steps according to table 5.5.2.1A.2.2a for the 1,28 Mcps TDD Option. The step duration shall be sufficient slow to capture the active TS. The measured power shall be recorded for each step.
- 2) Measure the RRC filtered mean power centered on the assigned channel frequency according to annex B.
- 3) Display the results of 1) in dBc with respect to 2).

## 5.5.2.1A5 Test requirements

## 5.5.2.1A5.1 3,84 Mcps TDD Option

[FFS]

## 5.5.2.1A5.2 1,28 Mcps TDD Option

The result 5.5.2.1B4.2. step 3) shall fulfil the requirements of table 5.5.2.1A.5.2a.

**Table 5.5.2.1A.5.2a: Spectrum Emission Mask Requirement (1,28 Mcps TDD Option)**

$\Delta f$ (note 1) in MHz	Minimum requirement	Measurement bandwidth
0.8	-33.5 dBc	30 kHz (note 2)
0.8-1.8	$\left\{ -33.5 - 14 \cdot \left( \frac{\Delta f}{\text{MHz}} - 0.8 \right) \right\} \text{dB}$	30 kHz (note 2)
1.8-2.4	$\left\{ -47.5 - 17 \cdot \left( \frac{\Delta f}{\text{MHz}} - 1.8 \right) \right\} \text{dB}$	30 kHz (note 2)
2.4 – 4.0	-42.5 dBc	1MHz (note 3)
NOTE 1: $\Delta f$ is the separation between the carrier frequency and the centre of the measuring filter. NOTE 2: The first and last measurement position with a 30 kHz filter is at $\Delta f$ equals to 0.815 MHz and 2.385 MHz. NOTE 3: The first and last measurement position with a 1 MHz filter is at $\Delta f$ equals to 2.9MHz and 3.5MHz. .As a general rule, the resolution bandwidth of the measuring equipment should be equal to the measurement bandwidth. To improve measurement accuracy, sensitivity and efficiency, the resolution bandwidth can be different from the measurement bandwidth. When the resolution bandwidth is smaller than the measurement bandwidth, the result should be integrated over the measurement bandwidth in order to obtain the equivalent noise bandwidth of the measurement bandwidth. The lower limit shall be $-53.5 \text{ dBm}/1,281,28 \text{ MHz}$ or the minimum requirement presented in this table which ever is the higher.		

NOTE: If the above Test Requirement differs from the Minimum Requirement then the Test Tolerance applied for this test is non-zero. The Test Tolerance for this test is defined in Annex F.2 and the explanation of how the Minimum Requirement has been relaxed by the Test Tolerance is given in Annex F.4.

## 5.5.2.1A5.3 7,68 Mcps TDD Option

[FFS]

## 5.5.2.1B Spectrum emission mask

## 5.5.2.1B.1 Definition and applicability

## 5.5.2.1B.1.1 3,84 Mcps TDD Option

[FFS]

## 5.5.2.1B.1.2 1,28 Mcps TDD Option

The spectrum emission mask of the UE applies to frequencies, which are between 0,8 MHz and 4,0 MHz on both sides of the centre carrier frequency. The out of channel emission is specified relative to the RRC filtered mean power of the UE carrier.

The requirements and this test apply for release 5 and later release to all types of UTRA for the TDD UE that support HSDPA.

## 5.5.2.1B.1.3 7,68 Mcps TDD Option

[FFS]

## 5.5.2.1B.2 Minimum Requirements

## 5.5.2.1B.2.1 3,84 Mcps TDD Option

[FFS]

## 5.5.2.1B.2.2 1,28 Mcps TDD Option

The power of any UE emission shall not exceed the levels specified in table 5.5.2.1B.2.2b.

The normative reference for this requirement is TS 25.102 clause 6.6.2.1.1.2.

**Table 5.5.2.1B.2.2b: Spectrum Emission Mask Requirement (1,28 Mcps TDD Option)**

$\Delta f$ (note 1) in MHz	Minimum requirement	Measurement bandwidth
0.8-1.8	$\left\{ -35 - 14 \cdot \left( \frac{\Delta f}{\text{MHz}} - 0.8 \right) \right\} \text{dBc}$	30 kHz (note 2)
1.8-2.4	$\left\{ -49 - 17 \cdot \left( \frac{\Delta f}{\text{MHz}} - 1.8 \right) \right\} \text{dBc}$	30 kHz (note 2)
2.4 – 4.0	-44 dBc	1MHz (note 3)
NOTE 1: $\Delta f$ is the separation between the carrier frequency and the centre of the measuring filter. NOTE 2: The first and last measurement position with a 30 kHz filter is at $\Delta f$ equals to 0.815 MHz and 2.385 MHz. NOTE 3: The first and last measurement position with a 1 MHz filter is at $\Delta f$ equals to 2.9MHz and 3.5MHz .As a general rule, the resolution bandwidth of the measuring equipment should be equal to the measurement bandwidth. To improve measurement accuracy, sensitivity and efficiency, the resolution bandwidth can be different from the measurement bandwidth. When the resolution bandwidth is smaller than the measurement bandwidth, the result should be integrated over the measurement bandwidth in order to obtain the equivalent noise bandwidth of the measurement bandwidth. The lower limit shall be $-55\text{dBm}/1,281,28 \text{ MHz}$ or the minimum requirement presented in this table which ever is the higher.		

## 5.5.2.1B.2.3 7,68 Mcps TDD Option

[FFS]

## 5.5.2.1B.3 Test purpose

This test supplements Occupied Bandwidth (verifying the spectral concentration of the UE's emissions) and Adjacent Channel Leakage Ratio in a system independent way. It is the purpose of this test to limit interferences to other systems (wideband or narrowband).

## 5.5.2.1B.4 Method of test

## 5.5.2.1B.4.1 Initial conditions

Test environment: normal; see clauses G.2.1 and G.2.2.

Frequencies to be tested: low range, mid range, high range; see clause G.2.4.

- 2) Connect the SS to the UE antenna connector as shown in figure A.1.
- 2) The Reference Measurement Channels are specified C.2.2.2a.
- 3) An HSDPA call is set up according to the generic call setup procedure using parameters as specified in table E.3.1.2.
- 4) Enter the UE into loopback test mode and start the loopback test.



## 5.5.2.1B.4.2 Procedure

- 1) Measure the power of the transmitted signal with a measurement filter of bandwidths according to table 5.5.2.1B.2.2b for the 1,28 Mcps TDD Option. The characteristic of the filter shall be approximately Gaussian (typical spectrum analyzer filter). The center frequency of the filter shall be stepped in contiguous steps according to table 5.5.2.1B.2.2b for the 1,28 Mcps TDD Option. The step duration shall be sufficient slow to capture the active TS. The measured power shall be recorded for each step.
- 2) Measure the RRC filtered mean power centered on the assigned channel frequency according to annex B.
- 3) Display the results of 1) in dBc with respect to 2).

## 5.5.2.1B5 Test requirements

## 5.5.2.1B5.1 3,84 Mcps TDD Option

[FFS]

## 5.5.2.1B5.2 1,28 Mcps TDD Option

The result 5.5.2.1B4.2. step 3) shall fulfil the requirements of table 5.5.2.1B.5.2b.

**Table 5.5.2.1B.5.2b: Spectrum Emission Mask Requirement (1,28 Mcps TDD Option)**

$\Delta f$ (note 1) in MHz	Minimum requirement	Measurement bandwidth
0.8-1.8	$\left\{ -33.5 - 14 \cdot \left( \frac{\Delta f}{\text{MHz}} - 0.8 \right) \right\} \text{dB}$	30 kHz (note 2)
1.8-2.4	$\left\{ -47.5 - 17 \cdot \left( \frac{\Delta f}{\text{MHz}} - 1.8 \right) \right\} \text{dB}$	30 kHz (note 2)
2.4 – 4.0	-42.5 dBc	1MHz (note 3)

NOTE 1:  $\Delta f$  is the separation between the carrier frequency and the centre of the measuring filter.  
 NOTE 2: The first and last measurement position with a 30 kHz filter is at  $\Delta f$  equals to 0.815 MHz and 2.385 MHz.  
 NOTE 3: The first and last measurement position with a 1 MHz filter is at  $\Delta f$  equals to 2.9MHz and 3.5MHz. As a general rule, the resolution bandwidth of the measuring equipment should be equal to the measurement bandwidth. To improve measurement accuracy, sensitivity and efficiency, the resolution bandwidth can be different from the measurement bandwidth. When the resolution bandwidth is smaller than the measurement bandwidth, the result should be integrated over the measurement bandwidth in order to obtain the equivalent noise bandwidth of the measurement bandwidth.  
 The lower limit shall be  $-53.5 \text{ dBm}/1,281,28 \text{ MHz}$  or the minimum requirement presented in this table which ever is the higher.

NOTE: If the above Test Requirement differs from the Minimum Requirement then the Test Tolerance applied for this test is non-zero. The Test Tolerance for this test is defined in Annex F.2 and the explanation of how the Minimum Requirement has been relaxed by the Test Tolerance is given in Annex F.4.

## 5.5.2.1B5.3 7,68 Mcps TDD Option

[FFS]

## 5.5.2.2 Adjacent Channel Leakage power Ratio (ACLR)

## 5.5.2.2.1 Definition and applicability

Adjacent Channel Leakage power Ratio (ACLR) is the ratio of the RRC filtered mean power centered on the assigned channel frequency to the RRC filtered mean power centered on an adjacent channel frequency.

The requirements in this clause shall apply to all types of UTRA-UE.

### 5.5.2.2.2 Minimum Requirements

#### 5.5.2.2.2.1 3,84Mcps TDD Option

If the adjacent channel RRC filtered mean power is greater than  $-50$  dBm then the ACLR shall be higher than the value specified in table 5.5.2.2.2.1.

The normative reference for this requirement is TS 25.102 [1] clause 6.6.2.2.1.1.

**Table 5.5.2.2.2.1: UE ACLR (3,84 Mcps TDD Option)**

Power Class	Adjacent channel	ACLR limit
2, 3	UE-channel $\pm 5$ MHz	33 dB
2, 3	UE-Channel $\pm 10$ MHz	43 dB

#### 5.5.2.2.2.2 1,28Mcps TDD Option

If the adjacent channel RRC filtered mean power is greater than  $-55$  dBm then the ACLR shall be better than the value specified in table 5.5.2.2.2.2.

The normative reference for this requirement is TS 25.102 [1] clause 6.6.2.2.1.2.

**Table 5.5.2.2.2.2: UE ACLR (1,28Mcps TDD Option)**

Power Class	adjacent channel	ACLR limit
2, 3	UE channel $\pm 1.6$ MHz	33 dB
2, 3	UE channel $\pm 3.2$ MHz	43 dB

NOTE 1: The requirement shall still be met in the presence of switching transients.

NOTE 2: The ACLR requirements reflect what can be achieved with present state of the art technology.

NOTE 3: Requirement on the UE shall be reconsidered when the state of the art technology progresses.

#### 5.5.2.2.2.3 7,68Mcps TDD Option

If the adjacent channel RRC filtered mean power is greater than  $-50$  dBm measured with a 3.84 Mcps RRC filter then the ACLR shall be higher than the value specified in table 5.5.2.2.2.3.

The normative reference for this requirement is TS 25.102 [1] clause 6.6.2.2.1.3.

**Table 5.5.2.2.2.3: UE ACLR (7,68 Mcps TDD Option)**

Power Class	adjacent channel	Chip Rate for RRC Measurement Filter	ACLR limit
2, 3	UE channel $\pm 7.5$ MHz	3.84 MHz	33 dB
2, 3	UE channel $\pm 12.5$ MHz	3.84 MHz	43 dB
2,3	UE channel $\pm 10.0$ MHz	7.68 MHz	33 dB
2,3	UE channel $\pm 20.0$ MHz	7.68 MHz	43 dB

NOTE 1: The requirement shall still be met in the presence of switching transients.

NOTE 2: The ACLR requirements reflect what can be achieved with present state of the art technology.

#### 5.5.2.2.3 Test purpose

The test purpose is to verify the ability of the UE to limit the interference produced by the transmitted signal to other UTRA receivers operating at the first or second adjacent RF channel.

#### 5.5.2.2.4 Method of test

##### 5.5.2.2.4.1 Initial conditions

Test environment: normal, TL/VL, TL/VH, TH/VL, TH/VH; see clauses G.2.1 and G.2.2.

Frequencies to be tested: low range, mid range, high range; see clause G.2.4.

- 1) Connect the SS to the UE antenna connector as shown in figure A.1.
- 2) A call is set up according to the generic call setup procedure using parameters as specified in table E.3.1.2.
- 3) Enter the UE into loopback test mode and start the loopback test.

##### 5.5.2.2.4.2 Procedure

- 1) Measure the RRC filtered mean power centered on the assigned channel frequency.
- 2) Measure RRC filtered mean power centered on the first lower adjacent channel frequency.
- 3) Calculate the ACLR by dividing the power measured in 1) by the power measured in 2).
- 4) Repeat steps 2) and 3) for the second lower adjacent RF channel (center frequency 10 MHz for the 3,84 Mcps TDD Option, 3,2 MHz for the 1,28 Mcps TDD Option and 20MHz for the 7,68 Mcps TDD option with the 7,68Mcps RRC filter, respectively, below the assigned channel frequency of the transmitted signal) and also for the first and second upper adjacent RF channel (center frequency 5 MHz for the 3,84 Mcps TDD Option, 1,6 MHz for the 1,28 Mcps TDD Option and 10MHz for the 7,68Mcps TDD option with the 7,68Mcps RRC filter, respectively, and 10 MHz, for the 3,84 Mcps TDD Option, 3,2 MHz for the 1,28 Mcps TDD Option and 20MHz for the 7,68Mcps TDD option with the 7,68Mcps RRC filter, respectively).
- 7) Run step 1) to 4) for RF channels Low/Mid/High.
- 8) For the 7,68Mcps TDD option repeat steps 1 to 7 except use the adjacent channel frequency of +/- 7.5MHz and 12.5MHz using the 3.84Mcps RRC filter..

#### 5.5.2.2.5 Test requirements

##### 5.5.2.2.5.1 3,84 Mcps TDD Option

The ACLR calculated in steps 3) and 4) of clause 5.5.2.2.4.2 shall be equal or greater than the limits given in table 5.5.2.2.5.1 for the 3,84 Mcps TDD Option.

**Table 5.5.2.2.5.1: UE ACLR (3,84 Mcps TDD Option)**

Power Class	Adjacent channel	ACLR limit
2, 3	UE-channel ± 5 MHz	32.2 dB
2, 3	UE-Channel ± 10 MHz	42.2 dB

NOTE: If the above Test Requirement differs from the Minimum Requirement then the Test Tolerance applied for this test is non-zero. The Test Tolerance for this test is defined in annex F clause F.2 and the explanation of how the Minimum Requirement has been relaxed by the Test Tolerance is given in annex F.

##### 5.5.2.2.5.2 1,28 Mcps TDD Option

The ACLR calculated in steps 3) and 4) of clause 5.5.2.2.4.2 shall be equal or greater than the limits given in table 5.5.2.2.5.2 for the 1,28 Mcps TDD Option.

**Table 5.5.2.2.5.2: UE ACLR (1,28 Mcps TDD Option)**

Power Class	Adjacent channel	ACLR limit
2, 3	UE-channel $\pm 1.6$ MHz	32.2 dB
2, 3	UE-Channel $\pm 3.2$ MHz	42.2 dB

NOTE: If the above Test Requirement differs from the Minimum Requirement then the Test Tolerance applied for this test is non-zero. The Test Tolerance for this test is defined in annex F clause F.2 and the explanation of how the Minimum Requirement has been relaxed by the Test Tolerance is given in annex F.

#### 5.5.2.2.5.3 7,68 Mcps TDD Option

The ACLR calculated in steps 3) and 4) of clause 5.5.2.2.4.2 shall be equal or greater than the limits given in table 5.5.2.2.5.3 for the 7,68 Mcps TDD Option.

**Table 5.5.2.2.5.3: UE ACLR (7,68 Mcps TDD Option)**

Power Class	adjacent channel	Chip Rate for RRC Measurement Filter	ACLR limit
2, 3	UE channel $\pm 7.5$ MHz	3.84 MHz	32.8 dB
2, 3	UE channel $\pm 12.5$ MHz	3.84 MHz	42.2 dB
2,3	UE channel $\pm 10.0$ MHz	7.68 MHz	32.8 dB
2,3	UE channel $\pm 20.0$ MHz	7.68 MHz	42.2 dB

NOTE: If the above Test Requirement differs from the Minimum Requirement then the Test Tolerance applied for this test is non-zero. The Test Tolerance for this test is defined in annex F clause F.2 and the explanation of how the Minimum Requirement has been relaxed by the Test Tolerance is given in annex F.

### 5.5.2.2A Adjacent Channel Leakage power Ratio (ACLR) with E-DCH

#### 5.5.2.2A.1 Definition and applicability

Adjacent Channel Leakage power Ratio (ACLR) is the ratio of the RRC filtered mean power centered on the assigned channel frequency to the RRC filtered mean power centered on an adjacent channel frequency.

The requirements in this clause shall apply for Release 7 and later releases to all types of UTRA-UE that support HSUPA.

#### 5.5.2.2A.2 Minimum Requirements

##### 5.5.2.2A.2.1 3,84Mcps TDD Option

[FFS]

##### 5.5.2.2A.2.2 1,28Mcps TDD Option

If the adjacent channel RRC filtered mean power is greater than  $-55$  dBm then the ACLR shall be better than the value specified in table 5.5.2.2A.2.2.a.

The normative reference for this requirement is TS 25.102 [1] clause 6.6.2.2.1.2.

**Table 5.5.2.2A.2.2a: UE ACLR (1,28Mcps TDD Option)**

Power Class	adjacent channel	ACLR limit
2, 3	UE channel $\pm$ 1.6 MHz	33 dB
2, 3	UE channel $\pm$ 3.2 MHz	43 dB

NOTE 1: The requirement shall still be met in the presence of switching transients.

NOTE 2: The ACLR requirements reflect what can be achieved with present state of the art technology.

NOTE 3: Requirement on the UE shall be reconsidered when the state of the art technology progresses.

#### 5.5.2.2A.2.3 7,68Mcps TDD Option

[FFS]

#### 5.5.2.2A.3 Test purpose

The test purpose is to verify the ability of the UE to limit the interference produced by the transmitted signal to other UTRA receivers operating at the first or second adjacent RF channel.

#### 5.5.2.2A.4 Method of test

##### 5.5.2.2A.4.1 Initial conditions

Test environment: normal, TL/VL, TL/VH, TH/VL, TH/VH; see clauses G.2.1 and G.2.2.

Frequencies to be tested: low range, mid range, high range; see clause G.2.4.

- 1) Connect the SS to the UE antenna connector as shown in figure A.1.
- 2) The Reference Measurement Channels(FRC3,16QAM) are specified C.6.1.2.3
- 3) A HSUPA call is set up according to TS 34.108[3] clause 7.3.9.
- 4) Enter the UE into loopback test mode in the presence of HSUPA and start the loopback test.

##### 5.5.2.2A.4.2 Procedure

- 1) Measure the RRC filtered mean power centered on the assigned channel frequency.
- 2) Measure RRC filtered mean power centered on the first lower adjacent channel frequency.
- 3) Calculate the ACLR by dividing the power measured in 1) by the power measured in 2).
- 4) Repeat steps 2) and 3) for the second lower adjacent RF channel.
- 7) Run step 1) to 4) for RF channels Low/Mid/High.

#### 5.5.2.2A.5 Test requirements

##### 5.5.2.2A.5.1 3,84 Mcps TDD Option

[FFS]

##### 5.5.2.2A.5.2 1,28 Mcps TDD Option

The ACLR calculated in steps 3) and 4) of clause 5.5.2.2A.4.2 shall be equal or greater than the limits given in table 5.5.2.2A.5.2a for the 1,28 Mcps TDD Option.

**Table 5.5.2.2A.5.2a: UE ACLR (1,28 Mcps TDD Option)**

Power Class	Adjacent channel	ACLR limit
2, 3	UE-channel ± 1.6 MHz	32.2 dB
2, 3	UE-Channel ± 3.2 MHz	42.2 dB

NOTE: If the above Test Requirement differs from the Minimum Requirement then the Test Tolerance applied for this test is non-zero. The Test Tolerance for this test is defined in annex F clause F.2 and the explanation of how the Minimum Requirement has been relaxed by the Test Tolerance is given in annex F.

#### 5.5.2.2A.5.3 7,68 Mcps TDD Option

[FFS]

### 5.5.2.2B Adjacent Channel Leakage power Ratio (ACLR) with HS-SICH and DPCH

#### 5.5.2.2B.1 Definition and applicability

Adjacent Channel Leakage power Ratio (ACLR) is the ratio of the RRC filtered mean power centered on the assigned channel frequency to the RRC filtered mean power centered on an adjacent channel frequency.

The requirements in this clause shall apply for Release 5 and later releases to all types of UTRA-UE that support HSDPA.

#### 5.5.2.2B.2 Minimum Requirements

##### 5.5.2.2B.2.1 3,84Mcps TDD Option

[FFS]

##### 5.5.2.2B.2.2 1,28Mcps TDD Option

If the adjacent channel RRC filtered mean power is greater than  $-55$  dBm then the ACLR shall be better than the value specified in table 5.5.2.2B.2.2.b.

The normative reference for this requirement is TS 25.102 [1] clause 6.6.2.2.1.2.

**Table 5.5.2.2B.2.2b: UE ACLR (1,28Mcps TDD Option)**

Power Class	adjacent channel	ACLR limit
2, 3	UE channel ± 1.6 MHz	33 dB
2, 3	UE channel ± 3.2 MHz	43 dB

NOTE 1: The requirement shall still be met in the presence of switching transients.

NOTE 2: The ACLR requirements reflect what can be achieved with present state of the art technology.

NOTE 3: Requirement on the UE shall be reconsidered when the state of the art technology progresses.

##### 5.5.2.2B.2.3 7,68Mcps TDD Option

[FFS]

#### 5.5.2.2B.3 Test purpose

The test purpose is to verify the ability of the UE to limit the interference produced by the transmitted signal to other UTRA receivers operating at the first or second adjacent RF channel.

#### 5.5.2.2B.4 Method of test

##### 5.5.2.2B.4.1 Initial conditions

Test environment: normal, TL/VL, TL/VH, TH/VL, TH/VH; see clauses G.2.1 and G.2.2.

Frequencies to be tested: low range, mid range, high range; see clause G.2.4.

- 1) Connect the SS to the UE antenna connector as shown in figure A.1.
- 2) The Reference Measurement Channels are specified C.2.2.2a.
- 3) A HSDPA call is set up according to TS 34.108[3] clause 7.3.6.3.
- 4) Enter the UE into loopback test mode in the presence of HSDPA and start the loopback test.

##### 5.5.2.2B.4.2 Procedure

- 1) Measure the RRC filtered mean power centered on the assigned channel frequency.
- 2) Measure RRC filtered mean power centered on the first lower adjacent channel frequency.
- 3) Calculate the ACLR by dividing the power measured in 1) by the power measured in 2).
- 4) Repeat steps 2) and 3) for the second lower adjacent RF channel.
- 7) Run step 1) to 4) for RF channels Low/Mid/High.

#### 5.5.2.2B.5 Test requirements

##### 5.5.2.2B.5.1 3,84 Mcps TDD Option

[FFS]

##### 5.5.2.2B.5.2 1,28 Mcps TDD Option

The ACLR calculated in steps 3) and 4) of clause 5.5.2.2B.4.2 shall be equal or greater than the limits given in table 5.5.2.2B.5.2b for the 1,28 Mcps TDD Option.

**Table 5.5.2.2B.5.2b: UE ACLR (1,28 Mcps TDD Option)**

Power Class	Adjacent channel	ACLR limit
2, 3	UE-channel $\pm 1.6$ MHz	32.2 dB
2, 3	UE-Channel $\pm 3.2$ MHz	42.2 dB

NOTE: If the above Test Requirement differs from the Minimum Requirement then the Test Tolerance applied for this test is non-zero. The Test Tolerance for this test is defined in annex F clause F.2 and the explanation of how the Minimum Requirement has been relaxed by the Test Tolerance is given in annex F.

##### 5.5.2.2B.5.3 7,68 Mcps TDD Option

[FFS]

### 5.5.3 Spurious emissions

#### 5.5.3.1 Definition and applicability

Spurious emissions are emissions which are caused by unwanted transmitter effects such as harmonics emission, parasitic emission, intermodulation products and frequency conversion products, but exclude out of band emissions.

The frequency boundary and the detailed transitions of the limits between the requirement for out band emissions and spectrum emissions are based on ITU-R Recommendations SM.329 [8].

The requirements and this test apply to all types of 1.28 Mcps TDD UE.

### 5.5.3.2 Minimum Requirements

#### 5.5.3.2.1 3,84 Mcps TDD Option

These requirements are only applicable for frequencies which are greater than 12.5 MHz away from the UE center carrier frequency.

The normative reference for this requirement is TS 25.102 [1] clause 6.6.3.1.1.

**Table 5.5.3.2.1a: General Spurious emissions requirements (3,84 Mcps TDD Option)**

Frequency Bandwidth	Resolution Bandwidth	Minimum requirement
$9 \text{ kHz} \leq f < 150 \text{ kHz}$	1 kHz	-36 dBm
$150 \text{ kHz} \leq f < 30 \text{ MHz}$	10 kHz	-36 dBm
$30 \text{ MHz} \leq f < 1000 \text{ MHz}$	100 kHz	-36 dBm
$1 \text{ GHz} \leq f < 12.75 \text{ GHz}$	1 MHz	-30 dBm

**Table 5.5.3.2.1b: Additional Spurious emissions requirements (3,84 Mcps TDD Option)**

Frequency Bandwidth	Resolution Bandwidth	Minimum requirement
$925 \text{ MHz} \leq f \leq 935 \text{ MHz}$	100 kHz	-67 dBm*
$935 \text{ MHz} < f \leq 960 \text{ MHz}$	100 kHz	-79 dBm*
$1805 \text{ MHz} \leq f \leq 1880 \text{ MHz}$	100 kHz	-71 dBm*
$1884.5 \text{ MHz} \leq f \leq 1919.6 \text{ MHz}$	300kHz	-41 dBm**

NOTE: The measurements are made on frequencies which are integer multiples of 200 kHz. As exceptions, up to five measurements with a level up to the applicable requirements defined in table 5.5.3.2.1a are permitted for each UARFCN used in the measurement.

\*\* Applicable for transmission in 2010-2025 MHz as defined in subclause 4.2 (a).

#### 5.5.3.2.2 1,28Mcps TDD Option

These requirements are only applicable for frequencies which are greater than 4 MHz away from the UE center carrier frequency.

The normative reference for this requirement is TS 25.102 [1] clause 6.6.3.1.2.

**Table 5.5.3.2.2a : General Spurious emissions requirements (1,28 Mcps TDD Option)**

Frequency Bandwidth	Resolution Bandwidth	Minimum requirement
$9 \text{ kHz} \leq f < 150 \text{ kHz}$	1 kHz	-36 dBm
$150 \text{ kHz} \leq f < 30 \text{ MHz}$	10 kHz	-36 dBm
$30 \text{ MHz} \leq f < 1000 \text{ MHz}$	100 kHz	-36 dBm
$1 \text{ GHz} \leq f < 12.75 \text{ GHz}$	1 MHz	-30 dBm



**Table 5.5.3.2.2b : Additional Spurious emissions requirements (1,28 Mcps TDD Option)**

Operating Band	Frequency Bandwidth	Measurement Bandwidth	Minimum requirement
a	$921 \text{ MHz} \leq f < 925 \text{ MHz}$	100 kHz	-60 dBm (note1)
	$925 \text{ MHz} \leq f \leq 935 \text{ MHz}$	100 kHz	-67 dBm (note1)
	$935 \text{ MHz} < f \leq 960 \text{ MHz}$	100 kHz	-79 dBm (note1)
	$1805 \text{ MHz} \leq f \leq 1880 \text{ MHz}$	100 kHz	-71 dBm (note1)
	$2010 \text{ MHz} \leq f \leq 2025 \text{ MHz}$	1MHz	-65 dBm (Note2)
	$1900 \text{ MHz} \leq f \leq 1920 \text{ MHz}$	1MHz	-65 dBm (Note 3)
b	$1850 \text{ MHz} \leq f \leq 1910 \text{ MHz}$	1 MHz	-65 dBm (Note 4)
	$1930 \text{ MHz} \leq f \leq 1990 \text{ MHz}$	1 MHz	-65 dBm (Note 5)
	$2010 \text{ MHz} \leq f \leq 2025 \text{ MHz}$	1MHz	-65 dBm
c	$2010 \text{ MHz} \leq f \leq 2025 \text{ MHz}$	1 MHz	-65 dBm
d	$1900 \text{ MHz} \leq f \leq 1920 \text{ MHz}$	1 MHz	-65 dBm
	$2010 \text{ MHz} \leq f \leq 2025 \text{ MHz}$	1 MHz	-65 dBm
	$2620 \text{ MHz} \leq f \leq 2690 \text{ MHz}$	3.84 MHz	-37 dBm
e	$921 \text{ MHz} \leq f < 925 \text{ MHz}$	100 kHz	-60 dBm (note1)
	$925 \text{ MHz} \leq f \leq 935 \text{ MHz}$	100 kHz	-67 dBm (note1)
	$935 \text{ MHz} < f \leq 960 \text{ MHz}$	100 kHz	-79 dBm (note1)
	$1805 \text{ MHz} \leq f \leq 1880 \text{ MHz}$	100 kHz	-71 dBm (note1)
	$1900 \text{ MHz} \leq f \leq 1920 \text{ MHz}$	1 MHz	-65 dBm
	$2010 \text{ MHz} \leq f \leq 2025 \text{ MHz}$	1 MHz	-65 dBm
f	$921 \text{ MHz} \leq f < 925 \text{ MHz}$	100 kHz	-60 dBm (note1)
	$925 \text{ MHz} < f < 935 \text{ MHz}$	100 kHz	-67 dBm (note1)
	$935 \text{ MHz} < f < 960 \text{ MHz}$	100 kHz	-79 dBm (note1)
	$1805 \text{ MHz} \leq f \leq 1850 \text{ MHz}$	100 kHz	-71 dBm (note1)
	$2010 \text{ MHz} \leq f \leq 2025 \text{ MHz}$	1MHz	-65 dBm
	$2300 \text{ MHz} \leq f \leq 2400 \text{ MHz}$	1MHz	-65 dBm

Note 1: The measurements are made on frequencies which are integer multiples of 200 kHz. As exceptions, up to five measurements with a level up to the applicable requirements defined in Table 6.7c are permitted for each UARFCN used in the measurement.

Note 2: This requirement is only applicable when UE operating in 1900-1920MHz of band a.

Note 3: This requirement is only applicable when UE operating in 2010-2025MHz of band a.

Note 4: This requirement is only applicable when UE operating in 1930-1990MHz of band b.

Note 5: This requirement is only applicable when UE operating in 1850-1910MHz of band b.

### 5.5.3.2.3 7,68 Mcps TDD Option

These requirements are only applicable for frequencies which are greater than 25 MHz away from the UE center carrier frequency.

The normative reference for this requirement is TS 25.102 [1] clause 6.6.3.1.3.

**Table 5.5.3.2.3a: General Spurious emissions requirements (7,68 Mcps TDD Option)**

Frequency Bandwidth	Measurement Bandwidth	Minimum requirement
$9 \text{ kHz} \leq f < 150 \text{ kHz}$	1 kHz	-36 dBm
$150 \text{ kHz} \leq f < 30 \text{ MHz}$	10 kHz	-36 dBm
$30 \text{ MHz} \leq f < 1000 \text{ MHz}$	100 kHz	-36 dBm
$1 \text{ GHz} \leq f < 12.75 \text{ GHz}$	1 MHz	-30 dBm

**Table 5.5.3.2.3b: Additional Spurious emissions requirements (7,68 Mcps TDD Option)**

Frequency Bandwidth	Measurement Bandwidth	Minimum requirement
$921 \text{ MHz} \leq f < 925 \text{ MHz}$	100 kHz	-60 dBm (note 1)
$925 \text{ MHz} \leq f \leq 935 \text{ MHz}$	100 kHz	-67 dBm (note 1)
$935 \text{ MHz} < f \leq 960 \text{ MHz}$	100 kHz	-79 dBm (note 1)
$1805 \text{ MHz} \leq f \leq 1880 \text{ MHz}$	100 kHz	-71 dBm (note 1)
$2620 \text{ MHz} \leq f \leq 2690 \text{ MHz}$	3.84 MHz	-37 dBm (note 1)
$1884.5 \text{ MHz} \leq f \leq 1919.6 \text{ MHz}$	300 kHz	-41 dBm (note 2)
NOTE 1: The measurements are made on frequencies which are integer multiples of 200 kHz. As exceptions, up to five measurements with a level up to the applicable requirements defined in Table 6.7E are permitted for each UARFCN used in the measurement.		
NOTE 2: Applicable for transmission in 2010-2025 MHz as defined in subclause 4.2 (a).		

NOTE: The measurements are made on frequencies which are integer multiples of 200 kHz. As exceptions, up to five measurements with a level up to the applicable requirements defined in table 5.5.3.2.3a are permitted for each UARFCN used in the measurement.

### 5.5.3.3 Test purpose

#### 5.5.3.3.1 3,84 Mcps Option

The test purpose is to verify the ability of the UE to limit the interference caused by unwanted transmitter effects to other systems operating at frequencies which are more than 12,5 MHz away from of the UE's carrier frequency.

#### 5.5.3.3.2 1,28 Mcps Option

The test purpose is to verify the ability of the UE to limit the interference caused by unwanted transmitter effects to other systems operating at frequencies which are more than 4 MHz away from of the UE's carrier frequency.

#### 5.5.3.3.3 7,68 Mcps Option

The test purpose is to verify the ability of the UE to limit the interference caused by unwanted transmitter effects to other systems operating at frequencies which are more than 25 MHz away from of the UE's carrier frequency.

### 5.5.3.4 Method of test

#### 5.5.3.4.1 Initial conditions

Test environment: normal; see clauses G.2.1 and G.2.2.

Frequencies to be tested: low range, mid range, high range; see clause G.2.4.

- 1) Connect the SS to the UE antenna connector as shown in figure A.1.
- 2) A call is set up according to the generic call setup procedure using parameters as specified in table E.3.1.2.
- 3) Enter the UE into loopback test mode and start the loopback test.

#### 5.5.3.4.2 Procedure

Measure the power of the spurious emissions applying measurement filters with bandwidths as specified in the relevant tables of 5.5.3.2.1 for 3,84 Mcps TDD Option, tables 5.5.3.2.2 for 1,28 Mcps TDD Option and tables 5.5.3.2.3 for 7,68 Mcps TDD option, respectively. The characteristic of the filters shall be approximately Gaussian (typical spectrum analyzer filters). The center frequency of the filter shall be swept over the frequency bands as given in the tables. The sweep time shall be sufficiently low to capture the active time slots.

### 5.5.3.5 Test requirements

#### 5.5.3.5.1 3,84 Mcps TDD Option

The spurious emissions measured according to clause 5.5.3.4.2 shall not exceed the limits specified in the relevant tables of 5.5.3.5.1a and 5.5.3.5.1b.

**Table 5.5.3.5.1a: General Spurious emissions requirements**

Frequency Bandwidth	Resolution Bandwidth	Test requirement
$9 \text{ kHz} \leq f < 150 \text{ kHz}$	1 kHz	-36 dBm
$150 \text{ kHz} \leq f < 30 \text{ MHz}$	10 kHz	-36 dBm
$30 \text{ MHz} \leq f < 1000 \text{ MHz}$	100 kHz	-36 dBm
$1 \text{ GHz} \leq f < 12.75 \text{ GHz}$	1 MHz	-30 dBm

**Table 5.5.3.5.1b: Additional Spurious emissions requirements**

Frequency Bandwidth	Resolution Bandwidth	Test requirement
$925 \text{ MHz} \leq f \leq 935 \text{ MHz}$	100 kHz	-67 dBm*
$935 \text{ MHz} < f \leq 960 \text{ MHz}$	100 kHz	-79 dBm*
$1805 \text{ MHz} \leq f \leq 1880 \text{ MHz}$	100 kHz	-71 dBm*
$1884.5 \text{ MHz} \leq f \leq 1919.6 \text{ MHz}$	300 kHz	-41 dBm**

NOTE 1: The measurements are made on frequencies which are integer multiples of 200 kHz. As exceptions, up to five measurements with a level up to the applicable requirements defined in table 5.5.3.5.1a for the 3,84 Mcps TDD Option are permitted for each UARFCN used in the measurement.

NOTE 2: If the above Test Requirement differs from the Minimum Requirement then the Test Tolerance applied for this test is non-zero. The Test Tolerance for this test is defined in annex F clause F.2 and the explanation of how the Minimum Requirement has been relaxed by the Test Tolerance is given in annex F clause F.4.

\*\* Applicable for transmission in 2010-2025 MHz as defined in subclause 4.2 (a).

#### 5.5.3.5.2 1,28 Mcps TDD Option

The spurious emissions measured according to clause 5.5.3.4.2 shall not exceed the limits specified in the relevant tables of 5.5.3.5.2a and 5.5.3.5.2b.

**Table 5.5.3.5.2a: General Spurious emissions requirements (1,28 Mcps TDD Option)**

Frequency Bandwidth	Resolution Bandwidth	Test requirement
$9 \text{ kHz} \leq f < 150 \text{ kHz}$	1 kHz	-36 dBm
$150 \text{ kHz} \leq f < 30 \text{ MHz}$	10 kHz	-36 dBm
$30 \text{ MHz} \leq f < 1000 \text{ MHz}$	100 kHz	-36 dBm
$1 \text{ GHz} \leq f < 12.75 \text{ GHz}$	1 MHz	-30 dBm

**Table 5.5.3.5.2b: Additional Spurious emissions requirements (1,28 Mcps TDD Option)**

Operating Band	Frequency Bandwidth	Measurement Bandwidth	Minimum requirement
a	$921 \text{ MHz} \leq f < 925 \text{ MHz}$	100 kHz	-60 dBm (note1)
	$925 \text{ MHz} \leq f \leq 935 \text{ MHz}$	100 kHz	-67 dBm (note1)
	$935 \text{ MHz} < f \leq 960 \text{ MHz}$	100 kHz	-79 dBm (note1)
	$1805 \text{ MHz} \leq f \leq 1880 \text{ MHz}$	100 kHz	-71 dBm (note1)
	$2010 \text{ MHz} \leq f \leq 2025 \text{ MHz}$	1MHz	-65 dBm (Note2)
	$1900 \text{ MHz} \leq f \leq 1920 \text{ MHz}$	1MHz	-65 dBm (Note 3)
b	$1850 \text{ MHz} \leq f \leq 1910 \text{ MHz}$	1 MHz	-65 dBm (Note 4)
	$1930 \text{ MHz} \leq f \leq 1990 \text{ MHz}$	1 MHz	-65 dBm (Note 5)
	$2010 \text{ MHz} \leq f \leq 2025 \text{ MHz}$	1MHz	-65 dBm
c	$2010 \text{ MHz} \leq f \leq 2025 \text{ MHz}$	1 MHz	-65 dBm
d	$1900 \text{ MHz} \leq f \leq 1920 \text{ MHz}$	1 MHz	-65 dBm
	$2010 \text{ MHz} \leq f \leq 2025 \text{ MHz}$	1 MHz	-65 dBm
	$2620 \text{ MHz} \leq f \leq 2690 \text{ MHz}$	3.84 MHz	-37 dBm
e	$921 \text{ MHz} \leq f < 925 \text{ MHz}$	100 kHz	-60 dBm (note1)
	$925 \text{ MHz} \leq f \leq 935 \text{ MHz}$	100 kHz	-67 dBm (note1)
	$935 \text{ MHz} < f \leq 960 \text{ MHz}$	100 kHz	-79 dBm (note1)
	$1805 \text{ MHz} \leq f \leq 1880 \text{ MHz}$	100 kHz	-71 dBm (note1)
	$1900 \text{ MHz} \leq f \leq 1920 \text{ MHz}$	1 MHz	-65 dBm
	$2010 \text{ MHz} \leq f \leq 2025 \text{ MHz}$	1 MHz	-65 dBm
f	$921 \text{ MHz} \leq f < 925 \text{ MHz}$	100 kHz	-60 dBm (note1)
	$925 \text{ MHz} < f < 935 \text{ MHz}$	100 kHz	-67 dBm (note1)
	$935 \text{ MHz} < f < 960 \text{ MHz}$	100 kHz	-79 dBm (note1)
	$1805 \text{ MHz} \leq f \leq 1850 \text{ MHz}$	100 kHz	-71 dBm (note1)
	$2010 \text{ MHz} \leq f \leq 2025 \text{ MHz}$	1MHz	-65 dBm
	$2300 \text{ MHz} \leq f \leq 2400 \text{ MHz}$	1MHz	-65 dBm

Note 1: The measurements are made on frequencies which are integer multiples of 200 kHz. As exceptions, up to five measurements with a level up to the applicable requirements defined in Table 6.7c are permitted for each UARFCN used in the measurement.

Note 2: This requirement is only applicable when UE operating in 1900-1920MHz of band a.

Note 3: This requirement is only applicable when UE operating in 2010-2025MHz of band a.

Note 4: This requirement is only applicable when UE operating in 1930-1990MHz of band b.

Note 5: This requirement is only applicable when UE operating in 1850-1910MHz of band b.

NOTE 1: If the above Test Requirement differs from the Minimum Requirement then the Test Tolerance applied for this test is non-zero. The Test Tolerance for this test is defined in annex F clause F.2 and the explanation of how the Minimum Requirement has been relaxed by the Test Tolerance is given in annex F clause F.4.

### 5.5.3.5.3 7,68 Mcps TDD Option

The spurious emissions measured according to clause 5.5.3.4.2 shall not exceed the limits specified in the relevant tables of 5.5.3.5.3a and 5.5.3.5.3b.

**Table 5.5.3.5.3a: General Spurious emissions requirements**

Frequency Bandwidth	Measurement Bandwidth	Minimum requirement
$9 \text{ kHz} \leq f < 150 \text{ kHz}$	1 kHz	-36 dBm
$150 \text{ kHz} \leq f < 30 \text{ MHz}$	10 kHz	-36 dBm
$30 \text{ MHz} \leq f < 1000 \text{ MHz}$	100 kHz	-36 dBm
$1 \text{ GHz} \leq f < 12.75 \text{ GHz}$	1 MHz	-30 dBm

**Table 5.5.3.5.3b: Additional Spurious emissions requirements**

Frequency Bandwidth	Measurement Bandwidth	Minimum requirement
$921 \text{ MHz} \leq f < 925 \text{ MHz}$	100 kHz	-60 dBm (note 1)
$925 \text{ MHz} \leq f \leq 935 \text{ MHz}$	100 kHz	-67 dBm (note 1)
$935 \text{ MHz} < f \leq 960 \text{ MHz}$	100 kHz	-79 dBm (note 1)
$1805 \text{ MHz} \leq f \leq 1880 \text{ MHz}$	100 kHz	-71 dBm (note 1)
$2620 \text{ MHz} \leq f \leq 2690 \text{ MHz}$	3.84 MHz	-37 dBm (note 1)
$1884.5 \text{ MHz} \leq f \leq 1919.6 \text{ MHz}$	300 kHz	-41 dBm (note 2)
NOTE 1: The measurements are made on frequencies which are integer multiples of 200 kHz. As exceptions, up to five measurements with a level up to the applicable requirements defined in Table 6.7E are permitted for each UARFCN used in the measurement.		
NOTE 2: Applicable for transmission in 2010-2025 MHz as defined in subclause 4.2 (a).		

NOTE: The measurements are made on frequencies which are integer multiples of 200 kHz. As exceptions, up to five measurements with a level up to the applicable requirements defined in table 5.5.3.5.3a are permitted for each UARFCN used in the measurement.

NOTE 2: If the above Test Requirement differs from the Minimum Requirement then the Test Tolerance applied for this test is non-zero. The Test Tolerance for this test is defined in annex F clause F.2 and the explanation of how the Minimum Requirement has been relaxed by the Test Tolerance is given in annex F clause F.4.

## 5.6 Transmit Intermodulation

### 5.6.1 Definition and applicability

The transmit intermodulation performance is a measure of the capability of the transmitter to inhibit the generation of signals in its non linear elements caused by the presence of the wanted signal and an interfering signal reaching the transmitter via the antenna.

User Equipment(s) transmitting in close vicinity of each other can produce intermodulation products, which can fall into the UE, or BS receive band as an unwanted interfering signal. The UE intermodulation attenuation is defined by the ratio of the RRC filtered mean power of the wanted signal to the RRC filtered mean power of the intermodulation product when an interfering CW signal is added at a level below the wanted signal.

The requirements of this test shall apply for all UTRA-UE.

### 5.6.2 Minimum Requirements

#### 5.6.2.1 3,84 Mcps TDD Option

The requirement of transmitting intermodulation for carrier spacing 5 MHz is prescribed in the table below.

The normative reference for this requirement is TS 25.102 [1] clause 6.7.1.1.

**Table 5.6.2.1: Transmit Intermodulation (3,84 Mcps TDD Option)**

Interference Signal Frequency Offset	5MHz	10MHz
Interference Signal Level	-40 dBc	
Interferer Modulation	CW Note: BS Test uses a CDMA modulated signal	
Minimum Requirement	-31dBc	-41dBc

#### 5.6.2.2 1,28 Mcps TDD Option

The requirement of transmitting intermodulation for carrier spacing 1,6 MHz is prescribed in table 5.6.2.2.

The normative reference for this requirement is TS 25.102 [1] clause 6.7.1.1.

**Table 5.6.2.2: Transmit Intermodulation (1,28 Mcps TDD Option)**

Interference Signal Frequency Offset	1.6 MHz	3.2 MHz
Interference Signal Level	-40 dBc	
Interferer Modulation	CW Note: BS Test uses a CDMA modulated signal	
Minimum Requirement	-31dBc	-41dBc

### 5.6.2.3 7,68 Mcps TDD Option

The requirement of transmitting intermodulation for carrier spacing 10 MHz is prescribed in the table 5.6.2.3.

The normative reference for this requirement is TS 25.102 [1] clause 6.7.1.3.

**Table 5.6.2.3: Transmit Intermodulation (7,68 Mcps TDD Option)**

Interference Signal Frequency Offset	10MHz	20MHz
Interference Signal Level	-40 dBc	
Interferer Modulation	CW Note: BS Test uses a CDMA modulated signal	
Minimum Requirement	-31dBc	-41dBc

## 5.6.3 Test purpose

User Equipment(s) transmitting in close vicinity of each other can produce intermodulation products, which can fall into other UE, or BS receive band as an unwanted interfering signal.

It is the purpose of this test to limit interferences to the own and other systems due to intermodulation products.

## 5.6.4 Method of test

### 5.6.4.1 Initial conditions

Test environment: normal; see clauses G.2.1 and G.2.2.

Frequencies to be tested: mid range; see clause G.2.4.

- 1) Connect the SS and the interferer to the UE antenna connector as shown in figure A.2.
- 2) A call is set up according to the generic call setup procedure using parameters as specified in table E.3.1.2.
- 3) Enter the UE into loopback test mode and start the loopback test.

Configure parameters of the interferer according to table 5.6.2.1 for 3,84 Mcps TDD Option, table 5.6.2.2 for 1,28 Mcps TDD Option and table 5.6.2.3 for 7,68 Mcps TDD Option, respectively.

### 5.6.4.2 Procedure

#### 5.6.4.2.1 3,84 Mcps TDD Option

- 1) Measure the unwanted emissions according to 5.6.2. in a carrier offset spacing of 5 MHz using an interferer +5MHz offset.

The frequency occupied by the interferer is excluded from the measurement.

- 2) Repeat 1) with the other 3 interferer-configurations (-5Mz, +10 MHz, -10 MHz).
- 3) Measure the wanted power according to annex B.
- 4) Display 1) and 2) in dBc with respect to 3).

#### 5.6.4.2.2 1,28 Mcps TDD Option

- 1) Measure the unwanted emissions according to 5.6.2.2 in a carrier offset spacing of 1.6 MHz using an interferer +1.6MHz offset.

The frequency occupied by the interferer is excluded from the measurement.

- 2) Repeat 1) with the other 3 interferer-configurations (-1.6 MHz, +3.2 MHz, -3.2 MHz).
- 3) Measure the wanted power according to annex B.
- 4) Display 1) and 2) in dBc with respect to 3).

#### 5.6.4.2.3 7,68 Mcps TDD Option

- 1) Measure the unwanted emissions according to 5.6.2.3 in a carrier offset spacing of 10 MHz using an interferer +10MHz offset.

The frequency occupied by the interferer is excluded from the measurement.

- 2) Repeat 1) with the other 3 interferer-configurations (-10MHz, +20 MHz, -20 MHz).
- 3) Measure the wanted power according to annex B.
- 4) Display 1) and 2) in dBc with respect to 3).

### 5.6.5 Test requirements

#### 5.6.5.1 3,84 Mcps TDD Option

The results in 4) from clause 5.6.4.2.1 shall not exceed the prescribed values in table 5.6.5.1.

**Table 5.6.5.1: Transmit Intermodulation (3,84 Mcps TDD Option)**

Interference Signal Frequency Offset	5MHz	10MHz
Interference Signal Level	-40 dBc	
Interferer Modulation	CW Note: BS Test uses a CDMA modulated signal	
Minimum Requirement	[-31+TT] dBc	[-41+TT] dBc

NOTE: If the above Test Requirement differs from the Minimum Requirement then the Test Tolerance applied for this test is non-zero. The Test Tolerance for this test is defined in annex F clause F.2 and the explanation of how the Minimum Requirement has been relaxed by the Test Tolerance is given in annex F clause F.4.

#### 5.6.5.2 1,28 Mcps TDD Option

The results in 4) from clause 5.6.4.2.2 shall not exceed the prescribed values in table 5.6.5.2.

**Table 5.6.5.2 : Transmit Intermodulation (1,28Mcps TDD Option)**

Interference signal frequency offset	1.6MHz	3.2MHz
Interference signal level	-40dBc	
Minimum requirement of intermodulation products	-31dBc	-41 dBc

NOTE: If the above Test Requirement differs from the Minimum Requirement then the Test Tolerance applied for this test is non-zero. The Test Tolerance for this test is defined in annex F clause F.2 and the explanation of how the Minimum Requirement has been relaxed by the Test Tolerance is given in annex F clause F.4.

### 5.6.5.3 7,68 Mcps TDD Option

The results in 4) from clause 5.6.4.2.3 shall not exceed the prescribed values in table 5.6.5.3.

**Table 5.6.5.3: Transmit Intermodulation (7,68 Mcps TDD Option)**

Interference Signal Frequency Offset	10MHz	20MHz
Interference Signal Level	-40 dBc	
Interferer Modulation	CW Note: BS Test uses a CDMA modulated signal	
Minimum Requirement	[-31+TT] dBc	[-41+TT] dBc

NOTE: If the above Test Requirement differs from the Minimum Requirement then the Test Tolerance applied for this test is non-zero. The Test Tolerance for this test is defined in annex F clause F.2 and the explanation of how the Minimum Requirement has been relaxed by the Test Tolerance is given in annex F clause F.4.

## 5.7 Transmit Modulation

### 5.7.1 Error Vector Magnitude

#### 5.7.1.1 Definition and applicability

The Error Vector Magnitude (EVM) is a measure of the difference between the measured waveform and the theoretical modulated waveform (the error vector). Both waveforms pass through a matched Root Raised Cosine filter with bandwidth corresponding to the considered chip rate and roll-off  $\alpha = 0,22$ . Both waveforms are then further modified by selecting the frequency, absolute phase, absolute amplitude and chip clock timing so as to minimise the error vector. The EVM result is defined as the square root of the ratio of the mean error vector power to the mean reference signal power expressed as a %. The measurement interval is one timeslot excluding the guard period.

The requirement of this clause shall apply to all types of UTRA-UE.

#### 5.7.1.2 Minimum Requirements

The Error Vector Magnitude shall not exceed 17,5 % for the parameters specified in table 5.7.1.2.

**Table 5.7.1.2.: Test parameters for Error Vector Magnitude/Peak Code Domain Error**

Parameter	Level	Unit
UE Output Power	$\geq -20$	dBm
Operating conditions	Normal conditions	
Power control step size	1	dB

The normative reference for this requirement is TS 25.102 [1] clause 6.8.2.1.

#### 5.7.1.3 Test purpose

The transmitter shall generate a sufficient precise waveform, to enable the receiver to achieve the specified receiver performances.

#### 5.7.1.4 Method of test

##### 5.7.1.4.1 Initial conditions

Test environment: normal, TL/VL, TL/VH, TH/VL, TH/VH, vibration; see clauses G.2.1, G.2.2 and G.2.3.

Frequencies to be tested: low range, mid range, high range; see clause G.2.4.

- 1) Connect the SS to the UE antenna connector as shown in figure A.1.
- 2) A call is set up according to the generic call setup procedure using parameters as specified in table E.3.1.2.



- 3) Enter the UE into loopback test mode and start the loopback test.

#### 5.7.1.4.2 Procedure

- 1) Starting from the initial conditions, measure EVM (Error Vector Magnitude) of the UE according to annex B.
- 2) Set SS-level and signalling values such that the power level of the UE is between  $-20$  and  $-19$  dBm.
- 3) Measure EVM of the UE according to annex B.

#### 5.7.1.5 Test requirements

The results in step 1) and 2) shall not exceed 17.5 % for parameters specified in table 5.7.1.2.

NOTE: If the above Test Requirement differs from the Minimum Requirement then the Test Tolerance applied for this test is non-zero. The Test Tolerance for this test is defined in annex F clause F.2 and the explanation of how the Minimum Requirement has been relaxed by the Test Tolerance is given in annex F clause F.4.

### 5.7.1A Error Vector Magnitude with E-DCH16QAM

#### 5.7.1A.1 Definition and applicability

The Error Vector Magnitude (EVM) is a measure of the difference between the measured waveform and the theoretical modulated waveform (the error vector). Both waveforms pass through a matched Root Raised Cosine filter with bandwidth corresponding to the considered chip rate and roll-off  $\alpha = 0,22$ . Both waveforms are then further modified by selecting the frequency, absolute phase, absolute amplitude and chip clock timing so as to minimise the error vector. The EVM result is defined as the square root of the ratio of the mean error vector power to the mean reference signal power expressed as a %. The measurement interval is one timeslot excluding the guard period.

The requirement of this clause shall apply to UTRA-UE which supports E-DCH with 16QAM.

#### 5.7.1A.2 Minimum Requirements

The Error Vector Magnitude shall not exceed 14 % for the parameters specified in table 5.7.1.2.

**Table 5.7.1.2A.: Test parameters for Error Vector Magnitude/Peak Code Domain Error**

Parameter	Level	Unit
UE Output Power	$\geq -20$	dBm
Operating conditions	Normal conditions	
Power control step size	1	dB

The normative reference for this requirement is TS 25.102 [1] clause 6.8.2.1.

#### 5.7.1A.3 Test purpose

The transmitter shall generate a sufficient precise waveform, to enable the receiver to achieve the specified receiver performances.

#### 5.7.1A.4 Method of test

##### 5.7.1A.4.1 Initial conditions

###### 5.7.1A.4.1.1 3.84Mcps TDD option

Void

###### 5.7.1A.4.1.2 1.28Mcps TDD option

Test environment: normal, TL/VL, TL/VH, TH/VL, TH/VH, vibration; see clauses G.2.1, G.2.2 and G.2.3.

Frequencies to be tested: low range, mid range, high range; see clause G.2.4.

- 1) Connect the SS to the UE antenna connector as shown in figure A.1.
- 2) The UL Reference Measurement Channel parameters are defined in Annex C.6.1.2 and DL Reference Measurement Channel parameters are defined in Annex C4.2.1.1
- 4) The value of TRRI shall be set to '11100' and CRR1 on E-AGCH shall be set to 1.
- 5) The value of PRRI is same. This ensures that the UL datarate remains constant.
- 6) The UE is switched on.
- 7) Enter the UE into loopback mode 1, looping back both the 12.2kbps RMC and HSDPA to E-DCH, and start the loopback test. See TS 34.108 [3] clause 7.3.9 and TS 34.109 [4] clauses 5.3.2.3 and 5.3.2.6. To fill the RLC transmit buffer, run the loopback for [3]s before starting the procedure.

#### 5.7.1A.4.1.3 7.68Mcps TDD option

Void

#### 5.7.1A.4.2 Procedure

##### 5.7.1A.4.2.1 3.84Mcps TDD Option

Void

##### 5.7.1A.4.2.2 1.28Mcps TDD Option

- 1) Starting from the initial conditions, measure EVM (Error Vector Magnitude) of the UE according to annex B.
- 2) Set SS level and signalling values such that the power level of the UE is between  $-20$  and  $-19$  dBm.
- 3) Measure EVM of the UE according to annex B.

##### 5.7.1A.4.2.3 7.68Mcps TDD Option

Void

#### 5.7.1A.5 Test requirements

The results in step 1) and 2) shall not exceed 14 % for parameters specified in table 5.7.1.2.

NOTE: If the above Test Requirement differs from the Minimum Requirement then the Test Tolerance applied for this test is non-zero. The Test Tolerance for this test is defined in annex F clause F.2 and the explanation of how the Minimum Requirement has been relaxed by the Test Tolerance is given in annex F clause F.4.

### 5.7.1B Error Vector Magnitude with HS-SICH and DPCH

#### 5.7.1B.1 Definition and applicability

The Error Vector Magnitude (EVM) is a measure of the difference between the measured waveform and the theoretical modulated waveform (the error vector). Both waveforms pass through a matched Root Raised Cosine filter with bandwidth corresponding to the considered chip rate and roll-off  $\alpha = 0,22$ . Both waveforms are then further modified by selecting the frequency, absolute phase, absolute amplitude and chip clock timing so as to minimise the error vector. The EVM result is defined as the square root of the ratio of the mean error vector power to the mean reference signal power expressed as a %. The measurement interval is one timeslot excluding the guard period.

The requirements and this test apply for Release 5 only to all types of UTRA for the TDD UE that support HSDPA.

#### 5.7.1B.2 Minimum Requirements

The Error Vector Magnitude shall not exceed 17,5 % for the parameters specified in table 5.7.1B.2b.

**Table 5.7.1B.2b.: Test parameters for Error Vector Magnitude/Peak Code Domain Error**

Parameter	Level	Unit
UE Output Power	$\geq -20$	dBm
Operating conditions	Normal conditions	
Power control step size	1	dB

The normative reference for this requirement is TS 25.102 [1] clause 6.8.2.1.

### 5.7.B1.3 Test purpose

The transmitter shall generate a sufficient precise waveform, to enable the receiver to achieve the specified receiver performances.

### 5.7.1B.4 Method of test

#### 5.7.1B.4.1 Initial conditions

Test environment: normal, TL/VL, TL/VH, TH/VL, TH/VH, vibration; see clauses G.2.1, G.2.2 and G.2.3.

Frequencies to be tested: low range, mid range, high range; see clause G.2.4.

- 1) Connect the SS (node B emulator) to the UE antenna connector as shown in figure A.1.
- 2) The Reference Measurement Channels are specified C.2.2.2a.
- 3) An HSDPA call is set up according to TS 34.108 [3] 7.3.6
- 4) Enter the UE into loopback test mode in the presence of HSDPA and start the loopback test.

See TS 34.108 [3] and TS 34.109 [4] for details regarding loopback test mode for HSDPA

#### 5.7.1B.4.2 Procedure

- 1) Starting from the initial conditions, measure EVM (Error Vector Magnitude) of the UE according to annex B.
- 2) Set SS-level and signalling values such that the power level of the UE is between  $-20$  and  $-19$  dBm.
- 3) Measure EVM of the UE according to annex B.

### 5.7.1B.5 Test requirements

The results in step 1) and 2) shall not exceed 17.5 % for parameters specified in table 5.7.1B.2b.

NOTE: If the above Test Requirement differs from the Minimum Requirement then the Test Tolerance applied for this test is non-zero. The Test Tolerance for this test is defined in annex F clause F.2 and the explanation of how the Minimum Requirement has been relaxed by the Test Tolerance is given in annex F clause F.4.

## 5.7.2 Peak code domain error

### 5.7.2.1 Definition and applicability

The code domain error is computed by projecting the error vector power onto the code domain at a specific spreading factor. The error power for each code is defined as the ratio to the mean power of the projection onto the code, to the mean power of the composite reference waveform expressed in dB. And the Peak Code Domain Error is defined as the maximum value for Code Domain Error. The measurement interval is one timeslot.

The present document is applicable for multi-code transmission only.

The requirement of this test applies to all UTRA-UE, applicable for multi-code transmission.

### 5.7.2.2 Minimum Requirement

The peak code domain error shall not exceed -21dB at spreading factor 16 for 3,84 Mcps TDD Option, and 1,28 Mcps TDD Option . The peak code domain error shall not exceed -24dB at spreading factor 32 for 7,68 Mcps TDD Option.

The normative reference for this requirement is TS 25.102 [1] clause 6.8.3.1.

### 5.7.2.3 Test purpose

It is the purpose of this test to limit crosstalk among codes.

### 5.7.2.4 Method of test

#### 5.7.2.4.1 Initial conditions

##### 5.7.2.4.1.1 3,84 Mcps TDD Option

Test environment: normal, TL/VL, TL/VH, TH/VL, TH/VH; see clauses G.2.1 and G.2.2.

Frequencies to be tested: low range, mid range, high range; see clause G.2.4.

- 1) Connect the SS to the UE antenna connector as shown in figure A.1.
- 2) A call is set up according to the generic call setup procedure using parameters as specified in table 5.7.2.4.1.1 for the 3,84 Mcps TDD Option.
- 3) Enter the UE into loopback test mode and start the loopback test.

**Table 5.7.2.4.1.1: Test parameters for Peak code Domain Error (3,84 Mcps TDD Option)**

Parameter	Value/description
Reference measurement channel	Multicode 12,2kbps, according to annex C.2.2.1
Uplink Power Control	SS level and signalling values such that UE transmits maximum power
Data content	real life (sufficient irregular)

##### 5.7.2.4.1.2 1,28 Mcps TDD Option

- 1) Connect the SS to the UE antenna connector as shown in figure A.1.
- 2) A call is set up according to the generic call setup procedure using parameters as specified in table 5.7.2.4.1.2 for the 1,28 Mcps TDD Option.
- 3) Enter the UE into loopback test mode and start the loopback test.

**Table 5.7.2.4.1.2: Test parameters for Peak code Domain Error (1,28 Mcps TDD Option)**

Parameter	Value/description
Reference measurement channel	Multicode 12,2kbps, according to annex C.2.2.2
Uplink Power Control	SS level and signalling values such that UE transmits maximum power
Data content	real life (sufficient irregular)

##### 5.7.2.4.1.3 7,68 Mcps TDD Option

Test environment: normal, TL/VL, TL/VH, TH/VL, TH/VH; see clauses G.2.1 and G.2.2.

Frequencies to be tested: low range, mid range, high range; see clause G.2.4.

- 1) Connect the SS to the UE antenna connector as shown in figure A.1.
- 2) A call is set up according to the generic call setup procedure using parameters as specified in table 5.7.2.4.1.3 for the 7,68 Mcps TDD Option.
- 3) Enter the UE into loopback test mode and start the loopback test.

**Table 5.7.2.4.1.3: Test parameters for Peak code Domain Error (7,68 Mcps TDD Option)**

Parameter	Value/description
Reference measurement channel	Multicode 12,2kbps, according to annex C.2.2.3
Uplink Power Control	SS level and signalling values such that UE transmits maximum power
Data content	real life (sufficient irregular)

#### 5.7.2.4.2 Procedure

- 1) Starting from the initial conditions, measure peak code error(PCDE)of the UE according to annex B.
- 2) Set SS-level and signalling values such that the power level of the UE is between –20 and –19 dBm.
- 3) Measure PCDE of the UE according to annex B.

#### 5.7.2.5 Test requirements

The results in step 1) and 2) shall not exceed -20 dB. for parameters specified in table 5.7.1.2 for 3,84 Mcps TDD Option, and 1,28 Mcps TDD Option.

The results in step 1) and 2) shall not exceed -23 dB. for parameters specified in table 5.7.1.2 for 7,68 Mcps TDD Option.

**NOTE:** If the above Test Requirement differs from the Minimum Requirement then the Test Tolerance applied for this test is non-zero. The Test Tolerance for this test is defined in annex F clause F.2 and the explanation of how the Minimum Requirement has been relaxed by the Test Tolerance is given in annex F clause F.4.

---

## 6 Receiver Characteristics

### 6.1 General

Receiving performance test of the UE is implemented during communicating with the SS via air interface. The procedure uses normal call protocol until the UE is communicating on traffic channel basically. (Refer to TS 34.108 [3] Common Test Environments for User Equipment (UE) Conformance Testing.) On the traffic channel, the UE provides special function for testing that is described in Logical Test Interface and the UE is tested using this function. (Refer to TS 34.109 [3] Logical Test Interface (FDD/TDD) Special conformance testing functions.)

Unless otherwise stated the receiver characteristics are specified at the antenna connector of the UE. For UE(s) with an integral antenna only, a reference antenna with a gain of 0 dBi is assumed. UE with an integral antenna may be taken into account by converting these power levels into field strength requirements, assuming a 0 dBi gain antenna. Receiver characteristics for UE(s) with multiple antennas/antenna connectors are for further study.

The UE antenna performance has a significant impact on system performance, and minimum requirements on the antenna efficiency are therefore intended to be included in future versions of the present document. It is recognized that different requirements and test methods are likely to be required for the different types of UE.

All the parameters in clause 6 are defined using the DL reference measurement channel (12,2 kbps) specified in clause C.3.3. For 3.84 Mcps TDD IMB, the DL reference measurement channel (28 kbps) specified in clause C.3.8 is used..

All Bit Error ratio (BER) measurements in clause 6 shall be performed according to the general rules for statistical testing in Annex F.6.

## 6.2 Reference sensitivity level

### 6.2.1 Definition and applicability

The reference sensitivity level is the minimum mean power received at the UE antenna connector at which the BER shall not exceed the specific value.

The requirements in this clause shall apply to all types of UTRA UE.

### 6.2.2 Minimum Requirements

#### 6.2.2.1 3,84 Mcps TDD Option

For the DL reference measurement channel 12,2 kBit/s specified in annex C, the BER shall not exceed 0.001 for the parameters specified in table 6.2.2.1.

**Table 6.2.2.1: Test parameters for reference sensitivity (3,84 Mcps TDD Option)**

Parameter	Level	Unit
$\frac{\Sigma DPCH\_Ec}{I_{or}}$	0	dB
$\hat{I}_{or}$	-105	dBm/3,84 MHz

The normative reference for this requirement is TS 25.102 [1] clause 7.3.1.1.

#### 6.2.2.2 1,28 Mcps TDD Option

The BER shall not exceed 0.001 for the parameters specified in table 6.2.2.2.

**Table 6.2.2.2: Test parameters for reference sensitivity (1,28 Mcps TDD Option)**

Parameter	Level	Unit
$\frac{\Sigma DPCH\_Ec}{I_{or}}$	0	dB
$\hat{I}_{or}$	-108	dBm/1,28 MHz

The normative reference for this requirement is TS 25.102 [1] clause 7.3.1.2.

#### 6.2.2.3 7,68 Mcps TDD Option

For the DL reference measurement channel 12,2 kBit/s specified in annex C.3.1.3, the BER shall not exceed 0.001 for the parameters specified in table 6.2.2.3.

**Table 6.2.2.3: Test parameters for reference sensitivity (7,68 Mcps TDD Option)**

Parameter	Level	Unit
$\frac{\Sigma DPCH\_Ec}{I_{or}}$	0	dB
$\hat{I}_{or}$	-105	dBm/7.68 MHz

The normative reference for this requirement is TS 25.102 [1] clause 7.3.1.3.

## 6.2.3 Test purpose

The test purpose is to verify the ability of the UE to receive a prescribed test signal at the lower end of the dynamic range under defined conditions (no interference, no multipath propagation) with a BER not exceeding a specified level. This test is also used as a reference case for other tests to allow the assessment of degradations due to various sources of interference.

## 6.2.4 Method of test

### 6.2.4.1 Initial conditions

Test environment: normal, TL/VL, TL/VH, TH/VL, TH/VH; see clauses G.2.1 and G.2.2.

Frequencies to be tested: low range, mid range, high range; see clause G.2.4.

- 1) Connect the SS to the UE antenna connector as shown in figure A.3.
- 2) A call is set up according to the Generic call setup procedure.
- 3) Enter the UE into loopback test mode and start the loopback test.
- 4) The level of SS output signal measured at the UE antenna connector shall be  $-105$  dBm for the 3,84 Mcps TDD Option and 7,68 Mcps TDD option and  $-108$  dBm for the 1,28 Mcps TDD Option, respectively.

### 6.2.4.2 Procedure

- 1) Measure the BER of DCH received from the UE at the SS.

## 6.2.5 Test requirements

### 6.2.5.1 3,84 Mcps TDD Option

The measured BER, derived in step 1), shall not exceed 0.001 under conditions described in table 6.2.5.1 for the 3,84 Mcps TDD Option.

**Table 6.2.5.1: Test parameters for reference sensitivity (3,84 Mcps TDD Option)**

Parameter	Level	Unit
$\frac{\Sigma DPCH_{Ec}}{I_{or}}$	0	dB
$\hat{I}_{or}$	-104.3	dBm/3,84 MHz

NOTE: If the above Test Requirement differs from the Minimum Requirement then the Test Tolerance applied for this test is non-zero. The Test Tolerance for this test is defined in annex F clause F.2 and the explanation of how the Minimum Requirement has been relaxed by the Test Tolerance is given in annex F clause F.4.

### 6.2.5.2 1,28 Mcps TDD Option

The measured BER, derived in step 1), shall not exceed 0.001 under conditions described in table 6.2.5.2 for the 1,28 Mcps TDD Option.

**Table 6.2.5.2: Test parameters for reference sensitivity (1,28 Mcps TDD Option)**

Parameter	Level	Unit
$\frac{\Sigma DPCH_{Ec}}{I_{or}}$	0	dB
$\hat{I}_{or}$	-107.3	dBm/1,28 MHz

NOTE: If the above Test Requirement differs from the Minimum Requirement then the Test Tolerance applied for this test is non-zero. The Test Tolerance for this test is defined in annex F clause F.2 and the explanation of how the Minimum Requirement has been relaxed by the Test Tolerance is given in annex F clause F.4.

### 6.2.5.3 7,68 Mcps TDD Option

The measured BER, derived in step 1), shall not exceed 0.001 under conditions described in table 6.2.5.3 for the 7,68 Mcps TDD Option.

**Table 6.2.5.3: Test parameters for reference sensitivity (7,68 Mcps TDD Option)**

Parameter	Level	Unit
$\frac{\Sigma DPCH_{Ec}}{I_{or}}$	0	dB
$\hat{I}_{or}$	-104.3	dBm/7,68 MHz

NOTE: If the above Test Requirement differs from the Minimum Requirement then the Test Tolerance applied for this test is non-zero. The Test Tolerance for this test is defined in annex F clause F.2 and the explanation of how the Minimum Requirement has been relaxed by the Test Tolerance is given in annex F clause F.4.

## 6.2A Reference sensitivity level (IMB)

### 6.2A.1 Definition and applicability

The reference sensitivity level is the minimum mean power received at the UE antenna connector at which the BLER shall not exceed the specific value.

The requirements in this clause shall apply to 3.84 Mcps TDD IMB UE.

### 6.2A.2 Minimum Requirements

The BLER shall not exceed 0.01 for the parameters specified in table 6.2A.2.1 for the DL reference measurement channel 28 kBit/s specified in annex C.



**Table 6.2A.2.1: Test parameters for reference sensitivity (3.84 Mcps TDD IMB)**

Parameter	Level	Unit
$\frac{\Sigma \text{DPCH\_Ec}}{I_{\text{or}}}$	-0.77	dB
$\hat{I}_{\text{or}}$	-105	dBm/3,84 MHz
NOTE: The term $\Sigma \text{DPCH\_Ec}$ refers to the sum of the energy of the physical channels comprising the IMB DL reference measurement channel.		

The normative reference for this requirement is TS 25.102 [1] clause 7.3.1.1.

## 6.2A.3 Test purpose

The test purpose is to verify the ability of the UE to receive a prescribed test signal at the lower end of the dynamic range under defined conditions (no interference, no multipath propagation) with a BLER not exceeding a specified level. This test is also used as a reference case for other tests to allow the assessment of degradations due to various sources of interference.

## 6.2A.4 Method of test

### 6.2A.4.1 Initial conditions

Test environment: normal, TL/VL, TL/VH, TH/VL, TH/VH; see clauses G.2.1 and G.2.2.

Frequencies to be tested: low range, mid range, high range; see clause G.2.4.

- 1) Connect the SS to the UE antenna connector as shown in figure A.3.
- 2) A call is set up according to the Generic call setup procedure.
- 3) Enter the UE into loopback mode 3 and start the loopback test. See TS 34.108 and TS 34.109 for details regarding loopback test mode 3 for MBMS.
- 4) The level of SS output signal measured at the UE antenna connector shall be -105 dBm.

### 6.2A.4.2 Procedure

- 1) SS shall start the test by sending data on the MTCH radio bearer and maintain the count of transmitted RLC SDU blocks on the MTCH.
- 2) SS shall send a "UE TEST LOOP MODE 3 RLC SDU COUNTER REQUEST" message and wait for the UE to response with a "UE TEST LOOP MODE 3 RLC SDU COUNTER RESPONSE" reporting the received RLC SDU counter value.
- 3) SS shall compute the RLC SDU error rate based on the transmitted RLC SDUs count and received RLC SDU count reported by the UE.
- 4) The test shall be run until the statistical significance according to Annex to F.6.1.8 is achieved.

## 6.2A.5 Test requirements

The computed BLER shall not exceed 0.01 under conditions described in table 6.2A.5.1.

**Table 6.2A.5.1: Test parameters for reference sensitivity (3,84 Mcps TDD Option)**

Parameter	Level	Unit
$\frac{\Sigma \text{DPCH\_Ec}}{I_{\text{or}}}$	-0.77	dB
$\hat{I}_{\text{or}}$	-104.3	dBm/3,84 MHz

NOTE: The term  $\Sigma \text{DPCH\_Ec}$  refers to the sum of the energy of the physical channels comprising the IMB DL reference measurement channel.

NOTE: If the above Test Requirement differs from the Minimum Requirement then the Test Tolerance applied for this test is non-zero. The Test Tolerance for this test is defined in annex F clause F.2 and the explanation of how the Minimum Requirement has been relaxed by the Test Tolerance is given in annex F clause F.4.

## 6.3 Maximum Input Level

### 6.3.1 Definition and applicability

The maximum input level is defined as the maximum mean power received at the UE antenna connector, which does not degrade the specified BER performance.

The requirements in this clause shall apply to all types of UTRA UE.

### 6.3.2 Minimum requirements

#### 6.3.2.1 3,84 Mcps TDD Option

The BER shall not exceed 0,001 for the parameters specified in table 6.3.2.1.

**Table 6.3.2.1: Maximum input level (3,84 Mcps TDD Option)**

Parameter	Level	Unit
$\frac{\Sigma \text{DPCH\_Ec}}{I_{\text{or}}}$	-7	dB
$\hat{I}_{\text{or}}$	-25	dBm/3,84 MHz

The reference for this requirement is TS 25.102 [1] clause 7.4.1.1.

#### 6.3.2.2 1,28 Mcps TDD Option

The BER shall not exceed 0.001 for the parameters specified in table 6.3.2.2.

**Table 6.3.2.2: Maximum input level (1,28Mcps TDD Option)**

Parameter	Level	Unit
$\frac{\Sigma \text{DPCH\_Ec}}{I_{\text{or}}}$	-7	dB
$\hat{I}_{\text{or}}$	-25	dBm/1,28 MHz

The reference for this requirement is TS 25.102 [1] clause 7.4.1.2.

### 6.3.2.3 7,68 Mcps TDD Option

The BER shall not exceed 0,001 for the parameters specified in table 6.3.2.3.

**Table 6.3.2.3: Maximum input level (7,68 Mcps TDD Option)**

Parameter	Level	Unit
$\frac{\Sigma \text{DPCH\_Ec}}{I_{\text{or}}}$	-10	dB
$\hat{I}_{\text{or}}$	-25	dBm/7,68 MHz

The reference for this requirement is TS 25.102 [1] clause 7.4.1.3.

### 6.3.3 Test purpose

The test purpose is to verify the ability of the UE to receive a prescribed test signal at the upper end of the dynamic range under defined conditions (no interference, no multipath propagation) with BER not exceeding a specified value.

### 6.3.4 Method of test

#### 6.3.4.1 Initial conditions

Test environment: normal; see clauses G.2.1 and G.2.2.

Frequencies to be tested: mid range; see clause G.2.4.

- 1) Connect the SS to the UE antenna connector as shown in figure A.3.
- 2) A call is set up according to the Generic call setup procedure.
- 3) Enter the UE into loopback test mode and start the loopback test.
- 4) The level of SS output signal measured at the UE antenna connector shall be according to table 6.3.2.1 (3,84 Mcps TDD Option), table 6.3.2.2(1,28 Mcps TDD Option) and table 6.3.2.3 (7,68 Mcps TDD Option), respectively.

#### 6.3.4.2 Procedure

Measure the BER of DCH received from the UE at the SS.

### 6.3.5 Test requirements

The measured BER, derived in step 1), shall not exceed 0,001.

## 6.3A Maximum Input Level for HS-PDSCH Reception (16QAM)

### 6.3A.1 Definition and applicability

Maximum input level for HS-PDSCH reception is defined as the maximum power received at the UE antenna port, which shall not degrade the specified HSDPA throughput performance. The requirements and this test apply to all types of 1.28Mcps TDD option UE that support HSDPA (16QAM).

### 6.3A.2 Minimum requirements

The throughput shall be  $\geq 90\%$  of the maximum throughput of the reference measurement channels as specified in Table 6.3A.2 for different UE categories with the parameters specified in Table 6.3A.1. Using this configuration the throughput shall meet or exceed 500kbps

The reference for this requirement is TS 25.102 [1] clause 7.4.2.

**Table 6.3A.1 Minimum requirement parameters for 16QAM Maximum Input Level**

Parameter	Unit	Value
$\frac{\sum HS - PDSCH - Ec}{I_{or}}$	dB	0
$\hat{I}_{or}$	dBm/1.28 MHz	-25
Redundancy and constellation version	-	6
Maximum number of HARQ transmissions	-	1

**Table 6.3A.2 Reference Measurement Channel for different UE Categories (16QAM)**

UE Category	Reference Channel
Category 4-6	C.4.2.2.2
Category 7-9	C.4.2.3.2
Category 10-12	C.4.2.4.2
Category 13-15	C.4.2.5.2

### 6.3A.3 Test purpose

To verify that the UE HSDPA throughput meets the minimum requirements for the DL reference channel specified in Table 6.3A.2 with the addition of the parameters specified in table 6.3A.1.

An inadequate maximum input level causes loss of coverage near the Node B.

### 6.3A.4 Method of test

#### 6.3A.4.1 Initial conditions

Test environment: normal; see clauses G.2.1 and G.2.2.

Frequencies to be tested: mid range; see clause G.2.4.

#### 6.3A.4.2 Procedure

Connect the SS to the UE antenna connector as shown in figure A.1.

- 1) The UE is switched on.
- 2) An RRC connection is set-up according to the generic HSDPA set-up procedure specified in TS 34.108 [3] and SS RF parameters are given in tables 6.3A.1.
- 3) Measure the HS-PDSCH throughput  $R$  received by the UE by counting the number of NACK, ACK and statDTX on the UL HS-SICH (Throughput = blocksize\*number of blocks acknowledged/time).
- 4) The UE is switched off.

### 6.3A.5 Test requirements

The throughput shall be  $\geq 90\%$  of the maximum throughput of the reference measurement channels as specified in Table 6.3A.2 for different UE categories with the parameters specified in Table 6.3A.1. The minimum number of measurements required for a statistically significant result to this test is clarified in annex F.6.3, Table F.6.3.5.1.

**NOTE:** If the above Test Requirement differs from the Minimum Requirement then the Test Tolerance applied for this test is non-zero. The Test Tolerance for this test is defined in clause F.2 and the explanation of how the Minimum Requirement has been relaxed by the Test Tolerance is given in clause F.4.

## 6.3B Maximum Input Level for HS-PDSCH Reception (64QAM)

### 6.3B.1 Definition and applicability

Maximum input level for HS-PDSCH reception is defined as the maximum power received at the UE antenna port, which shall not degrade the specified HSDPA throughput performance. The requirements and this test apply to all types of 1.28Mcps TDD option UE that support HSDPA (64QAM).

### 6.3B.2 Minimum requirements

The throughput shall be  $\geq 90\%$  of the maximum throughput of the reference measurement channels as specified in Table 6.3B.2 for different UE categories with the parameters specified in Table 6.3B.1. Using this configuration the throughput shall meet or exceed 1.1Mbps

The reference for this requirement is TS 25.102 [1] clause 7.4.2.

**Table 6.3B.1 Minimum requirement parameters for 64QAM Maximum Input Level**

Parameter	Unit	Value
$\frac{\sum HS - PDSCH - Ec}{I_{or}}$	dB	0
$\hat{I}_{or}$	dBm/1.28 MHz	-25
Redundancy and constellation version	-	6
Maximum number of HARQ transmissions	-	1

**Table 6.3B.2 Reference Measurement Channel for different UE Categories (64QAM)**

UE Category	Reference Channel
Category 16-18	C.4.2.6.1
Category 19-21	C.4.2.6.2
Category 22-24	C.4.2.6.3
Category 25/26/27	Note1
Category 28 (Note2)	C.4.2.10.1
Category 29 (Note2)	C.4.2.11.1
Category 30 (Note2)	C.4.2.12.1
Note1: Category 25/26/27 UEs are configured to non-MIMO mode and the requirements of Category 18/21/24 UEs are applied respectively.	
Note2: The FRCs for the first stream is used.	

### 6.3B.3 Test purpose

To verify that the UE HSDPA throughput meets the minimum requirements for the DL reference channel specified in Table 6.3B.2 with the addition of the parameters specified in table 6.3B.1.

An inadequate maximum input level causes loss of coverage near the Node B.

### 6.3B.4 Method of test

#### 6.3B.4.1 Initial conditions

Test environment: normal; see clauses G.2.1 and G.2.2.

Frequencies to be tested: mid range; see clause G.2.4.

### 6.3B.4.2 Procedure

Connect the SS to the UE antenna connector as shown in figure A.1.

- 1) The UE is switched on.
- 2) An RRC connection is set-up according to the generic HSDPA set-up procedure specified in TS 34.108 [3] and SS RF parameters are given in tables 6.3B.1.
- 3) Measure the HS-PDSCH throughput  $R$  received by the UE by counting the number of NACK, ACK and statDTX on the UL HS-SICH (Throughput = blocksize\*number of blocks acknowledged/time).
- 4) The UE is switched off.

### 6.3B.5 Test requirements

The throughput shall be  $\geq 90\%$  of the maximum throughput of the reference measurement channels as specified in Table 6.3B.2 for different UE categories with the parameters specified in Table 6.3B.1. The minimum number of measurements required for a statistically significant result to this test is clarified in annex F.6.3, Table F.6.3.5.1.

NOTE: If the above Test Requirement differs from the Minimum Requirement then the Test Tolerance applied for this test is non-zero. The Test Tolerance for this test is defined in clause F.2 and the explanation of how the Minimum Requirement has been relaxed by the Test Tolerance is given in clause F.4.

## 6.3C Maximum Input Level (IMB)

### 6.3C.1 Definition and applicability

The maximum input level is defined as the maximum mean power received at the UE antenna connector, which does not degrade the specified BLER performance.

The requirements in this clause shall apply to 3.84 Mcps TDD IMB UE.

### 6.3C.2 Minimum requirements

The BLER shall not exceed 0.01 for the parameters specified in table 6.3C.2.1.

**Table 6.3C.2.1: Maximum input level (3,84 Mcps TDD IMB)**

Parameter	Level	Unit
$\frac{\Sigma DPCH\_Ec}{I_{or}}$	-7.77	dB
$\hat{I}_{or}$	-25	dBm/3,84 MHz
NOTE: The term $\Sigma DPCH\_Ec$ refers to the sum of the energy of the physical channels comprising the IMB DL reference measurement channel.		

The reference for this requirement is TS 25.102 [1] clause 7.4.1.1.

### 6.3C.3 Test purpose

The test purpose is to verify the ability of the UE to receive a prescribed test signal at the upper end of the dynamic range under defined conditions (no interference, no multipath propagation) with BLER not exceeding a specified value.

### 6.3C.4 Method of test

#### 6.3C.4.1 Initial conditions

Test environment: normal; see clauses G.2.1 and G.2.2.

Frequencies to be tested: mid range; see clause G.2.4.

- 1) Connect the SS to the UE antenna connector as shown in figure A.3.
- 2) A call is set up according to the Generic call setup procedure.
- 3) Enter the UE into loopback mode 3 and start the loopback test. See TS 34.108 and TS 34.109 for details regarding loopback test mode 3 for MBMS.
- 4) The level of SS output signal measured at the UE antenna connector shall be according to table 6.3C.2.1

### 6.3C.4.2 Procedure

- 1) SS shall start the test by sending data on the MTCH radio bearer and maintain the count of transmitted RLC SDU blocks on the MTCH.
- 2) SS shall send a "UE TEST LOOP MODE 3 RLC SDU COUNTER REQUEST" message and wait for the UE to response with a "UE TEST LOOP MODE 3 RLC SDU COUNTER RESPONSE" reporting the received RLC SDU counter value.
- 3) SS shall compute the RLC SDU error rate based on the transmitted RLC SDUs count and received RLC SDU count reported by the UE.
- 4) The test shall be run until the statistical significance according to Annex to F.6.1.8 is achieved.

### 6.3C.5 Test requirements

For IMB operation, the computed BLER shall not exceed 0.01.

## 6.4 Adjacent Channel Selectivity (ACS)

### 6.4.1 Definition and applicability

Adjacent Channel Selectivity is a measure of a receiver's ability to receive a wanted signal at its assigned channel frequency in the presence of an adjacent channel signal at a given frequency offset from the centre frequency of the assigned channel. ACS is the ratio of the receive filter attenuation on the assigned channel frequency to the receiver filter attenuation on the adjacent channel(s).

The requirements of this test apply to all UTRA UE.

### 6.4.2 Minimum Requirements

#### 6.4.2.1 3,84 Mcps TDD Option

For the UE of power class 2 and 3, the BER shall not exceed 0,001 for parameters specified in table 6.4.2.1. This test condition is equivalent to the ACS value 33 dB.

**Table 6.4.2.1: Test parameters for Adjacent Channel Selectivity (3,84 Mcps TDD Option)**

Parameter	Unit	Level
$\frac{\Sigma DPCH - Ec}{I_{or}}$	dB	0
$I_{or}$	dBm/3,84 MHz	-91
$I_{oac}$ mean power (modulated)	dBm	-52
$F_{uw}$ offset	MHz	+5 or -5

Explanatory note:

Within the reference sensitivity BER= 0.001 corresponds to a test signal = -105 dBm/3,84 MHz and a noise level -99 dBm /3,84 MHz BW (S/I -6 dB).

Within ACS BER=0.001 is directly verified.

Known from the reference sensitivity, this corresponds to S/I -6dB in the wanted BW.

As a wanted signal of  $-91$  dBm applied, an in-channel-interfering-signal of  $-85$  dBm can be assumed.

Verifying a filter suppression of 33 dB indirectly, an adjacent-channel-interferer of  $-52$  dBm is needed

The normative reference of this requirement is TS 25.102 [1] clause 7.5.

#### 6.4.2.2 1,28 Mcps TDD Option

For the UE of power class 2 and 3, the BER shall not exceed 0,001 for parameters specified in table 6.4.2.2. This test condition is equivalent to the ACS value 33 dB.

**Table 6.4.2.2: Test parameters for Adjacent Channel Selectivity (1,28Mcps TDD Option)**

Parameter	Unit	Case 1	Case 2
$\frac{\Sigma DPCH\_Ec}{I_{or}}$	dB	0	0
$I_{or}$	dBm/1,28MHz	-91	-62
$I_{oac}$ mean power (modulated)	dBm	-54	-25
$F_{uw}$ offset	MHz	+1.6 or -1.6	+1.6 or -1.6

The normative reference of this requirement is TS 25.102 [1] clause 7.5.1.2.

#### 6.4.2.3 7,68 Mcps TDD Option

For the UE of power class 2 and 3, the BER shall not exceed 0,001 for parameters specified in table 6.4.2.3. This test condition is equivalent to the ACS value 33 dB.

**Table 6.4.2.3: Test parameters for Adjacent Channel Selectivity (7,68 Mcps TDD Option)**

Parameter	Unit	Level
$\frac{\Sigma DPCH\_Ec}{I_{or}}$	dB	0
$I_{or}$	dBm/7.68 MHz	-91
$I_{oac}$ mean power (modulated)	dBm	-52
$F_{uw}$ offset (3.84 Mcps Modulated)	MHz	+7.5 or -7.5
$F_{uw}$ offset (7.68 Mcps Modulated)	MHz	+10 or -10

Explanatory note:

Within the reference sensitivity BER= 0.001 corresponds to a testsignal = -105 dBm/7,68 MHz and a noise level -99 dBm /7,68 MHz BW (S/I -6 dB).

Within ACS BER=0.001 is directly verified.

Known from the reference sensitivity, this corresponds to S/I -6dB in the wanted BW.

As a wanted signal of  $-91$  dBm applied, an in-channel-interfering-signal of  $-85$  dBm can be assumed.

Verifying a filter suppression of 33 dB indirectly, an adjacent-channel-interferer of  $-52$  dBm is needed

The normative reference of this requirement is TS 25.102 [1] clause 7.5.1.3.

### 6.4.3 Test purpose

The test purpose is to verify the ability of the UE-receiver to sufficiently suppress the interfering signal in the channel adjacent to the wanted channel.

#### 6.4.4 Method of test

##### 6.4.4.1 Initial conditions

Test environment: normal; see clauses G.2.1 and G.2.2.



Frequencies to be tested: mid range; see clause G.2.4.

- 1) Connect the SS and the interferer to the UE antenna connector as shown in figure A.4.
- 2) A call is set up according to the Generic call setup procedure.
- 3) Enter the UE into loopback test mode and start the loopback test.
- 4) Set the signal generators to produce wanted and interference signals according table 6.4.2.1 for 3,84 Mcps TDD option, table 6.4.2.1.2 for 1,28 Mcps TDD option and table 6.4.2.1.3 for 7,68 Mcps TDD option. The interference signal shall be equivalent to a continuously running wideband CDMA signal with one code and chip frequency 3,84 Mchip/s for the 3,84 Mcps TDD Option, a 1,28 Mchip/s for the 1,28 Mcps TDD Option and 7,68 Mchip/s for the 7,68 Mcps TDD Option, respectively and rolloff 0.22.

#### 6.4.4.2 Procedure

- 1) Set the interference signal 5 MHz for the 3,84 Mcps TDD Option, 1.6 MHz for the 1,28 Mcps TDD Option and 10 MHz for the 7,68 Mcps TDD Option, respectively above the assigned channel frequency of the wanted signal.
- 2) Measure the BER of the wanted signal received from the UE at the SS.
- 3) Set the interference signal 5 MHz for the 3,84 Mcps TDD Option, 1.6 MHz for the 1,28 Mcps TDD Option and 10 MHz for the 7,68 Mcps TDD Option, respectively, below the assigned channel frequency of the wanted signal and repeat 2).
- 4) For the 7,68 Mcps TDD option repeat steps 1 to 3 for an interfering 3.84 Mcps signal with offsets 7.5 MHz above and below the assigned channel frequency of the wanted signal.

### 6.4.5 Test Requirements

#### 6.4.5.1 3,84 Mcps TDD Option

The measured BER, derived in step 2), shall not exceed 0,001 under conditions described in table 6.4.5.1 for the 3,84 Mcps TDD Option.

**Table 6.4.5.1: Test parameters for Adjacent Channel Selectivity (3,84 Mcps TDD Option)**

Parameter	Unit	Level
$\frac{\Sigma DPCH - Ec}{I_{or}}$	dB	0
$I_{or}$	dBm/3,84 MHz	-91
$I_{oac}$ mean power (modulated)	dBm	-52
$F_{uw}$ offset	MHz	+5 or -5

NOTE: If the above Test Requirement differs from the Minimum Requirement then the Test Tolerance applied for this test is non-zero. The Test Tolerance for this test is defined in Annex F.2 and the explanation of how the Minimum Requirement has been relaxed by the Test Tolerance is given in Annex F.4.

#### 6.4.5.2 1,28 Mcps TDD Option

The measured BER, derived in step 2), shall not exceed 0,001 under conditions described in table 6.4.5.2 for the 1,28 Mcps TDD Option.

**Table 6.4.5.2: Test parameters for Adjacent Channel Selectivity (1,28Mcps TDD Option)**

Parameter	Unit	Case 1	Case 2
$\frac{\Sigma DPCH_{-} Ec}{I_{or}}$	dB	0	0
$\hat{I}_{or}$	dBm/1,28MHz	-91	-62
$I_{oac}$ mean power (modulated)	dBm	-54	-25
$F_{uw}$ offset	MHz	+1.6 or -1.6	+1.6 or -1.6

NOTE: If the above Test Requirement differs from the Minimum Requirement then the Test Tolerance applied for this test is non-zero. The Test Tolerance for this test is defined in annex F clause F.2 and the explanation of how the Minimum Requirement has been relaxed by the Test Tolerance is given in annex F clause F.4.

### 6.4.5.3 7,68 Mcps TDD Option

The measured BER, derived in step 2), shall not exceed 0,001 under conditions described in table 6.4.5.3 for the 7,68 Mcps TDD Option.

**Table 6.4.5.3: Test parameters for Adjacent Channel Selectivity (7,68 Mcps TDD Option)**

Parameter	Unit	Level
$\frac{\Sigma DPCH_{-} Ec}{I_{or}}$	dB	0
$\hat{I}_{or}$	dBm/3,84 MHz	-91
$I_{oac}$ mean power (modulated)	dBm	-52
$F_{uw}$ offset (3.84 Mcps Modulated)	MHz	+7.5 or -7.5
$F_{uw}$ offset (7.68 Mcps Modulated)	MHz	+10 or -10

NOTE: If the above Test Requirement differs from the Minimum Requirement then the Test Tolerance applied for this test is non-zero. The Test Tolerance for this test is defined in Annex F.2 and the explanation of how the Minimum Requirement has been relaxed by the Test Tolerance is given in Annex F.4.

## 6.4A Adjacent Channel Selectivity (ACS) (IMB)

### 6.4A.1 Definition and applicability

Adjacent Channel Selectivity is a measure of a receiver's ability to receive a wanted signal at its assigned channel frequency in the presence of an adjacent channel signal at a given frequency offset from the centre frequency of the assigned channel. ACS is the ratio of the receive filter attenuation on the assigned channel frequency to the receiver filter attenuation on the adjacent channel(s).

The requirements of this test apply to 3.84 Mcps TDD IMB UE.

### 6.4A.2 Minimum Requirements

The BLER shall not exceed [0.01 for the parameters specified in table 6.4A.2.1.

**Table 6.4A.2.1: Test parameters for Adjacent Channel Selectivity (3,84 Mcps TDD IMB)**

Parameter	Unit	Level
$\Sigma DPCH\_Ec$	dB	-0.77
$\frac{I_{or}}{I_{or}}$		
$I_{or}$	dBm/3,84 MHz	-91
$I_{oac}$ mean power (modulated)	dBm	-52
$F_{uw}$ offset	MHz	+5 or -5
NOTE: The term $\Sigma DPCH\_Ec$ refers to the sum of the energy of the physical channels comprising the IMB DL reference measurement channel.		

Explanatory note:

Within the reference sensitivity BLER=0.01 corresponds to a test signal = -105 dBm/3,84 MHz and a noise level -99 dBm /3,84 MHz BW (S/I -6 dB).

Within ACS BLER=0.01 is directly verified.

Known from the reference sensitivity, this corresponds to S/I -6dB in the wanted BW.

As a wanted signal of -91 dBm applied, an in-channel-interfering-signal of -85 dBm can be assumed.

Verifying a filter suppression of 33 dB indirectly, an adjacent-channel-interferer of -52 dBm is needed

The normative reference of this requirement is TS 25.102 [1] clause 7.5.

### 6.4A.3 Test purpose

The test purpose is to verify the ability of the UE-receiver to sufficiently suppress the interfering signal in the channel adjacent to the wanted channel.

### 6.4A.4 Method of test

#### 6.4A.4.1 Initial conditions

Test environment: normal; see clauses G.2.1 and G.2.2.

Frequencies to be tested: mid range; see clause G.2.4.

- 1) Connect the SS and the interferer to the UE antenna connector as shown in figure A.4.
- 2) A call is set up according to the Generic call setup procedure.
- 3) Enter the UE into loopback mode 3 and start the loopback test. See TS 34.108 and TS 34.109 for details regarding loopback test mode 3 for MBMS.
- 4) Set the signal generators to produce wanted and interference signals according table 6.4A.2.1. The interference signal shall be equivalent to a continuously running wideband CDMA signal with one code and chip frequency 3,84 Mchip/s and rolloff 0.22.

#### 6.4A.4.2 Procedure

- 1) Set the interference signal 5 MHz for the 3,84 Mcps TDD Option above the assigned channel frequency of the wanted signal.
- 2) SS shall start the test by sending data on the MTCH radio bearer and maintain the count of transmitted RLC SDU blocks on the MTCH.
- 3) SS shall send a "UE TEST LOOP MODE 3 RLC SDU COUNTER REQUEST" message and wait for the UE to response with a "UE TEST LOOP MODE 3 RLC SDU COUNTER RESPONSE" reporting the received RLC SDU counter value.

- 4) SS shall compute the RLC SDU error rate based on the transmitted RLC SDUs count and received RLC SDU count reported by the UE.
- 5) Set the interference signal 5 MHz for the 3,84 Mcps TDD Option below the assigned channel frequency of the wanted signal and repeat steps 2 to 5.

## 6.4A.5 Test Requirements

The computed BLER shall not exceed 0.01 under conditions described in table 6.4A.5.1.

**Table 6.4A.5.1: Test parameters for Adjacent Channel Selectivity (3,84 Mcps TDD IMB)**

Parameter	Unit	Level
$\frac{\Sigma DPCH\_Ec}{I_{or}}$	dB	-0.77
$\hat{I}_{or}$	dBm/3,84 MHz	-91
$I_{oac}$ mean power (modulated)	dBm	-52
$F_{uw}$ offset	MHz	+5 or -5
NOTE: The term $\Sigma DPCH\_Ec$ refers to the sum of the energy of the physical channels comprising the IMB DL reference measurement channel.		

NOTE: If the above Test Requirement differs from the Minimum Requirement then the Test Tolerance applied for this test is non-zero. The Test Tolerance for this test is defined in Annex F.2 and the explanation of how the Minimum Requirement has been relaxed by the Test Tolerance is given in Annex F.4.

## 6.5 Blocking Characteristics

### 6.5.1 Definition and applicability

The blocking characteristics is a measure of the receiver ability to receive a wanted signal at its assigned channel frequency in the presence of an unwanted interferer on frequencies other than those of the spurious response or the adjacent channels without this unwanted input signal causing a degradation of the performance of the receiver beyond a specified limit.. The blocking performance shall apply at all frequencies except those at which a spurious response occur.

The requirements of this test apply to all UTRA UE.

### 6.5.2 Minimum Requirements

#### 6.5.2.1 3,84 Mcps TDD Option

The BER shall not exceed 0,001 for the parameters specified in table 6.5.2.1a and table 6.5.2.1b. For table 6.5.2.1b up to 24 exceptions are allowed for spurious response frequencies in each assigned frequency channel when measured using a 1MHz step size for the interference signal.

The normative reference for this requirement is TS 25.102 clause 7.6.1.1.

**Table 6.5.2.1a: In-band blocking (3,84 Mcps TDD Option)**

Parameter	Level		Unit
$\frac{\Sigma DPCH\_Ec}{I_{or}}$	0		dB
$\hat{I}_{or}$	-102		dBm/3,84 MHz
$I_{ouw}$ mean power (modulated)	-56 (for $F_{uw}$ offset $\pm 10$ MHz)	-44 (for $F_{uw}$ offset $\pm 15$ MHz)	dBm

**Table 6.5.2.1b: Out of band blocking (3,84 Mcps TDD Option)**

Parameter	Band 1	Band 2	Band 3	Unit
$\frac{\Sigma DPCH - Ec}{I_{or}}$	0	0	0	dB
$\hat{I}_{or}$	-102	-102	-102	dBm/3,84 MHz
$I_{ouw}$	-44	-30	-15	dBm
$F_{uw}$ For operation in frequency bands as defined in clause 4.2(a)	1840 < f < 1885 1935 < f < 1995 2040 < f < 2085	1815 < f < 1840 2085 < f < 2110	1 < f < 1815 2110 < f < 12750	MHz
$F_{uw}$ For operation in frequency bands as defined in clause 4.2(b)	1790 < f < 1835 2005 < f < 2050	1765 < f < 1790 2050 < f < 2075	1 < f < 1765 2075 < f < 12750	MHz
$F_{uw}$ For operation in frequency bands as defined in clause 4.2(c)	1850 < f < 1895 1945 < f < 1990	1825 < f < 1850 1990 < f < 2015	1 < f < 1825 2015 < f < 12750	MHz

NOTE 1: For operation referenced in 4.2(a), from 1885 < f < 1900 MHz, 1920 < f < 1935 MHz, 1995 < f < 2010 MHz and 2025 < f < 2040 MHz, the appropriate in-band blocking or adjacent channel selectivity in clause 6.4.2.1 shall be applied.

NOTE 2: For operation referenced in 4.2(b), from 1835 < f < 1850 MHz and 1990 < f < 2005 MHz, the appropriate in-band blocking or adjacent channel selectivity in clause 6.4.2.1 shall be applied.

NOTE 3: For operation referenced in 4.2(c), from 1895 < f < 1910 MHz and 1930 < f < 1945 MHz, the appropriate in-band blocking or adjacent channel selectivity in clause 6.4.2.1 shall be applied.

### 6.5.2.2 1,28 Mcps TDD Option

The BER shall not exceed 0.001 for the parameters specified in table 6.5.2.2a and table 6.5.2.2b. For table 6.5.2.2b up to 24 exceptions are allowed for spurious response frequencies in each assigned frequency channel when measured using a 1MHz step size.

The normative reference for this requirement is 3G TS 25.102 [1] clause 7.6.1.2.

**Table 6.5.2.2a: In-band blocking (1,28Mcps TDD Option)**

Parameter	Level		Unit
$\frac{\Sigma DPCH - Ec}{I_{or}}$	0		dB
$\hat{I}_{or}$	-105		dBm/1,28 MHz
$I_{ouw}$ mean power (modulated)	-61 (for $F_{uw}$ offset $\pm 3.2$ MHz)	-49 (for $F_{uw}$ offset $\pm 4.8$ MHz)	dBm

Table 6.5.2.2b: Out of band blocking (1,28Mcps TDD Option)

Parameter	Band 1	Band 2	Band 3	Unit
$\frac{\Sigma DPCH\_Ec}{I_{or}}$	0	0	0	dB
$\hat{I}_{or}$	-105	-105	-105	dBm/1,28 MHz
$I_{ouw}$ (CW)	-44	-30	-15	dBm
$F_{uw}$ For operation in frequency bands as defined in clause 4.2(a)	1840 < f < 1895.2 1924.8 < f < 2005.2 2029.8 < f < 2085	1815 < f < 1840 2085 < f < 2110	1 < f < 1815 2110 < f < 12750	MHz
$F_{uw}$ For operation in frequency bands as defined in clause 4.2(b)	1790 < f < 1845.2 1994.8 < f < 2050	1765 < f < 1790 2050 < f < 2075	1 < f < 1765 2075 < f < 12750	MHz
$F_{uw}$ For operation in frequency bands as defined in clause 4.2(c)	1850 < f < 1905.2 1934.8 < f < 1990	1825 < f < 1850 1990 < f < 2015	1 < f < 1825 2015 < f < 12750	MHz
$F_{uw}$ For operation in frequency bands as defined in subclause 5.2(e)	2240 < f < 2295.2 2404.8 < f < 2460	2215 < f ≤ 2240 2460 ≤ f < 2485	1 < f ≤ 2215 2485 ≤ f < 12750	MHz
$F_{uw}$ For operation in frequency bands as defined in subclause 5.2(f)	1820 < f < 1875.2 1924.8 < f < 1980	1795 < f ≤ 1820 1980 ≤ f < 2005	1 < f ≤ 1795 2005 < f < 12750	MHz

NOTE 1: For operation referenced in 4.2(a), from 1895.2 < f < 1900 MHz, 1920 < f < 1924.8 MHz, 2005.2 < f < 2010 MHz and 2025 < f < 2029.8 MHz, the appropriate in-band blocking or adjacent channel selectivity in clause 6.4.2.2 shall be applied.

NOTE 2: For operation referenced in 4.2(b), from 1845.2 < f < 1850 MHz and 1990 < f < 1994.8 MHz, the appropriate in-band blocking or adjacent channel selectivity in clause 6.4.2.2 shall be applied.

NOTE 3: For operation referenced in 4.2(c), from 1905.2 < f < 1910 MHz and 1930 < f < 1934.8 MHz, the appropriate in-band blocking or adjacent channel selectivity in clause 6.4.2.2 shall be applied.

NOTE 4: For operation referenced in 4.2(d), from 2565.2 ≤ f ≤ 2624.8 MHz, the appropriate in-band blocking or adjacent channel selectivity in clause 6.4.2.2 shall be applied.

NOTE 5: For operation referenced in 4.2(e), from 2295.2 ≤ f ≤ 2404.8 MHz, the appropriate in-band blocking or adjacent channel selectivity in clause 6.4.2.2 shall be applied.

NOTE 6: For operation referenced in 4.2(f), from 1875.2 ≤ f ≤ 1924.8 MHz, the appropriate in-band blocking or adjacent channel selectivity in clause 6.4.2.2 shall be applied.

### 6.5.2.3 7,68 Mcps TDD Option

The BER shall not exceed 0,001 for the parameters specified in table 6.5.2.3a and table 6.5.2.3b. For table 6.5.2.3b up to 24 exceptions are allowed for spurious response frequencies in each assigned frequency channel when measured using a 1MHz step size for the interference signal.

The normative reference for this requirement is TS 25.102 clause 7.6.1.3.

**Table 6.5.2.3a: In-band blocking (7,68 Mcps TDD Option)**

Parameter	Level		Unit
$\frac{\Sigma DPCH\_Ec}{I_{or}}$	0		dB
$\hat{I}_{or}$	-102		dBm/7.68 MHz
$I_{ouw}$ mean power (modulated)	-53 (for $F_{uw}$ offset $\pm 20$ MHz)	-41 (for $F_{uw}$ offset $\pm 30$ MHz)	dBm

**Table 6.5.2.3b: Out of band blocking (7,68 Mcps TDD Option)**

Parameter	Band 1	Band 2	Band 3	Unit
$\frac{\Sigma DPCH\_Ec}{I_{or}}$	0	0	0	dB
$\hat{I}_{or}$	-102	-102	-102	dBm/7.68 MHz
$I_{ouw}$ (CW)	-44	-30	-15	dBm
$F_{uw}$ For operation in frequency bands as defined in subclause 4.2(a)	1840 <f < 1870 1950 <f < 1980 2055 <f < 2085	1815 <f < 1840 2085 <f < 2110	1 < f < 1815 2110 < f < 12750	MHz
$F_{uw}$ For operation in frequency bands as defined in subclause 4.2(b)	1790 < f < 1820 2020 < f < 2050	1765 < f < 1790 2050 < f < 2075	1 < f < 1765 2075 < f < 12750	MHz
$F_{uw}$ For operation in frequency bands as defined in subclause 4.2(c)	1850 < f < 1880 1960 < f < 1990	1825 < f < 1850 1990 < f < 2015	1 < f < 1825 2015 < f < 12750	MHz
$F_{uw}$ For operation in frequency bands as defined in subclause 4.2(d)	2510 <f < 2540 2650 <f < 2680	2485 <f < 2510 2680 <f < 2705	1 <f < 2485 2705 <f < 12750	MHz
1.	For operation referenced in 4.2(a), from 1870 <f < 1900 MHz, 1920 <f < 1950 MHz, 1980 <f < 2010 MHz and 2025 <f < 2055 MHz, the appropriate in-band blocking or adjacent channel selectivity in section 6.4.2.3 shall be applied.			
2.	For operation referenced in 4.2(b), from 1820 < f < 1850 MHz and 1990 < f < 2020 MHz, the appropriate in-band blocking or adjacent channel selectivity in section 6.4.2.3 shall be applied.			
3.	For operation referenced in 4.2(c), from 1880 < f < 1910 MHz and 1930 < f < 1960 MHz, the appropriate in-band blocking or adjacent channel selectivity in section 6.4.2.3 shall be applied.			
4.	For operation referenced in 4.2(d), from 2540 < f < 2570 MHz and 2620 < f < 2650 MHz, the appropriate in-band blocking or adjacent channel selectivity in section 6.4.2.3 shall be applied.			

**Table 6.5.2.3c: Additional Out of band blocking (7,68 Mcps TDD Option)**

Parameter	Band 1	Band 2	Band 3	Unit
$\frac{\Sigma D P C H \_ E c}{I_{or}}$	0	0	0	dB
$\hat{I}_{or}$	-102	-102	-102	dBm/7.68 MHz
$I_{ouw}(CW)$	-44	-30	-15	dBm
$F_{uw}$ For operation in frequency bands in 2010-2025 MHz as defined in subclause 5.2(a)	1840 <f <1995 2040 <f <2085	1815 <f <1840 2085 <f <2110	1 < f <1815 2110 < f <12750	MHz
NOTE 1: Additional requirement is applied for Band a) UE operating on 2010-2025MHz.				

### 6.5.3 Test purpose

"The test stresses the ability of the UE receiver to withstand high-level interference from unwanted signals at frequency offsets of 10 MHz or more, without undue degradation of its sensitivity."

### 6.5.4 Method of test

#### 6.5.4.1 Initial conditions

For in-band case:

Test environment: normal; see clauses G.2.1 and G.2.2.

Frequencies to be tested: mid range; see clause G.2.4.

For out-of-band case:

Test environment: normal; see clauses G.2.1 and G.2.2.

Frequency to be tested: 1 arbitrary frequency chosen from the low, mid or high range; see clause G.2.4.

- 1) Connect the SS and the interfering Signal generator to the UE antenna connector as shown in figure A.5.
- 2) A call is set up according to the Generic call setup procedure.
- 3) Enter the UE into loopback test mode and start the loopback test.

#### 6.5.4.2 Procedure

- 1) The wanted signal frequency channel is set to mid range frequency. The wanted signal power level shall be set according to Table 6.5.5.1a for the 3,84 Mcps TDD option, Table 6.5.5.2a for the 1,28 Mcps TDD option and Table 6.5.5.3a for the 7,68 Mcps TDD option.
- 2) The interfering Signal Generator is stepped through the frequency range indicated in table 6.5.2.1a for the 3,84 Mcps TDD Option, table 6.5.2.2a for the 1,28 Mcps TDD Option and table 6.5.2.3a for the 7,68 Mcps TDD Option, respectively with a step size of 1 MHz. The interfering signal level shall be set according to Table 6.5.5.1a for the 3,84 Mcps TDD option, Table 6.5.5.2a for the 1,28 Mcps TDD option and Table 6.5.5.3a for the 7,68 Mcps TDD option.
- 3) The interference signal shall be equivalent to a continuously running wideband CDMA signal with one code and chip frequency 3,84 Mchip/s for the 3,84 Mcps TDD Option, 1,28 Mchip/s for the 1,28 Mcps TDD Option and 7,68 Mchip/s for the 7,68 Mcps TDD Option, respectively and rolloff 0.22.
- 4) Measure the BER of the wanted signal received from the UE at the SS for each step of the interferer.
- 5) The wanted signal frequency channel is set to an arbitrary frequency chosen from the low, mid or high range. The level of the wanted signal shall be set according to Table 6.5.5.1b for the 3,84 Mcps TDD option, table 6.5.5.2b for the 1,28 Mcps TDD option and table 6.5.5.3b for the 7,68 Mcps TDD option.



- 6) The interfering Signal Generator is stepped through the frequency range indicated in table 6.5.2.1b for the 3,84 Mcps TDD Option, table 6.5.2.2b for the 1,28 Mcps TDD Option and table 6.5.2.3b for the 7,68 Mcps TDD Option, respectively with a step size of 1 MHz. The interfering signal level shall be set according to Table 6.5.5.1b for the 3,84 Mcps TDD option, Table 6.5.5.2b for the 1,28 Mcps TDD option and Table 6.5.5.3b for the 7,68 Mcps TDD option.
- 7) The interference signal is a CW signal.
- 8) Measure the BER of the wanted signal received from the UE at the SS for each step of the interferer.
- 9) Record the frequencies for which BER exceed the test requirements in Table 6.5.5.1b for the 3,84 Mcps TDD option, table 6.5.5.2b for the 1,28 Mcps TDD option and table 6.5.5.3b for the 7,68 Mcps TDD option. These frequencies are further proceeding in subclause 6.6 Spurious Response.
- 10) For 7,68 Mcps TDD option repeat steps 1 to 9 except use the channel power levels defined for the addition test conditions specified in 6.5.5.3c and the frequency ranges specified in 6.5.2.3c.

NOTE: Due to the large amount of time-consuming BER tests it is recommended to speed up a single BER test by reducing the 0.001-BER confidence level [10 000 bits under test or 10 errors] for screening the critical frequencies. Critical frequencies must be identified using standard BER confidence level. [30 000 bits or 30 errors].

## 6.5.5 Test requirements

### 6.5.5.1 3,84 Mcps TDD Option

The measured BER, derived in step 4) shall not exceed 0,001 (without exception) under test conditions described in table 6.5.5.1a.

The measured BER, derived in step 8), shall not exceed 0,001 except for up to 24 different frequencies of the interfering signal under test conditions described in table 6.5.5.1b.

These frequencies are further processed in clause 6.6 Spurious response.

**Table 6.5.5.1a: Test conditions In-band blocking (3,84 Mcps TDD Option)**

Parameter	Level		Unit
$\frac{\Sigma DPCH\_Ec}{I_{or}}$	0		dB
$\bar{I}_{or}$	-102		dBm/3,84 MHz
$I_{ouw}$ mean power (modulated)	-56 (for $F_{uw\ offset} \pm 10$ MHz)	-44 (for $F_{uw\ offset} \pm 15$ MHz)	dBm

**Table 6.5.5.1b: Test conditions Out of band blocking (3,84 Mcps TDD Option)**

Parameter	Band 1	Band 2	Band 3	Unit
$\frac{\Sigma DPCH\_Ec}{I_{or}}$	0	0	0	dB
$\bar{I}_{or}$	-102	-102	-102	dBm/3,84 MHz
$I_{ouw}$ (CW)	-44	-30	-15	dBm

NOTE: If the above Test Requirement differs from the Minimum Requirement then the Test Tolerance applied for this test is non-zero. The Test Tolerance for this test is defined in annex F clause F.2 and the explanation of how the Minimum Requirement has been relaxed by the Test Tolerance is given in annex F clause F.4.

### 6.5.5.2 1,28 Mcps TDD Option

The measured BER, derived in step 4), shall not exceed 0,001 (without exception) under test conditions described in table 6.5.5.2a.

The measured BER, derived in step 8), shall not exceed 0,001 except for up to 24 different frequencies of the interfering signal under test conditions described in table 6.5.5.2b.

These frequencies are further processed in clause 6.6 Spurious response.

**Table 6.5.5.2a: Test conditions In-band blocking (1,28 Mcps TDD Option)**

Parameter	Level		Unit
$\frac{\Sigma DPCH\_Ec}{I_{or}}$	0		dB
$\hat{I}_{or}$	-105		dBm/1,28 MHz
$I_{ouw}$ mean power (modulated)	-61 (for $F_{uw}$ offset $\pm 3.2$ MHz)	-49 (for $F_{uw}$ offset $\pm 4.8$ MHz)	dBm

**Table 6.5.5.2b: Test conditions Out of band blocking (1,28 Mcps TDD Option)**

Parameter	Band 1	Band 2	Band 3	Unit
$\frac{\Sigma DPCH\_Ec}{I_{or}}$	0	0	0	dB
$\hat{I}_{or}$	-105	-105	-105	dBm/1,28 MHz
$I_{ouw}$	-44	-30	-15	dBm

NOTE: If the above Test Requirement differs from the Minimum Requirement then the Test Tolerance applied for this test is non-zero. The Test Tolerance for this test is defined in annex F clause F.2 and the explanation of how the Minimum Requirement has been relaxed by the Test Tolerance is given in annex F clause F.4

### 6.5.5.3 7,68 Mcps TDD Option

The measured BER, derived in step 4) shall not exceed 0,001 (without exception) under test conditions described in table 6.5.5.3a.

The measured BER, derived in step 8), shall not exceed 0,001 except for up to 24 different frequencies of the interfering signal under test conditions described in table 6.5.5.3b and 6.5.5.3c.

These frequencies are further processed in clause 6.6 Spurious response.

**Table 6.5.5.3a: Test conditions In-band blocking (7,68 Mcps TDD Option)**

Parameter	Level		Unit
$\frac{\Sigma DPCH\_Ec}{I_{or}}$	0		dB
$\hat{I}_{or}$	-102		dBm/7,68 MHz
$I_{ouw}$ mean power (modulated)	-53 (for $F_{uw}$ offset $\pm 20$ MHz)	-41 (for $F_{uw}$ offset $\pm 30$ MHz)	dBm

**Table 6.5.5.3b: Test conditions Out of band blocking (7,68 Mcps TDD Option)**

Parameter	Band 1	Band 2	Band 3	Unit
$\frac{\Sigma DPCH\_Ec}{I_{or}}$	0	0	0	dB

$\hat{I}_{or}$	-102	-102	-102	dBm/7,68 MHz
$I_{ouw}$ (CW)	-44	-30	-15	dBm

**Table 6.5.5.3c: Test conditions additional Out of band blocking (7,68 Mcps TDD Option)**

Parameter	Band 1	Band 2	Band 3	Unit
$\frac{\Sigma DPCH\_Ec}{I_{or}}$	0	0	0	dB
$\hat{I}_{or}$	-102	-102	-102	dBm/7.68 MHz
$I_{ouw}$ (CW)	-44	-30	-15	dBm

NOTE: If the above Test Requirement differs from the Minimum Requirement then the Test Tolerance applied for this test is non-zero. The Test Tolerance for this test is defined in annex F clause F.2 and the explanation of how the Minimum Requirement has been relaxed by the Test Tolerance is given in annex F clause F.4.

## 6.5A Blocking Characteristics (IMB)

### 6.5A.1 Definition and applicability

The blocking characteristics is a measure of the receiver ability to receive a wanted signal at its assigned channel frequency in the presence of an unwanted interferer on frequencies other than those of the spurious response or the adjacent channels without this unwanted input signal causing a degradation of the performance of the receiver beyond a specified limit.. The blocking performance shall apply at all frequencies except those at which a spurious response occur.

The requirements of this test apply to 3.84 Mcps TDD IMB UE.

### 6.5A.2 Minimum Requirements

The BLER shall not exceed 0.01 for the parameters specified in table 6.5A.2.1a and table 6.5A.2.1b. For table 6.5A.2.1b up to 24 exceptions are allowed for spurious response frequencies in each assigned frequency channel when measured using a 1MHz step size for the interference signal.

The normative reference for this requirement is TS 25.102 clause 7.6.1.1.

**Table 6.5A.2.1a: In-band blocking (3,84 Mcps TDD IMB)**

Parameter	Level		Unit
$\frac{\Sigma DPCH\_Ec}{I_{or}}$	-0.77		dB
$\hat{I}_{or}$	-102		dBm/3,84 MHz
$I_{ouw}$ mean power (modulated)	-56 (for $F_{uw\ offset} \pm 10$ MHz)	-44 (for $F_{uw\ offset} \pm 15$ MHz)	dBm

NOTE: The term  $\Sigma DPCH\_Ec$  refers to the sum of the energy of the physical channels comprising the IMB DL reference measurement channel.

Table 6.5A.2.1b: Out of band blocking (3,84 Mcps TDD IMB)

Parameter	Band 1	Band 2	Band 3	Unit
$\frac{\Sigma DPCH\_Ec}{I_{or}}$	-0.77	-0.77	-0.77	dB
$I_{or}$	-102	-102	-102	dBm/3,84 MHz
$I_{ouw}$	-44	-30	-15	dBm
Fuw For operation in frequency bands as defined in clause 4.2(a)	1840 <f <1885 1935 <f <1995 2040 <f <2085	1815 <f <1840 2085 <f <2110	1 <f <1815 2110 <f <12750	MHz
Fuw For operation in frequency bands as defined in clause 4.2(b)	1790 <f < 1835 2005 <f < 2050	1765 <f < 1790 2050 <f < 2075	1 <f < 1765 2075 <f < 12750	MHz
Fuw For operation in frequency bands as defined in clause 4.2(c)	1850 <f < 1895 1945 <f < 1990	1825 <f < 1850 1990 <f < 2015	1 <f < 1825 2015 <f < 12750	MHz
NOTE: The term $\Sigma DPCH\_Ec$ refers to the sum of the energy of the physical channels comprising the IMB DL reference measurement channel.				

NOTE 1: For operation referenced in 4.2(a), from 1885 <f < 1900 MHz, 1920 <f < 1935 MHz, 1995 <f < 2010 MHz and 2025 <f < 2040 MHz, the appropriate in-band blocking or adjacent channel selectivity in clause 6.4.2.1 shall be applied.

NOTE 2: For operation referenced in 4.2(b), from 1835 <f < 1850 MHz and 1990 <f < 2005 MHz, the appropriate in-band blocking or adjacent channel selectivity in clause 6.4.2.1 shall be applied.

NOTE 3: For operation referenced in 4.2(c), from 1895 <f < 1910 MHz and 1930 <f < 1945 MHz, the appropriate in-band blocking or adjacent channel selectivity in clause 6.4.2.1 shall be applied.

### 6.5A.3 Test purpose

"The test stresses the ability of the UE receiver to withstand high-level interference from unwanted signals at frequency offsets of 10 MHz or more, without undue degradation of its sensitivity."

### 6.5A.4 Method of test

#### 6.5A.4.1 Initial conditions

For in-band case:

Test environment: normal; see clauses G.2.1 and G.2.2.

Frequencies to be tested: mid range; see clause G.2.4.

For out-of-band case:

Test environment: normal; see clauses G.2.1 and G.2.2.

Frequency to be tested: 1 arbitrary frequency chosen from the low, mid or high range; see clause G.2.4.

- 1) Connect the SS and the interfering Signal generator to the UE antenna connector as shown in figure A.5.
- 2) A call is set up according to the Generic call setup procedure.

- 3) Enter the UE into loopback mode 3 and start the loopback test. See TS 34.108 and TS 34.109 for details regarding loopback test mode 3 for MBMS.

#### 6.5A.4.2 Procedure

- 1) The wanted signal frequency channel is set to mid range frequency. The wanted signal power level shall be set according to Table 6.5A.5.1a.
- 2) The interfering Signal Generator is stepped through the frequency range indicated in table 6.5A.2.1a with a step size of 1 MHz. The interfering signal level shall be set according to Table 6.5A.5.1a.
- 3) The interference signal shall be equivalent to a continuously running wideband CDMA signal with one code and chip frequency 3,84 Mchip/s and rolloff 0.22.
- 4) SS shall start the test by sending data on the MTCH radio bearer and maintain the count of transmitted RLC SDU blocks on the MTCH.
- 5) SS shall send a "UE TEST LOOP MODE 3 RLC SDU COUNTER REQUEST" message and wait for the UE to response with a "UE TEST LOOP MODE 3 RLC SDU COUNTER RESPONSE" reporting the received RLC SDU counter value.
- 6) SS shall compute the RLC SDU error rate based on the transmitted RLC SDUs count and received RLC SDU count reported by the UE.
- 7) The test shall be run for the wanted signal received from the UE at the SS for each step of the interferer.
- 8) The wanted signal frequency channel is set to an arbitrary frequency chosen from the low, mid or high range. The level of the wanted signal shall be set according to Table 6.5A.5.1b.
- 9) The interfering Signal Generator is stepped through the frequency range indicated in table 6.5A.2.1b with a step size of 1 MHz. The interfering signal level shall be set according to Table 6.5A.5.1b
- 10) The interference signal is a CW signal.
- 11) SS shall start the test by sending data on the MTCH radio bearer and maintain the count of transmitted RLC SDU blocks on the MTCH.
- 12) SS shall send a "UE TEST LOOP MODE 3 RLC SDU COUNTER REQUEST" message and wait for the UE to response with a "UE TEST LOOP MODE 3 RLC SDU COUNTER RESPONSE" reporting the received RLC SDU counter value.
- 13) SS shall compute the RLC SDU error rate based on the transmitted RLC SDUs count and received RLC SDU count reported by the UE.
- 14) The test shall be run for the wanted signal received from the UE at the SS for each step of the interferer.
- 15) Record the frequencies for which BLER exceed the test requirements in Table 6.5A.5.1b. These frequencies are further proceeding in subclause 6.6A Spurious Response.

NOTE: Due to the large amount of time consumed by the BLER test it is recommended to speed up a single BLER test by reducing the 0.01-BLER confidence level [1 000 blocks under test or 10 errors] for screening the critical frequencies. Critical frequencies must be identified using standard BLER confidence level. [3 000 blocks or 30 errors].

#### 6.5A.5 Test requirements

The computed BLER, in step 6) shall not exceed 0.01 (without exception) under test conditions described in table 6.5A.5.1a.

The computed BLER, in step 13), shall not exceed 0.01 except for up to 24 different frequencies of the interfering signal under test conditions described in table 6.5A.5.1b.

These frequencies are further processed in clause 6.6A Spurious response.

**Table 6.5A.5.1a: Test conditions In-band blocking (3,84 Mcps TDD IMB)**

Parameter	Level		Unit
$\frac{\Sigma DPCH\_Ec}{I_{or}}$	-0.77		dB
$\hat{I}_{or}$	-102		dBm/3,84 MHz
$I_{ouw}$ mean power (modulated)	-56 (for $F_{uw\ offset} \pm 10$ MHz)	-44 (for $F_{uw\ offset} \pm 15$ MHz)	dBm
NOTE: The term $\Sigma DPCH\_Ec$ refers to the sum of the energy of the physical channels comprising the IMB DL reference measurement channel.			

**Table 6.5A.5.1b: Test conditions Out of band blocking (3,84 Mcps TDD IMB)**

Parameter	Band 1	Band 2	Band 3	Unit
$\frac{\Sigma DPCH\_Ec}{I_{or}}$	-0.77	-0.77	-0.77	dB
$\hat{I}_{or}$	-102	-102	-102	dBm/3,84 MHz
$I_{ouw}$ (CW)	-44	-30	-15	dBm
NOTE: The term $\Sigma DPCH\_Ec$ refers to the sum of the energy of the physical channels comprising the IMB DL reference measurement channel.				

NOTE: If the above Test Requirement differs from the Minimum Requirement then the Test Tolerance applied for this test is non-zero. The Test Tolerance for this test is defined in annex F clause F.2 and the explanation of how the Minimum Requirement has been relaxed by the Test Tolerance is given in annex F clause F.4.

## 6.6 Spurious Response

### 6.6.1 Definition and applicability

Spurious response is a measure of the receiver's ability to receive a wanted signal on its assigned channel frequency without exceeding a given degradation due to the presence of an unwanted CW interfering signal at any other frequency at which a response is obtained i.e. for which the blocking limit is not met.

The requirements of this test apply to all types of UTRA for the UE.

### 6.6.2 Minimum Requirements

#### 6.6.2.1 3,84 Mcps TDD Option

The BER shall not exceed 0,001 for the parameters specified in table 6.6.2.1.

The normative reference for this requirement is TS 25.102 clause 7.7.1.1.

**Table 6.6.2.1: Spurious Response (3,84 Mcps TDD Option)**

Parameter	Value	Unit
$\frac{\Sigma DPCH\_Ec}{I_{or}}$	0	dB
$\hat{I}_{or}$	-102	dBm/3,84 MHz
$I_{ouw}$ (CW)	-44	dBm
$F_{uw}$	Spurious response frequencies	MHz

### 6.6.2.2 1,28 Mcps TDD Option

The BER shall not exceed 0.001 for the parameters specified in table 6.6.2.2.

**Table 6.6.2.2: Spurious Response (1,28Mcps TDD Option)**

Parameter	Level	Unit
$\frac{\Sigma DPCH\_Ec}{I_{or}}$	0	dB
$\hat{I}_{or}$	-105	dBm/1,28 MHz
$I_{ouw}$ (CW)	-44	dBm
$F_{uw}$	Spurious response frequencies	MHz

### 6.6.2.3 7,68 Mcps TDD Option

The BER shall not exceed 0,001 for the parameters specified in table 6.6.2.3.

The normative reference for this requirement is TS 25.102 clause 7.7.1.3.

**Table 6.6.2.3: Spurious Response (7,68 Mcps TDD Option)**

Parameter	Level	Unit
$\frac{\Sigma DPCH\_Ec}{I_{or}}$	0	dB
$\hat{I}_{or}$	-102	dBm/7.68 MHz
$I_{ouw}$ (CW)	-44	dBm
$F_{uw}$	Spurious response frequencies	MHz

## 6.6.3 Test purpose

Spurious response frequencies, identified in the blocking test, are measured against a less stringent test requirement. The test stresses the ability of the receiver to withstand high level interference signals without undue degradation of its sensitivity due to the receiver's frequency conversion concept.

## 6.6.4 Method of test

### 6.6.4.1 Initial conditions

Test environment: normal; see clauses G.2.1 and G.2.2.

Frequency to be tested: the same frequency as chosen in subclause 6.5.4.1 for Blocking characteristics out-of-band case.

- 1) Connect the SS and the unwanted signal to the UE antenna connector as shown in figure A.6.
- 2) A call is set up according to the Generic call setup procedure.
- 3) Enter the UE into loopback test mode and start the loopback test.

### 6.6.4.2 Procedure

- 1) Set the wanted signal frequency to the frequency used for the out-of-band blocking test. Set the power level of the wanted signal according to table 6.6.2.1 for the 3,84 Mcps TDD Option, table 6.6.2.2 for the 1,28 Mcps TDD Option and table 6.6.2.3 for the 7,68 Mcps TDD Option, respectively.

- 2) Set the frequency of the interferer signal according the recorded spurious response frequency values obtained from the out-of-band blocking test as described in 6.5.4.2, at which the blocking test failed. Set the power level of the interferer according to table 6.6.5.1 for the 3,84 Mcps TDD Option, table 6.6.5.2 for the 1,28 Mcps TDD Option and table 6.6.5.3 for the 7,68 Mcps TDD Option, respectively.
- 3) Measure the BER of DCH received from the UE at the SS.

## 6.6.5 Test requirements

### 6.6.5.1 3,84 Mcps TDD

The measured BER, derived in step 3), shall not exceed 0,001 under test conditions described in table 6.6.5.1 for the 3,84 Mcps TDD Option.

**Table 6.6.5.1: Test Parameters Spurious Response (3,84 Mcps TDD Option)**

Parameter	Value	Unit
$\frac{\Sigma DPCH\_Ec}{I_{or}}$	0	dB
$\hat{I}_{or}$	-102	dBm/3,84 MHz
$I_{ouw}$ (CW)	-44	dBm
$F_{uw}$	Spurious response frequencies	MHz

NOTE: If the above Test Requirement differs from the Minimum Requirement then the Test Tolerance applied for this test is non-zero. The Test Tolerance for this test is defined in annex F clause F.2 and the explanation of how the Minimum Requirement has been relaxed by the Test Tolerance is given in annex F clause F.4.

### 6.6.5.2 1,28 Mcps TDD

The measured BER, derived in step 3), shall not exceed 0,001 under test conditions described in table 6.6.5.2 for the 1,28 Mcps TDD Option.

**Table 6.6.5.2: Test Parameters Spurious Response (1,28 Mcps TDD Option)**

Parameter	Value	Unit
$\frac{\Sigma DPCH\_Ec}{I_{or}}$	0	dB
$\hat{I}_{or}$	-105	dBm/1,28 MHz
$I_{ouw}$ (CW)	-44	dBm
$F_{uw}$	Spurious response frequencies	MHz

NOTE: If the above Test Requirement differs from the Minimum Requirement then the Test Tolerance applied for this test is non-zero. The Test Tolerance for this test is defined in annex F clause F.2 and the explanation of how the Minimum Requirement has been relaxed by the Test Tolerance is given in annex F clause F.4.

### 6.6.5.3 7,68 Mcps TDD

The measured BER, derived in step 3), shall not exceed 0,001 under test conditions described in table 6.6.5.3 for the 7,68 Mcps TDD Option.

**Table 6.6.5.3: Test Parameters Spurious Response (7,68 Mcps TDD Option)**

Parameter	Value	Unit
$\frac{\Sigma DPCH\_Ec}{I_{or}}$	0	dB



$\hat{I}_{or}$	-102	dBm/3,84 MHz
$I_{ouw}$ (CW)	-44	dBm
$F_{uw}$	Spurious response frequencies	MHz

NOTE: If the above Test Requirement differs from the Minimum Requirement then the Test Tolerance applied for this test is non-zero. The Test Tolerance for this test is defined in annex F clause F.2 and the explanation of how the Minimum Requirement has been relaxed by the Test Tolerance is given in annex F clause F.4.

## 6.6A Spurious Response (IMB)

### 6.6A.1 Definition and applicability

Spurious response is a measure of the receiver's ability to receive a wanted signal on its assigned channel frequency without exceeding a given degradation due to the presence of an unwanted CW interfering signal at any other frequency at which a response is obtained i.e. for which the blocking limit is not met.

The requirements of this test apply to 3.84 Mcps TDD IMB UE.

### 6.6A.2 Minimum Requirements

The BLER shall not exceed 0.01 for the parameters specified in table 6.6A.2.1.

The normative reference for this requirement is TS 25.102 clause 7.7.1.1.

**Table 6.6A.2.1: Spurious Response (3,84 Mcps TDD IMB)**

Parameter	Value	Unit
$\frac{\Sigma DPCH_{Ec}}{I_{or}}$	-0.77	dB
$\hat{I}_{or}$	-102	dBm/3,84 MHz
$I_{ouw}$ (CW)	-44	dBm
$F_{uw}$	Spurious response frequencies	MHz
NOTE: The term $\Sigma DPCH_{Ec}$ refers to the sum of the energy of the physical channels comprising the IMB DL reference measurement channel.		

### 6.6A.3 Test purpose

Spurious response frequencies, identified in the blocking test, are measured against a less stringent test requirement. The test stresses the ability of the receiver to withstand high level interference signals without undue degradation of its sensitivity due to the receiver's frequency conversion concept.

### 6.6A.4 Method of test

#### 6.6A.4.1 Initial conditions

Test environment: normal; see clauses G.2.1 and G.2.2.

Frequency to be tested: the same frequency as chosen in subclause 6.5A.4.1 for Blocking characteristics out-of-band case.

- 1) Connect the SS and the unwanted signal to the UE antenna connector as shown in figure A.6.
- 2) A call is set up according to the Generic call setup procedure.
- 3) Enter the UE into loopback mode 3 and start the loopback test. See TS 34.108 and TS 34.109 for details regarding loopback test mode 3 for MBMS.

## 6.6A.4.2 Procedure

- 1) Set the wanted signal frequency to the frequency used for the out-of-band blocking test. Set the power level of the wanted signal according to table 6.6A.2.1.
- 2) Set the frequency of the interferer signal according the recorded spurious response frequency values obtained from the out-of-band blocking test as described in 6.5A.4.2, at which the blocking test failed. Set the power level of the interferer according to table 6.6A.5.1.
- 3) SS shall start the test by sending data on the MTCH radio bearer and maintain the count of transmitted RLC SDU blocks on the MTCH.
- 2) SS shall send a "UE TEST LOOP MODE 3 RLC SDU COUNTER REQUEST" message and wait for the UE to response with a "UE TEST LOOP MODE 3 RLC SDU COUNTER RESPONSE" reporting the received RLC SDU counter value.
- 3) SS shall compute the RLC SDU error rate based on the transmitted RLC SDUs count and received RLC SDU count reported by the UE.

## 6.6A.5 Test requirements

The computed BLER in step 3), shall not exceed 0.01 under test conditions described in table 6.6A.5.1.

**Table 6.6A.5.1: Test Parameters Spurious Response (3,84 Mcps TDD IMB)**

Parameter	Value	Unit
$\frac{\Sigma DPCH\_Ec}{I_{or}}$	-0.77	dB
$I_{or}$	-102	dBm/3,84 MHz
$I_{ouw}$ (CW)	-44	dBm
$F_{uw}$	Spurious response frequencies	MHz
NOTE: The term $\Sigma DPCH\_Ec$ refers to the sum of the energy of the physical channels comprising the IMB DL reference measurement channel.		

NOTE: If the above Test Requirement differs from the Minimum Requirement then the Test Tolerance applied for this test is non-zero. The Test Tolerance for this test is defined in annex F clause F.2 and the explanation of how the Minimum Requirement has been relaxed by the Test Tolerance is given in annex F clause F.4.

## 6.7 Intermodulation Characteristics

### 6.7.1 Definition and applicability

Third and higher order mixing of the two interfering RF signals can produce an interfering signal in the band of the desired channel. Intermodulation response rejection is a measure of the capability of the receiver to receiver a wanted signal on its assigned channel frequency in the presence of two or more interfering signals which have a specific frequency relationship to the wanted signal.

The requirements of this test shall apply to all UTRA UE.

## 6.7.2 Minimum Requirements

### 6.7.2.1 3,84 Mcps TDD Option

The BER shall not exceed 0,001 for the parameters specified in table 6.7.2.1.

The normative reference for this requirement is TS 25.102 clause 7.8.1.1.

**Table 6.7.2.1: Receive intermodulation characteristics (3,84 Mcps TDD Option)**

Parameter	Value	Unit
$\frac{\Sigma DPCH_{-} Ec}{I_{or}}$	0	dB
$\hat{I}_{or}$	-102	dBm/3,84 MHz
$I_{ouw1}(CW)$	-46	dBm
$I_{ouw2}$ mean power (modulated)	-46	dBm
$F_{uw1}(CW)$	$\pm 10$	MHz
$F_{uw2}$ (Modulated)	$\pm 20$	MHz

### 6.7.2.2 1,28 Mcps TDD Option

The BER shall not exceed 0.001 for the parameters specified in table 6.7.2.2.

The normative reference for this requirement is TS 25.102 clause 7.8.1.2.

**Table 6.7.2.2: Receive intermodulation characteristics (1,28 Mcps TDD Option)**

Parameter	Level	Unit
$\frac{\Sigma DPCH_{-} Ec}{I_{or}}$	0	dB
$\hat{I}_{or}$	-105	dBm/1,28 MHz
$I_{ouw1}(CW)$	-46	dBm
$I_{ouw2}$ mean power (modulated)	-46	dBm
$F_{uw1}(CW)$	$\pm 3.2$	MHz
$F_{uw2}$ (Modulated)	$\pm 6.4$	MHz

### 6.7.2.3 7,68 Mcps TDD Option

The BER shall not exceed 0,001 for the parameters specified in table 6.7.2.3.

The normative reference for this requirement is TS 25.102 clause 7.8.1.3.

**Table 6.7.2.3: Receive intermodulation characteristics (7,68 Mcps TDD Option)**

Parameter	Level	Unit
$\frac{\Sigma DPCH_{-} Ec}{I_{or}}$	0	dB
$\hat{I}_{or}$	-102	dBm/7.68 MHz
$I_{ouw1}(CW)$	-46	dBm
$I_{ouw2}$ mean power (modulated)	-46	dBm
$F_{uw1}(CW)$	$\pm 20$	MHz
$F_{uw2}$ (modulated)	$\pm 40$	MHz

### 6.7.3 Test purpose

The test stresses the ability of the receiver to withstand two or more high level interference signals without undue degradation of its sensitivity due to the receiver's non-linear elements.

### 6.7.4 Method of test

#### 6.7.4.1 Initial conditions

Test environment: normal; see clauses G.2.1 and G.2.2.

Frequencies to be tested: mid range; see clause G.2.4.

- 1) Connect the SS and the unwanted signals to the UE antenna connector as shown in figure A.7.
- 2) A call is set up according to the Generic call setup procedure.
- 3) Enter the UE into loopback test mode and start the loopback test.

#### 6.7.4.2 Procedure

- 1) Set the wanted and interfering signals as indicated in table 6.7.2.1 for the 3,84 Mcps TDD Option, table 6.7.2.2 for the 1,28 Mcps TDD Option and table 6.7.2.3 for the 7,68 Mcps TDD Option with positive offset with respect to the wanted signal.
- 2) Measure the BER of DCH received from the UE at the SS.
- 3) Set the interfering signals as indicated in table 6.7.2.1 for the 3,84 Mcps TDD Option, table 6.7.2.2 for the 1,28 Mcps TDD Option and table 6.7.2.3 for the 7,68 Mcps TDD Option with negative offset with respect to the wanted signal and repeat 2).

### 6.7.5 Test requirements

#### 6.7.5.1 3,84 Mcps TDD Option

The measured BER, derived in step 2) and 3), shall not exceed 0,001 under test conditions described in table 6.7.5.1 for the 3,84 Mcps TDD Option.

**Table 6.7.5.1: Test parameters Receive intermodulation characteristics (3,84 Mcps TDD Option)**

Parameter	Value	Unit
$\frac{\Sigma DPCH\_Ec}{I_{or}}$	0	dB
$I_{or}$ /Wanted Signal Level	-102	dBm/3,84 MHz
I <sub>ouw1</sub> (CW)	-46	dBm
I <sub>ouw2</sub> mean power (modulated)	-46	dBm
F <sub>uw1</sub> (CW)	±10	MHz
F <sub>uw2</sub> (Modulated)	±20	MHz

NOTE: If the above Test Requirement differs from the Minimum Requirement then the Test Tolerance applied for this test is non-zero. The Test Tolerance for this test is defined in annex F clause F.2 and the explanation of how the Minimum Requirement has been relaxed by the Test Tolerance is given in annex F clause F.4.

#### 6.7.5.2 1,28 Mcps TDD Option

The measured BER, derived in step 2) and 3), shall not exceed 0,001 under test conditions described in table 6.7.5.2 for the 1,28 Mcps TDD Option.

**Table 6.7.5.2: Test parameters Receive intermodulation characteristics (1,28 Mcps TDD Option)**

Parameter	Level	Unit
$\frac{\Sigma DPCH - Ec}{I_{or}}$	0	dB
$\hat{I}_{or}$	-105	dBm/1,28 MHz
$I_{ouw1}$ (CW)	-46	dBm
$I_{ouw2}$ mean power (modulated)	-46	dBm
$F_{uw1}$ (CW)	$\pm 3.2$	MHz
$F_{uw2}$ (Modulated)	$\pm 6.4$	MHz

NOTE: If the above Test Requirement differs from the Minimum Requirement then the Test Tolerance applied for this test is non-zero. The Test Tolerance for this test is defined in Annex F.2 and the explanation of how the Minimum Requirement has been relaxed by the Test Tolerance is given in Annex F.4.

### 6.7.5.3 7,68 Mcps TDD Option

The measured BER, derived in step 2) and 3), shall not exceed 0,001 under test conditions described in table 6.7.5.3 for the 7,68 Mcps TDD Option.

**Table 6.7.5.3: Test parameters Receive intermodulation characteristics (7,68 Mcps TDD Option)**

Parameter	Value	Unit
$\frac{\Sigma DPCH - Ec}{I_{or}}$	0	dB
$\hat{I}_{or}$ /Wanted Signal Level	-102	dBm/3,84 MHz
$I_{ouw1}$ (CW)	-46	dBm
$I_{ouw2}$ mean power (modulated)	-46	dBm
$F_{uw1}$ (CW)	$\pm 20$	MHz
$F_{uw2}$ (Modulated)	$\pm 40$	MHz

NOTE: If the above Test Requirement differs from the Minimum Requirement then the Test Tolerance applied for this test is non-zero. The Test Tolerance for this test is defined in annex F clause F.2 and the explanation of how the Minimum Requirement has been relaxed by the Test Tolerance is given in annex F clause F.4.

## 6.7A Intermodulation Characteristics (IMB)

### 6.7A.1 Definition and applicability

Third and higher order mixing of the two interfering RF signals can produce an interfering signal in the band of the desired channel. Intermodulation response rejection is a measure of the capability of the receiver to receiver a wanted signal on its assigned channel frequency in the presence of two or more interfering signals which have a specific frequency relationship to the wanted signal.

The requirements of this test shall apply to 3.84 Mcps TDD IMB UE.

### 6.7A.2 Minimum Requirements

The BLER shall not exceed 0.01 for the parameters specified in table 6.7A.2.1.

The normative reference for this requirement is TS 25.102 clause 7.8.1.1.

**Table 6.7A.2.1: Receive intermodulation characteristics (3,84 Mcps TDD IMB)**

Parameter	Value	Unit
$\frac{\Sigma DPCH - Ec}{I_{or}}$	-0.77	dB

$\hat{I}_{or}$	-102	dBm/3,84 MHz
$I_{ouw1}(CW)$	-46	dBm
$I_{ouw2}$ mean power (modulated)	-46	dBm
$F_{uw1}(CW)$	$\pm 10$	MHz
$F_{uw2}$ (Modulated)	$\pm 20$	MHz
NOTE: The term $\Sigma DPCH_{Ec}$ refers to the sum of the energy of the physical channels comprising the IMB DL reference measurement channel.		

### 6.7A.3 Test purpose

The test stresses the ability of the receiver to withstand two or more high level interference signals without undue degradation of its sensitivity due to the receiver's non-linear elements.

### 6.7A.4 Method of test

#### 6.7A.4.1 Initial conditions

Test environment: normal; see clauses G.2.1 and G.2.2.

Frequencies to be tested: mid range; see clause G.2.4.

- 1) Connect the SS and the unwanted signals to the UE antenna connector as shown in figure A.7.
- 2) A call is set up according to the Generic call setup procedure.
- 3) Enter the UE into loopback mode 3 and start the loopback test. See TS 34.108 and TS 34.109 for details regarding loopback test mode 3 for MBMS.

#### 6.7A.4.2 Procedure

- 1) Set the wanted and interfering signals as indicated in table 6.7A.2.1 with positive offset with respect to the wanted signal.
- 2) SS shall start the test by sending data on the MTCH radio bearer and maintain the count of transmitted RLC SDU blocks on the MTCH.
- 3) SS shall send a "UE TEST LOOP MODE 3 RLC SDU COUNTER REQUEST" message and wait for the UE to response with a "UE TEST LOOP MODE 3 RLC SDU COUNTER RESPONSE" reporting the received RLC SDU counter value.
- 4) SS shall compute the RLC SDU error rate based on the transmitted RLC SDUs count and received RLC SDU count reported by the UE.
- 5) Set the interfering signals as indicated in table 6.7A.2.1 with negative offset with respect to the wanted signal and repeat steps 2 to 4).

## 6.7A.5 Test requirements

The computed BLER in step 4) and 5), shall not exceed 0.01 under test conditions described in table 6.7A.5.1.

**Table 6.7A.5.1: Test parameters Receive intermodulation characteristics (3,84 Mcps TDD IMB)**

Parameter	Value	Unit
$\frac{\Sigma DPCH\_Ec}{I_{or}}$	-0.77	dB
$I_{or}$ Wanted Signal Level	-102	dBm/3,84 MHz
louw1(CW)	-46	dBm
louw2 mean power (modulated)	-46	dBm
F <sub>uw1</sub> (CW)	±10	MHz
F <sub>uw2</sub> (Modulated)	±20	MHz
NOTE: The term $\Sigma DPCH\_Ec$ refers to the sum of the energy of the physical channels comprising the IMB DL reference measurement channel.		

NOTE: If the above Test Requirement differs from the Minimum Requirement then the Test Tolerance applied for this test is non-zero. The Test Tolerance for this test is defined in annex F clause F.2 and the explanation of how the Minimum Requirement has been relaxed by the Test Tolerance is given in annex F clause F.4.

## 6.8 Spurious Emissions

### 6.8.1 Definition and applicability

The Spurious Emissions Power is the power of emissions generated or amplified in a receiver that appear at the UE antenna connector.

The requirements of this test are applicable for all UTRA UE.

### 6.8.2 Minimum Requirements

#### 6.8.2.1 3,84 Mcps TDD Option

The power of any spurious emission shall not exceed:

**Table 6.8.2.1: Receiver spurious emission requirements (3,84 Mcps TDD Option)**

Band	Maximum level	Measurement Bandwidth	Note
30 MHz – 1 GHz	-57 dBm	100 kHz	
1 GHz – 1,9 GHz and 1,92 GHz – 2,01 GHz and 2,025 GHz – 2,11 GHz	-47 dBm	1 MHz	
1,9 GHz – 1,92 GHz and 2,01 GHz – 2,025 GHz and 2,11 GHz – 2,170 GHz	-60 dBm	3,84 MHz	
2,170 GHz – 12,75 GHz	-47 dBm	1 MHz	

The normative reference for this requirement is TS 25.102 [1] clause 7.9.1.1.

#### 6.8.2.2 1,28 Mcps TDD Option

The power of any spurious emission shall not exceed the maximum level specified in Table 6.8.2.2 and Table 6.8.2.2A.

**Table 6.8.2.2: Receiver spurious emission requirements (1,28Mcps TDD Option)**

Frequency Band	Measurement Bandwidth	Maximum level	Note
$30\text{MHz} \leq f < 1\text{GHz}$	100 kHz	-57 dBm	
$1\text{GHz} \leq f \leq 12.75\text{GHz}$	1 MHz	-47 dBm	

**Table 6.8.2.2A: Additional receiver spurious emission requirements (1.28 Mcps TDD Option)**

Band	Frequency Band	Measurement Bandwidth	Maximum level	Note
<b>a</b>	$2010\text{MHz} \leq f \leq 2025\text{MHz}$	1.28MHz	-64dBm	
	$2570\text{MHz} \leq f \leq 2620\text{MHz}$	1.28MHz	-64dBm	
	$2300\text{MHz} \leq f \leq 2400\text{MHz}$	1.28MHz	-64dBm	
	$1880\text{MHz} \leq f \leq 1920\text{MHz}$	1.28MHz	-64dBm	
	$2110\text{MHz} \leq f \leq 2170\text{MHz}$	3.84MHz	-60dBm	
	$2620\text{MHz} \leq f \leq 2690\text{MHz}$	3.84MHz	-60dBm	
<b>b</b>	$1850\text{MHz} \leq f \leq 1910\text{MHz}$	1.28MHz	-64dBm	
	$1910\text{MHz} \leq f \leq 1990\text{MHz}$	1.28MHz	-64dBm	
<b>c</b>	$1910\text{MHz} \leq f \leq 1930\text{MHz}$	1.28MHz	-64dBm	
<b>d</b>	$2570\text{MHz} \leq f \leq 2620\text{MHz}$	1.28MHz	-64dBm	
	$2010\text{MHz} \leq f \leq 2025\text{MHz}$	1.28MHz	-64dBm	
	$2110\text{MHz} \leq f \leq 2170\text{MHz}$	3.84MHz	-60dBm	
	$2620\text{MHz} \leq f \leq 2690\text{MHz}$	3.84MHz	-60dBm	
<b>e</b>	$2300\text{MHz} \leq f \leq 2400\text{MHz}$	1.28MHz	-64dBm	
	$2010\text{MHz} \leq f \leq 2025\text{MHz}$	1.28MHz	-64dBm	
	$1880\text{MHz} \leq f \leq 1920\text{MHz}$	1.28MHz	-64dBm	
<b>f</b>	$1880\text{MHz} \leq f \leq 1920\text{MHz}$	1.28MHz	-64dBm	
	$2010\text{MHz} \leq f \leq 2025\text{MHz}$	1.28MHz	-64dBm	
	$2300\text{MHz} \leq f \leq 2400\text{MHz}$	1.28MHz	-64dBm	

The normative reference for this requirement is TS 25.102 [1] clause 7.9.1.2.

### 6.8.2.3 7,68 Mcps TDD Option

The power of any spurious emission shall not exceed:

**Table 6.8.2.3: Receiver spurious emission requirements (7,68 Mcps TDD Option)**

Band	Maximum level	Measurement Bandwidth	Note
30 MHz - 1 GHz	-57 dBm	100 kHz	
1 GHz - 1.9 GHz and 1.92 GHz - 2.01 GHz and 2.025 GHz - 2.11 GHz 2.17 GHz - 2.57 GHz	-47 dBm	1 MHz	
1.9 GHz - 1.92 GHz and 2.01 GHz - 2.025 GHz and 2.11 GHz - 2.170 GHz 2.57 GHz - 2.69 GHz	-57 dBm	7.68 MHz	
2.69 GHz - 12.75 GHz	-47 dBm	1 MHz	

The normative reference for this requirement is TS 25.102 [1] clause 7.9.1.3.

## 6.8.3 Test purpose

The test purpose is to verify the UE's ability to limit interference caused by receiver spurious emissions to the own and the other systems. The test requirements are tighter than in clause 5.5.3 ((TX) Spurious Emissions) because the time of Receive-Only-Operation is generally much longer than RX-TX-Operation.



## 6.8.4 Method of test

### 6.8.4.1 Initial conditions

Test environment: normal; see clauses G.2.1 and G.2.2.

Frequencies to be tested: 1 arbitrary frequency selected between low and high range; see clause G.2.4.

- 1) Connect the measurement equipment to the UE antenna connector according to figure A.8.
- 2) RF parameters are setup according to table 6.8.4.1a for 3,84 Mcps TDD option, 6.8.4.1b for 1,28 Mcps TDD and table 6.8.4.1a for 7,68 Mcps TDD option respectively.
- 3) A call is set up according to the setup procedure specified in TS34.108 [3] sub-clause 7.3.3, with the following exceptions for information elements in System Information Block type3.

Information Element	Value/Remark
- Cell selection and re-selection info	TDD
- CHOICE mode	0 dB
- Sintrasearch	0 dB
- Sintersearch	This parameter is configurable
- RAT List	0 dB
- Ssearch,RAT	0 dB
- Maximum allowed UL TX power	Power level where Pcompensation=0

Note 1: The setup procedure (3) sets the UE into CELL\_FACH state. With this state and the SS level (2) it is ensured that UE continuously monitors the S-CCPCH and no cell reselections are performed [see 25.304, subcl. 5.2.3.and 5.2.6]. No transmission of the UE will interfere with the measurement.

**Table 6.8.4.1a: RF parameters for receiver spurious test (3,84Mcps TDD Option and 7.68Mcps TDD option)**

Parameter	Unit	Level
PCCPCH_Ec/lor	dB	-3
SCH_Ec/lor	dB	-9
$\hat{I}_{or}/I_{oc}$	dB	9
PCCPCH RSCP	dBm	-64

**Table 6.8.4.1b: RF parameters for receiver spurious test (1,28Mcps TDD Option)**

Parameter	Unit	Level
PCCPCH_Ec/lor	dB	-3
DwPCH_Ec/lor	dB	0
$\hat{I}_{or}/I_{oc}$	dB	9
PCCPCH RSCP	dBm	-64

### 6.8.4.2 Procedure

Measure the average power of spurious emissions by covering the frequency ranges of table 6.8.2.1 for the 3,84 Mcps TDD Option, table 6.8.2.2 for the 1,28 Mcps TDD Option and table 6.8.2.3 for the 7,68 Mcps TDD Option.

## 6.8.5 Test requirements

### 6.8.5.1 3,84 Mcps TDD Option

The spurious emissions shall be according to table 6.8.5.1 for the 3,84 Mcps TDD Option.

**Table 6.8.5.1: Receiver spurious emission test requirements (3,84 Mcps TDD Option)**

Band	Maximum level	Measurement Bandwidth	Note
30 MHz – 1 GHz	-57 dBm	100 kHz	
1 GHz – 1,9 GHz and 1,92 GHz – 2,01 GHz and 2,025 GHz – 2,11 GHz	-47 dBm	1 MHz	
1,9 GHz – 1,92 GHz and 2,01 GHz – 2,025 GHz and 2,11 GHz – 2,170 GHz	-60 dBm	3,84 MHz	
2,170 GHz – 12,75 GHz	-47 dBm	1MHz	

NOTE: If the above Test Requirement differs from the Minimum Requirement then the Test Tolerance applied for this test is non-zero. The Test Tolerance for this test is defined in annex F clause F.2 and the explanation of how the Minimum Requirement has been relaxed by the Test Tolerance is given in annex F clause F.4.

### 6.8.5.2 1,28 Mcps TDD Option

The spurious emissions shall be according to table 6.8.5.2 and table 6.8.5.2A for the 1,28 Mcps TDD Option.

**Table 6.8.5.2: Receiver spurious emission requirements (1,28Mcps TDD Option)**

Frequency Band	Measurement Bandwidth	Maximum level	Note
$30\text{MHz} \leq f < 1\text{GHz}$	100 kHz	-57 dBm	
$1\text{GHz} \leq f \leq 12.75\text{GHz}$	1 MHz	-47 dBm	

**Table 6.8.5.2A: Additional receiver spurious emission requirements (1.28 Mcps TDD Option)**

Band	Frequency Band	Measurement Bandwidth	Maximum level	Note
a	$2010\text{MHz} \leq f \leq 2025\text{MHz}$	1.28MHz	-64dBm	
	$2570\text{MHz} \leq f \leq 2620\text{MHz}$	1.28MHz	-64dBm	
	$2300\text{MHz} \leq f \leq 2400\text{MHz}$	1.28MHz	-64dBm	
	$1880\text{MHz} \leq f \leq 1920\text{MHz}$	1.28MHz	-64dBm	
	$2110\text{MHz} \leq f \leq 2170\text{MHz}$	3.84MHz	-60dBm	
	$2620\text{MHz} \leq f \leq 2690\text{MHz}$	3.84MHz	-60dBm	
b	$1850\text{MHz} \leq f \leq 1910\text{MHz}$	1.28MHz	-64dBm	
	$1910\text{MHz} \leq f \leq 1990\text{MHz}$	1.28MHz	-64dBm	
c	$1910\text{MHz} \leq f \leq 1930\text{MHz}$	1.28MHz	-64dBm	
d	$2570\text{MHz} \leq f \leq 2620\text{MHz}$	1.28MHz	-64dBm	
	$2010\text{MHz} \leq f \leq 2025\text{MHz}$	1.28MHz	-64dBm	
	$2110\text{MHz} \leq f \leq 2170\text{MHz}$	3.84MHz	-60dBm	
	$2620\text{MHz} \leq f \leq 2690\text{MHz}$	3.84MHz	-60dBm	
e	$2300\text{MHz} \leq f \leq 2400\text{MHz}$	1.28MHz	-64dBm	
	$2010\text{MHz} \leq f \leq 2025\text{MHz}$	1.28MHz	-64dBm	
	$1880\text{MHz} \leq f \leq 1920\text{MHz}$	1.28MHz	-64dBm	
f	$1880\text{MHz} \leq f \leq 1920\text{MHz}$	1.28MHz	-64dBm	
	$2010\text{MHz} \leq f \leq 2025\text{MHz}$	1.28MHz	-64dBm	
	$2300\text{MHz} \leq f \leq 2400\text{MHz}$	1.28MHz	-64dBm	

NOTE: If the above Test Requirement differs from the Minimum Requirement then the Test Tolerance applied for this test is non-zero. The Test Tolerance for this test is defined in annex F clause F.2 and the explanation of how the Minimum Requirement has been relaxed by the Test Tolerance is given in annex F clause F.4.

### 6.8.5.3 7,68 Mcps TDD Option

The spurious emissions shall be according to table 6.8.5.3 for the 7,68 Mcps TDD Option.

**Table 6.8.5.3: Receiver spurious emission test requirements (7,68 Mcps TDD Option)**

<b>Band</b>	<b>Maximum level</b>	<b>Measurement Bandwidth</b>	<b>Note</b>
30 MHz - 1 GHz	-57 dBm	100 kHz	
1 GHz - 1.9 GHz and 1.92 GHz - 2.01 GHz and 2.025 GHz - 2.11 GHz 2.17 GHz - 2.57 GHz	-47 dBm	1 MHz	
1.9 GHz - 1.92 GHz and 2.01 GHz - 2.025 GHz and 2.11 GHz - 2.170 GHz 2.57 GHz - 2.69 GHz	-57 dBm	7.68 MHz	
2.69 GHz - 12.75 GHz	-47 dBm	1 MHz	

NOTE: If the above Test Requirement differs from the Minimum Requirement then the Test Tolerance applied for this test is non-zero. The Test Tolerance for this test is defined in annex F clause F.2 and the explanation of how the Minimum Requirement has been relaxed by the Test Tolerance is given in annex F clause F.4.

## 7 Performance Requirements

### 7.1 General

The performance requirements for the UE in this clause is specified for the measurement channels specified in annex C and the test environments specified in annex D.

All Block Error ratio (BLER) measurements in clause 7 shall be performed according to the general rules for statistical testing in Annex F.6.

#### 7.1.2 Definition of Additive White Gaussian Noise (AWGN) Interferer

The minimum bandwidth of the AWGN interferer shall be 1.5 times chip rate of the radio access mode. (e.g. 5.76 MHz for a chip rate of 3,84 Mcps). The flatness across this minimum bandwidth shall be less than  $\pm 0.5$  dB and the peak to average ratio at a probability of 0.001% shall exceed 10 dB.

### 7.2 Demodulation in static propagation conditions

#### 7.2.1 Demodulation of DCH

##### 7.2.1.1 Definition and applicability

The performance requirement of DCH in static propagation conditions is determined by the maximum Block Error Ratio (BLER). The BLER is specified for each individual data rate of the DCH. DCH is mapped into the Dedicated Physical Channel (DPCH).

The UE shall be tested only according to the datarates, supported. The data-rate-corresponding requirements shall apply to the UE.

The requirements and this test apply to all types of UTRA TDD UE.

##### 7.2.1.2 Minimum requirements

###### 7.2.1.2.1 3,84 Mcps TDD Option

For the parameters specified in table 7.2.1.2.1a the BLER shall not exceed the piece-wise linear BLER curve specified in table 7.2.1.2.1b. These requirements are applicable for TFCS size 16.

The reference for this requirement is TS 25.102 [1] clause 8.2.1.1.1.

**Table 7.2.1.2.1a: DCH parameters in static propagation conditions (3,84 Mcps TDD Option)**

Parameters	Unit	Test 1	Test 2	Test 3	Test 4	Test 5
$\frac{\Sigma DPCH \_ E_c}{I_{or}}$	dB	-6	-3	0	0	0
$I_{oc}$	dBm/3,84 MHz	-60				
Cell Parameter*		0,1				
DPCH Channelization Codes*	C(k,Q)	C(i,16) i=1,2	C(i,16) i=1 . .5	C(i,16) i=1 . .9	C(i,16) i=1 . .8	-
OCNS Channelization Code*	C(k,Q)	C(3,16)	C(6,16)	-	-	-
Information Data Rate	kbps	12,2	64	144	384	2048
Note:	Refer to TS 25.223 for definition of channelization codes and cell parameter.					

**Table 7.2.1.2.1b: Performance requirements in AWGN channel (3,84 Mcps TDD Option)**

Test Number	$\frac{\hat{I}_{or}}{I_{oc}}$ [dB]	BLER
1	1,1	$10^{-2}$
2	3,5	$10^{-1}$
	3,8	$10^{-2}$
3	3,4	$10^{-1}$
	3,6	$10^{-2}$
4	2,7	$10^{-1}$
	3,0	$10^{-2}$
5	3,5	$10^{-1}$
	3,6	$10^{-2}$

### 7.2.1.2.2 1,28 Mcps TDD Option

For the parameters specified in table 7.2.1.2.2a the BLER should not exceed the piece-wise linear BLER curve specified in table 7.2.1.2.2b. The reference for this requirement is TS 25.102 [1] clause 8.2.1.1.2.

**Table 7.2.1.2.2a: DCH parameters in static propagation conditions (1,28Mcps TDD Option)**

Parameters	Unit	Test 1	Test 2	Test 3	Test 4
Number of DPCH <sub>o</sub>		8	2	2	0
Scrambling code and basic midamble code number*		0	0	0	0
DPCH Channelization Codes*	C(k,Q)	C(i,16) i=1,2	C(i,16) i=1...8	C(i,16) i=1...8	C(i,16) i=1...9
DPCH <sub>o</sub> Channelization Codes*	C(k,Q)	C(i,16) 3 ≤ i ≤ 10	C(i,16) 9 ≤ i ≤ 10	C(i,16) 9 ≤ i ≤ 10	-
$\frac{DPCH_{o} - E_c}{I_{or}}$	dB	-10	-10	-10	0
$I_{oc}$	dBm/1,28MHz	-60			
Midamble		Common midamble			
Information Data Rate	Kbps	12,2	64	144	384

\*Note: Refer to TS 25.223 for definition of channelization codes, scrambling code and basic midamble code.

**Table 7.2.1.2.2b: Performance requirements in AWGN channel (1,28 Mcps TDD Option)**

Test Number	$\frac{\hat{I}_{or}}{I_{oc}}$ [dB]	BLER
1	3.6	$10^{-2}$
2	2.4	$10^{-1}$
	2.7	$10^{-2}$
3	2.8	$10^{-1}$
	3.2	$10^{-2}$
4	4.6	$10^{-1}$

### 7.2.1.2.3 7,68 Mcps TDD Option

For the parameters specified in table 7.2.1.2.3a the BLER shall not exceed the piece-wise linear BLER curve specified in table 7.2.1.2.3b. These requirements are applicable for TFCS size 16.

The reference for this requirement is TS 25.102 [1] clause 8.2.1.1.3.

**Table 7.2.1.2.3a: DCH parameters in static propagation conditions (7,68 Mcps TDD Option)**

Parameters	Unit	Test 1
$\frac{\Sigma DPCH \_ E_c}{I_{or}}$	dB	-9
$I_{oc}$	dBm/7.68 MHz	-60
Cell Parameter*	-	0,1
DPCH Channelization Codes*	C(k, Q)	C(i, 32), i = 1,2
OCNS Channelization Code*	C(k, Q)	C(3, 32)
Information Data Rate	kbps	12.2
*Note: Refer to TS 25.223 for definition of channelization codes and cell parameter.		

**Table 7.2.1.2.3b: Performance requirements in AWGN channel (7,68 Mcps TDD Option)**

Test Number	$\frac{\hat{I}_{or}}{I_{oc}}$ [dB]	BLER
1	1.1	$10^{-2}$

### 7.2.1.3 Test purpose

While the receiver tests in clause 6 aims for the RF hardware, this performance requirement aims for the receiver's signal processing.

The test purpose is to verify the ability of the receiver to receive a predefined test signal ,representing a static propagation channel for the wanted and for the co-channel signals from serving and adjacent cells, with a block error ratio (BLER) not exceeding a specified value.

### 7.2.1.4 Method of test

#### 7.2.1.4.1 Initial conditions

Test environment: normal; see clauses G.2.1 and G.2.2.

Frequencies to be tested: mid range; see clause G.2.4.

- 1) Connect the SS, AWGN Generator and additional components to the UE antenna connector as shown in figure A.9.
- 2) A call is set up according to the Generic call setup procedure. The characteristic of the call shall be according to the DL reference measurement channels (12,2 kbit/s) (64 kbit/s), (144 kbit/s), and (384 kbit/s) specified in annex C for 3.84 Mcps TDD option and 1.28Mcps TDD option. The characteristic of the call shall be according to the DL reference measurement channels (12,2 kbit/s) for 7.68 Mcps TDD option.
- 3) Enter the UE into loopback test mode and start the loopback test. (test 1) and/or activate the Ack/Nack test mode (test 1 to test 4).
- 4) The levels of the wanted signal and the co-channel signals are set according to table 7.2.1.2.1a and b for the 3,84 Mcps TDD Option, table 7.2.1.2.2a and b for the 1,28 Mcps TDD Option and table 7.2.1.2.3a and b for the 7,68 Mcps TDD Option, respectively.

#### 7.2.1.4.2 Procedure

Measure the BLER of DCH received from the UE at the SS for all tests specified in table 7.2.1.2.1a for the 3,84 Mcps TDD Option, table 7.2.1.2.2a for the 1,28 Mcps TDD Option and table 7.2.1.2.3a for the 7,68 Mcps TDD Option, respectively.

### 7.2.1.5 Test requirements

#### 7.2.1.5.1 3.84Mcps TDD Option

The measured BLER shall not exceed the values indicated in table 7.2.1.2.1b for the 3,84 Mcps TDD Option

### 7.2.1.5.2 1.28Mcps TDD Option

The measured BLER shall not exceed the values indicated in table 7.2.1.5.2 for the 1.28 Mcps TDD Option

**Table 7.2.1.5.2: Performance requirements in AWGN channel (1,28 Mcps TDD Option)**

Test Number	$\frac{\hat{I}_{or}}{I_{oc}}$ [dB]	BLER
1	3.9	$10^{-2}$
2	2.7	$10^{-1}$
	3.0	$10^{-2}$
3	3.1	$10^{-1}$
	3.5	$10^{-2}$
4	4.9	$10^{-1}$

### 7.2.1.5.3 7.68Mcps TDD Option

The measured BLER shall not exceed the values indicated in table 7.2.1.2.3b for the 7.68 Mcps TDD Option

NOTE: If the Test Requirement differs from the Minimum Requirement then the Test Tolerance applied for this test is non-zero. The Test Tolerance for this test is defined in clause F.2 and the explanation of how the Minimum Requirement has been relaxed by the Test Tolerance is given in clause F.4.

## 7.3 Demodulation of DCH in multipath fading conditions

### 7.3.1 Multipath fading Case 1

#### 7.3.1.1 Definition and applicability

The performance requirement of DCH is determined by the maximum Block Error Ratio (BLER). The BLER is specified for each individual data ratio of the DCH. DCH is mapped into the Dedicated Physical Channel (DPCH).

The UE shall be tested only according to the data ratios, supported. The data-ratio-corresponding requirements shall apply to the UE.

The requirements and this test apply to all types of UTRA TDD UE.

#### 7.3.1.2 Minimum requirements

##### 7.3.1.2.1 3,84 Mcps TDD Option

For the parameters specified in table 7.3.1.2.1a the BLER shall not exceed the piece-wise linear BLER curve specified in table 7.3.1.2.1b. These requirements are applicable for TFCS size 16.

The reference for this requirement is TS 25.102 clause 8.3.1.1.1.

**Table 7.3.1.2.1a: DCH parameters in multipath Case 1 channel (3,84 Mcps TDD Option)**

Parameters	Unit	Test 1	Test 2	Test 3	Test 4	Test 5
$\frac{\Sigma DPCH - E_c}{I_{or}}$	DB	-6	-3	0	0	0
$I_{oc}$	dBm/3,84 MHz	-60				
Cell Parameter (note)						
DPCH Channelization Codes (note)	C(k,Q)	C(i,16) i=1,2	C(i,16) i=1 .5	C(i,16) i=1 .9	C(i,16) i=1 .8	-
OCNS Channelization Code (note)	C(k,Q)	C(3,16)	C(6,16)	-	-	-
Information Data Rate	kbps	12,2	64	144	384	2048

Note: Refer to TS 25.223 for definition of channelization codes and cell parameter.

**Table 7.3.1.2.1b: Performance requirements in multipath Case 1 channel (3,84 Mcps TDD Option)**

Test Number	$\frac{\hat{I}_{or}}{I_{oc}}$ [dB]	BLER
1	13,9	$10^{-2}$
2	13,7	$10^{-1}$
3	19,8	$10^{-2}$
	14,1	$10^{-1}$
4	20,6	$10^{-2}$
	13,8	$10^{-1}$
5	20,0	$10^{-2}$
	13,2	$10^{-1}$
	17,8	$10^{-2}$

### 7.3.1.2.2 1,28 Mcps TDD Option

For the parameters specified in table 7.3.1.2.2a the BLER should not exceed the piece-wise linear BLER curve specified in table 7.3.1.2.2b. The reference for this requirement is TS 25.102 [1] clause 8.3.1.1.2.

**Table 7.3.1.2.2a: DCH parameters in a multipath Case 1 channel (1,28 Mcps TDD Option)**

Parameters	Unit	Test 1	Test 2	Test 3	Test 4
Number of DPCH <sub>o</sub>		8	2	2	0
Scrambling code and basic midamble code number (see note)		0	0	0	0
DPCH Channelization Codes (see note)	C(k,Q)	C(i,16) i=1,2	C(i,16) i=1...8	C(i,16) i=1...8	C(i,16) i=1...9
DPCH <sub>o</sub> Channelization Codes (see note)	C(k,Q)	C(i,16) 3 ≤ i ≤ 10	C(i,16) 9 ≤ i ≤ 10	C(i,16) 9 ≤ i ≤ 10	-
$\frac{DPCH_o - E_c}{I_{or}}$	DB	-10	-10	-10	0
$I_{oc}$	dBm/1,28MHz	-60			
Midamble					
Information Data Rate	Kbps	12.2	64	144	384

Note: Refer to TS 25.223 for definition of channelization codes, scrambling code and basic midamble code.



**Table 7.3.1.2.2b: Performance requirements in a multipath Case 1 channel (1,28 Mcps TDD Option)**

Test Number	$\frac{\hat{I}_{or}}{I_{oc}}$ [dB]	BLER
1	22.4	$10^{-2}$
2	15.8	$10^{-1}$
	22.9	$10^{-2}$
3	16.6	$10^{-1}$
	23.9	$10^{-2}$
4	15.5	$10^{-1}$
	21.4	$10^{-2}$

### 7.3.1.2.3 7,68 Mcps TDD Option

For the parameters specified in table 7.3.1.2.3a the BLER shall not exceed the piece-wise linear BLER curve specified in table 7.3.1.2.3b. This requirements is applicable for TFCS size 16.

The reference for this requirement is TS 25.102 clause 8.3.1.1.3.

**Table 7.3.1.2.3a: DCH parameters in multipath Case 1 channel (7,68 Mcps TDD Option)**

Parameters	Unit	Test 1
$\frac{\Sigma DPCH - E_c}{I_{or}}$	dB	-9
$I_{oc}$	dBm/7.68 MHz	-60
Cell Parameter*	-	0,1
DPCH Channelization Codes*	C(k, Q)	C(i, 32), i = 1,2
OCNS Channelization Code*	C(k, Q)	C(3, 32)
Information Data Rate	kbps	12.2
*Note: Refer to TS 25.223 for definition of channelization codes and cell parameter.		

**Table 7.3.1.2.3b: Performance requirements in multipath Case 1 channel (7,68 Mcps TDD Option)**

Test Number	$\frac{\hat{I}_{or}}{I_{oc}}$ [dB]	BLER
1	13.9	$10^{-2}$

### 7.3.1.3 Test purpose

While the receiver tests in clause 6 aims for the RF hardware, this performance requirement aims for the receiver's signal processing.

The test purpose is to verify the ability of the receiver to receive a predefined test signal, representing a multipath propagation channel for the wanted and for the co-channel signals from serving and adjacent cells, with a block error ratio (BLER) not exceeding a specified value.

### 7.3.1.4 Method of test

#### 7.3.1.4.1 Initial conditions

Test environment: normal; see clauses G.2.1 and G.2.2.

Frequencies to be tested: mid range; see clause G.2.4.

- 1) Connect the SS, , the fading simulator, the AWGN generator and additional components to the UE antenna connector as shown in figure A.10.
- 2) A call is set up according to the Generic call setup procedure. The characteristic of the call shall be according to the DL reference measurement channels (12,2 kbit/s), (64 kbit/s), (144 kbit/s), and (384 kbit/s) specified in

annex C for 3.84 Mcps TDD option and 1.28Mcps TDD option. The characteristic of the call shall be according to the DL reference measurement channels (12,2 kbit/s) for 7.68 Mcps TDD option.

- 3) Enter the UE into loopback test mode and start the loopback test. (test 1) and/or activate the Ack/Nack test mode (test 1 to test 4).
- 4) The levels of the wanted signal and the co-channel signals are set according to table 7.3.1.2.1a and b for the 3,84 Mcps TDD Option, table 7.3.1.2.2a and b for the 1,28 Mcps TDD Option and table 7.3.1.2.3a and b for the 7,68 Mcps TDD Option, respectively.

#### 7.3.1.4.2 Procedure

Measure the BLER of DCH received from the UE at the SS for all tests specified in table 7.3.1.2.1a for the 3,84 Mcps TDD Option, table 7.3.1.2.2a for the 1,28 Mcps TDD Option and table 7.3.1.2.3a for the 7,68 Mcps TDD Option, respectively.

#### 7.3.1.5 Test requirements

##### 7.3.1.5.1 3.84Mcps TDD Option

The measured BLER shall not exceed the values indicated in table 7.3.1.2.1b for the 3,84 Mcps TDD Option

##### 7.3.1.5.2 1.28Mcps TDD Option

The measured BLER shall not exceed the values indicated in table 7.3.1.5.2b for the 1.28 Mcps TDD Option

**Table 7.3.1.5.2b: Performance requirements in a multipath Case 1 channel (1,28 Mcps TDD Option)**

Test Number	$\frac{\hat{I}_{or}}{I_{oc}}$ [dB]	BLER
1	23.0	$10^{-2}$
2	16.4	$10^{-1}$
	23.5	$10^{-2}$
3	17.2	$10^{-1}$
	24.5	$10^{-2}$
4	16.2	$10^{-1}$
	22.0	$10^{-2}$

##### 7.3.1.5.3 7.68Mcps TDD Option

The measured BLER shall not exceed the values indicated in table 7.3.1.2.3b for the 7.68 Mcps TDD Option

NOTE: If the Test Requirement differs from the Minimum Requirement then the Test Tolerance applied for this test is non-zero. The Test Tolerance for this test is defined in clause F.2 and the explanation of how the Minimum Requirement has been relaxed by the Test Tolerance is given in clause F.4.

### 7.3.2 Multipath fading Case 2

#### 7.3.2.1 Definition and applicability

The performance requirement of DCH is determined by the maximum Block Error Ratio (BLER). The BLER is specified for each individual data rate of the DCH. DCH is mapped into the Dedicated Physical Channel (DPCH).

The UE shall be tested only according to the data rates, supported. The data-rate-corresponding requirements shall apply to the UE.

The requirements and this test apply to all types of UTRA TDD UE.

### 7.3.2.2 Minimum requirement

#### 7.3.2.2.1 3,84 Mcps TDD Option

For the parameters specified in table 7.3.2.2.1a the BLER should not exceed the piece-wise linear BLER curve specified in table 7.3.2.2.1b. These requirements are applicable for TFCS size 16.

The reference for this requirement is TS 25.102 [1] clause 8.3.2.1.

**Table 7.3.2.2.1a: DCH parameters in multipath Case 2 channel (3,84 Mcps TDD Option)**

Parameters	Unit	Test 1	Test 2	Test 3	Test 4	Test 5
$\frac{\Sigma DPCH - E_c}{I_{or}}$	DB	-3	0	0	0	0
$I_{oc}$	dBm/3,84 MHz	-60				
Cell Parameter (note)		0,1				
DPCH Channelization Codes (note)	C(k,Q)	C(i,16) i=1,2	C(i,16) i=1 .5	C(i,16) i=1 .9	C(i,16) i=1 .8	-
OCNS Channelization Code (note)	C(k,Q)	C(3,16)	-	-	-	-
Information Data Rate	kbps	12,2	64	144	384	2048

Note: Refer to TS 25.223 for definition of channelization codes and cell parameter.

**Table 7.3.2.2.1b: Performance requirements in multipath Case 2 channel (3,84 Mcps TDD Option)**

Test Number	$\frac{\hat{I}_{or}}{I_{oc}}$ [dB]	BLER
1	5,8	$10^{-2}$
2	5,7	$10^{-1}$
	9,2	$10^{-2}$
3	9,3	$10^{-1}$
	12,7	$10^{-2}$
4	8,8	$10^{-1}$
	12,0	$10^{-2}$
5	10,3	$10^{-1}$
	12,7	$10^{-2}$

#### 7.3.2.2.2 1,28 Mcps TDD Option

For the parameters specified in table 7.3.2.2.2a: the BLER should not exceed the piece-wise linear BLER curve specified in table 7.3.2.2.2b. The reference for this requirement is TS 25.102 [1] clause 8.3.2.1.2.

**Table 7.3.2.2.2a: DCH parameters in multipath Case 2 channel (1,28 Mcps TDD Option)**

Parameters	Unit	Test 1	Test 2	Test 3	Test 4
Number of DPCH <sub>o</sub>		8	2	2	0
Scrambling code and basic midamble code number (see note)		0	0	0	0
DPCH Channelization Codes (see note)	C(k,Q)	C(i,16) i=1,2	C(i,16) i=1...8	C(i,16) i=1...8	C(i,16) i=1...9
DPCH <sub>o</sub> Channelization Codes (see note)	C(k,Q)	C(i,16) 3 ≤ i ≤ 10	C(i,16) 9 ≤ i ≤ 10	C(i,16) 9 ≤ i ≤ 10	-
$\frac{DPCH_o - E_c}{I_{or}}$	dB	-10	-10	-10	0
$I_{oc}$	dBm/1,28MHz	-60			
Midamble		Common midamble			
Information Data Rate	Kbps	12.2	64	144	384
Note	Refer to TS 25.223 for definition of channelization codes, scrambling code and basic midamble code.				

**Table 7.3.2.2.2b: Performance requirements in multipath Case 2 channel (1,28 Mcps TDD Option)**

Test Number	$\frac{\hat{I}_{or}}{I_{oc}}$ [dB]	BLER
1	13.6	10 <sup>-2</sup>
2	9.8	10 <sup>-1</sup>
	13.9	10 <sup>-2</sup>
3	10.3	10 <sup>-1</sup>
	14.4	10 <sup>-2</sup>
4	11.4	10 <sup>-1</sup>
	15.0	10 <sup>-2</sup>

### 7.3.2.2.3 7,68 Mcps TDD Option

For the parameters specified in table 7.3.2.2.3a the BLER should not exceed the piece-wise linear BLER curve specified in table 7.3.2.2.3b. These requirements are applicable for TFCS size 16.

The reference for this requirement is TS 25.102 [1] clause 8.3.2.1.3.

**Table 7.3.2.2.3a: DCH parameters in multipath Case 2 channel (7,68 Mcps TDD Option)**

Parameters	Unit	Test 1
$\frac{\Sigma DPCH - E_c}{I_{or}}$	dB	-6
$I_{oc}$	dBm/7.68 MHz	-60
Cell Parameter (note)	-	0,1
DPCH Channelization Codes (note)	C(k, Q)	C(i, 32), i = 1,2
OCNS Channelization Code (note)	C(k, Q)	C(3, 32)
Information Data Rate	kbps	12.2
NOTE:	Refer to TS 25.223 for definition of channelization codes and cell parameter.	

**Table 7.3.2.2.3b: Performance requirements in multipath Case 2 channel (7,68 Mcps TDD Option)**

Test Number	$\frac{\hat{I}_{or}}{I_{oc}}$ [dB]	BLER
1	5.8	10 <sup>-2</sup>

### 7.3.2.3 Test purpose

While the receiver tests in clause 6 aims for the RF hardware, this performance requirement aims for the receiver's signal processing.

The test purpose is to verify the ability of the receiver to receive a predefined test signal, representing a multipath propagation channel for the wanted and for the co-channel signals from serving and adjacent cells, with a block error ratio (BLER) not exceeding a specified value.

### 7.3.2.4 Method of test

#### 7.3.2.4.1 Initial conditions

Test environment: normal; see clauses G.2.1 and G.2.2.

Frequencies to be tested: mid range; see clause G.2.4.

- 1) Connect the SS, the fading simulator, the AWGN generator and additional components to the UE antenna connector as shown in figure A.10.
- 2) A call is set up according to the Generic call setup procedure. The characteristic of the call shall be according to the DL reference measurement channels (12,2 kbit/s) (64 kbit/s), (144 kbit/s), and (384 kbit/s) specified in annex C for 3.84 Mcps TDD option and 1.28 Mcps TDD option. The characteristic of the call shall be according to the DL reference measurement channels (12,2 kbit/s) for 7.68 Mcps TDD option.
- 3) Enter the UE into loopback test mode and start the loopback test. (test 1) and/or activate the Ack/Nack test mode (test 1 to test 4).
- 4) The levels of the wanted signal and the co-channel signals are set according to table 7.3.2.2.1a and b for the 3,84 Mcps TDD Option, table 7.3.2.2.2a and b for the 1,28 Mcps TDD Option and table 7.3.2.2.3a and b for the 7,68 Mcps TDD Option, respectively.

#### 7.3.2.4.2 Procedure

Measure the BLER of DCH received from the UE at the SS for all tests specified in table 7.3.2.2.1a for the 3,84 Mcps TDD Option, table 7.3.2.2.2a for the 1,28 Mcps TDD Option and table 7.3.2.2.3a for the 7,68 Mcps TDD Option, respectively.

### 7.3.2.5 Test requirements

#### 7.3.2.5.1 3.84Mcps TDD Option

The measured BLER shall not exceed the values indicated in table 7.3.2.2.1b for the 3,84 Mcps TDD Option

#### 7.3.2.5.2 1.28Mcps TDD Option

The measured BLER shall not exceed the values indicated in table 7.3.2.5.2b for the 1,28 Mcps TDD Option

**Table 7.3.2.5.2b: Performance requirements in multipath Case 2 channel (1,28 Mcps TDD Option)**

Test Number	$\frac{\hat{I}_{or}}{I_{oc}}$ [dB]	BLER
1	14.2	$10^{-2}$
2	10.4	$10^{-1}$
	14.5	$10^{-2}$
3	10.9	$10^{-1}$
	15.0	$10^{-2}$
4	12.0	$10^{-1}$
	15.6	$10^{-2}$

#### 7.3.2.5.3 7.68Mcps TDD Option

The measured BLER shall not exceed the values indicated in table 7.3.2.2.3b for the 7.68 Mcps TDD Option

NOTE: If the Test Requirement differs from the Minimum Requirement then the Test Tolerance applied for this test is non-zero. The Test Tolerance for this test is defined in clause F.2 and the explanation of how the Minimum Requirement has been relaxed by the Test Tolerance is given in clause F.4.

## 7.3.3 Multipath fading Case 3

### 7.3.3.1 Definition and applicability

The performance requirement of DCH is determined by the maximum Block Error Ratio (BLER). The BLER is specified for each individual data rate of the DCH. DCH is mapped into the Dedicated Physical Channel (DPCH).

The UE shall be tested only according to the datarates, supported. The data-rate-corresponding requirements shall apply to the UE.

The requirements and this test apply to all types of UTRA TDD UE.

### 7.3.3.2 Minimum requirements

#### 7.3.3.2.1 3,84 Mcps TDD Option

For the parameters specified in table 7.3.3.2.1a the BLER should not exceed the piece-wise linear BLER curve specified in table 7.3.3.2.1b. These requirements are applicable for TFCS size 16.

The reference for this requirement is 3G TS 25.102 clause 8.3.3.1.1.

**Table 7.3.3.2.1a: DCH parameters in multipath Case 3 channel (3,84 Mcps TDD Option)**

Parameters	Unit	Test 1	Test 2	Test 3	Test 4	Test 5
$\frac{\Sigma DPCH - E_c}{I_{or}}$	DB	-3	0	0	0	0
$I_{oc}$	dBm/3,84 MHz	-60				
Cell Parameter (note)		0,1				
DPCH Channelization Codes (note)	C(k,Q)	C(i,16) i=1,2	C(i,16) i=1 .5	C(i,16) i=1 .9	C(i,16) i=1 .8	-
OCNS Channelization Code (note)	C(k,Q)	C(3,16)	-	-	-	-
Information Data Rate	kbps	12,2	64	144	384	2048

Note: Refer to TS 25.223 for definition of channelization codes and cell parameter.

**Table 7.3.3.2.1b: Performance requirements in multipath Case 3 channel (3,84 Mcps TDD Option)**

Test Number	$\frac{\hat{I}_{or}}{I_{oc}}$ [dB]	BLER
1	4,8	$10^{-2}$
2	5,8	$10^{-1}$
	8,5	$10^{-2}$
	10,7	$10^{-3}$
3	10,3	$10^{-1}$
	13,3	$10^{-2}$
	16,0	$10^{-3}$
4	8,9	$10^{-1}$
	11,5	$10^{-2}$
	13,6	$10^{-3}$
5	9,4	$10^{-1}$
	11,5	$10^{-2}$
	13,6	$10^{-3}$

#### 7.3.3.2.2 1,28 Mcps TDD Option

For the parameters specified in table 7.3.3.2.2a the BLER should not exceed the piece-wise linear BLER curve specified in table 7.3.3.2.2b. The reference for this requirement is TS 25.102 [1] clause 8.3.3.1.2.

**Table 7.3.3.2.2a: DCH parameters in multipath Case 3 channel (1,28 Mcps TDD Option)**

Parameters	Unit	Test 1	Test 2	Test 3	Test 4
Number of DPCH <sub>o</sub>		8	2	2	0
Scrambling code and basic midamble code number (see note)		0	0	0	0
DPCH Channelization Codes (see note)	C(k,Q)	C(i,16) i=1,2	C(i,16) i=1...8	C(i,16) i=1...8	C(i,16) i=1...9
DPCH <sub>o</sub> Channelization Codes (see note)	C(k,Q)	C(i,16) 3 ≤ i ≤ 10	C(i,16) 9 ≤ i ≤ 10	C(i,16) 9 ≤ i ≤ 10	-
$\frac{DPCH_o - E_c}{I_{or}}$	dB	-10	-10	-10	0
$I_{oc}$	dBm/1,28MHz	-60			
Midamble		Common midamble			
Information Data Rate	Kbps	12.2	64	144	384
Note	Refer to TS 25.223 for definition of channelization codes, scrambling code and basic midamble code.				

**Table 7.3.3.2.2b: Performance requirements in multipath Case 3 channel (1,28 Mcps TDD Option)**

Test Number	$\frac{\hat{I}_{or}}{I_{oc}}$ [dB]	BLER
1	11.7	10 <sup>-2</sup>
2	9.0	10 <sup>-1</sup>
	11.7	10 <sup>-2</sup>
	14.3	10 <sup>-3</sup>
3	9.1	10 <sup>-1</sup>
	11.2	10 <sup>-2</sup>
	12.7	10 <sup>-3</sup>
4	9.9	10 <sup>-1</sup>
	11.2	10 <sup>-2</sup>
	12.4	10 <sup>-3</sup>

7.3.3.2.3 7,68 Mcps TDD Option

For the parameters specified in table 7.3.3.2.3a the BLER should not exceed the piece-wise linear BLER curve specified in table 7.3.3.2.3b. These requirements are applicable for TFCS size 16.

The reference for this requirement is 3G TS 25.102 clause 8.3.3.1.3.

**Table 7.3.3.2.3a: DCH parameters in multipath Case 3 channel (7,68 Mcps TDD Option)**

Parameters	Unit	Test 1
$\frac{\Sigma DPCH - E_c}{I_{or}}$	dB	-6
$I_{oc}$	dBm/7.68 MHz	-60
Cell Parameter*	-	0,1
DPCH Channelization Codes*	C(k, Q)	C(i, 32), i = 1,2
OCNS Channelization Code*	C(k, Q)	C(3, 32)
Information Data Rate	kbps	12.2
*Note:	Refer to TS 25.223 for definition of channelization codes and cell parameter.	

**Table 7.3.3.2.3b: Performance requirements in multipath Case 3 channel (7,68 Mcps TDD Option)**

Test Number	$\frac{\hat{I}_{or}}{I_{oc}}$ [dB]	BLER
1	4.8	10 <sup>-2</sup>

### 7.3.3.3 Test purpose

While the receiver tests in clause 6 aims for the RF hardware, this performance requirement aims for the receiver's signal processing.

The test purpose is to verify the ability of the receiver to receive a predefined test signal ,representing a multipath propagation channel for the wanted and for the co-channel signals from serving and adjacent cells, with a block error ratio (BLER) not exceeding a specified value.

### 7.3.3.4 Method of test

#### 7.3.3.4.1 Initial conditions

Test environment: normal; see clauses G.2.1 and G.2.2.

Frequencies to be tested: mid range; see clause G.2.4.

- 1) Connect the SS, the fading simulator, the AWGN generator and additional components to the UE antenna connector as shown in figure A.10.
- 2) A call is set up according to the Generic call setup procedure. The characteristic of the call shall be according to the DL reference measurement channels (12,2 kbit/s)(64 kbit/s), (144 kbit/s), and (384 kbit/s) specified in annex C for 3.84 Mcps TDD option and 1.28Mcps TDD option. The characteristic of the call shall be according to the DL reference measurement channels (12,2 kbit/s) for 7.68 Mcps TDD option.
- 3) Enter the UE into loopback test mode and start the loopback test. (test 1) and/or activate the Ack/Nack test mode (test 1 to test 4).
- 4) The levels of the wanted signal and the co-channel signals are set according to table 7.3.3.2.1a and b for the 3,84 Mcps TDD Option, table 7.3.3.2.2a and b for the 1,28 Mcps TDD Option and table 7.3.3.2.3a and b for the 7,68 Mcps TDD Option, respectively.

#### 7.3.3.4.2 Procedure

Measure the BLER of DCH received from the UE at the SS for all tests specified in table 7.3.3.2.1a for the 3,84 Mcps TDD Option, table 7.3.3.2.2a for the 1,28 Mcps TDD Option and table 7.3.3.2.3a for the 7,68 Mcps TDD Option, respectively.

### 7.3.3.5 Test requirements

#### 7.3.3.5.1 3.84Mcps TDD Option

The measured BLER shall not exceed the values indicated in table 7.3.3.2.1b for the 3,84 Mcps TDD Option

#### 7.3.3.5.2 1.28Mcps TDD Option

The measured BLER shall not exceed the values indicated in table 7.3.3.5.2b for the1.28 Mcps TDD Option

**Table 7.3.3.5.2b: Performance requirements in multipath Case 3 channel (1,28 Mcps TDD Option)**

Test Number	$\frac{\hat{I}_{or}}{I_{oc}}$ [dB]	BLER
1	12.3	$10^{-2}$
2	9.6	$10^{-1}$
	12.3	$10^{-2}$
	14.9	$10^{-3}$
3	10.0	$10^{-1}$
	11.8	$10^{-2}$
	13.3	$10^{-3}$
4	10.5	$10^{-1}$
	11.8	$10^{-2}$
	13.0	$10^{-3}$



### 7.3.3.5.3 7.68Mcps TDD Option

The measured BLER shall not exceed the values indicated in table 7.3.3.2.3b for the 7.68Mcps TDD Option.

NOTE: If the Test Requirement differs from the Minimum Requirement then the Test Tolerance applied for this test is non-zero. The Test Tolerance for this test is defined in clause F.2 and the explanation of how the Minimum Requirement has been relaxed by the Test Tolerance is given in clause F.4.

## 7.3A Demodulation of DCH in High speed train conditions

### 7.3A.1 Definition and applicability

#### 7.3A.1.1 3,84 Mcps TDD Option

<void>

#### 7.3A.1.2 1,28 Mcps TDD Option

The performance requirement of DCH in high speed train conditions is determined by the maximum Block Error Ratio (BLER). The BLER is specified for each individual data rate of the DCH. DCH is mapped into the Dedicated Physical Channel (DPCH).

The UE shall be tested only according to the datarates, supported. The data-rate-corresponding requirements shall apply to the UE.

The requirements and this test apply to all types of 1.28 Mcps TDD UE of Release 9 and later.

#### 7.3A.1.3 3,84 Mcps TDD Option

<void>

### 7.3A.2 Minimum requirements

#### 7.3A.2.1 3,84 Mcps TDD Option

<void>

#### 7.3A.2.2 1,28 Mcps TDD Option

For the parameters specified in table 7.3A.2.2a the BLER should not exceed the piece-wise linear BLER curve specified in table 7.3A.2.2b. The reference for this requirement is TS 25.102 [1] clause 8.3A.2.2.

**Table 7.3A.2.2a: DCH parameters in high speed train condition**

Parameters	Unit	Test 1	Test 2
Number of DPCHo		8	2
Scrambling code and basic midamble code number*		0	0
DPCH Channelization Codes*		C(i,16) i=1,2	C(i,16) i=1...8
DPCH <sub>o</sub> Channelization Codes*	C(k,Q)	C(i,16) 3 ≤ i ≤ 10	C(i,16) 9 ≤ i ≤ 10
$\frac{DPCH_o - E_c}{I_{or}}$	C(k,Q)	-10	-10
loc	dBm/1.28MHz	-60	
Information Data Rate	Kbps	12.2	64
*Note: Refer to TS 25.223 for definition of channelization codes and cell parameter.			

**Table 7.3A.2.2b: Performance requirements in high speed train condition**

Test Number	$\frac{\hat{I}_{or}}{I_{oc}}$	BLER
1	8.5	$10^{-2}$
2	6.2	$10^{-1}$
	8.5	$10^{-2}$

### 7.3A.2.3 7,68 Mcps TDD Option

<void>

### 7.3A.3 Test purpose

While the receiver tests in clause 6 aims for the RF hardware, this performance requirement aims for the receiver's signal processing.

The test purpose is to verify the ability of the receiver to receive a predefined test signal ,representing a high speed train channel for the wanted and for the co-channel signals from serving and adjacent cells, with a block error ratio (BLER) not exceeding a specified value.

### 7.3A.4 Method of test

#### 7.3A.4.1 Initial conditions

Test environment: normal; see clauses G.2.1 and G.2.2.

Frequencies to be tested: mid range; see clause G.2.4.

- 1) Connect the SS, the AWGN noise source and additional components to the UE antenna connector as shown in figure A.10.
- 2) A call is set up according to the Generic call setup procedure. The characteristic of the call shall be according to the DL reference measurement channels (12,2 kbit/s) and (64 kbit/s) specified in annex C 1.28Mcps TDD option.
- 3) Enter the UE into loopback test mode and start the loopback test.
- 4) Setup fading simulator as High speed train conditions, which is described in clause D.2.4A.
- 5) The levels of the wanted signal and the co-channel signals are set according to table 7.3A.2.2a for the 1,28 Mcps TDD Option.

#### 7.3A.4.2 Procedure

Measure the BLER of DCH received from the UE at the SS for all tests specified in table 7.3A.2.2a for the 1,28 Mcps TDD Option.

### 7.3A.5 Test requirements

#### 7.3A.5.1 3.84Mcps TDD Option

<void>

#### 7.3A.5.2 1.28Mcps TDD Option

The measured BLER shall not exceed the values indicated in table 7.3A.3.2a for the 1.28 Mcps TDD Option

**Table 7.3A.5.2a: Performance requirements in high speed train condition**

Test Number	$\frac{\hat{I}_{or}}{I_{oc}}$	BLER
1	9.1	$10^{-2}$
2	6.8	$10^{-1}$
	9.1	$10^{-2}$

### 7.3A.5.3 7.68Mcps TDD Option

<void>

NOTE: If the Test Requirement differs from the Minimum Requirement then the Test Tolerance applied for this test is non-zero. The Test Tolerance for this test is defined in clause F.2 and the explanation of how the Minimum Requirement has been relaxed by the Test Tolerance is given in clause F.4.

## 7.4 Base station transmit diversity mode for 3,84 Mcps TDD Option

### 7.4.1 Demodulation of BCH in SCTD mode

This is not tested.

## 7.5 Power control in downlink

### 7.5.1 Definition and applicability

Power control in the uplink is the ability of the UE to converge to the required link quality set by the network while using minimum uplink power. The requirements of this test shall apply to the UTRA-TDD UE.

### 7.5.2 Power control in downlink for 3,84 Mcps TDD option, constant BLER Target

#### 7.5.2.1 Minimum requirements

For the parameters specified in table 7.5.2.1 the downlink  $\hat{I}_{or}/I_{oc}$  averaged over one timeslot shall be below the specified value in table 7.5.2 more than 90% of the time. BLER shall be as shown in table 7.5.2.2 Downlink power control is ON during the test.

**Table 7.5.2.1: Test parameters for downlink power control - constant BLER Target**

Parameter	Unit	Test 1
$\frac{DPCH - E_c}{I_{or}}$	dB	0
$I_{oc}$	dBm/3,84 MHz	-60
Information Data Rate	kbps	12,2
Target quality value on DTCH	BLER	0,01
Propagation condition		Case 1
DL Power Control step size, $\Delta_{TPC}$	dB	1
Maximum_DL_power (note)	dB	0
Minimum_DL_power (note)	dB	-27
NOTE: Refer to TS 25.224 for description and definition		

NOTE: DL power is relative to P-CCPCH power.

**Table 7.5.2.2: Requirements for downlink power control - constant BLER Target**

Parameter	Unit	Test 1
$\hat{I}_{or}/I_{oc}$	dB	8,5
Measured quality on DTCH	BLER	0,01±30%

The reference for this requirement is TS 25.102 [1] clause 8.5.1.

### 7.5.2.2 Test purpose

To verify that the UE receiver is capable of converging to the required link quality set by the network while using as low power as possible.

### 7.5.2.3 Method of test

#### 7.5.2.3.1 Initial conditions

Test environment: normal; see clauses G.2.1 and G.2.2.

Frequencies to be tested: mid range; see clause G.2.4.

- 1) Connect SS, multipath fading simulator and an AWGN source to the UE antenna connector as shown in figure A.10.
- 2) Set up a call according to the Generic call setup procedure.
- 3) RF parameters are set up according to table 7.5.2.1
- 4) Enter the UE into loopback test mode and start the loopback test.
- 5) SS signals to UE target quality value on DTCH as specified in table 7.5.2.1. SS will vary the physical channel power in downlink according to the TPC commands from UE, and at the same time measure BLER. This is continued until the target quality value on DTCH is met, within the minimum accuracy requirement.

See TS 34.108 [3] and TS 34.109 [4] for details regarding generic call setup procedure and loopback test.

#### 7.5.2.3.2 Procedure

- 1) After the target quality on DTCH is met, BLER is measured. Simultaneously the downlink  $\hat{I}_{or}/I_{oc}$  power ratio averaged over one slot is measured. This is repeated until adequate amount of measurements is done to reach the required confidence level.
- 2) The measured quality on DTCH (BLER) and the measured downlink  $\hat{I}_{or}/I_{oc}$  power ratio values averaged over one slot are compared to the limits in table 7.5.2.2.

### 7.5.2.4 Test Requirements

- a) The measured quality on DTCH does not exceed the values in table 7.5.2.2.
- b) The downlink  $\hat{I}_{or}/I_{oc}$  power ratio values, which are averaged over one slot, shall be below the values in table 7.5.2.2 more than 90 % of the time.

## 7.5.3 Power control in downlink for 1,28 Mcps TDD option, constant BLER Target(Release 6 and earlier)

### 7.5.3.1 Definition and applicability

Power control in the downlink is the ability of the UE receiver to converge to required link quality set by the network while using as low power as possible in downlink. If a BLER target has been assigned to a DCCH (See clause C.3),

then it has to be such that outer loop is based on DTCH and not on DCCH. The requirements and this test apply to all types of UTRA for the 1,28 Mcps TDD UE Release 6 and earlier releases.

### 7.5.3.2 Minimum requirements

For the parameters specified in table 7.5.3.1 the downlink  $\hat{I}_{or}/I_{oc}$  averaged over one timeslot power shall be below the specified value in table 7.5.3.2 more than 90% of the time. BLER shall be as shown in table 7.5.3.2. Downlink power control is ON during the test.

**Table 7.5.3.1: Test parameters for downlink power control – constant BLER Target**

Parameter	Unit	Value
$\frac{\Sigma DPCH - E_c}{I_{or}}$	dB	0
$I_{oc}$	dBm/1.28 MHz	-60
Information data rate	kbps	12.2
Target quality on DTCH	BLER	0.01
Propagation condition	Case 1	
DL Power Control step size, $\Delta_{TPC}$	dB	1
Maximum_DL_power *	dB	0
Minimum_DL_power *	dB	-27

Note: DL power is compared to P-CCPCH power.

**Table 7.5.3.2: Requirements for downlink power control – constant BLER Target**

Parameter	Unit	Test 1	
$\hat{I}_{or}/I_{oc}$	dB	7.5	
Measured quality on DTCH	BLER	0,01±30%	

The reference for this requirement is TS 25.102 [1] clause 8.5.1.

### 7.5.3.3 Test purpose

To verify that the UE receiver is capable of converging to the required link quality set by the network while using as low power as possible.

### 7.5.3.4 Method of test

#### 7.5.3.4.1 Initial conditions

Test environment: normal; see clauses G.2.1 and G.2.2.

Frequencies to be tested: mid range; see clause G.2.4.

- 1) Connect SS, multipath fading simulator and an AWGN source to the UE antenna connector as shown in figure A.10.
- 2) Set up a call according to the Generic call setup procedure.
- 3) RF parameters are set up according to table 7.5.3.1
- 4) Enter the UE into loopback test mode and start the loopback test.

- 5) SS signals to UE target quality value on DTCH as specified in table 7.5.3.1. SS will vary the physical channel power in downlink according to the TPC commands from UE, and at the same time measure BLER. This is continued until the target quality value on DTCH is met, within the minimum accuracy requirement.

See TS 34.108 [3] and TS 34.109 [4] for details regarding generic call setup procedure and loopback test.

#### 7.5.3.4.2 Procedure

- 1) After the target quality on DTCH is met, BLER is measured. Simultaneously the downlink  $\hat{I}_{or}/I_{oc}$  power ratio averaged over one slot is measured. This is repeated until adequate amount of measurements is done to reach the required confidence level.
- 2) The measured quality on DTCH (BLER) and the measured downlink  $\hat{I}_{or}/I_{oc}$  power ratio values averaged over one slot are compared to the limits in table 7.5.3.2.

#### 7.5.3.5 Test Requirements

- a) The measured quality on DTCH does not exceed the values in table 7.5.3.2.
- b) The downlink  $\hat{I}_{or}/I_{oc}$  power ratio values, which are averaged over one slot, shall be below the values in table 7.5.3.2.

### 7.5.3A Power control in downlink for 1,28 Mcps TDD option, constant BLER Target(Release 7 and later)

#### 7.5.3A.1 Definition and applicability

Power control in the downlink is the ability of the UE receiver to converge to required link quality set by the network while using as low power as possible in downlink. If a BLER target has been assigned to a DCCH (See clause C.3), then it has to be such that outer loop is based on DTCH and not on DCCH. The requirements and this test apply to all types of UTRA for the 1,28 Mcps TDD UE Release 7 and later releases.

#### 7.5.3A.2 Minimum requirements

For the parameters specified in table 7.5.3A.1 the downlink  $\hat{I}_{or}/I_{oc}$  averaged over one timeslot power shall be below the specified value in table 7.5.3A.2 more than 90% of the time. BLER shall be as shown in table 7.5.3A.2. Downlink power control is ON during the test.

**Table 7.5.3A.1: Test parameters for downlink power control – constant BLER Target**

Parameter	Unit	Test 1	Test2	Test3	Test4	Test5	Test6
$\frac{\Sigma DPCH - E_c}{I_{or}}$	dB	0	0	0	0	0	0
$I_{oc}$	dBm/1.28 Mhz	-60	-60	-60	-60	-60	-60
Information data rate	kbps	12.2	12.2	64	64	64	64
Target quality on DTCH	BLER	0.01	0.01	0.1	0.1	0.001	0.001
Propagation condition		Case 1	Case3	Case 1	Case3	Case1	Case3
DL Power Control step size, $\Delta_{TPC}$	dB	1	1	1	1	1	1
Maximum_DL_power *	dB	0	0	0	0	0	0
Minimum_DL_power *	dB	-27	-27	-27	-27	-27	-27

NOTE: DL power is compared to P-CCPCH power.

**Table 7.5.3A.2: Requirements for downlink power control – constant BLER Target**

Parameter	Unit	Test 1	Test 2	Test 3	Test 4	Test5	Test 6
$\hat{I}_{or}/I_{oc}$	dB	7.5	4.8	9.1	8.9	17.9	13.1
Measured quality on DTCH	BLER	0.01±30%	0.01±30%	0.1±30%	0.1±30%	0.001±30%	0.001±30%

The reference for this requirement is TS 25.102 [1] clause 8.5.1.

### 7.5.3A.3 Test purpose

To verify that the UE receiver is capable of converging to the required link quality set by the network while using as low power as possible.

### 7.5.3A.4 Method of test

#### 7.5.3A.4.1 Initial conditions

Test environment: normal; see clauses G.2.1 and G.2.2.

Frequencies to be tested: mid range; see clause G.2.4.

- 1) Connect SS, multipath fading simulator and an AWGN source to the UE antenna connector as shown in figure A.10.
- 2) Set up a call according to the Generic call setup procedure.
- 3) RF parameters are set up according to table 7.5.3A.1
- 4) Enter the UE into loopback test mode and start the loopback test.
- 5) SS signals to UE target quality value on DTCH as specified in table 7.5.3A.1. SS will vary the physical channel power in downlink according to the TPC commands from UE, and at the same time measure BLER. This is continued until the target quality value on DTCH is met, within the minimum accuracy requirement.

See TS 34.108 [3] and TS 34.109 [4] for details regarding generic call setup procedure and loopback test.

#### 7.5.3A.4.2 Procedure

- 1) After the target quality on DTCH is met, BLER is measured. Simultaneously the downlink  $\hat{I}_{or}/I_{oc}$  power ratio averaged over one slot is measured. This is repeated until adequate amount of measurements is done to reach the required confidence level.
- 2) The measured quality on DTCH (BLER) and the measured downlink  $\hat{I}_{or}/I_{oc}$  power ratio values averaged over one slot are compared to the limits in table 7.5.3A.2.

### 7.5.3A.5 Test Requirements

- a) The measured quality on DTCH does not exceed the values in table 7.5.3A.2.
- b) The downlink  $\hat{I}_{or}/I_{oc}$  power ratio values, which are averaged over one slot, shall be below the values in table 7.5.3A.2.7.5.4 Power control in downlink for 7,68 Mcps TDD option, constant BLER Target

FFS

## 7.5.4 Power control in the downlink for 1,28 Mcps TDD option, wind up effects

### 7.5.4.1 Definition and applicability

This requirement verifies that, after the downlink maximum power is limited in the UTRAN and it has been released again, the downlink power control in the UE does not have a wind up effect, i.e. the required DL power has increased during time period the DL power was limited.

The requirements and this test apply to all types of 1.28 Mcps TDD UE of Release 7 and later.

### 7.5.4.2 Minimum requirements

This test is run in three stages where stage 1 is for convergence of the power control loop. In stage two the maximum downlink power for the dedicated channel is limited not to be higher than the parameter specified in table 7.5.4.1. All parameters used in the three stages are specified in table 7.5.4.1. The downlink Ior/Ioc power ratio measured values, which are averaged over one timeslot, during stage 3 shall be lower than the value specified in table 7.5.4.2 more than 90 % of the time. Power control of the UE is ON during the test.

**Table 7.5.4.1: Test parameter for downlink power control, wind-up effects**

Parameter	Test 1			Unit
	Stage 1	Stage 2	Stage 3	
Time in each stage	5	40	5	S
$I_{oc}$	-60			dBm/1,28 MHz
Information Data Rate	12,2			Kbps
Quality target on DTCH	0,01			BLER
Propagation condition	Case 1			
Maximum_DL_Power (Note 2)	0	$P$ (Note 1)	0	dB
Minimum_DL_Power (Note 2)	-27			dB
DL Power Control step size, $\Delta_{TPC}$	1			dB
Note 1:	$P$ is the level corresponding to the average Ior/Ioc power ratio - 3 dB compared to the P-CCPCH level. The average Ior/Ioc power ratio is measured during the initialisation stage after the power control loop has converged before the actual test starts.			
Note 2:	Power is compared to P-CCPCH.			

**Table 7.5.4.2: Requirements in downlink power control, wind-up effects**

Parameter	Test 1, stage 3	Unit
Ior/Ioc	9.1	dB

The reference for this requirement is TS 25.102 [1] clause 8.5.2.

### 7.5.4.3 Test purpose

To verify that the UE downlink power control does not require too high downlink power during a period after the downlink power is limited by the UTRAN.



#### 7.5.4.4 Method of test

##### 7.5.4.4.1 Initial conditions

Test environment: normal; see clauses G.2.1 and G.2.2.

Frequencies to be tested: mid range; see clause G.2.4.

- 1) Connect SS, multipath fading simulator and an AWGN source to the UE antenna connector as shown in figure A.10.
- 2) Set up a call according to the Generic call setup procedure.
- 3) Enter the UE into loopback test mode and start the loopback test. RF parameters are set up according to table 7.5.4.1. SS waits 15 seconds and then collects the Ior/Ioc power ratio measured values, which are averaged over one timeslot, over 80 second period. The average of these Ior/Ioc values is then calculated and 3dB is subtracted from it to get the power value P, which will then be used during the stage 2 in the test procedure.

See TS 34.108 [3] and TS 34.109 [4] for details regarding generic call setup procedure and loopback test.

##### 7.5.4.4.2 Procedure

- 1) RF parameters are set up according to table 7.5.4.1. Stage 1 is used for the power control to converge and During Stage 2 the maximum downlink power is limited by UTRAN.
- 2) SS will vary the physical channel power in downlink according to the TPC commands from UE during stages 1, 2, and 3.
- 3) Measure Ior/Ioc power ratio during stage 3 according to table 7.5.4.1.
- 4) Repeat steps 1) to 3) 230 times.

NOTE: The number of repetitions (230) is derived from minimum testing time for 3 km/h fading channels (Table F.6.1.6.2; 1168 seconds).

#### 7.5.4.5 Test Requirements

The downlink Ior/Ioc power ratio values, which are averaged over one timeslot during stage 3, shall be lower than the level specified in table 7.5.4.2 during stage 3 more than 90 % of the time.

## 7.6 Uplink Power Control

### 7.6.1 Definition and applicability

Power control in the uplink is the ability of the UE to converge to the required link quality set by the network while using minimum uplink power. The requirements of this test shall apply to all types of the UTRA-TDD UE.

### 7.6.2 Minimum requirements

During period T1, the PCCPCH and a second Beacon Channel are transmitted in the DL in designated slots within each frame and at the same power level.

The UE transmits, using the channel of TS25.105, Annex A.2.1 UL reference measurement channel (12.2 kbps) in one UL slot. For different parts of the test, different UL slots will be designated.

The values of table 7.6.1, period T1 shall be selected. Then, with the received PCCPCH and Beacon power set at -60 dBm, the value of DPCH constant value shall be adjusted so that the mean UE output power is 5 dBm. These conditions are held steady during period T1.

Periods T1 and T2 are each 5 seconds long.

**Table 7.6.1: UL Power Control Test Conditions**

		Period T1	Period T2
$I_{BTS}$ all slots	dBm	-60	
PCCPCH Power -Broadcast	dBm	18	
PCCPCH Power - Received	dBm	-60	-70
Mean UE transmit power	dBm	5	According to tables 7.6.2 and 7.6.3
$SIR_{TARGET}$	dB	6	
$I_{oc}$ in PCCPCH and Beacon Slots	dBm	-60	
IE (information element) Alpha	As defined in 25.331	1.0	
PCCPCH slot position	Integer 0 -14	0	
Beacon slot position	Integer 0 -14	8	

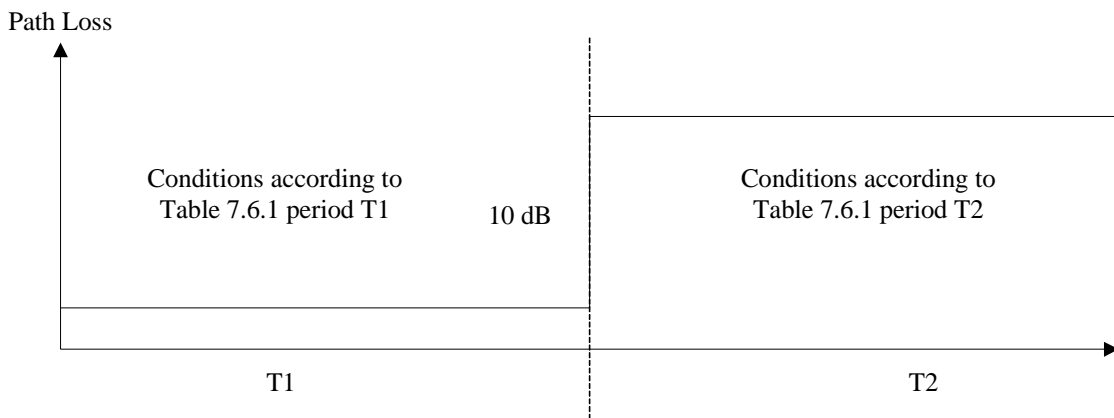

**Figure 7.6.1**

At the end of period T1, the PCCPCH and Beacon Received power shall be simultaneously decreased by 10 dB. These conditions are summarized in table 7.6.1, period T2.

For the first frame including the change in received power the UE output power shall satisfy the values in table 7.6.2.

For the 20<sup>th</sup> frame after the change in received power the UE output power shall satisfy the values in table 7.6.3.

**Table 7.6.2: Required UE Output Power, Frame Containing Power Level Change**

Parameter	Units	Value	
UL transmission slot position		1,9	7,14
UE output power	dBm	15 ±4.0	5 ±0.5

**Table 7.6.3: Required UE Output Power, 20 Frames after Power Level Change**

Parameter	Units	Value	
UL transmission slot position		1,9	7,14
UE output power	dBm	15 ±4.0	15 ±4.0

### 7.6.3 Test purpose

To verify the ability of the UE to converge to the required link quality set by the network while using minimum uplink power.

### 7.6.4 Method of test

#### 7.6.4.1 Initial conditions

Test environment: normal; see clauses G.2.1 and G.2.2.

Frequencies to be tested: mid range; see clause G.2.4.

- 1) Connect SS and an AWGN source to the UE antenna connector as shown in figure A.9.
- 2) Set up a call according to the Generic call setup procedure using SS levels and signalling values as specified in table 7.6.1 for Period P1 and table 7.6.4 . The UE shall be signalled to transmit in timeslot position 1.

**Table 7.6.4: Test parameters for Uplink Power Control Test**

Parameter	Value/description
UL Reference measurement channel	12,2kbps, according to annex C.2.1
DPCH constant value	0
Data content	real life (sufficient irregular)

- 3) Enter the UE into loopback test mode and start the loopback test.

See TS 34.108 [3] and TS 34.109 [4] for details regarding generic call setup procedure and loopback test.

### 7.6.4.2 Procedure

- 1) The SS adjusts the DPCH constant value until the UE transmit power is 5 dBm.
- 2) After the UE output power has been held constant at 5 dBm for at least 5 seconds, the received PCCPCH power shall be decreased by 10 dB to -70 dBm as shown in figure 7.6.1.
- 3) Measure the transmit power according to annex B for the first frame including the pathloss change and the 20<sup>th</sup> frame after the pathloss change.
- 4) Set the received PCCPCH power to -60 dBm.
- 5) SS signals UE to transmit in timeslot 7. Repeat step 1 - 4.
- 6) SS signals UE to transmit in timeslot 9. Repeat step 1 - 4.
- 7) SS signals UE to transmit in timeslot 14. Repeat step 1 - 4.

### 7.6.5 Test Requirements

The measured transmit power shall not exceed the prescribed tolerance in tables 7.6.5 and 7.6.6.

**Table 7.6.5: Required UE Output Power, Frame Containing Power Level Change**

Parameter	Units	Value	
UL transmission slot position		1,9	7,14
UE output power	dBm	15 ±5.5	5 ±0.5

**Table 7.6.6: Required UE Output Power, 20 Frames after Power Level Change**

Parameter	Units	Value	
UL transmission slot position		1,9	7,14
UE output power	dBm	15 ±5.5	15 ±5.5

NOTE: If the above Test Requirement differs from the Minimum Requirement then the Test Tolerance applied for this test is non-zero. The Test Tolerance for this test is defined in annex F clause F.2 and the explanation of how the Minimum Requirement has been relaxed by the Test Tolerance is given in Annex F clause F.4.

## 7.7 Demodulation of DCH in moving conditions

### 7.7.1 Definition and applicability

#### 7.7.1.1 3,84 Mcps TDD Option

<void>

#### 7.7.1.2 1,28 Mcps TDD Option

The receive characteristics of the Dedicated Channel (DCH) in dynamic moving propagation conditions are determined by the Block Error Ratio (BLER) values. BLER is measured for the each of the individual data rate specified for the DPCH. DCH is mapped into in Dedicated Physical Channel (DPCH).

The requirements and this test apply to all types of 1.28 Mcps TDD UE of Release 7 and later.

#### 7.7.1.3 7,68 Mcps TDD Option

<void>

### 7.7.2 Minimum requirements

#### 7.7.2.1 3.84 Mcps TDD Option

Void

#### 7.7.2.2 1.28 Mcps TDD Option

For the parameters specified in Table 7.7.1 the BLER should not exceed the piece-wise linear BLER curve specified in Table 7.7.2.

**Table 7.7.1: DCH parameters in moving propagation conditions (1.28 Mcps TDD Option)**

Parameters	Unit	Test 1	Test 2
Number of DPCH <sub>o</sub>		8	2
Scrambling code and basic midamble code number*		0	0
DPCH Channelization Codes*	C(k,Q)	C(i,16) i=1,2	C(i,16) i=1...8
DPCH <sub>o</sub> Channelization Codes*	C(k,Q)	C(i,16) 3 ≤ i ≤ 10	C(i,16) 9 ≤ i ≤ 10
$\frac{DPCH_o - E_c}{I_{or}}$	DB	-10	-10
$I_{oc}$	dBm/1.28MHz	-60	
Information Data Rate	Kbps	12.2	64
*Note: Refer to TS 25.223 for definition of channelization codes, scrambling code and basic midamble code.			

**Table 7.7.2: Performance requirements in moving propagation conditions (1.28 Mcps TDD Option)**

Test Number	$\frac{\hat{I}_{or}}{I_{oc}}$ [dB]	BLER
1	7.1	10 <sup>-2</sup>
2	6.7	10 <sup>-2</sup>

#### 7.7.2.3 7.68 Mcps TDD Option

void

### 7.7.3 Test purpose

To verify the ability of the receiver to receive a predefined test signal, representing a moving propagation channel for the wanted and for the co-channel signals from serving and adjacent cells, with a BLER not exceeding a specified value.

### 7.7.4 Method of test

#### 7.7.4.1 Initial conditions

Test environment: normal; see clauses G.2.1 and G.2.2.

Frequencies to be tested: mid range; see clause G.2.4.

1. Connect the SS and an AWGN noise source to the UE antenna connector as shown in figure A.10. In case of UE-receive diversity connect according to figure A.17.
2. Set up a call according to the Generic call setup procedure TS34.108 [3] sub clause 7.3.2.
3. Set the test parameters as specified in table 7.7.1.
4. Enter the UE into loopback test mode and start the loopback test.
5. Setup fading simulator as moving propagation condition, which is described in clause D.2.3.

#### 7.7.4.2 Procedure

1. Measure BLER of DCH.

### 7.7.5 Test Requirements

#### 7.7.5.1 3.84 Mcps option

Void.

#### 7.7.5.2 1.28 Mcps option

For the parameters specified in table 7.7.3 the average downlink  $\frac{\hat{I}_{or}}{I_{oc}}$  power ratio shall be below the specified value for the BLER shown in table 7.7.4.

**Table 7.7.3: DCH parameters in moving propagation conditions**

Parameters	Unit	Test 1	Test 2
Number of DPCH <sub>o</sub>		8	2
Scrambling code and basic midamble code number*		0	0
DPCH Channelization Codes*	C(k,Q)	C(i,16) i=1,2	C(i,16) i=1...8
DPCH <sub>o</sub> Channelization Codes*	C(k,Q)	C(i,16) 3 ≤ i ≤ 10	C(i,16) 9 ≤ i ≤ 10
$\frac{DPCH_o - E_c}{I_{or}}$	DB	-10	-10
I <sub>oc</sub>	dBm/1.28MHz	-60	
Information Data Rate	Kbps	12.2	64
*Note:	Refer to TS 25.223 for definition of channelization codes, scrambling code and basic midamble code.		

**Table 7.7.4: DCH requirements in moving propagation conditions**

Test Number	$\frac{\hat{I}_{or}}{I_{oc}}$ [dB]	BLER
1	7.8	$10^{-2}$
2	7.4	$10^{-2}$

NOTE: If the above Test Requirement differs from the Minimum Requirement then the Test Tolerance applied for this test is non-zero. The Test Tolerance for this test is defined in clause F.2 and the explanation of how the Minimum Requirement has been relaxed by the Test Tolerance is given in clause F.4.

### 7.7.5.3 7.68Mcps option

Void.

## 7.8 Demodulation of DCH in birth-death conditions

### 7.8.1 Definition and applicability

#### 7.8.1.1 3,84 Mcps TDD Option

<void>

#### 7.8.1.2 1,28 Mcps TDD Option

The receive characteristics of the Dedicated Channel (DCH) in birth-death propagation conditions are determined by the Block Error Ratio (BLER) values. BLER is measured for the each of the individual data rate specified for the DPCH. DCH is mapped into in Dedicated Physical Channel (DPCH).

The requirements and this test apply to all types of 1.28 Mcps TDD UE of Release 7 and later.

#### 7.8.1.3 7,68 Mcps TDD Option

<void>

### 7.8.2 Minimum requirements

#### 7.8.2.1 3.84 Mcps TDD Option

Void

### 7.8.2.2 1.28 Mcps TDD Option

For the parameters specified in Table 7.8.1 the BLER should not exceed the piece-wise linear BLER curve specified in Table 7.8.2.

**Table 7.8.1: DCH parameters in birth-death propagation conditions (1.28 Mcps TDD Option)**

Parameters	Unit	Test 1	Test 2
Number of DPCH <sub>o</sub>		8	2
Scrambling code and basic midamble code number*		0	0
DPCH Channelization Codes*	C(k,Q)	C(i,16) i=1,2	C(i,16) i=1...8
DPCH <sub>o</sub> Channelization Codes*	C(k,Q)	C(i,16) 3 ≤ i ≤ 10	C(i,16) 9 ≤ i ≤ 10
$\frac{DPCH_o - E_c}{I_{or}}$	DB	-10	-10
$I_{oc}$	dBm/1.28MHz	-60	
Information Data Rate	Kbps	12.2	64
*Note: Refer to TS 25.223 for definition of channelization codes, scrambling code and basic midamble code.			

**Table 7.8.2: Performance requirements in birth-death propagation conditions (1.28 Mcps TDD Option)**

Test Number	$\frac{\hat{I}_{or}}{I_{oc}}$ [dB]	BLER
1	7.3	10 <sup>-2</sup>
2	6.5	10 <sup>-2</sup>

### 7.8.2.3 7.68 Mcps TDD Option

void

## 7.8.3 Test purpose

To verify the ability of the receiver to receive a predefined test signal, representing a moving propagation channel for the wanted and for the co-channel signals from serving and adjacent cells, with a BLER not exceeding a specified value.

## 7.8.4 Method of test

### 7.8.4.1 Initial conditions

Test environment: normal; see clauses G.2.1 and G.2.2.

Frequencies to be tested: mid range; see clause G.2.4.

1. Connect the SS and an AWGN noise source to the UE antenna connector as shown in figure A.10. In case of UE-receive diversity connect according to figure A.17.
2. Set up a call according to the Generic call setup procedure TS34.108 [3] sub clause 7.3.2.
3. Set the test parameters as specified in table 7.8.1.
4. Enter the UE into loopback test mode and start the loopback test.
5. Setup fading simulator as moving propagation condition, which is described in clause D.2.3.

### 7.8.4.2 Procedure

1. Measure BLER of DCH.

## 7.8.5 Test Requirements

### 7.8.5.1 3.84 Mcps option

Void.

### 7.8.5.2 1.28 Mcps option

For the parameters specified in table 7.8.3 the average downlink  $\frac{\hat{I}_{or}}{I_{oc}}$  power ratio shall be below the specified value for the BLER shown in table 7.8.4.

**Table 7.8.3: DCH parameters in birth-death propagation conditions**

Parameters	Unit	Test 1	Test 2
Number of DPCH <sub>o</sub>		8	2
Scrambling code and basic midamble code number*		0	0
DPCH Channelization Codes*	C(k,Q)	C(i,16) i=1,2	C(i,16) i=1...8
DPCH <sub>o</sub> Channelization Codes*	C(k,Q)	C(i,16) 3 ≤ i ≤ 10	C(i,16) 9 ≤ i ≤ 10
$\frac{DPCH_o - E_c}{I_{or}}$	DB	-10	-10
$I_{oc}$	dBm/1.28MHz	-60	
Information Data Rate	Kbps	12.2	64
*Note: Refer to TS 25.223 for definition of channelization codes, scrambling code and basic midamble code.			

**Table 7.8.4: DCH requirements in birth-death propagation conditions**

Test Number	$\frac{\hat{I}_{or}}{I_{oc}}$ [dB]	BLER
1	8.0	10 <sup>-2</sup>
2	7.2	10 <sup>-2</sup>

NOTE: If the above Test Requirement differs from the Minimum Requirement then the Test Tolerance applied for this test is non-zero. The Test Tolerance for this test is defined in clause F.2 and the explanation of how the Minimum Requirement has been relaxed by the Test Tolerance is given in clause F.4.

### 7.8.5.3 7.68 Mcps option

Void.



## 8 Requirements for Support of RRM

### 8.1 General

Void.

### 8.2 Idle Mode Tasks

#### 8.2.1 RF Cell Selection Scenario

##### 8.2.1.1 Introduction

After a UE has switched on and a PLMN has been selected, the Cell selection process takes place, as described in TS 25.304. This process allows the UE to select a suitable cell where to camp on in order to access available services. In this process the UE can use stored information (*Stored information cell selection*) or not (*Initial cell selection*).

##### 8.2.2 Cell Re-Selection

###### 8.2.2.1 Scenario 1: Cell re-selection to intra frequency TDD cell

###### 8.2.2.1.1 Definition and applicability

###### 8.2.2.1.1.1 3,84 Mcps TDD Option

The cell re-selection delay is defined as the time from a change of cell levels to the moment when this change causes the UE to camp on a new cell, and starts to send the RRC CONNECTION REQUEST message to perform a Location Registration on the new cell.

The requirements and this test apply to the 3,84 Mcps TDD UE.

###### 8.2.2.1.1.2 1,28 Mcps TDD Option

The cell re-selection delay is defined as the time from the beginning of time period T2, to the moment when the UE camps on Cell 2, and starts to send SYNCH-UL sequence in the UpPTS for sending the RRC CONNECTION REQUEST to perform a Location Registration on cell 2.

This test is applicable to 1,28 Mcps TDD UE.

###### 8.2.2.1.1.3 7,68 Mcps TDD Option

The cell re-selection delay is defined as the time from a change of cell levels to the moment when this change causes the UE to camp on a new cell, and starts to send the RRC CONNECTION REQUEST message to perform a Location Registration on the new cell.

The requirements and this test apply to the 7,68 Mcps TDD UE.

###### 8.2.2.1.2 Minimum requirement

###### 8.2.2.1.2.1 3,84 Mcps TDD Option

The cell re-selection delay shall be less than 8 s when the DRX cycle length is 1,28 s.

The rate of correct cell reselections observed during repeated tests shall be at least 90% with a confidence level of [FFS]%.

NOTE:

The cell re-selection delay can be expressed as:  $T_{\text{evaluateTDD}} + T_{\text{SI}}$ , where:

$T_{\text{evaluateTDD}}$  A DRX cycle length of 1280ms is assumed for this test case, this leads to a  $T_{\text{evaluateTDD}}$  of 6.4s according to table 4.1 in clause 4.2.2.7 in [2].

$T_{SI}$  Maximum repetition rate of relevant system info blocks that needs to be received by the UE to camp on a cell. 1280 ms is assumed in this test case.

This gives a total of 7.68 s, allow 8s in the test case.

The normative reference for this requirement is TS 25.123 [2] clauses 4.2.2 and A.4.2.1.

#### 8.2.2.1.2.2 1,28 Mcps TDD Option

The cell re-selection delay shall be less than 8 s when the DRX cycle length is 1,28 s.

The rate of correct cell reselections observed during repeated tests shall be at least 90% with a confidence level of 95%.

NOTE:

The cell re-selection delay can be expressed as:  $T_{\text{evaluateNTDD}} + T_{SI}$ , where:

$T_{\text{evaluateNTDD}}$ : A DRX cycle length of 1280ms is assumed for this test case, this leads to a  $T_{\text{evaluateNTDD}}$  of 6.4s according to table 4.1A in clause 4.2 in [2].

$T_{SI}$ : Time required for receiving all the relevant system information data according to the reception procedure and the RRC procedure delay of system information blocks defined in 25.331 for a UTRAN cell (ms). 1280 ms is assumed in this test case.

This gives a total of 7.68 s, allow 8s in the test case.

The normative reference for this requirement is TS 25.123 [2] clauses 4.2.2 and A.4.2.1.

#### 8.2.2.1.2.3 7,68 Mcps TDD Option

The cell re-selection delay shall be less than 8 s when the DRX cycle length is 1,28 s.

The rate of correct cell reselections observed during repeated tests shall be at least 90% with a confidence level of 95%.

NOTE:

The cell re-selection delay can be expressed as:  $T_{\text{evaluateTDD}} + T_{SI}$ , where:

$T_{\text{evaluateTDD}}$  A DRX cycle length of 1280ms is assumed for this test case, this leads to a  $T_{\text{evaluateTDD}}$  of 6.4s according to table 4.1B in clause 4.2.2.7.3 in [2].

$T_{SI}$  Maximum repetition rate of relevant system info blocks that needs to be received by the UE to camp on a cell. 1280 ms is assumed in this test case.

This gives a total of 7.68 s, allow 8s in the test case.

The normative reference for this requirement is TS 25.123 [2] clauses 4.2.2 and A.4.2.1.

#### 8.2.2.1.3 Test purpose

This test is to verify the requirement for the cell re-selection delay in the single carrier case

#### 8.2.2.1.4 Method of test

##### 8.2.2.1.4.1 3,84 Mcps TDD Option

##### 8.2.2.1.4.1.1 Initial conditions

This scenario implies the presence of 1 carrier and 6 cells as given in table 8.2.2.1.1 and table 8.2.2.1.2. Cell 1 and cell 2 shall belong to different Location Areas.

**Table 8.2.2.1.1: General test parameters for Cell Re-selection to intra-frequency TDD cell**

	<b>Parameter</b>	<b>Unit</b>	<b>Value</b>	<b>Comment</b>
Initial condition	Active cell		Cell1	
	Neighbour cells		Cell2, Cell3, Cell4, Cell5, Cell6	
Final condition	Active cell		Cell2	
HCS			Not used	
UE_TXPWR_MAX_RACH		dBm	21	The value shall be used for all cells in the test.
Qrxlevmin		dBm	-102	The value shall be used for all cells in the test.
Access Service Class (ASC#0) - Persistence value			1	Selected so that no additional delay is caused by the random access procedure. The value shall be used for all cells in the test.
T <sub>SI</sub>		s	1,28	The value shall be used for all cells in the test.
DRX cycle length		s	1,28	The value shall be used for all cells in the test.
T1		s	15	
T2		s	15	

Table 8.2.2.1.2: Cell re-selection single carrier to intra-frequency TDD cell

Parameter	Unit	Cell 1				Cell 2				Cell 3			
		0		8		0		8		0		8	
Timeslot Number		T1	T2	T1	T2	T1	T2	T1	T2	T1	T2	T1	T2
UTRA RF Channel Number		Channel 1				Channel 1				Channel 1			
PCCPCH_Ec/lor	dB	-3	-3			-3	-3			-3	-3		
SCH_Ec/lor	dB	-9	-9	-9	-9	-9	-9	-9	-9	-9	-9	-9	-9
SCH_toffset		0	0	0	0	5	5	5	5	10	10	10	10
PICH_Ec/lor	dB			-3	-3			-3	-3			-3	-3
OCNS_Ec/lor	dB	-3,12	-3,12	-3,12	-3,12	-3,12	-3,12	-3,12	-3,12	-3,12	-3,12	-3,12	-3,12
$\hat{I}_{or}/I_{oc}$	dB	9	7	9	7	7	9	7	9	-1	-1	-1	-1
PCCPCH RSCP	dBm	-64	-66			-66	-64			-74	-74		
Qoffset <sub>1s,n</sub>	dB	C1, C2: 0; C1, C3:0; C1,C4:0 C1, C5:0; C1, C6:0				C2, C1: 0; C2, C3:0; C2,C4:0 C2, C5: 0; C2, C6:0				C3, C1: 0; C3, C2:0; C3,C4:0 C3, C5: 0; C3, C6:0			
Qhyst <sub>1s</sub>	dB	0				0				0			
Treselection	s	0				0				0			
Sintrasearch	dB	not sent				not sent				not sent			
Timeslot		Cell 4				Cell 5				Cell 6			
		0		8		0		8		0		8	
UTRA RF Channel Number		Channel 1				Channel 1				Channel 1			
PCCPCH_Ec/lor	dB	-3	-3			-3	-3			-3	-3		
SCH_Ec/lor	dB	-9	-9	-9	-9	-9	-9	-9	-9	-9	-9	-9	-9
SCH_toffset		15	15	15	15	20	20	20	20	25	25	25	25
PICH_Ec/lor	dB			-3	-3			-3	-3			-3	-3
OCNS_Ec/lor	dB	-3,12	-3,12	-3,12	-3,12	-3,12	-3,12	-3,12	-3,12	-3,12	-3,12	-3,12	-3,12
$\hat{I}_{or}/I_{oc}$	dB	-1	-1	-1	-1	-1	-1	-1	-1	-1	-1	-1	-1
PCCPCH RSCP	dBm	-74	-74			-74	-74			-74	-74		
Qoffset <sub>1s,n</sub>	dB	C4, C1: 0; C4, C2:0; C4,C3:0C4, C5:0; C4, C6:0				C5, C1: 0; C5, C2:0; C5,C3:0 C5, C4:0; C5, C6:0				C6, C1: 0; C6, C2:0; C6,C3:0 C6, C4:0; C6, C5:0			
Qhyst <sub>1s</sub>	dB	0				0				0			
Treselection	s	0				0				0			
Sintrasearch	dB	not sent				not sent				not sent			
$I_{oc}$	dBm/3,8 4 MHz	-70											
Propagation Condition		AWGN											

## 8.2.2.1.4.1.2 Procedure

- a) The SS activates cell 1-6 with T1 defined parameters and monitors cell 1 and 2 for RRC CONNECTION REQUEST messages from the UE.
- b) The UE is switched on.
- c) The SS waits until the UE camps on Cell 1 and sends the RRC CONNECTION REQUEST message.
- d) After 15 s, the parameters are changed as described for T2.
- e) The SS waits for RRC CONNECTION REQUEST messages from the UE.
- f) After another 15 s, the parameters are changed as described for T1.
- g) The SS waits for RRC CONNECTION REQUEST messages from the UE.
- h) Repeat steps d) to g) [TBD] times.

## 8.2.2.1.4.2 1,28 Mcps TDD Option

## 8.2.2.1.4.2.1 Initial conditions

This scenario implies the presence of 1 carrier and 6 cells as given in table 8.2.2.1.1A and 8.2.2.1.2A.

**Table 8.2.2.1.1A: General test parameters for Cell Re-selection to intra-frequency TDD cell**

Parameter	Unit	Value	Comment
Initial condition	Active cell	Cell1	
	Neighbour cells	Cell2, Cell3, Cell4, Cell5, Cell6	
Final condition	Active cell	Cell2	
HCS		Not used	
UE_TXPWR_MAX_RACH	dBm	21	The value shall be used for all cells in the test.
Qrxlevmin	dBm	-103	The value shall be used for all cells in the test.
Access Service Class (ASC#0) -- Persistence value	0..1	1	Selected so that no additional delay is caused by the random access procedure. The value shall be used for all cells in the test.
T <sub>SI</sub>	s	1,28	The value shall be used for all cells in the test.
DRX cycle length	s	1,28	The value shall be used for all cells in the test.
T1	s	15	
T2	s	15	

Table 8.2.2.1.2A: Cell re-selection to intra-frequency TDD cell

Parameter	Unit	Cell 1				Cell 2				Cell 3			
		0		DWPTS		0		DWPTS		0		DWPTS	
Timeslot Number		T1	T2	T1	T2	T1	T2	T1	T2	T1	T2	T1	T2
UTRA RF Channel Number		Channel 1				Channel 1				Channel 1			
PCCPCH_Ec/lor	dB	-3	-3			-3	-3			-3	-3		
DwPCH_Ec/lor	dB			0	0			0	0			0	0
OCNS_Ec/lor	dB	-3	-3			-3	-3			-3	-3		
$\hat{I}_{or}/I_{oc}$	dB	10	7	10	7	7	10	7	10	-1	-1	-1	-1
PCCPCH RSCP	dBm	-63	-66			-66	-63			-74	-74		
Qoffset <sub>1s,n</sub>	dB	C1, C2: 0; C1, C3:0; C1,C4:0 C1, C5:0; C1,C6:0				C2, C1: 0; C2, C3:0; C2,C4:0 C2, C5: 0; C2, C6:0				C3, C1: 0; C3, C2:0; C3,C4:0 C3, C5: 0; C3, C6:0			
Qhyst <sub>1s</sub>	dB	0				0				0			
Treselection	s	0				0				0			
Sintrasearch	dB	not sent				not sent				not sent			
Timeslot		Cell 4				Cell 5				Cell 6			
		0		DWPTS		0		DWPTS		0		DWPTS	
UTRA RF Channel Number		Channel 1				Channel 1				Channel 1			
PCCPCH_Ec/lor	dB	-3	-3			-3	-3			-3	-3		
DwPCH_Ec/lor	dB			0	0			0	0			0	0
OCNS_Ec/lor	dB	-3	-3			-3	-3			-3	-3		
$\hat{I}_{or}/I_{oc}$	dB	-1	-1	-1	-1	-1	-1	-1	-1	-1	-1	-1	-1
PCCPCH RSCP	dBm	-74	-74			-74	-74			-74	-74		
Qoffset <sub>1s,n</sub>	dB	C4, C1: 0; C4, C2:0; C4,C3:0 C4, C5:0; C4, C6:0				C5, C1: 0; C5, C2:0; C5,C3:0 C5, C4:0; C5, C6:0				C6, C1: 0; C6, C2:0; C6,C3:0 C6, C4:0; C6, C5:0			
Qhyst <sub>1s</sub>	dB	0				0				0			
Treselection	s	0				0				0			
Sintrasearch	dB	not sent				not sent				not sent			
$I_{oc}$	dBm/ 1.28 MHz	-70											
Propagation Condition		AWGN											

Note: In the case of multi-frequency cell, the UTRA RF Channel Number is the primary frequency's channel number.

8.2.2.1.4.2.2 Procedure

- a) The SS activates cell 1-6 with T1 defined parameters and monitors cell 1 and 2 for SYNCH-UL sequence in the UpPTS for sending for RRC CONNECTION REQUEST messages from the UE.
- b) The UE is switched on.
- c) The SS waits until the UE camps on Cell 1 and sends the RRC CONNECTION REQUEST message.
- d) After 15 s, the parameters are changed as described for T2.
- e) The SS waits for SYNCH-UL sequence in the UpPTS for sending RRC CONNECTION REQUEST messages from the UE.
- f) After another 15 s, the parameters are changed as described for T1.
- g) The SS waits for SYNCH-UL sequence in the UpPTS for sending RRC CONNECTION REQUEST messages from the UE.
- h) Repeat steps b)-g) until the confidence level according to annex F.6.2 is achieved.

8.2.2.1.4.3 7,68 Mcps TDD Option

8.2.2.1.4.3.1 Initial conditions

This scenario implies the presence of 1 carrier and 6 cells as given in table 8.2.2.1.1B and table 8.2.2.1.2B. Cell 1 and cell 2 shall belong to different Location Areas.

**Table 8.2.2.1.1B: General test parameters for Cell Re-selection to intra-frequency TDD cell**

Parameter		Unit	Value	Comment
Initial condition	Active cell		Cell1	
	Neighbour cells		Cell2, Cell3, Cell4, Cell5, Cell6	
Final condition	Active cell		Cell2	
HCS			Not used	
UE_TXPWR_MAX_RACH		dBm	21	The value shall be used for all cells in the test.
Qrxlevmin		dBm	-102	The value shall be used for all cells in the test.
Access Service Class (ASC#0) - Persistence value			1	Selected so that no additional delay is caused by the random access procedure. The value shall be used for all cells in the test.
T <sub>SI</sub>		s	1.28	The value shall be used for all cells in the test.
DRX cycle length		s	1.28	The value shall be used for all cells in the test.
T1		s	15	
T2		s	15	

Table 8.2.2.1.2B: Cell re-selection to intra-frequency TDD cell

Parameter	Unit	Cell 1				Cell 2				Cell 3			
		0		8		0		8		0		8	
Timeslot Number		T1	T2	T1	T2	T1	T2	T1	T2	T1	T2	T1	T2
UTRA RF Channel Number		Channel 1				Channel 1				Channel 1			
PCCPCH_Ec/lor	dB	-3	-3			-3	-3			-3	-3		
SCH_Ec/lor	dB	-9	-9	-9	-9	-9	-9	-9	-9	-9	-9	-9	-9
SCH_offset		0	0	0	0	5	5	5	5	10	10	10	10
PICH_Ec/lor	dB			-3	-3			-3	-3			-3	-3
OCNS_Ec/lor	dB	-3,12	-3,12	-3,12	-3,12	-3,12	-3,12	-3,12	-3,12	-3,12	-3,12	-3,12	-3,12
$\hat{I}_{or}/I_{oc}$	dB	9	7	9	7	7	9	7	9	-1	-1	-1	-1
PCCPCH RSCP	dBm	-64	-66			-66	-64			-74	-74		
Qoffset <sub>1s,n</sub>	dB	C1, C2: 0; C1, C3:0; C1,C4:0 C1, C5:0; C1,C6:0				C2, C1: 0; C2, C3:0; C2,C4:0 C2, C5: 0; C2,C6:0				C3, C1: 0; C3, C2:0; C3,C4:0 C3, C5: 0; C3,C6:0			
Qhyst <sub>1s</sub>	dB	0				0				0			
Treselection	s	0				0				0			
Sintrasearch	dB	not sent				not sent				not sent			
Timeslot		Cell 4				Cell 5				Cell 6			
		0		8		0		8		0		8	
UTRA RF Channel Number		Channel 1				Channel 1				Channel 1			
PCCPCH_Ec/lor	dB	-3	-3			-3	-3			-3	-3		
SCH_Ec/lor	dB	-9	-9	-9	-9	-9	-9	-9	-9	-9	-9	-9	-9
SCH_offset		15	15	15	15	20	20	20	20	25	25	25	25
PICH_Ec/lor	dB			-3	-3			-3	-3			-3	-3
OCNS_Ec/lor	dB	-3,12	-3,12	-3,12	-3,12	-3,12	-3,12	-3,12	-3,12	-3,12	-3,12	-3,12	-3,12
$\hat{I}_{or}/I_{oc}$	dB	-1	-1	-1	-1	-1	-1	-1	-1	-1	-1	-1	-1
PCCPCH RSCP	dBm	-74	-74			-74	-74			-74	-74		
Qoffset <sub>1s,n</sub>	dB	C4, C1: 0; C4, C2:0; C4,C3:0 C4, C5:0; C4, C6:0				C5, C1: 0; C5, C2:0; C5,C3:0 C5, C4:0; C5, C6:0				C6, C1: 0; C6, C2:0; C6,C3:0 C6, C4:0; C6, C5:0			
Qhyst <sub>1s</sub>	dB	0				0				0			
Treselection	s	0				0				0			
Sintrasearch	dB	not sent				not sent				not sent			
$I_{oc}$	dBm/7,6 8 MHz	-70											
Propagation Condition		AWGN											



#### 8.2.2.1.4.3.2 Procedure

- a) The SS activates cell 1-6 with T1 defined parameters and monitors cell 1 and 2 for RRC CONNECTION REQUEST messages from the UE.
- b) The UE is switched on.
- c) The SS waits until the UE camps on Cell 1 and sends the RRC CONNECTION REQUEST message.
- d) After 15 s, the parameters are changed as described for T2.
- e) The SS waits for RRC CONNECTION REQUEST messages from the UE.
- f) After another 15 s, the parameters are changed as described for T1.
- g) The SS waits for RRC CONNECTION REQUEST messages from the UE.
- h) Repeat steps d) to g) until the confidence level according to annex F.6.2 is achieved.

#### 8.2.2.1.5 Test Requirements

##### 8.2.2.1.5.1 3,84 Mcps TDD Option

- 1) In step c), after the UE has responded on cell 1, it shall not respond on any other cell (cell selection).
- 2) In step e), the UE shall respond on cell 2 within 8 s.
- 3) In step g), the UE shall respond on cell 1 within 8 s.

For the test to pass, the total number of fulfilled test requirements 2) and 3) shall be more than [FFS]% of the cases.

NOTE: If the above Test Requirement differs from the Minimum Requirement then the Test Tolerance applied for this test is non-zero. The Test Tolerance for this test is defined in clause F.2 and the explanation of how the Minimum Requirement has been relaxed by the Test Tolerance is given in clause F.4.

##### 8.2.2.1.5.2 1,28 Mcps TDD Option

- 1) In step c), after the UE has responded on cell 1, it shall not respond on any other cell (cell selection).
- 2) In step e), the UE shall respond on cell 2 within 8 s.
- 3) In step g), the UE shall respond on cell 1 within 8 s.

For the test to pass, the total number of successful tests shall be more than 90% with a confidence level of 95% of the cases.

NOTE: If the above Test Requirement differs from the Minimum Requirement then the Test Tolerance applied for this test is non-zero. The Test Tolerance for this test is defined in clause F.2 and the explanation of how the Minimum Requirement has been relaxed by the Test Tolerance is given in clause F.4.

##### 8.2.2.1.5.3 7,68 Mcps TDD Option

- 1) In step c), after the UE has responded on cell 1, it shall not respond on any other cell (cell selection).
- 2) In step e), the UE shall respond on cell 2 within 8 s.
- 3) In step g), the UE shall respond on cell 1 within 8 s.

For the test to pass, the total number of fulfilled test requirements 2) and 3) shall be more than 90% of the cases.

NOTE: If the above Test Requirement differs from the Minimum Requirement then the Test Tolerance applied for this test is non-zero. The Test Tolerance for this test is defined in clause F.2 and the explanation of how the Minimum Requirement has been relaxed by the Test Tolerance is given in clause F.4.

## 8.2.2.2 Scenario 2: Cell re-selection to inter-frequency TDD cell

### 8.2.2.2.1 Definition and applicability

#### 8.2.2.2.1.1 3,84 Mcps Option

The cell re-selection delay is defined as the time from a change of cell levels to the moment when this change causes the UE to camp on a new cell, and starts to send the RRC CONNECTION REQUEST message to perform a Location Registration on the new cell.

The requirements and this test apply to the 3,84 Mcps TDD UE.

#### 8.2.2.2.1.2 1,28 Mcps Option

The cell re-selection delay is defined as the time from the beginning of time period T2, to the moment when the UE camps on Cell 2, and starts to send the SYNCH-UL sequence in the UpPTS for sending the RRC CONNECTION REQUEST to perform a Location Registration on cell 2.

This test is applicable to 1,28 Mcps TDD UE.

#### 8.2.2.2.1.3 7,68 Mcps Option

The cell re-selection delay is defined as the time from a change of cell levels to the moment when this change causes the UE to camp on a new cell, and starts to send the RRC CONNECTION REQUEST message to perform a Location Registration on the new cell.

The requirements and this test apply to the 7,68 Mcps TDD UE.

### 8.2.2.2.2 Minimum requirement

#### 8.2.2.2.2.1 3,84 Mcps Option

The cell re-selection delay shall be less than 8 s.

The rate of correct cell reselections observed during repeated tests shall be at least 90% with a confidence level of [FFS]%.

The rate of correct cell reselections observed during repeated tests shall be at least 90%.NOTE:

The cell re-selection delay can be expressed as:  $T_{\text{evaluateTDD}} + T_{\text{SI}}$ , where:

$T_{\text{evaluateTDD}}$  A DRX cycle length of 1280ms is assumed for this test case, this leads to a  $T_{\text{evaluateTDD}}$  of 6.4s according to table 4.1 in clause 4.2.2.7 in [2].

$T_{\text{SI}}$  Maximum repetition rate of relevant system info blocks that needs to be received by the UE to camp on a cell. 1280 ms is assumed in this test case.

This gives a total of 7.68 s, allow 8s in the test case.

The normative reference for this requirement is TS 25.123 [2] clauses 4.2.2 and A.4.2.2.

#### 8.2.2.2.2.2 1,28 Mcps Option

The cell re-selection delay shall be less than 8 s.

The rate of correct cell reselections observed during repeated tests shall be at least 90% with a confidence level of 95%.

NOTE:

The cell re-selection delay can be expressed as:  $T_{\text{evaluateNTDD}} + T_{\text{SI}}$ , where:

$T_{\text{evaluateNTDD}}$  A DRX cycle length of 1280ms is assumed for this test case, this leads to a  $T_{\text{evaluateNTDD}}$  of 6.4s according to table 4.1A in clause 4.2 in [2].

$T_{\text{SI}}$  Time required for receiving all the relevant system information data according to the reception procedure and the RRC procedure delay of system information blocks defined in 25.331 for a UTRAN cell (ms). 1280 ms is assumed in this test case.

This gives a total of 7.68 s, allow 8s in the test case.

The normative reference for this requirement is TS 25.123 [2] clauses 4.2.2 and A.4.2.2.

#### 8.2.2.2.3 7,68 Mcps Option

The cell re-selection delay shall be less than 8 s.

The rate of correct cell reselections observed during repeated tests shall be at least 90% with a confidence level of 95%.

#### NOTE:

The cell re-selection delay can be expressed as:  $T_{\text{evaluateTDD}} + T_{\text{SI}}$ , where:

$T_{\text{evaluateTDD}}$  A DRX cycle length of 1280ms is assumed for this test case, this leads to a  $T_{\text{evaluateTDD}}$  of 6.4s according to table 4.1B in clause 4.2.2.7.3 in [2].

$T_{\text{SI}}$  Maximum repetition rate of relevant system info blocks that needs to be received by the UE to camp on a cell. 1280 ms is assumed in this test case.

This gives a total of 7.68 s, allow 8s in the test case.

The normative reference for this requirement is TS 25.123 [2] clauses 4.2.2 and A.4.2.2.

#### 8.2.2.2.3 Test purpose

This test is to verify the requirement for the cell re-selection delay in the multi carrier case.

#### 8.2.2.2.4 Method of test

##### 8.2.2.2.4.1 3,84 Mcps Option

##### 8.2.2.2.4.1.1 Initial conditions

This scenario implies the presence of 2 carriers and 6 cells as given in table 8.2.2.2.1 and table 8.2.2.2.2. Cell 1 and cell 2 shall belong to different Location Areas.

**Table 8.2.2.2.1: General test parameters for Cell Re-selection to inter-frequency TDD cell**

Parameter		Unit	Value	Comment
Initial condition	Active cell		Cell1	
	Neighbour cells		Cell2, Cell3, Cell4, Cell5, Cell6	
Final condition	Active cell		Cell2	
HCS			Not used	
UE_TXPWR_MAX_RACH		dBm	21	The value shall be used for all cells in the test.
Qrxlevmin		dBm	-102	The value shall be used for all cells in the test.
Access Service Class (ASC#0) - Persistence value			1	Selected so that no additional delay is caused by the random access procedure. The value shall be used for all cells in the test.
$T_{\text{SI}}$		s	1,28	The value shall be used for all cells in the test.
DRX cycle length		s	1,28	The value shall be used for all cells in the test.
T1		s	30	
T2		s	15	

Table 8.2.2.2: Cell re-selection to inter-frequency TDD cell

0	Parameter	0	Unit	0				0				0															
1	Timeslot Number	1		1		1		1		0		0		0													
2		2		T1	T2	T1	T2	T1	T2	T1	T2	T1	T2	T1	T2												
3	UTRA RF Channel Number	3		3				3				3															
				Channel 1				Channel 2				Channel 1															
				4				4				4															
4	PCCPCH_Ec/lor	4	dB	5	-3	5	-3	5		0	2	-3	2	-3	1		1										
5	DwPCH_Ec/lor	5	dB	6		6		6	0	1	0	3		3		2	0	2	0								
6	$\hat{I}_{or}/I_{oc}$	6	dB	7	10	7	7	7	10	2	7	4	7	4	10	3	7	3	10	3	-1	3	-1	3	-1		
7	PCCPCH RSCP	7	dBm	8	-63	8	-66	8		3	5	-66	5	-63	4		4	4	4	4	4	4	4	4	4		
8	Qoffset1 <sub>s,n</sub>	8	dB	9				9				9															
				C1, C2: 0; C1, C3:0; C1,C4:0				C2, C1: 0; C2, C3:0;				C3, C1: 0; C3, C2:0; C3,C4:0															
				C1, C5:0; C1, C6:0				C2,C4:0C2, C5:0; C2, C6:0				10 C3, C5:0; C3, C6:0															
9	Qhyst1 <sub>s</sub>	9	dB	10				10				11															
10	Treselection	10	s	11				11				12															
11	Sintrasearch	11	dB	12				12				13															
12	Sintersearch	12	dB	13				13				14															
13		13		14				14				15															
				Cell 4				Cell 5				Cell 6															
14	Timeslot	14		15		15		16		0		6		6													
				0		DWPTS		0		DWPTS		0		DWPTS													
15		15		16	T1	16	T2	17	T1	1	T2	7	T1	7	T2	0	T1	5	T2	5	T1	5	T2	5	T1	5	T2
16	UTRA RF Channel Number	16		17				17				18															
				Channel				Channel 2				Channel															
				18				18				19															
17	PCCPCH_Ec/lor	17	dB	19	-3	19	-3	20		0	8	-3	8	-3	1		6	6	-3	6	-3	6		6	6	6	
18	DwPCH_Ec/lor	18	dB	20		20		21	0	1	0	9		9		2	0	7	0	7		7		7	0	7	0
19	$\hat{I}_{or}/I_{oc}$	19	dB	21	-1	21	-1	22	-1	2	-1	10	-1	10	-1	3	-1	8	-1	8	-1	8	-1	8	-1	8	-1
20	PCCPCH RSCP	20	dBm	22	-74	22	-74	23		3	11	-74	11	-74	4		9	9	9	9	9	9	9	9	9	9	
21	Qoffset1 <sub>s,n</sub>	21	dB	23				23				24															
				C4, C1: 0; C4, C2:0; C4,C3:0				C5, C1: 0; C5, C2:0; C5,C3:0				C6, C1: 0; C6, C2:0; C6,C3:0															
				24				24				25															
				C4, C5:0; C4, C6:0				C5, C4:0; C5, C6:0				C6, C4:0; C6, C5:0															
22	Qhyst1 <sub>s</sub>	22	dB	25				25				26															
23	Treselection	23	s	26				26				27															
24	Sintrasearch	24	dB	27				27				28															
25	Sintersearch	25	dB	28				28				29															
26	$I_{oc}$	26	dBm/3,84 MHz					29				-70															
27	Propagation Condition	27						30				AWGN															

## 8.2.2.2.4.1.2 Procedure

- a) The SS activates cell 1-6 with T1 defined parameters and monitors cell 1 and 2 for RRC CONNECTION REQUEST messages from the UE.
- b) The UE is switched on.
- c) The SS waits until the UE camps on Cell 1 and sends the RRC CONNECTION REQUEST message.
- d) After 15 s, the parameters are changed as described for T2.
- e) The SS waits for RRC CONNECTION REQUEST messages from the UE.
- f) After another 15 s, the parameters are changed as described for T1.
- g) The SS waits for RRC CONNECTION REQUEST messages from the UE.
- h) Repeat steps d) to g) [TBD] times.

NOTE: T1 is initially 30 s to allow enough time for the UE to search for cells as it has no prior knowledge of these.

## 8.2.2.2.4.2 1,28 Mcps Option

## 8.2.2.2.4.2.1 Initial conditions

This scenario implies the presence of 2 carriers and 6 cells as given in table 8.2.2.2.1A and table 8.2.2.2.2A. For this test purpose the broadcast repetition period of the target cell shall be 1.28s. Cell 1 and cell 2 shall belong to different Location Areas.

**Table 8.2.2.2.1A: General test parameters for Cell Re-selection to inter-frequency TDD cell**

Parameter		Unit	Value	Comment
Initial condition	Active cell		Cell1	
	Neighbour cells		Cell2, Cell3, Cell4, Cell5, Cell6	
Final condition	Active cell		Cell2	
HCS			Not used	
UE_TXPWR_MAX_RACH		dBm	21	The value shall be used for all cells in the test.
Qrxlevmin		dBm	-103	The value shall be used for all cells in the test.
Access Service Class (ASC#0) - Persistence value			1	Selected so that no additional delay is caused by the random access procedure. The value shall be used for all cells in the test.
T <sub>SI</sub>		s	1,28	The value shall be used for all cells in the test.
DRX cycle length		s	1,28	The value shall be used for all cells in the test.
T1		s	30	
T2		s	15	

**Table 8.2.2.2A: Cell re-selection to inter-frequency TDD cell**

Parameter	Unit	Cell 1				Cell 2				Cell 3			
		0		DWPTS		0		DWPTS		0		DWPTS	
Timeslot Number		T1	T2	T1	T2	T1	T2	T1	T2	T1	T2	T1	T2
UTRA RF Channel Number		Channel 1				Channel 2				Channel 1			
PCCPCH_Ec/lor	dB	-3	-3			-3	-3			-3	-3		
DwPCH_Ec/lor	dB			0	0			0	0			0	0
OCNS_Ec/lor	dB	-3	-3			-3	-3			-3	-3		
$\hat{I}_{or}/I_{oc}$	dB	10	4	10	4	4	10	4	10	-1	-1	-1	-1
PCCPCH RSCP	dBm	-63	-69			-69	-63			-74	-74		
Qoffset1 <sub>s,n</sub>	dB	C1, C2: 0; C1, C3:0; C1,C4:0 C1, C5:0; C1, C6:0				C2, C1: 0; C2, C3:0; C2,C4:0C2, C5:0; C2, C6:0				C3, C1: 0; C3, C2:0; C3,C4:0 C3, C5:0; C3, C6:0			
Qhyst1 <sub>s</sub>	dB	0				0				0			
Treselection	s	0				0				0			
Sintrasearch	dB	not sent				not sent				not sent			
Sintersearch	dB	not sent				not sent				not sent			
Timeslot		Cell 4				Cell 5				Cell 6			
		0		DWPTS		0		DWPTS		0		DWPTS	
UTRA RF Channel Number		Channel 1				Channel 2				Channel 2			
PCCPCH_Ec/lor	dB	-3	-3			-3	-3			-3	-3		
DwPCH_Ec/lor	dB			0	0			0	0			0	0
OCNS_Ec/lor	dB	-3	-3			-3	-3			-3	-3		
$\hat{I}_{or}/I_{oc}$	dB	-1	-1	-1	-1	-1	-1	-1	-1	-1	-1	-1	-1
PCCPCH RSCP	dBm	-74	-74			-74	-74			-74	-74		
Qoffset1 <sub>s,n</sub>	dB	C4, C1: 0; C4, C2:0; C4,C3:0 C4, C5:0; C4, C6:0				C5, C1: 0; C5, C2:0; C5,C3:0 C5, C4:0; C5, C6:0				C6, C1: 0; C6, C2:0; C6,C3:0 C6, C4:0; C6, C5:0			
Qhyst1 <sub>s</sub>	dB	0				0				0			
Treselection	s	0				0				0			
Sintrasearch	dB	not sent				not sent				not sent			
Sintersearch	dB	not sent				not sent				not sent			
$I_{oc}$	dBm/1, 28 MHz	-70											
Propagation Condition		AWGN											
* Note: In the case of multi-frequency cell, the UTRA RF Channel Number is the primary frequency's channel number.													

8.2.2.2.4.2.2 Procedure

- a) The SS activates cell 1-6 with T1 defined parameters and monitors cell 1 and 2 for SYNCH-UL sequence in the UpPTS for sending RRC CONNECTION REQUEST messages from the UE.
- b) The UE is switched on.
- c) The SS waits until the UE camps on Cell 1 and sends the RRC CONNECTION REQUEST message.
- d) After 15 s, the parameters are changed as described for T2.
- e) The SS waits for SYNCH-UL sequence in the UpPTS for sending RRC CONNECTION REQUEST messages from the UE.
- f) After another 15 s, the parameters are changed as described for T1.
- g) The SS waits for SYNCH-UL sequence in the UpPTS for sending RRC CONNECTION REQUEST messages from the UE.
- h) Repeat steps b)-g) until the confidence level according to annex F.6.2 is achieved.

NOTE: T1 is initially 30 s to allow enough time for the UE to search for cells as it has no prior knowledge of these.

#### 8.2.2.2.4.3 7,68 Mcps Option

##### 8.2.2.2.4.3.1 Initial conditions

This scenario implies the presence of 2 carriers and 6 cells as given in table 8.2.2.2.1B and table 8.2.2.2.2B. Cell 1 and cell 2 shall belong to different Location Areas.

**Table 8.2.2.2.1B: General test parameters for Cell Re-selection to intra-frequency TDD cell**

Parameter	Unit	Value	Comment
Initial condition	Active cell	Cell1	
	Neighbour cells	Cell2, Cell3, Cell4, Cell5, Cell6	
Final condition	Active cell	Cell2	
HCS		Not used	
UE_TXPWR_MAX_RACH	dBm	21	The value shall be used for all cells in the test.
Qrxlevmin	dBm	-102	The value shall be used for all cells in the test.
Access Service Class (ASC#0) - Persistence value		1	Selected so that no additional delay is caused by the random access procedure. The value shall be used for all cells in the test.
T <sub>SI</sub>	s	1.28	The value shall be used for all cells in the test.
DRX cycle length	s	1.28	The value shall be used for all cells in the test.
T1	s	30	
T2	s	15	

Table 8.2.2.2B: Cell re-selection to intra-frequency TDD cell

Parameter	Unit	Cell 1				Cell 2				Cell 3			
		0		8		0		8		0		8	
Timeslot Number		T1	T2	T1	T2	T1	T2	T1	T2	T1	T2	T1	T2
UTRA RF Channel Number		Channel 1				Channel 2				Channel 1			
PCCPCH_Ec/lor	dB	-3	-3			-3	-3			-3	-3		
SCH_Ec/lor	dB	-9	-9	-9	-9	-9	-9	-9	-9	-9	-9	-9	-9
SCH_offset		0	0	0	0	5	5	5	5	10	10	10	10
PICH_Ec/lor	dB			-3	-3			-3	-3			-3	-3
OCNS_Ec/lor	dB	-3,12	-3,12	-3,12	-3,12	-3,12	-3,12	-3,12	-3,12	-3,12	-3,12	-3,12	-3,12
$\hat{I}_{or}/I_{oc}$	dB	6	0	6	0	0	6	0	6	-3	-3	-3	-3
PCCPCH RSCP	dBm	-67	-73			-73	-67			-76	-76		
Qoffset1 <sub>s,n</sub>	dB	C1, C2: 0; C1, C3:0; C1,C4:0 C1, C5:0; C1, C6:0				C2, C1: 0; C2, C3:0; C2,C4:0 C2, C5:0; C2, C6:0				C3, C1: 0; C3, C2:0; C3,C4:0 C3, C5:0; C3, C6:0			
Qhyst1 <sub>s</sub>	dB	0				0				0			
Treselection	s	0				0				0			
Sintrasearch	dB	not sent				not sent				not sent			
Sintersearch	dB	not sent				not sent				not sent			
Timeslot		Cell 4				Cell 5				Cell 6			
		0		8		0		8		0		8	
UTRA RF Channel Number		Channel 1				Channel 2				Channel 2			
PCCPCH_Ec/lor	dB	-3	-3			-3	-3			-3	-3		
SCH_Ec/lor	dB	-9	-9	-9	-9	-9	-9	-9	-9	-9	-9	-9	-9
SCH_offset		15	15	15	15	20	20	20	20	25	25	25	25
PICH_Ec/lor	dB			-3	-3			-3	-3			-3	-3
OCNS	dB	-3,12	-3,12	-3,12	-3,12	-3,12	-3,12	-3,12	-3,12	-3,12	-3,12	-3,12	-3,12
$\hat{I}_{or}/I_{oc}$	dB	-3	-3	-3	-3	-3	-3	-3	-3	-3	-3	-3	-3
PCCPCH RSCP	dBm	-76	-76			-76	-76			-76	-76		
Qoffset1 <sub>s,n</sub>	dB	C4, C1: 0; C4, C2:0; C4,C3:0 C4, C5:0; C4, C6:0				C5, C1: 0; C5, C2:0; C5,C3:0 C5, C4:0; C5, C6:0				C6, C1: 0; C6, C2:0; C6,C3:0 C6, C4:0; C6, C5:0			
Qhyst1 <sub>s</sub>	dB	0				0				0			
Treselection	s	0				0				0			
Sintrasearch	dB	not sent				not sent				not sent			
Sintersearch	dB	not sent				not sent				not sent			
$I_{oc}$	dBm/7,6 8 MHz	-70											
Propagation Condition		AWGN											



#### 8.2.2.2.4.3.2 Procedure

- a) The SS activates cell 1-6 with T1 defined parameters and monitors cell 1 and 2 for RRC CONNECTION REQUEST messages from the UE.
- b) The UE is switched on.
- c) The SS waits until the UE camps on Cell 1 and sends the RRC CONNECTION REQUEST message.
- d) After 15 s, the parameters are changed as described for T2.
- e) The SS waits for RRC CONNECTION REQUEST messages from the UE.
- f) After another 15 s, the parameters are changed as described for T1.
- g) The SS waits for RRC CONNECTION REQUEST messages from the UE.
- h) Repeat steps d) to g) until the confidence level according to annex F.6.2 is achieved.

NOTE: T1 is initially 30 s to allow enough time for the UE to search for cells as it has no prior knowledge of these.

#### 8.2.2.2.5 Test Requirements

##### 8.2.2.2.5.1 3,84 Mcps Option

- 1) In step c), after the UE has responded on cell 1, it shall not respond on any other cell (cell selection).
- 2) In step e), the UE shall respond on cell 1 within 8 s.
- 3) In step g), the UE shall respond on cell 2 within 8 s.

For the test to pass, the total number of fulfilled test requirements 2) and 3) shall be more than [FFS]% of the cases.

NOTE: If the above Test Requirement differs from the Minimum Requirement then the Test Tolerance applied for this test is non-zero. The Test Tolerance for this test is defined in clause F.2 and the explanation of how the Minimum Requirement has been relaxed by the Test Tolerance is given in clause F.4.

##### 8.2.2.2.5.2 1,28 Mcps Option

- 1) In step c), after the UE has responded on cell 1, it shall not respond on any other cell (cell selection).
- 2) In step e), the UE shall respond on cell 1 within 8 s.
- 3) In step g), the UE shall respond on cell 2 within 8 s.

For the test to pass, the total number of successful tests shall be more than 90% with a confidence level of 95% of the cases.

NOTE: If the above Test Requirement differs from the Minimum Requirement then the Test Tolerance applied for this test is non-zero. The Test Tolerance for this test is defined in clause F.2 and the explanation of how the Minimum Requirement has been relaxed by the Test Tolerance is given in clause F.4.

##### 8.2.2.2.5.3 7,68 Mcps Option

- 1) In step c), after the UE has responded on cell 1, it shall not respond on any other cell (cell selection).
- 2) In step e), the UE shall respond on cell 1 within 8 s.
- 3) In step g), the UE shall respond on cell 2 within 8 s.

For the test to pass, the total number of fulfilled test requirements 2) and 3) shall be more than 90% of the cases.

NOTE: If the above Test Requirement differs from the Minimum Requirement then the Test Tolerance applied for this test is non-zero. The Test Tolerance for this test is defined in clause F.2 and the explanation of how the Minimum Requirement has been relaxed by the Test Tolerance is given in clause F.4.

8.2.2.2A Scenario 2A: 3,84 Mcps TDD cell re-selection for 1,28 Mcps TDD UE  
[FFS]

8.2.2.2B Scenario 2B: 1,28 Mcps TDD cell re-selection for 3,84 Mcps TDD UE  
FFS

8.2.2.2C Scenario 2C: 3,84 Mcps TDD cell re-selection for 7,68 Mcps TDD UE

8.2.2.2C.1 Definition and applicability

The cell re-selection delay is defined as the time from a change of cell levels to the moment when this change causes the UE to camp on a new cell, and starts to send the RRC CONNECTION REQUEST message to perform a Location Registration on the new cell.

The requirements and this test applies to UEs supporting both 3.84 Mcps TDD and 7.68Mcps TDD.

8.2.2.2C.2 Minimum requirement

The cell re-selection delay shall be less than 8 s.

The rate of correct cell reselections observed during repeated tests shall be at least 90% with a confidence level of [FFS]%.  
[FFS]%

The rate of correct cell reselections observed during repeated tests shall be at least 90%.

NOTE:

$$T_{\text{evaluateTDD}} + T_{\text{SI}}$$

where:

$T_{\text{evaluateTDD}}$  A DRX cycle length of 1280ms is assumed for this test case, this leads to a  $T_{\text{evaluateTDD}}$  of 6.4s according to Table 4.1B in section 4.2.

$T_{\text{SI}}$  Maximum repetition rate of relevant system info blocks that needs to be received by the UE to camp on a cell. 1280 ms is assumed in this test case.

This gives a total of 7.68 s, allow 8s in the test case.

The normative reference for this requirement is TS 25.123 [2] clauses 4.2.2 and A.4.2.2.

8.2.2.2C.3 Test purpose

This test is to verify the requirement for the cell re-selection delay in the 7.68Mcps TDD to 3.84 Mcps TDD case.

8.2.2.2C.4 Method of test

8.2.2.2C.4.1 Initial conditions

This scenario implies the presence of 1 higher chip rate (7.68 Mcps TDD OPTION) and 1 high chip rate (3.84 Mcps TDD OPTION) cell as given in Table 8.2.2.2C.1 and 8.2.2.2C.1.

Cell 1 and cell 2 shall belong to different Location Areas.

**Table 8.2.2.2C.1: General test parameters for TDD higher chip rate (7.68 Mcps) to TDD high chip rate (3.84 Mcps) cell re-selection**

Parameter		Unit	Value	Comment
Initial condition	Active cell		Cell1	7.68 Mcps TDD OPTION cell
	Neighbour cell		Cell2	3.84 Mcps TDD OPTION cell
Final condition	Active cell		Cell2	3.84 Mcps TDD OPTION cell
HCS			Not used	
UE_TXPWR_MAX_RACH		dBm	21	The value shall be used for all cells in the test.
Qrxlevmin		dBm	-102	The value shall be used for all cells in the test.
Access Service Class (ASC#0) - Persistence value			1	Selected so that no additional delay is caused by the random access procedure. The value shall be used for all cells in the test.
T <sub>SI</sub>		S	1,28	The value shall be used for all cells in the test.
DRX cycle length		S	1,28	The value shall be used for all cells in the test.
T1		S	30	
T2		S	15	

**Table 8.2.2.2C.2: Test parameters for TDD higher chip rate (7.68 Mcps) to TDD high chip rate (3.84 Mcps) cell re-selection**

Parameter	Unit	Cell 1				Cell 2			
		0		8		0		8	
Timeslot Number		T1	T2	T1	T2	T1	T2	T1	T2
UTRA RF Channel Number		Channel 1				Channel 2			
PCCPCH_Ec/I <sub>or</sub>	dB	-3	-3			-3	-3		
SCH_Ec/I <sub>or</sub>	dB	-9	-9	-9	-9	-9	-9	-9	-9
SCH_offset		0	0	0	0	5	5	5	5
PICH_Ec/I <sub>or</sub>	dB			-3	-3			-3	-3
OCNS_Ec/I <sub>or</sub>		-3,12	-3,12	-3,12	-3,12	-3,12	-3,12	-3,12	-3,12
$\hat{I}_{or}/I_{oc}$	dB	10	7	10	7	7	10	7	10
PCCPCH_RSCP	dBm	-63	-66			-66	-63		
Qoffset1 <sub>s,n</sub>	dB	C1, C2: 0				C2, C1: 0			
Qhyst1 <sub>s</sub>	dB	0				0			
Treselection	s	0				0			
Sintersearch	dB	not sent				not sent			
I <sub>oc</sub>		-70 dBm/7.68 MHz				-70 dBm/3.84 MHz			
Propagation Condition		AWGN							

**8.2.2.2C.4.2 Procedure**

- The SS activates cell 1 and 2 with T1 defined parameters and monitors cell 1 and 2 for RRC CONNECTION REQUEST messages from the UE.
- The UE is switched on.
- The SS waits until the UE camps on Cell 1 and sends the RRC CONNECTION REQUEST message.
- After 15 s, the parameters are changed as described for T2.
- The SS waits for RRC CONNECTION REQUEST messages from the UE.
- After another 15 s, the parameters are changed as described for T1.
- The SS waits for RRC CONNECTION REQUEST messages from the UE.

h) Repeat steps d) to g) [TBD] times.

NOTE: T1 is initially 30 s to allow enough time for the UE to search for cells as it has no prior knowledge of these.

### 8.2.2.2C.5 Test Requirements

- 1) In step c), after the UE has responded on cell 1, it shall not respond on any other cell (cell selection).
- 2) In step e), the UE shall respond on cell 1 within 8 s.
- 3) In step g), the UE shall respond on cell 2 within 8 s.

For the test to pass, the total number of fulfilled test requirements 2) and 3) shall be more than [FFS]% of the cases.

NOTE: If the above Test Requirement differs from the Minimum Requirement then the Test Tolerance applied for this test is non-zero. The Test Tolerance for this test is defined in clause F.2 and the explanation of how the Minimum Requirement has been relaxed by the Test Tolerance is given in clause F.4.

### 8.2.2.2D Scenario 2D: 7,68 Mcps TDD cell re-selection for 3,84 Mcps TDD UE

#### 8.2.2.2D.1 Definition and applicability

The cell re-selection delay is defined as the time from a change of cell levels to the moment when this change causes the UE to camp on a new cell, and starts to send the RRC CONNECTION REQUEST message to perform a Location Registration on the new cell.

The requirements and this test applies to UEs supporting both 3.84 Mcps TDD and 7.68Mcps TDD.

#### 8.2.2.2D.2 Minimum requirement

The cell re-selection delay shall be less than 8 s.

The rate of correct cell reselections observed during repeated tests shall be at least 90% with a confidence level of [FFS]%.

The rate of correct cell reselections observed during repeated tests shall be at least 90%.

NOTE:

$$T_{\text{evaluateTDD}} + T_{\text{SI}}$$

where:

$T_{\text{evaluateTDD}}$  A DRX cycle length of 1280ms is assumed for this test case, this leads to a  $T_{\text{evaluate TDD}}$  of 6.4s according to Table 4.1B in section 4.2.

$T_{\text{SI}}$  Maximum repetition rate of relevant system info blocks that needs to be received by the UE to camp on a cell. 1280 ms is assumed in this test case.

This gives a total of 7.68 s, allow 8s in the test case.

The normative reference for this requirement is TS 25.123 [2] clauses 4.2.2 and A.4.2.2.

#### 8.2.2.2D.3 Test purpose

This test is to verify the requirement for the cell re-selection delay in the 3.84Mcps TDD to 7.68 Mcps TDD case.

#### 8.2.2.2D.4 Method of test

##### 8.2.2.2D.4.1 Initial conditions

This scenario implies the presence of one 3.84 Mcps TDD serving cell, and one 7.68 Mcps TDD cell to be re-selected. The UE is requested to monitor neighbouring cells on one 3.84Mcps TDD carrier and one 7.68 Mcps TDD carrier. Test parameters are given in Table 8.2.2.2D.1 and 8.2.2.2D.2.

Cell 1 and cell 2 shall belong to different Location Areas.

**Table 8.2.2.D.1: General test parameters for 3.84 Mcps /7.68 Mcps TDD cell re-selection**

Parameter		Unit	Value	Comment
Initial condition	Active cell		Cell 1	3.84 Mcps TDD OPTION cell
	Neighbour cell		Cell 2	7.68 Mcps TDD OPTION cell
Final condition	Active cell		Cell 2	7.68 Mcps TDD OPTION cell
HCS			Not used	
UE_TXPWR_MAX_RACH		dBm	21	The value shall be used for all cells in the test.
$Q_{rxlevmin}$		dBm	-102	
Access Service Class (ASC#0) - Persistence value			1	Selected so that no additional delay is caused by the random access procedure. The value shall be used for all cells in the test.
$T_{SI}$		S	1,28	The value shall be used for all cells in the test.
DRX cycle length		S	1,28	The value shall be used for all cells in the test.
$T_1$		S	30	
$T_2$		S	15	

**Table 8.2.2.D.2: Cell 1 specific test parameters for 3.84 Mcps TDD/7.68 Mcps TDD cell re-selection**

Parameter	Unit	Cell 1				Cell 2			
		0		8		0		8	
Timeslot Number		T1	T2	T1	T2	T1	T2	T1	T2
UTRA RF Channel Number		Channel 1				Channel 2			
PCCPCH_Ec/lor	dB	-3	-3			-3	-3		
SCH_Ec/lor	dB	-9	-9	-9	-9	-9	-9	-9	-9
SCH_offset		0	0	0	0	5	5	5	5
PICH_Ec/lor	dB			-3	-3			-3	-3
OCNS_Ec/lor		-3,12	-3,12	-3,12	-3,12	-3,12	-3,12	-3,12	-3,12
$\hat{I}_{or}/I_{oc}$	dB	10	7	10	7	7	10	7	10
PCCPCH_RSCP	dBm	-63	-66			-66	-63		
Qoffset1 <sub>s,n</sub>	dB	C1, C2: 0				C2, C1: 0			
Qhyst1 <sub>s</sub>	dB	0				0			
Treselection	s	0				0			
Sintersearch	dB	not sent				not sent			
$I_{oc}$		-70 dBm/3.84 MHz				-70 dBm/7.68 MHz			
Propagation Condition		AWGN							

#### 8.2.2.D.4.2 Procedure

- The SS activates cell 1 and 2 with T1 defined parameters and monitors cell 1 and 2 for RRC CONNECTION REQUEST messages from the UE.
- The UE is switched on.
- The SS waits until the UE camps on Cell 1 and sends the RRC CONNECTION REQUEST message.
- After 15 s, the parameters are changed as described for T2.
- The SS waits for RRC CONNECTION REQUEST messages from the UE.
- After another 15 s, the parameters are changed as described for T1.
- The SS waits for RRC CONNECTION REQUEST messages from the UE.
- Repeat steps d) to g) [TBD] times.

NOTE: T1 is initially 30 s to allow enough time for the UE to search for cells as it has no prior knowledge of these.

### 8.2.2.2D.5 Test Requirements

- 1) In step c), after the UE has responded on cell 1, it shall not respond on any other cell (cell selection).
- 2) In step e), the UE shall respond on cell 1 within 8 s.
- 3) In step g), the UE shall respond on cell 2 within 8 s.

For the test to pass, the total number of fulfilled test requirements 2) and 3) shall be more than [FFS]% of the cases.

NOTE: If the above Test Requirement differs from the Minimum Requirement then the Test Tolerance applied for this test is non-zero. The Test Tolerance for this test is defined in clause F.2 and the explanation of how the Minimum Requirement has been relaxed by the Test Tolerance is given in clause F.4.

### 8.2.2.3 Scenario 3: TDD/FDD Cell re-selection

#### 8.2.2.3.1 Definition and applicability

##### 8.2.2.3.1.1 3,84 Mcps Option

The cell re-selection delay is defined as the time from when the cell quality levels change to the moment when this change makes the UE reselect a better ranked cell, and starts to send preambles on the PRACH for sending the RRC CONNECTION REQUEST message to perform a Location Registration on the new cell.

This test is for the case where the UE camps on a 3,84 Mcps TDD cell and reselects to an FDD cell.

The requirements and this test apply to UEs supporting both 3,84 Mcps TDD and FDD.

##### 8.2.2.3.1.2 1,28 Mcps Option

The cell re-selection delay is defined as the time from the beginning of time period T2, to the moment when the UE camps on Cell 2, and starts to send preambles on the PRACH for sending the RRC CONNECTION REQUEST message to perform a Location Registration on cell 2.

This test is for the case where the UE camps on a 1,28 Mcps TDD cell and reselects to an FDD cell.

The requirements and this test apply to UEs supporting both 1,28 Mcps TDD and FDD.

##### 8.2.2.3.1.3 7,68 Mcps Option

The cell re-selection delay is defined as the time from when the cell quality levels change to the moment when this change makes the UE reselect a better ranked cell, and starts to send preambles on the PRACH for sending the RRC CONNECTION REQUEST message to perform a Location Registration on the new cell.

This test is for the case where the UE camps on a 7,68 Mcps TDD cell and reselects to an FDD cell.

The requirements and this test apply to UEs supporting both 7,68 Mcps TDD and FDD.

#### 8.2.2.3.2 Minimum requirements

##### 8.2.2.3.2.1 3,84 Mcps TDD Option

The cell re-selection delay shall be less than 8 s when the DRX cycle length is 1,28 s.

The rate of correct cell reselections observed during repeated tests shall be at least 90% with a confidence level of [FFS]%.

NOTE:

The cell re-selection delay can be expressed as:  $T_{\text{evaluateFDD}} + T_{\text{SI}}$ , where:

$T_{\text{evaluateFDD}}$  See TS 25.123 [2] table 4.1 in clause 4.2.2.

$T_{SI}$  Maximum repetition rate of relevant system info blocks that needs to be received by the UE to camp on a cell. 1280 ms is assumed in this test case.

This gives a total of 7.68 s, allow 8s in the test case.

The normative reference for this requirement is TS 25.123 [2] clauses 4.2.2 and A.4.2.3.

#### 8.2.2.3.2.2 1,28 Mcps TDD Option

The minimum requirement for the cell re-selection delay is less than 8 s with a DRX cycle length of 1280ms.

This shall be verified in more than 90% of the cases with a confidence level of 95%.

The normative reference for this requirement is TS 25.123 [2] clauses 4.2.2 and A4.2.3.

NOTE: The cell re-selection delay can be expressed as:  $T_{\text{evaluateFDD}} + T_{SI}$ , where:

$T_{\text{evaluateFDD}}$  A DRX cycle length of 1280ms is assumed for this test case, this leads to a  $T_{\text{evaluateFDD}}$  of 6.4s according to table F2.4.1.A in Annex F clause F.2.4.

$T_{SI}$  Maximum repetition rate of relevant system info blocks that needs to be received by the UE to camp on a cell. 1280 ms is assumed in this test case.

This gives a total of 7,68 s, allow 8 s in the test case.

#### 8.2.2.3.2.3 7,68 Mcps TDD Option

The cell re-selection delay shall be less than 8 s when the DRX cycle length is 1,28 s.

The rate of correct cell reselections observed during repeated tests shall be at least 90% with a confidence level of 95%.

NOTE:

The cell re-selection delay can be expressed as:  $T_{\text{evaluateFDD}} + T_{SI}$ , where:

$T_{\text{evaluateFDD}}$  A DRX cycle length of 1280ms is assumed for this test case, this leads to a  $T_{\text{evaluateTDD}}$  of 6.4s. See TS 25.123 [2] table 4.1 in clause 4.2.2.

$T_{SI}$  Maximum repetition rate of relevant system info blocks that needs to be received by the UE to camp on a cell. 1280 ms is assumed in this test case.

This gives a total of 7.68 s, allow 8s in the test case.

The normative reference for this requirement is TS 25.123 [2] clauses 4.2.2 and A.4.2.3.

#### 8.2.2.3.3 Test purpose

The test purpose is to verify the requirement for the cell re-selection.

#### 8.2.2.3.4 Method of test

##### 8.2.2.3.4.1 3,84 Mcps Option

##### 8.2.2.3.4.1.1 Initial conditions

This scenario implies the presence of 1 TDD and 1 FDD cell as given in table 8.2.2.3.4.1 and table 8.2.2.3.4.2. Cell 1 and cell 2 shall belong to different Location Areas.

Table 8.2.2.3.4.1: General test parameters for the TDD/FDD cell re-selection

Parameter	Unit	Value	Comment
Initial condition	Active cell	Cell1	TDD cell
	Neighbour cells	Cell2	FDD cell
Final condition	Active cell	Cell2	
HCS		Not used	
UE_TXPWR_MAX_RACH	dBm	21	The value shall be used for all cells in the test.
Access Service Class (ASC#0) - Persistence value		1	Selected so that no additional delay is caused by the random access procedure. The value shall be used for all cells in the test.
$T_{SI}$	s	1,28	The value shall be used for all cells in the test.
DRX cycle length	s	1,28	The value shall be used for all cells in the test.
T1	s	30	
T2	s	15	

Table 8.2.2.3.4.2: TDD/FDD cell re-selection

Parameter	Unit	Cell 1				Cell 2	
		0		8		n.a.	n.a.
Timeslot Number		T1	T2	T1	T2	T1	T2
UTRA RF Channel Number		Channel 1				Channel 2	
CPICH_Ec/lor	dB	n.a.		n.a.		-10	-10
PCCPCH_Ec/lor	dB	-3	-3			-12	-12
SCH_Ec/lor	dB	-9	-9	-9	-9	-12	-12
SCH_offset		0	0	0	0	n.a.	n.a.
PICH_Ec/lor	dB			-3	-3	-15	-15
OCNS_Ec/lor	dB	-3,12	-3,12	-3,12	-3,12	-0,941	-0,941
$\hat{I}_{or}/I_{oc}$	dB	3	-2	3	-2	-2	3
$I_{oc}$	dBm/3,84 MHz	-70					
CPICH_RSCP	dBm	n.a.		n.a.		-82	-77
PCCPCH_RSCP	dBm	-70	-75			n.a.	n.a.
Cell_selection and reselectionquality_measure		CPICH_RSCP				CPICH_RSCP	
Qrxlevmin	dBm	-102				-115	
Qoffset1 <sub>s,n</sub>	dB	C1, C2: -12				C2, C1: +12	
Qhyst1 <sub>s</sub>	dB	0				0	
Treselection	s	0				0	
Sintersearch	dB	not sent				not sent	
Propagation Condition		AWGN				AWGN	

## 8.2.2.3.4.1.2 Procedure

- The SS activates cell 1 and cell 2 with T1 defined parameters and monitors them for RRC CONNECTION REQUEST messages from the UE.
- The UE is switched on.
- The SS waits until the UE camps on Cell 1 and sends the RRC CONNECTION REQUEST message.
- After 30 s, the parameters are changed as described for T2.
- The SS waits for RRC CONNECTION REQUEST messages from the UE.
- After another 15 s, the parameters are changed as described for T1.
- The SS waits for RRC CONNECTION REQUEST messages from the UE.
- Repeat steps d) to g) [TBD] times.



## 8.2.2.3.4.2 1,28 Mcps Option

## 8.2.2.3.4.2.1 Initial Conditions

This test is to verify the requirement for the 1,28 Mcps TDD OPTION/FDD cell re-selection delay reported in clause 4.2. in [2]

This scenario implies the presence 1.28Mps TDD serving cell, and 1 FDD cell to be selected. The UE is requested to monitor neighbouring cells on 1 1.28Mcps TDD carrier and 1 FDD carrier. Test parameters are given in table 8.2.2.3.4.1A and table 8.2.2.3.4.2A.

Cell 1 and cell 2 shall belong to different Location Areas.

**Table 8.2.2.3.4.1A: General test parameters for the TDD/FDD cell re-selection**

Parameter	Unit	Value	Comment
Initial condition	Active cell	Cell1	1,28 Mcps TDD OPTION cell
	Neighbour cells	Cell2	FDD cell
Final condition	Active cell	Cell2	FDD cell
HCS		Not used	
UE_TXPWR_MAX_RACH	dBm	21	The value shall be used for all cells in the test.
Access Service Class (ASC#0) - Persistence value		1	Selected so that no additional delay is caused by the random access procedure. The value shall be used for all cells in the test.
T <sub>SI</sub>	s	1,28	The value shall be used for all cells in the test.
DRX cycle length	s	1,28	The value shall be used for all cells in the test.
T1	s	30	
T2	s	15	

**Table 8.2.2.3.4.2A: Test parameters for the 1,28 Mcps TDD OPTION/FDD cell re-selection**

Parameter	Unit	Cell 1				Cell 2	
		0		DwPts		n.a.	
Timeslot Number							
		T1	T2	T1	T2	T1	T2
UTRA RF Channel Number		Channel 1					
PCCPCH_Ec/I <sub>or</sub>	dB	-3	-3			-12	-12
DwPCH_Ec/I <sub>or</sub>	dB			0	0	n.a.	
CPICH_Ec/I <sub>or</sub>	dB	n.a.		n.a.		-10	-10
SCH_Ec/I <sub>or</sub>	dB	n.a.		n.a.		-12	-12
PICH_Ec/I <sub>or</sub>	dB					-15	-15
OCNS_Ec/I <sub>or</sub>	dB	-3		-3		-0,941	-0,941
$\hat{I}_{or}/I_{oc}$	dB	8	2	8	2	-3	-3
$I_{oc}$		-70 dBm/1.28MHz				-70 dBm/3.84MHz	
PCCPCH_RSCP	dBm	-65	-71			n.a.	n.a.
CPICH_RSCP		n.a.				-83	-77
Cell_selection_and_reselection_quality_measure		CPICH_RSCP				CPICH_RSCP	
Qrxlevmin	dBm	-103				-115	
Qoffset1 <sub>s,n</sub>	dB	C1, C2: -12				C2, C1: +12	
Qhyst1 <sub>s</sub>	dB	0				0	
Treselection	s	0				0	
Sintersearch	dB	not sent					
Propagation Condition		AWGN					
* Note: In the case of multi-frequency cell, the UTRA RF Channel Number is the primary frequency's channel number.							

## 8.2.2.3.4.2.2 Procedure

- a) The SS activates cell 1 and cell 2 with T1 defined parameters and monitors them for RRC CONNECTION REQUEST messages from the UE.

- b) The UE is switched on.
- c) The SS waits until the UE camps on Cell 1 and sends the RRC CONNECTION REQUEST message.
- d) After 30 s, the parameters are changed as described for T2.
- e) The SS waits for RRC CONNECTION REQUEST messages from the UE.
- f) After another 15 s, the parameters are changed as described for T1.
- g) The SS waits for SYNCH-UL sequence in the UpPTS for sending RRC CONNECTION REQUEST messages from the UE.
- h) Repeat steps b)-g) until the confidence level according to annex F.6.2 is achieved.

8.2.2.3.4.3 7,68 Mcps Option

8.2.2.3.4.3.1 Initial conditions

This scenario implies the presence of 1 TDD and 1 FDD cell as given in table 8.2.2.3.4.1B and table 8.2.2.3.4.2B. Cell 1 and cell 2 shall belong to different Location Areas.

**Table 8.2.2.3.4.1B: General test parameters for the TDD/FDD cell re-selection**

Parameter		Unit	Value	Comment
Initial condition	Active cell		Cell1	TDD cell
	Neighbour cells		Cell2	FDD cell
Final condition	Active cell		Cell2	
HCS			Not used	
UE_TXPWR_MAX_RACH		dBm	21	The value shall be used for all cells in the test.
Access Service Class (ASC#0) - Persistence value			1	Selected so that no additional delay is caused by the random access procedure. The value shall be used for all cells in the test.
DRX cycle length		s	1.28	The value shall be used for all cells in the test.
T1		s	30	During T1 cell 1 better ranked than cell 2
T2		s	15	During T2 cell 2 better ranked than cell 1

**Table 8.2.2.3.4.2B: TDD/FDD cell re-selection**

Parameter	Unit	Cell 1				Cell 2	
		0		8		n.a.	n.a.
Timeslot Number		T1	T2	T 1	T 2	T 1	T 2
UTRA RF Channel Number		Channel 1				Channel 2	
CPICH_Ec/lor	dB	n.a.		n.a.		-10	-10
PCCPCH_Ec/lor	dB	-3	-3			-12	-12
SCH_Ec/lor	dB	-9	-9	-9	-9	-12	-12
SCH_t_offset		0	0	0	0	n.a.	n.a.
PICH_Ec/lor	dB			-3	-3	-15	-15
OCNS_Ec/lor	dB	-3,12	-3,12	-3,12	-3,12	-0,941	-0,941
$\hat{I}_{or}/I_{oc}$	dB	3	-2	3	-2	-2	3
$I_{oc}$		-70 dBm/7.68 MHz				-70 dBm/3.84 MHz	
CPICH_RSCP	dBm	n.a.		n.a.		-82	-77
PCCPCH_RSCP	dBm	-70	-75			n.a.	n.a.
Cell_selection_and_reselection_quality_measure		CPICH_RSCP				CPICH_RSCP	
Qrxlevmin	dBm	-102				-115	
Qoffset <sub>s,n</sub>	dB	C1, C2: -12				C2, C1: +12	
Qhyst <sub>s</sub>	dB	0				0	
Treselection	s	0				0	
Propagation Condition		AWGN				AWGN	

#### 8.2.2.3.4.3.2 Procedure

- a) The SS activates cell 1 and cell 2 with T1 defined parameters and monitors them for RRC CONNECTION REQUEST messages from the UE.
- b) The UE is switched on.
- c) The SS waits until the UE camps on Cell 1 and sends the RRC CONNECTION REQUEST message.
- d) After 30 s, the parameters are changed as described for T2.
- e) The SS waits for RRC CONNECTION REQUEST messages from the UE.
- f) After another 15 s, the parameters are changed as described for T1.
- g) The SS waits for RRC CONNECTION REQUEST messages from the UE.
- h) Repeat steps d) to g) until the confidence level according to annex F.6.2 is achieved.

#### 8.2.2.3.5 Test requirements

##### 8.2.2.3.5.1 3,84 Mcps TDD Option

- 1) In step c), after the UE has responded on cell 1, it shall not respond on any other cell (cell selection).
- 2) In step e), the UE shall respond on cell 2 within 8 s.
- 3) In step g), the UE shall respond on cell 1 within 8 s.

For the test to pass, the total number of fulfilled test requirements 2) and 3) shall be more than [FFS]% of the cases.

NOTE: If the above Test Requirement differs from the Minimum Requirement then the Test Tolerance applied for this test is non-zero. The Test Tolerance for this test is defined in clause F.2 and the explanation of how the Minimum Requirement has been relaxed by the Test Tolerance is given in clause F.4.

##### 8.2.2.3.5.2 1,28 Mcps TDD Option

- 1) In step c), after the UE has responded on cell 1, it shall not respond on any other cell (cell selection).
- 2) In step e), the UE shall respond on cell 2 within 8 s.
- 3) In step g), the UE shall respond on cell 1 within 8 s.

For the test to pass, the total number of fulfilled test requirements 2) and 3) shall be more than 90% with a confidence level of 95% of the cases.

NOTE: If the above Test Requirement differs from the Minimum Requirement then the Test Tolerance applied for this test is non-zero. The Test Tolerance for this test is defined in clause F.2 and the explanation of how the Minimum Requirement has been relaxed by the Test Tolerance is given in clause F.4.

##### 8.2.2.3.5.3 7,68 Mcps TDD Option

- 1) In step c), after the UE has responded on cell 1, it shall not respond on any other cell (cell selection).
- 2) In step e), the UE shall respond on cell 2 within 8 s.
- 3) In step g), the UE shall respond on cell 1 within 8 s.

For the test to pass, the total number of fulfilled test requirements 2) and 3) shall be more than 90% of the cases.

NOTE: If the above Test Requirement differs from the Minimum Requirement then the Test Tolerance applied for this test is non-zero. The Test Tolerance for this test is defined in clause F.2 and the explanation of how the Minimum Requirement has been relaxed by the Test Tolerance is given in clause F.4.

## 8.2.2.4 Scenario 4: inter RAT cell re-selection

### 8.2.2.4.1 Definition and applicability

#### 8.2.2.4.1.1 3,84 Mcps Option

The cell re-selection delay is defined as the time from when the cell quality levels change to the moment when this change makes the UE reselect a better ranked cell, and starts to send LOCATION UPDATING REQUEST message to perform a Location update to the new cell.

This test is for the case where the UE camps on a 3,84 Mcps TDD cell and reselects to a GSM cell.

The requirements and this test apply to UEs supporting both 3,84 Mcps TDD and GSM.

#### 8.2.2.4.1.2 1,28 Mcps Option

The cell re-selection delay is defined as the time from the beginning of time period T2, to the moment when the UE camps on Cell 2, and starts to send LOCATION UPDATING REQUEST message to perform a Location update.

This test is for the case where the UE camps on a 1,28 Mcps TDD cell and reselects to a GSM cell.

The requirements and this test apply to UEs supporting both 1,28 Mcps TDD and GSM.

#### 8.2.2.4.1.3 7,68 Mcps Option

The cell re-selection delay is defined as the time from when the cell quality levels change to the moment when this change makes the UE reselect a better ranked cell, and starts to send LOCATION UPDATING REQUEST message to perform a Location update to the new cell.

This test is for the case where the UE camps on a 7,68 Mcps TDD cell and reselects to a GSM cell.

The requirements and this test apply to UEs supporting both 7,68 Mcps TDD and GSM.

### 8.2.2.4.2 Minimum requirement

#### 8.2.2.4.2.1 3,84 Mcps Option

The cell re-selection delay shall be less than  $26 \text{ s} + T_{\text{BCCH}}$ , where  $T_{\text{BCCH}}$  is the maximum time allowed to read BCCH data in the GSM cell.

NOTE: The cell re-selection delay can be expressed as:

$$4 * T_{\text{measureGSM}} + T_{\text{BCCH}}$$

where:

$T_{\text{measureGSM}}$  Specified in Table 4.1 in sub clause 4.2.2.7.1 in [2].

$T_{\text{BCCH}}$  Equal to 1.9 s, i.e. the maximum time allowed to read BCCH data when synchronised to a BCCH carrier from a GSM cell (specified in TS 45.005).

The rate of correct cell reselections observed during repeated tests shall be at least 90% with a confidence level of [FFS]%.

The normative reference for this requirement is TS 25.123 [2] clauses 4.2.2 and A.4.2.4

#### 8.2.2.4.2.2 1,28 Mcps Option

The cell re-selection delay shall be less than  $8 \text{ s} + T_{\text{BCCH}}$  where  $T_{\text{BCCH}}$  is the maximum time allowed to read BCCH data from GSM cell.

The rate of correct cell reselections observed during repeated tests shall be at least 90%.

NOTE: The cell re-selection delay can be expressed as:  $\text{Max}(3 * T_{\text{measureNTDD}}, T_{\text{measureGSM}} + 1\text{DRX}) + T_{\text{BCCH}}$ , where:

$T_{\text{measureTDD}}$  A DRX cycle length of 1280ms is assumed for this test case, this leads to a  $T_{\text{measureNTDD}}$  of 1.28s according to Table 4.1A in [2].

$T_{\text{measureGSM}}$  A DRX cycle length of 1280ms is assumed for this test case, this leads to a  $T_{\text{measureGSM}}$  of 6.4s according to Table 4.1A in [2].

DRX cycle length 1.28s is assumed, see Table A.4.1A in [2].

$T_{\text{BCCH}}$  Maximum time allowed to read BCCH data from GSM cell in TS 45.005.

According to [20], the maximum time allowed to read the BCCH data, when being synchronized to a BCCH carrier, is 1.9 s.

This gives a total of  $7.68s + T_{\text{BCCH}}$ , thus allow  $8s + T_{\text{BCCH}}$ .

The normative reference for this requirement is TS 25.123 [2] clauses 4.2.2 and A.4.2.4

#### 8.2.2.4.2.3 7,68 Mcps Option

The cell re-selection delay shall be less than  $26 s + T_{\text{BCCH}}$ , where  $T_{\text{BCCH}}$  is the maximum time allowed to read BCCH data in the GSM cell [21].

The rate of correct cell reselections observed during repeated tests shall be at least 90%.

NOTE: The cell re-selection delay can be expressed as:

$$4 * T_{\text{measureGSM}} + T_{\text{BCCH}}$$

where:

$T_{\text{measureGSM}}$  Specified in Table 4.1B in sub clause 4.2.2.7.3 in [2].

$T_{\text{BCCH}}$  Equal to 1.9 s, i.e. the maximum time allowed to read BCCH data when synchronised to a BCCH carrier from a GSM cell [21].

This gives a total of  $25.6 s + T_{\text{BCCH}}$ , allow  $26 s + T_{\text{BCCH}}$  in the test case.

#### 8.2.2.4.3 Test purpose

This test verifies the UE meets the minimum requirement for the case where the UE camps on a TDD cell and reselects to a GSM cell.

#### 8.2.2.4.4 Method of Test

##### 8.2.2.4.4.1 3,84 Mcps Option

##### 8.2.2.4.4.1.1 Initial conditions

This scenario implies the presence of 1 3,84 Mcps TDD and 1 GSM cell as given in table 8.2.2.4.1, 8.2.2.4.2, and 8.2.2.4.3. Cell 1 and cell 2 shall belong to different Location Areas.

**Table 8.2.2.4.1: General test parameters for UTRAN to GSM Cell Re-selection**

Parameter		Unit	Value	Comment
Initial condition	Active cell		Cell1	TDD Cell
	Neighbour cell		Cell2	GSM Cell
Final condition	Active cell		Cell2	
DRX cycle length		s	1,28	UTRAN cell
BCCH repetition period (GSM cell)		s	1,87	In GSM the system information is scheduled according to an 8 x (51 x 8) cycle (i.e. a system information message is transmitted every 235 ms). The cell selection parameters in system info 3 and 4 are transmitted at least every second. (GSM 05.02)
T1		s	45	
T2		s	35	

**Table 8.2.2.4.2: Cell re-selection UTRAN to GSM cell case (cell 1)**

Parameter	Unit	Cell 1 (UTRA)			
		0		8	
Timeslot Number		T1	T2	T1	T2
UTRA RF Channel Number		Channel 1		Channel 1	
PCCPCH_Ec/lor	dB	-3	-3		
SCH_Ec/lor	dB	-9	-9	-9	-9
SCH_toffset		0	0	0	0
PICH_Ec/lor	dB			-3	-3
OCNS_Ec/lor	dB	-3,12	-3,12	-3,12	-3,12
$\hat{I}_{or}/I_{oc}$	dB	3	-2	3	-2
$I_{oc}$	dBm/3,8 4 MHz	-70		-70	
PCCPCH RSCP	dBm	-70	-75		
Propagation Condition		AWGN		AWGN	
Treselection	s	0			
Ssearch <sub>RAT</sub>	dB	not sent			

**Table 8.2.2.4.3: Cell re-selection UTRAN to GSM cell case (cell 2)**

Parameter	Unit	Cell 2 (GSM)	
		T1	T2
Absolute RF Channel Number		ARFCN 1	
RXLEV	dBm	-90	-75
RXLEV_ACCESS_MIN	dBm	-100	
MS_TXPWR_MAX_CCH	dBm	30	

#### 8.2.2.4.4.1.2 Procedure

- The SS activates cell 1 and 2 with T1 defined parameters and monitors cell 1 and 2 for RRC CONNECTION REQUEST and LOCATION UPDATING REQUEST messages from the UE.
- The UE is switched on.
- The SS waits until the UE camps on Cell 1 and sends the RRC CONNECTION REQUEST message.
- After 45 s, the parameters are changed as described for T2.
- The SS waits for LOCATION UPDATING REQUEST messages from the UE.
- After 35 s, the parameters are changed as described for T1.
- The SS waits for RRC CONNECTION REQUEST messages from the UE.
- Repeat steps d) to g) [TBD] times.

## 8.2.2.4.4.2 1,28 Mcps Option

## 8.2.2.4.4.2.1 Initial conditions

This scenario implies the presence of 1 1,28 Mcps TDD serving cell, and 1 GSM cell to be re-selected. Test parameters are given in table 8.2.2.4.1A, 8.2.2.4.2A, and 8.2.2.4.3A.

The ranking of the cells shall be made according to the cell reselection criteria specified in TS25.304. Cell 1 and cell 2 shall belong to different location areas.

**Table 8.2.2.4.1A: General test parameters for UTRAN (1,28 Mcps TDD OPTION) to GSM Cell Re-selection**

Parameter	Unit	Value	Comment
Initial condition	Active cell	Cell1	
	Neighbour cell	Cell2	
Final condition	Active cell	Cell2	
DRX cycle length	s	1,28	
T1	s	15	
T2	s	15	

**Table 8.2.2.4.2A: Cell re-selection UTRAN to GSM cell case (cell 1)**

Parameter	Unit	Cell 1 (UTRA)			
		0		DwPTS	
Timeslot Number		T1	T2	T1	T2
UTRA RF Channel Number		Channel 1		Channel 1	
PCCPCH_Ec/Ior	dB	-3	-3		
DwPCH_Ec/Ior	dB			0	0
$\hat{I}_{or}/I_{oc}$	dB	13	-12	13	-12
$I_{oc}$	dBm/1,2 8 MHz	-80			
PCCPCH RSCP	dBm	-70	-95	n.a.	n.a.
Propagation Condition		AWGN		AWGN	
Treselection	s	0			
Ssearch <sub>RAT</sub>	dB	Not sent			
Qrxlevmin	dBm	-103			
Qoffset1 <sub>s,n</sub>	dB	C1, C2: 0			
Qhyst1 <sub>s</sub>	dB	0			
* Note: In the case of multi-frequency cell, the UTRA RF Channel Number is the primary frequency's channel number.					

**Table 8.2.2.4.3A: Cell re-selection UTRAN to GSM cell case (cell 2)**

Parameter	Unit	Cell 2 (GSM)	
		T1	T2
Absolute RF Channel Number		ARFCN 1	
RXLEV	dBm	-75	-75
RXLEV_ACCESS_MIN	dBm	-104	
MS_TXPWR_MAX_CCH	dBm	33	

## 8.2.2.4.4.2.2 Procedure

- The SS activates cell 1 and 2 with T1 defined parameters and monitors cell 1 and 2 for RRC CONNECTION REQUEST and LOCATION UPDATING REQUEST messages from the UE.
- The UE is switched on.
- The SS waits until the UE camps on Cell 1 and sends the RRC CONNECTION REQUEST message.
- After 15 s, the parameters are changed as described for T2.

- e) The SS waits for LOCATION UPDATING REQUEST messages from the UE.
- f) After 15 s, the parameters are changed as described for T1.
- g) The SS waits for RRC CONNECTION REQUEST messages from the UE.
- h) Repeat steps b)-g) until the confidence level according to annex F.6.2 is achieved.

#### 8.2.2.4.4.3 7,68 Mcps Option

##### 8.2.2.4.4.3.1 Initial conditions

This scenario implies the presence of 1 7,68 Mcps TDD and 1 GSM cell as given in table 8.2.2.4.1B, 8.2.2.4.2B, and 8.2.2.4.3B. Cell 1 and cell 2 shall belong to different Location Areas.

**Table 8.2.2.4.1B: General test parameters for UTRAN to GSM Cell Re-selection**

Parameter	Unit	Value	Comment
Initial condition	Active cell	Cell1	UTRA TDD Cell
	Neighbour cell	Cell2	GSM Cell
Final condition	Active cell	Cell2	
HCS		Not used	
DRX cycle length	s	1,28	UTRA TDD cell
T1	s	45	
T2	s	35	

**Table 8.2.2.4.2B: Cell re-selection UTRAN to GSM cell case (cell 1)**

Parameter	Unit	Cell 1 (UTRA TDD)			
		0		8	
Timeslot Number		T1	T2	T1	T2
UTRA RF Channel Number		Channel 1		Channel 1	
PCCPCH_Ec/lor	dB	-3	-3		
SCH_Ec/lor	dB	-9	-9	-9	-9
SCH_toffset		0	0	0	0
PICH_Ec/lor	dB			-3	-3
OCNS_Ec/lor	dB	-3,12	-3,12	-3,12	-3,12
$\hat{I}_{or}/I_{oc}$	dB	3	-2	3	-2
$I_{oc}$	dBm/7,6 8 MHz	-70		-70	
PCCPCH RSCP	dBm	-70	-75	n.a.	n.a.
Propagation Condition		AWGN		AWGN	
Qrxlevmin	dBm	-102			
Qoffset1 <sub>s,n</sub>	dB	C1, C2: 0			
Qhyst1	dB	0			
Treselection	s	0			
Ssearch <sub>RAT</sub>	dB	not sent			

**Table 8.2.2.4.3B: Cell re-selection UTRAN to GSM cell case (cell 2)**

Parameter	Unit	Cell 2 (GSM)	
		T1	T2
Absolute RF Channel Number		ARFCN 1	
RXLEV	dBm	-90	-75
RXLEV_ACCESS_MIN	dBm	-104	
MS_TXPWR_MAX_CCH	dBm	33	

##### 8.2.2.4.4.3.2 Procedure

- a) The SS activates cell 1 and 2 with T1 defined parameters and monitors cell 1 and 2 for RRC CONNECTION REQUEST and LOCATION UPDATING REQUEST messages from the UE.
- b) The UE is switched on.



- c) The SS waits until the UE camps on Cell 1 and sends the RRC CONNECTION REQUEST message.
- d) After 45 s, the parameters are changed as described for T2.
- e) The SS waits for LOCATION UPDATING REQUEST messages from the UE.
- f) After 35 s, the parameters are changed as described for T1.
- g) The SS waits for RRC CONNECTION REQUEST messages from the UE.
- h) Repeat steps d) to g) until the confidence level according to annex F.6.2 is achieved.

#### 8.2.2.4.5 Test Requirements

##### 8.2.2.4.5.1 3,84 Mcps Option

- 1) In step c), after the UE has responded on cell 1, it shall not respond on any other cell (cell selection).
- 2) In step e), the UE shall respond on cell 2 within 27.9 s.
- 3) In step g), the UE shall respond on cell 1.

For the test to pass, the total number of fulfilled test requirements in step 2) shall be at least 90% of the cases.

NOTE: If the above Test Requirement differs from the Minimum Requirement then the Test Tolerance applied for this test is non-zero. The Test Tolerance for this test is defined in clause F.2 and the explanation of how the Minimum Requirement has been relaxed by the Test Tolerance is given in clause F.4.

##### 8.2.2.4.5.2 1,28 Mcps Option

- 1) In step c), after the UE has responded on cell 1, it shall not respond on any other cell (cell selection).
- 2) In step e), the UE shall respond on cell 2 within 9.7 s.
- 3) In step g), the UE shall respond on cell 1.

For the test to pass, the total number of successful tests shall be more than 90% with a confidence level of 95% of the cases.

NOTE: If the above Test Requirement differs from the Minimum Requirement then the Test Tolerance applied for this test is non-zero. The Test Tolerance for this test is defined in clause F.2 and the explanation of how the Minimum Requirement has been relaxed by the Test Tolerance is given in clause F.4.

##### 8.2.2.4.5.3 7,68 Mcps Option

- 1) In step c), after the UE has responded on cell 1, it shall not respond on any other cell (cell selection).
- 2) In step e), the UE shall respond on cell 2 within 27.9 s.
- 3) In step g), the UE shall respond on cell 1.

For the test to pass, the total number of fulfilled test requirements in step 2) shall be at least 90% of the cases.

NOTE: If the above Test Requirement differs from the Minimum Requirement then the Test Tolerance applied for this test is non-zero. The Test Tolerance for this test is defined in clause F.2 and the explanation of how the Minimum Requirement has been relaxed by the Test Tolerance is given in clause F.4.

#### 8.2.2.5 Scenario 4A: inter RAT cell acquisition and re-selection

##### 8.2.2.5.1 Definition and applicability

###### 8.2.2.5.1.1 3,84 Mcps Option

Void

Note: Scenario 4A does not apply for 3,84 Mcps TDD, this section numbering is purely for consistency with TS 25.123, where corresponding sections are also void.

## 8.2.2.5.1.2 1,28 Mcps Option

The cell re-selection delay is defined as the time from the beginning of time period T<sub>2</sub>, to the moment when the UE camps on Cell 2, and starts to send RR Channel Request message for location update to Cell 2. .

Unlike 1,28 Mcps scenario 4 the initial GSM RX\_LEV is set below monitoring threshold and GSM measurements do not start until the second phase of the test. The requirements and this test apply to UEs supporting both 1,28 Mcps TDD and GSM.

## 8.2.2.5.1.3 7,68 Mcps Option

Void

Note: Scenario 4A does not apply for 7,68 Mcps TDD, this section numbering is purely for consistency with TS 25.123, where corresponding sections are also void.

## 8.2.2.5.2 Minimum requirement

## 8.2.2.5.2.1 3,84 Mcps Option

Void

## 8.2.2.5.2.2 1,28 Mcps Option

The cell re-selection delay shall be less than  $26\text{ s} + T_{\text{BCCH}}$ , where  $T_{\text{BCCH}}$  is the maximum time allowed to read BCCH data from GSM cell [21].

The rate of correct cell reselections observed during repeated tests shall be at least 90%.

NOTE: The UE shall keep a running average of 4 measurements, thus gives  $4 * T_{\text{measureGSM}} + T_{\text{BCCH}}$ , where:

$T_{\text{measureGSM}}$  A DRX cycle length of 1280ms is assumed for this test case, this leads to a  $T_{\text{measureGSM}}$  of 6.4s according to Table 4.1A in section 4.2. in [2].

$T_{\text{BCCH}}$  Maximum time allowed to read BCCH data from GSM cell in TS 45.005 [20].

According to [21], the maximum time allowed to read the BCCH data, when being synchronized to a BCCH carrier, is 1.9 s.

This gives a total of  $25,6\text{ s} + T_{\text{BCCH}}$ , thus allow  $26\text{ s} + T_{\text{BCCH}}$ .

The normative reference for this requirement is TS 25.123 [2] clauses 4.2.2 and A.4.2.4.3

## 8.2.2.5.2.3 7,68 Mcps Option

Void

## 8.2.2.5.3 Test purpose

This test verifies the UE meets the minimum requirement for the case where the UE camps on a TDD cell and then acquires and reselects to a GSM cell

## 8.2.2.5.4 Method of Test

## 8.2.2.5.4.1 3,84 Mcps Option

Void

## 8.2.2.5.4.2 1,28 Mcps Option

## 8.2.2.5.4.2.1 Initial conditions

This scenario implies the presence of 1 1,28 Mcps TDD serving cell, and 1 GSM cell to be re-selected. Test parameters are given in table 8.2.2.5.1A, 8.2.2.5.2A, and 8.2.2.5.3A.

The ranking of the cells shall be made according to the cell reselection criteria specified in TS25.304. Cell 1 and cell 2 shall belong to different location areas.

**Table 8.2.2.5.1A: General test parameters for UTRAN (1,28 Mcps TDD OPTION) to GSM Cell Re-selection Scenario 4A**

Parameter		Unit	Value	Comment
Initial condition	Active cell		Cell1	1,28 Mcps TDD OPTION cell
	Neighbour cell		Cell2	GSM cell
Final condition	Active cell		Cell2	GSM cell
DRX cycle length		s	1,28	
HCS			Not Used	
T1		s	45	
T2		s	45	

**Table 8.2.2.5.2A: Cell re-selection UTRAN to GSM cell case (cell 1) Scenario 4A**

Parameter	Unit	Cell 1 (UTRA)			
		0		DwPTS	
Timeslot Number		T1	T2	T1	T2
UTRA RF Channel Number		Channel 1		Channel 1	
PCCPCH_Ec/Ior	dB	-3	-3		
DwPCH_Ec/Ior	dB			0	0
OCNS_Ec/Ior	dB	-3	-3		
$\hat{I}_{or}/I_{oc}$	dB	6	6	6	6
$I_{oc}$	dBm/1,2 8 MHz	-80			
PCCPCH RSCP	dBm	-77	-77		
Propagation Condition		AWGN		AWGN	
Treselection	s	0			
Ssearch <sub>RAT</sub>	dB	Not sent			
Qrxlevmin	dBm	-103			
Qoffset <sub>1s,n</sub>	dB	C1, C2: 0			
Qhyst <sub>1s</sub>	dB	0			
* Note: In the case of multi-frequency cell, the UTRA RF Channel Number is the primary frequency's channel number.					

**Table 8.2.2.5.3A: Cell re-selection UTRAN to GSM cell case (cell 2) Scenario 4A**

Parameter	Unit	Cell 2 (GSM)	
		T1	T2
Absolute RF Channel Number		ARFCN 1	
RXLEV	dBm	-90	-70
RXLEV_ACCESS_MIN	dBm	-104	
MS_TXPWR_MAX_CCH	dBm	33	

#### 8.2.2.5.4.2.2 Procedure

- The SS activates cell 1 and 2 with T1 defined parameters and monitors cell 1 and 2 for RRC CONNECTION REQUEST and LOCATION UPDATING REQUEST messages from the UE.
- The UE is switched on.
- The SS waits until the UE camps on Cell 1 and sends the RRC CONNECTION REQUEST message.
- After 45 s, the parameters are changed as described for T2.
- The SS waits for RR Channel Request message for a location update to Cell 2 from the UE.
- After 45 s, the parameters are changed as described for T1.
- The SS waits for RRC CONNECTION REQUEST messages from the UE.
- Repeat steps b)-g) until the confidence level according to annex F.6.2 is achieved.

8.2.2.5.4.3 7,68 Mcps Option

Void

8.2.2.5.5 Test Requirements

8.2.2.5.5.1 3,84 Mcps Option

void

8.2.2.5.5.2 1,28 Mcps Option

- 1) In step c), after the UE has responded on cell 1, it shall not respond on any other cell (cell selection).
- 2) In step e), the UE shall respond on cell 2 within 28 s.
- 3) In step g), the UE shall respond on cell 1.

For the test to pass, the total number of successful tests shall be more than 90% with a confidence level of 95% of the cases.

NOTE: If the above Test Requirement differs from the Minimum Requirement then the Test Tolerance applied for this test is non-zero. The Test Tolerance for this test is defined in clause F.2 and the explanation of how the Minimum Requirement has been relaxed by the Test Tolerance is given in clause F.4.

8.2.2.5.5.3 7,68 Mcps Option

void

8.2.2.5A Scenario 4B: UTRAN to GSM Cell Re-Selection: HCS with only UTRA level changed

8.2.2.5A.1 Definition and applicability

8.2.2.5A.1.1 3,84 Mcps Option

Void

8.2.2.5A.1.2 1,28 Mcps Option

The cell re-selection delay is defined as the time from when the cell quality levels change to the moment when this change makes the UE reselect a better ranked cell, and starts to send LOCATION UPDATING REQUEST message to perform a Location update to the new cell.

The requirements and this test apply to Release 6 and later releases for the combined TDD and GSM UE.

8.2.2.5A.1.3 7,68 Mcps Option

Void

8.2.2.5A.2 Minimum requirement

8.2.2.5A.2.1 3,84 Mcps Option

Void

8.2.2.5A.2.2 1,28 Mcps Option

The cell re-selection delay shall be less than  $37.7 \text{ s} + T_{\text{BCCH}}$ , where  $T_{\text{BCCH}}$  is the maximum time allowed to read BCCH data from GSM cell, see TS 45.008 [30].

The rate of correct cell reselections observed during repeated tests shall be at least 90% with a confidence level of 95 %.

NOTE: The cell re-selection delay can be expressed as:  $30 \text{ s} + T_{\text{measureGSM}} + \text{DRX cycle length} + T_{\text{BCCH}}$ , where:

T <sub>measureGSM</sub>	See Table 4.1 in TS 25.123 section 4.2, 6.4s
DRX cycle length	See Table 4.1 in TS 25.123 section 4.2, 1.28s
T <sub>BCCH</sub>	Maximum time allowed to read BCCH data from GSM cell, see TS 45.008 [30]. According to [20] and [30], the maximum time allowed to read the BCCH data, when being synchronized to a BCCH carrier, is 1.9 s.

This gives a total of 37.68 s + 1.9s, allow 40s in the test case.

The normative reference for this requirement is TS 25.123.

#### 8.2.2.5A.2.3 7,68 Mcps Option

Void

#### 8.2.2.5A.3 Test purpose

This test verifies the UE meets the minimum requirement for the case where the UE camps on a TDD cell and then HCS to a GSM cell.

#### 8.2.2.5A.4 Method of Test

##### 8.2.2.5A.4.1 3,84 Mcps Option

Void

##### 8.2.2.5A.4.2 1,28 Mcps Option

##### 8.2.2.5A.4.2.1 Initial conditions

Test environment: normal; see clauses G.2.1 and G.2.2.

Frequencies to be tested: mid range; see clause G.2.4.

This scenario implies the presence of 1 UTRAN serving cell, and 1 GSM cell to be re-selected, as given in tables 8.2.2.7.8.1 to 8.2.2.7.8.3. The UE is requested to monitor neighbouring cells on 1 UMTS carrier and 12 GSM cells. Cell 1 and cell 2 shall belong to different Location Areas.

**Table 8.2.2.5A.1: General test parameters for UTRAN to GSM Cell Re-selection**

Parameter		Unit	Value	Comment
Initial condition	Active cell		Cell1	1,28 Mcps TDD OPTION cell
	Neighbour cell		Cell2	GSM cell
Final condition	Active cell		Cell2	GSM cell
DRX cycle length		s	1,28	
HCS			Used	
Monitored cell list size			12 GSM neighbours including the ARFCN of cell 2	NOTE: See Annex I for cell information
T1		s	45	
T2		s	45	

Table 8.2.2.5A.1A: Cell re-selection UTRAN to GSM cell case (cell 1) Scenario 4B

Parameter	Unit	Cell 1 (UTRA)			
		0		DwPTS	
Timeslot Number		T1	T2	T1	T2
UTRA RF Channel Number		Channel 1		Channel 1	
PCCPCH_Ec/lor	dB	-3	-3		
DwPCH_Ec/lor	dB			0	0
$\hat{I}_{or}/I_{oc}$	dB	13	-12	13	-12
$I_{oc}$	dBm/1,2 8 MHz	-80			
PCCPCH RSCP	dBm	-77	-95		
Propagation Condition		AWGN		AWGN	
Treselection	s	0			
Ssearch <sub>RAT</sub>	dB	Not sent			
Qrxlevmin	dBm	-103			
Qoffset <sub>1s,n</sub>	dB	C1, C2: 0			
Qhyst <sub>1s</sub>	dB	0			
SsearchRAT	dB	0			
Penalty_time	s	0 (default value)			
HCS_PRIO		0 (default value)			
Qhcs		0 (default value)			
TCrmax	s	not used (default value)			

Table 8.2.2.5A.1B: Cell re-selection UTRAN to GSM cell case (cell 2) Scenario 4B

Parameter	Unit	Cell 2 (GSM)	
		T1	T2
Absolute RF Channel Number		ARFCN 1	
RXLEV	dBm	-80	-80
RXLEV_ACCESS_MIN	dBm	-104	
MS_TXPWR_MAX_CCH	dBm	33	
Qsearch_I	-	always	

### Specific 2 quarter Message Contents

All messages indicated shall use the same content as described in the default message content in TS45.008 [30] clause 9, with the above exceptions.

#### 8.2.2.5A.4.2.2 Procedure

- The SS activates cell 1 and 2 with T1 defined parameters in tables 8.2.3.3.4 and 8.2.3.3.5 and monitors cell 1 and 2 for random access requests from the UE.
- The UE is switched on.
- The SS and the UE shall perform a location registration procedure on cell 1.
- After 45 s from the end of step 3, the parameters are changed as described for T2 in tables 8.2.3.3.4 and 8.2.3.3.5.
- The SS waits for a location registration procedure from the UE. If the UE begins transmitting on cell 2 within 39.6 s then the number of successful tests is increased by one.
- After 45 s from the beginning of T2, the parameters are changed as described for T1 in tables 8.2.3.3.4 and 8.2.3.3.5.
- The SS and the UE shall perform a location registration procedure on cell 1.
- After 45 s from the end of step 6, the parameters are changed as described for T2 in tables 8.2.3.3.4 and 8.2.3.3.5.

Repeat step e) to h) until the confidence level according to annex F.6.2 is achieved.

## Specific Message Contents

All messages indicated above shall use the same content as described in the default message content in clause 6.1.0b of 34.108 [3], with the above and the following exceptions:

## SYSTEM INFORMATION BLOCK TYPE3:

Information Element	Value
HCS Serving Cell Information	
-HCS PRIO	0
-Qhcs	0
-TCRmax	not used

## SYSTEM INFORMATION BLOCK TYPE11

Information Element	Value
HCS neighbouring Cell Information	
-HCS PRIO	0
-Qhcs	0
-HCS Cell RE-selection Information	
-Penalty_time	0

8.2.2.5A.4.3            7,68 Mcps Option

Void

8.2.2.5A.5            Test Requirements

8.2.2.5A.5.1           3,84 Mcps Option

void

8.2.2.5A.5.2           1,28 Mcps Option

For the test to pass, the total number of successful tests shall be at least 90% of the cases with a confidence level of 95 %.

NOTE: If the above Test Requirement differs from the Minimum Requirement then the Test Tolerance applied for this test is non-zero. The Test Tolerance for this test is defined in clause F.2 and the explanation of how the Minimum Requirement has been relaxed by the Test Tolerance is given in clause F.4.

8.2.2.5A.5.3           7,68 Mcps Option

Void

8.2.2.6            Scenario 5:TDD/E-TURA cell re-selection

8.2.2.6.1            UTRA to E-UTRA TDD cell reselection: E-UTRA is of higher priority

8.2.2.6.1.1           Definition and application

8.2.2.6.1.1.1        3.84 Mcps Option

8.2.2.6.1.1.2        1.28Mcps Option

The cell reselection delay to higher priority is defined as the time from the beginning of time period T3, to the moment when the UE camps on cell2, and start to send preamble on the PRACH for the RRC CONNECTION REQUEST message on cell2.

This test is for case when the UE camps on a 1.28Mcps TDD cell and reselects to a E-UTRA TDD cell which is of higher priority.

The requirement and this test apply to UEs supporting both 1.28Mcps TDD and E-UTRA TDD.

8.2.2.6.1.1.3	7.68Mcps Option
8.2.2.6.1.2	Minimum requirement
8.2.2.6.1.2.1	3.84 Mcps Option
8.2.2.6.1.2.2	1.28Mcps Option

The cell re-selection delay to higher priority shall be less than [81] s.

The rate of correct cell reselections observed during repeated tests shall be at least 90%.

NOTE: The cell re-selection delay to higher priority cell can be expressed as:  $T_{\text{higher\_priority\_search}} + T_{\text{evaluateE-UTRA}} + T_{\text{SI}}$ ,

Where:

$T_{\text{higher\_priority\_search}}$  [60]s, See 25.123[2]section 4.2.2.5a

$T_{\text{evaluateE-UTRA}}$  [19.2]s, See 25.123[2] Table 4.2A in section 4.2.2.7

$T_{\text{SI}}$  Maximum repetition period of relevant system info blocks that needs to be received by the UE to camp on a cell; 1280 ms is assumed in this test case.

This gives a total of 80.48 s, allow 81 s for higher priority cell reselection in the test case.

8.2.2.6.1.2.3	7.68Mcps Option
8.2.2.6.1.3	Test purpose

This test verifies the UE meet minimum requirement for the case where the UE camps on a TDD cell and reselects to a E-UTRA TDD cell which is of higher priority.

8.2.2.6.1.4	Method of test
8.2.2.6.1.4.1	3.84Mcps Option
8.2.2.6.1.4.2	1.28Mcps Option
8.2.2.6.1.4.2.1	Initial conditions

This test scenario comprised of 1UTRA TDD serving cell ,and 1E-UTRA TDD cell to be re-selected. Test parameters are given in table 8.2.2.6.1.4.2.1-1, 8.2.2.6.1.4.2.1-2 and 8.2.2.6.1.4.2.1-3.The test consists of three successive time periods, with time duration of T1,T2 and T3 respectively. Both UTRA cell1 and E-UTRA cell2 are already identified by the UE prior to the start of the test, At T1 the UE is camped on to cell1. Cell2 is of higher priority than cell1.



**Table 8.2.2.6.1.4.2.1-1: General test parameters for UTRAN (1.28 Mcps TDD OPTION) to E-UTRAN TDD Cell Re-selection**

Parameter		Unit	Value	Comment
Initial condition	Active cell		Cell 2	UE shall be forced to cell 2 in the initialisation phase, so that reselection to cell 1 occurs during the first T1 phase
T1 end condition	Active cell		Cell1	UE shall perform reselection to cell 1 during T1
	Neighbour cell		Cell2	E-UTRA TDD cell
T3 end condition	Active cell		Cell2	UE shall perform reselection to cell 2 during T3
	Neighbour cell		Cell1	UTRA 1.28 Mcps TDD OPTION cell
Uplink-downlink configuration of cell 2			1	As specified in table 4.2.2 in TS 36.211
Special subframe configuration of cell 2			6	As specified in table 4.2.1 in TS 36.211
PRACH configuration of cell 2			53	As specified in table 4.7.1-3 in TS 36.211
CP length of cell 2			Normal	
Time offset between cells			3 ms	Asynchronous cells
Access Barring Information		-	Not sent	No additional delays in random access procedure.
Treselection		s	0	
DRX cycle length		s	1,28	
HCS			Not used	
T1		s	25	T1 need to be defined so that cell re-selection reaction time is taken into account.
T2			5	During T2, cell 2 shall be powered off, and during the off time the physical layer cell identity shall be changed, The intention is to ensure that cell 2 has not been detected by the UE prior to the start of period T3
T3		s	85	T3 need to be defined so that cell re-selection reaction time is taken into account.

**Table 8.2.2.6.1.4.2.1-2: Cell specific test parameters for cell re-selection UTRA TDD to E-UTRA TDD test case (cell 1)**

Parameter	Unit	Cell 1 (UTRA)					
		0			DwPTS		
Timeslot Number		T1	T2	T3	T1	T2	T3
UTRA RF Channel Number (Note1)		Channel 1					
PCCPCH_Ec/Ior	dB	-3	-3	-3			
DwPCH_Ec/Ior	dB				0	0	0
OCNS_Ec/Ior	dB	-3	-3	-3			
$I_{or}/I_{oc}$	dB	11	11	11	11	11	11
$I_{oc}$	dBm/1.28 MHz	-80					
PCCPCH RSCP	dBm	-72	-72	-72	n.a.		
Propagation Condition		AWGN					
Qrxlevmin	dBm	-103					
Qoffset1s,n	dB	C1, C2: 0					
Qhyst1s	dB	0					
Threshx, high (Note2)	dB	46 (-94dBm)					
Note1: In the case of multi-frequency cell, the UTRA RF Channel Number is the primary frequency's channel number.							
Note2: This refers to the value of Threshx, high which is included in UTRA system information, and is a threshold for the E-UTRA target cell							

**Table 8.2.2.6.1.4.2.1-3: Cell specific test parameters for cell re-selection UTRA TDD to E-UTRA TDD test case (cell 2)**

Parameter	Unit	Cell 2		
		T1	T2	T3
E-UTRA RF Channel Number		2		
BWchannel	MHz	10		
PBCH_RA	dB	0	0	0
PBCH_RB	dB			
PSS_RB	dB			
SSS_RB	dB			
PCFICH_PA	dB			
PHICH_PA	dB			
PHICH_PB	dB			
PDCCH_PA	dB			
PDCCH_PB	dB			
PDSCH_PA	dB			
PDSCH_PB	dB			
OCNG_RANote 1	dB			
OCNG_RBNote 1	dB			
Qrxlevmin	dBm/15kHz			
$N_{rx}$	dBm/15kHz	-98		
RSRP	dBm/15kHz	-101	-inf	-87
$\hat{E}_s/I_n$	dB	-3	-inf	11
Snonintrasearch	dB	Not sent		
Threshserving, low	dB	46 (-94dBm)		
Threshx, low (Note2)	dB	24 (-79dBm)		
Propagation Condition		AWGN		
Note 1: OCNG shall be used such that cell is fully allocated and a constant total transmitted power spectral density is achieved for all OFDM symbols.				
Note2: This refers to the value of Threshx, low which is included in E-UTRA system information, and is a threshold for the UTRA target cell				

**8.2.2.6.1.4.2.2 Procedure**

- a) The SS activates cell1 and cell2 with T3 defined parameters and monitors cell1 and 2 for RRC CONNECTION REQUEST messages from the UE,
- b) The UE is switched on,
- c) The SS waits until the UE camps on cell2 and sends the RRC CONNECTION REQUEST message.
- d) After 85s , the parameters are changed as described for T2.
- e) The SS waits for RRC CONNECTION REQUEST message from the UE.
- f) After 25s,cell2 is powered off.
- g) After 5s, the parameters are changed as described for T3.
- h) The SS waits for RRC CONNECTION REQUEST message from the UE.
- i) Repeat steps d) to h) [TBD]times.

8.2.2.6.1.4.3 7.68Mcps Option

8.2.2.6.1.5 Test requirement

8.2.2.6.1.5.1 3.84Mcps Option

8.2.2.6.1.5.2 1.28Mcps Option

- 1) In step c), after UE has responded on cell 2,it shall not respond to any other cell( cell selection).

- 2) In step e), the UE shall respond on cell 1.
- 3) In step h), the UE shall respond on cell 2 within 81s.

For the test to pass, the total number of fulfilled test requirement in step 3) shall be at least 90% of the cases,

NOTE: If the above Test Requirement differs from the Minimum Requirement then the Test Tolerance applied for this test is non-zero. The Test Tolerance for this test is defined in clause F.2 and the explanation of how the Minimum Requirement has been relaxed by the Test Tolerance is given in clause F.4.

8.2.2.6.1.5.3            7.68Mcps Option

8.2.2.6.2                UTRA to E-UTRA TDD cell reselection: E-UTRA is of lower priority

8.2.2.6.2.1             Definition and application

8.2.2.6.2.1.1           3.84 Mcps Option

8.2.2.6.2.1.2           1.28Mcps Option

The cell reselection delay to low priority is defined as the time from the beginning of time period T2, to the moment when the UE camps on cell2, and start to send preamble on the PRACH for the RRC CONNECTION REQUEST message on cell2.

This test is for case when the UE camps on a 1.28Mcps TDD cell and reselects to a E-UTRA TDD cell which is of lower priority.

The requirement and this test apply to UEs supporting both 1.28Mcps TDD and E-UTRA TDD.

8.2.2.6.2.1.3           7.68Mcps Option

8.2.2.6.2.2             Minimum requirement

8.2.2.6.2.2.1           3.84 Mcps Option

8.2.2.6.2.2.2           1.28Mcps Option

The cell re-selection delay to higher priority shall be less than [21] s.

The rate of correct cell reselections observed during repeated tests shall be at least 90%.

NOTE: The cell re-selection delay to lower priority cell can be expressed as:  $T_{\text{evaluateE-UTRA}} + T_{\text{SI}}$ ,

Where:

$T_{\text{evaluateE-UTRA}}$     [19.2]s, See Table 4.2A in section 4.2.2.7 in 25.123

$T_{\text{SI}}$                     Maximum repetition period of relevant system info blocks that needs to be received by the UE to camp on a cell; 1280 ms is assumed in this test case.

This gives a total of 20.48 s, allow 21 s for lower priority cell reselection in the test case.

8.2.2.6.2.2.3           7.68Mcps Option

8.2.2.6.2.3             Test purpose

This test verifies the UE meet minimum requirement for the case where the UE camps on a TDD cell and reselects to a E-UTRA TDD cell which is of lower priority.

- 8.2.2.6.2.4 Method of test
- 8.2.2.6.2.4.1 3.84Mcps Option
- 8.2.2.6.2.4.2 1.28Mcps Option
- 8.2.2.6.2.4.2.1 Initial conditions

This test scenario comprised of 1UTRA TDD serving cell ,and 1E-UTRA TDD cell to be re-selected.Test parameters are given in table 8.2.2.6.2.4.2.1-1, 8.2.2.6.2.4.2.1-2 and 8.2.2.6.2.4.2.1-3.The test consists of two successive time periods,with time duration of T1 and T2 respectively. At T1 the UE is camped on to cell1. Cell2 is of lower priority than cell1.

**Table 8.2.2.6.2.4.2.1-1: General test parameters for UTRAN (1.28 Mcps TDD OPTION) to E-UTRAN TDD Cell Re-selection**

Parameter		Unit	Value	Comment
Initial condition	Active cell		Cell 2	UE shall be forced to cell 2 in the initialisation phase, so that reselection to cell 1 occurs during the first T1 phase
T1 end condition	Active cell		Cell1	UE shall perform reselection to cell 1 during T1
	Neighbour cell		Cell2	E-UTRA TDD cell
T2 end condition	Active cell		Cell2	UE shall perform reselection to cell 2 during T2
	Neighbour cell		Cell1	UTRA 1.28 Mcps TDD OPTION cell
Uplink-downlink configuration of cell 2			1	As specified in table 4.2.2 in TS 36.211
Special subframe configuration of cell 2			6	As specified in table 4.2.1 in TS 36.211
PRACH configuration of cell 2			53	As specified in table 4.7.1-3 in TS 36.211
CP length of cell 2			Normal	
Time offset between cells			3 ms	Asynchronous cells
Access Barring Information		-	Not sent	No additional delays in random access procedure.
Treselection		s	0	
DRX cycle length		s	1,28	
HCS			Not used	
T1		s	85	T1 need to be defined so that cell re-selection reaction time is taken into account.
T2		s	25	

**Table 8.2.2.6.2.4.2.1-2: Cell specific test parameters for cell re-selection UTRA TDD to E-UTRA TDD test case (cell 1)**

Parameter	Unit	Cell 1 (UTRA)			
		0		DwPTS	
Timeslot Number		T1	T2	T1	T2
UTRA RF Channel Number (Note1)		Channel 1			
PCCPCH_Ec/lor	dB	-3	-3		
DwPCH_Ec/lor	dB			0	0
OCNS_Ec/lor	dB	-3	-3		
$I_{oc} / I_{oc}$	dB	11	-3	11	-3
$I_{oc}$	dBm/1.28 MHz	-80			
PCCPCH RSCP	dBm	-72	-86	n.a.	n.a.
Propagation Condition		AWGN			
Qrxlevmin	dBm	-103			
Qoffset1s,n	dB	C1, C2: 0			
Qhyst1s	dB	0			
Snointrasearch	dB	Not sent			
Threshserving, low	dB	24 (-79dBm)			
Threshx, low (Note2)	dB	46 (-94dBm)			
Note1: In the case of multi-frequency cell, the UTRA RF Channel Number is the primary frequency's channel number. Note2: This refers to the value of Threshx, low which is included in UTRA system information, and is a threshold for the E-UTRA target cell					

**Table 8.2.2.6.2.4.2.1-3: Cell specific test parameters for cell re-selection UTRA TDD to E-UTRA TDD test case (cell 2)**

Parameter	Unit	Cell 2	
		T1	T2
E-UTRA RF Channel Number		2	
BWchannel	MHz	10	
PBCH_RA	dB	0	0
PBCH_RB	dB		
PSS_RB	dB		
SSS_RB	dB		
PCFICH_PA	dB		
PHICH_PA	dB		
PHICH_PB	dB		
PDCCH_PA	dB		
PDCCH_PB	dB		
PDSCH_PA	dB		
PDSCH_PB	dB		
OCNG_RANote1	dB		
OCNG_RBNote1	dB		
Qrxlevmin	dBm/15kHz		
$N_{oc}$	dBm/15kHz	-98	
RSRP	dBm/15kHz	-87	-87
$E_s / I_{oc}$	dB	11	11
Threshx, high (Note2)	dB	24(-79dBm)	
Propagation Condition		AWGN	
Note1: OCNG shall be used such that cell is fully allocated and a constant total transmitted power spectral density is achieved for all OFDM symbols. Note2: This refers to the value of Threshx, high which is included in E-UTRA system information, and is a threshold for the UTRA target cell			

#### 8.2.2.6.2.4.2.2 Procedure

- a) The SS activates cell1 and cell2 with T2 defined parameters and monitors cell1 and 2 for RRC CONNECTION REQUEST messages from the UE,
- b) The UE is switched on,
- c) The SS waits until the UE camps on cell2 and sends the RRC CONNECTION REQUEST message.
- d) After 25s, the parameters are changed as described for T1.
- e) The SS waits for RRC CONNECTION REQUEST message from the UE.
- f) After 85s, the parameters are changed as described for T2.
- g) The SS waits for RRC CONNECTION REQUEST message from the UE.
- h) Repeat steps d) to h) [TBD]times.

#### 8.2.2.6.2.4.3 7.68Mcps Option

#### 8.2.2.6.2.5 Test requirement

##### 8.2.2.6.2.5.1 3.84Mcps Option

##### 8.2.2.6.2.5.2 1.28Mcps Option

- 1) In step c), after UE has responded on cell 2, it shall not respond to any other cell( cell selection).
- 2) In step e), the UE shall respond on cell 1.
- 3) In step g), the UE shall respond on cell 2 within 21s.

For the test to pass, the total number of fulfilled test requirement in step 3) shall be at least 90% of the cases,

NOTE: If the above Test Requirement differs from the Minimum Requirement then the Test Tolerance applied for this test is non-zero. The Test Tolerance for this test is defined in clause F.2 and the explanation of how the Minimum Requirement has been relaxed by the Test Tolerance is given in clause F.4.

##### 8.2.2.6.2.5.3 7.68Mcps Option

### 8.2.2.7 Scenario 6: Inter-band Cell Re-selection for 1.28 Mcps TDD UE

#### 8.2.2.7.1 Definition and applicability

The cell re-selection delay is defined as the time from a change of cell parameters to the moment when the UE camps on a new cell, and starts to send SYNCH-UL sequence in the UpPTS for sending the RRC CONNECTION REQUEST to perform a Location Registration on the new cell.

The requirements and this test apply to all types of 1.28 Mcps TDD UE.

#### 8.2.2.7.2 Minimum requirement

The cell re-selection delay shall be less than 8 s.

#### 8.2.2.7.3 Test purpose

This test is to verify the requirement for the cell re-selection delay in the cross frequency band case.

#### 8.2.2.7.4 Method of test

##### 8.2.2.7.4.1 Initial conditions

Test environment: normal; see clauses G.2.1 and G.2.2.

Frequencies to be tested: mid range; see clause G.2.4.

Cell condition:

There are six cells. Two frequency points are in frequency band a and frequency band b respectively. (The cells are two service cells and four background cells. The service cells use different frequencies. Every two background cells use the same frequency.)

Signal propagation condition: AWGN

Test instrument: Noise source

**Table 8.2.2.7.4.1-1 General test parameters for inter-frequency cell re-selection**

Parameter		Unit	Value	Remarks
Initial conditions	Active cell		Cell1	
	Neighbour cell		Cell2, Cell3, Cell4, Cell5, Cell6	
Final condition	Active cell		Cell2	
HCS			Not used	
UE_TXPWR_MAX_RACH		dBm	21	
Qrxlevmin		dBm	-103	
Access Service Class (ASC#0) - Persistence value			1	
TSI		s	1.28	
DRX cycle length		s	1.28	
T1		s	30	
T2		s	15	

**Table 8.2.2.7.4.1-2 Cell settings for inter-frequency cell re-selection**

Parameter	Unit	Cell 1				Cell 2				Cell 3			
Timeslot		0		DWPTS		0		DWPTS		0		DWPTS	
		T1	T2	T1	T2	T1	T2	T1	T2	T1	T2	T1	T2
UTRA RF Channel Number (Note 1)		Channel 1				Channel 2				Channel 1			
PCCPCH_Ec/lor	dB	-3	-3			-3	-3			-3	-3		
DwPCH_Ec/lor	dB			0	0			0	0			0	0
OCNS_Ec/lor	dB	-3	-3			-3	-3			-3	-3		
$\hat{I}_{or}/I_{oc}$	dB	10	4	10	4	4	10	4	10	-1	-1	-1	-1
PCCPCH RSCP	dBm	-63	-69			-69	-63			-74	-74		
Qoffset1s,n	dB	C1, C2: 0; C1, C3:0; C1, C4:0 C1, C5:0; C1, C6:0				C2, C1: 0; C2, C3:0; C2, C4:0C2, C5:0; C2, C6:0				C3, C1: 0; C3, C2:0; C3, C4:0 C3, C5:0; C3, C6:0			
Qhyst1s	dB	0				0				0			
Treselection	s	0				0				0			
Sintrasearch	dB	not sent				not sent				not sent			
Sintersearch	dB	not sent				not sent				not sent			
		Cell 4				Cell 5				Cell 6			
Timeslot		0		DWPTS		0		DWPTS		0		DWPTS	
		T1	T2	T1	T2	T1	T2	T1	T2	T1	T2	T1	T2
UTRA RF Channel Number (Note 1)		Channel 1				Channel 2				Channel 2			
PCCPCH_Ec/lor	dB	-3	-3			-3	-3			-3	-3		
DwPCH_Ec/lor	dB			0	0			0	0			0	0
OCNS_Ec/lor	dB	-3	-3			-3	-3			-3	-3		
$\hat{I}_{or}/I_{oc}$	dB	-1	-1	-1	-1	-1	-1	-1	-1	-1	-1	-1	-1
PCCPCH RSCP	dBm	-74	-74			-74	-74			-74	-74		
Qoffset1s,n	dB	C4, C1: 0; C4, C2:0; C4, C3:0 C4, C5:0; C4, C6:0				C5, C1: 0; C5, C2:0; C5, C3:0 C5, C4:0; C5, C6:0				C6, C1: 0; C6, C2:0; C6, C3:0 C6, C4:0; C6, C5:0			
Qhyst1s	dB	0				0				0			
Treselection	s	0				0				0			
Sintrasearch	dB	not sent				not sent				not sent			
Sintersearch	dB	not sent				not sent				not sent			
$I_{oc}$	dBm/1.28 MHz	-70											
Propagation Condition		AWGN											
Note 1: Channel 1 is in frequency band a, and channel 2 is in frequency band f.													

NOTE: The cell re-selection delay can be expressed as:  $T_{evaluateNTDD} + T_{SI}$ , where:

To evaluate NTDD: A DRX cycle length of 1280 ms is assumed for this test case, and this leads to a  $T_{evaluateNTDD}$  of 6.4 s according to "Appendix F."

$T_{SI}$ : Time required for receiving all the relevant system information data according to the reception procedure and the RRC procedure delay of system information blocks for a UTRAN cell (ms). 1280 ms is assumed in this test case.

This gives a total of 7.68s, allow 8s in the test case.



#### 8.2.2.7.4.2 Procedure

- 1) The SS activates cells 1–6 with T1 defined parameters and monitors cells 1 and 2 for RRC CONNECTION REQUEST messages from the UE.
- 2) The UE is switched on.
- 3) The SS waits until the UE camps on Cell 1 and sends the RRC CONNECTION REQUEST message.
- 4) After 15 seconds, the SS shall switch the power settings from T1 to T2.
- 5) The SS waits for SYNCH-UL sequence in the UpPTS for sending RRC CONNECTION REQUEST messages from the UE.
- 6) After another 15 seconds, the SS shall switch the power settings as described for T1.
- 7) The SS waits for SYNCH-UL sequence in the UpPTS for sending RRC CONNECTION REQUEST messages from the UE.
- 8) Repeat steps 2 to 7 until the required confidence level is achieved.

NOTE: T1 is initially 30s to allow enough time for the UE to search for cells.

#### 8.2.2.7.5 Test Requirements

The cell re-selection delay shall be less than 8s.

The rate of correct cell reselections observed during repeated tests shall be at least 90% with a confidence level of 95%.

In step 3, after the UE has responded on cell 1, it shall not respond on any other cell.

In step 5, the UE shall respond on cell 2 within eight seconds.

In step 7, the UE shall respond on cell 1 within eight seconds.

## 8.3 UTRAN Connected Mode Mobility

### 8.3.1 TDD/TDD Handover for 3,84 Mcps Option

#### 8.3.1.1 Handover to intra-frequency cell

##### 8.3.1.1.1 Definition and applicability

Handover interruption time is defined as the time between the end of the last TTI containing a transport block on the old DPCH and the time the UE starts transmission of the new uplink DPCH.

The requirements and this test apply to the UTRA TDD UE.

##### 8.3.1.1.2 Minimum requirement

The interruption time shall be less than 40 ms in the single carrier case when the cell is known by the UE and the SFN of the target cell does not need to be decoded. The rate of correct handovers observed during repeated tests shall be at least 90% with a confidence level of [FFS]%.

The interruption time is dependent on whether the target cell is known for the UE or not.

If TDD/TDD intra-frequency handover is commanded, the interruption time shall be less than,

$$T_{\text{interrupt}} = T_{\text{offset}} + T_{\text{UL}} + 30 * F_{\text{SFN}} + 20 * KC + 180 * UC \text{ ms}$$

where,

$T_{\text{offset}}$  Equal to 10 ms, the frame timing uncertainty between the old cell and the target cell and the time that can elapse until the appearance of a Beacon channel

$T_{\text{UL}}$  Equal to 10 ms, the time that can elapse until the appearance of the UL timeslot in the target cell

$F_{SFN}$	Equal to 1 if SFN decoding is required and equal to 0 otherwise
KC	Equal to 1 if a known target cell is indicated in the RRC message implying TDD/TDD handover and equal to 0 otherwise
UC	Equal to 1 if an unknown target cell is indicated in the RRC message implying TDD/TDD handover and equal to 0 otherwise

An intra-frequency TDD target cell shall be considered as known by the UE, if either or both of the following conditions are true:

- the target cell has been measured during the last 5 seconds
- the UE has had a radio link connected to the target cell during the last 5 seconds.

The interruption time requirements for an unknown target cell shall apply only if the signal quality of the unknown target cell is sufficient for successful synchronisation with one attempt.

The normative reference for this requirement is TS 25.123 [2] clauses 5.1.2 and A.5.1.1.

### 8.3.1.1.3 Test purpose

The purpose of this test is to verify the requirement for the intra-frequency handover delay in CELL\_DCH state in the single carrier case.

### 8.3.1.1.4 Method of test

#### 8.3.1.1.4.1 Initial conditions

Test environment: normal; see clauses G.2.1 and G.2.2.

Frequencies to be tested: mid range; see clause G.2.4.

The test parameters are given in table 8.3.1.1.1 and 8.3.1.1.2. In the measurement control information it is indicated to the UE that event-triggered reporting with Event 1G shall be used, and that P-CCPCH RSCP and SFN-CFN observed timed difference shall be reported together with Event 1G. The test consists of three successive time periods, with a time duration of T1, T2 and T3 respectively. At the start of time duration T1, the UE may not have any timing information of cell 2.

UTRAN shall send a Physical Channel reconfiguration message with activation time at the beginning of T3 with a new active cell, cell 2. The Physical Channel reconfiguration message shall be sent to the UE such that the delay between the end of the last received TTI containing the message and the beginning of T3 is at least equal to the RRC procedure delay as defined in [16].

The second Beacon timeslot shall be provided in timeslot 8 for both cell 1 and cell 2. The UL DPCH shall be transmitted in timeslot 12.

**Table 8.3.1.1.1: General test parameters for Handover to intra-frequency cell**

Parameter		Unit	Value	Comment
DCH parameters			DL Reference Measurement Channel 12.2 kbps	As specified in TS 25.102 clause A.2.2
Power Control			On	
Target quality value on DTCH		BLER	0.01	
Initial conditions	Active cell		Cell 1	
	Neighbour cell		Cell 2	
Final condition	Active cell		Cell 2	
HCS			Not used	
O		dB	0	Cell individual offset. This value shall be used for all cells in the test.
Hysteresis		dB	0	
Time to Trigger		ms	0	
Filter coefficient			0	
Monitored cell list size			6 TDD neighbours on Channel 1	
T1		s	10	
T2		s	10	
T3		s	10	

**Table 8.3.1.1.2: Cell specific test parameters for Handover to intra-frequency cell**

Parameter	Unit	Cell 1						Cell 2					
		0			4			0			5		
DL timeslot number		T1	T2	T3	T1	T2	T3	T1	T2	T3	T1	T2	T3
UTRA RF Channel Number		Channel 1						Channel 1					
PCCPCH_Ec/I <sub>or</sub>	dB	-3			n.a.			-3			n.a.		
SCH_Ec/I <sub>or</sub>	dB	-9			n.a.			-9			n.a.		
SCH_t <sub>offset</sub>	dB	0			n.a.			5			n.a.		
DPCH_Ec/I <sub>or</sub>	dB	n.a.			Note 1		n.a.	n.a.			n.a.		Note 1
OCNS_Ec/I <sub>or</sub>	dB	-3,12			Note 2		n.a.	n.a.	-3,12		n.a.		Note 2
$\hat{I}_{or}/I_{oc}$	dB	1						-Inf.	3		-Inf.	3	
PCCPCH RSCP	dBm	-72			n.a.			-Inf.	-70		n.a.		
I <sub>oc</sub>	dBm/3, 84 MHz	-70											
Propagation Condition		AWGN											

Note 1: The DPCH level is controlled by the power control loop  
Note 2: The power of the OCNS channel that is added shall make the total power from the cell to be equal to I<sub>or</sub>.

#### 8.3.1.1.4.2 Procedure

- 1) The RF parameters are set up according to T1.
- 2) The UE is switched on.
- 3) A call is set up according to the test procedure specified in TS 34.108 [3] subclause 7.3.4.

[Editor's note: subclause 7.3.4 in TS 34.108 (Message sequence chart for Handover Test procedure) is not yet specified]

- 4) SS shall transmit a MEASUREMENT CONTROL message.
- 5) After 10 seconds, the SS shall switch the power settings from T1 to T2.
- 6) UE shall transmit a MEASUREMENT REPORT message triggered by event 1G.
- 7) SS shall transmit a PHYSICAL CHANNEL RECONFIGURATION message with activation time at T3.
- 8) After 10 seconds, the SS shall switch the power settings from T2 to T3

- 9) UE shall transmit a PHYSICAL CHANNEL RECONFIGURATION COMPLETE message on the UL DCCH of cell 2. If the UE transmits the UL DPCH to cell 2 less than 40 ms from the beginning of time period T3 then the number of successful tests is increased by one.
- 10) After 10 seconds, the UE is switched off. Any timing information of cell 2 is deleted in the UE.
- 11) Repeat step 1-10 [TBD] times.

#### Specific Message Contents

All messages indicated above shall use the same content as described in the default message content in clause 9 of 34.108 [3] with the following exceptions:

MEASUREMENT CONTROL message (step 4):

Information Element/Group name	Value/Remark
Message Type (10.2.17)	
<b>UE information elements</b>	
-RRC transaction identifier	0
-Integrity check info	Not Present
<b>Measurement Information elements</b>	
-Measurement Identity	1
-Measurement Command (10.3.7.46)	Modify
-Measurement Reporting Mode (10.3.7.49)	AM RLC
-Periodical Reporting / Event Trigger Reporting Mode	Event trigger
-Additional measurements list (10.3.7.1)	Not Present
-CHOICE <i>Measurement type</i>	Intra-frequency measurement
-Intra-frequency measurement (10.3.7.36)	Not Present
-Intra-frequency measurement objects list (10.3.7.33)	Not Present
-Intra-frequency measurement quantity (10.3.7.38)	0
-Filter coefficient (10.3.7.9)	TDD
-CHOICE <i>mode</i>	1
-Measurement quantity list	
-Measurement quantity	Primary CCPCH
-Intra-frequency reporting quantity (10.3.7.41)	
-Reporting quantities for active set cells (10.3.7.5)	No report
-SFN-SFN observed time difference reporting indicator	TRUE (Note 1)
-Cell synchronisation information reporting indicator	TRUE
-Cell Identity reporting indicator	TDD
-CHOICE <i>mode</i>	FALSE
-Timeslot ISCP reporting indicator	TRUE
-Primary CCPCH RSCP reporting indicator	TRUE
-Pathloss reporting indicator	FALSE
-Reporting quantities for monitored set cells (10.3.7.5)	No report
-SFN-SFN observed time difference reporting indicator	TRUE (Note 1)
-Cell synchronisation information reporting indicator	TRUE
-Cell Identity reporting indicator	TDD
-CHOICE <i>mode</i>	FALSE
-Timeslot ISCP reporting indicator	FALSE
-Proposed TGSN reporting required	FALSE
-Primary CCPCH RSCP reporting indicator	TRUE
-Pathloss reporting indicator	FALSE
-Reporting quantities for detected set cells (10.3.7.5)	Not Present
-Reporting cell status (10.3.7.61)	
-CHOICE <i>reported cell</i>	Report all active set cells + cells within monitored set on used frequency
-Maximum number of reported cells	2
-Measurement validity (10.3.7.51)	Not Present
-CHOICE <i>report criteria</i>	Intra-frequency measurement reporting criteria
-Intra-frequency measurement reporting criteria (10.3.7.39)	
-Parameters required for each event	1
-Intra-frequency event identity	Event 1G
-Triggering condition 2	Not Present
-Reporting Range Constant	Not Present
-Cells forbidden to affect Reporting Range	Not Present
-W	Not Present
-Hysteresis	0 dB
-Threshold used frequency	Not Present
-Reporting deactivation threshold	Not Present
-Replacement activation threshold	Not Present
-Time to trigger	0 ms
-Amount of reporting	Infinity
-Reporting interval	0 ms (Note 2)
-Reporting cell status	Not Present
<b>Physical channel information elements</b>	
-DPCH compressed mode status info (10.3.6.34)	Not Present

Information Element/Group name	Value/Remark
Note 1:	The SFN-CFN observed time difference is calculated from the OFF and Tm parameters contained in the IE "Cell synchronisation information", TS 25.331, clause 10.3.7.6. According to TS 25.331, 8.6.7.7, this IE is included in MEASUREMENT REPORT if IE "Cell synchronisation information reporting indicator" in IE "Cell reporting quantities" TS 25.331, clause 10.3.7.5 is set to TRUE in MEASUREMENT CONTROL.
Note 2:	Reporting interval = 0 ms means no periodical reporting

PHYSICAL CHANNEL RECONFIGURATION message (step 7):

Information Element	Value/Remark
Message Type	
<b>UE Information Elements</b>	
-RRC transaction identifier	0
-Integrity check info	Not Present
-Integrity protection mode info	Not Present
-Ciphering mode info	Not Present
-Activation time	At T3
-New U-RNTI	Not Present
-New C-RNTI	Not Present
-RRC State Indicator	CELL_DCH
-UTRAN DRX cycle length coefficient	Not Present
<b>CN Information Elements</b>	
-CN Information info	Not Present
<b>UTRAN mobility information elements</b>	
-URA identity	Not Present
<b>RB information elements</b>	
-Downlink counter synchronisation info	Not Present
-RB with PDCP information list	Not Present
-RB with PDCP information	Not Present
<b>PhyCH information elements</b>	
-Frequency info (10.3.6.36)	TDD
-CHOICE <i>mode</i>	Same UARFCN as used for cell 2
-UARFCN (Nt)	
<b>Uplink radio resources</b>	
-Maximum allowed UL TX power	33 dBm
-CHOICE <i>channel requirement</i>	Uplink DPCH info
-Uplink DPCH info (10.3.6.88)	
-Uplink DPCH power control info (10.3.6.91)	
-CHOICE <i>mode</i>	TDD
-CHOICE <i>TDD option</i>	3,84 Mcps TDD
-UL Target SIR	Not Present
-CHOICE <i>UL OL PC info</i>	Individually signalled
-CHOICE <i>TDD option</i>	3,84 Mcps TDD
-Individual Timeslot interference info	1
-Individual timeslot interference (10.3.6.38)	
-Timeslot Number (10.3.6.84)	
-CHOICE <i>TDD option</i>	3,84 Mcps TDD
-Timeslot number	12
-UL Timeslot Interference	-90 dBm
-CHOICE <i>mode</i>	TDD
-Uplink timing advance control (10.3.6.96)	
-CHOICE <i>Timing Advance</i>	Disabled
-UL CCTrCH list	1
-UL Target SIR	TBD dB
-Time Info (10.3.6.83)	
-Activation Time	T3
-Duration	Infinite
-Common timeslot info	Not Present
-Uplink DPCH timeslots and codes (10.3.6.94)	
-Dynamic SF Usage	False
-First individual timeslot info (10.3.6.37)	
-Timeslot Number (10.3.6.84)	
-CHOICE <i>TDD option</i>	3,84 Mcps
-Timeslot number	12
-TFCl existence	True
-Midamble shift and burst type (10.3.6.41)	
-Choice <i>TDD option</i>	3,84 Mcps
-Choice Burst Type	Type 1
-Midamble Allocation Mode	Default
-Midamble configuration burst type 1 and 3	16
-Midamble shift	Not present
-CHOICE <i>TDD option</i>	3,84 Mcps
-First timeslot code list	1
-Channelisation code	8/1
-Choice more timeslots	No more timeslots

Information Element	Value/Remark
<b>Downlink radio resources</b>	
-CHOICE <i>mode</i>	TDD
-Downlink information common for all radio links (10.3.6.24)	
-Downlink DPCH info common for all RL (10.3.6.18)	
-Timing indicator	Initialise
-CFN-targetSFN frame offset	Not Present
-Downlink DPCH power control information (10.3.6.23)	
-CHOICE <i>mode</i>	TDD
-TPC Step size	1 dB
-CHOICE <i>mode</i>	TDD
-CHOICE <i>mode</i>	TDD
-CHOICE <i>TDD option</i>	3,84 Mcps
-TX Diversity mode (10.3.6.86)	None
-Default DPCH Offset Value (10.3.6.16)	0
-Downlink information per radio link list	1
-Downlink information for each radio link (10.3.6.27)	
-CHOICE <i>mode</i>	TDD
-Primary CCPCH info (10.3.6.57)	
-CHOICE <i>mode</i>	TDD
-CHOICE <i>TDD option</i>	3,84 Mcps
-CHOICE <i>sync case</i>	Case 2
-Timeslot	0
-Cell parameters ID	20
-SCTD indicator	False
-Downlink DPCH info for each RL (10.3.6.21)	
-CHOICE <i>mode</i>	TDD
-DL CCTrCH list	1
-TFCS ID	Not Present
-Time Info (10.3.6.83)	
-Activation Time	T3
-Duration	Infinite
-Common timeslot info	Not Present
-Downlink DPCH timeslots and codes (10.3.6.32)	
-First individual timeslot info (10.3.6.37)	
-Timeslot Number (10.3.6.84)	
-CHOICE <i>TDD option</i>	3,84 Mcps
-Timeslot number	5
-TFCI existence	True
-Midamble shift and burst type (10.3.6.41)	
-CHOICE <i>TDD option</i>	3,84 Mcps
-CHOICE <i>Burst Type</i>	Type 1
-Midamble Allocation Mode	Default
-Midamble configuration burst type 1 and 3	16
-Midamble shift	Not present
-CHOICE <i>TDD option</i>	3,84 Mcps
-First timeslot channelisation codes (10.3.6.17)	
-CHOICE <i>codes representation</i>	Consecutive codes
-First channelisation code	16/1
-Last channelisation code	16/2
-CHOICE <i>more timeslots</i>	No more timeslots
-SCCPCH information for FACH (10.3.6.70)	Not Present



## MEASUREMENT REPORT message (step 6)

Information Element	Value/remark
Message Type (10.2.17)	
Integrity check info	Not Present
Measurement identity	1
Measured Results (10.3.7.44)	
-CHOICE Measurement	Intra-frequency Measured results list
-Intra-frequency measured results	1
-Cell measured results (10.3.7.3)	
-Cell identity	Checked that this IE is present
-SFN-SFN observed time difference	Not Present
-Cell synchronisation info	Checked that this IE is present
-CHOICE mode	TDD
-Cell parameters ID	20
-Proposed TGSN	Not Present
-Primary CCPCH RSCP	Checked that this IE is present
-Pathloss	Not Present
-Timeslot list	Not Present
Measured results on RACH	Not Present
Additional measured results	Not Present
Event results (10.3.7.7)	
-CHOICE event result	Intra-frequency measurement event results
-Intra-frequency event identity	1G
-Cell measurement event results (10.3.7.4)	
-CHOICE mode	TDD
-Primary CCPCH info (10.3.6.57)	
-CHOICE mode	TDD
-Cell parameters ID	40

## 8.3.1.1.5 Test requirements

For the test to pass, the total number of successful tests shall be more than 90% with a confidence level of [FFS]% of the cases.

Note: If the above Test Requirement differs from the Minimum Requirement then the Test Tolerance applied for this test is non-zero. The Test Tolerance for this test is defined in clause F.2 and the explanation of how the Minimum Requirement has been relaxed by the Test Tolerance is given in clause F.4.

## 8.3.1.2 Handover to inter-frequency cell

## 8.3.1.2.1 Definition and applicability

The handover interruption time is defined as the time between the end of the last TTI containing a transport block on the old DPCH and the time the UE starts transmission of the new uplink DPCH.

The requirements and this test apply to the UTRA TDD UE.

## 8.3.1.2.2 Minimum requirement

The interruption time shall be less than 40 ms in the dual carrier case when the cell is known by the UE and the SFN of the target cell needs to be decoded. The rate of correct handovers observed during repeated tests shall be at least 90% with a confidence level of [FFS]%.

The interruption time is dependent on whether the target cell is known for the UE or not.

If TDD/TDD inter-frequency handover is commanded, the interruption time shall be less than,

$$T_{\text{interrupt}} = T_{\text{offset}} + T_{\text{UL}} + 30 * F_{\text{SFN}} + 20 * KC + 180 * UC \text{ ms}$$

where,

$T_{\text{offset}}$  Equal to 10 ms, the frame timing uncertainty between the old cell and the target cell and the time that can elapse until the appearance of a Beacon channel

$T_{UL}$	Equal to 10 ms, the time that can elapse until the appearance of the UL timeslot in the target cell
$F_{SFN}$	Equal to 1 if SFN decoding is required and equal to 0 otherwise
KC	Equal to 1 if a known target cell is indicated in the RRC message implying TDD/TDD handover and equal to 0 otherwise
UC	Equal to 1 if an unknown target cell is indicated in the RRC message implying TDD/TDD handover and equal to 0 otherwise

An inter-frequency TDD target cell shall be considered as known by the UE, if either or both of the following conditions are true:

- the target cell has been measured during the last 5 seconds
- the UE has had a radio link connected to the target cell during the last 5 seconds.

The interruption time requirements for an unknown target cell shall apply only if the signal quality of the unknown target cell is sufficient for successful synchronisation with one attempt.

The normative reference for this requirement is TS 25.123 [2] clauses 5.1.2 and A.5.1.2.

#### 8.3.1.2.3 Test purpose

The purpose of this test is to verify the requirement for the inter-frequency handover delay in CELL\_DCH state in the dual carrier case.

#### 8.3.1.2.4 Method of test

##### 8.3.1.2.4.1 Initial conditions

Test environment: normal; see clauses G.2.1 and G.2.2.

Frequencies to be tested: mid range; see clause G.2.4.

The test parameters are given in table 8.3.1.2.1 and 8.3.1.2.2. In the measurement control information it is indicated to the UE that event-triggered reporting with Event 2C shall be used. The PCCPCH RSCP and SFN-CFN observed time difference of the best cell on the unused frequency shall be reported together with Event 2C reporting. At the start of time duration T1, the UE may not have any timing information of cell 2.

UTRAN shall send a Physical Channel reconfiguration message with activation time at beginning of T3 with one active cell, cell 2. The Physical Channel reconfiguration message shall be sent to the UE such that the delay between the end of the last received TTI containing the message and the beginning of T3 is at least equal to the RRC procedure delay as defined in [16].

The second Beacon timeslot shall be provided in timeslot 8 for cell 1 and in timeslot 10 for cell 2. The UL DPCH shall be transmitted in timeslot 12.

Table 8.3.1.2.1: General test parameters for Handover to inter-frequency cell

Parameter		Unit	Value	Comment
DCH parameters			DL Reference Measurement Channel 12.2 kbps	As specified in TS 25.102 clause A.2.2
Power Control			On	
Target quality value on DTCH		BLER	0.01	
Initial conditions	Active cell		Cell 1	
	Neighbour cell		Cell 2	
Final condition	Active cell		Cell 2	
HCS			Not used	
O		dB	0	Cell individual offset. This value shall be used for all cells in the test.
Hysteresis		dB	0	Hysteresis parameter for event 2C
Time to Trigger		ms	0	
Threshold non-used frequency		dBm	-80	Applicable for Event 2C
Filter coefficient			0	
Monitored cell list size			6 TDD neighbours on Channel 1 6 TDD neighbours on Channel 2	
T <sub>SI</sub>		s	1,28	The value shall be used for all cells in the test.
T1		s	10	
T2		s	10	
T3		s	10	

Table 8.3.1.2.2: Cell Specific parameters for Handover to inter-frequency cell

Parameter	Unit	Cell 1						Cell 2					
		0			4			2			5		
DL timeslot number		T1	T2	T3	T1	T2	T3	T1	T2	T3	T1	T2	T3
UTRA RF Channel Number		Channel 1						Channel 2					
PCCPCH_Ec/lor	dB	-3			n.a.			-3			n.a.		
SCH_Ec/lor	dB	-9			n.a.			-9			n.a.		
SCH_offset	dB	0			n.a.			5			n.a.		
DPCH_Ec/lor	dB	n.a.			Note 1		n.a.	n.a.			n.a.		Note 1
OCNS_Ec/lor	dB	-3,12			Note 2		n.a.	n.a.	-3,12		n.a.		Note 2
$\hat{I}_{or}/I_{oc}$	dB	1						-Inf.	7		-Inf.	7	
PCCPCH RSCP	dBm	-72			n.a.			-Inf.	-66		n.a.		
$I_{oc}$	dBm/3, 84 MHz	-70											
Propagation Condition		AWGN											
Note 1: The DPCH level is controlled by the power control loop													
Note 2: The power of the OCNS channel that is added shall make the total power from the cell to be equal to lor .													

## 8.3.1.2.4.2 Procedure

- 1) The RF parameters are set up according to T1.
- 2) The UE is switched on.
- 3) A call is set up according to the test procedure specified in TS 34.108 [3] subclause 7.3.4.

[Editor's note: subclause 7.3.4 in TS 34.108 (Message sequence chart for Handover Test procedure) is not yet specified]

- 4) SS shall transmit a MEASUREMENT CONTROL message.
- 5) After 10 seconds, the SS shall switch the power settings from T1 to T2.

- 6) UE shall transmit a MEASUREMENT REPORT message triggered by event 2C.
- 7) SS shall transmit a PHYSICAL CHANNEL RECONFIGURATION message with activation time at T3.
- 8) After 10 seconds, the SS shall switch the power settings from T2 to T3
- 9) UE shall transmit a PHYSICAL CHANNEL RECONFIGURATION COMPLETE message on the UL DCCH of cell 2. If the UE transmits the UL DPCH to cell 2 less than 40 ms from the beginning of time period T3 then the number of successful tests is increased by one.
- 10) After 10 seconds, the UE is switched off. Any timing information of cell 2 is deleted in the UE.
- 11) Repeat step 1-10 [TBD] times.

#### Specific Message Contents

All messages indicated above shall use the same content as described in the default message content in clause 9 of 34.108 [3] and in Annex A of 34.123-1 [21], with the following exceptions:

MEASUREMENT CONTROL message, event 2C (step 4):

Information Element/Group name	Value/Remark
Message Type (10.2.17)	
<b>UE information elements</b>	
-RRC transaction identifier	0
-Integrity check info	Not Present
<b>Measurement Information elements</b>	
-Measurement Identity	1
-Measurement Command (10.3.7.46)	Modify
-Measurement Reporting Mode (10.3.7.49)	AM RLC
-Periodical Reporting / Event Trigger Reporting Mode	Event trigger
-Additional measurements list (10.3.7.1)	Not Present
-CHOICE <i>Measurement type</i>	Inter-frequency measurement
-Inter-frequency measurement (10.3.7.16)	Not Present
-Inter-frequency measurement objects list (10.3.7.13)	Not Present
-Inter-frequency measurement quantity (10.3.7.18)	Inter-frequency reporting criteria
-CHOICE <i>reporting criteria</i>	Inter-frequency reporting criteria
-Inter-frequency reporting criteria	0
-Filter coefficient	TDD
-CHOICE <i>mode</i>	Primary CCPCH RSCP
-Measurement quantity for frequency quality estimate	Primary CCPCH RSCP
-Inter-frequency reporting quantity (10.3.7.21)	FALSE
-UTRA Carrier RSSI	FALSE
-Frequency quality estimate	FALSE
-Non frequency related cell reporting quantities (10.3.7.5)	No Report
-SFN-SFN observed time difference reporting indicator	TRUE
-Cell synchronisation information reporting indicator	TRUE
-Cell Identity reporting indicator	TDD
-CHOICE <i>mode</i>	FALSE
-Timeslot ISCP reporting indicator	FALSE
-Proposed TGSN reporting required	FALSE
-Primary CCPCH RSCP reporting indicator	TRUE
-Pathloss reporting indicator	FALSE
-Reporting cell status (10.3.7.61)	Report cells within monitored set on non-used frequency
-CHOICE <i>reported cell</i>	1
-Maximum number of reported cells per reported non-used frequency	1
-Measurement validity (10.3.7.51)	Not Present
-Inter-frequency set update (10.3.7.22)	Not Present
-CHOICE <i>report criteria</i>	Inter-frequency measurement reporting criteria
-Inter-frequency measurement reporting criteria (10.3.7.19)	Inter-frequency measurement reporting criteria
-Parameters required for each event	1
-Inter-frequency event identity (10.3.7.14)	Event 2C
-Threshold used frequency	Not Present
-W used frequency	Not Present
-Hysteresis	0 dB
-Time to trigger	0 ms
-Reporting cell status (10.3.7.61)	Report cells within monitored set on non-used frequency
-CHOICE <i>reported cell</i>	Report cells within monitored set on non-used frequency
-Maximum number of reported cells per reported non-used frequency	1
-Parameters required for each non-used frequency	1
-Threshold non-used frequency	-80 dBm
-W non-used frequency	1
<b>Physical channel information elements</b>	
-DPCH compressed mode status info (10.3.6.34)	Not Present

PHYSICAL CHANNEL RECONFIGURATION message (step 7):

Information Element	Value/Remark
Message Type	
<b>UE Information Elements</b>	
-RRC transaction identifier	0
-Integrity check info	Not Present
-Integrity protection mode info	Not Present
-Ciphering mode info	Not Present
-Activation time	At T3
-New U-RNTI	Not Present
-New C-RNTI	Not Present
-RRC State Indicator	CELL_DCH
-UTRAN DRX cycle length coefficient	Not Present
<b>CN Information Elements</b>	
-CN Information info	Not Present
<b>UTRAN mobility information elements</b>	
-URA identity	Not Present
<b>RB information elements</b>	
-Downlink counter synchronisation info	Not Present
-RB with PDCP information list	Not Present
-RB with PDCP information	Not Present
<b>PhyCH information elements</b>	
-Frequency info (10.3.6.36)	TDD
-CHOICE <i>mode</i>	Same UARFCN as used for cell 2
-UARFCN (Nt)	
<b>Uplink radio resources</b>	
-Maximum allowed UL TX power	33 dBm
-CHOICE <i>channel requirement</i>	Uplink DPCH info
-Uplink DPCH info (10.3.6.88)	
-Uplink DPCH power control info (10.3.6.91)	
-CHOICE <i>mode</i>	TDD
-CHOICE <i>TDD option</i>	3,84 Mcps TDD
-UL Target SIR	Not Present
-CHOICE <i>UL OL PC info</i>	Individually signalled
-CHOICE <i>TDD option</i>	3,84 Mcps TDD
-Individual Timeslot interference info	1
-Individual timeslot interference (10.3.6.38)	
-Timeslot Number (10.3.6.84)	
-CHOICE <i>TDD option</i>	3,84 Mcps TDD
-Timeslot number	12
- UL Timeslot Interference	-90 dBm
-CHOICE <i>mode</i>	TDD
-Uplink timing advance control (10.3.6.96)	
-CHOICE <i>Timing Advance</i>	Disabled
-UL CCTrCH list	1
-UL Target SIR	TBD dB
-Time Info (10.3.6.83)	
-Activation Time	T3
-Duration	Infinite
-Common timeslot info	Not Present
-Uplink DPCH timeslots and codes (10.3.6.94)	
-Dynamic SF Usage	False
-First individual timeslot info (10.3.6.37)	
-Timeslot Number (10.3.6.84)	
-CHOICE <i>TDD option</i>	3,84 Mcps
-Timeslot number	12
-TFCl existence	True
-Midamble shift and burst type (10.3.6.41)	
-CHOICE <i>TDD option</i>	3,84 Mcps
-CHOICE <i>Burst Type</i>	Type 1
-Midamble Allocation Mode	Default
-Midamble configuration burst type 1 and 3	16
-Midamble shift	Not present
-CHOICE <i>TDD option</i>	3,84 Mcps
-First timeslot code list	1
-Channelisation code	8/1
-CHOICE <i>more timeslots</i>	No more timeslots

Information Element	Value/Remark
<b>Downlink radio resources</b>	
-CHOICE <i>mode</i>	TDD
-Downlink information common for all radio links (10.3.6.24)	
-Downlink DPCH info common for all RL (10.3.6.18)	
-Timing indicator	Initialise
-CFN-targetSFN frame offset	Not Present
-Downlink DPCH power control information (10.3.6.23)	
-CHOICE <i>mode</i>	TDD
-TPC Step size	1 dB
-CHOICE <i>mode</i>	TDD
-CHOICE <i>mode</i>	TDD
-CHOICE <i>TDD option</i>	3,84 Mcps
-TX Diversity mode (10.3.6.86)	None
-Default DPCH Offset Value (10.3.6.16)	0
-Downlink information per radio link list	1
-Downlink information for each radio link (10.3.6.27)	
-CHOICE <i>mode</i>	TDD
-Primary CCPCH info (10.3.6.57)	
- CHOICE <i>mode</i>	TDD
- CHOICE <i>TDD option</i>	3,84 Mcps
- CHOICE <i>sync case</i>	Case 2
- Timeslot	2
- Cell parameters ID	20
- SCTD indicator	False
-Downlink DPCH info for each RL (10.3.6.21)	
-CHOICE <i>mode</i>	TDD
- DL CCTrCH list	1
-TFCS ID	Not Present
-Time Info (10.3.6.83)	
-Activation Time	T3
-Duration	Infinite
-Common timeslot info	Not Present
- Downlink DPCH timeslots and codes (10.3.6.32)	
- First individual timeslot info (10.3.6.37)	
- Timeslot Number (10.3.6.84)	
- CHOICE <i>TDD option</i>	3,84 Mcps
- Timeslot number	5
- TFCI existence	True
- Midamble shift and burst type (10.3.6.41)	
- CHOICE <i>TDD option</i>	3,84 Mcps
- CHOICE <i>Burst Type</i>	Type 1
- Midamble Allocation Mode	Default
- Midamble configuration burst type 1 and 3	16
- Midamble shift	Not present
- CHOICE <i>TDD option</i>	3,84 Mcps
- First timeslot channelisation codes (10.3.6.17)	
- CHOICE <i>codes representation</i>	Consecutive codes
- First channelisation code	16/1
- Last channelisation code	16/2
- CHOICE <i>more timeslots</i>	No more timeslots
- SCCPCH information for FACH (10.3.6.70)	Not Present

## MEASUREMENT REPORT message (step 6)

Information Element	Value/remark
Message Type (10.2.17)	
Integrity check info	Not Present
Measurement identity	1
Measured Results (10.3.7.44)	
-CHOICE Measurement	Inter-frequency Measured results list
-Inter-frequency measured results	1
-Frequency info	
-CHOICE mode	TDD
-UARFCN(Nt)	Same frequency as channel 2 in Table 8.6.2.4.1.2
-UTRA carrier RSSI	Not Present
-Inter-frequency cell measured results	1
-Cell measured results (10.3.7.3)	
-Cell identity	Checked that this IE is present
-SFN-SFN observed time difference	Not Present
-Cell synchronisation info	Checked that this IE is present
-CHOICE mode	TDD
-Cell parameters ID	Set to cell parameters ID of Cell 2
-Proposed TGSN	Not Present
-Primary CCPCH RSCP	Checked that this IE is present
-Pathloss	Not Present
-Timeslot list	Not Present
Measured results on RACH	Not Present
Additional measured results	Not Present
Event results (10.3.7.7)	
-CHOICE event result	Inter-frequency measurement event results
-Inter-frequency event identity	2C
-Inter-frequency cells	1
-Frequency Info	
-CHOICE mode	TDD
-UARFCN(Nt)	Same frequency as channel 2 in Table 8.6.2.4.1.2
-CHOICE mode	TDD
-Primary CCPCH Info	
-CHOICE mode	TDD
-CHOICE TDD Option	3,84 Mcps TDD
-CHOICE Sync Case	Not Present
-Cell Parameters ID	Set to cell parameters ID of Cell 2
-SCTD Indicator	FALSE

## 8.3.1.2.5 Test requirements

For the test to pass, the total number of successful tests shall be more than 90% with a confidence level of [FFS]% of the cases.

Note: If the above Test Requirement differs from the Minimum Requirement then the Test Tolerance applied for this test is non-zero. The Test Tolerance for this test is defined in clause F.2 and the explanation of how the Minimum Requirement has been relaxed by the Test Tolerance is given in clause F.4.

## 8.3.1A TDD/TDD Handover for 1,28 Mcps Option

## 8.3.1A.1 Handover to intra-frequency cell

## 8.3.1A.1.1 Scenario 1

This test case is applicable for UE handovers in single frequency network and UE handovers from primary frequency to primary frequency in multi-frequency network

## 8.3.1A.1.1.1 Definition and applicability

Handover delay of the UE is defined as the time from the end of the last TTI containing an RRC message implying hard handover to the transmission of the new uplink DPCH or the SYNC-UL in case that a handover with SYNCH uplink exchange is recommended, including the RRC procedure delay as defined in [9].

The requirements and this test apply to the UTRA TDD UE 1,28 Mcps option.



## 8.3.1A.1.1.2 Minimum requirement

The hard handover delay shall be less than 160 ms when the cell is known by the UE and the SFN of the target cell does not need to be decoded. The rate of correct handovers observed during repeated tests shall be at least 90% with a confidence level of 95%.

The normative reference for this requirement is TS 25.123 [2] clauses 5.1.2 and A.5.1.2.

## 8.3.1A.1.1.3 Test purpose

The purpose of this test is to verify the requirement for the intra-frequency handover delay in CELL\_DCH state.

## 8.3.1A.1.1.4 Method of test

## 8.3.1A.1.1.4.1 Initial conditions

Test environment: normal; see clauses G.2.1 and G.2.2.

Frequencies to be tested: mid range; see clause G.2.4.

The test parameters are given in table 8.3.1A.1.1.1 and 8.3.1A.1.1.2. In the measurement control information it is indicated to the UE that event-triggered reporting with Event 1G shall be used, and that P-CCPCH RSCP and SFN-CFN observed timed difference shall be reported together with Event 1G. The test consists of three successive time periods, with a time duration of T1, T2 and T3 respectively. At the start of time duration T1, the UE may not have any timing information of cell 2.

UTRAN shall send a Physical Channel reconfiguration message with activation time "now" with a new active cell, cell 2. The Physical Channel reconfiguration message shall be sent to the UE during period T2, after the UE has reported event 1G. The starting point of T3 is defined as the end of the last TTI containing the physical channel reconfiguration message.

**Table 8.3.1A.1.1.1: General test parameters for Handover to intra-frequency cell**

Parameter	Unit	Value	Comment
DCH parameters		DL and UL Reference Measurement Channel 12.2 kbps	As specified in TS 25.102 clause A.2.2.2 and A.2.1.2
Power Control		On	
Target quality value on DTCH	BLER	0.01	
Initial conditions	Active cell	Cell 1	In the case of multi-frequency network, the UE has a RRC connection on the primary frequency in cell 1.
	Neighbour cell	Cell 2	
Final condition	Active cell	Cell 2	In the case of multi-frequency network, UE will handover to the primary frequency in cell 2.
O	dB	0	Cell individual offset. This value shall be used for all cells in the test.
Hysteresis	dB	0	
Time to Trigger	ms	0	
Filter coefficient		0	
Monitored cell list size		6 TDD neighbours on Channel 1	
T1	s	5	
T2	s	5	
T3	s	5	

Table 8.3.1A.1.1.2: Cell specific test parameters for Handover to intra-frequency cell 1,28Mcps option

Parameter	Unit	Cell 1								
		0			DwPTS			5		
Timeslot Number		T1	T2	T3	T1	T2	T3	T1	T2	T3
UTRA RF Channel Number		Channel 1								
PCCPCH_Ec/I <sub>or</sub>	dB	-3						n.a.		
DwPCH_Ec/I <sub>or</sub>					0					
DPCH_Ec/I <sub>or</sub>	dB	n.a.			n.a.			Note1	n.a.	
OCNS_Ec/I <sub>or</sub>	dB	-3						Note2		
$\hat{I}_{or}/I_{oc}$	dB	3			3			3		
$I_{oc}$	dBm/1, 28 MHz	-70								
PCCPCH_RSCP	dBm	-70			n.a.			n.a.		
Propagation Condition		AWGN								
Parameter	Unit	Cell 2								
Timeslot Number		0			DwPTS			5		
Timeslot Number		T1	T2	T3	T1	T2	T3	T1	T2	T3
UTRA RF Channel Number(NOTE3)		Channel 1								
PCCPCH_Ec/I <sub>or</sub>	dB	-3						n.a.		
DwPCH_Ec/I <sub>or</sub>					0					
DPCH_Ec/I <sub>or</sub>	dB	n.a.			n.a.			n.a.	Note1	
OCNS_Ec/I <sub>or</sub>	dB	-3						Note2		
$\hat{I}_{or}/I_{oc}$	dB	-Inf.	6		-Inf.	6		-Inf.	6	
$I_{oc}$	dBm/1, 28 MHz	-70								
PCCPCH_RSCP	dBm	-Inf.	-67		n.a.			n.a.		
Propagation Condition		AWGN								
Note 1:	The DPCH level is controlled by the power control loop									
Note 2:	The power of the OCNS channel that is added shall make the total power from the cell to be equal to I <sub>or</sub> .									
Note3:	In the case of multi-frequency network, the UTRA RF Channel Number is the primary frequency's channel number.									

## 8.3.1A.1.4.1.2 Procedure

- 1) The RF parameters are set up according to T1.
- 2) The UE is switched on.
- 3) A call is set up according to the test procedure specified in TS 34.108 [3] subclause 7.3.4.
- 4) SS shall transmit a MEASUREMENT CONTROL message.
- 5) After 5 seconds, the SS shall switch the power settings from T1 to T2.
- 6) UE shall transmit a MEASUREMENT REPORT message triggered by event 1G.
- 7) SS shall transmit a PHYSICAL CHANNEL RECONFIGURATION message with activation time "now".
- 8) After 5 seconds, the SS shall switch the power settings from T2 to T3
- 9) If the UE transmits the UL DPCH to cell 2 less than 160 ms from the beginning of time period T3 then the number of successful tests is increased by one  
 UE shall transmit a PHYSICAL CHANNEL RECONFIGURATION COMPLETE message on the UL DCCH of cell 2.
- 10) After 5 seconds, the UE is switched off. Any timing information of cell 2 is deleted in the UE.
- 11) Repeat step 1-10 until the confidence level according to annex F.6.2 is achieved.

### Specific Message Contents

All messages indicated above shall use the same content as described in the default message content in clause 9 of 34.108 [3] with the following exceptions:

MEASUREMENT CONTROL message (step 4):

Information Element/Group name	Value/Remark
Message Type (10.2.17)	
<b>UE information elements</b>	
-RRC transaction identifier	0
-Integrity check info	Not Present
<b>Measurement Information elements</b>	
-Measurement Identity	1
-Measurement Command (10.3.7.46)	Modify
-Measurement Reporting Mode (10.3.7.49)	AM RLC
-Periodical Reporting / Event Trigger Reporting Mode	Event trigger
-Additional measurements list (10.3.7.1)	Not Present
-CHOICE <i>Measurement type</i>	Intra-frequency measurement
-Intra-frequency measurement (10.3.7.36)	Not Present
-Intra-frequency measurement objects list (10.3.7.33)	Not Present
-Intra-frequency measurement quantity (10.3.7.38)	0
-Filter coefficient (10.3.7.9)	TDD
-CHOICE <i>mode</i>	1
-Measurement quantity list	
-Measurement quantity	Primary CCPCH
-Intra-frequency reporting quantity (10.3.7.41)	
-Reporting quantities for active set cells (10.3.7.5)	No report
-SFN-SFN observed time difference reporting indicator	TRUE (Note 1)
-Cell synchronisation information reporting indicator	TRUE
-Cell Identity reporting indicator	TDD
-CHOICE <i>mode</i>	TRUE
-Timeslot ISCP reporting indicator	TRUE
-Primary CCPCH RSCP reporting indicator	TRUE
-Pathloss reporting indicator	TRUE
-Reporting quantities for monitored set cells (10.3.7.5)	No report
-SFN-SFN observed time difference reporting indicator	TRUE (Note 1)
-Cell synchronisation information reporting indicator	TRUE
-Cell Identity reporting indicator	TDD
-CHOICE <i>mode</i>	TRUE
-Timeslot ISCP reporting indicator	FALSE
-Proposed TGSN reporting required	TRUE
-Primary CCPCH RSCP reporting indicator	TRUE
-Pathloss reporting indicator	TRUE
-Reporting quantities for detected set cells (10.3.7.5)	Not Present
-Reporting cell status (10.3.7.61)	
-CHOICE <i>reported cell</i>	Report all active set cells + cells within monitored set on used frequency
-Maximum number of reported cells	2
-Measurement validity (10.3.7.51)	Not Present
-CHOICE <i>report criteria</i>	Intra-frequency measurement reporting criteria
-Intra-frequency measurement reporting criteria (10.3.7.39)	
-Parameters required for each event	1
-Intra-frequency event identity	Event 1G
-Triggering condition 2	Not Present
-Reporting Range Constant	Not Present
-Cells forbidden to affect Reporting Range	Not Present
-W	Not Present
-Hysteresis	0 dB
-Threshold used frequency	Not Present
-Reporting deactivation threshold	Not Present
-Replacement activation threshold	Not Present
-Time to trigger	0 ms
-Amount of reporting	Infinity
-Reporting interval	0 ms (Note 2)
-Reporting cell status	Not Present
<b>Physical channel information elements</b>	
-DPCH compressed mode status info (10.3.6.34)	Not Present

Information Element/Group name	Value/Remark
Note 1:	The SFN-CFN observed time difference is calculated from the OFF and Tm parameters contained in the IE "Cell synchronisation information", TS 25.331, clause 10.3.7.6. According to TS 25.331, 8.6.7.7, this IE is included in MEASUREMENT REPORT if IE "Cell synchronisation information reporting indicator" in IE "Cell reporting quantities" TS 25.331, clause 10.3.7.5 is set to TRUE in MEASUREMENT CONTROL.
Note 2:	Reporting interval = 0 ms means no periodical reporting

PHYSICAL CHANNEL RECONFIGURATION message (step 7):

Information Element	Value/Remark
Message Type	
<b>UE Information Elements</b>	
-RRC transaction identifier	0
-Integrity check info	Not Present
-Integrity protection mode info	Not Present
-Ciphering mode info	Not Present
-Activation time	At T3
-New U-RNTI	Not Present
-New C-RNTI	Not Present
-RRC State Indicator	CELL_DCH
-UTRAN DRX cycle length coefficient	Not Present
<b>CN Information Elements</b>	
-CN Information info	Not Present
<b>UTRAN mobility information elements</b>	
-URA identity	Not Present
<b>RB information elements</b>	
-Downlink counter synchronisation info	Not Present
-RB with PDCP information list	Not Present
-RB with PDCP information	Not Present
<b>PhyCH information elements</b>	
-Frequency info (10.3.6.36)	TDD
-CHOICE <i>mode</i>	Same UARFCN as used for cell 2
-UARFCN (Nt)	
<b>Uplink radio resources</b>	
-Maximum allowed UL TX power	30 dBm
-CHOICE <i>channel requirement</i>	Uplink DPCH info
-Uplink DPCH info (10.3.6.88)	
-Uplink DPCH power control info (10.3.6.91)	
-CHOICE <i>mode</i>	TDD
-TDD	1,28 Mcps TDD
-UL target SIR	Not Present
-CHOICE <i>UL OL PC info</i>	Individually signalled
-CHOICE <i>TDD option</i>	
--1,28 Mcps TDD	1
-TPC step size	1
-CHOICE <i>mode</i>	TDD
-Uplink timing advance control (10.3.6.96)	
-CHOICE <i>Timing Advance</i>	Disabled
-UL CCTrCH list	1
-UL Target SIR	9 dB
-Time Info (10.3.6.83)	
-Activation Time	now
-Duration	Infinite
-Common timeslot info	Not Present
-Uplink DPCH timeslots and codes (10.3.6.94)	
-Dynamic SF Usage	False
-First individual timeslot info (10.3.6.37)	
-Timeslot Number (10.3.6.84)	
-CHOICE <i>TDD option</i>	1,28 Mcps
-Timeslot number	2
-TFCl existence	True
-Midamble shift and burst type (10.3.6.41)	
-Choice <i>TDD option</i>	1,28 Mcps
-Midamble Allocation Mode	Default
-Midamble configuration	16
-Midamble shift	Not present
-CHOICE <i>TDD option</i>	1,28 Mcps
-Modulation	QPSK
-SS-TPC Symbols	
-Additional TPC-SS Symbols	
-First timeslot code list	1
-Channelisation code	8/1
-Choice more timeslots	No more timeslots
<b>Downlink radio resources</b>	
-CHOICE <i>mode</i>	TDD

Information Element	Value/Remark
-Downlink information common for all radio links (10.3.6.24)	
-Downlink DPCH info common for all RL (10.3.6.18)	
-Timing indicator	Initialise
-CFN-targetSFN frame offset	Not Present
-Downlink DPCH power control information (10.3.6.23)	
-CHOICE <i>mode</i>	TDD
-TPC Step size	1 dB
-CHOICE <i>mode</i>	TDD
-CHOICE <i>mode</i>	TDD
-CHOICE <i>TDD option</i>	1,28 Mcps
- <i>TSTD indicator</i> (10.3.6.85a)	TRUE
-Default DPCH Offset Value (10.3.6.16)	0
-Downlink information per radio link list	1
-Downlink information for each radio link (10.3.6.27)	
-CHOICE <i>mode</i>	TDD
-Primary CCPCH info (10.3.6.57)	
-CHOICE <i>mode</i>	TDD
-CHOICE <i>TDD option</i>	1,28 Mcps
<i>TSTD indicator</i>	TRUE
-Cell parameters ID	0
-SCTD indicator	False
-Downlink DPCH info for each RL (10.3.6.21)	
-CHOICE <i>mode</i>	TDD
-DL CCTrCH list	1
-TFCS ID	Not Present
-Time Info (10.3.6.83)	
-Activation Time	now
-Duration	Infinite
-Common timeslot info	Not Present
-Downlink DPCH timeslots and codes (10.3.6.32)	
-First individual timeslot info (10.3.6.37)	
-Timeslot Number (10.3.6.84)	
-CHOICE <i>TDD option</i>	1,28 Mcps
-Timeslot number	5
-TFCI existence	True
-Midamble shift and burst type (10.3.6.41)	
-CHOICE <i>TDD option</i>	1,28 Mcps
-Midamble Allocation Mode	Default
-Midamble configuration	16
-Midamble shift	Not present
-CHOICE <i>TDD option</i>	1,28 Mcps
-Modulation	QPSK
-SS-TPC Symbols	
-Additional TPC-SS Symbols	
-First timeslot channelisation codes (10.3.6.17)	
-CHOICE <i>codes representation</i>	Consecutive codes
-First channelisation code	16/1
-Last channelisation code	16/2
-CHOICE <i>more timeslots</i>	No more timeslots
-SCCPCH information for FACH (10.3.6.70)	Not Present

## MEASUREMENT REPORT message for Intra frequency test cases

This message is common for all intra frequency test cases in clause 8.7 and is described in Annex I.

### 8.3.1A.1.1.5 Test requirements

For the test to pass, the total number of successful tests shall be more than 90% with a confidence level of 95% of the cases.

**NOTE:** If the above Test Requirement differs from the Minimum Requirement then the Test Tolerance applied for this test is non-zero. The Test Tolerance for this test is defined in clause F.2 and the explanation of how the Minimum Requirement has been relaxed by the Test Tolerance is given in clause F.4.

### 8.3.1A.1.2 Scenario 2

This test case is applicable for UE handovers from primary frequency to secondary frequency in the case of multi-frequency network.

#### 8.3.1A.1.2.1 Definition and applicability

Handover delay of the UE is defined as the time from the end of the last TTI containing an RRC message implying hard handover to the transmission of the new uplink DPCH or the SYNC-UL in case that a handover with SYNCH uplink exchange is recommended, including the RRC procedure delay as defined in [9].

The requirements and this test apply to the UTRA TDD UE 1,28 Mcps option.

#### 8.3.1A.1.2.2 Minimum requirement

The hard handover delay shall be less than 160 ms when the cell is known by the UE and the SFN of the target cell does not need to be decoded. The rate of correct handovers observed during repeated tests shall be at least 90% with a confidence level of 95%.

The normative reference for this requirement is TS 25.123 [2] clauses 5.1.2 and A.5.1.2.

#### 8.3.1A.1.2.3 Test purpose

The purpose of this test is to verify the requirement for the intra-frequency handover delay in CELL\_DCH state.

#### 8.3.1A.1.2.4 Method of test

##### 8.3.1A.1.2.4.1 Initial conditions

Test environment: normal; see clauses G.2.1 and G.2.2.

Frequencies to be tested: mid range; see clause G.2.4.

The test parameters are given in table 8.3.1A.1.2.1 and 8.3.1A.1.2.2. In the measurement control information it is indicated to the UE that event-triggered reporting with Event 2C shall be used, and that P-CCPCH RSCP and SFN-CFN observed timed difference shall be reported together with Event 2C. The test consists of three successive time periods, with a time duration of T1, T2 and T3 respectively. At the start of time duration T1, the UE may not have any timing information of cell 2.

UTRAN shall send a Physical Channel reconfiguration message with activation time "now" with a new active cell, cell 2. The Physical Channel reconfiguration message shall be sent to the UE during period T2, after the UE has reported event 1G. The starting point of T3 is defined as the end of the last TTI containing the physical channel reconfiguration message.

**Table 8.3.1A.1.2.1: General test parameters for Handover to intra-frequency cell**

Parameter	Unit	Value	Comment
DCH parameters		DL and UL Reference Measurement Channel 12.2 kbps	As specified in TS 25.102 clause A.2.2.2 and A.2.1.2
Power Control		On	
Target quality value on DTCH	BLER	0.01	
Initial conditions	Active cell	Cell 1	The UE has a RRC connection on the secondary frequency in cell 1.
	Neighbour cell	Cell 2	
Final condition	Active cell	Cell 2	The UE will handover to the primary frequency in cell 2.
Hysteresis	dB	0	
Threshold non-used frequency	dBm	-75	Absolute threshold RSCP for Event 2C
Time to Trigger	ms	0	
Filter coefficient		0	
Monitored cell list size		6 TDD neighbours on Channel 1	
T1	s	5	
T2	s	5	
T3	s	5	



Table 8.3.1A.1.2.2: Cell specific test parameters for Handover to intra-frequency cell 1,28Mcps option

Parameter	Unit	Cell 1								
		0			DwPTS			5		
Timeslot Number		T1	T2	T3	T1	T2	T3	T1	T2	T3
UTRA RF Channel Number(Note 3)		Channel 1								
PCCPCH_Ec/Ior	dB	-3						n.a.		
DwPCH_Ec/Ior					0					
DPCH_Ec/Ior	dB	n.a.			n.a.			Note1	n.a.	
OCNS_Ec/Ior	dB	-3						Note2		
$\hat{I}_{or}/I_{oc}$	dB	3			3			3		
$I_{oc}$	dBm/1, 28 MHz	-70								
PCCPCH_RSCP	dBm	-70			n.a.			n.a.		
Propagation Condition		AWGN								
Parameter	Unit	Cell 2								
Timeslot Number		0			DwPTS			5		
Timeslot Number		T1	T2	T3	T1	T2	T3	T1	T2	T3
UTRA RF Channel Number(NOTE3)		Channel 2								
UTRA RF Channel Number(NOTE4)		Channel 1								
PCCPCH_Ec/Ior	dB	-3						n.a.		
DwPCH_Ec/Ior					0					
DPCH_Ec/Ior	dB	n.a.			n.a.			n.a.	Note 1	
OCNS_Ec/Ior	dB	-3						Note2		
$\hat{I}_{or}/I_{oc}$	dB	-Inf.	4		-Inf.	4		-Inf.	4	
$I_{oc}$	dBm/1, 28 MHz	-70								
PCCPCH_RSCP	dBm	-Inf.	-69		n.a.			n.a.		
Propagation Condition		AWGN								
Note 1:	The DPCH level is controlled by the power control loop									
Note 2:	The power of the OCNS channel that is added shall make the total power from the cell to be equal to $I_{or}$ .									
Note3:	In the case of multi-frequency network, the UTRA RF Channel Number is the primary frequency's channel number.									
Note 4:	In the case of multi-frequency network, the UTRA RF Channel Number is the secondary frequency's channel number									

## 8.3.1A.1.2.4.2 Procedure

- 1) The RF parameters are set up according to T1.
- 2) The UE is switched on.
- 3) A call is set up according to the test procedure specified in TS 34.108 [3] subclause 7.3.4.
- 4) SS shall transmit a MEASUREMENT CONTROL message.
- 5) After 5 seconds, the SS shall switch the power settings from T1 to T2.
- 6) UE shall transmit a MEASUREMENT REPORT message triggered by event 1G.
- 7) SS shall transmit a PHYSICAL CHANNEL RECONFIGURATION message with activation time "now".
- 8) After 5 seconds, the SS shall switch the power settings from T2 to T3
- 9) If the UE transmits the UL DPCH to cell 2 less than 160 ms from the beginning of time period T3 then the number of successful tests is increased by one UE shall transmit a PHYSICAL CHANNEL RECONFIGURATION COMPLETE message on the UL DCCH of cell 2.

10) After 5 seconds, the UE is switched off. Any timing information of cell 2 is deleted in the UE.

11) Repeat step 1-10 until the confidence level according to annex F.6.2 is achieved.

#### Specific Message Contents

All messages indicated above shall use the same content as described in the default message content in clause 9 of 34.108 [3] with the following exceptions:

MEASUREMENT CONTROL message (step 4):

Information Element/Group name	Value/Remark
Message Type (10.2.17)	
<b>UE information elements</b> -RRC transaction identifier -Integrity check info	0 Not Present
<b>Measurement Information elements</b> -Measurement Identity -Measurement Command (10.3.7.46) -Measurement Reporting Mode (10.3.7.49) -Measurement Report Transfer Mode -Periodical Reporting / Event Trigger Reporting Mode -Additional measurements list (10.3.7.1)	1 Modify  AM RLC Event trigger Not Present
-CHOICE <i>Measurement type</i> -Inter-frequency measurement (10.3.7.16) -Inter-frequency measurement objects list (10.3.7.13) -Inter-frequency measurement quantity (10.3.7.18) -CHOICE <i>reporting criteria</i> -Inter-frequency reporting criteria -Filter coefficient -CHOICE <i>mode</i> -Measurement quantity for frequency quality estimate	Inter-frequency measurement  Not Present  Inter-frequency reporting criteria  0 TDD Primary CCPCH RSCP
-Inter-frequency reporting quantity (10.3.7.21) -UTRA Carrier RSSI -Frequency quality estimate -Non frequency related cell reporting quantities (10.3.7.5) -SFN-SFN observed time difference reporting indicator -Cell synchronisation information reporting indicator -Cell Identity reporting indicator -CHOICE <i>mode</i> -Timeslot ISCP reporting indicator -Proposed TGSN reporting required -Primary CCPCH RSCP reporting indicator -Pathloss reporting indicator	FALSE FALSE  Type 1 TRUE TRUE TDD TRUE FALSE TRUE TRUE
-Reporting cell status (10.3.7.61) -CHOICE <i>reported cell</i>  -Maximum number of reported cells per reported non-used frequency -Measurement validity (10.3.7.51) -Inter-frequency set update (10.3.7.22) -CHOICE <i>report criteria</i>	Report cells within monitored set on non-used frequency  1  Not Present Not Present Inter-frequency measurement reporting criteria
-Inter-frequency measurement reporting criteria (10.3.7.19) -Parameters required for each event -Inter-frequency event identity (10.3.7.14) -Threshold used frequency -W used frequency -Hysteresis -Time to trigger -Reporting cell status (10.3.7.61) -CHOICE <i>reported cell</i>  -Maximum number of reported cells per reported non-used frequency -Parameters required for each non-used frequency -Threshold non-used frequency -W non-used frequency	1 Event 2C Not Present Not Present 0 dB 0 ms  Report cells within monitored set on non-used frequency 1  1 -75 dBm 1
<b>Physical channel information elements</b> -DPCH compressed mode status info (10.3.6.34)	Not Present

## PHYSICAL CHANNEL RECONFIGURATION message (step 7):

Information Element	Value/Remark
Message Type	
<b>UE Information Elements</b>	
-RRC transaction identifier	0
-Integrity check info	Not Present
-Integrity protection mode info	Not Present
-Ciphering mode info	Not Present
-Activation time	At T3
-New U-RNTI	Not Present
-New C-RNTI	Not Present
-RRC State Indicator	CELL_DCH
-UTRAN DRX cycle length coefficient	Not Present
<b>CN Information Elements</b>	
-CN Information info	Not Present
<b>UTRAN mobility information elements</b>	
-URA identity	Not Present
<b>RB information elements</b>	
-Downlink counter synchronisation info	Not Present
-RB with PDCP information list	Not Present
-RB with PDCP information	Not Present
<b>PhyCH information elements</b>	
-Frequency info (10.3.6.36)	
-CHOICE <i>mode</i>	TDD
-UARFCN (Nt)	Same UARFCN as used for cell 2
<b>Uplink radio resources</b>	
-Maximum allowed UL TX power	30 dBm
-CHOICE <i>channel requirement</i>	Uplink DPCH info
-Uplink DPCH info (10.3.6.88)	
-Uplink DPCH power control info (10.3.6.91)	
-CHOICE <i>mode</i>	TDD
-TDD	1,28 Mcps TDD
-UL target SIR	Not Present
-CHOICE <i>UL OL PC info</i>	Individually signalled
-CHOICE <i>TDD option</i>	
--1,28 Mcps TDD	1
-TPC step size	1
-CHOICE <i>mode</i>	TDD
-Uplink timing advance control (10.3.6.96)	
-CHOICE <i>Timing Advance</i>	Disabled
-UL CCTrCH list	1
-UL Target SIR	9 dB
-Time Info (10.3.6.83)	
-Activation Time	now
-Duration	Infinite
-Common timeslot info	Not Present
-Uplink DPCH timeslots and codes (10.3.6.94)	
-Dynamic SF Usage	False
-First individual timeslot info (10.3.6.37)	
-Timeslot Number (10.3.6.84)	
-CHOICE <i>TDD option</i>	1,28 Mcps
-Timeslot number	2
-TFCl existence	True
-Midamble shift and burst type (10.3.6.41)	
-Choice <i>TDD option</i>	1,28 Mcps
-Midamble Allocation Mode	Default
-Midamble configuration	16
-Midamble shift	Not present
-CHOICE <i>TDD option</i>	1,28 Mcps
-Modulation	QPSK
-SS-TPC Symbols	
-Additional TPC-SS Symbols	
-First timeslot code list	1
-Channelisation code	8/1
-Choice more timeslots	No more timeslots
<b>Downlink radio resources</b>	
-CHOICE <i>mode</i>	TDD

Information Element	Value/Remark
-Downlink information common for all radio links (10.3.6.24)	
-Downlink DPCH info common for all RL (10.3.6.18)	
-Timing indicator	Initialise
-CFN-targetSFN frame offset	Not Present
-Downlink DPCH power control information (10.3.6.23)	
-CHOICE <i>mode</i>	TDD
-TPC Step size	1 dB
-CHOICE <i>mode</i>	TDD
-CHOICE <i>mode</i>	TDD
-CHOICE <i>TDD option</i>	1,28 Mcps
- <i>TSTD indicator</i> (10.3.6.85a)	TRUE
-Default DPCH Offset Value (10.3.6.16)	0
-Downlink information per radio link list	1
-Downlink information for each radio link (10.3.6.27)	
-CHOICE <i>mode</i>	TDD
-Primary CCPCH info (10.3.6.57)	
-CHOICE <i>mode</i>	TDD
-CHOICE <i>TDD option</i>	1,28 Mcps
<i>TSTD indicator</i>	TRUE
-Cell parameters ID	0
-SCTD indicator	False
-Downlink DPCH info for each RL (10.3.6.21)	
-CHOICE <i>mode</i>	TDD
-DL CCTrCH list	1
-TFCS ID	Not Present
-Time Info (10.3.6.83)	
-Activation Time	now
-Duration	Infinite
-Common timeslot info	Not Present
-Downlink DPCH timeslots and codes (10.3.6.32)	
-First individual timeslot info (10.3.6.37)	
-Timeslot Number (10.3.6.84)	
-CHOICE <i>TDD option</i>	1,28 Mcps
-Timeslot number	5
-TFCI existence	True
-Midamble shift and burst type (10.3.6.41)	
-CHOICE <i>TDD option</i>	1,28 Mcps
-Midamble Allocation Mode	Default
-Midamble configuration	16
-Midamble shift	Not present
-CHOICE <i>TDD option</i>	1,28 Mcps
-Modulation	QPSK
-SS-TPC Symbols	
-Additional TPC-SS Symbols	
-First timeslot channelisation codes (10.3.6.17)	
-CHOICE <i>codes representation</i>	Consecutive codes
-First channelisation code	16/1
-Last channelisation code	16/2
-CHOICE <i>more timeslots</i>	No more timeslots
-SCCPCH information for FACH (10.3.6.70)	Not Present

## MEASUREMENT REPORT message for Intra frequency test cases

This message is common for all intra frequency test cases in clause 8.7 and is described in Annex I.

### 8.3.1A.1.2.5 Test requirements

For the test to pass, the total number of successful tests shall be more than 90% with a confidence level of 95% of the cases.

**NOTE:** If the above Test Requirement differs from the Minimum Requirement then the Test Tolerance applied for this test is non-zero. The Test Tolerance for this test is defined in clause F.2 and the explanation of how the Minimum Requirement has been relaxed by the Test Tolerance is given in clause F.4.

## 8.3.1A.2 Handover to inter-frequency cell

### 8.3.1A.2.1 Scenario 1

This test case is applicable for UE handovers in single frequency network and UE handovers from primary frequency to the primary frequency in multi-frequency network.

#### 8.3.1A.2.1.1 Definition and applicability

Handover delay of the UE is defined as the time from the end of the last TTI containing an RRC message implying hard handover to the transmission of the new uplink DPCH or the SYNC-UL in case that a handover with SYNCH uplink exchange is recommended, including the RRC procedure delay as defined in [9].

The requirements and this test apply to the UTRA TDD UE 1,28 Mcps option.

#### 8.3.1A.2.1.2 Minimum requirement

The hard handover delay shall be less than 160ms when the cell is known by the UE and the SFN of the target cell needs to be decoded. The rate of correct handovers observed during repeated tests shall be at least 90%.

The normative reference for this requirement is TS 25.123 [2] clauses 5.1.2 and A.5.1.2.

#### 8.3.1A.2.1.3 Test purpose

The purpose of this test is to verify the requirement for the inter-frequency handover delay in CELL\_DCH state.

#### 8.3.1A.2.1.4 Method of test

##### 8.3.1A.2.1.4.1 Initial conditions

Test environment: normal; see clauses G.2.1 and G.2.2.

Frequencies to be tested: mid range; see clause G.2.4.

The test parameters are given in table 8.3.1A.2.1.1 and 8.3.1A.2.1.2. In the measurement control information it is indicated to the UE that event-triggered reporting with Event 2C shall be used. The PCCPCH RSCP and SFN-CFN observed time difference of the best cell on the unused frequency shall be reported together with Event 2C reporting. At the start of time duration T1, the UE may not have any timing information of cell 2.

UTRAN shall send a Physical Channel reconfiguration message with activation time "now" with one active cell, cell 2. The Physical Channel reconfiguration message shall be sent to the UE during period T2, after the UE has reported event 2C, The starting point of T3 is defined as the end of the last TTI containing the physical channel reconfiguration message.

**Table 8.3.1A.2.1.1: General test parameters for Handover to inter-frequency cell**

Parameter		Unit	Value	Comment
DCH parameters			DL and UL Reference Measurement Channel 12.2 kbps	As specified in TS 25.102 clause A.2.2.2 and A.2.1.2
Power Control			On	
Target quality value on DTCH		BLER	0.01	
Initial conditions	Active cell		Cell 1	In the case of multi-frequency network, the UE has a RRC connection on the primary frequency in cell 1.
	Neighbour cell		Cell 2	
Final condition	Active cell		Cell 2	In the case of multi-frequency network, the UE will handover to the primary frequency in cell 2.
Threshold non-used frequency		dBm	-75	Absolute threshold RSCP for Event 2C
O		dB	0	Cell individual offset. This value shall be used for all cells in the test.
Hysteresis		dB	0	
Time to Trigger		ms	0	
Filter coefficient			0	
Monitored cell list size			6 TDD neighbours on Channel 1 6 TDD neighbours on Channel 2	
T1		s	5	
T2		s	10	
T3		s	5	

Table 8.3.1A.2.1.2: Cell Specific parameters for Handover to inter-frequency cell

Parameter	Unit	Cell 1								
		0			DwPTS			5		
Timeslot Number		T1	T2	T3	T1	T2	T3	T1	T2	T3
UTRA RF Channel Number(Note 3)		Channel 1								
PCCPCH_Ec/lor	dB	-3						n.a.		
DwPCH_Ec/lor					0					
DPCH_Ec/lor	dB	n.a.			n.a.			Note1	n.a.	
OCNS_Ec/lor	dB	-3						Note2		
$\hat{I}_{or}/I_{oc}$	dB	3			3			3		
$I_{oc}$	dBm/1, 28 MHz	-70								
PCCPCH_RSCP	dBm	-70			n.a.			n.a.		
Propagation Condition		AWGN								
Parameter	Unit	Cell 2								
Timeslot Number		0			DwPTS			5		
Timeslot Number		T1	T2	T3	T1	T2	T3	T1	T2	T3
UTRA RF Channel Number(Note 3)		Channel 2								
PCCPCH_Ec/lor	dB	-3						n.a.		
DwPCH_Ec/lor					0					
DPCH_Ec/lor	dB	n.a.			n.a.			n.a.	Note 1	
OCNS_Ec/lor	dB	-3						Note2		
$\hat{I}_{or}/I_{oc}$	dB	-Inf.	4		-Inf.	4		-Inf.	4	
$I_{oc}$	dBm/1, 28 MHz	-70								
PCCPCH_RSCP	dBm	-Inf.	-69		n.a.			n.a.		
Propagation Condition		AWGN								
Note 1: The DPCH level is controlled by the power control loop Note 2: The power of the OCNS channel that is added shall make the total power from the cell to be equal to $I_{or}$ . Note3: In the case of multi-frequency network, the UTRA RF Channel Number is the primary frequency's channel number.										

## 8.3.1A.2.1.4.2 Procedure

- 1) The RF parameters are set up according to T1.
- 2) The UE is switched on.
- 3) A call is set up according to the test procedure specified in TS 34.108 [3] subclause 7.3.4.
- 4) SS shall transmit a MEASUREMENT CONTROL message.
- 5) After 5 seconds, the SS shall switch the power settings from T1 to T2.
- 6) UE shall transmit a MEASUREMENT REPORT message triggered by event 2C.
- 7) SS shall transmit a PHYSICAL CHANNEL RECONFIGURATION message with activation time "now".
- 8) After 10 seconds, the SS shall switch the power settings from T2 to T3
- 9) If the UE transmits the UL DPCH to cell 2 less than 160 ms from the beginning of time period T3 then the number of successful tests is increased by one. UE shall transmit a PHYSICAL CHANNEL RECONFIGURATION COMPLETE message on the UL DCCH of cell 2.
- 10) After 5 seconds, the UE is switched off. Any timing information of cell 2 is deleted in the UE.
- 11) Repeat steps 1-10 until the confidence level according to annex F.6.2 is achieved.



## Specific Message Contents

All messages indicated above shall use the same content as described in the default message content in clause 9 of 34.108 [3] with the following exceptions:

MEASUREMENT CONTROL message, event 2C (step 4):

Information Element/Group name	Value/Remark
Message Type (10.2.17)	
<b>UE information elements</b> -RRC transaction identifier -Integrity check info	0 Not Present
<b>Measurement Information elements</b> -Measurement Identity -Measurement Command (10.3.7.46) -Measurement Reporting Mode (10.3.7.49) -Measurement Report Transfer Mode -Periodical Reporting / Event Trigger Reporting Mode -Additional measurements list (10.3.7.1)	1 Modify AM RLC Event trigger Not Present
-CHOICE <i>Measurement type</i> -Inter-frequency measurement (10.3.7.16) -Inter-frequency measurement objects list (10.3.7.13) -Inter-frequency measurement quantity (10.3.7.18) -CHOICE <i>reporting criteria</i> -Inter-frequency reporting criteria -Filter coefficient -CHOICE <i>mode</i> -Measurement quantity for frequency quality estimate	Inter-frequency measurement Not Present Inter-frequency reporting criteria 0 TDD Primary CCPCH RSCP
-Inter-frequency reporting quantity (10.3.7.21) -UTRA Carrier RSSI -Frequency quality estimate -Non frequency related cell reporting quantities (10.3.7.5) -SFN-SFN observed time difference reporting indicator -Cell synchronisation information reporting indicator -Cell Identity reporting indicator -CHOICE <i>mode</i> -Timeslot ISCP reporting indicator -Proposed TGSN reporting required -Primary CCPCH RSCP reporting indicator -Pathloss reporting indicator	FALSE FALSE Type 1 TRUE TRUE TDD TRUE FALSE TRUE TRUE
-Reporting cell status (10.3.7.61) -CHOICE <i>reported cell</i>  -Maximum number of reported cells per reported non-used frequency -Measurement validity (10.3.7.51) -Inter-frequency set update (10.3.7.22) -CHOICE <i>report criteria</i>	Report cells within monitored set on non-used frequency 1 Not Present Not Present Inter-frequency measurement reporting criteria
-Inter-frequency measurement reporting criteria (10.3.7.19) -Parameters required for each event -Inter-frequency event identity (10.3.7.14) -Threshold used frequency -W used frequency -Hysteresis -Time to trigger -Reporting cell status (10.3.7.61) -CHOICE <i>reported cell</i>  -Maximum number of reported cells per reported non-used frequency -Parameters required for each non-used frequency -Threshold non-used frequency -W non-used frequency	1 Event 2C Not Present Not Present 0 dB 0 ms Report cells within monitored set on non-used frequency 1 1 -75 dBm 1
<b>Physical channel information elements</b> -DPCH compressed mode status info (10.3.6.34)	Not Present

## PHYSICAL CHANNEL RECONFIGURATION message (step 7):

Information Element	Value/Remark
Message Type	
<b>UE Information Elements</b>	
-RRC transaction identifier	0
-Integrity check info	Not Present
-Integrity protection mode info	Not Present
-Ciphering mode info	Not Present
-Activation time	now
-New U-RNTI	Not Present
-New C-RNTI	Not Present
-RRC State Indicator	CELL_DCH
-UTRAN DRX cycle length coefficient	Not Present
<b>CN Information Elements</b>	
-CN Information info	Not Present
<b>UTRAN mobility information elements</b>	
-URA identity	Not Present
<b>RB information elements</b>	
-Downlink counter synchronisation info	Not Present
-RB with PDCP information list	Not Present
-RB with PDCP information	Not Present
<b>PhyCH information elements</b>	
-Frequency info (10.3.6.36)	
-CHOICE <i>mode</i>	TDD
-UARFCN (Nt)	Same UARFCN as used for cell 2
<b>Uplink radio resources</b>	
-Maximum allowed UL TX power	30 dBm
-CHOICE <i>channel requirement</i>	Uplink DPCH info
-Uplink DPCH info (10.3.6.88)	
-Uplink DPCH power control info (10.3.6.91)	
-CHOICE <i>mode</i>	
-UL target SIR	Not Present
-CHOICE <i>UL OL PC info</i>	Individually signalled
-CHOICE <i>TDD option</i>	
-1,28 Mcps TDD	
-TPC stepsize	1
-CHOICE <i>mode</i>	TDD
-Uplink timing advance control (10.3.6.96)	
-CHOICE <i>Timing Advance</i>	Disabled
-UL CCTrCH list	1
-UL Target SIR	9 dB
-Time Info (10.3.6.83)	
-Activation Time	T3
-Duration	Infinite
-Common timeslot info	Not Present
-Uplink DPCH timeslots and codes (10.3.6.94)	
-Dynamic SF Usage	False
-First individual timeslot info (10.3.6.37)	
-Timeslot Number (10.3.6.84)	
-CHOICE <i>TDD option</i>	1,28 Mcps
-Timeslot number	2
-TFCl existence	True
-Midamble shift and burst type (10.3.6.41)	
-CHOICE <i>TDD option</i>	1,28 Mcps
-Midamble Allocation Mode	Default
-Midamble configuration	16
-Midamble shift	Not present
-CHOICE <i>TDD option</i>	1,28 Mcps
-Modulation	QPSK
-SS-TPC Symbols	
-Additional TPC-SS Symbols	
-First timeslot code list	1
-Channelisation code	8/1
-CHOICE <i>more timeslots</i>	No more timeslots
<b>Downlink radio resources</b>	
-CHOICE <i>mode</i>	TDD
-Downlink information common for all radio links (10.3.6.24)	

Information Element	Value/Remark
-Downlink DPCH info common for all RL (10.3.6.18)	
-Timing indicator	Initialise
-CFN-targetSFN frame offset	Not Present
-Downlink DPCH power control information (10.3.6.23)	
-CHOICE <i>mode</i>	TDD
-TPC Step size	1 dB
-CHOICE <i>mode</i>	TDD
-CHOICE <i>mode</i>	TDD
-CHOICE <i>TDD option</i>	1,28 Mcps
- TSTD indicator (10.3.6.85a)	TRUE
-Default DPCH Offset Value (10.3.6.16)	0
-Downlink information per radio link list	1
-Downlink information for each radio link (10.3.6.27)	
-CHOICE <i>mode</i>	TDD
-Primary CCPCH info (10.3.6.57)	
- CHOICE <i>mode</i>	TDD
- CHOICE <i>TDD option</i>	1,28 Mcps
<i>TSTD indicator</i>	TRUE
- Cell parameters ID	0
- SCTD indicator	False
-Downlink DPCH info for each RL (10.3.6.21)	
-CHOICE <i>mode</i>	TDD
- DL CCTrCH list	1
-TFCS ID	Not Present
-Time Info (10.3.6.83)	
-Activation Time	now
-Duration	Infinite
-Common timeslot info	Not Present
- Downlink DPCH timeslots and codes (10.3.6.32)	
- First individual timeslot info (10.3.6.37)	
- Timeslot Number (10.3.6.84)	
- CHOICE <i>TDD option</i>	1,28 Mcps
- Timeslot number	5
- TFCI existence	True
- Midamble shift and burst type (10.3.6.41)	
- CHOICE <i>TDD option</i>	1,28 Mcps
- Midamble Allocation Mode	Default
- Midamble configuration	16
- Midamble shift	Not present
- CHOICE <i>TDD option</i>	1,28 Mcps
- First timeslot channelisation codes (10.3.6.17)	
-Modulation	QPSK
-SS-TPC Symbols	
-Additional TPC-SS Symbols	
- CHOICE <i>codes representation</i>	Consecutive codes
- First channelisation code	16/1
- Last channelisation code	16/2
- CHOICE <i>more timeslots</i>	No more timeslots
- SCCPCH information for FACH (10.3.6.70)	Not Present

### MEASUREMENT REPORT message for Inter frequency test cases

This message is common for all inter frequency TDD test cases in clause 8.7 and is described in Annex I.

#### 8.3.1A.2.1.5 Test requirements

For the test to pass, the total number of successful tests shall be more than 90% with a confidence level of 95% of the cases.

NOTE: If the above Test Requirement differs from the Minimum Requirement then the Test Tolerance applied for this test is non-zero. The Test Tolerance for this test is defined in clause F.2 and the explanation of how the Minimum Requirement has been relaxed by the Test Tolerance is given in clause F.4.

### 8.3.1A.2.2 Scenario 2

This test case is applicable for UE handovers in single frequency network and UE handovers from primary frequency to the secondary frequency in multi-frequency network.

#### 8.3.1A.2.2.1 Definition and applicability

Handover delay of the UE is defined as the time from the end of the last TTI containing an RRC message implying hard handover to the transmission of the new uplink DPCH or the SYNC-UL in case that a handover with SYNCH uplink exchange is recommended, including the RRC procedure delay as defined in [9].

The requirements and this test apply to the UTRA TDD UE 1,28 Mcps option.

#### 8.3.1A.2.2.2 Minimum requirement

The hard handover delay shall be less than 160ms when the cell is known by the UE and the SFN of the target cell needs to be decoded. The rate of correct handovers observed during repeated tests shall be at least 90%.

The normative reference for this requirement is TS 25.123 [2] clauses 5.1.2 and A.5.1.2.

#### 8.3.1A.2.2.3 Test purpose

The purpose of this test is to verify the requirement for the inter-frequency handover delay in CELL\_DCH state.

#### 8.3.1A.2.2.4 Method of test

##### 8.3.1A.2.2.4.1 Initial conditions

Test environment: normal; see clauses G.2.1 and G.2.2.

Frequencies to be tested: mid range; see clause G.2.4.

The test parameters are given in table 8.3.1A.2.2.1 and 8.3.1A.2.2.2. In the measurement control information it is indicated to the UE that event-triggered reporting with Event 1G shall be used. The PCCPCH RSCP and SFN-CFN observed time difference of the best cell on the unused frequency shall be reported together with Event 1G reporting. At the start of time duration T1, the UE may not have any timing information of cell 2.

UTRAN shall send a Physical Channel reconfiguration message with activation time "now" with one active cell, cell 2. The Physical Channel reconfiguration message shall be sent to the UE during period T2, after the UE has reported event 1G, The starting point of T3 is defined as the end of the last TTI containing the physical channel reconfiguration message.

**Table 8.3.1A.2.2.1: General test parameters for Handover to inter-frequency cell**

Parameter		Unit	Value	Comment
DCH parameters			DL and UL Reference Measurement Channel 12.2 kbps	As specified in TS 25.102 clause A.2.2.2 and A.2.1.2
Power Control			On	
Target quality value on DTCH		BLER	0.01	
Initial conditions	Active cell		Cell 1	In the case of multi-frequency network, the UE has a RRC connection on the primary frequency in cell 1.
	Neighbour cell		Cell 2	

Final condition	Active cell		Cell 2	In the case of multi-frequency network, the UE will handover to the secondary frequency in cell 2.
O		dB	0	Cell individual offset. This value shall be used for all cells in the test.
Hysteresis		dB	0	
Time to Trigger		ms	0	
Filter coefficient			0	
Monitored cell list size			6 TDD neighbours on Channel 1 6 TDD neighbours on Channel 2	
T1		s	5	
T2		s	10	
T3		s	5	

**Table 8.3.1A.2.2.2: Cell Specific parameters for Handover to inter-frequency cell**

Parameter	Unit	Cell 1								
		0			DwPTS			5		
Timeslot Number		T1	T2	T3	T1	T2	T3	T1	T2	T3
UTRA RF Channel Number(Note 3)		Channel 1								
PCCPCH_Ec/lor	dB	-3			0			n.a.		
DwPCH_Ec/lor					0					
DPCH_Ec/lor	dB	n.a.			n.a.			Note1	n.a.	
OCNS_Ec/lor	dB	-3						Note2		
$\hat{I}_{or}/I_{oc}$	dB	3			3			3		
$I_{oc}$	dBm/1, 28 MHz	-70								
PCCPCH_RSCP	dBm	-70			n.a.			n.a.		
Propagation Condition		AWGN								
Parameter	Unit	Cell 2								
Timeslot Number		0			DwPTS			5		
		T1	T2	T3	T1	T2	T3	T1	T2	T3
UTRA RF Channel Number(Note 3)		Channel 1								
UTRA RF Channel Number(Note 4)		Channel 2								
PCCPCH_Ec/lor	dB	-3			0			n.a.		
DwPCH_Ec/lor					0					
DPCH_Ec/lor	dB	n.a.			n.a.			n.a.	Note 1	
OCNS_Ec/lor	dB	-3						Note2		
$\hat{I}_{or}/I_{oc}$	dB	-Inf.	6		-Inf.	6		-Inf.	6	
$I_{oc}$	dBm/1, 28 MHz	-70								
PCCPCH_RSCP	dBm	-Inf.	-67		n.a.			n.a.		
Propagation Condition		AWGN								
Note 1:	The DPCH level is controlled by the power control loop									
Note 2:	The power of the OCNS channel that is added shall make the total power from the cell to be equal to $I_{or}$ .									
Note3:	In the case of multi-frequency network, the UTRA RF Channel Number is the primary frequency's channel number.									
Note 4:	In the case of multi-frequency network, the UTRA RF Channel Number is the secondary frequency's channel number.									

8.3.1A.2.2.4.2 Procedure

- 1) The RF parameters are set up according to T1.
- 2) The UE is switched on.

- 3) A call is set up according to the test procedure specified in TS 34.108 [3] subclause 7.3.4.
- 4) SS shall transmit a MEASUREMENT CONTROL message.
- 5) After 5 seconds, the SS shall switch the power settings from T1 to T2.
- 6) UE shall transmit a MEASUREMENT REPORT message triggered by event 1G.
- 7) SS shall transmit a PHYSICAL CHANNEL RECONFIGURATION message with activation time "now".
- 8) After 10 seconds, the SS shall switch the power settings from T2 to T3
- 9) If the UE transmits the UL DPCH to cell 2 less than 160 ms from the beginning of time period T3 then the number of successful tests is increased by one. UE shall transmit a PHYSICAL CHANNEL RECONFIGURATION COMPLETE message on the UL DCCH of cell 2.
- 10) After 5 seconds, the UE is switched off. Any timing information of cell 2 is deleted in the UE.
- 11) Repeat steps 1-10 until the confidence level according to annex F.6.2 is achieved.

#### Specific Message Contents

All messages indicated above shall use the same content as described in the default message content in clause 9 of 34.108 [3] with the following exceptions:

MEASUREMENT CONTROL message, event 2C (step 4):

Information Element/Group name	Value/Remark
Message Type (10.2.17)	
<b>UE information elements</b>	
-RRC transaction identifier	0
-Integrity check info	Not Present
<b>Measurement Information elements</b>	
-Measurement Identity	1
-Measurement Command (10.3.7.46)	Modify
-Measurement Reporting Mode (10.3.7.49)	AM RLC
-Periodical Reporting / Event Trigger Reporting Mode	Event trigger
-Additional measurements list (10.3.7.1)	Not Present
-CHOICE <i>Measurement type</i>	Intra-frequency measurement
-Intra-frequency measurement (10.3.7.36)	
-Intra-frequency measurement objects list (10.3.7.33)	Not Present
-Intra-frequency measurement quantity (10.3.7.38)	
-Filter coefficient (10.3.7.9)	0
-CHOICE <i>mode</i>	TDD
-Measurement quantity list	1
-Measurement quantity	Primary CCPCH
-Intra-frequency reporting quantity (10.3.7.41)	
-Reporting quantities for active set cells (10.3.7.5)	No report
-SFN-SFN observed time difference reporting indicator	TRUE (Note 1)
-Cell synchronisation information reporting indicator	TRUE
-Cell Identity reporting indicator	TRUE
-CHOICE <i>mode</i>	TDD
-Timeslot ISCP reporting indicator	TRUE
-Primary CCPCH RSCP reporting indicator	TRUE
-Pathloss reporting indicator	TRUE
-Reporting quantities for monitored set cells (10.3.7.5)	No report
-SFN-SFN observed time difference reporting indicator	TRUE (Note 1)
-Cell synchronisation information reporting indicator	TRUE
-Cell Identity reporting indicator	TRUE
-CHOICE <i>mode</i>	TDD
-Timeslot ISCP reporting indicator	TRUE
-Proposed TGSN reporting required	FALSE
-Primary CCPCH RSCP reporting indicator	TRUE
-Pathloss reporting indicator	TRUE
-Reporting quantities for detected set cells (10.3.7.5)	Not Present
-Reporting cell status (10.3.7.61)	
-CHOICE <i>reported cell</i>	Report all active set cells + cells within monitored set on used frequency
-Maximum number of reported cells	2
-Measurement validity (10.3.7.51)	Not Present
-CHOICE <i>report criteria</i>	Intra-frequency measurement reporting criteria
-Intra-frequency measurement reporting criteria (10.3.7.39)	
-Parameters required for each event	1
-Intra-frequency event identity	Event 1G
-Triggering condition 2	Not Present
-Reporting Range Constant	Not Present
-Cells forbidden to affect Reporting Range	Not Present
-W	Not Present
-Hysteresis	0 dB
-Threshold used frequency	Not Present
-Reporting deactivation threshold	Not Present
-Replacement activation threshold	Not Present
-Time to trigger	0 ms
-Amount of reporting	Infinity
-Reporting interval	0 ms (Note 2)
-Reporting cell status	Not Present
<b>Physical channel information elements</b>	
-DPCH compressed mode status info (10.3.6.34)	Not Present

Information Element/Group name	Value/Remark
Note 1:	The SFN-CFN observed time difference is calculated from the OFF and Tm parameters contained in the IE "Cell synchronisation information", TS 25.331, clause 10.3.7.6. According to TS 25.331, 8.6.7.7, this IE is included in MEASUREMENT REPORT if IE "Cell synchronisation information reporting indicator" in IE "Cell reporting quantities" TS 25.331, clause 10.3.7.5 is set to TRUE in MEASUREMENT CONTROL.
Note 2:	Reporting interval = 0 ms means no periodical reporting



PHYSICAL CHANNEL RECONFIGURATION message (step 7):

Information Element	Value/Remark
Message Type	
<b>UE Information Elements</b>	
-RRC transaction identifier	0
-Integrity check info	Not Present
-Integrity protection mode info	Not Present
-Ciphering mode info	Not Present
-Activation time	At T3
-New U-RNTI	Not Present
-New C-RNTI	Not Present
-RRC State Indicator	CELL_DCH
-UTRAN DRX cycle length coefficient	Not Present
<b>CN Information Elements</b>	
-CN Information info	Not Present
<b>UTRAN mobility information elements</b>	
-URA identity	Not Present
<b>RB information elements</b>	
-Downlink counter synchronisation info	Not Present
-RB with PDCP information list	Not Present
-RB with PDCP information	Not Present
<b>PhyCH information elements</b>	
-Frequency info (10.3.6.36)	TDD
-CHOICE <i>mode</i>	Same UARFCN as used for cell 2
-UARFCN (Nt)	
<b>Uplink radio resources</b>	
-Maximum allowed UL TX power	30 dBm
-CHOICE <i>channel requirement</i>	Uplink DPCH info
-Uplink DPCH info (10.3.6.88)	
-Uplink DPCH power control info (10.3.6.91)	
-CHOICE <i>mode</i>	TDD
-TDD	1,28 Mcps TDD
-UL target SIR	Not Present
-CHOICE <i>UL OL PC info</i>	Individually signalled
-CHOICE <i>TDD option</i>	
--1,28 Mcps TDD	1
-TPC step size	1
-CHOICE <i>mode</i>	TDD
-Uplink timing advance control (10.3.6.96)	
-CHOICE <i>Timing Advance</i>	Disabled
-UL CCTrCH list	1
-UL Target SIR	9 dB
-Time Info (10.3.6.83)	
-Activation Time	now
-Duration	Infinite
-Common timeslot info	Not Present
-Uplink DPCH timeslots and codes (10.3.6.94)	
-Dynamic SF Usage	False
-First individual timeslot info (10.3.6.37)	
-Timeslot Number (10.3.6.84)	
-CHOICE <i>TDD option</i>	1,28 Mcps
-Timeslot number	2
-TFCl existence	True
-Midamble shift and burst type (10.3.6.41)	
-Choice <i>TDD option</i>	1,28 Mcps
-Midamble Allocation Mode	Default
-Midamble configuration	16
-Midamble shift	Not present
-CHOICE <i>TDD option</i>	1,28 Mcps
-Modulation	QPSK
-SS-TPC Symbols	
-Additional TPC-SS Symbols	
-First timeslot code list	1
-Channelisation code	8/1
-Choice more timeslots	No more timeslots
<b>Downlink radio resources</b>	
-CHOICE <i>mode</i>	TDD

Information Element	Value/Remark
-Downlink information common for all radio links (10.3.6.24)	
-Downlink DPCH info common for all RL (10.3.6.18)	
-Timing indicator	Initialise
-CFN-targetSFN frame offset	Not Present
-Downlink DPCH power control information (10.3.6.23)	
-CHOICE <i>mode</i>	TDD
-TPC Step size	1 dB
-CHOICE <i>mode</i>	TDD
-CHOICE <i>mode</i>	TDD
-CHOICE <i>TDD option</i>	1,28 Mcps
- <i>TSTD indicator</i> (10.3.6.85a)	TRUE
-Default DPCH Offset Value (10.3.6.16)	0
-Downlink information per radio link list	1
-Downlink information for each radio link (10.3.6.27)	
-CHOICE <i>mode</i>	TDD
-Primary CCPCH info (10.3.6.57)	
-CHOICE <i>mode</i>	TDD
-CHOICE <i>TDD option</i>	1,28 Mcps
<i>TSTD indicator</i>	TRUE
-Cell parameters ID	0
-SCTD indicator	False
-Downlink DPCH info for each RL (10.3.6.21)	
-CHOICE <i>mode</i>	TDD
-DL CCTrCH list	1
-TFCS ID	Not Present
-Time Info (10.3.6.83)	
-Activation Time	now
-Duration	Infinite
-Common timeslot info	Not Present
-Downlink DPCH timeslots and codes (10.3.6.32)	
-First individual timeslot info (10.3.6.37)	
-Timeslot Number (10.3.6.84)	
-CHOICE <i>TDD option</i>	1,28 Mcps
-Timeslot number	5
-TFCI existence	True
-Midamble shift and burst type (10.3.6.41)	
-CHOICE <i>TDD option</i>	1,28 Mcps
-Midamble Allocation Mode	Default
-Midamble configuration	16
-Midamble shift	Not present
-CHOICE <i>TDD option</i>	1,28 Mcps
-Modulation	QPSK
-SS-TPC Symbols	
-Additional TPC-SS Symbols	
-First timeslot channelisation codes (10.3.6.17)	
-CHOICE <i>codes representation</i>	Consecutive codes
-First channelisation code	16/1
-Last channelisation code	16/2
-CHOICE <i>more timeslots</i>	No more timeslots
-SCCPCH information for FACH (10.3.6.70)	Not Present

## MEASUREMENT REPORT message for Inter frequency test cases

This message is common for all inter frequency TDD test cases in clause 8.7 and is described in Annex I.

### 8.3.1A.2.2.5 Test requirements

For the test to pass, the total number of successful tests shall be more than 90% with a confidence level of 95% of the cases.

**NOTE:** If the above Test Requirement differs from the Minimum Requirement then the Test Tolerance applied for this test is non-zero. The Test Tolerance for this test is defined in clause F.2 and the explanation of how the Minimum Requirement has been relaxed by the Test Tolerance is given in clause F.4.

### 8.3.1A.3 Handover to inter-band cell

#### 8.3.1A.3.1 Scenario 1

This test case is applicable for UE handovers from primary frequency to the primary frequency in multi-band network.

##### 8.3.1A.3.1.1 Definition and applicability

Handover delay of the UE is defined as the time from the end of the last TTI containing an RRC message implying handover to the transmission of the SYNC-UL, including the RRC procedure delay as defined in [9].

The requirements and this test apply to all types of 1.28 Mcps TDD UE.

##### 8.3.1A.3.1.2 Minimum Requirements

The inter-frequency hard handover delay shall be less than 160 ms when the cell is known by the UE and the SFN of the target cell does not need to be decoded.

##### 8.3.1A.3.1.3 Test purpose

The purpose of this test is to verify that the hard handover success rate from primary frequency to primary frequency of the UE in CELL\_DCH state meets the requirements of the specifications. (Here, the handover success means that the handover delay meets the related requirements.)

##### 8.3.1A.3.1.4 Method of test

###### 8.3.1A.3.1.4.1 Initial conditions

Test environment: normal,; see clauses G.2.1 and G.2.2.

Frequencies to be tested: mid range; see clause G.2.4.

Cell condition: In cell 1, the primary frequency uses frequency b of band a, and the secondary frequency uses frequencies a and c. In cell 2, the primary frequency uses frequency e of band f, and the secondary frequency uses frequencies d and f.

Signal propagation condition: AWGN

Test instrument: Noise source

The test parameters are given in table1 and table2. In the measurement control information it is indicated to the UE that event-triggered reporting with Event 2C shall be used. The P-CCPCH RSCP and SFN-CFN observed time difference of the best cell on the unused frequency shall be reported together with Event 2C reporting. At the start of time duration T1, the UE may not have any timing information of cell 2.

UTRAN shall send a Physical Channel reconfiguration message with activation time "now" with a new active cell, cell 2. The Physical Channel reconfiguration message shall be sent to the UE during period T2, after the UE has reported event 2C. The starting point of T3 is defined as the end of the last TTI containing the physical channel reconfiguration message.

**Table 8.3.1A.3.1 General test parameters for TD-SCDMA/TD-SCDMA primary frequency -> primary frequency hard handover (cross frequency band)**

Parameter	Unit	Value	Remarks
DCH parameters		DL and UL Reference Measurement Channel 12.2 kbit/s	As specified in TS 25.102 clause A.2.2.2 and A.2.1.2
Power Control		On	
Target quality value on DTCH	BLER	0.01	
Initial conditions	Active cell	Cell 1	
	Neighbour cell	Cell 2	
Final condition	Active cell	Cell 2	
Threshold non-used frequency	dBm	-75	Threshold RSCP for Event 2C
O	dB	0	Cell individual offset. This value shall be used for all cells in the test.
Hysteresis	dB	0	
Time to Trigger	ms	0	
Filter coefficient		0	
Monitored cell list size		6 TD-SCDMA neighbours on Channel 1 6 TD-SCDMA neighbours on Channel 2	
T1	s	5	
T2	s	10	
T3	s	5	

**Table 8.3.1A.3.2 Cell specific test parameters for TD-SCDMA/TD-SCDMA primary frequency -> primary frequency hard handover (cross frequency band)**

Parameter	Unit	Cell 1								
		0			DwPTS			5		
Timeslot Number		T1	T2	T3	T1	T2	T3	T1	T2	T3
UTRA RF Channel Number (Note 2)		Channel 1								
PCCPCH_Ec/lor	dB	-3						n.a.		
DwPCH_Ec/lor					0					
DPCH_Ec/lor	dB	n.a.			n.a.			Note 1		n.a.
$\frac{DPCH_o - E_c}{I_{or}}$	dB	-3								
$\hat{I}_{or}/I_{oc}$	dB	3			3			3		
$I_{oc}$	dBm/1.28 MHz	-70								
PCCPCH_RSCP	dBm	-70			n.a.			n.a.		
Propagation Condition		AWGN								
Parameter	Unit	Cell 2								
Timeslot Number		0			DwPTS			5		
UTRA RF Channel Number (Note 2)		T1	T2	T3	T1	T2	T3	T1	T2	T3
UTRA RF Channel Number (Note 2)		Channel 2								
PCCPCH_Ec/lor	dB	-3						n.a.		
DwPCH_Ec/lor					0					
DPCH_Ec/lor	dB	n.a.			n.a.			n.a.		Note 1
$\frac{DPCH_o - E_c}{I_{or}}$	dB	-3								
$\hat{I}_{or}/I_{oc}$	dB	-Inf.	4		-Inf.	4		-Inf.		4
$I_{oc}$	dBm/1.28 MHz	-70								
PCCPCH_RSCP	dBm	-Inf.	-69		n.a.			n.a.		
Propagation Condition		AWGN								
Note 1: The DPCH level is controlled by the power control loop.										
Note 2: In the case of multi-frequency network, the UTRA RF Channel Number is the channel number of the primary frequency.										

#### 8.3.1A.3.1.4.2 Procedure

- 1) The RF parameters are set up according to T1.
- 2) The UE is switched on.
- 3) A call is set up according to the test procedure specified in 3GPP TS 34.108 [3] sub-clause 7.3.4.
- 4) SS shall transmit a MEASUREMENT CONTROL message.
- 5) After five seconds, the SS shall switch the power settings from T1 to T2.
- 6) UE shall transmit a MEASUREMENT REPORT message triggered by event 2C.
- 7) SS shall transmit a PHYSICAL CHANNEL RECONFIGURATION message with activation time "now".
- 8) After 10 seconds, the SS shall switch the power settings from T2 to T3.
- 9) If the UE transmits the SYNC-UL to cell 2 less than 160 ms from the beginning of time period T3, then the number of successful tests is increased by one. UE shall transmit a PHYSICAL CHANNEL RECONFIGURATION COMPLETE message on the UL DCCH of cell 2.
- 10) After five seconds, the UE is switched off. Any timing information of cell 2 is deleted in the UE.

11) Repeat steps 1 to 10 until the required confidence level is achieved.

All messages indicated above shall use the same content as described in the default message content in clause 9 of TS34.108 with the following exceptions:

## MEASUREMENT CONTROL message (step 4)

Information Element/Group Name	Value/Remark
Message Type (10.2.17)	
<b>UE information elements</b>	
-RRC transaction identifier	0
-Integrity check info	Not Present
Measurement Information elements	
-Measurement Identity	1
-Measurement Command (10.3.7.46)	Modify
-Measurement Reporting Mode (10.3.7.49)	
-Measurement Report Transfer Mode	AM RLC
-Periodical Reporting/Event Trigger Reporting Mode	Event trigger
-Additional measurements list (10.3.7.1)	Not Present
-CHOICE Measurement type	Inter-frequency measurement
-Inter-frequency measurement (10.3.7.16)	
-Inter-frequency measurement objects list (10.3.7.13)	Not Present
-Inter-frequency measurement quantity (10.3.7.18)	
-CHOICE reporting criteria	Inter-frequency reporting criteria
-Inter-frequency reporting criteria	
-Filter coefficient	0
-CHOICE mode	TD-SCDMA
-Measurement quantity for frequency quality estimate	Primary CCPCH RSCP
-Inter-frequency reporting quantity (10.3.7.21)	
-UTRA Carrier RSSI	FALSE
-Frequency quality estimate	FALSE
-Non frequency related cell reporting quantities (10.3.7.5)	
-SFN-SFN observed time difference reporting indicator	Type 1
-Cell synchronization information reporting indicator	TRUE
-Cell Identity reporting indicator	TRUE
-CHOICE mode	TD-SCDMA
-Timeslot ISCP reporting indicator	TRUE
-Proposed TGSN reporting required	FALSE
-Primary CCPCH RSCP reporting indicator	TRUE
-Pathloss reporting indicator	TRUE
-Reporting cell status (10.3.7.61)	
-CHOICE reported cell	Report cells within monitored set on non-used frequency
-Maximum number of reported cells per reported non-used frequency	1
-Measurement validity (10.3.7.51)	Not Present
-Inter-frequency set update (10.3.7.22)	Not Present
-CHOICE report criteria	Inter-frequency measurement reporting criteria
-Inter-frequency measurement reporting criteria (10.3.7.19)	
-Parameters required for each event	1
-Inter-frequency event identity (10.3.7.14)	Event 2C
-Threshold used frequency	Not Present
-W used frequency	Not Present
-Hysteresis	0 dB
-Time to trigger	0 ms
-Reporting cell status (10.3.7.61)	
-CHOICE reported cell	Report cells within monitored set on non-used frequency
-Maximum number of reported cells per reported non-used frequency	1
-Parameters required for each non-used frequency	1
-Threshold non-used frequency	-75 dBm
-W non-used frequency	1
<b>Physical channel information elements</b>	
-DPCH compressed mode status info (10.3.6.34)	Not Present

## PHYSICAL CHANNEL RECONFIGURATION message (step 7)

Information Element	Value/Remark
Message Type	
<b>UE Information Elements</b>	
-RRC transaction identifier	0
-Integrity check info	Not Present
-Integrity protection mode info	Not Present
-Ciphering mode info	Not Present
-Activation time	now
-New U-RNTI	Not Present
-New C-RNTI	Not Present
-RRC State Indicator	CELL_DCH
-UTRAN DRX cycle length coefficient	Not Present
<b>CN Information Elements</b>	
-CN Information info	Not Present
UTRAN mobility information elements	
-URA identity	Not Present
<b>RB information elements</b>	
-Downlink counter synchronization info	Not Present
-RB with PDCP information list	Not Present
-RB with PDCP information	Not Present
<b>PhyCH information elements</b>	
-Frequency info (10.3.6.36)	
-CHOICE mode	TD-SCDMA
-UARFCN (Nt)	Same UARFCN as used for cell 2
<b>Uplink radio resources</b>	
-Maximum allowed UL TX power	30 dBm
-CHOICE channel requirement	Uplink DPCH info
-Uplink DPCH info (10.3.6.88)	
-Uplink DPCH power control info (10.3.6.91)	
-CHOICE mode	TD-SCDMA
-CHOICE TD-SCDMA option	TD-SCDMA
-UL target SIR	-80 dBm
-CHOICE UL OL PC info	Individually signalled
-CHOICE TD-SCDMA option	TD-SCDMA
-TPC stepsize	1
- UL Timeslot Interference	-90 dBm
-CHOICE mode	TD-SCDMA
-Uplink timing advance control (10.3.6.96)	
- CHOICE Timing Advance	Enabled
- CHOICE TDD option	1.28 Mcps TDD
- Uplink synchronization parameters	
- Uplink synchronization step size	1
- Uplink synchronization frequency	1
- Synchronization parameters	
- SYNC_UL codes bitmap	01010101
- FPACH info	
- Timeslot number	0
- Channelisation code	16/15
- Midamble Shift and burst type	
- CHOICE TDD option	1.28 Mcps TDD
- Midamble Allocation Mode	Default midamble
- Midamble configuration	16
- WT	4
- PRXUpPCHdes	-80 dBm
- SYNC_UL procedure	
- Max SYNC_UL Transmissions	2
- Power Ramp Step	2
- Frequency info	Not present
- UpPCH position info	0
-CHOICE Timing Advance	Disabled
-UL CcTrCH list	1
-UL Target SIR	TBD dB



Information Element	Value/Remark
-Time Info (10.3.6.83)	
-Activation Time	T3
-Duration	Infinite
-Common timeslot info	Not Present
-Uplink DPCH timeslots and codes (10.3.6.94)	
-Dynamic SF Usage	False
-First individual timeslot info (10.3.6.37)	
-Timeslot Number (10.3.6.84)	
-CHOICE TD-SCDMA option	1.28 Mcps
-Timeslot number	2
-TFCI existence	True
-Midamble shift and burst type (10.3.6.41)	
-CHOICE TD-SCDMA option	1.28 Mcps
-Midamble Allocation Mode	Default
-Midamble configuration	16
-Midamble shift	Not present
-CHOICE TD-SCDMA option	1.28 Mcps
-Modulation	QPSK
- SS-TPC Symbols	
-Additional TPC-SS Symbols	
-First timeslot code list	1
-Channelisation code	8/1
-CHOICE more timeslots	No more timeslots
<b>Downlink radio resources</b>	
-CHOICE mode	TD-SCDMA
-Downlink information common for all radio links (10.3.6.24)	
-Downlink DPCH info common for all RL (10.3.6.18)	
-Timing indicator	Initialise
-CFN-targetSFN frame offset	Not Present
-Downlink DPCH power control information (10.3.6.23)	
-CHOICE mode	TD-SCDMA
-TPC Step size	1 dB
-CHOICE mode	TD-SCDMA
-CHOICE mode	TD-SCDMA
-CHOICE TD-SCDMA option	1.28 Mcps
-tstd_indicator	FALSE
-Default DPCH Offset Value (10.3.6.16)	0
-Downlink information per radio link list	1
-Downlink information for each radio link (10.3.6.27)	
-CHOICE mode	TD-SCDMA
-Primary CCPCH info (10.3.6.57)	
- CHOICE mode	TD-SCDMA
- CHOICE TD-SCDMA option	1.28 Mcps
TSTD indicator	TRUE
- Cell parameters ID	0
- SCTD indicator	False
-Downlink DPCH info for each RL (10.3.6.21)	
-CHOICE mode	TD-SCDMA
- DL CCTrCH list	1
-TFCS ID	Not Present
-Time Info (10.3.6.83)	
-Activation Time	now
-Duration	Infinite
-Common timeslot info	Not Present
- Downlink DPCH timeslots and codes (10.3.6.32)	
- First individual timeslot info (10.3.6.37)	
- Timeslot Number (10.3.6.84)	
- CHOICE TD-SCDMA option	1.28 Mcps
- Timeslot number	5
- TFCI existence	True
- Midamble shift and burst type (10.3.6.41)	
- CHOICE TD-SCDMA option	1.28 Mcps
- Midamble Allocation Mode	Default

Information Element	Value/Remark
- Midamble configuration	16
- Midamble shift	Not present
- CHOICE TD-SCDMA option	1.28 Mcps
- First timeslot channelisation codes (10.3.6.17)	
-Modulation	QPSK
-SS-TPC Symbols	
-Additional TPC-SS Symbols	
- CHOICE codes representation	Consecutive codes
- First channelisation code	16/1
- Last channelisation code	16/2
- CHOICE more timeslots	No more timeslots
- SCCPCH information for FACH (10.3.6.70)	Not Present

### 8.3.1A.3.1.5 Test requirements

The inter-frequency hard handover delay shall be less than 160 ms when the cell is known by the UE and the SFN of the target cell does not need to be decoded (see the Note). The rate of correct handovers observed during repeated tests shall be at least 90% with a confidence level of 95%.

NOTE: For the target cell and original cell, the SFNs are the same, but the DOFFs are different; therefore, the CFNs are different.

### 8.3.1A.3.2 Scenario 2

This test case is applicable for UE handovers from primary frequency to the secondary frequency in multi-band network.

#### 8.3.1A.3.2.1 Definition and applicability

Handover delay of the UE is defined as the time from the end of the last TTI containing an RRC message implying hard handover to the transmission of the new uplink DPCH or the SYNC-UL in case that a handover with SYNCH uplink exchange is recommended, including the RRC procedure delay as defined in [9].

The requirements and this test apply to the UTRA TDD UE 1,28 Mcps option.

#### 8.3.1A.3.2.2 Minimum requirement

The handover delay shall be less than 160ms when the cell is known by the UE and the SFN of the target cell dose not need to be decoded. The rate of correct handovers observed during repeated tests shall be at least 90%.

The normative reference for this requirement is TS 25.123 [2] clauses 5.1.2 and A.5.1.2.

#### 8.3.1A.3.2.3 Test purpose

The purpose of this test is to verify the requirement for the inter-band handover delay in CELL\_DCH state.

#### 8.3.1A.3.2.4 Method of test

##### 8.3.1A.3.2.4.1 Initial conditions

Test environment: normal; see clauses G.2.1 and G.2.2.

Frequencies to be tested: mid range; see clause G.2.4.

Cell condition: In cell 1, the primary frequency and the secondary frequencies are in band a. In cell 2, the primary frequency uses band a and the secondary frequencies are in band f.

Signal propagation condition: AWGN.

Test instrument: Noise source.

The test parameters are given in table 8.3.1A.3.2.1 and 8.3.1A.3.2.2. In the measurement control information it is indicated to the UE that event-triggered reporting with Event 2C shall be used. The PCCPCH RSCP and SFN-CFN

observed time difference of the best cell on the unused frequency shall be reported together with Event 2C reporting. At the start of time duration T1, the UE may not have any timing information of cell 2.

UTRAN shall send a Physical Channel reconfiguration message with activation time "now" with one active cell, cell 2. The Physical Channel reconfiguration message shall be sent to the UE during period T2, after the UE has reported event 2C, The starting point of T3 is defined as the end of the last TTI containing the physical channel reconfiguration message.

**Table 8.3.1A.3.2.1: General test parameters for Handover to inter-band cell**

Parameter		Unit	Value	Comment
DCH parameters			DL and UL Reference Measurement Channel 12.2 kbps	As specified in TS 25.102 clause A.2.2.2 and A.2.1.2
Power Control			On	
Target quality value on DTCH		BLER	0.01	
Initial conditions	Active cell		Cell 1	In the case of multi-band network, the UE has a RRC connection on the primary frequency in cell 1.
	Neighbour cell		Cell 2	
Final condition	Active cell		Cell 2	In the case of multi-band network, the UE will handover to the secondary frequency in cell 2.
Threshold non-used frequency		dBm	-75	Threshold RSCP for Event 2C
O		dB	0	Cell individual offset. This value shall be used for all cells in the test.
Hysteresis		dB	0	
Time to Trigger		ms	0	
Filter coefficient			0	
Monitored cell list size			6 TDD neighbours on Channel 1 6 TDD neighbours on Channel 2	
T1		s	5	
T2		s	10	
T3		s	5	

Table 8.3.1A.3.2.2: Cell Specific parameters for Handover to inter-band cell

Parameter	Unit	Cell 1								
		0			DwPTS			5		
Timeslot Number		T1	T2	T3	T1	T2	T3	T1	T2	T3
UTRA RF Channel Number(Note 3)		Channel 1								
PCCPCH_Ec/lor	dB	-3						n.a.		
DwPCH_Ec/lor					0					
DPCH_Ec/lor	dB	n.a.			n.a.			Note1	n.a.	
OCNS_Ec/lor	dB	-3						Note2		
$\hat{I}_{or}/I_{oc}$	dB	3			3			3		
$I_{oc}$	dBm/1, 28 MHz	-70								
PCCPCH_RSCP	dBm	-70			n.a.			n.a.		
Propagation Condition		AWGN								
Parameter	Unit	Cell 2								
Timeslot Number		0			DwPTS			5		
Timeslot Number		T1	T2	T3	T1	T2	T3	T1	T2	T3
UTRA RF Channel Number(Note 3)		Channel 1								
UTRA RF Channel Number(Note 4)		Channel 2								
PCCPCH_Ec/lor	dB	-3						n.a.		
DwPCH_Ec/lor					0					
DPCH_Ec/lor	dB	n.a.			n.a.			n.a.	Note 1	
OCNS_Ec/lor	dB	-3						Note2		
$\hat{I}_{or}/I_{oc}$	dB	-Inf.	6		-Inf.	6		-Inf.	6	
$I_{oc}$	dBm/1, 28 MHz	-70								
PCCPCH_RSCP	dBm	-Inf.	-67		n.a.			n.a.		
Propagation Condition		AWGN								
Note 1: The DPCH level is controlled by the power control loop										
Note 2: The power of the OCNS channel that is added shall make the total power from the cell to be equal to $I_{or}$ .										

## 8.3.1A.3.2.4.2 Procedure

- 1) The RF parameters are set up according to T1.
- 2) The UE is switched on.
- 3) A call is set up according to the test procedure specified in TS 34.108 [3] subclause 7.3.4.
- 4) SS shall transmit a MEASUREMENT CONTROL message.
- 5) After 5 seconds, the SS shall switch the power settings from T1 to T2.
- 6) UE shall transmit a MEASUREMENT REPORT message triggered by event 2C.
- 7) SS shall transmit a PHYSICAL CHANNEL RECONFIGURATION message with activation time "now".
- 8) After 10 seconds, the SS shall switch the power settings from T2 to T3
- 9) If the UE transmits the UL DPCH to cell 2 less than 160 ms from the beginning of time period T3 then the number of successful tests is increased by one. UE shall transmit a PHYSICAL CHANNEL RECONFIGURATION COMPLETE message on the UL DCCH of cell 2.
- 10) After 5 seconds, the UE is switched off. Any timing information of cell 2 is deleted in the UE.
- 11) Repeat steps 1-10 until the confidence level according to annex F.6.2 is achieved.

## Specific Message Contents

All messages indicated above shall use the same content as described in the default message content in clause 9 of 34.108 [3] with the following exceptions:

MEASUREMENT CONTROL message (step 4):

Information Element/Group name	Value/Remark
Message Type (10.2.17)	
<b>UE information elements</b> -RRC transaction identifier -Integrity check info	0 Not Present
<b>Measurement Information elements</b> -Measurement Identity -Measurement Command (10.3.7.46) -Measurement Reporting Mode (10.3.7.49) -Measurement Report Transfer Mode -Periodical Reporting / Event Trigger Reporting Mode -Additional measurements list (10.3.7.1)	1 Modify AM RLC Event trigger Not Present
-CHOICE <i>Measurement type</i> -Inter-frequency measurement (10.3.7.16) -Inter-frequency measurement objects list (10.3.7.13) -Inter-frequency measurement quantity (10.3.7.18) -CHOICE <i>reporting criteria</i> -Inter-frequency reporting criteria -Filter coefficient -CHOICE <i>mode</i> -Measurement quantity for frequency quality estimate	Inter-frequency measurement Not Present Inter-frequency reporting criteria 0 TDD Primary CCPCH RSCP
-Inter-frequency reporting quantity (10.3.7.21) -UTRA Carrier RSSI -Frequency quality estimate -Non frequency related cell reporting quantities (10.3.7.5) -SFN-SFN observed time difference reporting indicator -Cell synchronisation information reporting indicator -Cell Identity reporting indicator -CHOICE <i>mode</i> -Timeslot ISCP reporting indicator -Proposed TGSN reporting required -Primary CCPCH RSCP reporting indicator -Pathloss reporting indicator	FALSE FALSE Type 1 TRUE TRUE TDD TRUE FALSE TRUE TRUE
-Reporting cell status (10.3.7.61) -CHOICE <i>reported cell</i>  -Maximum number of reported cells per reported non-used frequency -Measurement validity (10.3.7.51) -Inter-frequency set update (10.3.7.22) -CHOICE <i>report criteria</i>	Report cells within monitored set on non-used frequency 1 Not Present Not Present Inter-frequency measurement reporting criteria
-Inter-frequency measurement reporting criteria (10.3.7.19) -Parameters required for each event -Inter-frequency event identity (10.3.7.14) -Threshold used frequency -W used frequency -Hysteresis -Time to trigger -Reporting cell status (10.3.7.61) -CHOICE <i>reported cell</i>  -Maximum number of reported cells per reported non-used frequency -Parameters required for each non-used frequency -Threshold non-used frequency -W non-used frequency	1 Event 2C Not Present Not Present 0 dB 0 ms Report cells within monitored set on non-used frequency 1 1 -75 dBm 1
<b>Physical channel information elements</b> -DPCH compressed mode status info (10.3.6.34)	Not Present

## PHYSICAL CHANNEL RECONFIGURATION message (step 7):

Information Element	Value/Remark
Message Type	
<b>UE Information Elements</b>	
-RRC transaction identifier	0
-Integrity check info	Not Present
-Integrity protection mode info	Not Present
-Ciphering mode info	Not Present
-Activation time	Now
-New U-RNTI	Not Present
-New C-RNTI	Not Present
-RRC State Indicator	CELL_DCH
-UTRAN DRX cycle length coefficient	Not Present
<b>CN Information Elements</b>	
-CN Information info	Not Present
<b>UTRAN mobility information elements</b>	
-URA identity	Not Present
<b>RB information elements</b>	
-Downlink counter synchronisation info	Not Present
-RB with PDCP information list	Not Present
-RB with PDCP information	Not Present
<b>PhyCH information elements</b>	
-Frequency info (10.3.6.36)	TDD
-CHOICE <i>mode</i>	Same UARFCN as used for cell 2
-UARFCN (Nt)	
<b>Uplink radio resources</b>	
-Maximum allowed UL TX power	30 dBm
-CHOICE <i>channel requirement</i>	Uplink DPCH info
-Uplink DPCH info (10.3.6.88)	
-Uplink DPCH power control info (10.3.6.91)	
-CHOICE <i>mode</i>	TDD
-TDD	1,28 Mcps TDD
-UL target SIR	Not Present
-CHOICE <i>UL OL PC info</i>	Individually signalled
-CHOICE <i>TDD option</i>	
--1,28 Mcps TDD	1
-TPC step size	1
-CHOICE <i>mode</i>	TDD
-Uplink timing advance control (10.3.6.96)	
-CHOICE <i>Timing Advance</i>	Disabled
-UL CCTrCH list	1
-UL Target SIR	9 dB
-Time Info (10.3.6.83)	
-Activation Time	now
-Duration	Infinite
-Common timeslot info	Not Present
-Uplink DPCH timeslots and codes (10.3.6.94)	
-Dynamic SF Usage	False
-First individual timeslot info (10.3.6.37)	
-Timeslot Number (10.3.6.84)	
-CHOICE <i>TDD option</i>	1,28 Mcps
-Timeslot number	2
-TFCl existence	True
-Midamble shift and burst type (10.3.6.41)	
-Choice <i>TDD option</i>	1,28 Mcps
-Midamble Allocation Mode	Default
-Midamble configuration	16
-Midamble shift	Not present
-CHOICE <i>TDD option</i>	1,28 Mcps
-Modulation	QPSK
-SS-TPC Symbols	
-Additional TPC-SS Symbols	
-First timeslot code list	1
-Channelisation code	8/1
-Choice more timeslots	No more timeslots
<b>Downlink radio resources</b>	
-CHOICE <i>mode</i>	TDD

Information Element	Value/Remark
-Downlink information common for all radio links (10.3.6.24)	
-Downlink DPCH info common for all RL (10.3.6.18)	
-Timing indicator	Initialise
-CFN-targetSFN frame offset	Not Present
-Downlink DPCH power control information (10.3.6.23)	
-CHOICE <i>mode</i>	TDD
-TPC Step size	1 dB
-CHOICE <i>mode</i>	TDD
-CHOICE <i>mode</i>	TDD
-CHOICE <i>TDD option</i>	1,28 Mcps
- <i>TSTD indicator</i> (10.3.6.85a)	FALSE
-Default DPCH Offset Value (10.3.6.16)	0
-Downlink information per radio link list	1
-Downlink information for each radio link (10.3.6.27)	
-CHOICE <i>mode</i>	TDD
-Primary CCPCH info (10.3.6.57)	
-CHOICE <i>mode</i>	TDD
-CHOICE <i>TDD option</i>	1,28 Mcps
<i>TSTD indicator</i>	TRUE
-Cell parameters ID	0
-SCTD indicator	False
-Downlink DPCH info for each RL (10.3.6.21)	
-CHOICE <i>mode</i>	TDD
-DL CCTrCH list	1
-TFCS ID	Not Present
-Time Info (10.3.6.83)	
-Activation Time	now
-Duration	Infinite
-Common timeslot info	Not Present
-Downlink DPCH timeslots and codes (10.3.6.32)	
-First individual timeslot info (10.3.6.37)	
-Timeslot Number (10.3.6.84)	
-CHOICE <i>TDD option</i>	1,28 Mcps
-Timeslot number	5
-TFCI existence	True
-Midamble shift and burst type (10.3.6.41)	
-CHOICE <i>TDD option</i>	1,28 Mcps
-Midamble Allocation Mode	Default
-Midamble configuration	16
-Midamble shift	Not present
-CHOICE <i>TDD option</i>	1,28 Mcps
-Modulation	QPSK
-SS-TPC Symbols	
-Additional TPC-SS Symbols	
-First timeslot channelisation codes (10.3.6.17)	
-CHOICE <i>codes representation</i>	Consecutive codes
-First channelisation code	16/1
-Last channelisation code	16/2
-CHOICE <i>more timeslots</i>	No more timeslots
-SCCPCH information for FACH (10.3.6.70)	Not Present

## MEASUREMENT REPORT message for Inter frequency test cases

This message is common for all inter frequency TDD test cases in clause 8.7 and is described in Annex I.

### 8.3.1A.3.2.5 Test requirements

The inter-band handover delay shall be less than 160 ms when the cell is known by the UE and the SFN of the target cell does not need to be decoded. For the test to pass, the total number of successful tests shall be more than 90% with a confidence level of 95% of the cases.

NOTE: If the above Test Requirement differs from the Minimum Requirement then the Test Tolerance applied for this test is non-zero. The Test Tolerance for this test is defined in clause F.2 and the explanation of how the Minimum Requirement has been relaxed by the Test Tolerance is given in clause F.4.

### 8.3.1A.3.3 Scenario 3

This test case is applicable for UE handovers from secondary frequency to secondary frequency in multi-band network.

#### 8.3.1A.3.3.1 Definition and applicability

Handover delay of the UE is defined as the time from the end of the last TTI containing an RRC message implying hard handover to the transmission of the new uplink DPCH or the SYNC-UL in case that a handover with SYNCH uplink exchange is recommended, including the RRC procedure delay as defined in [9].

The requirements and this test apply to the UTRA TDD UE 1,28 Mcps option.

#### 8.3.1A.3.3.2 Minimum requirement

The handover delay shall be less than 160ms when the cell is known by the UE and the SFN of the target cell does not need to be decoded. The rate of correct handovers observed during repeated tests shall be at least 90%.

The normative reference for this requirement is TS 25.123 [2] clauses 5.1.2 and A.5.1.2.

#### 8.3.1A.3.3.3 Test purpose

The purpose of this test is to verify the requirement for the inter-band handover delay in CELL\_DCH state.

#### 8.3.1A.3.3.4 Method of test

##### 8.3.1A.3.3.4.1 Initial conditions

Test environment: normal; see clauses G.2.1 and G.2.2.

Frequencies to be tested: mid range; see clause G.2.4.

Cell condition: In cell 1, the primary frequency uses band a and the secondary frequencies are in band f. In cell 2, the primary frequency and the secondary frequencies are in band a.

Signal propagation condition: AWGN.

Test instrument: Noise source.

The test parameters are given in table 8.3.1A.3.3.1 and 8.3.1A.3.3.2. In the measurement control information it is indicated to the UE that event-triggered reporting with Event 2C shall be used. The PCCPCH RSCP and SFN-CFN observed time difference of the best cell on the unused frequency shall be reported together with Event 2C reporting. At the start of time duration T1, the UE may not have any timing information of cell 2.

UTRAN shall send a Physical Channel reconfiguration message with activation time "now" with one active cell, cell 2. The Physical Channel reconfiguration message shall be sent to the UE during period T2, after the UE has reported event 2C, The starting point of T3 is defined as the end of the last TTI containing the physical channel reconfiguration message.

**Table 8.3.1A.3.3.1: General test parameters for Handover to inter-band cell**

Parameter	Unit	Value	Comment
DCH parameters		DL and UL Reference Measurement Channel 12.2 kbps	As specified in TS 25.102 clause A.2.2.2 and A.2.1.2
Power Control		On	
Target quality value on DTCH	BLER	0.01	
Initial conditions	Active cell	Cell 1	In the case of multi-band network, the UE has a RRC connection on the primary frequency in cell 1.
	Neighbour cell	Cell 2	



Final condition	Active cell		Cell 2	In the case of multi-band network, the UE will handover to the secondary frequency in cell 2.
Threshold non-used frequency		dBm	-75	Threshold RSCP for Event 2C
O		dB	0	Cell individual offset. This value shall be used for all cells in the test.
Hysteresis		dB	0	
Time to Trigger		ms	0	
Filter coefficient			0	
Monitored cell list size			6 TDD neighbours on Channel 1 6 TDD neighbours on Channel 2	
T1		s	5	
T2		s	10	
T3		s	5	

**Table 8.3.1A.3.3.2: Cell Specific parameters for Handover to inter-band cell**

Parameter	Unit	Cell 1								
		0			DwPTS			5		
Timeslot Number		T1	T2	T3	T1	T2	T3	T1	T2	T3
UTRA RF Channel Number(Note 3)		Channel 1								
PCCPCH_Ec/lor	dB	-3						n.a.		
DwPCH_Ec/lor					0					
DPCH_Ec/lor	dB	n.a.			n.a.			Note1	n.a.	
OCNS_Ec/lor	dB	-3						Note2		
$\hat{I}_{or}/I_{oc}$	dB	3			3			3		
$I_{oc}$	dBm/1, 28 MHz	-70								
PCCPCH_RSCP	dBm	-70			n.a.			n.a.		
Propagation Condition		AWGN								
Parameter	Unit	Cell 2								
Timeslot Number		0			DwPTS			5		
Timeslot Number		T1	T2	T3	T1	T2	T3	T1	T2	T3
UTRA RF Channel Number(Note 3)		Channel 1								
UTRA RF Channel Number(Note 4)		Channel 2								
PCCPCH_Ec/lor	dB	-3						n.a.		
DwPCH_Ec/lor					0					
DPCH_Ec/lor	dB	n.a.			n.a.			n.a.	Note 1	
OCNS_Ec/lor	dB	-3						Note2		
$\hat{I}_{or}/I_{oc}$	dB	-Inf.	6		-Inf.	6		-Inf.	6	
$I_{oc}$	dBm/1, 28 MHz	-70								
PCCPCH_RSCP	dBm	-Inf.	-67		n.a.			n.a.		
Propagation Condition		AWGN								
Note 1:	The DPCH level is controlled by the power control loop									
Note 2:	The power of the OCNS channel that is added shall make the total power from the cell to be equal to $I_{or}$ .									

8.3.1A.3.3.4.2 Procedure

- 1) The RF parameters are set up according to T1.
- 2) The UE is switched on.
- 3) A call is set up according to the test procedure specified in TS 34.108 [3] subclause 7.3.4.

- 4) SS shall transmit a MEASUREMENT CONTROL message.
- 5) After 5 seconds, the SS shall switch the power settings from T1 to T2.
- 6) UE shall transmit a MEASUREMENT REPORT message triggered by event 2C.
- 7) SS shall transmit a PHYSICAL CHANNEL RECONFIGURATION message with activation time "now".
- 8) After 10 seconds, the SS shall switch the power settings from T2 to T3
- 9) If the UE transmits the UL DPCH to cell 2 less than 160 ms from the beginning of time period T3 then the number of successful tests is increased by one. UE shall transmit a PHYSICAL CHANNEL RECONFIGURATION COMPLETE message on the UL DCCH of cell 2.
- 10) After 5 seconds, the UE is switched off. Any timing information of cell 2 is deleted in the UE.
- 11) Repeat steps 1-10 until the confidence level according to annex F.6.2 is achieved.

#### Specific Message Contents

All messages indicated above shall use the same content as described in the default message content in clause 9 of 34.108 [3] with the following exceptions:

MEASUREMENT CONTROL message (step 4):

Information Element/Group name	Value/Remark
Message Type (10.2.17)	
<b>UE information elements</b> -RRC transaction identifier -Integrity check info	0 Not Present
<b>Measurement Information elements</b> -Measurement Identity -Measurement Command (10.3.7.46) -Measurement Reporting Mode (10.3.7.49) -Measurement Report Transfer Mode -Periodical Reporting / Event Trigger Reporting Mode -Additional measurements list (10.3.7.1)	1 Modify  AM RLC Event trigger Not Present
-CHOICE <i>Measurement type</i> -Inter-frequency measurement (10.3.7.16) -Inter-frequency measurement objects list (10.3.7.13) -Inter-frequency measurement quantity (10.3.7.18) -CHOICE <i>reporting criteria</i> -Inter-frequency reporting criteria -Filter coefficient -CHOICE <i>mode</i> -Measurement quantity for frequency quality estimate	Inter-frequency measurement  Not Present  Inter-frequency reporting criteria  0 TDD Primary CCPCH RSCP
-Inter-frequency reporting quantity (10.3.7.21) -UTRA Carrier RSSI -Frequency quality estimate -Non frequency related cell reporting quantities (10.3.7.5) -SFN-SFN observed time difference reporting indicator -Cell synchronisation information reporting indicator -Cell Identity reporting indicator -CHOICE <i>mode</i> -Timeslot ISCP reporting indicator -Proposed TGSN reporting required -Primary CCPCH RSCP reporting indicator -Pathloss reporting indicator	FALSE FALSE  Type 1 TRUE TRUE TDD TRUE FALSE TRUE TRUE
-Reporting cell status (10.3.7.61) -CHOICE <i>reported cell</i>  -Maximum number of reported cells per reported non-used frequency -Measurement validity (10.3.7.51) -Inter-frequency set update (10.3.7.22) -CHOICE <i>report criteria</i>	Report cells within monitored set on non-used frequency  1  Not Present Not Present Inter-frequency measurement reporting criteria
-Inter-frequency measurement reporting criteria (10.3.7.19) -Parameters required for each event -Inter-frequency event identity (10.3.7.14) -Threshold used frequency -W used frequency -Hysteresis -Time to trigger -Reporting cell status (10.3.7.61) -CHOICE <i>reported cell</i>  -Maximum number of reported cells per reported non-used frequency -Parameters required for each non-used frequency -Threshold non-used frequency -W non-used frequency	1 Event 2C Not Present Not Present 0 dB 0 ms  Report cells within monitored set on non-used frequency 1  1 -75 dBm 1
<b>Physical channel information elements</b> -DPCH compressed mode status info (10.3.6.34)	Not Present

## PHYSICAL CHANNEL RECONFIGURATION message (step 7):

Information Element	Value/Remark
Message Type	
<b>UE Information Elements</b>	
-RRC transaction identifier	0
-Integrity check info	Not Present
-Integrity protection mode info	Not Present
-Ciphering mode info	Not Present
-Activation time	Now
-New U-RNTI	Not Present
-New C-RNTI	Not Present
-RRC State Indicator	CELL_DCH
-UTRAN DRX cycle length coefficient	Not Present
<b>CN Information Elements</b>	
-CN Information info	Not Present
<b>UTRAN mobility information elements</b>	
-URA identity	Not Present
<b>RB information elements</b>	
-Downlink counter synchronisation info	Not Present
-RB with PDCP information list	Not Present
-RB with PDCP information	Not Present
<b>PhyCH information elements</b>	
-Frequency info (10.3.6.36)	TDD
-CHOICE <i>mode</i>	Same UARFCN as used for cell 2
-UARFCN (Nt)	
<b>Uplink radio resources</b>	
-Maximum allowed UL TX power	30 dBm
-CHOICE <i>channel requirement</i>	Uplink DPCH info
-Uplink DPCH info (10.3.6.88)	
-Uplink DPCH power control info (10.3.6.91)	
-CHOICE <i>mode</i>	TDD
-TDD	1,28 Mcps TDD
-UL target SIR	Not Present
-CHOICE <i>UL OL PC info</i>	Individually signalled
-CHOICE <i>TDD option</i>	
--1,28 Mcps TDD	1
-TPC step size	1
-CHOICE <i>mode</i>	TDD
-Uplink timing advance control (10.3.6.96)	
-CHOICE <i>Timing Advance</i>	Disabled
-UL CCTrCH list	1
-UL Target SIR	9 dB
-Time Info (10.3.6.83)	
-Activation Time	now
-Duration	Infinite
-Common timeslot info	Not Present
-Uplink DPCH timeslots and codes (10.3.6.94)	
-Dynamic SF Usage	False
-First individual timeslot info (10.3.6.37)	
-Timeslot Number (10.3.6.84)	
-CHOICE <i>TDD option</i>	1,28 Mcps
-Timeslot number	2
-TFCl existence	True
-Midamble shift and burst type (10.3.6.41)	
-Choice <i>TDD option</i>	1,28 Mcps
-Midamble Allocation Mode	Default
-Midamble configuration	16
-Midamble shift	Not present
-CHOICE <i>TDD option</i>	1,28 Mcps
-Modulation	QPSK
-SS-TPC Symbols	
-Additional TPC-SS Symbols	
-First timeslot code list	1
-Channelisation code	8/1
-Choice more timeslots	No more timeslots
<b>Downlink radio resources</b>	
-CHOICE <i>mode</i>	TDD

Information Element	Value/Remark
-Downlink information common for all radio links (10.3.6.24)	
-Downlink DPCH info common for all RL (10.3.6.18)	
-Timing indicator	Initialise
-CFN-targetSFN frame offset	Not Present
-Downlink DPCH power control information (10.3.6.23)	
-CHOICE <i>mode</i>	TDD
-TPC Step size	1 dB
-CHOICE <i>mode</i>	TDD
-CHOICE <i>mode</i>	TDD
-CHOICE <i>TDD option</i>	1,28 Mcps
- <i>TSTD indicator</i> (10.3.6.85a)	FALSE
-Default DPCH Offset Value (10.3.6.16)	0
-Downlink information per radio link list	1
-Downlink information for each radio link (10.3.6.27)	
-CHOICE <i>mode</i>	TDD
-Primary CCPCH info (10.3.6.57)	
-CHOICE <i>mode</i>	TDD
-CHOICE <i>TDD option</i>	1,28 Mcps
<i>TSTD indicator</i>	TRUE
-Cell parameters ID	0
-SCTD indicator	False
-Downlink DPCH info for each RL (10.3.6.21)	
-CHOICE <i>mode</i>	TDD
-DL CCTrCH list	1
-TFCS ID	Not Present
-Time Info (10.3.6.83)	
-Activation Time	now
-Duration	Infinite
-Common timeslot info	Not Present
-Downlink DPCH timeslots and codes (10.3.6.32)	
-First individual timeslot info (10.3.6.37)	
-Timeslot Number (10.3.6.84)	
-CHOICE <i>TDD option</i>	1,28 Mcps
-Timeslot number	5
-TFCI existence	True
-Midamble shift and burst type (10.3.6.41)	
-CHOICE <i>TDD option</i>	1,28 Mcps
-Midamble Allocation Mode	Default
-Midamble configuration	16
-Midamble shift	Not present
-CHOICE <i>TDD option</i>	1,28 Mcps
-Modulation	QPSK
-SS-TPC Symbols	
-Additional TPC-SS Symbols	
-First timeslot channelisation codes (10.3.6.17)	
-CHOICE <i>codes representation</i>	Consecutive codes
-First channelisation code	16/1
-Last channelisation code	16/2
-CHOICE <i>more timeslots</i>	No more timeslots
-SCCPCH information for FACH (10.3.6.70)	Not Present

## MEASUREMENT REPORT message for Inter frequency test cases

This message is common for all inter frequency TDD test cases in clause 8.7 and is described in Annex I.

### 8.3.1A.3.3.5 Test requirements

The inter-band handover delay shall be less than 160 ms when the cell is known by the UE and the SFN of the target cell does not need to be decoded. For the test to pass, the total number of successful tests shall be more than 90% with a confidence level of 95% of the cases.

NOTE: If the above Test Requirement differs from the Minimum Requirement then the Test Tolerance applied for this test is non-zero. The Test Tolerance for this test is defined in clause F.2 and the explanation of how the Minimum Requirement has been relaxed by the Test Tolerance is given in clause F.4.

## 8.3.1B TDD/TDD Handover for 7,68 Mcps Option

### 8.3.1B.1 Handover to intra-frequency cell

#### 8.3.1B.1.1 Definition and applicability

Handover interruption time is defined as the time between the end of the last TTI containing a transport block on the old DPCH and the time the UE starts transmission of the new uplink DPCH.

The requirements and this test apply to the UTRA TDD UE 7,68 Mcps option.

#### 8.3.1B.1.2 Minimum requirement

The interruption time shall be less than 40 ms in the single carrier case when the cell is known by the UE and the SFN of the target cell does not need to be decoded. The rate of correct handovers observed during repeated tests shall be at least 90% with a confidence level of 95%.

The interruption time is dependent on whether the target cell is known for the UE or not.

If TDD/TDD intra-frequency handover is commanded, the interruption time shall be less than,

$$T_{\text{interrupt}} = T_{\text{offset}} + T_{\text{UL}} + 30 * F_{\text{SFN}} + 20 * \text{KC} + 180 * \text{UC} \text{ ms}$$

where,

$T_{\text{offset}}$	Equal to 10 ms, the frame timing uncertainty between the old cell and the target cell and the time that can elapse until the appearance of a Beacon channel
$T_{\text{UL}}$	Equal to 10 ms, the time that can elapse until the appearance of the UL timeslot in the target cell
$F_{\text{SFN}}$	Equal to 1 if SFN decoding is required and equal to 0 otherwise
KC	Equal to 1 if a known target cell is indicated in the RRC message implying TDD/TDD handover and equal to 0 otherwise
UC	Equal to 1 if an unknown target cell is indicated in the RRC message implying TDD/TDD handover and equal to 0 otherwise

An intra-frequency TDD target cell shall be considered as known by the UE, if either or both of the following conditions are true:

- the target cell has been measured during the last 5 seconds
- the UE has had a radio link connected to the target cell during the last 5 seconds.

The interruption time requirements for an unknown target cell shall apply only if the signal quality of the unknown target cell is sufficient for successful synchronisation with one attempt.

The normative reference for this requirement is TS 25.123 [2] clauses 5.1.2 and A.5.1.3.

#### 8.3.1B.1.3 Test purpose

The purpose of this test is to verify the requirement for the intra-frequency handover delay in CELL\_DCH state in the single carrier case.

#### 8.3.1B.1.4 Method of test

##### 8.3.1B.1.4.1 Initial conditions

Test environment: normal; see clauses G.2.1 and G.2.2.

Frequencies to be tested: mid range; see clause G.2.4.

The test parameters are given in table 8.3.1B.1.1 and 8.3.1B.1.2. In the measurement control information it is indicated to the UE that event-triggered reporting with Event 1G shall be used, and that P-CCPCH RSCP and SFN-CFN observed timed difference shall be reported together with Event 1G. The test consists of three successive time periods, with a

time duration of T1, T2 and T3 respectively. At the start of time duration T1, the UE may not have any timing information of cell 2.

UTRAN shall send a Physical Channel reconfiguration message with activation time at the beginning of T3 with a new active cell, cell 2. The Physical Channel reconfiguration message shall be sent to the UE such that the delay between the end of the last received TTI containing the message and the beginning of T3 is at least equal to the RRC procedure delay as defined in [16].

The second Beacon timeslot shall be provided in timeslot 8 for both cell 1 and cell 2. The UL DPCH shall be transmitted in timeslot 12.

**Table 8.3.1B.1.1: General test parameters for Handover to intra-frequency cell**

Parameter		Unit	Value	Comment
DCH parameters			DL and UL Reference Measurement Channel 12.2 kbps	As specified in TS 25.102 section A.2.2 and A.2.1
Power Control			On	
Target quality value on DTCH		BLER	0.01	
Initial conditions	Active cell		Cell 1	
	Neighbour cell		Cell 2	
Final condition	Active cell		Cell 2	
HCS			Not used	
O		dB	0	Cell individual offset. This value shall be used for all cells in the test.
Hysteresis		dB	0	
Time to Trigger		ms	0	
Filter coefficient			0	
Monitored cell list size			6 TDD neighbours on Channel 1	
T1		s	10	
T2		s	10	
T3		s	10	

**Table 8.3.1B.1.2: Cell specific test parameters for Handover to intra-frequency cell**

Parameter	Unit	Cell 1						Cell 2					
		0			4			0			5		
DL timeslot number		T1	T2	T3	T1	T2	T3	T1	T2	T3	T1	T2	T3
UTRA RF Channel Number		Channel 1						Channel 1					
PCCPCH_Ec/Ior	dB	-3			n.a.			-3			n.a.		
SCH_Ec/Ior	dB	-9			n.a.			-9			n.a.		
SCH_toffset	dB	0			n.a.			5			n.a.		
DPCH_Ec/Ior	dB	n.a.			Note 1		n.a.	n.a.			n.a.		Note 1
OCNS_Ec/Ior	dB	-3,12			Note 2		n.a.	n.a.	-3,12		n.a.		Note 2
$\hat{I}_{or}/I_{oc}$	dB	1						-Inf.	3		-Inf.	3	
PCCPCH RSCP	dBm	-72			n.a.			-Inf.	-70		n.a.		
$I_{oc}$	dBm/7, 68 MHz	-70											
Propagation Condition		AWGN											
Note 1: The DPCH level is controlled by the power control loop													
Note 2: The power of the OCNS channel that is added shall make the total power from the cell to be equal to Ior .													

#### 8.3.1B.1.4.2 Procedure

- 1) The RF parameters are set up according to T1.
- 2) The UE is switched on.
- 3) A call is set up according to the test procedure specified in TS 34.108 [3] subclause 7.3.4.
- 4) SS shall transmit a MEASUREMENT CONTROL message.

- 5) After 10 seconds, the SS shall switch the power settings from T1 to T2.
- 6) UE shall transmit a MEASUREMENT REPORT message triggered by event 1G.
- 7) SS shall transmit a PHYSICAL CHANNEL RECONFIGURATION message with activation time at T3.
- 8) After 10 seconds, the SS shall switch the power settings from T2 to T3
- 9) UE shall transmit a PHYSICAL CHANNEL RECONFIGURATION COMPLETE message on the UL DCCH of cell 2. If the UE transmits the UL DPCH to cell 2 less than 40 ms from the beginning of time period T3 then the number of successful tests is increased by one.
- 10) After 10 seconds, the UE is switched off. Any timing information of cell 2 is deleted in the UE.
- 11) Repeat step 1-10 until the confidence level according to annex F.6.2 is achieved.

#### Specific Message Contents

All messages indicated above shall use the same content as described in the default message content in clause 9 of 34.108 [3] with the following exceptions:



MEASUREMENT CONTROL message (step 4):

Information Element/Group name	Value/Remark
Message Type (10.2.17)	
<b>UE information elements</b>	
-RRC transaction identifier	0
-Integrity check info	Not Present
<b>Measurement Information elements</b>	
-Measurement Identity	1
-Measurement Command (10.3.7.46)	Modify
-Measurement Reporting Mode (10.3.7.49)	AM RLC
-Periodical Reporting / Event Trigger Reporting Mode	Event trigger
-Additional measurements list (10.3.7.1)	Not Present
-CHOICE <i>Measurement type</i>	Intra-frequency measurement
-Intra-frequency measurement (10.3.7.36)	Not Present
-Intra-frequency measurement objects list (10.3.7.33)	Not Present
-Intra-frequency measurement quantity (10.3.7.38)	0
-Filter coefficient (10.3.7.9)	TDD
-CHOICE <i>mode</i>	1
-Measurement quantity list	
-Measurement quantity	Primary CCPCH
-Intra-frequency reporting quantity (10.3.7.41)	
-Reporting quantities for active set cells (10.3.7.5)	No report
-SFN-SFN observed time difference reporting indicator	TRUE (Note 1)
-Cell synchronisation information reporting indicator	TRUE
-Cell Identity reporting indicator	TDD
-CHOICE <i>mode</i>	FALSE
-Timeslot ISCP reporting indicator	TRUE
-Primary CCPCH RSCP reporting indicator	TRUE
-Pathloss reporting indicator	FALSE
-Reporting quantities for monitored set cells (10.3.7.5)	No report
-SFN-SFN observed time difference reporting indicator	TRUE (Note 1)
-Cell synchronisation information reporting indicator	TRUE
-Cell Identity reporting indicator	TDD
-CHOICE <i>mode</i>	FALSE
-Timeslot ISCP reporting indicator	FALSE
-Proposed TGSN reporting required	FALSE
-Primary CCPCH RSCP reporting indicator	TRUE
-Pathloss reporting indicator	FALSE
-Reporting quantities for detected set cells (10.3.7.5)	Not Present
-Reporting cell status (10.3.7.61)	
-CHOICE <i>reported cell</i>	Report all active set cells + cells within monitored set on used frequency
-Maximum number of reported cells	2
-Measurement validity (10.3.7.51)	Not Present
-CHOICE <i>report criteria</i>	Intra-frequency measurement reporting criteria
-Intra-frequency measurement reporting criteria (10.3.7.39)	
-Parameters required for each event	1
-Intra-frequency event identity	Event 1G
-Triggering condition 2	Not Present
-Reporting Range Constant	Not Present
-Cells forbidden to affect Reporting Range	Not Present
-W	Not Present
-Hysteresis	0 dB
-Threshold used frequency	Not Present
-Reporting deactivation threshold	Not Present
-Replacement activation threshold	Not Present
-Time to trigger	0 ms
-Amount of reporting	Infinity
-Reporting interval	0 ms (Note 2)
-Reporting cell status	Not Present
<b>Physical channel information elements</b>	
-DPCH compressed mode status info (10.3.6.34)	Not Present

Information Element/Group name	Value/Remark
Note 1:	The SFN-CFN observed time difference is calculated from the OFF and Tm parameters contained in the IE "Cell synchronisation information", TS 25.331, clause 10.3.7.6. According to TS 25.331, 8.6.7.7, this IE is included in MEASUREMENT REPORT if IE "Cell synchronisation information reporting indicator" in IE "Cell reporting quantities" TS 25.331, clause 10.3.7.5 is set to TRUE in MEASUREMENT CONTROL.
Note 2:	Reporting interval = 0 ms means no periodical reporting

PHYSICAL CHANNEL RECONFIGURATION message (step 7):

Information Element	Value/Remark
Message Type	
<b>UE Information Elements</b>	
-RRC transaction identifier	0
-Integrity check info	Not Present
-Integrity protection mode info	Not Present
-Ciphering mode info	Not Present
-Activation time	At T3
-Delay restriction flag	Not present
-New U-RNTI	Not Present
-New C-RNTI	Not Present
-New DSCH-RNTI	Not Present
-New H-RNTI	Not Present
-CHOICE <i>mode</i>	TDD
-New E-RNTI	Not Present
-RRC State Indicator	CELL_DCH
-UTRAN DRX cycle length coefficient	Not Present
<b>CN Information Elements</b>	
-CN Information info	Not Present
<b>UTRAN mobility information elements</b>	
-URA identity	Not Present
<b>RB information elements</b>	
-Downlink counter synchronisation info	Not Present
-RB with PDCP information list	Not Present
-RB with PDCP information	Not Present
<b>PhyCH information elements</b>	
-Frequency info (10.3.6.36)	
-CHOICE <i>mode</i>	TDD
-UARFCN (Nt)	Same UARFCN as used for cell 2
<b>Uplink radio resources</b>	
-Maximum allowed UL TX power	33 dBm
-Uplink DPCH info (10.3.6.88)	
-Uplink DPCH power control info (10.3.6.91)	
-CHOICE <i>mode</i>	TDD
-UL Target SIR	Not Present
-CHOICE <i>UL OL PC info</i>	Individually signalled
-CHOICE <i>TDD option</i>	7,68 Mcps TDD
-Individual Timeslot interference info	1
-Individual timeslot interference (10.3.6.38)	
-Timeslot Number (10.3.6.84)	
-CHOICE <i>TDD option</i>	7,68 Mcps TDD
-Timeslot number	12
-UL Timeslot Interference	-90 dBm
-CHOICE <i>mode</i>	TDD
-Uplink timing advance control (10.3.6.96)	
-CHOICE <i>Timing Advance</i>	Disabled
-UL CCTrCH list	1
- TFCS ID	1
-UL Target SIR	20 dB
-Time Info (10.3.6.83)	
-Activation Time	T3
-Duration	Infinite
-Common timeslot info	Not Present
-CHOICE <i>TDD option</i>	7,68 Mcps TDD
-Uplink DPCH timeslots and codes (10.3.6.94)	
-Dynamic SF Usage	False
-First individual timeslot info (10.3.6.37)	
-Timeslot Number (10.3.6.84)	
-CHOICE <i>TDD option</i>	7,68 Mcps
-Timeslot number	12
-TFCl existence	True
-Midamble shift and burst type (10.3.6.41)	
-Choice <i>TDD option</i>	7,68 Mcps
-Choice Burst Type	Type 1
-Midamble Allocation Mode	Default
-Midamble configuration burst type 1 and 3	16

Information Element	Value/Remark
-Midamble shift	Not present
-CHOICE <i>TDD option</i>	7,68 Mcps
-First timeslot code list	1
-Channelisation code	16/1
-Choice more timeslots	No more timeslots
-E-DCH info	Not Present
<b>Downlink radio resources</b>	
-Downlink HS-PDSCH information	Not Present
-Downlink information common for all radio links (10.3.6.24)	
- Choice DPCH info	Downlink DPCH info common for all RL
-Downlink DPCH info common for all RL (10.3.6.18)	
-Timing indicator	Initialise
-Downlink DPCH power control information (10.3.6.23)	
-CHOICE <i>mode</i>	TDD
-TPC Step size	1 dB
-MAC-d HFN initial value	Not present
-CHOICE <i>mode</i>	TDD
-CHOICE <i>mode</i>	TDD
-CHOICE <i>TDD option</i>	7,68 Mcps
-TX Diversity mode (10.3.6.86)	None
-Default DPCH Offset Value (10.3.6.16)	0
-MAC-hs reset indicator	Not present
-Post-verification period	Not present
-Downlink information per radio link list	1
-Downlink information for each radio link (10.3.6.27)	
-CHOICE <i>mode</i>	TDD
-Primary CCPCH info (10.3.6.57)	
-CHOICE <i>mode</i>	TDD
-CHOICE <i>TDD option</i>	7,68 Mcps
-CHOICE <i>sync case</i>	Case 2
-Timeslot	0
-Cell parameters ID	20
-SCTD indicator	False
-CHOICE <i>DPCH info</i>	Downlink DPCH info for each RL
-Downlink DPCH info for each RL (10.3.6.21)	
-CHOICE <i>mode</i>	7.68 Mcps TDD
-DL CCTrCH list	1
-TFCS ID	1
-Time Info (10.3.6.83)	
-Activation Time	T3
-Duration	Infinite
-Common timeslot info	Not Present
-Downlink DPCH timeslots and codes VHCR (10.3.6.32a)	
-First individual timeslot info (10.3.6.37)	
-Timeslot Number (10.3.6.84)	
-CHOICE <i>TDD option</i>	7,68 Mcps
-Timeslot number	5
-TFCI existence	True
-Midamble shift and burst type (10.3.6.41)	
-CHOICE <i>TDD option</i>	7,68 Mcps
-CHOICE <i>Burst Type</i>	Type 1
-Midamble Allocation Mode	Default
-Midamble configuration burst type 1 and 3	16
-Midamble shift	Not present
-CHOICE <i>TDD option</i>	7,68 Mcps
-First timeslot channelisation codes VHCR (10.3.6.17a)	
-CHOICE <i>codes representation</i>	Consecutive codes
-First channelisation code	16/1
-Last channelisation code	16/1
-CHOICE <i>more timeslots</i>	No more timeslots
-UL CCTrCH TPC List	Not Present
- DL CCTrCH List to Remove	Not Present
- E-AGCH Info	Not Present
- CHOICE <i>mode</i>	TDD
- E=HICH information	Not Present
-MBMS PL Service Restriction Information	Not Present

## MEASUREMENT REPORT message (step 6)

Information Element	Value/remark
Message Type (10.2.17)	
Integrity check info	Not Present
Measurement identity	1
Measured Results (10.3.7.44)	
-CHOICE Measurement	Intra-frequency Measured results list
-Intra-frequency measured results	1
-Cell measured results (10.3.7.3)	
-Cell identity	Checked that this IE is present
-SFN-SFN observed time difference	Not Present
-Cell synchronisation info	Checked that this IE is present
-CHOICE mode	TDD
-Cell parameters ID	20
-Proposed TGSN	Not Present
-Primary CCPCH RSCP	Checked that this IE is present
-Pathloss	Not Present
-Timeslot list	Not Present
Measured results on RACH	Not Present
Additional measured results	Not Present
Event results (10.3.7.7)	
-CHOICE event result	Intra-frequency measurement event results
-Intra-frequency event identity	1G
-Cell measurement event results (10.3.7.4)	
-CHOICE mode	TDD
-Primary CCPCH info (10.3.6.57)	
-CHOICE mode	TDD
-CHOICE TDD option	7.68Mcps TDD
-CHOICE SyncCase	Not Present
-Cell parameters ID	40
-SCTD indicator	FALSE

## 8.3.1B.1.5 Test requirements

For the test to pass, the total number of successful tests shall be more than 90% with a confidence level of 95% of the cases.

Note: If the above Test Requirement differs from the Minimum Requirement then the Test Tolerance applied for this test is non-zero. The Test Tolerance for this test is defined in clause F.2 and the explanation of how the Minimum Requirement has been relaxed by the Test Tolerance is given in clause F.4.

## 8.3.1B.2 Handover to inter-frequency cell

## 8.3.1B.2.1 Definition and applicability

The handover interruption time is defined as the time between the end of the last TTI containing a transport block on the old DPCH and the time the UE starts transmission of the new uplink DPCH.

The requirements and this test apply to the UTRA TDD UE.

## 8.3.1B.2.2 Minimum requirement

The interruption time shall be less than 40 ms in the dual carrier case when the cell is known by the UE and the SFN of the target cell needs to be decoded. The rate of correct handovers observed during repeated tests shall be at least 90% with a confidence level of 95%.

The interruption time is dependent on whether the target cell is known for the UE or not.

If TDD/TDD inter-frequency handover is commanded, the interruption time shall be less than,

$$T_{\text{interrupt}} = T_{\text{offset}} + T_{\text{UL}} + 30 * F_{\text{SFN}} + 20 * KC + 180 * UC \text{ ms}$$

where,

$T_{\text{offset}}$	Equal to 10 ms, the frame timing uncertainty between the old cell and the target cell and the time that can elapse until the appearance of a Beacon channel
$T_{\text{UL}}$	Equal to 10 ms, the time that can elapse until the appearance of the UL timeslot in the target cell
$F_{\text{SFN}}$	Equal to 1 if SFN decoding is required and equal to 0 otherwise
KC	Equal to 1 if a known target cell is indicated in the RRC message implying TDD/TDD handover and equal to 0 otherwise
UC	Equal to 1 if an unknown target cell is indicated in the RRC message implying TDD/TDD handover and equal to 0 otherwise

An inter-frequency TDD target cell shall be considered as known by the UE, if either or both of the following conditions are true:

- the target cell has been measured during the last 5 seconds
- the UE has had a radio link connected to the target cell during the last 5 seconds.

The interruption time requirements for an unknown target cell shall apply only if the signal quality of the unknown target cell is sufficient for successful synchronisation with one attempt.

The normative reference for this requirement is TS 25.123 [2] clauses 5.1.2 and A.5.1.3.

### 8.3.1B.2.3 Test purpose

The purpose of this test is to verify the requirement for the inter-frequency handover delay in CELL\_DCH state in the dual carrier case.

### 8.3.1B.2.4 Method of test

#### 8.3.1B.2.4.1 Initial conditions

Test environment: normal; see clauses G.2.1 and G.2.2.

Frequencies to be tested: mid range; see clause G.2.4.

The test parameters are given in table 8.3.1B.2.1 and 8.3.1B.2.2. In the measurement control information it is indicated to the UE that event-triggered reporting with Event 2C shall be used. The PCCPCH RSCP and SFN-CFN observed time difference of the best cell on the unused frequency shall be reported together with Event 2C reporting. At the start of time duration T1, the UE may not have any timing information of cell 2.

UTRAN shall send a Physical Channel reconfiguration message with activation time at beginning of T3 with one active cell, cell 2. The Physical Channel reconfiguration message shall be sent to the UE such that the delay between the end of the last received TTI containing the message and the beginning of T3 is at least equal to the RRC procedure delay as defined in [16].

The second Beacon timeslot shall be provided in timeslot 8 for cell 1 and in timeslot 10 for cell 2. The UL DPCH shall be transmitted in timeslot 12.

Table 8.3.1B.2.1: General test parameters for Handover to inter-frequency cell

Parameter		Unit	Value	Comment
DCH parameters			DL and UL Reference Measurement Channel 12.2 kbps	As specified in TS 25.102 section A.2.2 and A.2.1
Power Control			On	
Target quality value on DTCH		BLER	0.01	
Initial conditions	Active cell		Cell 1	
	Neighbour cell		Cell 2	
Final condition	Active cell		Cell 2	
HCS			Not used	
O		dB	0	Cell individual offset. This value shall be used for all cells in the test.
Hysteresis		dB	0	Hysteresis parameter for event 2C
Time to Trigger		ms	0	
Threshold non-used frequency		dBm	-80	Applicable for Event 2C
Filter coefficient			0	
Monitored cell list size			6 TDD neighbours on Channel 1 6 TDD neighbours on Channel 2	
T <sub>SI</sub>		s	1.28	The value shall be used for all cells in the test.
T1		s	10	
T2		s	10	
T3		s	10	

Table 8.3.1B.2.2: Cell Specific parameters for Handover to inter-frequency cell

Parameter	Unit	Cell 1						Cell 2					
		0			4			2			5		
DL timeslot number		T1	T2	T3	T1	T2	T3	T1	T2	T3	T1	T2	T3
UTRA RF Channel Number		Channel 1						Channel 2					
PCCPCH_Ec/I <sub>or</sub>	dB	-3			n.a.			-3			n.a.		
SCH_Ec/I <sub>or</sub>	dB	-9			n.a.			-9			n.a.		
SCH_t <sub>offset</sub>	dB	0			n.a.			5			n.a.		
DPCH_Ec/I <sub>or</sub>	dB	n.a.			Note 1		n.a.	n.a.			n.a.		Note 1
OCNS_Ec/I <sub>or</sub>	dB	-3,12			Note 2		n.a.	n.a.	-3,12		n.a.		Note 2
$\hat{I}_{or}/I_{oc}$	dB	1						-Inf.	7		-Inf.	7	
PCCPCH RSCP	dBm	-72			n.a.			-Inf.	-66		n.a.		
I <sub>oc</sub>	dBm/ 7,68 MHz							-70					
Propagation Condition		AWGN											
Note 1: The DPCH level is controlled by the power control loop													
Note 2: The power of the OCNS channel that is added shall make the total power from the cell to be equal to I <sub>or</sub> .													

## 8.3.1B.2.4.2 Procedure

- 1) The RF parameters are set up according to T1.
- 2) The UE is switched on.
- 3) A call is set up according to the test procedure specified in TS 34.108 [3] subclause 7.3.4.
- 4) SS shall transmit a MEASUREMENT CONTROL message.
- 5) After 10 seconds, the SS shall switch the power settings from T1 to T2.
- 6) UE shall transmit a MEASUREMENT REPORT message triggered by event 2C.

- 7) SS shall transmit a PHYSICAL CHANNEL RECONFIGURATION message with activation time at T3.
- 8) After 10 seconds, the SS shall switch the power settings from T2 to T3
- 9) UE shall transmit a PHYSICAL CHANNEL RECONFIGURATION COMPLETE message on the UL DCCH of cell 2. If the UE transmits the UL DPCH to cell 2 less than 40 ms from the beginning of time period T3 then the number of successful tests is increased by one.
- 10) After 10 seconds, the UE is switched off. Any timing information of cell 2 is deleted in the UE.
- 11) Repeat step 1-10 until the confidence level according to annex F.6.2 is achieved..

#### Specific Message Contents

All messages indicated above shall use the same content as described in the default message content in clause 9 of 34.108 [3] and in Annex A of 34.123-1 [21], with the following exceptions:



MEASUREMENT CONTROL message, event 2C (step 4):

Information Element/Group name	Value/Remark
Message Type (10.2.17)	
<b>UE information elements</b>	
-RRC transaction identifier	0
-Integrity check info	Not Present
<b>Measurement Information elements</b>	
-Measurement Identity	1
-Measurement Command (10.3.7.46)	Modify
-Measurement Reporting Mode (10.3.7.49)	AM RLC
-Periodical Reporting / Event Trigger Reporting Mode	Event trigger
-Additional measurements list (10.3.7.1)	Not Present
-CHOICE <i>Measurement type</i>	Inter-frequency measurement
-Inter-frequency measurement (10.3.7.16)	Not Present
-Inter-frequency measurement objects list (10.3.7.13)	Not Present
-Inter-frequency measurement quantity (10.3.7.18)	Inter-frequency reporting criteria
-CHOICE <i>reporting criteria</i>	
-Inter-frequency reporting criteria	
-Filter coefficient	0
-CHOICE <i>mode</i>	TDD
-Measurement quantity for frequency quality estimate	Primary CCPCH RSCP
-Inter-frequency reporting quantity (10.3.7.21)	
-UTRA Carrier RSSI	FALSE
-Frequency quality estimate	FALSE
-Non frequency related cell reporting quantities (10.3.7.5)	No Report
-SFN-SFN observed time difference reporting indicator	TRUE
-Cell synchronisation information reporting indicator	TRUE
-Cell Identity reporting indicator	TDD
-CHOICE <i>mode</i>	FALSE
-Timeslot ISCP reporting indicator	FALSE
-Proposed TGSN reporting required	TRUE
-Primary CCPCH RSCP reporting indicator	FALSE
-Pathloss reporting indicator	FALSE
-Reporting cell status (10.3.7.61)	
-CHOICE <i>reported cell</i>	Report cells within monitored set on non-used frequency
-Maximum number of reported cells per reported non-used frequency	1
-Measurement validity (10.3.7.51)	Not Present
-Inter-frequency set update (10.3.7.22)	Not Present
-CHOICE <i>report criteria</i>	Inter-frequency measurement reporting criteria
-Inter-frequency measurement reporting criteria (10.3.7.19)	
-Parameters required for each event	1
-Inter-frequency event identity (10.3.7.14)	Event 2C
-Threshold used frequency	Not Present
-W used frequency	Not Present
-Hysteresis	0 dB
-Time to trigger	0 ms
-Reporting cell status (10.3.7.61)	
-CHOICE <i>reported cell</i>	Report cells within monitored set on non-used frequency
-Maximum number of reported cells per reported non-used frequency	1
-Parameters required for each non-used frequency	1
-Threshold non-used frequency	-80 dBm
-W non-used frequency	1
<b>Physical channel information elements</b>	
-DPCH compressed mode status info (10.3.6.34)	Not Present

## PHYSICAL CHANNEL RECONFIGURATION message (step 7):

Information Element	Value/Remark
Message Type	
<b>UE Information Elements</b>	
-RRC transaction identifier	0
-Integrity check info	Not Present
-Integrity protection mode info	Not Present
-Ciphering mode info	Not Present
-Activation time	At T3
-Delay restriction flag	Not present
-New U-RNTI	Not Present
-New C-RNTI	Not Present
-New DSCH-RNTI	Not Present
-New H-RNTI	Not Present
-CHOICE <i>mode</i>	TDD
-New E-RNTI	Not Present
-RRC State Indicator	CELL_DCH
-UTRAN DRX cycle length coefficient	Not Present
<b>CN Information Elements</b>	
-CN Information info	Not Present
<b>UTRAN mobility information elements</b>	
-URA identity	Not Present
<b>RB information elements</b>	
-Downlink counter synchronisation info	Not Present
-RB with PDCP information list	Not Present
-RB with PDCP information	Not Present
<b>PhyCH information elements</b>	
-Frequency info (10.3.6.36)	
-CHOICE <i>mode</i>	TDD
-UARFCN (Nt)	Same UARFCN as used for cell 2
<b>Uplink radio resources</b>	
-Maximum allowed UL TX power	33 dBm
-Uplink DPCH info (10.3.6.88)	
-Uplink DPCH power control info (10.3.6.91)	
-CHOICE <i>mode</i>	TDD
-UL Target SIR	Not Present
-CHOICE <i>UL OL PC info</i>	Individually signalled
-CHOICE <i>TDD option</i>	7,68 Mcps TDD
-Individual Timeslot interference info	1
-Individual timeslot interference (10.3.6.38)	
-Timeslot Number (10.3.6.84)	
-CHOICE <i>TDD option</i>	7,68 Mcps TDD
-Timeslot number	12
-UL Timeslot Interference	-90 dBm
-CHOICE <i>mode</i>	TDD
-Uplink timing advance control (10.3.6.96)	
-CHOICE <i>Timing Advance</i>	Disabled
-UL CCTrCH list	1
- TFCS ID	1
-UL Target SIR	20 dB
-Time Info (10.3.6.83)	
-Activation Time	T3
-Duration	Infinite
-Common timeslot info	Not Present
-CHOICE <i>TDD option</i>	7,68 Mcps TDD
-Uplink DPCH timeslots and codes (10.3.6.94)	
-Dynamic SF Usage	False
-First individual timeslot info (10.3.6.37)	
-Timeslot Number (10.3.6.84)	
-CHOICE <i>TDD option</i>	7,68 Mcps
-Timeslot number	12
-TFCI existence	True
-Midamble shift and burst type (10.3.6.41)	
-Choice <i>TDD option</i>	7,68 Mcps
-Choice Burst Type	Type 1
-Midamble Allocation Mode	Default
-Midamble configuration burst type 1 and 3	16

Information Element	Value/Remark
-Midamble shift	Not present
-CHOICE <i>TDD option</i>	7,68 Mcps
-First timeslot code list	1
-Channelisation code	16/1
-Choice more timeslots	No more timeslots
-E-DCH info	Not Present
<b>Downlink radio resources</b>	
-Downlink HS-PDSCH information	Not Present
-Downlink information common for all radio links (10.3.6.24)	
- Choice DPCH info	Downlink DPCH info common for all RL
-Downlink DPCH info common for all RL (10.3.6.18)	
-Timing indicator	Initialise
-Downlink DPCH power control information (10.3.6.23)	
-CHOICE <i>mode</i>	TDD
-TPC Step size	1 dB
-MAC-d HFN initial value	Not present
-CHOICE <i>mode</i>	TDD
-CHOICE <i>mode</i>	TDD
-CHOICE <i>TDD option</i>	7,68 Mcps
-TX Diversity mode (10.3.6.86)	None
-Default DPCH Offset Value (10.3.6.16)	0
-MAC-hs reset indicator	Not present
-Post-verification period	Not present
-Downlink information per radio link list	1
-Downlink information for each radio link (10.3.6.27)	
-CHOICE <i>mode</i>	TDD
-Primary CCPCH info (10.3.6.57)	
-CHOICE <i>mode</i>	TDD
-CHOICE <i>TDD option</i>	7,68 Mcps
-CHOICE <i>sync case</i>	Case 2
-Timeslot	0
-Cell parameters ID	20
-SCTD indicator	False
-CHOICE <i>DPCH info</i>	Downlink DPCH info for each RL
-Downlink DPCH info for each RL (10.3.6.21)	
-CHOICE <i>mode</i>	7.68 Mcps TDD
-DL CCTrCH list	1
-TFCS ID	1
-Time Info (10.3.6.83)	
-Activation Time	T3
-Duration	Infinite
-Common timeslot info	Not Present
-Downlink DPCH timeslots and codes VHCR (10.3.6.32a)	
-First individual timeslot info (10.3.6.37)	
-Timeslot Number (10.3.6.84)	
-CHOICE <i>TDD option</i>	7,68 Mcps
-Timeslot number	5
-TFCI existence	True
-Midamble shift and burst type (10.3.6.41)	
-CHOICE <i>TDD option</i>	7,68 Mcps
-CHOICE <i>Burst Type</i>	Type 1
-Midamble Allocation Mode	Default
-Midamble configuration burst type 1 and 3	16
-Midamble shift	Not present
-CHOICE <i>TDD option</i>	7,68 Mcps
-First timeslot channelisation codes VHCR (10.3.6.17a)	
-CHOICE <i>codes representation</i>	Consecutive codes
-First channelisation code	16/1
-Last channelisation code	16/1
-CHOICE <i>more timeslots</i>	No more timeslots
-UL CCTrCH TPC List	Not Present
- DL CCTrCH List to Remove	Not Present
- E-AGCH Info	Not Present
- CHOICE <i>mode</i>	TDD
- E=HICH information	Not Present
-MBMS PL Service Restriction Information	Not Present

## MEASUREMENT REPORT message (step 6)

Information Element	Value/remark
Message Type (10.2.17)	
Integrity check info	Not Present
Measurement identity	1
Measured Results (10.3.7.44)	
-CHOICE Measurement	Inter-frequency Measured results list
-Inter-frequency measured results	1
-Frequency info	
-CHOICE mode	TDD
-UARFCN(Nt)	Same frequency as channel 2 in Table 8.6.2.4.1.2
-UTRA carrier RSSI	Not Present
-Inter-frequency cell measured results	1
-Cell measured results (10.3.7.3)	
-Cell identity	Checked that this IE is present
-SFN-SFN observed time difference	Not Present
-Cell synchronisation info	Checked that this IE is present
-CHOICE mode	TDD
-Cell parameters ID	Set to cell parameters ID of Cell 2
-Proposed TGSN	Not Present
-Primary CCPCH RSCP	Checked that this IE is present
-Pathloss	Not Present
-Timeslot list	Not Present
Measured results on RACH	Not Present
Additional measured results	Not Present
Event results (10.3.7.7)	
-CHOICE event result	Inter-frequency measurement event results
-Inter-frequency event identity	2C
-Inter-frequency cells	1
-Frequency Info	
-CHOICE mode	TDD
-UARFCN(Nt)	Same frequency as channel 2 in Table 8.6.2.4.1.2
-CHOICE mode	TDD
-Primary CCPCH Info	
-CHOICE mode	TDD
-CHOICE TDD Option	7,68 Mcps TDD
-CHOICE Sync Case	Not Present
-Cell Parameters ID	Set to cell parameters ID of Cell 2
-SCTD Indicator	FALSE

### 8.3.1B.2.5 Test requirements

For the test to pass, the total number of successful tests shall be more than 90% with a confidence level of 95% of the cases.

Note: If the above Test Requirement differs from the Minimum Requirement then the Test Tolerance applied for this test is non-zero. The Test Tolerance for this test is defined in clause F.2 and the explanation of how the Minimum Requirement has been relaxed by the Test Tolerance is given in clause F.4.

## 8.3.2 TDD/FDD Handover for 3,84 Mcps Option

### 8.3.2.1 Definition and applicability

The handover interruption time is defined as the time between the end of the last TTI containing a transport block on the old DPCH and the time the UE starts transmission of the new uplink DPCCCH.

The requirements and this test apply to the UTRA TDD / FDD UE.

### 8.3.2.2 Minimum requirement

The interruption time shall be less than 100 ms in the single carrier case when the cell is known by the UE and the SFN of the target cell does not need to be decoded. The rate of correct handovers observed during repeated tests shall be at least 90% with a confidence level of [FFS]%.

The interruption time is dependent on whether the target cell is known for the UE or not.

If TDD/FDD handover is commanded, the interruption time shall be less than,

$$T_{\text{interrupt}} = T_{\text{offset}} + 40 + 50 * KC + 150 * UC \text{ ms}$$

where,

$T_{\text{offset}}$	Equal to 10 ms, the frame timing uncertainty between the old cell and the target cell.
KC	Equal to 1 if a known target cell is indicated in the RRC message implying TDD/FDD handover and equal to 0 otherwise
UC	Equal to 1 if an unknown target cell is indicated in the RRC message implying TDD/FDD handover and equal to 0 otherwise

An inter-frequency FDD target cell shall be considered known by the UE, if the target cell has been measured by the UE during the last 5 seconds.

The phase reference is the Primary CPICH.

The interruption time requirements for an unknown target cell shall apply only if the signal quality of the unknown target cell is sufficient for successful synchronisation with one attempt.

The normative reference for this requirement is TS 25.123 [2] clauses 5.2 and A.5.2.

### 8.3.2.3 Test purpose

The purpose of this test is to verify the requirement for the TDD/FDD handover delay in CELL\_DCH state.

### 8.3.2.4 Method of test

#### 8.3.2.4.1 Initial conditions

Test environment: normal; see clauses G.2.1 and G.2.2.

Frequencies to be tested: mid range; see clause G.2.4.

The test parameters are given in table 8.3.2.1, 8.3.2.2 and 8.3.2.3 below. In the measurement control information it is indicated to the UE that event-triggered reporting with Event 1G and 2B shall be used. The CPICH\_RSCP of the best cell on the unused frequency shall be reported together with Event 2B reporting. The test consists of three successive time periods, with a time duration of T1, T2 and T3 respectively. At the start of time duration T1, the UE may not have any timing information of cell 2.

UTRAN shall send a Physical Channel reconfiguration message with activation time at the beginning of T3 with a new active cell, cell 2. The Physical Channel reconfiguration message shall be sent to the UE such that the delay between the end of the last received TTI containing the message and the beginning of T3 is at least equal to the RRC procedure delay as defined in [16].

Table 8.3.2.1: General test parameters for TDD/FDD handover

Parameter		Unit	Value	Comment
DCH parameters			DL Reference Measurement Channel 12.2 kbps	As specified in TS 25.102 clause A.2.2
Power Control			On	
Target quality value on DTCH		BLER	0.01	
Initial conditions	Active cell		Cell 1	TDD cell
	Neighbour cell		Cell 2	FDD cell
Final condition	Active cell		Cell 2	FDD cell
HCS			Not used	
	O	dB	0	Cell individual offset. This value shall be used for all cells in the test.
Hysteresis		dB	3	Hysteresis parameter for event 2B
Time to Trigger		ms	0	
Absolute threshold used frequency		dBm	-71	Applicable for Event 2B
Threshold non-used frequency		dBm	-80	Applicable for Event 2B
W non-used frequency			1	Applicable for Event 2B
Filter coefficient			0	
Monitored cell list size			6 TDD neighbours on Channel 1 6 FDD neighbours on Channel 2	
	T <sub>SI</sub>	s	1,28	The value shall be used for all cells in the test.
	T1	s	5	
	T2	s	15	
	T3	s	5	

Table 8.3.2.2: Cell 1 specific test parameters for TDD/FDD handover

Parameter	Unit	Cell 1					
		0			2		
DL timeslot number		T1	T2	T3	T1	T2	T3
UTRA RF Channel Number		Channel 1					
PCCPCH_Ec/lor	dB	-3			n.a.		
SCH_Ec/lor	dB	-9			n.a.		
SCH_t <sub>offset</sub>	dB	0			n.a.		
DPCH_Ec/lor	dB	n.a.			Note 1		n.a.
OCNS_Ec/lor	dB	-3,12			Note 2		n.a.
$\hat{I}_{or}/I_{oc}$	dB	5	-1		5	-1	
PCCPCH RSCP	dBm	-68	-74		n.a.		
$I_{oc}$	dBm/3, 84 MHz	-70					
Propagation Condition		AWGN					
Note 1: The DPCH level is controlled by the power control loop							
Note 2: The power of the OCNS channel that is added shall make the total power from the cell to be equal to lor.							

**Table 8.3.2.3: Cell 2 specific test parameters for TDD/FDD handover**

Parameter	Unit	Cell 2	
		T1, T2	T3
CPICH_Ec/Ior	dB	-10	
PCCPCH_Ec/Ior	dB	-12	
SCH_Ec/Ior	dB	-12	
PICH_Ec/Ior	dB	-15	
DPCH_Ec/Ior	dB	n.a.	Note 1
OCNS_Ec/Ior	dB	-0,941	Note 2
CPICH_RSCP	dBm	-83	-77
$\hat{I}_{or}/I_{oc}$	dB	-3	3
$I_{oc}$	dBm/3,8 4 MHz	-70	
Propagation Condition		AWGN	
Note 1: The DPCH level is controlled by the power control loop			
Note 2 : The power of the OCNS channel that is added shall make the total power from the cell to be equal to $I_{or}$			

#### 8.3.2.4.2 Procedure

- 1) The RF parameters are set up according to T1.
- 2) The UE is switched on.
- 3) A call is set up according to the test procedure specified in TS 34.108 [3] subclause 7.3.4.  
[Editor's note: subclause 7.3.4 in TS 34.108 (Message sequence chart for Handover Test procedure) is not yet specified]
- 4) SS shall transmit a MEASUREMENT CONTROL message.
- 5) After 5 seconds, the SS shall switch the power settings from T1 to T2.
- 6) UE shall transmit a MEASUREMENT REPORT message triggered by event 2B.
- 7) SS shall transmit a PHYSICAL CHANNEL RECONFIGURATION message with activation time at T3.
- 8) After 15 seconds, the SS shall switch the power settings from T2 to T3
- 9) UE shall transmit a PHYSICAL CHANNEL RECONFIGURATION COMPLETE message on the UL DCCH of cell 2. If the UE transmits the UL DPCCH to cell 2 less than 100 ms from the beginning of time period T3 then the number of successful tests is increased by one.
- 10) After 5 seconds, the UE is switched off. Any timing information of cell 2 is deleted in the UE.
- 11) Repeat step 1-10 [TBD] times.

#### Specific Message Contents

All messages indicated below shall use the same content as described in the default message content in clause 9 of 34.108 [3] and in Annex A of 34.123-1 [21], with the following exceptions:

MEASUREMENT CONTROL message, event 2B (step 4):

Information Element/Group name	Value/Remark
Message Type (10.2.17)	
<b>UE information elements</b>	
-RRC transaction identifier	0
-Integrity check info	Not Present
<b>Measurement Information elements</b>	
-Measurement Identity	1
-Measurement Command (10.3.7.46)	Modify
-Measurement Reporting Mode (10.3.7.49)	AM RLC
-Periodical Reporting / Event Trigger Reporting Mode	Event trigger
-Additional measurements list (10.3.7.1)	Not Present
-CHOICE <i>Measurement type</i>	Inter-frequency measurement
-Inter-frequency measurement (10.3.7.16)	Not Present
-Inter-frequency measurement objects list (10.3.7.13)	Not Present
-Inter-frequency measurement quantity (10.3.7.18)	Inter-frequency reporting criteria
-CHOICE <i>reporting criteria</i>	
-Inter-frequency reporting criteria	
-Filter coefficient	0
-CHOICE <i>mode</i>	FDD
-Measurement quantity for frequency quality estimate	CPICH RSCP
-Inter-frequency reporting quantity (10.3.7.21)	
-UTRA Carrier RSSI	FALSE
-Frequency quality estimate	FALSE
-Non frequency related cell reporting quantities (10.3.7.5)	No Report
-SFN-SFN observed time difference reporting indicator	FALSE
-Cell synchronisation information reporting indicator	TRUE
-Cell Identity reporting indicator	FDD
-CHOICE <i>mode</i>	FALSE
-CPICH Ec/N0 reporting indicator	FALSE
-CPICH RSCP reporting indicator	TRUE
-Pathloss reporting indicator	FALSE
-Reporting cell status (10.3.7.61)	
-CHOICE <i>reported cell</i>	Report cells within monitored set on non-used frequency
-Maximum number of reported cells per reported non-used frequency	1
-Measurement validity (10.3.7.51)	Not Present
-Inter-frequency set update (10.3.7.22)	Not Present
-CHOICE <i>report criteria</i>	Inter-frequency measurement reporting criteria
-Inter-frequency measurement reporting criteria (10.3.7.19)	
-Parameters required for each event	1
-Inter-frequency event identity (10.3.7.14)	Event 2B
-Threshold used frequency	-71 dBm
-W used frequency	1
-Hysteresis	0 dB
-Time to trigger	0 ms
-Reporting cell status (10.3.7.61)	
-CHOICE <i>reported cell</i>	Report cells within monitored set on non-used frequency
-Maximum number of reported cells per reported non-used frequency	1
-Parameters required for each non-used frequency	1
-Threshold non-used frequency	-80 dBm
-W non-used frequency	1
<b>Physical channel information elements</b>	
-DPCH compressed mode status info (10.3.6.34)	Not Present



## PHYSICAL CHANNEL RECONFIGURATION message (step 7):

Information Element	Value/Remark
Message Type	
<b>UE Information Elements</b>	
-RRC transaction identifier	0
-Integrity check info	Not Present
-Integrity protection mode info	Not Present
-Ciphering mode info	Not Present
-Activation time	At T3
-New U-RNTI	Not Present
-New C-RNTI	Not Present
-RRC State Indicator	CELL_DCH
-UTRAN DRX cycle length coefficient	Not Present
<b>CN Information Elements</b>	
-CN Information info	Not Present
<b>UTRAN mobility information elements</b>	
-URA identity	Not Present
<b>RB information elements</b>	
-Downlink counter synchronisation info	Not Present
-RB with PDCP information list	Not Present
-RB with PDCP information	Not Present
<b>PhyCH information elements</b>	
-Frequency info (10.3.6.36)	
-CHOICE <i>mode</i>	FDD
-UARFCN uplink(Nu)	Same uplink UARFCN as used for cell 2
-UARFCN downlink(Nd)	Same downlink UARFCN as used for cell 2
<b>Uplink radio resources</b>	
-Maximum allowed UL TX power	33 dBm
-CHOICE <i>channel requirement</i>	Uplink DPCH info
-Uplink DPCH info (10.3.6.88)	
-Uplink DPCH power control info (10.3.6.91)	
-CHOICE <i>mode</i>	FDD
-DPCCH power offset	-6dB
- PC Preamble	1 frame
- SRB delay	7 frames
- Power Control Algorithm	Algorithm1
- TPC step size	1dB
-CHOICE <i>mode</i>	FDD
-Scrambling code type	Long
-Scrambling code number	0 (0 to 16777215)
-Number of DPDCH	Not Present(1)
-Spreading factor	SF is reference to TS34.108 clause 6.10 Parameter Set
-TFCI existence	TRUE
-Number of FBI bit	Not Present(0)
-Puncturing Limit	Reference to TS34.108 clause 6.10 Parameter Set
<b>Downlink radio resources</b>	
-CHOICE <i>mode</i>	FDD
-Downlink PDSCH information	Not Present
-Downlink information common for all radio links (10.3.6.24)	
-Downlink DPCH info common for all RL (10.3.6.18)	
-Timing indicator	Initialise
-CFN-targetSFN frame offset	Not Present
-Downlink DPCH power control information (10.3.6.23)	
-DPC mode	0 (single)
-CHOICE <i>mode</i>	FDD
-Power offset $P_{\text{Pilot-DPDCCH}}$	TBD
-DL rate matching restriction information	Not Present
-Spreading factor	Reference to TS34.108 clause 6.10 Parameter Set
-Fixed or Flexible Position	Flexible
-TFCI existence	TRUE
-CHOICE <i>SF</i>	Not Present
-Number of bits for Pilot bits(SF=128,256)	Not Present
-CHOICE <i>mode</i>	FDD
-DPCH compressed mode info (10.3.6.33)	Not Present (Note 1)

Information Element	Value/Remark
-TX Diversity mode (10.3.6.86)	None
-SSDT information (10.3.6.77)	Not Present
-Default DPCH Offset Value (10.3.6.16)	0
-Downlink information per radio link list	1
-Downlink information for each radio link (10.3.6.27)	
-CHOICE <i>mode</i>	FDD
-Primary CPICH info (10.3.6.60)	
-Primary scrambling code	350
-PDSCH with SHO DCH info (10.3.6.47)	Not Present
-PDSCH code mapping (10.3.6.43)	Not Present
-Downlink DPCH info for each RL (10.3.6.21)	
-CHOICE <i>mode</i>	FDD
-Primary CPICH usage for channel estimation	Primary CPICH may be used
-DPCH frame offset	0 chips
-Secondary CPICH info	Not Present
-DL channelisation code	
-Secondary scrambling code	1
-Spreading factor	Reference to TS34.108 clause 6.10
-Code number	Parameter Set
-Scrambling code change	SF-1(SF is reference to TS34.108 clause 6.10 Parameter Set)
-TPC combination index	No change
-SSDT Cell Identity	0
- Closed loop timing adjustment mode	-a
- SCCPCH information for FACH (10.3.6.70)	Not Present
	Not Present
Note 1: IE "DPCH compressed mode info" is not needed as default values are applied that have previously been received in RADIO BEARER SETUP or RRC CONNECTION SETUP	

MEASUREMENT REPORT message for Inter frequency test cases

Information Element	Value/remark
Message Type (10.2.17)	
Integrity check info	Not Present
Measurement identity	1
Measured Results (10.3.7.44)	
-CHOICE Measurement	Inter-frequency Measured results list
-Inter-frequency measured results	1
-Frequency info	
-CHOICE mode	FDD
-UARFCN uplink (Nu)	Not Present
-UARFCN downlink (Nd)	Same frequency as channel 2 in Table 8.3.2.3
-UTRA carrier RSSI	Not Present
-Inter-frequency cell measured results	1
-Cell measured results (10.3.7.3)	
-Cell identity	Checked that this IE is present
-SFN-SFN observed time difference	Not Present
-Cell synchronisation info	Not Present
-CHOICE mode	FDD
-Primary CPICH Info	
-Primary scrambling code	Set to Primary scrambling code of Cell2
-CPICH Ec/No	Not Present
-CPICH RSCP	Checked that this IE is present
-Pathloss	Not Present
Measured results on RACH	Not Present
Additional measured results	Not Present
Event results (10.3.7.7)	
-CHOICE event result	Inter-frequency measurement event results
-Inter-frequency event identity	2B
-Inter-frequency cells	1
-Frequency Info	
-CHOICE mode	FDD
-UARFCN uplink (Nu)	Not Present
-UARFCN downlink (Nd)	Same frequency as channel 2 in Table 8.3.2.3
-CHOICE mode	FDD
-Primary CPICH info	
-Primary Scrambling Code	Set to Primary scrambling code of Cell2

### 8.3.2.5 Test requirements

For the test to pass, the total number of successful tests shall be more than 90% with a confidence level of [FFS]% of the cases.

Note: If the above Test Requirement differs from the Minimum Requirement then the Test Tolerance applied for this test is non-zero. The Test Tolerance for this test is defined in clause F.2 and the explanation of how the Minimum Requirement has been relaxed by the Test Tolerance is given in clause F.4.

## 8.3.2A TDD/FDD Handover for 1,28 Mcps Option

### 8.3.2A.1 Definition and applicability

The handover interruption time is defined as the time between the end of the last TTI containing a transport block on the old DPCH and the time the UE starts transmission of the new uplink DPCH.

The requirements and this test apply to the UTRA 1,28Mcps TDD / FDD UE.

### 8.3.2A.2 Minimum requirement

The interruption time shall be less than 100 ms in the single carrier case when the cell is known by the UE and the SFN of the target cell does not need to be decoded. The rate of correct handovers observed during repeated tests shall be at least 90% with a confidence level of [FFS]%.

The interruption time is dependent on whether the target cell is known for the UE or not.

If TDD/FDD handover is commanded, the interruption time shall be less than,

$$T_{\text{interrupt}} = T_{\text{offset}} + 40 + 50 * KC + 150 * UC \text{ ms}$$

where,

$T_{\text{offset}}$	Equal to 10 ms, the frame timing uncertainty between the old cell and the target cell.
KC	Equal to 1 if a known target cell is indicated in the RRC message implying TDD/FDD handover and equal to 0 otherwise
UC	Equal to 1 if an unknown target cell is indicated in the RRC message implying TDD/FDD handover and equal to 0 otherwise

An inter-frequency FDD target cell shall be considered known by the UE, if the target cell has been measured by the UE during the last 5 seconds.

The phase reference is the Primary CPICH.

The interruption time requirements for an unknown target cell shall apply only if the signal quality of the unknown target cell is sufficient for successful synchronisation with one attempt.

The normative reference for this requirement is TS 25.123 [2] clauses 5.2.2 and A.5.2.2

### 8.3.2A.3 Test purpose

The purpose of this test is to verify the requirement for the TDD/FDD handover delay in CELL\_DCH state.

### 8.3.2A.4 Method of test

#### 8.3.2A.4.1 Initial conditions

Test environment: normal; see clauses G.2.1 and G.2.2.

Frequencies to be tested: mid range; see clause G.2.4.

The test parameters are given in table 8.3.2.1, 8.3.2.2 and 8.3.2.3 below. In the measurement control information it is indicated to the UE that event-triggered reporting with Event 1G and 2B shall be used. The CPICH\_RSCP of the best cell on the unused frequency shall be reported together with Event 2B reporting. The test consists of three successive time periods, with a time duration of T1, T2 and T3 respectively. At the start of time duration T1, the UE may not have any timing information of cell 2.

UTRAN shall send a Physical Channel reconfiguration message with activation time at the beginning of T3 with a new active cell, cell 2. The Physical Channel reconfiguration message shall be sent to the UE such that the delay between the end of the last received TTI containing the message and the beginning of T3 is at least equal to the RRC procedure delay as defined in [16].

Table 8.3.2A.1: General test parameters for 1,28 Mcps TDD/FDD handover

Parameter		Unit	Value	Comment
DCH parameters			DL and UL Reference Measurement Channels 12.2 kbps	As specified in TS 25.102 annex A and TS 25.101 annex A
Power Control			On	
Initial conditions	Active cell		Cell 1	TDD cell
	Neighbour cell		Cell 2	FDD cell
Final condition	Active cell		Cell 2	FDD cell
O	dB		0	Cell individual offset. This value shall be used for all cells in the test.
Hysteresis	dB		3	Hysteresis parameter for event 2B
Time to Trigger	ms		0	
Absolute threshold used frequency	dBm		-71	Applicable for Event 2B
Threshold non-used frequency	dBm		-80	Applicable for Event 2B
W non-used frequency			1	Applicable for Event 2B
Filter coefficient			0	
Monitored cell list size			6 TDD neighbours on Channel 1 6 FDD neighbours on Channel 2	
T <sub>SI</sub>	s		1,28	The value shall be used for all cells in the test.
T <sub>1</sub>	s		5	
T <sub>2</sub>	s		15	
T <sub>3</sub>	s		5	

Table 8.3.2A.2: Cell 1 (1,28 Mcps TDD cell) specific test parameters for TDD/FDD handover

Parameter	Unit	Cell 1					
		0			5		
Timeslot number		T1	T2	T3	T1	T2	T3
UTRA RF Channel Number		Channel 1					
PCCPCH_Ec/I <sub>or</sub>	dB	-3			n.a.		
DPCH_Ec/I <sub>or</sub>	dB	n.a.			Note 1		n.a.
OCNS_Ec/I <sub>or</sub>	dB	-3			Note 2		n.a.
$\hat{I}_{or}/I_{oc}$	dB	5	-1		5	-1	
PCCPCH RSCP	dBm	-68	-74		n.a.		
I <sub>oc</sub>	dBm/ 1,28 MHz	-70					
Propagation Condition		AWGN					
Note 1: The DPCH level is controlled by the power control loop							
Note 2: The power of the OCNS channel that is added shall make the total power from the cell to be equal to I <sub>or</sub> .							

Table 8.3.2A.3: Cell 2 (FDD cell) specific test parameters for TDD/FDD handover

Parameter	Unit	Cell 2		
		T1	T2	T3
CPICH_Ec/Ior	dB		-10	
PCCPCH_Ec/Ior	dB		-12	
SCH_Ec/Ior	dB		-12	
PICH_Ec/Ior	dB		-15	
DPCH_Ec/Ior	dB	n.a.		Note 1
OCNS_Ec/Ior	dB	-0.941		Note 2
CPICH_RSCP	dBm	-Inf		-75
$\hat{I}_{or}/I_{oc}$	dB	-Inf		5
$I_{oc}$	dBm/ 3,84 MHz			-70
Propagation Condition				AWGN
Note 1: The DPCH level is controlled by the power control loop				
Note 2: The power of the OCNS channel that is added shall make the total power from the cell to be equal to $I_{or}$ .				

### 8.3.2A.4.2 Procedure

- 1) The RF parameters are set up according to T1.
- 2) The UE is switched on.
- 3) A call is set up according to the test procedure to be specified in TS 34.108 [3] subclause 7.3.4.
- 4) SS shall transmit a MEASUREMENT CONTROL message.
- 5) After 5 seconds, the SS shall switch the power settings from T1 to T2.
- 6) UE shall transmit a MEASUREMENT REPORT message triggered by event 2B.
- 7) SS shall transmit a PHYSICAL CHANNEL RECONFIGURATION message with activation time at T3.
- 8) After 15 seconds, the SS shall switch the power settings from T2 to T3
- 9) UE shall transmit a PHYSICAL CHANNEL RECONFIGURATION COMPLETE message on the UL DCCH of cell 2. If the UE transmits the UL DPCCH to cell 2 less than 100 ms from the beginning of time period T3 then the number of successful tests is increased by one.
- 10) After 5 seconds, the UE is switched off. Any timing information of cell 2 is deleted in the UE.
- 11) Repeat step 1-10 until the confidence level according to annex F.6.2 is achieved..

### Specific Message Contents

All messages indicated below shall use the same content as described in the default message content in clause 9 of 34.108 [3] and in Annex A of 34.123-1 [21], with the following exceptions:

MEASUREMENT CONTROL message, event 2B (step 4):

Information Element/Group name	Value/Remark
Message Type (10.2.17)	
<b>UE information elements</b>	
-RRC transaction identifier	0
-Integrity check info	Not Present
<b>Measurement Information elements</b>	
-Measurement Identity	1
-Measurement Command (10.3.7.46)	Modify
-Measurement Reporting Mode (10.3.7.49)	AM RLC
-Periodical Reporting / Event Trigger Reporting Mode	Event trigger
-Additional measurements list (10.3.7.1)	Not Present
-CHOICE <i>Measurement type</i>	Inter-frequency measurement
-Inter-frequency measurement (10.3.7.16)	Not Present
-Inter-frequency measurement objects list (10.3.7.13)	Not Present
-Inter-frequency measurement quantity (10.3.7.18)	Inter-frequency reporting criteria
-CHOICE <i>reporting criteria</i>	
-Inter-frequency reporting criteria	
-Filter coefficient	0
-CHOICE <i>mode</i>	FDD
-Measurement quantity for frequency quality estimate	CPICH RSCP
-Inter-frequency reporting quantity (10.3.7.21)	
-UTRA Carrier RSSI	FALSE
-Frequency quality estimate	FALSE
-Non frequency related cell reporting quantities (10.3.7.5)	No Report
-SFN-SFN observed time difference reporting indicator	FALSE
-Cell synchronisation information reporting indicator	TRUE
-Cell Identity reporting indicator	FDD
-CHOICE <i>mode</i>	FALSE
-CPICH Ec/N0 reporting indicator	FALSE
-CPICH RSCP reporting indicator	TRUE
-Pathloss reporting indicator	FALSE
-Reporting cell status (10.3.7.61)	
-CHOICE <i>reported cell</i>	Report cells within monitored set on non-used frequency
-Maximum number of reported cells per reported non-used frequency	1
-Measurement validity (10.3.7.51)	Not Present
-Inter-frequency set update (10.3.7.22)	Not Present
-CHOICE <i>report criteria</i>	Inter-frequency measurement reporting criteria
-Inter-frequency measurement reporting criteria (10.3.7.19)	
-Parameters required for each event	1
-Inter-frequency event identity (10.3.7.14)	Event 2B
-Threshold used frequency	-71 dBm
-W used frequency	1
-Hysteresis	0 dB
-Time to trigger	0 ms
-Reporting cell status (10.3.7.61)	
-CHOICE <i>reported cell</i>	Report cells within monitored set on non-used frequency
-Maximum number of reported cells per reported non-used frequency	1
-Parameters required for each non-used frequency	1
-Threshold non-used frequency	-80 dBm
-W non-used frequency	1
<b>Physical channel information elements</b>	
-DPCH compressed mode status info (10.3.6.34)	Not Present

## PHYSICAL CHANNEL RECONFIGURATION message (step 7):

Information Element	Value/Remark
Message Type	
<b>UE Information Elements</b>	
-RRC transaction identifier	0
-Integrity check info	Not Present
-Integrity protection mode info	Not Present
-Ciphering mode info	Not Present
-Activation time	At T3
-New U-RNTI	Not Present
-New C-RNTI	Not Present
-RRC State Indicator	CELL_DCH
-UTRAN DRX cycle length coefficient	Not Present
<b>CN Information Elements</b>	
-CN Information info	Not Present
<b>UTRAN mobility information elements</b>	
-URA identity	Not Present
<b>RB information elements</b>	
-Downlink counter synchronisation info	Not Present
-RB with PDCP information list	Not Present
-RB with PDCP information	Not Present
<b>PhyCH information elements</b>	
-Frequency info (10.3.6.36)	
-CHOICE <i>mode</i>	FDD
-UARFCN uplink(Nu)	Same uplink UARFCN as used for cell 2
-UARFCN downlink(Nd)	Same downlink UARFCN as used for cell 2
<b>Uplink radio resources</b>	
-Maximum allowed UL TX power	33 dBm
-CHOICE <i>channel requirement</i>	Uplink DPCH info
-Uplink DPCH info (10.3.6.88)	
-Uplink DPCH power control info (10.3.6.91)	
-CHOICE <i>mode</i>	FDD
-DPCCH power offset	-6dB
- PC Preamble	1 frame
- SRB delay	7 frames
- Power Control Algorithm	Algorithm1
- TPC step size	1dB
-CHOICE <i>mode</i>	FDD
-Scrambling code type	Long
-Scrambling code number	0 (0 to 16777215)
-Number of DPDCH	Not Present(1)
-Spreading factor	SF is reference to TS34.108 clause 6.10 Parameter Set
-TFCI existence	TRUE
-Number of FBI bit	Not Present(0)
-Puncturing Limit	Reference to TS34.108 clause 6.10 Parameter Set
<b>Downlink radio resources</b>	
-CHOICE <i>mode</i>	FDD
-Downlink PDSCH information	Not Present
-Downlink information common for all radio links (10.3.6.24)	
-Downlink DPCH info common for all RL (10.3.6.18)	
-Timing indicator	Initialise
-CFN-targetSFN frame offset	Not Present
-Downlink DPCH power control information (10.3.6.23)	
-DPC mode	0 (single)
-CHOICE <i>mode</i>	FDD
-Power offset $P_{\text{Pilot-DPDCH}}$	TBD
-DL rate matching restriction information	Not Present
-Spreading factor	Reference to TS34.108 clause 6.10 Parameter Set
-Fixed or Flexible Position	Flexible
-TFCI existence	TRUE
-CHOICE <i>SF</i>	Not Present
-Number of bits for Pilot bits(SF=128,256)	Not Present
-CHOICE <i>mode</i>	FDD
-DPCH compressed mode info (10.3.6.33)	Not Present (Note 1)



Information Element	Value/Remark
-TX Diversity mode (10.3.6.86)	None
-SSDT information (10.3.6.77)	Not Present
-Default DPCH Offset Value (10.3.6.16)	0
-Downlink information per radio link list	1
-Downlink information for each radio link (10.3.6.27)	
-CHOICE <i>mode</i>	FDD
-Primary CPICH info (10.3.6.60)	
-Primary scrambling code	350
-PDSCH with SHO DCH info (10.3.6.47)	Not Present
-PDSCH code mapping (10.3.6.43)	Not Present
-Downlink DPCH info for each RL (10.3.6.21)	
-CHOICE <i>mode</i>	FDD
-Primary CPICH usage for channel estimation	Primary CPICH may be used
-DPCH frame offset	0 chips
-Secondary CPICH info	Not Present
-DL channelisation code	
-Secondary scrambling code	1
-Spreading factor	Reference to TS34.108 clause 6.10
-Code number	Parameter Set
-Scrambling code change	SF-1(SF is reference to TS34.108 clause 6.10 Parameter Set)
-TPC combination index	No change
-SSDT Cell Identity	0
- Closed loop timing adjustment mode	-a
- SCCPCH information for FACH (10.3.6.70)	Not Present
	Not Present
Note 1: IE "DPCH compressed mode info" is not needed as default values are applied that have previously been received in RADIO BEARER SETUP or RRC CONNECTION SETUP	

MEASUREMENT REPORT message for Inter frequency test cases

Information Element	Value/remark
Message Type (10.2.17)	
Integrity check info	Not Present
Measurement identity	1
Measured Results (10.3.7.44)	
-CHOICE Measurement	Inter-frequency Measured results list
-Inter-frequency measured results	1
-Frequency info	
-CHOICE mode	FDD
-UARFCN uplink (Nu)	Not Present
-UARFCN downlink (Nd)	Same frequency as channel 2 in Table 8.3.2.3
-UTRA carrier RSSI	Not Present
-Inter-frequency cell measured results	1
-Cell measured results (10.3.7.3)	
-Cell identity	Checked that this IE is present
-SFN-SFN observed time difference	Not Present
-Cell synchronisation info	Not Present
-CHOICE mode	FDD
-Primary CPICH Info	
-Primary scrambling code	Set to Primary scrambling code of Cell2
-CPICH Ec/No	Not Present
-CPICH RSCP	Checked that this IE is present
-Pathloss	Not Present
Measured results on RACH	Not Present
Additional measured results	Not Present
Event results (10.3.7.7)	
-CHOICE event result	Inter-frequency measurement event results
-Inter-frequency event identity	2B
-Inter-frequency cells	1
-Frequency Info	
-CHOICE mode	FDD
-UARFCN uplink (Nu)	Not Present
-UARFCN downlink (Nd)	Same frequency as channel 2 in Table 8.3.2.3
-CHOICE mode	FDD
-Primary CPICH info	
-Primary Scrambling Code	Set to Primary scrambling code of Cell2

### 8.3.2A.5 Test requirements

For the test to pass, the total number of successful tests shall be more than 90% with a confidence level of 95% of the cases.

Note: If the above Test Requirement differs from the Minimum Requirement then the Test Tolerance applied for this test is non-zero. The Test Tolerance for this test is defined in clause F.2 and the explanation of how the Minimum Requirement has been relaxed by the Test Tolerance is given in clause F.4.

## 8.3.2B TDD/FDD Handover for 7,68 Mcps Option

### 8.3.2B.1 Definition and applicability

The handover interruption time is defined as the time between the end of the last TTI containing a transport block on the old DPCH and the time the UE starts transmission of the new uplink DPCH.

The requirements and this test apply to the UTRA TDD / FDD UE.

### 8.3.2B.2 Minimum requirement

The interruption time shall be less than 100 ms in the single carrier case when the cell is known by the UE and the SFN of the target cell does not need to be decoded. The rate of correct handovers observed during repeated tests shall be at least 90% with a confidence level of 95%.

The interruption time is dependent on whether the target cell is known for the UE or not.

If TDD/FDD handover is commanded, the interruption time shall be less than,

$$T_{\text{interrupt}} = T_{\text{offset}} + 40 + 50 * KC + 150 * UC \text{ ms}$$

where,

$T_{\text{offset}}$	Equal to 10 ms, the frame timing uncertainty between the old cell and the target cell.
KC	Equal to 1 if a known target cell is indicated in the RRC message implying TDD/FDD handover and equal to 0 otherwise
UC	Equal to 1 if an unknown target cell is indicated in the RRC message implying TDD/FDD handover and equal to 0 otherwise

An inter-frequency FDD target cell shall be considered known by the UE, if the target cell has been measured by the UE during the last 5 seconds.

The phase reference is the Primary CPICH.

The interruption time requirements for an unknown target cell shall apply only if the signal quality of the unknown target cell is sufficient for successful synchronisation with one attempt.

The normative reference for this requirement is TS 25.123 [2] clauses 5.2 and A.5.3.

### 8.3.2B.3 Test purpose

The purpose of this test is to verify the requirement for the TDD/FDD handover delay in CELL\_DCH state.

### 8.3.2B.4 Method of test

#### 8.3.2B.4.1 Initial conditions

Test environment: normal; see clauses G.2.1 and G.2.2.

Frequencies to be tested: mid range; see clause G.2.4.

The test parameters are given in table 8.3.2B.1, 8.3.2B.2 and 8.3.2B.3 below. In the measurement control information it is indicated to the UE that event-triggered reporting with Event 1G and 2B shall be used. The CPICH\_RSCP of the best cell on the unused frequency shall be reported together with Event 2B reporting. The test consists of three successive time periods, with a time duration of T1, T2 and T3 respectively. At the start of time duration T1, the UE may not have any timing information of cell 2.

UTRAN shall send a Physical Channel reconfiguration message with activation time at the beginning of T3 with a new active cell, cell 2. The Physical Channel reconfiguration message shall be sent to the UE such that the delay between the end of the last received TTI containing the message and the beginning of T3 is at least equal to the RRC procedure delay as defined in [16].

Table 8.3.2B.1: General test parameters for TDD/FDD handover

Parameter		Unit	Value	Comment
DCH parameters			DL and UL Reference Measurement Channel 12.2 kbps	As specified in TS 25.102 annex A.2.2 and TS 25.101 annex A
Power Control			On	
Target quality value on DTCH		BLER	0.01	
Initial conditions	Active cell		Cell 1	TDD cell
	Neighbour cell		Cell 2	FDD cell
Final condition	Active cell		Cell 2	FDD cell
HCS			Not used	
	O	dB	0	Cell individual offset. This value shall be used for all cells in the test.
Hysteresis		dB	3	Hysteresis parameter for event 2B
Time to Trigger		ms	0	
Absolute threshold used frequency		dBm	-71	Applicable for Event 2B
Threshold non-used frequency		dBm	-80	Applicable for Event 2B
W non-used frequency			1	Applicable for Event 2B
Filter coefficient			0	
Monitored cell list size			6 TDD neighbours on Channel 1 6 FDD neighbours on Channel 2	
	T <sub>SI</sub>	s	1.28	The value shall be used for all cells in the test.
	T1	s	5	
	T2	s	15	
	T3	s	5	

Table 8.3.2B.2: Cell 1 specific test parameters for TDD/FDD handover

Parameter	Unit	Cell 1					
		0			2		
DL timeslot number		T1	T2	T3	T1	T2	T3
UTRA RF Channel Number		Channel 1					
PCCPCH_Ec/I <sub>or</sub>	dB	-3			n.a.		
SCH_Ec/I <sub>or</sub>	dB	-9			n.a.		
SCH_t <sub>offset</sub>	dB	0			n.a.		
DPCH_Ec/I <sub>or</sub>	dB	n.a.			Note 1		n.a.
OCNS_Ec/I <sub>or</sub>	dB	-3,12			Note 2		n.a.
$\hat{I}_{or}/I_{oc}$	dB	5	-1		5	-1	
PCCPCH RSCP	dBm	-68	-74		n.a.		
I <sub>oc</sub>	dBm/7, 68 MHz	-70					
Propagation Condition		AWGN					
The DPCH level is controlled by the power control loop The power of the OCNS channel that is added shall make the total power from the cell to be equal to I <sub>or</sub>							

**Table 8.3.2B.3: Cell 2 specific test parameters for TDD/FDD handover**

Parameter	Unit	Cell 2	
		T1, T2	T3
CPICH_Ec/I <sub>or</sub>	dB	-10	
PCCPCH_Ec/I <sub>or</sub>	dB	-12	
SCH_Ec/I <sub>or</sub>	dB	-12	
PICH_Ec/I <sub>or</sub>	dB	-15	
DPCH_Ec/I <sub>or</sub>	dB	n.a.	Note 1
OCNS_Ec/I <sub>or</sub>	dB	-0.941	Note 2
CPICH_RSCP	dBm	-83	-77
$\hat{I}_{or}/I_{oc}$	dB	-3	3
$I_{oc}$	dBm/7.6 8 MHz	-70	
Propagation Condition		AWGN	
Note 1: The DPCH level is controlled by the power control loop			
Note 2: The power of the OCNS channel that is added shall make the total power from the cell to be equal to $I_{or}$ .			

#### 8.3.2B.4.2 Procedure

- 1) The RF parameters are set up according to T1.
- 2) The UE is switched on.
- 3) A call is set up according to the test procedure specified in TS 34.108 [3] subclause 7.3.4.  
[Editor's note: subclause 7.3.4 in TS 34.108 (Message sequence chart for Handover Test procedure) is not yet specified]
- 4) SS shall transmit a MEASUREMENT CONTROL message.
- 5) After 5 seconds, the SS shall switch the power settings from T1 to T2.
- 6) UE shall transmit a MEASUREMENT REPORT message triggered by event 2B.
- 7) SS shall transmit a PHYSICAL CHANNEL RECONFIGURATION message with activation time at T3.
- 8) After 15 seconds, the SS shall switch the power settings from T2 to T3
- 9) UE shall transmit a PHYSICAL CHANNEL RECONFIGURATION COMPLETE message on the UL DCCH of cell 2. If the UE transmits the UL DPCCH to cell 2 less than 100 ms from the beginning of time period T3 then the number of successful tests is increased by one.
- 10) After 5 seconds, the UE is switched off. Any timing information of cell 2 is deleted in the UE.
- 11) Repeat step 1-10 until the confidence level according to annex F.6.2 is achieved..

#### Specific Message Contents

All messages indicated below shall use the same content as described in the default message content in clause 9 of 34.108 [3] and in Annex A of 34.123-1 [21], with the following exceptions:

MEASUREMENT CONTROL message, event 2B (step 4):

Information Element/Group name	Value/Remark
Message Type (10.2.17)	
<b>UE information elements</b>	
-RRC transaction identifier	0
-Integrity check info	Not Present
<b>Measurement Information elements</b>	
-Measurement Identity	1
-Measurement Command (10.3.7.46)	Modify
-Measurement Reporting Mode (10.3.7.49)	AM RLC
-Periodical Reporting / Event Trigger Reporting Mode	Event trigger
-Additional measurements list (10.3.7.1)	Not Present
-CHOICE <i>Measurement type</i>	Inter-frequency measurement
-Inter-frequency measurement (10.3.7.16)	Not Present
-Inter-frequency measurement objects list (10.3.7.13)	Not Present
-Inter-frequency measurement quantity (10.3.7.18)	Inter-frequency reporting criteria
-CHOICE <i>reporting criteria</i>	
-Inter-frequency reporting criteria	
-Filter coefficient	0
-CHOICE <i>mode</i>	FDD
-Measurement quantity for frequency quality estimate	CPICH RSCP
-Inter-frequency reporting quantity (10.3.7.21)	
-UTRA Carrier RSSI	FALSE
-Frequency quality estimate	FALSE
-Non frequency related cell reporting quantities (10.3.7.5)	No Report
-SFN-SFN observed time difference reporting indicator	FALSE
-Cell synchronisation information reporting indicator	TRUE
-Cell Identity reporting indicator	FDD
-CHOICE <i>mode</i>	FALSE
-CPICH Ec/N0 reporting indicator	FALSE
-CPICH RSCP reporting indicator	TRUE
-Pathloss reporting indicator	FALSE
-Reporting cell status (10.3.7.61)	
-CHOICE <i>reported cell</i>	Report cells within monitored set on non-used frequency
-Maximum number of reported cells per reported non-used frequency	1
-Measurement validity (10.3.7.51)	Not Present
-Inter-frequency set update (10.3.7.22)	Not Present
-CHOICE <i>report criteria</i>	Inter-frequency measurement reporting criteria
-Inter-frequency measurement reporting criteria (10.3.7.19)	
-Parameters required for each event	1
-Inter-frequency event identity (10.3.7.14)	Event 2B
-Threshold used frequency	-71 dBm
-W used frequency	1
-Hysteresis	0 dB
-Time to trigger	0 ms
-Reporting cell status (10.3.7.61)	
-CHOICE <i>reported cell</i>	Report cells within monitored set on non-used frequency
-Maximum number of reported cells per reported non-used frequency	1
-Parameters required for each non-used frequency	1
-Threshold non-used frequency	-80 dBm
-W non-used frequency	1
<b>Physical channel information elements</b>	
-DPCH compressed mode status info (10.3.6.34)	Not Present

## PHYSICAL CHANNEL RECONFIGURATION message (step 7):

Information Element	Value/Remark
Message Type	
<b>UE Information Elements</b>	
-RRC transaction identifier	0
-Integrity check info	Not Present
-Integrity protection mode info	Not Present
-Ciphering mode info	Not Present
-Activation time	At T3
-New U-RNTI	Not Present
-New C-RNTI	Not Present
-RRC State Indicator	CELL_DCH
-UTRAN DRX cycle length coefficient	Not Present
<b>CN Information Elements</b>	
-CN Information info	Not Present
<b>UTRAN mobility information elements</b>	
-URA identity	Not Present
<b>RB information elements</b>	
-Downlink counter synchronisation info	Not Present
-RB with PDCP information list	Not Present
-RB with PDCP information	Not Present
<b>PhyCH information elements</b>	
-Frequency info (10.3.6.36)	
-CHOICE <i>mode</i>	FDD
-UARFCN uplink(Nu)	Same uplink UARFCN as used for cell 2
-UARFCN downlink(Nd)	Same downlink UARFCN as used for cell 2
<b>Uplink radio resources</b>	
-Maximum allowed UL TX power	33 dBm
-CHOICE <i>channel requirement</i>	Uplink DPCH info
-Uplink DPCH info (10.3.6.88)	
-Uplink DPCH power control info (10.3.6.91)	
-CHOICE <i>mode</i>	FDD
-DPCCH power offset	-6dB
- PC Preamble	1 frame
- SRB delay	7 frames
- Power Control Algorithm	Algorithm1
- TPC step size	1dB
-CHOICE <i>mode</i>	FDD
-Scrambling code type	Long
-Scrambling code number	0 (0 to 16777215)
-Number of DPDCH	Not Present(1)
-Spreading factor	SF is reference to TS34.108 clause 6.10 Parameter Set
-TFCI existence	TRUE
-Number of FBI bit	Not Present(0)
-Puncturing Limit	Reference to TS34.108 clause 6.10 Parameter Set
<b>Downlink radio resources</b>	
-CHOICE <i>mode</i>	FDD
-Downlink PDSCH information	Not Present
-Downlink information common for all radio links (10.3.6.24)	
-Downlink DPCH info common for all RL (10.3.6.18)	
-Timing indicator	Initialise
-CFN-targetSFN frame offset	Not Present
-Downlink DPCH power control information (10.3.6.23)	
-DPC mode	0 (single)
-CHOICE <i>mode</i>	FDD
-Power offset $P_{\text{Pilot-DPDCCH}}$	TBD
-DL rate matching restriction information	Not Present
-Spreading factor	Reference to TS34.108 clause 6.10 Parameter Set
-Fixed or Flexible Position	Flexible
-TFCI existence	TRUE
-CHOICE <i>SF</i>	Not Present
-Number of bits for Pilot bits(SF=128,256)	Not Present
-CHOICE <i>mode</i>	FDD
-DPCH compressed mode info (10.3.6.33)	Not Present (Note 1)

Information Element	Value/Remark
-TX Diversity mode (10.3.6.86)	None
-SSDT information (10.3.6.77)	Not Present
-Default DPCH Offset Value (10.3.6.16)	0
-Downlink information per radio link list	1
-Downlink information for each radio link (10.3.6.27)	
-CHOICE <i>mode</i>	FDD
-Primary CPICH info (10.3.6.60)	
-Primary scrambling code	350
-PDSCH with SHO DCH info (10.3.6.47)	Not Present
-PDSCH code mapping (10.3.6.43)	Not Present
-Downlink DPCH info for each RL (10.3.6.21)	
-CHOICE <i>mode</i>	FDD
-Primary CPICH usage for channel estimation	Primary CPICH may be used
-DPCH frame offset	0 chips
-Secondary CPICH info	Not Present
-DL channelisation code	
-Secondary scrambling code	1
-Spreading factor	Reference to TS34.108 clause 6.10 Parameter Set
-Code number	SF-1(SF is reference to TS34.108 clause 6.10 Parameter Set)
-Scrambling code change	No change
-TPC combination index	0
- SSDT Cell Identity	-a
- Closed loop timing adjustment mode	Not Present
- SCCPCH information for FACH (10.3.6.70)	Not Present
Note 1: IE "DPCH compressed mode info" is not needed as default values are applied that have previously been received in RADIO BEARER SETUP or RRC CONNECTION SETUP	



MEASUREMENT REPORT message for Inter frequency test cases

Information Element	Value/remark
Message Type (10.2.17)	
Integrity check info	Not Present
Measurement identity	1
Measured Results (10.3.7.44)	
-CHOICE Measurement	Inter-frequency Measured results list
-Inter-frequency measured results	1
-Frequency info	
-CHOICE mode	FDD
-UARFCN uplink (Nu)	Not Present
-UARFCN downlink (Nd)	Same frequency as channel 2 in Table 8.3.2.3
-UTRA carrier RSSI	Not Present
-Inter-frequency cell measured results	1
-Cell measured results (10.3.7.3)	
-Cell identity	Checked that this IE is present
-SFN-SFN observed time difference	Not Present
-Cell synchronisation info	Not Present
-CHOICE mode	FDD
-Primary CPICH Info	
-Primary scrambling code	Set to Primary scrambling code of Cell2
-CPICH Ec/No	Not Present
-CPICH RSCP	Checked that this IE is present
-Pathloss	Not Present
Measured results on RACH	Not Present
Additional measured results	Not Present
Event results (10.3.7.7)	
-CHOICE event result	Inter-frequency measurement event results
-Inter-frequency event identity	2B
-Inter-frequency cells	1
-Frequency Info	
-CHOICE mode	FDD
-UARFCN uplink (Nu)	Not Present
-UARFCN downlink (Nd)	Same frequency as channel 2 in Table 8.3.2.3
-CHOICE mode	FDD
-Primary CPICH info	
-Primary Scrambling Code	Set to Primary scrambling code of Cell2

### 8.3.2B.5 Test requirements

For the test to pass, the total number of successful tests shall be more than 90% with a confidence level of 95% of the cases.

Note: If the above Test Requirement differs from the Minimum Requirement then the Test Tolerance applied for this test is non-zero. The Test Tolerance for this test is defined in clause F.2 and the explanation of how the Minimum Requirement has been relaxed by the Test Tolerance is given in clause F.4.

## 8.3.3 TDD/GSM Handover

### 8.3.3.1 Definition and applicability

#### 8.3.3.1.1 3,84 Mcps option

The UTRAN to GSM cell handover interruption time is defined as the time from the end of the last TTI containing an RRC message implying hard handover to the transmission on the channel of the new RAT.

The requirements and this test apply to the combined TDD (3,84 Mcps option) and GSM UE.

#### 8.3.3.1.2 1,28 Mcps option

The UTRAN to GSM cell handover delay is defined as the time from the end of the last TTI containing an RRC message implying hard handover to the transmission on the channel of the new RAT.

The requirements and this test apply to the combined TDD (1,28 Mcps option) and GSM UE

### 8.3.3.1.3 7,68 Mcps option

The UTRAN to GSM cell handover delay is defined as the time from the end of the last TTI containing an RRC message implying hard handover to the transmission on the channel of the new RAT.

The requirements and this test apply to the combined TDD (7,68 Mcps option) and GSM UE.

### 8.3.3.2 Minimum requirement

#### 8.3.3.2.1 3,84 Mcps option

The interruption time shall be less than 40 ms in the case where the UE has synchronised to the GSM cell before the HANOVER FROM UTRAN COMMAND is received. The rate of correct handovers observed during repeated tests shall be at least 90% with a confidence level of [FFS]%.

The normative reference for this requirement is TS 25.123 [2] clauses 5.3.2 and A.5.3.

#### 8.3.3.2.2 1,28 Mcps option

The handover delay shall be less than 90 ms in the case where the UE has synchronised to the GSM cell before the HANOVER FROM UTRAN COMMAND is received. The rate of correct handovers observed during repeated tests shall be at least 90% with a confidence level of 95%.

The normative reference for this requirement is TS 25.123 [2] clauses 5.3.2 and A.5.3.

#### 8.3.3.2.3 7,68 Mcps option

The handover delay shall be less than 90 ms in the case where the UE has synchronised to the GSM cell before the HANOVER FROM UTRAN COMMAND is received. The rate of correct handovers observed during repeated tests shall be at least 90% with a confidence level of 95%.

The normative reference for this requirement is TS 25.123 [2] clauses 5.3.2 and A.5.3.

### 8.3.3.3 Test purpose

#### 8.3.3.3.1 3,84 Mcps option

To verify that the UE meets the minimum requirement.

#### 8.3.3.3.2 1,28 Mcps option

To verify that the UE meets the minimum requirement.

### 8.3.3.4 Method of test

#### 8.3.3.4.1 3,84 Mcps option

##### 8.3.3.4.1.1 Initial conditions

Test environment: normal; see clauses G.2.1 and G.2.2.

Frequencies to be tested: mid range; see clause G.2.4 for TDD conditions, and clause A1.2 of TS 51.010-1 [23] for the corresponding GSM conditions.

The test parameters are given in Table 8.3.3.1, 8.3.3.2 and 8.3.3.3 below. In the measurement control information it is indicated to the UE that event-triggered reporting with Event 3C shall be used. The test consists of three successive time periods, with a time duration of T1, T2 and T3 respectively. At the start of time duration T1, the UE may not have any timing information of cell 2.

UTRAN shall send a HANOVER FROM UTRAN COMMAND message with activation time at beginning of T3 with one active cell, cell 2. The HANOVER FROM UTRAN COMMAND message shall be sent to the UE such that the delay between the last the end of the last received TTI containing the message and the beginning of T3 is at least equal to the RRC procedure delay as defined in [9]. In the GSM Handover command contained in this message, IE starting time shall not be included.

Cell 1 is a UTRA TDD cell and cell 2 is a GSM cell. The Beacon timeslot shall be transmitted in timeslot 0 for cell 1 and no second Beacon timeslot shall be provided for cell 1. The DL DPCH shall be transmitted in timeslot 1 and the UL DPCH shall be transmitted in timeslot 3.

**Table 8.3.3.1: General test parameters for TDD/GSM handover**

Parameter	Unit	Value	Comment
DCH parameters		DL Reference Measurement Channel 12.2 kbps	As specified in TS 25.102 section A.2.2
Power Control		On	
Target quality value on DTCH	BLER	0.01	
Initial conditions	Active cell	Cell 1	UTRA TDD cell
	Neighbour cell	Cell 2	GSM cell
Final condition	Active cell	Cell 2	GSM cell
Inter-RAT measurement quantity		GSM carrier RSSI	
BSIC verification required		Required	
Threshold other system	dBm	-80	Absolute GSM carrier RSSI threshold for Event 3C.
Hysteresis	dB	0	
Time to Trigger	ms	0	
Filter coefficient		0	
Monitored cell list size		12 TDD neighbours on Channel 1 6 GSM neighbours including ARFCN 1	Measurement control information is sent before the start of time period T1.
$T_{\text{identify abort}}$	s	5	
$T_{\text{reconfirm abort}}$	s	5	
T1	s	10	
T2	s	10	
T3	s	10	

**Table 8.3.3.2: Cell Specific Parameters for Handover UTRAN to GSM cell case (cell 1)**

Parameter	Unit	Cell 1					
		0			1		
DL timeslot number		T1	T2	T3	T1	T2	T3
UTRA RF Channel Number		Channel 1					
PCCPCH_Ec/I <sub>or</sub>	dB	-3			n.a.		
SCH_Ec/I <sub>or</sub>	dB	-9			n.a.		
SCH <sub>offset</sub>	dB	0			n.a.		
DPCH_Ec/I <sub>or</sub>	dB	n.a.			Note 1		n.a.
OCNS_Ec/I <sub>or</sub>	dB	-3,12			Note 2		n.a.
$\hat{I}_{or}/I_{oc}$	dB	6			6		
PCCPCH RSCP	dBm	-68			n.a.		
$I_{oc}$	dBm/3, 84 MHz	-70					
Propagation Condition		AWGN					
Note 1: The DPCH level is controlled by the power control loop							
Note 2: The power of the OCNS channel that is added shall make the total power from the cell to be equal to I <sub>or</sub> .							

**Table 8.3.3.3: Cell Specific Parameters for Handover UTRAN to GSM cell case (cell 2)**

Parameter	Unit	Cell 2	
		T1	T2, T3
Absolute RF Channel Number		ARFCN 1	
RXLEV	dBm	-85	-75

#### 8.3.3.4.1.2 Procedure

- 1) The RF parameters for cell 1 are set up according to T1.
- 2) The UE is switched on
- 3) A call is set up according to the test procedure specified in TS 34.108 [3] subclause 7.3.4
- 4) The RF parameters for cell 2 are set up according to T1 and the SS configures a traffic channel
- 5) SS shall transmit a MEASUREMENT CONTROL message to cell 1
- 6) After 10 seconds, the SS shall switch the power settings from T1 to T2
- 7) UE shall transmit a MEASUREMENT REPORT message triggered by event 3C
- 8) SS shall transmit a HANDOVER FROM UTRAN COMMAND message with activation time at T3 and indicating the traffic channel of the target GSM cell to the UE through DCCH of the serving UTRAN cell.
- 9) After 10 seconds, the SS shall switch the power settings from T2 to T3
- 10) UE shall transmit a burst on the traffic channel of cell 2 implying that it has switched to the GSM cell. The UE sends a HANDOVER ACCESS message. If the UE transmits access bursts on the new DCCH of the target cell less than 40 ms from the beginning of time period T3, then the number of successful tests is increased by one.  
[Editor's note: TS 34.108, 7.3.4 shall specify the messages HANDOVER ACCESS, PHYSICAL INFORMATION, SABM, UA and HANDOVER COMPLETE]
- 11) After 10 seconds, the UE is switched off. Any timing information of cell 2 is deleted in the UE.
- 12) Repeat step 1-11 [TBD] times

#### Specific Message Contents

All messages indicated below above shall use the same content as described in the default message content in clause 9 of 34.108 [3] with the following exceptions:

- Note: Numbers in brackets after an item e.g “Message Type (10.2.17)” in the IE description are references to clause numbers in TS 25.331 [9] describing that item in more detail.

MEASUREMENT CONTROL message (step 5):

Information Element/Group name	Value/Remark
Message Type (10.2.17)	
<b>UE information elements</b>	
-RRC transaction identifier	0
-Integrity check info	Not Present
<b>Measurement Information elements</b>	
-Measurement Identity	4
-Measurement Command (10.3.7.46)	Setup
-Measurement Reporting Mode (10.3.7.49)	AM RLC
-Periodical Reporting / Event Trigger Reporting Mode	Event trigger
-Additional measurements list (10.3.7.1)	Not Present
-CHOICE <i>Measurement type</i>	Inter-RAT measurement
-Inter-RAT measurement (10.3.7.27)	Not Present
-Inter-RAT measurement objects list (10.3.7.23)	
-Inter-RAT measurement quantity (10.3.7.29)	
-Measurement quantity for UTRAN quality estimate (10.3.7.38)	
-Filter coefficient	0
-CHOICE mode	TDD
-Measurement quantity list	1
-Measurement quantity	Primary CCPCH RSCP
-CHOICE system	GSM
-Measurement quantity	GSM Carrier RSSI
-Filter coefficient	0
-BSIC verification required	Required
-Inter-RAT reporting quantity (10.3.7.32)	Not Present
-Reporting cell status (10.3.7.61)	
-CHOICE reported cell	Report cells within active set or within virtual active set or of the other RAT
-Maximum number of reported cells	2
-CHOICE report criteria	Inter-RAT measurement reporting criteria
-Inter-RAT measurement reporting criteria (10.3.7.30)	
-Parameters required for each event	1
-Inter-RAT event identity (10.3.7.24)	Event 3C
-Threshold own system	Not Present
-W	Not Present
-Threshold other system	-80 dBm
-Hysteresis	0 dB
-Time to trigger	0 ms
-Reporting cell status (10.3.7.61)	Not Present
<b>Physical channel information elements</b>	
-DPCH compressed mode status info (10.3.6.34)	Not Present

HANDOVER FROM UTRAN COMMAND message (step 8):

Information Element	Value/remark
Message Type	
<b>UE information elements</b>	
-RRC transaction identifier	0
-Integrity check info	Not Present
-Activation time	At T3
<b>RB information elements</b>	
-RAB information list	1
-RAB Info	Not present
<b>Other information elements</b>	
-CHOICE System type	GSM
-Frequency Band	GSM/DCS 1800 Band
-GSM message	
-Single GSM message	[TBD]
-GSM message List	GSM HANDOVER COMMAND formatted as BIT STRING(1..512). The contents of the HANDOVER COMMAND see next table.

## HANDOVER COMMAND

Same as the HANDOVER COMMAND for M = 2 in clause 26.6.5.1 of TS 51.010, except that the CHANNEL MODE IE is included with value = speech full rate or half rate version 3

## MEASUREMENT REPORT message (step 7)

Information Element	Value/remark
Message Type (10.2.17)	
Integrity check info	Not Present
Measurement identity	1
Measured Results (10.3.7.44)	
-CHOICE Measurement	Inter-RAT Measured results list
-Inter-RAT-frequency measured results (10.3.7.26)	1
-CHOICE System	GSM
-Measured GSM cells	1
-GSM Carrier RSSI	Checked that this IE is present
-CHOICE BSIC	Verified BSIC
-inter-RAT cell id	Checked that this IE is present
-Observed Time difference to GSM cell	Not Present
Measured results on RACH	Not Present
Additional measured results	Not Present
Event results (10.3.7.7)	
-CHOICE event result	Inter-RAT measurement event results
-Inter-RAT event identity	3C
-Cells to report	1
-CHOICE BSIC	Verified BSIC
-inter-RAT cell id	Checked that this IE is present

## 8.3.3.4.2 1,28 Mcps option

Test environment: normal; see clauses G.2.1 and G.2.2.

Frequencies to be tested: mid range; see clause G.2.4 for TDD conditions, and clause A1.2 of TS 51.010-1 [24] for the corresponding GSM conditions.

The test parameters are given in Table 8.3.4.1, 8.3.4.2 and 8.3.4.3 below. In the measurement control information it is indicated to the UE that event-triggered reporting with Event 3C shall be used. The test consists of three successive time periods, with a time duration of T1, T2 and T3 respectively. At the start of time duration T1, the UE may not have any timing information of cell 2.

UTRAN shall send a HANDOVER FROM UTRAN COMMAND message with activation time "now" with one active cell, cell 2. The HANDOVER FROM UTRAN COMMAND message shall be sent to the UE during period T2. The starting point of T3 is defined as the end of the last TTI containing the HANDOVER COMMAND. In the GSM Handover command contained in this message, IE starting time shall not be included.

Cell 1 is a UTRA TDD cell and cell 2 is a GSM cell. The DL DPCH shall be transmitted in timeslot 4 and the UL DPCH shall be transmitted in timeslot 2.

**Table 8.3.3.4.1: General test parameters for 1,28Mcps TDD/GSM handover**

Parameter	Unit	Value	Comment
DCH parameters		DL Reference Measurement Channel 12.2 kbps	As specified in TS 25.102 section A
Power Control		On	
Target quality value on DTCH	BLER	0.01	
Initial conditions	Active cell	Cell 1	UTRA TDD cell
	Neighbour cell	Cell 2	GSM cell
Final condition	Active cell	Cell 2	GSM cell
Inter-RAT measurement quantity		GSM carrier RSSI	
BSIC verification required		Required	
Threshold other system	dBm	-80	Absolute GSM carrier RSSI threshold for Event 3C.
Hysteresis	dB	0	
Time to Trigger	ms	0	
Filter coefficient		0	
Monitored cell list size		12 TDD neighbours on Channel 1 6 GSM neighbours including ARFCN 1	Measurement control information is sent before the start of time period T1.
T <sub>identify abort</sub>	s	5	As specified in section 8.1A.2.5
T <sub>reconfirm abort</sub>	s	5	As specified in section 8.1A.2.5
T1	s	10	
T2	s	10	
T3	s	10	

**Table 8.3.3.4.2: Cell 1 (1,28Mcps )specific test parameters for TDD/GSM handover**

Parameter	Unit	Cell 1					
		0			DwPTS		
DL timeslot number		T1	T2	T3	T1	T2	T3
UTRA RF Channel Number		Channel 1					
PCCPCH_Ec/I <sub>or</sub>	dB	-3					
DwPCH_Ec/I <sub>or</sub>	dB				0		
OCNS_Ec/I <sub>or</sub>	dB	-3					
$\hat{I}_{or}/I_{oc}$	dB	5			5		
$I_{oc}$	dBm/1.28 MHz	-70					
Propagation Condition		AWGN					

**Table 8.3.3.4.3: Cell 2 (GSM )specific test parameters for TDD/GSM handover**

Parameter	Unit	Cell 2	
		T1	T2, T3
Absolute RF Channel Number		ARFCN 1	
RXLEV	dBm	-85	-75

#### 8.3.3.4.2.2 Procedure

- 1) The RF parameters for cell 1 are set up according to T1.
- 2) The UE is switched on
- 3) A call is set up according to the test procedure specified in TS 34.108 [3] subclause 7.3.4
- 4) The RF parameters for cell 2 are set up according to T1 and the SS configures a traffic channel

- 5) SS shall transmit a MEASUREMENT CONTROL message to cell 1
- 6) After 10 seconds, the SS shall switch the power settings from T1 to T2
- 7) UE shall transmit a MEASUREMENT REPORT message triggered by event 3C
- 8) SS shall transmit a HANDOVER FROM UTRAN COMMAND message with activation time “now” and indicating the traffic channel of the target GSM cell to the UE through DCCH of the serving UTRAN cell. The start of T3 is defined as the end of the last TTI, containing the HANDOVER COMMAND.
- 10) UE shall transmit a burst on the traffic channel of cell 2 implying that it has switched to the GSM cell. The UE sends a HANDOVER ACCESS message. If the UE transmits access bursts on the new DCCH of the target cell less than 90 ms from the beginning of time period T3, then the number of successful tests is increased by one.
- 11) At the end of T3 the UE is switched off. Any timing information of cell 2 is deleted in the UE.
- 12) Repeat step 1-11 until the confidence level according to annex F.6.2A is achieved

#### Specific Message Contents

All messages shall use the same content as described in the default message content in clause 9 of 34.108 [3] with the following exceptions:

Note: 10.x.y.z in the IE description refers to clauses in TS 25.331 [9].



MEASUREMENT CONTROL message (step 5):

Information Element/Group name	Value/Remark
Message Type (10.2.17)	
<b>UE information elements</b>	
-RRC transaction identifier	0
-Integrity check info	Not Present
<b>Measurement Information elements</b>	
-Measurement Identity	4
-Measurement Command (10.3.7.46)	Setup
-Measurement Reporting Mode (10.3.7.49)	
-Measurement Report Transfer Mode	AM RLC
-Periodical Reporting / Event Trigger Reporting Mode	Event trigger
-Additional measurements list (10.3.7.1)	Not Present
-CHOICE <i>Measurement type</i>	Inter-RAT measurement
-Inter-RAT measurement (10.3.7.27)	
-Inter-RAT measurement objects list (10.3.7.23)	Not Present
-Inter-RAT measurement quantity (10.3.7.29)	
-Measurement quantity for UTRAN quality estimate (10.3.7.38)	
-Filter coefficient	0
-CHOICE mode	TDD
-Measurement quantity list	1
-Measurement quantity	Primary CCPCH RSCP
-CHOICE system	GSM
-Measurement quantity	GSM Carrier RSSI
-Filter coefficient	0
-BSIC verification required	Required
-Inter-RAT reporting quantity (10.3.7.32)	Not Present
-Reporting cell status (10.3.7.61)	
-CHOICE reported cell	Report cells within active set or within virtual active set or of the other RAT
-Maximum number of reported cells	2
-CHOICE report criteria	Inter-RAT measurement reporting criteria
-Inter-RAT measurement reporting criteria (10.3.7.30)	
-Parameters required for each event	1
-Inter-RAT event identity (10.3.7.24)	Event 3C
-Threshold own system	Not Present
-W	Not Present
-Threshold other system	-80 dBm
-Hysteresis	0 dB
-Time to trigger	0 ms
-Reporting cell status (10.3.7.61)	Not Present
<b>Physical channel information elements</b>	
-DPCH compressed mode status info (10.3.6.34)	Not Present

HANDOVER FROM UTRAN COMMAND message (step 8):

Information Element	Value/remark
Message Type(10.2.15)	
<b>UE information elements</b> -RRC transaction identifier -Integrity check info -Activation time	0 Not Present now
<b>RB information elements</b> -RAB information list -RAB Info	1 Not present
- RAB identity	0000 0001B The first/ leftmost bit of the bit string contains the most significant bit of the RAB identity.
- CN domain identity	CS domain
- NAS Synchronization Indicator	Not present
- Re-establishment timer	Use T315
<b>Other information elements</b> -CHOICE System type -Frequency Band  -CHOICE GSM message - Single GSM message	GSM Set to "GSM/ PCS 1900" if GSM/ PCS 1900 is used in this test. Otherwise set to "GSM/DCS 1800 Band"  GSM HANDOVER COMMAND formatted and coded according to GSM specifications as BIT STRING (1..512). The first/ <i>leftmost/ most significant</i> bit of the bit string contains bit 8 of the first octet of the GSM message. The contents of the HANDOVER COMMAND see next table.

HANDOVER COMMAND

Information Element (GSM)	Value/remark	Version
Protocol Discriminator	RR Management.	
Skip Indicator	0000	
Message Type	00101011	
Cell Description		
- Network Colour Code	1	
- Base station Colour Code	5	
- BCCH Carrier Number	1	
Channel Description 2		
- Channel Type and TDMA offset	TCH/F + ACCHs	
- Timeslot Number	Chosen arbitrarily by the test house, but not Zero.	
- Training Sequence Code	Chosen arbitrarily by the test house.	
- Hopping	Single RF channel.	
- ARFCN	1	
Handover Reference		
- Handover Reference Value	Chosen arbitrarily by the test house.	
Power Command and ACCESS Type		
- ATC	0	
- EPC_mode	0	
- FPC	0	REL-5 R99 and REL-4 only REL-5
- EPC_FPC	0	
- Power level	Chosen arbitrarily by the test house.	
Synchronization Indication	Not present.	
Channel Mode	speech full rate or half rate version 1	
All other information elements	Not present.	

## MEASUREMENT REPORT message (step 7)

Information Element	Value/remark
Message Type (10.2.17)	Not Present
Integrity check info	1
Measurement identity	1
Measured Results (10.3.7.44)	Inter-RAT Measured results list
-CHOICE Measurement	1
-Inter-RAT-frequency measured results (10.3.7.26)	GSM
-CHOICE System	1
-Measured GSM cells	Checked that this IE is present
-GSM Carrier RSSI	Verified BSIC
-CHOICE BSIC	Checked that this IE is present
-inter-RAT cell id	Not Present
-Observed Time difference to GSM cell	Not Present
Measured results on RACH	Not Present
Additional measured results	Not Present
Event results (10.3.7.7)	Inter-RAT measurement event results
-CHOICE event result	3C
-Inter-RAT event identity	1
-Cells to report	Verified BSIC
-CHOICE BSIC	Checked that this IE is present
-inter-RAT cell id	

## 8.3.3.4.3 7,68 Mcps option

## 8.3.3.4.3.1 Initial conditions

Test environment: normal; see clauses G.2.1 and G.2.2.

Frequencies to be tested: mid range; see clause G.2.4 for TDD conditions, and clause A1.2 of TS 51.010-1 [23] for the corresponding GSM conditions.

The test parameters are given in Table 8.3.3.4.1B, 8.3.3.4.2B and 8.3.3.4.3B below. In the measurement control information it is indicated to the UE that event-triggered reporting with Event 3C shall be used. The test consists of three successive time periods, with a time duration of T1, T2 and T3 respectively. At the start of time duration T1, the UE may not have any timing information of cell 2.

UTRAN shall send a HANOVER FROM UTRAN COMMAND message with activation time at beginning of T3 with one active cell, cell 2. The HANOVER FROM UTRAN COMMAND message shall be sent to the UE such that the delay between the last the end of the last received TTI containing the message and the beginning of T3 is at least equal to the RRC procedure delay as defined in [9]. In the GSM Handover command contained in this message, IE starting time shall not be included.

Cell 1 is a UTRA TDD cell and cell 2 is a GSM cell. The Beacon timeslot shall be transmitted in timeslot 0 for cell 1 and no second Beacon timeslot shall be provided for cell 1. The DL DPCH shall be transmitted in timeslot 1 and the UL DPCH shall be transmitted in timeslot 3.

Table 8.3.3.4.1B: General test parameters for TDD/GSM handover

Parameter	Unit	Value	Comment
DCH parameters		DL Reference Measurement Channel 12.2 kbps	As specified in TS 25.102 section A.2.2
Power Control		On	
Target quality value on DTCH	BLER	0.01	
Initial conditions	Active cell	Cell 1	UTRA TDD cell
	Neighbour cell	Cell 2	GSM cell
Final condition	Active cell	Cell 2	GSM cell
Inter-RAT measurement quantity		GSM carrier RSSI	
BSIC verification required		Required	
Threshold other system	dBm	-80	Absolute GSM carrier RSSI threshold for Event 3C.
Hysteresis	dB	0	
Time to Trigger	ms	0	
Filter coefficient		0	
Monitored cell list size		12 TDD neighbours on Channel 1 6 GSM neighbours including ARFCN 1	Measurement control information is sent before the start of time period T1.
T <sub>identify abort</sub>	s	5	As specified in section 8.1.2.5
T <sub>reconfirm abort</sub>	s	5	As specified in section 8.1.2.5
T1	s	10	
T2	s	10	
T3	s	10	

Table 8.3.3.4.2B: Cell Specific Parameters for Handover UTRAN to GSM cell case (cell 1)

Parameter	Unit	Cell 1					
		0			1		
DL timeslot number		T1	T2	T3	T1	T2	T3
UTRA RF Channel Number		Channel 1					
PCCPCH_Ec/I <sub>or</sub>	dB	-3			n.a.		
SCH_Ec/I <sub>or</sub>	dB	-9			n.a.		
SCH_t <sub>offset</sub>	dB	0			n.a.		
DPCH_Ec/I <sub>or</sub>	dB	n.a.			Note 1		n.a.
OCNS_Ec/I <sub>or</sub>	dB	-3,12			Note 2		n.a.
$\hat{I}_{or}/I_{oc}$	dB	6			6		
PCCPCH RSCP	dBm	-68			n.a.		
$I_{oc}$	dBm/7,6 8 MHz	-70					
Propagation Condition		AWGN					
Note 1: The DPCH level is controlled by the power control loop							
Note 2: The power of the OCNS channel that is added shall make the total power from the cell to be equal to I <sub>or</sub> .							

Table 8.3.3.4.3B: Cell Specific Parameters for Handover UTRAN to GSM cell case (cell 2)

Parameter	Unit	Cell 2	
		T1	T2, T3
Absolute RF Channel Number		ARFCN 1	
RXLEV	dBm	-85	-75

## 8.3.3.4.3.2 Procedure

- 1) The RF parameters for cell 1 are set up according to T1.
- 2) The UE is switched on

- 3) A call is set up according to the test procedure specified in TS 34.108 [3] subclause 7.3.4
- 4) The RF parameters for cell 2 are set up according to T1 and the SS configures a traffic channel
- 5) SS shall transmit a MEASUREMENT CONTROL message to cell 1
- 6) After 10 seconds, the SS shall switch the power settings from T1 to T2
- 7) UE shall transmit a MEASUREMENT REPORT message triggered by event 3C
- 8) SS shall transmit a HANDOVER FROM UTRAN COMMAND message with activation time at T3 and indicating the traffic channel of the target GSM cell to the UE through DCCH of the serving UTRAN cell.
- 9) After 10 seconds, the SS shall switch the power settings from T2 to T3
- 10) UE shall transmit a burst on the traffic channel of cell 2 implying that it has switched to the GSM cell. The UE sends a HANDOVER ACCESS message. If the UE transmits access bursts on the new DCCH of the target cell less than 40 ms from the beginning of time period T3, then the number of successful tests is increased by one.  
[Editor's note: TS 34.108, 7.3.4 shall specify the messages HANDOVER ACCESS, PHYSICAL INFORMATION, SABM, UA and HANDOVER COMPLETE]
- 11) After 10 seconds, the UE is switched off. Any timing information of cell 2 is deleted in the UE.
- 12) Repeat step 1-11 until the confidence level according to annex F.6.2 is achieved.

#### Specific Message Contents

All messages indicated below above shall use the same content as described in the default message content in clause 9 of 34.108 [3] with the following exceptions:

- Note: Numbers in brackets after an item e.g “Message Type (10.2.17)” in the IE description are references to clause numbers in TS 25.331 [9] describing that item in more detail.

MEASUREMENT CONTROL message (step 5):

Information Element/Group name	Value/Remark
Message Type (10.2.17)	
<b>UE information elements</b>	
-RRC transaction identifier	0
-Integrity check info	Not Present
<b>Measurement Information elements</b>	
-Measurement Identity	4
-Measurement Command (10.3.7.46)	Setup
-Measurement Reporting Mode (10.3.7.49)	AM RLC
-Periodical Reporting / Event Trigger Reporting Mode	Event trigger
-Additional measurements list (10.3.7.1)	Not Present
-CHOICE <i>Measurement type</i>	Inter-RAT measurement
-Inter-RAT measurement (10.3.7.27)	Not Present
-Inter-RAT measurement objects list (10.3.7.23)	
-Inter-RAT measurement quantity (10.3.7.29)	
-Measurement quantity for UTRAN quality estimate (10.3.7.38)	
-Filter coefficient	0
-CHOICE mode	TDD
-Measurement quantity list	1
-Measurement quantity	Primary CCPCH RSCP
-CHOICE system	GSM
-Measurement quantity	GSM Carrier RSSI
-Filter coefficient	0
-BSIC verification required	Required
-Inter-RAT reporting quantity (10.3.7.32)	Not Present
-Reporting cell status (10.3.7.61)	
-CHOICE reported cell	Report cells within active set or within virtual active set or of the other RAT
-Maximum number of reported cells	2
-CHOICE report criteria	Inter-RAT measurement reporting criteria
-Inter-RAT measurement reporting criteria (10.3.7.30)	
-Parameters required for each event	1
-Inter-RAT event identity (10.3.7.24)	Event 3C
-Threshold own system	Not Present
-W	Not Present
-Threshold other system	-80 dBm
-Hysteresis	0 dB
-Time to trigger	0 ms
-Reporting cell status (10.3.7.61)	Not Present
<b>Physical channel information elements</b>	
-DPCH compressed mode status info (10.3.6.34)	Not Present

HANDOVER FROM UTRAN COMMAND message (step 8):

Information Element	Value/remark
Message Type	
<b>UE information elements</b>	
-RRC transaction identifier	0
-Integrity check info	Not Present
-Activation time	At T3
<b>RB information elements</b>	
-RAB information list	1
-RAB Info	Not present
<b>Other information elements</b>	
-CHOICE System type	GSM
-Frequency Band	GSM/DCS 1800 Band
-GSM message	
-Single GSM message	[TBD]
-GSM message List	GSM HANDOVER COMMAND formatted as BIT STRING(1..512). The contents of the HANDOVER COMMAND see next table.

## HANDOVER COMMAND

Same as the HANDOVER COMMAND for M = 2 in clause 26.6.5.1 of TS 51.010, except that the CHANNEL MODE IE is included with value = speech full rate or half rate version 3

## MEASUREMENT REPORT message (step 7)

Information Element	Value/remark
Message Type (10.2.17)	
Integrity check info	Not Present
Measurement identity	1
Measured Results (10.3.7.44)	
-CHOICE Measurement	Inter-RAT Measured results list
-Inter-RAT-frequency measured results (10.3.7.26)	1
-CHOICE System	GSM
-Measured GSM cells	1
-GSM Carrier RSSI	Checked that this IE is present
-CHOICE BSIC	Verified BSIC
-inter-RAT cell id	Checked that this IE is present
-Observed Time difference to GSM cell	Not Present
Measured results on RACH	Not Present
Additional measured results	Not Present
Event results (10.3.7.7)	
-CHOICE event result	Inter-RAT measurement event results
-Inter-RAT event identity	3C
-Cells to report	1
-CHOICE BSIC	Verified BSIC
-inter-RAT cell id	Checked that this IE is present

## 8.3.3.5 Test requirements

## 8.3.3.5.1 3,84 Mcps option

For the test to pass, the total number of successful tests shall be more than 90% with a confidence level of [FFS]% of the cases.

NOTE: If the above Test Requirement differs from the Minimum Requirement then the Test Tolerance applied for this test is non-zero. The Test Tolerance for this test is defined in clause F.2 and the explanation of how the Minimum Requirement has been relaxed by the Test Tolerance is given in clause F.4.

## 8.3.3.5.2 1,28 Mcps option

For the test to pass, the total number of successful tests shall be more than 90% with a confidence level of 95% of the cases.

NOTE: If the above Test Requirement differs from the Minimum Requirement then the Test Tolerance applied for this test is non-zero. The Test Tolerance for this test is defined in clause F.2 and the explanation of how the Minimum Requirement has been relaxed by the Test Tolerance is given in clause F.4.

## 8.3.3.5.3 7,68 Mcps option

For the test to pass, the total number of successful tests shall be more than 90% with a confidence level of 95% of the cases.

NOTE: If the above Test Requirement differs from the Minimum Requirement then the Test Tolerance applied for this test is non-zero. The Test Tolerance for this test is defined in clause F.2 and the explanation of how the Minimum Requirement has been relaxed by the Test Tolerance is given in clause F.4.

## 8.3.3a UTRA TDD to E-UTRA FDD Handover

*Editor's note: This section is incomplete. The following aspects are either missing or not yet determined:*

- The Test system uncertainties applicable to this test are undefined
- The Test tolerances applicable to this test are undefined

- *Some of the specific message contents are undefined*
- *Statistical testing of handover delay performance requirements is undefined*

### 8.3.3a.1 Definition and applicability

8.3.3a.1.1 3,84 Mcps option

8.3.3a.1.2 1,28 Mcps option

The UTRAN TDD to E-UTRAN FDD cell handover delay is defined as the time from the end of the last TTI containing an RRC message implying hard handover to the transmission on the channel of the new RAT.

The requirements and this test apply to the combined UTRAN TDD (1,28 Mcps option) and E-UTRAN FDD UE

8.3.3a.1.3 7,68 Mcps option

### 8.3.3a.2 Minimum requirement

8.3.3a.2.1 3,84 Mcps option

8.3.3a.2.2 1,28 Mcps option

The UE shall start to transmit the PRACH to target cell less than [85] ms from the beginning of time period T3.

The rate of correct handovers observed during repeated tests shall be at least 90%.

#### NOTE:

When the UE receives a RRC HANDOVER FROM UTRAN COMMAND message with activation time "now" or earlier than RRC procedure delay seconds from the end of the last TTI containing the RRC command, the UE shall be ready to start the transmission of the new uplink PRACH channel within  $D_{\text{handover}}$  seconds from the end of the last TTI containing the RRC command, where:

$D_{\text{handover}}$  equals the maximum RRC procedure delay defined plus the interruption time

The UE shall process the RRC procedures for the RRC HANDOVER FROM UTRAN COMMAND within [50] ms, which is noted as RRC procedure delay.

If the access is delayed to an indicated activation time later than RRC procedure delay seconds from the end of the last TTI containing the RRC command, the UE shall be ready to start the transmission of the new uplink PRACH channel at the designated activation time + interruption time.

The interruption time is the time between end of the last TTI in which the UE has received the handover command and the time the UE starts transmission of the PRACH in the new E-UTRA cell, excluding the RRC procedure delay. This requirement applies when UE is not required to perform any synchronisation procedure before transmitting on the new PRACH. When inter-RAT handover to E-UTRAN is commanded, the interruption time shall be less than  $T_{\text{interrupt}}$ :

$$T_{\text{interrupt}} = T_{\text{search}} + T_{\text{IU}} + 20 \text{ ms}$$

where

$T_{\text{search}}$  is the time required to search the target cell when the target cell is not already known when the handover command is received by the UE. If the target cell is known, then  $T_{\text{search}} = 0$  ms.

$T_{\text{IU}}$  is the interruption uncertainty in acquiring the first available PRACH occasion in the new cell.  $T_{\text{IU}}$  can be up to 30 ms. The actual value of  $T_{\text{IU}}$  shall depend upon the PRACH configuration used in the target cell.

The normative reference for this requirement is TS 25.123 [2] clauses 5.3a and A.5.3a.



8.3.3a.2.3 7,68 Mcps option

8.3.3a.3 Test purpose

8.3.3a.3.1 3,84 Mcps option

8.3.3a.3.2 1,28 Mcps option

To verify that the UE meets the minimum requirement.

8.3.3a.3.3 7,68 Mcps option

8.3.3a.4 Method of test

8.3.3a.4.1 3,84 Mcps option

8.3.3a.4.2 1,28 Mcps option

8.3.3a.4.2.1 Initial conditions

Test environment: normal; see clauses G.2.1 and G.2.2.

Frequencies to be tested: mid range; see clause G.2.4.

The test scenario comprises of 1 UTRAN TDD cell and 1 E-UTRAN FDD cell as given in Table 8.3.3a.1, Table 8.3.3a.2, and Table 8.3.3a.3. Idle interval of 80ms period as defined in TS25.331 is configured before T2 begins to enable E-UTRAN monitoring.

The test consists of three successive time periods, with time durations of T1, T2 and T3 respectively.

A RRC message implying handover shall be sent to the UE during period T2, after the UE has reported Event 3a. The end of the last TTI containing handover message is begin of T3 duration.

**Table 8.3.3a.1: General test parameters for UTRAN TDD to E-UTRAN FDD handover test case**

Parameter		Unit	Value	Comment
DPCH parameters active cell			DL Reference Measurement Channel 12.2 kbps	As specified in TS 25.102 section A. The DPCH is located in an other timeslot than 0.
PDSCH parameters			DL Reference Measurement Channel R.0 FDD	As specified in TS 36.133 section A.3.1.1.1
PCFICH/PDCCH/PHICH parameters			DL Reference Measurement Channel R.6 FDD	As specified in TS 36.133 section A.3.1.2.1
Initial conditions	Active cell		Cell 1	UTRA 1.28Mcps TDD cell
	Neighbour cell		Cell 2	E-UTRA FDD cell

Final conditions	Active cell		Cell 2	E-UTRA FDD cell
CP length of cell 2			normal	
PRACH configuration			4	As specified in table 5.7.1-2 in 3GPP TS 36.211
Idle intervals period	ms		80	As specified in TS 25.331
Handover activation time			now	
Access Barring Information			Not Sent	No additional delays in random access procedure.
$CIO_{other\_RAT}$	dB		0	Cell individual offset
$H_{3c}$	dB		0	Hysteresis parameter for event 3a
$T_{Used}$	dBm		-79	UTRA event 3a threshold
$T_{other\_RAT}$	dBm		-94	Absolute RSRP threshold for event 3a
TimeToTrigger	dB		0	
Filter coefficient			0	L3 filtering is not used
T1	s		5	
T2	s		≤10	
T3	s		1	

**Table 8.3.3a.2: Cell specific test parameters for UTRAN TDD to E-UTRAN FDD handover test case (cell 1)**

Parameter	Unit	Cell 1 (UTRA)					
		0			DwPTS		
Timeslot Number		T1	T2	T3	T1	T2	T3
UTRA RF Channel Number*		Channel 1					
PCCPCH_Ec/lor	dB	-3					
DwPCH_Ec/lor	dB				0		
OCNS_Ec/lor	dB	-3					
$\hat{I}_{or} / I_{oc}$	dB	$\frac{11+}{TT}$	$\frac{-}{3+T}$	$\frac{-}{3+T}$	$\frac{11+}{TT}$	$\frac{-}{3+T}$	$\frac{-}{3+T}$
$I_{oc}$	dBm/1.28 MHz	-80					
PCCPCH RSCP	dBm	$\frac{-}{72+}$	$\frac{-}{86+}$	$\frac{-}{86+}$	n.a.		
Propagation Condition		AWGN					
* Note: In the case of multi-frequency cell, the UTRA RF Channel Number is the primary frequency's channel number.							

**Table 8.3.3a.3: Cell specific test parameters for UTRAN TDD to E-UTRAN FDD handover test case (cell 2)**

Parameter	Unit	Cell 2		
		T1	T2	T3

E-UTRA RF Channel Number		2		
BW <sub>channel</sub>	MHz	10		
OCNG Patterns defined in TS36.133 A.3.2.1.1 (OP.1 FDD) and in A.3.2.1.2 (OP.2 FDD)		OP.2 FDD	OP.2 FDD	OP.1 FDD
PBCH_RA	dB	0	0	0
PBCH_RB	dB			
PSS_RB	dB			
SSS_RB	dB			
PCFICH_PA	dB			
PHICH_PA	dB			
PHICH_PB	dB			
PDCCH_PA	dB			
PDCCH_PB	dB			
PDSCH_PA	dB			
PDSCH_PB	dB			
OCNG_RA <sup>Note 1</sup>	dB			
OCNG_RB <sup>Note 1</sup>	dB			
$\hat{E}_s / N_{oc}$	dB			
$N_{oc}$	dBm/15kHz	-98		
$\hat{E}_s / I_{ot}$	dB	-3+TT	11+TT	11+TT
RSRP	dBm/15kHz	-101+TT	-87+TT	-87+TT
SCH_RP	dBm/15 kHz	-101+TT	-87+TT	-87+TT
Propagation Condition		AWGN		
Note 1: OCNG shall be used such that cell is fully allocated and a constant total transmitted power spectral density is achieved for all OFDM symbols.				

### 8.3.3a.4.2.2 Procedure

- 1) The RF parameters for cell 1 are set up according to T1 in table 8.3.3a.2
- 2) The UE is switched on
- 3) A call is set up according to the test procedure specified in TS 34.108 [3] subclause 7.3.4
- 4) The RF parameters for cell 2 are set up according to T1 in table 8.3.3a.3 and the SS configures a traffic channel
- 5) SS shall transmit a MEASUREMENT CONTROL message to cell 1
- 6) After 5 seconds, the SS shall switch the power settings from T1 to T2.
- 7) UE shall transmit a MEASUREMENT REPORT message triggered by event 3A
- 8) SS shall transmit a HANDOVER FROM UTRAN COMMAND message with activation time “now” and indicating the traffic channel of the target E-UTRAN cell to the UE through DCCH of the serving UTRAN cell. The start of T3 is defined as the end of the last TTI, containing the HANDOVER COMMAND.
- 10) The UE shall transmit a PRACH to cell 2 implying that it has switched to the E-UTRAN FDD cell. If the UE transmits the PRACH to cell2 less than [85] ms from the beginning of time period T3, then the number of successful tests is increased by one
- 11) At the end of T3 SS shall end the call and UE is switched off. Any timing information of cell 2 is deleted in the UE.
- 12) Repeat step 1-11 until the confidence level according to annex FFS is achieved

## Specific Message Contents

All messages shall use the same content as described in the default message content in clause 9 of 34.108 [3] with the following exceptions:

MEASUREMENT CONTROL message (step 5):

Information Element/Group name	Value/Remark
Message Type (10.2.17 of 25.331)	
<b>UE information elements</b>	
-RRC transaction identifier	0
-Integrity check info	Not Present
<b>Measurement Information elements</b>	
-Measurement Identity	2
-Measurement Command (10.3.7.46)	Setup
-Measurement Reporting Mode (10.3.7.49)	AM RLC
-Measurement Report Transfer Mode	Event trigger
-Periodical Reporting / Event Trigger Reporting Mode	Not Present
-Additional measurements list (10.3.7.1)	
-CHOICE <i>Measurement type</i>	Inter-RAT measurement
-Inter-RAT measurement (10.3.7.27)	
-Inter-RAT measurement objects list (10.3.7.23)	Not Present
-Inter-RAT measurement quantity (10.3.7.29)	
-Measurement quantity for UTRAN quality estimate (10.3.7.38)	
-Filter coefficient	0
-CHOICE mode	TDD
-Measurement quantity	Primary CCPCH RSCP
-CHOICE system	E-UTRA
-Measurement quantity	RSRP
-Filter coefficient	0
-Inter-RAT reporting quantity (10.3.7.32)	
- UTRAN estimated quality	FALSE
- CHOICE system	E-UTRA
-E-UTRA	
- Reporting indicator	Measurement quantity
-Reporting cell status (10.3.7.61)	
-CHOICE report criteria	Inter-RAT measurement reporting criteria
-Inter-RAT measurement reporting criteria (10.3.7.30)	
-Parameters required for each event	1
-Inter-RAT event identity (10.3.7.24)	Event 3A
-Threshold own system	-79dBm
-W	Not Present
-Threshold other system	-94 dBm
-Hysteresis	0 dB
-Time to trigger	0 ms
-CHOICE reported cell	Report cells within active set or within virtual active set or of the other RAT
-Maximum number of reported cells	2
-Idle Interval Information	80ms
<b>Physical channel information elements</b>	
-DPCH compressed mode status info (10.3.6.34)	Not Present

HANDOVER FROM UTRAN COMMAND message (step 8):

Information Element	Value/remark
Message Type (10.2.15 in TS25.331)	
<b>UE information elements</b> -RRC transaction identifier -Integrity check info -Activation time	0 Not Present Now
<b>RB information elements</b> -RAB information list -RAB Info	1 Not Present
<b>Other information elements</b> -CHOICE System type  -E-UTRA message	E-UTRA  Formatted and coded according to E-UTRA specifications. The first/leftmost/most significant bit of the octet string contains bit 8 of the first octet of the E-UTRA message.

HANDOVER COMMAND

Derivation Path: 36.331 clause 6.2.2			
Information Element	Value/remark	Comment	Condition
RRCConnectionReconfiguration ::= SEQUENCE {			
rrc-TransactionIdentifier	RRC-TransactionIdentifier-DL		
criticalExtensions CHOICE {			
c1 CHOICE{			
rrcConnectionReconfiguration-r8 SEQUENCE {			
nas-SecurityParamToEUTRA	OCTET STRING (SIZE(6))	This field is used to activate NAS security after inter-RAT handover to E-UTRA. The content is defined in TS 24.301.	I-RATHO
}			
}			
}			
}			

## MEASUREMENT REPORT message for Inter-RAT test cases

Information Element	Value/remark
Message Type(10.2.19 in TS25.331)	
Integrity check info	The presence of this IE is dependent on IXIT statements in TS 34.123-2. If integrity protection is indicated to be active, this IE shall be present with the values of the sub IEs as stated below. Else, this IE and the sub-IEs shall be absent.
- Message authentication code	This IE is checked to see if it is present. The value is compared against the XMAC-I value computed by SS.
- RRC Message sequence number	This IE is checked to see if it is present. The value is used by SS to compute the XMAC-I value.
Activation time	Not present
Measurement identity	2
E-UTRA Measured Results	
- E-UTRA measured results list	
- E-UTRA Carrier Frequency	Checked that this IE is present
- Measured E-UTRA cells	Checked that this IE is present
- Physical Cell Identity	Checked that this IE is present
- RSRP	Checked that this IE is present
- RSRQ	Checked that this IE is absent
E-UTRA event results	
- Inter-RAT event identity	3A
- E-UTRA events results list	
- E-UTRA Carrier Frequency	Checked that this IE is present
- Reported cells	Checked that this IE is present
- Physical Cell Identity	Checked that this IE is present
Measured results on RACH	This IE does not need to be checked.
Additional measured results	This IE does not need to be checked.
Event results	This IE does not need to be checked.
Additional measured results	This IE does not need to be checked.

8.3.3a.4.3 7,68 Mcps option

8.3.3a.5 Test Requirments

8.3.3a.5.1 3,84 Mcps option

8.3.3a.5.2 1,28 Mcps option

For the test to pass, the total number of successful tests shall be more than 90% with a confidence level of 95% of the cases.

NOTE: If the above Test Requirement differs from the Minimum Requirement then the Test Tolerance applied for this test is non-zero. The Test Tolerance for this test is defined in clause F.2 and the explanation of how the Minimum Requirement has been relaxed by the Test Tolerance is given in clause F.4.

8.3.3a.5.3 7,68 Mcps option

### 8.3.3b UTRA TDD to E-UTRA TDD Handover

*Editor's note: This section is incomplete. The following aspects are either missing or not yet determined:*

- *The Test system uncertainties applicable to this test are undefined*
- *The Test tolerances applicable to this test are undefined*
- *Some of the specific message contents are undefined*
- *Statistical testing of handover delay performance requirements is undefined*

### 8.3.3b.1 Definition and applicability

8.3.3b.1.1 3,84 Mcps option

8.3.3b.1.2 1,28 Mcps option

The UTRAN TDD to E-UTRAN TDD cell handover delay is defined as the time from the end of the last TTI containing an RRC message implying hard handover to the transmission on the channel of the new RAT.

The requirements and this test apply to the combined UTRAN TDD (1,28 Mcps option) and E-UTRAN TDD UE

8.3.3b.1.3 7,68 Mcps option

### 8.3.3b.2 Minimum requirement

8.3.3b.2.1 3,84 Mcps option

8.3.3b.2.2 1,28 Mcps option

The UE shall start to transmit the PRACH to target cell less than [85] ms from the beginning of time period T3.

The rate of correct handovers observed during repeated tests shall be at least 90%.

#### NOTE:

When the UE receives a RRC HANDOVER FROM UTRAN COMMAND message with activation time "now" or earlier than RRC procedure delay seconds from the end of the last TTI containing the RRC command, the UE shall be ready to start the transmission of the new uplink UpPTS or PRACH channel within  $D_{\text{handover}}$  seconds from the end of the last TTI containing the RRC command, where:

- $D_{\text{handover}}$  equals the maximum RRC procedure delay defined plus the interruption time

The UE shall process the RRC procedures for the RRC HANDOVER FROM UTRAN COMMAND within [50] ms, which is noted as RRC procedure delay.

If the access is delayed to an indicated activation time later than RRC procedure delay seconds from the end of the last TTI containing the RRC command, the UE shall be ready to start the transmission of the new uplink [TBD] channel at the designated activation time + interruption time.

The interruption time is the time between end of the last TTI in which the UE has received the handover command and the time the UE starts transmission of the UpPTS or PRACH in the new E-UTRA cell, excluding the RRC procedure delay. This requirement applies when UE is not required to perform any synchronisation procedure before transmitting on the new UpPTS or PRACH.

When inter-RAT handover to E-UTRAN is commanded, the interruption time shall be less than  $T_{\text{interrupt}}$ :

$$T_{\text{interrupt}} = T_{\text{search}} + T_{\text{IU}} + 20 \text{ ms}$$

where

$T_{\text{search}}$  is the time required to search the target cell when the target cell is not already known when the handover command is received by the UE. If the target cell is known, then  $T_{\text{search}} = 0$  ms.

$T_{\text{IU}}$  is the interruption uncertainty in acquiring the first available UpPTS or PRACH occasion in the new cell.  $T_{\text{IU}}$  can be up to 30 ms.

NOTE: The actual value of  $T_{\text{IU}}$  shall depend upon the PRACH configuration used in the target cell.

The normative reference for this requirement is TS 25.123 [2] clauses 5.3b and A.5.3b.

8.3.3b.2.3 7,68 Mcps option

8.3.3b.3 Test purpose

8.3.3b.3.1 3,84 Mcps option

8.3.3b.3.2 1,28 Mcps option

To verify that the UE meets the minimum requirement.

8.3.3b.3.3 7,68 Mcps option

8.3.3b.4 Method of test

8.3.3b.4.1 3,84 Mcps option

8.3.3b.4.2 1,28 Mcps option

8.3.3b.4.2.1 Initial conditions

Test environment: normal; see clauses G.2.1 and G.2.2.

Frequencies to be tested: mid range; see clause G.2.4.

The test scenario comprises of 1 UTRAN TDD cell and 1 E-UTRAN TDD cell as given in Table 8.3.3b.1, Table 8.3.3b.2, and Table 8.3.3b.3. Idle interval of 80ms period as defined in TS25.331 is configured before T2 begins to enable E-UTRAN monitoring.

The test consists of three successive time periods, with time durations of T1, T2 and T3 respectively.

A RRC message implying handover shall be sent to the UE during period T2, after the UE has reported Event 3a. The end of the last TTI containing handover message is begin of T3 duration.

**Table 8.3.3b.1: General test parameters for UTRAN TDD to E-UTRAN TDD handover test case**

Parameter		Unit	Value	Comment
DPCH parameters active cell			DL Reference Measurement Channel 12.2 kbps	As specified in TS 25.102 section A. The DPCH is located in an other timeslot than 0.
PDSCH parameters			DL Reference Measurement Channel R.0 TDD	As specified in section A.3.1.1.2 in [24]
PCFICH/PDCCH/PHICH parameters			DL Reference Measurement Channel R.6 TDD	As specified in section A.3.1.2.2 in [24]
Initial conditions	Active cell		Cell 1	UTRA 1.28Mcps TDD cell
	Neighbour cell		Cell 2	E-UTRA TDD cell



Final conditions	Active cell		Cell 2	E-UTRA TDD cell
CP length of cell 2			normal	
Uplink-downlink configuration			1	As specified in table 4.2-2 in 3GPP TS 36.211
Special subframe configuration			6	As specified in table 4.2-1 in 3GPP TS 36.211
PRACH configuration			53	As specified in table 5.7.1-3 in 3GPP TS 36.211
Idle intervals period	ms		80	As specified in TS 25.331
Handover activation time			now	
Access Barring Information			Not Sent	No additional delays in random access procedure.
$CIO_{other\_RAT}$	dB		0	Cell individual offset
$H_{3c}$	dB		0	Hysteresis parameter for event 3a
$T_{Used}$	dBm		-79	UTRA event 3a threshold
$T_{other\_RAT}$	dBm		-94	Absolute RSRP threshold for event 3a
TimeToTrigger	dB		0	
Filter coefficient			0	L3 filtering is not used
T1	s		5	
T2	s		≤10	
T3	s		1	

**Table 8.3.3b.2: Cell specific test parameters for UTRAN TDD to E-UTRAN TDD handover test case (cell 1)**

Parameter	Unit	Cell 1 (UTRA)					
		0			DwPTS		
Timeslot Number		T1	T2	T3	T1	T2	T3
UTRA RF Channel Number*		Channel 1					
PCCPCH_Ec/Ior	dB	-3			0		
DwPCH_Ec/Ior	dB				0		
OCNS_Ec/Ior	dB	-3					
$\hat{I}_{or} / I_{oc}$	dB	11+ TT	3+T T	3+T T	11+ TT	3+T T	3+T T
$I_{oc}$	dBm/1.28 MHz	-80					
PCCPCH RSCP	dBm	72+ TT	86+ TT	86+ TT	n.a.		
Propagation Condition		AWGN					
* Note: In the case of multi-frequency cell, the UTRA RF Channel Number is the primary frequency's channel number.							

**Table 8.3.3b.3: Cell specific test parameters for UTRAN TDD to E-UTRAN TDD handover test case (cell 2)**

Parameter	Unit	Cell 2		
		T1	T2	T3

E-UTRA RF Channel Number		2		
$BW_{channel}$	MHz	10		
OCNG Patterns defined in TS36.133 A.3.2.2.1 (OP.1 TDD) and in A.3.2.2.2 (OP.2 TDD)		OP.2 TDD	OP.2 TDD	OP.1 TDD
PBCH_RA	dB	0	0	0
PBCH_RB	dB			
PSS_RB	dB			
SSS_RB	dB			
PCFICH_PA	dB			
PHICH_PA	dB			
PHICH_PB	dB			
PDCCH_PA	dB			
PDCCH_PB	dB			
PDSCH_PA	dB			
PDSCH_PB	dB			
OCNG_RA <sup>Note 1</sup>	dB			
OCNG_RB <sup>Note 1</sup>	dB			
$\hat{E}_s / N_{oc}$	dB			
$N_{oc}$	dBm/15kHz	-98		
$\hat{E}_s / I_{ot}$	dB	-3+TT	11+TT	11+TT
SCH_RP	dBm/15 kHz	-101+TT	-87+TT	-87+TT
Propagation Condition		AWGN		
Note 1: OCNG shall be used such that cell is fully allocated and a constant total transmitted power spectral density is achieved for all OFDM symbols.				

#### 8.3.3b.4.2.2 Procedure

- 1) The RF parameters for cell 1 are set up according to T1 in table 8.3.3b.2
- 2) The UE is switched on
- 3) A call is set up according to the test procedure specified in TS 34.108 [3] subclause 7.3.4
- 4) The RF parameters for cell 2 are set up according to T1 in table 8.3.3b.3 and the SS configures a traffic channel
- 5) SS shall transmit a MEASUREMENT CONTROL message to cell 1
- 6) After 5 seconds, the SS shall switch the power settings from T1 to T2.
- 7) UE shall transmit a MEASUREMENT REPORT message triggered by event 3A
- 8) SS shall transmit a HANOVER FROM UTRAN COMMAND message with activation time “now” and indicating the traffic channel of the target E-UTRAN cell to the UE through DCCH of the serving UTRAN cell. The start of T3 is defined as the end of the last TTI, containing the HANOVER COMMAND.
- 10) The UE shall transmit a PRACH to cell 2 implying that it has switched to the E-UTRAN TDD cell. If the UE transmits the PRACH to cell2 less than [85] ms from the beginning of time period T3, then the number of successful tests is increased by one
- 11) At the end of T3 SS shall end the call and UE is switched off. Any timing information of cell 2 is deleted in the UE.
- 12) Repeat step 1-11 until the confidence level according to annex FFS is achieved

#### Specific Message Contents

All messages shall use the same content as described in the default message content in clause 9 of 34.108 [3] with the following exceptions:

MEASUREMENT CONTROL message (step 5):

Information Element/Group name	Value/Remark
Message Type (10.2.17 of 25.331)	
<b>UE information elements</b>	
-RRC transaction identifier	0
-Integrity check info	Not Present
<b>Measurement Information elements</b>	
-Measurement Identity	2
-Measurement Command (10.3.7.46)	Setup
-Measurement Reporting Mode (10.3.7.49)	AM RLC
-Periodical Reporting / Event Trigger Reporting Mode	Event trigger
-Additional measurements list (10.3.7.1)	Not Present
-CHOICE <i>Measurement type</i>	Inter-RAT measurement
-Inter-RAT measurement (10.3.7.27)	Not Present
-Inter-RAT measurement objects list (10.3.7.23)	
-Inter-RAT measurement quantity (10.3.7.29)	
-Measurement quantity for UTRAN quality estimate (10.3.7.38)	
-Filter coefficient	0
-CHOICE mode	TDD
-Measurement quantity	Primary CCPCH RSCP
-CHOICE system	E-UTRA
-Measurement quantity	RSRP
-Filter coefficient	0
-Inter-RAT reporting quantity (10.3.7.32)	
- UTRAN estimated quality	FALSE
- CHOICE system	E-UTRA
-E-UTRA	
- Reporting indicator	Measurement quantity
-Reporting cell status (10.3.7.61)	
-CHOICE report criteria	Inter-RAT measurement reporting criteria
-Inter-RAT measurement reporting criteria (10.3.7.30)	
-Parameters required for each event	1
-Inter-RAT event identity (10.3.7.24)	Event 3A
-Threshold own system	-79 dBm
-W	Not Present
-Threshold other system	-94 dBm
-Hysteresis	0 dB
-Time to trigger	0 ms
-CHOICE reported cell	Report cells within active set or within virtual active set or of the other RAT
-Maximum number of reported cells	2
-Idle Interval Information	80 ms
<b>Physical channel information elements</b>	
-DPCH compressed mode status info (10.3.6.34)	Not Present

HANDOVER FROM UTRAN COMMAND message (step 8):

Information Element	Value/remark
Message Type (10.2.15 in TS25.331)	
<b>UE information elements</b>	
-RRC transaction identifier	0
-Integrity check info	Not Present
-Activation time	Now
<b>RB information elements</b>	
-RAB information list	1
-RAB Info	Not Present
<b>Other information elements</b>	
-CHOICE System type	E-UTRA
-E-UTRA message	Formatted and coded according to E-UTRA specifications. The first/leftmost/most significant bit of the octet string contains bit 8 of the first octet of the E-UTRA message.

HANDOVER COMMAND

Derivation Path: 36.331 clause 6.2.2			
Information Element	Value/remark	Comment	Condition
RRCConnectionReconfiguration ::= SEQUENCE {			
rrc-TransactionIdentifier	RRC-TransactionIdentifier-DL		
criticalExtensions CHOICE {			
c1 CHOICE{			
rrcConnectionReconfiguration-r8 SEQUENCE {			
nas-SecurityParamToEUTRA	OCTET STRING (SIZE(6))	This field is used to activate NAS security after inter-RAT handover to E-UTRA. The content is defined in TS 24.301.	I-RATHO
}			
}			
}			
}			

MEASUREMENT REPORT message for Inter-RAT test cases

Information Element	Value/remark
Message Type(10.2.19 in TS25.331)	The presence of this IE is dependent on IXIT statements in TS 34.123-2. If integrity protection is indicated to be active, this IE shall be present with the values of the sub IEs as stated below. Else, this IE and the sub-IEs shall be absent.
Integrity check info	
- Message authentication code	This IE is checked to see if it is present. The value is compared against the XMAC-I value computed by SS.
- RRC Message sequence number	This IE is checked to see if it is present. The value is used by SS to compute the XMAC-I value.
Activation time	Not present
Measurement identity	2
E-UTRA Measured Results	Checked that this IE is present
- E-UTRA measured results list	
- E-UTRA Carrier Frequency	
- Measured E-UTRA cells	
- Physical Cell Identity	
- RSRP	Checked that this IE is present
- RSRQ	Checked that this IE is absent
E-UTRA event results	3A
- Inter-RAT event identity	
- E-UTRA events results list	
- E-UTRA Carrier Frequency	
- Reported cells	Checked that this IE is present
- Physical Cell Identity	Checked that this IE is present
Measured results on RACH	This IE does not need to be checked.
Additional measured results	This IE does not need to be checked.
Event results	This IE does not need to be checked.
Additional measured results	This IE does not need to be checked.

8.3.3b.4.3 7,68 Mcps option

8.3.3b.5 Test Requirments

8.3.3b.5.1 3,84 Mcps option

8.3.3b.5.2 1,28 Mcps option

For the test to pass, the total number of successful tests shall be more than 90% with a confidence level of 95% of the cases.

NOTE: If the above Test Requirement differs from the Minimum Requirement then the Test Tolerance applied for this test is non-zero. The Test Tolerance for this test is defined in clause F.2 and the explanation of how the Minimum Requirement has been relaxed by the Test Tolerance is given in clause F.4.

8.3.3b.5.3 7,68 Mcps option

### 8.3.3c TDD/GSM Handover: non-synchronization target cell

*Editor's note: This section is incomplete. The following aspects are either missing or not yet determined:*

- The Test system uncertainties applicable to this test are undefined
- The Test tolerances applicable to this test are undefined

8.3.3c.1 Definition and applicability

8.3.3c.1.2 1,28 Mcps option

The UTRAN to GSM cell handover delay is defined as the time from the end of the last TTI containing an RRC message implying hard handover to the transmission on the channel of the new RAT.

The requirements and this test apply to the combined TDD (1,28 Mcps option) and GSM UE

8.3.3c.2 Minimum requirement

8.3.3c.2.2 1,28 Mcps option

The handover delay shall be less than 200 ms in the case where the UE has not synchronised to the GSM cell before the HANDOVER FROM UTRAN COMMAND is received. The rate of correct handovers observed during repeated tests shall be at least 90% with a confidence level of 95%.

The normative reference for this requirement is TS 25.123 [2] clauses 5.3.2 and A.5.3.

NOTE: The test requirement in this test case is expressed as:

$$T_{\text{Handover delay}} = 190 \text{ ms} + T_{\text{offset}} + T_{\text{UL}}$$

$T_{\text{offset}}$ : Equal to 4.65 ms, GSM timing uncertainty between the time from when the UE is ready to transmit until the start of the next timeslot in GSM 26 multiframe structure

$T_{\text{UL}}$ : Equal to 4.65 ms, the time the UE has to wait in case the next timeslot is an idle frame or a SACCH frame.

This gives a total of 199.3 ms, allow 200 ms in the test case.

8.3.3c.3 Test purpose

8.3.3c.3.2 1,28 Mcps option

To verify that the UE meets the minimum requirement.

8.3.3c.4 Method of test

8.3.3c.4.2 1,28 Mcps option

Test environment: normal; see clauses G.2.1 and G.2.2.

Frequencies to be tested: mid range; see clause G.2.4 for TDD conditions, and clause A1.2 of TS 51.010-1 [24] for the corresponding GSM conditions.

The test parameters are given in Table 8.3.3c.4.2-1, 8.3.3c.4.2-2 and 8.3.3c.4.2-3 below. The test consists of two successive time periods, with a time duration of T1 and T2 respectively. At the start of time duration T1, the UE may not have any timing information of cell 2.

The starting point of T2 is defined as the end of the last TTI containing the HANDOVER COMMAND. In the GSM Handover command contained in this message, IE starting time shall not be included.

Cell 1 is a UTRA TDD cell and cell 2 is a GSM cell. The DL DPCH shall be transmitted in timeslot 4 and the UL DPCH shall be transmitted in timeslot 2.

**Table 8.3.3c.4.2-1: General test parameters for 1,28Mcps TDD/GSM handover**

Parameter	Unit	Value	Comment
DCH parameters		DL Reference Measurement Channel 12.2 kbps	As specified in TS 25.102 section A
Power Control		On	
Target quality value on DTCH	BLER	0.01	
Initial conditions	Active cell	Cell 1	UTRA TDD cell
	Neighbour cell	Cell 2	GSM cell
Final condition	Active cell	Cell 2	GSM cell
T1	s	10	
T2	s	1	

**Table 8.3.3c.4.2-2: Cell 1 (1,28Mcps )specific test parameters for TDD/GSM handover**

Parameter	Unit	Cell 1			
		0		DwPTS	
DL timeslot number		T1	T2	T1	T2
UTRA RF Channel Number		Channel 1			
PCCPCH_Ec/lor	dB	-3			
DwPCH_Ec/lor	dB			0	
OCNS_Ec/lor	dB	-3			
$\hat{I}_{or}/I_{oc}$	dB	5		5	
$I_{oc}$	dBm/1.28 MHz	-70			
Propagation Condition		AWGN			

**Table 8.3.3c.4.2-3: Cell 2 (GSM )specific test parameters for TDD/GSM handover**

Parameter	Unit	Cell 2	
		T1	T2
Absolute RF Channel Number		ARFCN 1	
RXLEV	dBm	-infinity	-75

#### 8.3.3c.4.2.2 Procedure

- 1) The RF parameters for cell 1 are set up according to T1.
- 2) The UE is switched on
- 3) A call is set up according to the test procedure specified in TS 34.108 [3] subclause 7.3.4
- 3) After 10 seconds, The RF parameters for cell 2 are set up according to T1 and the SS configures a traffic channel

- 4) SS shall transmit a HANOVER FROM UTRAN COMMAND message with activation time "now" and indicating the traffic channel of the target GSM cell to the UE through DCCH of the serving UTRAN cell. The start of T2 is defined as the end of the last TTI, containing the HANOVER COMMAND.
- 5) UE shall transmit a burst on the traffic channel of cell 2 implying that it has switched to the GSM cell. The UE sends a HANOVER ACCESS message. If the UE transmits access bursts on the new DCCH of the target cell less than 200 ms from the beginning of time period T2, then the number of successful tests is increased by one.
- 6) At the end of T2 the UE is switched off. Any timing information of cell 2 is deleted in the UE.
- 7) Repeat step 1-6 until the confidence level according to annex F.6.2A is achieved

### Specific Message Contents

All messages shall use the same content as described in the default message content in clause 9 of 34.108 [3] with the following exceptions:

Note: 10.x.y.z in the IE description refers to clauses in TS 25.331 [9].

HANOVER FROM UTRAN COMMAND message (step 4):

Information Element	Value/remark
Message Type(10.2.15)	
<b>UE information elements</b>	
-RRC transaction identifier	0
-Integrity check info	Not Present
-Activation time	now
<b>RB information elements</b>	
-RAB information list	1
-RAB Info	Not present
- RAB identity	0000 0001B The first/ leftmost bit of the bit string contains the most significant bit of the RAB identity.
- CN domain identity	CS domain
- NAS Synchronization Indicator	Not present
- Re-establishment timer	Use T315
<b>Other information elements</b>	
-CHOICE System type	GSM
-Frequency Band	Set to "GSM/ PCS 1900" if GSM/ PCS 1900 is used in this test. Otherwise set to "GSM/DCS 1800 Band"
-CHOICE GSM message	
- Single GSM message	GSM HANOVER COMMAND formatted and coded according to GSM specifications as BIT STRING (1..512). The first/ leftmost/ most significant bit of the bit string contains bit 8 of the first octet of the GSM message. The contents of the HANOVER COMMAND see next table.

## HANDOVER COMMAND

Information Element (GSM)	Value/remark	Version
Protocol Discriminator	RR Management.	
Skip Indicator	0000	
Message Type	00101011	
Cell Description		
- Network Colour Code	1	
- Base station Colour Code	5	
- BCCH Carrier Number	1	
Channel Description 2		
- Channel Type and TDMA offset	TCH/F + ACCHs	
- Timeslot Number	Chosen arbitrarily by the test house, but not Zero.	
- Training Sequence Code	Chosen arbitrarily by the test house.	
- Hopping	Single RF channel.	
- ARFCN	1	
Handover Reference		
- Handover Reference Value	Chosen arbitrarily by the test house.	
Power Command and ACCESS Type		
- ATC	0	
- EPC_mode	0	REL-5
- FPC	0	R99 and REL-4 only
- EPC_FPC	0	REL-5
- Power level	Chosen arbitrarily by the test house.	
Synchronization Indication	Not present.	
Channel Mode	speech full rate or half rate version 1	
All other information elements	Not present.	

## 8.3.3c.5 Test requirements

## 8.3.3c.5.2 1,28 Mcps option

For the test to pass, the total number of successful tests shall be more than 90% with a confidence level of 95% of the cases.

NOTE: If the above Test Requirement differs from the Minimum Requirement then the Test Tolerance applied for this test is non-zero. The Test Tolerance for this test is defined in clause F.2 and the explanation of how the Minimum Requirement has been relaxed by the Test Tolerance is given in clause F.4.

## 8.3.4 Cell Re-selection in CELL\_FACH

## 8.3.4.1 Scenario 1: TDD/TDD cell re-selection single carrier case

## 8.3.4.1.1 Definition and applicability

## 8.3.4.1.1.1 3,84 Mcps TDD option

The cell re-selection delay is defined as the time from a change of cell levels to the moment when this change causes the UE to camp on a new cell, and starts to send the CELL UPDATE message with cause value "cell reselection" in the new cell.

The requirements and this test apply to the 3,84 Mcps TDD UE.

## 8.3.4.1.1.2 1,28 Mcps TDD option

The cell re-selection delay is defined as the time from a change of cell levels to the moment when this change causes the UE to camp on a new cell, and starts to send SYNCH-UL sequence in the UpPTS for sending the CELL UPDATE with cause value "cell reselection".

The requirements and this test apply to the 1,28 Mcps TDD UE.



## 8.3.4.1.1.3 7,68 Mcps TDD option

The cell re-selection delay is defined as the time from a change of cell levels to the moment when this change causes the UE to camp on a new cell, and starts to send the CELL UPDATE message with cause value "cell reselection" in the new cell.

The requirements and this test apply to the 7,68 Mcps TDD UE.

## 8.3.4.1.2 Minimum requirement

## 8.3.4.1.2.1 3,84 Mcps TDD option

The cell re-selection delay shall be less than 2.5 s. The rate of correct cell re-selections observed during repeated tests shall be at least 90%.

The normative reference for this requirement is TS 25.123 [2] clauses 5.4.2 and A.5.4.1.

## 8.3.4.1.2.2 1,28 Mcps TDD option

The cell re-selection delay shall be less than 1.6s. The rate of correct cell re-selections observed during repeated tests shall be at least 90%.

The normative reference for this requirement is TS 25.123 [2] clauses 5.4.3 and A.5.4.2.

## 8.3.4.1.2.3 7,68 Mcps TDD option

The cell re-selection delay shall be less than 2.5 s. The rate of correct cell re-selections observed during repeated tests shall be at least 90%.

The normative reference for this requirement is TS 25.123 [2] clauses 5.4.4 and A.5.4.3.

## 8.3.4.1.3 Test purpose

This test verifies that the UE meets the minimum requirement for the cell re-selection delay in CELL\_FACH for the single carrier case

## 8.3.4.1.4 Method of test

## 8.3.4.1.4.1 3,84 Mcps TDD option

## 8.3.4.1.4.1.1 Initial conditions

This scenario contains 6 cells operating on the same carrier frequency. The test parameters are given in Tables 8.3.4.1.1.1, 8.3.4.1.1.2, 8.3.4.1.1.3, and 8.3.4.1.1.4.

**Table 8.3.4.1.1.1: General test parameters for Cell Re-selection in CELL\_FACH**

Parameter		Unit	Value	Comment
Initial condition	Active cell		Cell1	
	Neighbour cells		Cell2, Cell3, Cell4, Cell5, Cell6	
Final condition	Active cell		Cell2	
HCS			Not used	
UE_TXPWR_MAX_RACH		dBm	21	The value shall be used for all cells in the test.
Qrxlevmin		dBm	-102	The value shall be used for all cells in the test.
Access Service Class (ASC#0) - Persistence value		-	1	Selected so that no additional delay is caused by the random access procedure. The value shall be used for all cells in the test.
T <sub>SI</sub>		s	1,28	The value shall be used for all cells in the test.
T1		s	15	
T2		s	15	

**Table 8.3.4.1.1.2: Physical channel parameters for S-CCPCH.**

Parameter	Unit	Level
Channel bit rate	Kbps	24,4
Channel symbol rate	Ksps	12,2
Slot Format #	-	0
Frame allocation	-	Continuous frame allocation
Midamble allocation	-	Default Midamble

**Table 8.3.4.1.1.3: Transport channel parameters for S-CCPCH**

Parameter	FACH
Transport Channel Number	1
Transport Block Size	240
Transport Block Set Size	240
Transmission Time Interval	20 ms
Type of Error Protection	Convolutional Coding
Coding Rate	$\frac{1}{2}$
Rate Matching attribute	256
Size of CRC	16

Table 8.3.4.1.1.4: Cell specific test parameters for Cell Re-selection in CELL\_FACH

Parameter	Unit	Cell 1				Cell 2				Cell 3			
Timeslot Number		0		8		0		8		0		8	
		T1	T2	T1	T2	T1	T2	T1	T2	T1	T2	T1	T2
UTRA RF Channel Number		Channel 1				Channel 1				Channel 1			
PCCPCH_Ec/lor	dB	-3	-3			-3	-3			-3	-3		
SCH_Ec/lor	dB	-9	-9	-9	-9	-9	-9	-9	-9	-9	-9	-9	-9
SCH_toffset		0	0	0	0	5	5	5	5	10	10	10	10
PICH_Ec/lor	dB			-3	-3			-3	-3			-3	-3
OCNS_Ec/lor	dB	-4,28	-4,28	-4,28	-4,28	-4,28	-4,28	-4,28	-4,28	-4,28	-4,28	-4,28	-4,28
$\hat{I}_{or}/I_{oc}$	dB	9	7	9	7	7	9	7	9	-1	-1	-1	-1
PCCPCH RSCP	dBm	-64	-66			-66	-64			-74	-74		
Qoffset1 <sub>s,n</sub>	dB	C1, C2: 0; C1, C3:0; C1,C4:0 C1, C5:0; C1,C6:0				C2, C1: 0; C2, C3:0; C2,C4:0 C2, C5: 0; C2, C6:0				C3, C1: 0; C3, C2:0; C3,C4:0 C3, C5: 0; C3, C6:0			
Qhyst1 <sub>s</sub>	dB	0				0				0			
Treselection		0				0				0			
Sintrasearch	dB	not sent				not sent				not sent			
FACH measurement occasion info		not sent				not sent				not sent			
$I_{oc}$	dBm/3,8 4 MHz	-70											
Propagation Condition		AWGN											
		Cell 4				Cell 5				Cell 6			
Timeslot		0		8		0		8		0		8	
		T1	T2	T1	T2	T1	T2	T1	T2	T1	T2	T1	T2
UTRA RF Channel Number		Channel 1				Channel 1				Channel 1			
PCCPCH_Ec/lor	dB	-3	-3			-3	-3			-3	-3		
SCH_Ec/lor	dB	-9	-9	-9	-9	-9	-9	-9	-9	-9	-9	-9	-9
SCH_toffset		15	15	15	15	20	20	20	20	25	25	25	25
PICH_Ec/lor	dB			-3	-3			-3	-3			-3	-3
OCNS_Ec/lor	dB	-4,28	-4,28	-4,28	-4,28	-4,28	-4,28	-4,28	-4,28	-4,28	-4,28	-4,28	-4,28
$\hat{I}_{or}/I_{oc}$	dB	-1	-1	-1	-1	-1	-1	-1	-1	-1	-1	-1	-1
PCCPCH RSCP	dBm	-74	-74			-74	-74			-74	-74		
Qoffset1 <sub>s,n</sub>	dB	C4, C1: 0; C4, C2:0; C4,C3:0 C4, C5:0; C4, C6:0				C5, C1: 0; C5, C2:0; C5,C3:0 C5, C4:0; C5, C6:0				C6, C1: 0; C6, C2:0; C6,C3:0 C6, C4:0; C6, C5:0			
Qhyst1 <sub>s</sub>	dB	0				0				0			
Treselection		0				0				0			
Sintrasearch	dB	not sent				not sent				not sent			

FACH measurement occasion info		not sent	not sent	not sent
$I_{oc}$	dBm/3,8 4 MHz	-70		
Propagation Condition		AWGN		

Note: S-CCPCH shall not be located in TS0.

## 8.3.4.1.4.1.2 Procedure

- a) The SS activates cell 1-6 with T1 defined parameters.
- b) The UE is switched on.
- c) A call is set up according to the generic set-up procedure specified in TS 34.108 [3] subclauses 7.3.3 and 7.4.2 to place the UE in CELL\_FACH.
- d) After 15 s, the parameters are changed as described for T2.
- e) The SS waits for CELL UPDATE message with cause value "cell reselection" from the UE. If the UE has failed to respond with the correct message within the allowed time, a failure is recorded. The SS shall then wait for a total of 15 s and if no response is received the UE shall be switched off and the procedure returns to step 1. Otherwise the SS shall transmit a CELL UPDATE CONFIRM message and then the procedure continues.
- f) After another 15 s, the parameters are changed as described for T1.
- g) The SS waits for CELL UPDATE message with cause value "cell reselection" from the UE. If the UE has failed to respond with the correct message within the allowed time, a failure is recorded. The SS shall then wait for a total of 15 s and if no response is received the UE shall be switched off and the procedure returns to step 1. Otherwise the SS shall transmit a CELL UPDATE CONFIRM message and then the procedure continues.
- h) Repeat steps d) to g) [TBD] times.

## 8.3.4.1.4.2 1,28 Mcps TDD option

## 8.3.4.1.4.2.1 Initial conditions

This scenario contains 6 cells operating on the same carrier frequency. The test parameters are given in Tables 8.3.4.1.4.2.1, 8.3.4.1.4.2.2, 8.3.4.1.4.2.3, and 8.3.4.1.4.2.4.

**Table 8.3.4.1.4.2.1: General test parameters for 1,28 Mcps Cell Re-selection in CELL\_FACH**

Parameter		Unit	Value	Comment
initial condition	Active cell		Cell1	
	Neighbour cells		Cell2, Cell3, Cell4, Cell5, Cell6	
final condition	Active cell		Cell2	
HCS			Not used	
UE_TXPWR_MAX_RACH		dBm	21	The value shall be used for all cells in the test.
Qrxlevmin		dBm	-103	The value shall be used for all cells in the test.
Access Service Class (ASC#0) - Persistence value			1	Selected so that no additional delay is caused by the random access procedure. The value shall be used for all cells in the test.
T <sub>SI</sub>		s	1,28	The value shall be used for all cells in the test.
T1		s	15 (initial), 15(repetition)	
T2		s	15	

**Table 8.3.4.1.4.2.2: Physical channel parameters for S-CCPCH.**

Parameter	Unit	Level
Channel bit rate	kbps	35.2
Channel symbol rate	ksps	17.6
Slot Format #	-	0; 2
Frame allocation	-	Continuous frame allocation
Midamble allocation	-	Common Midamble

**Table 8.3.4.1.4.2.3: Transport channel parameters for S-CCPCH**

Parameter	FACH
Transport Channel Number	1
Transport Block Size	240
Transport Block Set Size	240
Transmission Time Interval	20 ms
Type of Error Protection	Convolution Coding
Coding Rate	1/2
Rate Matching attribute	256
Size of CRC	16

**Table 8.3.4.1.4.2.4: Cell specific test parameters for 1,28 Mcps Cell Re-selection in CELL\_FACH**

Parameter	Unit	Cell 1				Cell 2				Cell 3			
		0		DWPTS		0		DWPTS		0		DWPTS	
		T1	T2	T1	T2	T1	T2	T1	T2	T1	T2	T1	T2
UTRA RF Channel Number		Channel 1				Channel 1				Channel 1			
PCCPCH_Ec/lor	dB	-3	-3			-3	-3			-3	-3		
DwPCH_Ec/lor	dB			0	0			0	0			0	0
OCNS_Ec/lor	dB	-3	-3			-3	-3			-3	-3		
$\hat{I}_{or}/I_{oc}$	dB	10	7	10	7	7	10	7	9	-1	-1	-1	-1
PCCPCH RSCP	dBm	-63	-66			-66	-63			-74	-74		
Qoffset1 <sub>s,n</sub>	dB	C1, C2: 0; C1, C3:0; C1,C4:0 C1, C5:0; C1,C6:0				C2, C1: 0; C2, C3:0; C2,C4:0 C2, C5: 0; C2, C6:0				C3, C1: 0; C3, C2:0; C3,C4:0 C3, C5: 0; C3, C6:0			
Qhyst1 <sub>s</sub>	dB	0				0				0			
Treselection		0				0				0			
Sintrasearch	dB	not sent				not sent				not sent			
FACH measurement occasion info		not sent				not sent				not sent			
		Cell 4				Cell 5				Cell 6			
		0		DWPTS		0		DWPTS		0		DWPTS	
		T1	T2	T1	T2	T1	T2	T1	T2	T1	T2	T1	T2
UTRA RF Channel Number		Channel 1				Channel 1				Channel 1			
PCCPCH_Ec/lor	dB	-3	-3			-3	-3			-3	-3		
DwPCH_Ec/lor	dB			0	0			0	0			0	0
OCNS_Ec/lor	dB	-3	-3			-3	-3			-3	-3		
$\hat{I}_{or}/I_{oc}$	dB	-1	-1	-1	-1	-1	-1	-1	-1	-1	-1	-1	-1
PCCPCH RSCP	dBm	-74	-74			-74	-74			-74	-74		
Qoffset1 <sub>s,n</sub>	dB	C4, C1: 0; C4, C2:0; C4,C3:0 C4, C5:0; C4, C6:0				C5, C1: 0; C5, C2:0; C5,C3:0 C5, C4:0; C5, C6:0				C6, C1: 0; C6, C2:0; C6,C3:0 C6, C4:0; C6, C5:0			
Qhyst1 <sub>s</sub>	dB	0				0				0			
Treselection		0				0				0			
Sintrasearch	dB	not sent				not sent				not sent			
FACH measurement occasion info		not sent				not sent				not sent			
$I_{oc}$	dBm/1,2 8 MHz	-70											
Propagation Condition		AWGN											

NOTE: S-CCPCH is located in an other downlink TS than TS0. Void.

8.3.4.1.4.2.2 Procedure

- a) The SS activates cell 1-6 with T1 defined parameters.

- b) The UE is switched on.
- c) A call is set up according to the generic set-up procedure specified in TS 34.108 [3] subclause s 7.3.3 and 7.4.2 to place the UE in CELL\_FACH.
- d) After 15 s, the parameters are changed as described for T2.
- e) The SS waits for SYNCH-UL sequence in the UpPTS for sending CELL UPDATE message with cause value "cell reselection" from the UE. If the UE has failed to respond with the correct message within the allowed time, a failure is recorded. The SS shall then wait for a total of 15s and if no response is received the UE shall be switched off and the procedure returns to step a). Otherwise the SS shall transmit a CELL UPDATE CONFIRM message and then the procedure continues.
- f) After another 15 s, the parameters are changed as described for T1.
- g) The SS waits for SYNCH-UL sequence in the UpPTS for sending CELL UPDATE message with cause value "cell reselection" from the UE. If the UE has failed to respond with the correct message within the allowed time, a failure is recorded. The SS shall then wait for a total of 15 s and if no response is received the UE shall be switched off and the procedure returns to step a). Otherwise the SS shall transmit a CELL UPDATE CONFIRM message and then the procedure continues
- h) After another 15 s, the UE shall be switched off.
- i) Repeat step a) to h) until the confidence level according to annex F.6.2 is achieved.

#### 8.3.4.1.4.3 7,68 Mcps TDD option

##### 8.3.4.1.4.3.1 Initial conditions

This scenario contains 6 cells operating on the same carrier frequency. The test parameters are given in Tables 8.3.4.1.4.3.1, 8.3.4.1.4.3.2, 8.3.4.1.4.3.3 and 8.3.4.1.4.3.4.

**Table 8.3.4.1.4.3.1: General test parameters for Cell Re-selection in CELL\_FACH**

Parameter		Unit	Value	Comment
Initial condition	Active cell		Cell1	
	Neighbour cells		Cell2, Cell3, Cell4, Cell5, Cell6	
Final condition	Active cell		Cell2	
HCS			Not used	
UE_TXPWR_MAX_RACH		dBm	21	The value shall be used for all cells in the test.
Qrxlevmin		dBm	-102	The value shall be used for all cells in the test.
Access Service Class (ASC#0) - Persistence value		-	1	Selected so that no additional delay is caused by the random access procedure. The value shall be used for all cells in the test.
T <sub>SI</sub>		s	1,28	The value shall be used for all cells in the test.
T1		s	15 (initial), 5 (repetition)	
T2		s	5	

**Table 8.3.4.1.4.3.2: Physical channel parameters for S-CCPCH.**

Parameter	Unit	Level
Channel bit rate	Kbps	24,4
Channel symbol rate	Ksps	12,2
Slot Format #	-	0
Frame allocation	-	Continuous frame allocation
Midamble allocation	-	Default Midamble

**Table 8.3.4.1.4.3.3: Transport channel parameters for S-CCPCH**

<b>Parameter</b>	<b>FACH</b>
Transport Channel Number	1
Transport Block Size	240
Transport Block Set Size	240
Transmission Time Interval	20 ms
Type of Error Protection	Convolutional Coding
Coding Rate	$\frac{1}{2}$
Rate Matching attribute	256
Size of CRC	16



Table 8.3.4.1.4.3.4: Cell specific test parameters for Cell Re-selection in CELL\_FACH

Parameter	Unit	Cell 1				Cell 2				Cell 3			
Timeslot Number		0		8		0		8		0		8	
		T1	T2	T1	T2	T1	T2	T1	T2	T1	T2	T1	T2
UTRA RF Channel Number		Channel 1				Channel 1				Channel 1			
PCCPCH_Ec/Ior	dB	-3	-3			-3	-3			-3	-3		
SCH_Ec/Ior	dB	-9	-9	-9	-9	-9	-9	-9	-9	-9	-9	-9	-9
SCH_t_offset		0	0	0	0	5	5	5	5	10	10	10	10
PICH_Ec/Ior	dB			-3	-3			-3	-3			-3	-3

OCNS_Ec/lor	dB	-3,12	-3,12	-3,12	-3,12	-3,12	-3,12	-3,12	-3,12	-3,12	-3,12	-3,12	-3,12
$\hat{I}_{or}/I_{oc}$	dB	9	7	9	7	7	9	7	9	-1	-1	-1	-1
PCCPCH RSCP	dBm	-64	-66			-66	-64			-74	-74		
Qoffset1 <sub>s,n</sub>	dB	C1, C2: 0; C1, C3:0; C1,C4:0 C1, C5:0; C1,C6:0				C2, C1: 0; C2, C3:0; C2,C4:0 C2, C5: 0; C2, C6:0				C3, C1: 0; C3, C2:0; C3,C4:0 C3, C5: 0; C3, C6:0			
Qhyst1 <sub>s</sub>	dB	0				0				0			
Treselection		0				0				0			
Sintrasearch	dB	not sent				not sent				not sent			
FACH measurement occasion info		not sent				not sent				not sent			
$I_{oc}$	dBm/7,68 MHz	-70											
Propagation Condition		AWGN											
		Cell 4				Cell 5				Cell 6			
Timeslot		0		8		0		8		0		8	
		T1	T2	T1	T2	T1	T2	T1	T2	T1	T2	T1	T2
UTRA RF Channel Number		Channel 1				Channel 1				Channel 1			
PCCPCH_Ec/lor	dB	-3	-3			-3	-3			-3	-3		
SCH_Ec/lor	dB	-9	-9	-9	-9	-9	-9	-9	-9	-9	-9	-9	-9
SCH_t <sub>offset</sub>		15	15	15	15	20	20	20	20	25	25	25	25
PICH_Ec/lor	dB			-3	-3			-3	-3			-3	-3
OCNS_Ec/lor	dB	-3,12	-3,12	-3,12	-3,12	-3,12	-3,12	-3,12	-3,12	-3,12	-3,12	-3,12	-3,12
$\hat{I}_{or}/I_{oc}$	dB	-1	-1	-1	-1	-1	-1	-1	-1	-1	-1	-1	-1
PCCPCH RSCP	dBm	-74	-74			-74	-74			-74	-74		
Qoffset1 <sub>s,n</sub>	dB	C4, C1: 0; C4, C2:0; C4,C3:0 C4, C5:0; C4, C6:0				C5, C1: 0; C5, C2:0; C5,C3:0 C5, C4:0; C5, C6:0				C6, C1: 0; C6, C2:0; C6,C3:0 C6, C4:0; C6, C5:0			
Qhyst1 <sub>s</sub>	dB	0				0				0			
Treselection		0				0				0			
Sintrasearch	dB	not sent				not sent				not sent			
FACH measurement occasion info		not sent				not sent				not sent			
$I_{oc}$	dBm/7,68 MHz	-70											
Propagation Condition		AWGN											

Note: S-CCPCH shall not be located in TS0.

#### 8.3.4.1.4.3.2 Procedure

- a) The SS activates cell 1-6 with T1 defined parameters.
- b) The UE is switched on.
- c) A call is set up according to the generic set-up procedure specified in TS 34.108 [3] subclauses 7.3.3 and 7.4.2 to place the UE in CELL\_FACH.
- d) After 15 s, the parameters are changed as described for T2.
- e) The SS waits for CELL UPDATE message with cause value "cell reselection" from the UE. If the UE has failed to respond with the correct message within the allowed time, a failure is recorded. The SS shall then wait for a total of 15 s and if no response is received the UE shall be switched off and the procedure returns to step 1. Otherwise the SS shall transmit a CELL UPDATE CONFIRM message and then the procedure continues.
- f) After another 15 s, the parameters are changed as described for T1.
- g) The SS waits for CELL UPDATE message with cause value "cell reselection" from the UE. If the UE has failed to respond with the correct message within the allowed time, a failure is recorded. The SS shall then wait for a total of 15 s and if no response is received the UE shall be switched off and the procedure returns to step 1. Otherwise the SS shall transmit a CELL UPDATE CONFIRM message and then the procedure continues.
- h) Repeat steps d) to g) until the confidence level according to annex F.6.2 is achieved..

#### 8.3.4.1.5 Test Requirements

##### 8.3.4.1.5.1 3,84 Mcps TDD option

- 1) In step d), after the UE has responded on cell 1, it shall not respond on any other cell (cell selection).
- 2) In step e), the UE shall respond on cell 2 within 2.5 s.
- 3) In step g), the UE shall respond on cell 1 within 2.5 s.

For the test to pass, the total number of fulfilled test requirements 2) and 3) shall be more than [FFS]% of the cases.

NOTE: If the above Test Requirement differs from the Minimum Requirement then the Test Tolerance applied for this test is non-zero. The Test Tolerance for this test is defined in clause F.2 and the explanation of how the Minimum Requirement has been relaxed by the Test Tolerance is given in clause F.4.

##### 8.3.4.1.5.2 1,28 Mcps TDD option

- 1) In step d), after the UE has responded on cell 1, it shall not respond on any other cell (cell selection).
- 2) In step e), the UE shall respond on cell 2 within 1.6 s.
- 3) In step g), the UE shall respond on cell 1 within 1.6 s.

For the test to pass, the total number of fulfilled test requirements 2) and 3) shall be more than 90% with a confidence level of 95% of the cases.

NOTE: If the above Test Requirement differs from the Minimum Requirement then the Test Tolerance applied for this test is non-zero. The Test Tolerance for this test is defined in clause F.2 and the explanation of how the Minimum Requirement has been relaxed by the Test Tolerance is given in clause F.4.

##### 8.3.4.1.5.3 7,68 Mcps TDD option

- 1) In step d), after the UE has responded on cell 1, it shall not respond on any other cell (cell selection).
- 2) In step e), the UE shall respond on cell 2 within 2.5 s.
- 3) In step g), the UE shall respond on cell 1 within 2.5 s.

For the test to pass, the total number of fulfilled test requirements 2) and 3) shall be more than 90% of the cases.

NOTE: If the above Test Requirement differs from the Minimum Requirement then the Test Tolerance applied for this test is non-zero. The Test Tolerance for this test is defined in clause F.2 and the explanation of how the Minimum Requirement has been relaxed by the Test Tolerance is given in clause F.4. 8.3.4.2 Scenario 2: TDD/TDD cell re-selection multi carrier case.

### 8.3.4.2 Scenario 2: TDD/TDD cell re-selection multi carrier case

#### 8.3.4.2.1 Definition and applicability

##### 8.3.4.2.1.1 3,84 Mcps TDD option

The cell re-selection delay is defined as the time from a change of cell levels to the moment when this change causes the UE to camp on a new cell , and starts to send the CELL UPDATE message with cause value "cell reselection" in the new cell.

The requirements and this test apply to the 3,84 Mcps TDD UE.

##### 8.3.4.2.1.2 1,28 Mcps TDD option

The cell re-selection delay is defined as the time from a change of cell levels to the moment when this change causes the UE to camp on a new cell , and starts to send SYNCH-UL sequence in the UpPTS for sending the CELL UPDATE with cause value "cell reselection".

The requirements and this test apply to the 1,28 Mcps TDD UE.

##### 8.3.4.2.1.3 7,68 Mcps TDD option

The cell re-selection delay is defined as the time from a change of cell levels to the moment when this change causes the UE to camp on a new cell , and starts to send the CELL UPDATE message with cause value "cell reselection" in the new cell.

The requirements and this test apply to the 7,68 Mcps TDD UE.

#### 8.3.4.2.2 Minimum requirement

##### 8.3.4.2.2.1 3,84 Mcps TDD option

The cell re-selection delay shall be less than 3 s. The rate of correct cell re-selections observed during repeated tests shall be at least 90%.

The normative reference for this requirement is TS 25.123 [2] clauses 5.4.2 and A.5.4.2.

##### 8.3.4.2.2.2 1,28 Mcps TDD option

The cell re-selection delay shall be less than 2 s. The rate of correct cell re-selections observed during repeated tests shall be at least 90%.

The normative reference for this requirement is TS 25.123 [2] clauses 5.4.3 and A.5.4.2.2.

##### 8.3.4.2.2.3 7,68 Mcps TDD option

The cell re-selection delay shall be less than 3 s. The rate of correct cell re-selections observed during repeated tests shall be at least 90%.

The normative reference for this requirement is TS 25.123 [2] clauses 5.4.4 and A.5.4.3.2.

#### 8.3.4.2.3 Test purpose

This test verifies that the UE meets the requirement for the cell re-selection delay in CELL\_FACH for the multi carrier case.

## 8.3.4.2.4 Method of test

## 8.3.4.2.4.1 3,84 Mcps TDD option

## 8.3.4.2.4.1.1 Initial conditions

This scenario contains 6 cells and 2 carrier frequencies. The test parameters are given in Tables 8.3.4.2.1.1, 8.3.4.2.1.2, 8.3.4.2.1.3, and 8.3.4.2.1.4.

**Table 8.3.4.2.1.1: General test parameters for Cell Re-selection in CELL\_FACH**

Parameter	Unit	Value	Comment
Initial condition	Active cell	Cell1	
	Neighbour cells	Cell2, Cell3, Cell4, Cell5, Cell6	
Final condition	Active cell	Cell2	
HCS		Not used	
UE_TXPWR_MAX_RACH	dBm	21	The value shall be used for all cells in the test.
Qrxlevmin	dBm	-102	The value shall be used for all cells in the test.
Access Service Class (ASC#0) - Persistence value	-	1	Selected so that no additional delay is caused by the random access procedure. The value shall be used for all cells in the test.
T <sub>SI</sub>	s	1,28	The value shall be used for all cells in the test.
T1	s	15	
T2	s	15	

**Table 8.3.4.2.1.2: Physical channel parameters for S-CCPCH.**

Parameter	Unit	Level
Channel bit rate	Kbps	24,4
Channel symbol rate	Ksps	12,2
Slot Format #	-	0
Frame allocation	-	Continuous frame allocation
Midamble allocation	-	Default Midamble

**Table 8.3.4.2.1.3: Transport channel parameters for S-CCPCH**

Parameter	FACH
Transport Channel Number	1
Transport Block Size	240
Transport Block Set Size	240
Transmission Time Interval	20 ms
Type of Error Protection	Convolutional Coding
Coding Rate	1/2
Rate Matching attribute	256
Size of CRC	16

Table 8.3.4.2.1.4: Cell specific test parameters for Cell Re-selection in CELL\_FACH

Parameter	Unit	Cell 1				Cell 2				Cell 3			
Timeslot Number		0		8		0		8		0		8	
		T1	T2	T1	T2	T1	T2	T1	T2	T1	T2	T1	T2
UTRA RF Channel Number		Channel 1				Channel 2				Channel 1			
PCCPCH_Ec/lor	dB	-3	-3			-3	-3			-3	-3		
SCH_Ec/lor	dB	-9	-9	-9	-9	-9	-9	-9	-9	-9	-9	-9	-9
SCH_toffset		0	0	0	0	5	5	5	5	10	10	10	10
PICH_Ec/lor	dB			-3	-3			-3	-3			-3	-3
OCNS_Ec/lor	dB	-4,28	-4,28	-4,28	-4,28	-4,28	-4,28	-4,28	-4,28	-4,28	-4,28	-4,28	-4,28
$\hat{I}_{or}/I_{oc}$	dB	9	3	9	3	3	9	3	9	-1	-1	-1	-1
PCCPCH RSCP	dBm	-64	-70			-70	-64			-74	-74		
Qoffset <sub>1s,n</sub>	dB	C1, C2: 0; C1, C3:0; C1,C4:0 C1, C5:0; C1,C6:0				C2, C1: 0; C2, C3:0; C2,C4:0 C2, C5: 0; C2, C6:0				C3, C1: 0; C3, C2:0; C3,C4:0 C3, C5: 0; C3, C6:0			
Qhyst <sub>1s</sub>	dB	0				0				0			
Treselection		0				0				0			
Sintrasearch	dB	not sent				not sent				not sent			
Sintersearch	dB	not sent				not sent				not sent			
FACH measurement occasion info		not sent				not sent				not sent			
Inter-frequency TDD measurement indicator		TRUE				TRUE				TRUE			
$I_{oc}$	dBm/3,8 4 MHz	-70											
Propagation Condition		AWGN											
		Cell 4				Cell 5				Cell 6			
Timeslot		0		8		0		8		0		8	
		T1	T2	T1	T2	T1	T2	T1	T2	T1	T2	T1	T2
UTRA RF Channel Number		Channel 1				Channel 2				Channel 2			
PCCPCH_Ec/lor	dB	-3	-3			-3	-3			-3	-3		
SCH_Ec/lor	dB	-9	-9	-9	-9	-9	-9	-9	-9	-9	-9	-9	-9
SCH_toffset		15	15	15	15	20	20	20	20	25	25	25	25
PICH_Ec/lor	dB			-3	-3			-3	-3			-3	-3
OCNS_Ec/lor	dB	-4,28	-4,28	-4,28	-4,28	-4,28	-4,28	-4,28	-4,28	-4,28	-4,28	-4,28	-4,28
$\hat{I}_{or}/I_{oc}$	dB	-1	-1	-1	-1	-1	-1	-1	-1	-1	-1	-1	-1
PCCPCH RSCP	dBm	-74	-74			-74	-74			-74	-74		
Qoffset <sub>1s,n</sub>	dB	C4, C1: 0; C4, C2:0; C4,C3:0 C4, C5:0; C4, C6:0				C5, C1: 0; C5, C2:0; C5,C3:0 C5, C4:0; C5, C6:0				C6, C1: 0; C6, C2:0; C6,C3:0 C6, C4:0; C6, C5:0			
Qhyst <sub>1s</sub>	dB	0				0				0			

Treselection		0	0	0
Sintrasearch	dB	not sent	not sent	not sent
Sintersearch	dB	not sent	not sent	not sent
FACH measurement occasion info		not sent	not sent	not sent
Inter-frequency TDD measurement indicator		TRUE	TRUE	TRUE
$I_{oc}$	dBm/3,8 4 MHz	-70		
Propagation Condition		AWGN		

NOTE: S-CCPCH shall not be located in TS0.

## 8.3.4.2.4.1.2 Procedure

- a) The SS activates cell 1-6 with T1 defined parameters.
- b) The UE is switched on.
- c) A call is set up according to the generic set-up procedure specified in TS 34.108 [3] subclauses 7.3.3 and 7.4.2 to place the UE in CELL\_FACH. If the UE has failed to respond with the correct message within the allowed time, a failure is recorded. The SS shall then wait for a total of 15s and if no response is received the UE shall be switched off and the procedure returns to step 1. Otherwise the SS shall transmit a CELL UPDATE CONFIRM message and then the procedure continues.
- d) After 15 s, the parameters are changed as described for T2.
- e) The SS waits for CELL UPDATE message with cause value "cell reselection" from the UE.
- f) After another 15 s, the parameters are changed as described for T1. If the UE has failed to respond with the correct message within the allowed time, a failure is recorded. The SS shall then wait for a total of 15s and if no response is received the UE shall be switched off and the procedure returns to step 1. Otherwise the SS shall transmit a CELL UPDATE CONFIRM message and then the procedure continues.
- g) The SS waits for CELL UPDATE message with cause value "cell reselection" from the UE.
- h) Repeat steps d) to g) [TBD] times.

## 8.3.4.2.4.2 1,28 Mcps TDD option

## 8.3.4.2.4.2.1 Initial conditions

This scenario contains 6 cells and 2 carrier frequencies. The test parameters are given in Tables 8.3.4.2.4.2.1, 8.3.4.2.4.2.2, 8.3.4.2.4.2.3, and 8.3.4.2.4.2.4.

**Table 8.3.4.2.4.2.1: General test parameters for 1,28Mcps Cell Re-selection in CELL\_FACH**

Parameter		Unit	Value	Comment
initial condition	Active cell		Cell1	
	Neighbour cells		Cell2, Cell3, Cell4, Cell5, Cell6	
final condition	Active cell		Cell2	
HCS			Not used	
UE_TXPWR_MAX_RACH		DBm	21	The value shall be used for all cells in the test.
Qrxlevmin		DBm	-103	The value shall be used for all cells in the test.
Access Service Class (ASC#0) - Persistence value			1	Selected so that no additional delay is caused by the random access procedure. The value shall be used for all cells in the test.
T <sub>SI</sub>		S	1,28	The value shall be used for all cells in the test.
T1		S	15(initial), 15 (repetition)	
T2		S	15	

**Table 8.3.4.2.4.2.2 Physical channel parameters for S-CCPCH.**

Parameter	Unit	Level
Channel bit rate	kbps	35.2
Channel symbol rate	ksps	17.6
Slot Format #	-	0; 2
Frame allocation	-	Continuous frame allocation
Midamble allocation	-	Common Midamble



**Table 8.3.4.2.4.2.3 Transport channel parameters for S-CCPCH**

<b>Parameter</b>	<b>FACH</b>
Transport Channel Number	1
Transport Block Size	240
Transport Block Set Size	240
Transmission Time Interval	20 ms
Type of Error Protection	Convolution Coding
Coding Rate	$\frac{1}{2}$
Rate Matching attribute	256
Size of CRC	16

**Table 8.3.4.2.4.2.4: Cell specific test parameters for 1,28Mcps Cell re-selection in CELL\_FACH state**

Parameter	Unit	Cell 1				Cell 2				Cell 3			
		0		DWPTS		0		DWPTS		0		DWPTS	
Timeslot Number		T1	T2	T1	T2	T1	T2	T1	T2	T1	T2	T1	T2
UTRA RF Channel Number		Channel 1				Channel 2				Channel 1			
PCCPCH_Ec/Ior	dB	-3	-3			-3	-3			-3	-3		
DwPCH_Ec/Ior	dB			0	0			0	0			0	0
OCNS_Ec/Ior	dB	-3	-3			-3	-3			-3	-3		
$\hat{I}_{or}/I_{oc}$	dB	10	4	10	4	4	10	4	10	-1	-1	-1	-1
PCCPCH RSCP	dBm	-63	-69			-69	-63			-74	-74		
Qoffset1 <sub>s,n</sub>	dB	C1, C2: 0; C1, C3:0; C1,C4:0 C1, C5:0; C1,C6:0				C2, C1: 0; C2, C3:0; C2,C4:0 C2, C5: 0; C2:C6:0				C3, C1: 0; C3, C2:0; C3,C4:0 C3, C5: 0; C3:C6:0			
Qhyst1 <sub>s</sub>	dBm	0				0				0			
Treselection	s	0				0				0			
Sintrasearch	dB	not sent				not sent				not sent			
Sintersearch	dB	not sent				not sent				not sent			
FACH measurement occasion info		not sent				not sent				not sent			
FACH measurement occasion cycle length		4				4				4			
Inter-frequency TDD measurement indicator		TRUE				TRUE				TRUE			
Inter-frequency FDD measurement indicator		FALSE				FALSE				FALSE			
Timeslot		Cell 4				Cell 5				Cell 6			
		0		DWPTS		0		DWPTS		0		DWPTS	
UTRA RF Channel Number		Channel 1				Channel 2				Channel 2			
PCCPCH_Ec/Ior	dB	-3	-3			-3	-3			-3	-3		
DwPCH_Ec/Ior	dB			0	0			0	0			0	0
OCNS_Ec/Ior	dB	-3	-3			-3	-3			-3	-3		
$\hat{I}_{or}/I_{oc}$	dB	-1	-1	-1	-1	-1	-1	-1	-1	-1	-1	-1	-1
PCCPCH RSCP	dBm	-74	-74			-74	-74			-74	-74		
Qoffset1 <sub>s,n</sub>	dB	C4, C1: 0; C4, C2:0; C4,C3:0C4, C5:0; C4:C6:0				C5, C1: 0; C5, C2:0; C5,C3:0 C5, C4:0; C5:C6:0				C6, C1: 0; C6, C2:0; C6,C3:0 C6, C4:0; C6:C5:0			
Qhyst1 <sub>s</sub>	dB	0				0				0			
Treselection	s	0				0				0			
Sintrasearch	dB	not sent				not sent				not sent			
Sintersearch	dB	not sent				not sent				not sent			
FACH measurement occasion info		not sent				not sent				not sent			
FACH measurement occasion cycle length		4				4				4			
Inter-frequency TDD measurement indicator		TRUE				TRUE				TRUE			
Inter-frequency FDD measurement indicator		FALSE				FALSE				FALSE			
$I_{oc}$	dBm/ 1,28 MHz	-70											
Propagation Condition		AWGN											

NOTE: S-CCPCH is located in an other downlink TS than TS0.

8.3.4.2.4.2.2 Procedure

- a) The SS activates cell 1-6 with T1 defined parameters.

- b) The UE is switched on.
- c) A call is set up according to the generic set-up procedure specified in TS 34.108 [3] subclauses 7.3.3 7.4.2 to place the UE in CELL\_FACH.
- d) After 15 s, the parameters are changed as described for T2.
- e) The SS waits for SYNCH-UL sequence in the UpPTS for sending CELL UPDATE message with cause value "cell reselection" from the UE. If the UE has failed to respond with the correct message within the allowed time, a failure is recorded. The SS shall then wait for a total of 15s and if no response is received the UE shall be switched off and the procedure returns to step a). Otherwise the SS shall transmit a CELL UPDATE CONFIRM message and then the procedure continues
- f) After another 15 s, the parameters are changed as described for T1.
- g) The SS waits for SYNCH-UL sequence in the UpPTS for sending CELL UPDATE message with cause value "cell reselection" from the UE. If the UE has failed to respond with the correct message within the allowed time, a failure is recorded. The SS shall then wait for a total of 15s and if no response is received the UE shall be switched off and the procedure returns to step a). Otherwise the SS shall transmit a CELL UPDATE CONFIRM message and then the procedure continues.
- h) After another 15 s, the UE shall be switched off.
- i) Repeat steps a) to h) until the confidence level according to annex F.6.2 is achieved.

#### 8.3.4.2.4.3 7,68 Mcps TDD option

##### 8.3.4.2.4.3.1 Initial conditions

This scenario contains 6 cells and 2 carrier frequencies. The test parameters are given in Tables 8.3.4.2.4.3.1, 8.3.4.2.4.3.2, 8.3.4.2.4.3.3, and 8.3.4.2.4.3.4.

**Table 8.3.4.2.4.3.1: General test parameters for Cell Re-selection in CELL\_FACH**

Parameter		Unit	Value	Comment
Initial condition	Active cell		Cell1	
	Neighbour cells		Cell2, Cell3, Cell4, Cell5, Cell6	
Final condition	Active cell		Cell2	
HCS			Not used	
UE_TXPWR_MAX_RACH		dBm	21	The value shall be used for all cells in the test.
Qrxlevmin		dBm	-102	The value shall be used for all cells in the test.
Access Service Class (ASC#0) - Persistence value		-	1	Selected so that no additional delay is caused by the random access procedure. The value shall be used for all cells in the test.
T <sub>SI</sub>		s	1,28	The value shall be used for all cells in the test.
T1		s	15 (initial), 5 (repetition)	
T2		s	5	

**Table 8.3.4.2.4.3.2: Physical channel parameters for S-CCPCH.**

Parameter	Unit	Level
Channel bit rate	Kbps	24,4
Channel symbol rate	Ksps	12,2
Slot Format #	-	0
Frame allocation	-	Continuous frame allocation
Midamble allocation	-	Default Midamble

**Table 8.3.4.2.4.3.3: Transport channel parameters for S-CCPCH**

<b>Parameter</b>	<b>FACH</b>
Transport Channel Number	1
Transport Block Size	240
Transport Block Set Size	240
Transmission Time Interval	20 ms
Type of Error Protection	Convolutional Coding
Coding Rate	$\frac{1}{2}$
Rate Matching attribute	256
Size of CRC	16

Table 8.3.4.2.4.3.4: Cell specific test parameters for Cell Re-selection in CELL\_FACH

Parameter	Unit	Cell 1				Cell 2				Cell 3			
		0		8		0		8		0		8	
Timeslot Number		T1	T2	T1	T2	T1	T2	T1	T2	T1	T2	T1	T2
UTRA RF Channel Number		Channel 1				Channel 2				Channel 1			
PCCPCH_Ec/lor	dB	-3	-3			-3	-3			-3	-3		
SCH_Ec/lor	dB	-9	-9	-9	-9	-9	-9	-9	-9	-9	-9	-9	-9
SCH_toffset		0	0	0	0	5	5	5	5	10	10	10	10
PICH_Ec/lor	dB			-3	-3			-3	-3			-3	-3
OCNS_Ec/lor	dB	-3,12	-3,12	-3,12	-3,12	-3,12	-3,12	-3,12	-3,12	-3,12	-3,12	-3,12	-3,12
$\hat{I}_{or}/I_{oc}$	dB	9	3	9	3	3	9	3	9	-1	-1	-1	-1
PCCPCH RSCP	dBm	-64	-70			-70	-64			-74	-74		
Qoffset1 <sub>s,n</sub>	dB	C1, C2: 0; C1, C3:0; C1,C4:0 C1, C5:0; C1,C6:0				C2, C1: 0; C2, C3:0; C2,C4:0 C2, C5: 0; C2, C6:0				C3, C1: 0; C3, C2:0; C3,C4:0 C3, C5: 0; C3, C6:0			
Qhyst1 <sub>s</sub>	dB	0				0				0			
Treselection		0				0				0			
Sintrasearch	dB	not sent				not sent				not sent			
Sintersearch	dB	not sent				not sent				not sent			
FACH measurement occasion info		not sent				not sent				not sent			
Inter-frequency TDD measurement indicator		TRUE				TRUE				TRUE			
$I_{oc}$	dBm/ 7,68 MHz	-70											
Propagation Condition		AWGN											
		Cell 4				Cell 5				Cell 6			
Timeslot		0		8		0		8		0		8	
		T1	T2	T1	T2	T1	T2	T1	T2	T1	T2	T1	T2
UTRA RF Channel Number		Channel 1				Channel 2				Channel 2			
PCCPCH_Ec/lor	dB	-3	-3			-3	-3			-3	-3		
SCH_Ec/lor	dB	-9	-9	-9	-9	-9	-9	-9	-9	-9	-9	-9	-9
SCH_toffset		15	15	15	15	20	20	20	20	25	25	25	25
PICH_Ec/lor	dB			-3	-3			-3	-3			-3	-3
OCNS_Ec/lor	dB	-3,12	-3,12	-3,12	-3,12	-3,12	-3,12	-3,12	-3,12	-3,12	-3,12	-3,12	-3,12
$\hat{I}_{or}/I_{oc}$	dB	-1	-1	-1	-1	-1	-1	-1	-1	-1	-1	-1	-1
PCCPCH RSCP	dBm	-74	-74			-74	-74			-74	-74		

Qoffset <sub>1s,n</sub>	dB	C4, C1: 0; C4, C2:0; C4,C3:0 C4, C5:0; C4, C6:0	C5, C1: 0; C5, C2:0; C5,C3:0 C5, C4:0; C5, C6:0	C6, C1: 0; C6, C2:0; C6,C3:0 C6, C4:0; C6, C5:0
Qhyst <sub>1s</sub>	dB	0	0	0
Treselection		0	0	0
Sintrasearch	dB	not sent	not sent	not sent
Sintersearch	dB	not sent	not sent	not sent
FACH measurement occasion info		not sent	not sent	not sent
Inter-frequency TDD measurement indicator		TRUE	TRUE	TRUE
$I_{oc}$	dBm/ 7,68 MHz	-70		
Propagation Condition		AWGN		

NOTE: S-CCPCH shall not be located in TS0.

#### 8.3.4.2.4.3.2 Procedure

- a) The SS activates cell 1-6 with T1 defined parameters.
- b) The UE is switched on.
- c) A call is set up according to the generic set-up procedure specified in TS 34.108 [3] subclauses 7.3.3 and 7.4.2 to place the UE in CELL\_FACH. If the UE has failed to respond with the correct message within the allowed time, a failure is recorded. The SS shall then wait for a total of 15s and if no response is received the UE shall be switched off and the procedure returns to step 1. Otherwise the SS shall transmit a CELL UPDATE CONFIRM message and then the procedure continues.
- d) After 15 s, the parameters are changed as described for T2.
- e) The SS waits for CELL UPDATE message with cause value "cell reselection" from the UE.
- f) After another 15 s, the parameters are changed as described for T1. If the UE has failed to respond with the correct message within the allowed time, a failure is recorded. The SS shall then wait for a total of 15s and if no response is received the UE shall be switched off and the procedure returns to step 1. Otherwise the SS shall transmit a CELL UPDATE CONFIRM message and then the procedure continues.
- g) The SS waits for CELL UPDATE message with cause value "cell reselection" from the UE.
- h) Repeat steps d) to g) until the confidence level according to annex F.6.2 is achieved.

#### 8.3.4.2.5 Test Requirements

##### 8.3.4.2.5.1 3,84 Mcps TDD option

- 1) In step d), after the UE has responded on cell 1, it shall not respond on any other cell (cell selection).
- 2) In step e), the UE shall respond on cell 1 within 3 s.
- 3) In step g), the UE shall respond on cell 2 within 3 s.

For the test to pass, the total number of fulfilled test requirements 2) and 3) shall be more than [FFS]% of the cases.

NOTE: If the above Test Requirement differs from the Minimum Requirement then the Test Tolerance applied for this test is non-zero. The Test Tolerance for this test is defined in clause F.2 and the explanation of how the Minimum Requirement has been relaxed by the Test Tolerance is given in clause F.4.

##### 8.3.4.2.5.2 1,28 Mcps TDD option

- 1) In step d), after the UE has responded on cell 1, it shall not respond on any other cell (cell selection).
- 2) In step e), the UE shall respond on cell 1 within 2 s.
- 3) In step g), the UE shall respond on cell 2 within 2 s.

For the test to pass, the total number of fulfilled test requirements 2) and 3) shall be more than 90% with a confidence level of 95% of the cases.

NOTE: If the above Test Requirement differs from the Minimum Requirement then the Test Tolerance applied for this test is non-zero. The Test Tolerance for this test is defined in clause F.2 and the explanation of how the Minimum Requirement has been relaxed by the Test Tolerance is given in clause F.4.

#### 8.3.4.2.5.3 7,68 Mcps TDD option

- 1) In step d), after the UE has responded on cell 1, it shall not respond on any other cell (cell selection).
- 2) In step e), the UE shall respond on cell 1 within 3 s.
- 3) In step g), the UE shall respond on cell 2 within 3 s.

For the test to pass, the total number of fulfilled test requirements 2) and 3) shall be more than 90% of the cases.

NOTE: If the above Test Requirement differs from the Minimum Requirement then the Test Tolerance applied for this test is non-zero. The Test Tolerance for this test is defined in clause F.2 and the explanation of how the Minimum Requirement has been relaxed by the Test Tolerance is given in clause F.4.

### 8.3.4.3 Scenario 3: TDD/GSM cell re-selection

#### 8.3.4.3.1 Definition and applicability

##### 8.3.4.3.1.1 3,84 Mcps TDD option

Void

##### 8.3.4.3.1.2 1,28 Mcps TDD option

The cell re-selection delay is defined as the time from when the cell quality levels change to the moment when this change makes the UE reselect a better ranked cell, and starts to send CHANNEL REQUEST message to perform a Location update to the new cell.

This test is for the case where the UE camps on a 1,28 Mcps TDD cell and reselects to a GSM cell.

The requirements and this test apply to UEs supporting both 1,28 Mcps TDD and GSM.

##### 8.3.4.3.1.3 7,68 Mcps TDD option

Void

#### 8.3.4.3.2 Minimum requirement

##### 8.3.4.3.2.1 3,84 Mcps TDD option

Void



## 8.3.4.3.2.2 1,28 Mcps TDD option

The cell re-selection delay shall be less than  $5530\text{ms} + T_{\text{BCCH}}$ ,

NOTE: The cell re-selection delay can be expressed as:

$$T_{\text{reselection GSM}} = T_{\text{identify GSM}} + T_{\text{measurement GSM}} + 40 + T_{\text{BCCH}} + T_{\text{RA}} \text{ (ms)}$$

where

$T_{\text{BCCH}}$  : The maximum time allowed to read BCCH data from GSM cell, 1.9s.

$T_{\text{RA}}$  : The additional delay caused by the random access procedure, 10ms.

$T_{\text{identify GSM}}$  Specified in TS 25.123, here it is 5000ms

$T_{\text{measurement GSM}}$  : 480ms

This gives a total of 7430ms, thus allow 7.5s.

## 8.3.4.3.2.3 7,68 Mcps TDD option

Void

## 8.3.4.3.3 Test purpose

This test verifies that the UE meets the minimum requirement for the inter-RAT cell re-selection delay in CELL\_FACH state.

## 8.3.4.3.4 Method of test

## 8.3.4.3.4.1 3,84 Mcps TDD option

Void

## 8.3.4.3.4.2 1,28 Mcps TDD option

## 8.3.4.3.4.2.1 Initial conditions

This scenario implies the presence of one 1.28 Mcps TDD serving cell, and one GSM cell to be re-selected. Test parameters are given in Tables 8.3.4.3.4.1, 8.3.4.3.4.2, 8.3.4.3.4.3, 8.3.4.3.4.4, 8.3.4.3.4.5.

The ranking of the cells shall be made according to the cell reselection criteria specified in TS25.304. Cell 1 and cell 2 shall belong to different location areas.

**Table 8.3.4.3.4.1: General test parameters for 1,28 Mcps Cell Re-selection in CELL\_FACH**

	Parameter	Unit	Value	Comment
initial condition	Active cell		Cell1	
	Neighbour cells		Cell2	
final condition	Active cell		Cell2	
HCS			Not used	
	UE_TXPWR_MAX_RACH	dBm	21	The value shall be used for all cells in the test.
	Qrxlevmin	dBm	-103	The value shall be used for all cells in the test.
	Access Service Class (ASC#0) - Persistence value		1	Selected so that no additional delay is caused by the random access procedure. The value shall be used for all cells in the test.
	T <sub>SI</sub>	s	1,28	The value shall be used for all cells in the test.
	T1	s	15	
	T2	s	15	

**Table 8.3.4.3.4.2: Physical channel parameters for S-CCPCH**

Parameter	Unit	Level
Channel bit rate	kbps	35.2
Channel symbol rate	ksps	17.6
Slot Format #	-	0; 2
Frame allocation	-	Continuous frame allocation
Midamble allocation	-	Common Midamble

Table 8.3.4.3.4.3: Transport channel parameters for FACH

Parameter	FACH
Transport Channel Number	1
Transport Block Size	240
Transport Block Set Size	240
Transmission Time Interval	20 ms
Type of Error Protection	Convolution Coding
Coding Rate	$\frac{1}{2}$
Rate Matching attribute	256
Size of CRC	16

Table 8.3.4.3.4.4: Cell specific test parameters for 1,28 Mcps Cell(Cell 1) Re-selection in CELL\_FACH

Parameter	Unit	Cell 1 (UTRA)			
		0		DwPTS	
Timeslot Number		T1	T2	T1	T2
UTRA RF Channel Number		Channel 1		Channel 1	
PCCPCH_Ec/Ior	dB	-3	-3		
DwPCH_Ec/Ior	dB			0	0
OCNS_Ec/Ior	dB	-3	-3		
$\hat{I}_{or}/I_{oc}$	dB	6	6	6	6
$I_{oc}$	dBm/1,28 MHz	-80			
PCCPCH RSCP	dBm	-77			
Propagation Condition		AWGN		AWGN	
Treselection	s	0			
Ssearch <sub>RAT</sub>	dB	Not sent			
Qrxlevmin	dBm	-103			
Qoffset1 <sub>s,n</sub>	dB	C1, C2: 0			
Qhyst1 <sub>s</sub>	dB	0			

Table 8.3.4.3.4.5: Cell specific test parameters for Cell 2(GSM) re-selection in CELL\_FACH state

Parameter	Unit	Cell 2 (GSM)	
		T1	T2
Absolute RF Channel Number		ARFCN 1	
RXLEV	dBm	-90	-70
RXLEV_ACCESS_MIN	dBm	-103	
MS_TXPWR_MAX_CCH	dBm	33	
Qsearch_I	-	always	

## 8.3.4.2.4.2.2 Procedure

The SS activates cell 1-2 with T1 defined parameters;

- a) The UE switched on.
- b) A RRC connection is set up according the generic set-up procedure specified in TS 34.108[3] clause 7.3.3 and 7.4.2 to place UE in CELL\_FACH state;
- c) After 15s the parameters changed to those defined for T2;
- d) If the UE responds on cell 2 for the CHANNEL REQUEST within 7.5s, the success is recorded;
- e) If the UE doesn't respond on cell 2 for the CHANNEL REQUEST within 7.5s, a failure is recorded. The SS shall then wait for a total of 10s from the beginning of T2 and if no response is received, the UE shall be switched off and the procedure returns to step a);
- f) After 15s from the beginning of T2, the UE shall be switched off;

Repeat step d) to g) until the confidence level according to annex F.6.2 is achieved.

## 8.3.4.3.4.3 7,68 Mcps TDD option

Void

## 8.3.4.3.5 Test Requirements

## 8.3.4.3.5.1 3,84 Mcps TDD option

Void

## 8.3.4.3.5.2 1,28 Mcps TDD option

In step d), the UE shall respond on cell 2 within 7.5 s.

For the test to pass, the total number of fulfilled test requirement shall be more than 90% with a confidence level of 95% of the cases.

NOTE: If the above Test Requirement differs from the Minimum Requirement then the Test Tolerance applied for this test is non-zero. The Test Tolerance for this test is defined in clause F.2 and the explanation of how the Minimum Requirement has been relaxed by the Test Tolerance is given in clause F.4.

8.3.4.3.5.3 7,68 Mcps TDD option

Void

## 8.3.4A Cell Re-selection in Enhanced CELL\_FACH

### 8.3.4A.1 Scenario 1: Cell Re-selection to Intra-Frequency TDD cell

8.3.4A.1.1 Definition and applicability

8.3.4A.1.1.1 3,84 Mcps TDD option

Void

8.3.4A.1.1.2 1,28 Mcps TDD option

The cell re-selection delay is defined as the time from a change of cell levels to the moment when this change causes the UE to camp on a new cell , and starts to send SYNCH-UL sequence in the UpPTS for sending the CELL UPDATE with cause value "cell reselection".

The requirements and this test apply to the 1,28 Mcps TDD UE of release 8 and later supporting Enhanced CELL\_FACH.

8.3.4A.1.1.3 7,68 Mcps TDD option

Void

8.3.4A.1.2 Minimum requirement

8.3.4A.1.2.1 3,84 Mcps TDD option

Void

8.3.4A.1.2.2 1,28 Mcps TDD option

The cell re-selection delay shall be less than 1.6s.

The rate of correct cell re-selections observed during repeated tests shall be at least 90%.

The normative reference for this requirement is TS 25.123 [2] clauses 5.4.3 and A.5.4A.2.1.

8.3.4A.1.2.3 7,68 Mcps TDD option

Void

## 8.3.4A.1.3 Test purpose

This test verifies that the UE meets the minimum requirement for the cell re-selection delay to intra-frequency TDD cell in Enhanced CELL\_FACH.

## 8.3.4A.1.4 Method of test

## 8.3.4A.1.4.1 3,84 Mcps TDD option

Void

## 8.3.4A.1.4.2 1,28 Mcps TDD option

## 8.3.4A.1.4.2.1 Initial conditions

This scenario contains 6 cells operating on the same carrier frequency. The test parameters are given in Tables 8.3.4A.1.4.2.1 and 8.3.4A.1.4.2.2.

**Table 8.3.4A.1.4.2.1: General test parameters for 1,28 Mcps Cell Re-selection to intra-frequency TDD cell in Enhanced CELL\_FACH**

	Parameter	Unit	Value	Comment
initial condition	Active cell		Cell1	
	Neighbour cells		Cell2, Cell3, Cell4, Cell5, Cell6	
final condition	Active cell		Cell2	
	HCS		Not used	
	UE_TXPWR_MAX_RACH	dBm	21	The value shall be used for all cells in the test.
	Qrxlevmin	dBm	-103	The value shall be used for all cells in the test.
	Access Service Class (ASC#0) - Persistence value		1	Selected so that no additional delay is caused by the random access procedure. The value shall be used for all cells in the test.
	T <sub>SI</sub>	s	1,28	The value shall be used for all cells in the test.
	T1	s	15 (initial), 5 (repetition)	
	T2	s	5	

Table 8.3.4A.1.4.2.2: Cell specific test parameters for 1,28 Mcps Cell Re-selection to intra-frequency TDD cell in Enhanced CELL\_FACH

Parameter	Unit	Cell 1				Cell 2				Cell 3			
		0		DWPTS		0		DWPTS		0		DWPTS	
Timeslot Number		T1	T2	T1	T2	T1	T2	T1	T2	T1	T2	T1	T2
UTRA RF Channel Number		Channel 1				Channel 1				Channel 1			
PCCPCH_Ec/lor	dB	-3	-3			-3	-3			-3	-3		
DwPCH_Ec/lor	dB			0	0			0	0			0	0
OCNS_Ec/lor	dB	-3	-3			-3	-3			-3	-3		
$\hat{I}_{or}/I_{oc}$	dB	10	7	10	7	7	10	7	9	-1	-1	-1	-1
PCCPCH RSCP	dBm	-63	-66			-66	-63			-74	-74		
Qoffset1 <sub>s,n</sub>	dB	C1, C2: 0; C1, C3:0; C1,C4:0 C1, C5:0; C1,C6:0				C2, C1: 0; C2, C3:0; C2,C4:0 C2, C5: 0; C2, C6:0				C3, C1: 0; C3, C2:0; C3,C4:0 C3, C5: 0; C3, C6:0			
Qhyst1 <sub>s</sub>	dB	0				0				0			
Treselection		0				0				0			
Sintrasearch	dB	not sent				not sent				not sent			
FACH measurement occasion info		not sent				not sent				not sent			
		Cell 4				Cell 5				Cell 6			
Timeslot		0		DWPTS		0		DWPTS		0		DWPTS	
		T1	T2	T1	T2	T1	T2	T1	T2	T1	T2	T1	T2
UTRA RF Channel Number		Channel 1				Channel 1				Channel 1			
PCCPCH_Ec/lor	dB	-3	-3			-3	-3			-3	-3		
DwPCH_Ec/lor	dB			0	0			0	0			0	0
OCNS_Ec/lor	dB	-3	-3			-3	-3			-3	-3		
$\hat{I}_{or}/I_{oc}$	dB	-1	-1	-1	-1	-1	-1	-1	-1	-1	-1	-1	-1
PCCPCH RSCP	dBm	-74	-74			-74	-74			-74	-74		
Qoffset1 <sub>s,n</sub>	dB	C4, C1: 0; C4, C2:0; C4,C3:0 C4, C5:0; C4, C6:0				C5, C1: 0; C5, C2:0; C5,C3:0 C5, C4:0; C5, C6:0				C6, C1: 0; C6, C2:0; C6,C3:0 C6, C4:0; C6, C5:0			
Qhyst1 <sub>s</sub>	dB	0				0				0			
Treselection		0				0				0			
Sintrasearch	dB	not sent				not sent				not sent			
FACH measurement occasion info		not sent				not sent				not sent			
$I_{oc}$	dBm/1,2 8 MHz	-70											
Propagation Condition		AWGN											

NOTE: S-CCPCH is located in an other downlink TS than TS0..

#### 8.3.4A.1.4.2.2 Procedure

- a) The SS activates cell 1-6 with T1 defined parameters.
- b) The UE is switched on.
- c) A call is set up according to the generic set-up procedure specified in TS 34.108 [3] subclause s 7.3.5 to place the UE in CELL\_FACH.
- d) After 15 s, the parameters are changed as described for T2.
- e) The SS waits for SYNCH-UL sequence in the UpPTS for sending CELL UPDATE message with cause value "cell reselection" from the UE. If the UE has failed to respond with the correct message within the allowed time, a failure is recorded. The SS shall then wait for a total of 15s and if no response is received the UE shall be switched off and the procedure returns to step 1. Otherwise the SS shall transmit a CELL UPDATE CONFIRM message and then the procedure continues.
- f) After another 15 s, the parameters are changed as described for T1.
- g) The SS waits for SYNCH-UL sequence in the UpPTS for sending CELL UPDATE message with cause value "cell reselection" from the UE. If the UE has failed to respond with the correct message within the allowed time, a failure is recorded. The SS shall then wait for a total of 15 s and if no response is received the UE shall be switched off and the procedure returns to step 1. Otherwise the SS shall transmit a CELL UPDATE CONFIRM message and then the procedure continues
- h) Repeat steps until the confidence level according to annex F.6.2 is achieved.

#### 8.3.4A.1.4.3 7,68 Mcps TDD option

Void

#### 8.3.4A.1.5 Test Requirements

##### 8.3.4A.1.5.1 3,84 Mcps TDD option

Void

##### 8.3.4A.1.5.2 1,28 Mcps TDD option

- 1) In step d), after the UE has responded on cell 1, it shall not respond on any other cell (cell selection).
- 2) In step e), the UE shall respond on cell 2 within 1.6 s.
- 3) In step g), the UE shall respond on cell 1 within 1.6 s.

For the test to pass, the total number of fulfilled test requirements 2) and 3) shall be more than 90% with a confidence level of 95% of the cases.



NOTE: If the above Test Requirement differs from the Minimum Requirement then the Test Tolerance applied for this test is non-zero. The Test Tolerance for this test is defined in clause F.2 and the explanation of how the Minimum Requirement has been relaxed by the Test Tolerance is given in clause F.4.

8.3.4A.1.5.3 7,68 Mcps TDD option

Void

8.3.4A.1 Scenario 2: Cell Re-selection to Inter-Frequency TDD cell

8.3.4A.2.1 Definition and applicability

8.3.4A.2.1.1 3,84 Mcps TDD option

Void

8.3.4A.2.1.2 1,28 Mcps TDD option

The cell re-selection delay is defined as the time from a change of cell levels to the moment when this change causes the UE to camp on a new cell , and starts to send SYNCH-UL sequence in the UpPTS for sending the CELL UPDATE with cause value "cell reselection".

The requirements and this test apply to the 1,28 Mcps TDD UE.

8.3.4A.2.1.3 7,68 Mcps TDD option

Void

8.3.4A.2.2 Minimum requirement

8.3.4A.2.2.1 3,84 Mcps TDD option

Void

8.3.4A.2.2.2 1,28 Mcps TDD option

The cell re-selection delay shall be less than 2 s. The rate of correct cell re-selections observed during repeated tests shall be at least 90%.

The normative reference for this requirement is TS 25.123 [2] clauses 5.4.3 and A.5.4A.2.2.

8.3.4A.2.2.3 7,68 Mcps TDD option

Void

8.3.4A.2.3 Test purpose

This test verifies that the UE meets the requirement for the cell re-selection delay to inter-frequency TDD cell in Enhanced CELL\_FACH.

- 8.3.4A.2.4 Method of test
- 8.3.4A.2.4.1 3,84 Mcps TDD option
- Void
- 8.3.4A.2.4.2 1,28 Mcps TDD option
- 8.3.4A.2.4.2.1 Initial conditions

This scenario contains 6 cells and 2 carrier frequencies. The test parameters are given in Tables 8.3.4A.2.4.2.1 and 8.3.4A.2.4.2.2.

**Table 8.3.4A.2.4.2.1: General test parameters for 1,28Mcps Cell Re-selection to inter-frequency TDD cell in Enhanced CELL\_FACH**

Parameter		Unit	Value	Comment
initial condition	Active cell		Cell1	
	Neighbour cells		Cell2, Cell3, Cell4, Cell5, Cell6	
final condition	Active cell		Cell2	
HCS			Not used	
UE_TXPWR_MAX_RACH		DBm	21	The value shall be used for all cells in the test.
Qrxlevmin		DBm	-103	The value shall be used for all cells in the test.
Access Service Class (ASC#0) - Persistence value			1	Selected so that no additional delay is caused by the random access procedure. The value shall be used for all cells in the test.
T <sub>SI</sub>		S	1,28	The value shall be used for all cells in the test.
T1		S	15(initial), 5 (repetition)	
T2		S	5	

Table 8.3.4A.2.4.2.2: Cell specific test parameters for 1,28Mcps Cell re-selection to inter-frequency TDD cell in Enhanced CELL\_FACH state

Parameter	Unit	Cell 1				Cell 2				Cell 3			
		0		DWPTS		0		DWPTS		0		DWPTS	
		T1	T2	T1	T2	T1	T2	T1	T2	T1	T2	T1	T2
UTRA RF Channel Number		Channel 1				Channel 2				Channel 1			
PCCPCH_Ec/lor	dB	-3	-3			-3	-3			-3	-3		
DwPCH_Ec/lor	dB			0	0			0	0			0	0
OCNS_Ec/lor	dB	-3	-3			-3	-3			-3	-3		
$\hat{I}_{or}/I_{oc}$	dB	10	4	10	4	4	10	4	10	-1	-1	-1	-1
PCCPCH RSCP	dBm	-63	-69			-69	-63			-74	-74		
Qoffset1 <sub>s,n</sub>	dB	C1, C2: 0; C1, C3:0; C1,C4:0 C1, C5:0; C1,C6:0				C2, C1: 0; C2, C3:0; C2,C4:0 C2, C5: 0; C2:C6:0				C3, C1: 0; C3, C2:0; C3,C4:0 C3, C5: 0; C3:C6:0			
Qhyst1 <sub>s</sub>	dBm	0				0				0			
Treselection	s	0				0				0			
Sintrasearch	dB	not sent				not sent				not sent			
Sintersearch	dB	not sent				not sent				not sent			
FACH measurement occasion info		not sent				not sent				not sent			
FACH measurement occasion cycle length		4				4				4			
Inter-frequency TDD measurement indicator		TRUE				TRUE				TRUE			
Inter-frequency FDD measurement indicator		FALSE				FALSE				FALSE			
		Cell 4				Cell 5				Cell 6			
Timeslot		0		DWPTS		0		DWPTS		0		DWPTS	
		T1	T2	T1	T2	T1	T2	T1	T2	T1	T2	T1	T2
UTRA RF Channel Number		Channel 1				Channel 2				Channel 2			
PCCPCH_Ec/lor	dB	-3	-3			-3	-3			-3	-3		
DwPCH_Ec/lor	dB			0	0			0	0			0	0
OCNS_Ec/lor	dB	-3	-3			-3	-3			-3	-3		
$\hat{I}_{or}/I_{oc}$	dB	-1	-1	-1	-1	-1	-1	-1	-1	-1	-1	-1	-1
PCCPCH RSCP	dBm	-74	-74			-74	-74			-74	-74		
Qoffset1 <sub>s,n</sub>	dB	C4, C1: 0; C4, C2:0; C4,C3:0C4, C5:0; C4:C6:0				C5, C1: 0; C5, C2:0; C5,C3:0 C5, C4:0; C5:C6:0				C6, C1: 0; C6, C2:0; C6,C3:0 C6, C4:0; C6:C5:0			
Qhyst1 <sub>s</sub>	dB	0				0				0			
Treselection	s	0				0				0			
Sintrasearch	dB	not sent				not sent				not sent			

Sintersearch	dB	not sent	not sent	not sent
FACH measurement occasion info		not sent	not sent	not sent
FACH measurement occasion cycle length		4	4	4
Inter-frequency TDD measurement indicator		TRUE	TRUE	TRUE
Inter-frequency FDD measurement indicator		FALSE	FALSE	FALSE
$I_{oc}$	dBm/ 1,28 MHz	-70		
Propagation Condition		AWGN		

NOTE: S-CCPCH is located in an other downlink TS than TS0.

#### 8.3.4A.2.4.2.2 Procedure

- a) The SS activates cell 1-6 with T1 defined parameters.
- b) The UE is switched on.
- c) A call is set up according to the generic set-up procedure specified in TS 34.108 [3] subclauses 7.3.5 to place the UE in CELL\_FACH.
- d) After 15 s, the parameters are changed as described for T2.
- e) The SS waits for SYNCH-UL sequence in the UpPTS for sending CELL UPDATE message with cause value "cell reselection" from the UE. If the UE has failed to respond with the correct message within the allowed time, a failure is recorded. The SS shall then wait for a total of 15s and if no response is received the UE shall be switched off and the procedure returns to step 1. Otherwise the SS shall transmit a CELL UPDATE CONFIRM message and then the procedure continues
- f) After another 15 s, the parameters are changed as described for T1.
- g) The SS waits for SYNCH-UL sequence in the UpPTS for sending CELL UPDATE message with cause value "cell reselection" from the UE. If the UE has failed to respond with the correct message within the allowed time, a failure is recorded. The SS shall then wait for a total of 15s and if no response is received the UE shall be switched off and the procedure returns to step 1. Otherwise the SS shall transmit a CELL UPDATE CONFIRM message and then the procedure continues
- h) Repeat steps d) to g) until the confidence level according to annex F.6.2 is achieved.

#### 8.3.4A.2.4.3 7,68 Mcps TDD option

Void

## 8.3.4A.2.5 Test Requirements

## 8.3.4A.2.5.1 3,84 Mcps TDD option

Void

## 8.3.4A.2.5.2 1,28 Mcps TDD option

- 1) In step d), after the UE has responded on cell 1, it shall not respond on any other cell (cell selection).
- 2) In step e), the UE shall respond on cell 1 within 1.9 s.
- 3) In step g), the UE shall respond on cell 2 within 1.9 s.

For the test to pass, the total number of fulfilled test requirements 2) and 3) shall be more than 90% with a confidence level of 95% of the cases.

NOTE: If the above Test Requirement differs from the Minimum Requirement then the Test Tolerance applied for this test is non-zero. The Test Tolerance for this test is defined in clause F.2 and the explanation of how the Minimum Requirement has been relaxed by the Test Tolerance is given in clause F.4.

## 8.3.4A.2.5.3 7,68 Mcps TDD option

Void

## 8.3.5 Cell Re-selection in CELL\_PCH

### 8.3.5.1 Scenario 1: TDD/TDD cell re-selection single carrier case

#### 8.3.5.1.1 Definition and applicability

##### 8.3.5.1.1.1 3,84 Mcps TDD option

The cell re-selection delay is defined as the time from a change of cell levels to the moment when this change causes the UE to camp on a new cell, and starts to send the CELL UPDATE message with cause value "cell reselection" in the new cell.

The requirements and this test apply to the 3,84 Mcps TDD UE.

##### 8.3.5.1.1.2 1,28 Mcps TDD option

The cell re-selection delay is defined as the time from a change of cell levels to the moment when this change causes the UE to camp on a new cell, and starts to send SYNCH-UL sequence in the UpPTS for sending the CELL UPDATE with cause value "cell reselection".

The requirements and this test apply to the 1,28 Mcps TDD UE.

##### 8.3.5.1.1.3 7,68 Mcps TDD option

The cell re-selection delay is defined as the time from a change of cell levels to the moment when this change causes the UE to camp on a new cell, and starts to send the CELL UPDATE message with cause value "cell reselection" in the new cell.

The requirements and this test apply to the 7,68 Mcps TDD UE.

#### 8.3.5.1.2 Minimum requirement

##### 8.3.5.1.2.1 3,84 Mcps TDD option

The cell re-selection delay shall be less than 8 s.

NOTE:

The cell re-selection delay can be expressed as:  $T_{\text{evaluateTDD}} + T_{\text{SI}}$ , where:

$T_{\text{evaluateTDD}}$  A DRX cycle length of 1280ms is assumed for this test case, this leads to a  $T_{\text{evaluateTDD}}$  of 6.4s according to TS 25.123 [2] table 4.1 in clause 4.2.2.7.

$T_{SI}$  Maximum repetition period of relevant system info blocks that needs to be received by the UE to camp on a cell. 1280 ms is assumed in this test case.  
This gives a total of 7.68 s, allow 8s in the test case.

The normative reference for this requirement is TS 25.123 [2] clauses 5.5 and A.5.5.1.

#### 8.3.5.1.2.2 1,28 Mcps TDD option

The cell re-selection delay shall be less than 8 s.

NOTE:

The cell re-selection delay can be expressed as:  $T_{\text{evaluateNTDD}} + T_{SI}$ , where:

$T_{\text{evaluateNTDD}}$  A DRX cycle length of 1280ms is assumed for this test case, this leads to a  $T_{\text{evaluateTDD}}$  of 6.4s according to TS 25.123 [2] table 4.1a in clause 4.2.2.

$T_{SI}$  Time required for receiving all the relevant system information data according to the reception procedure and the RRC procedure delay of system information blocks defined in 25.331 for a UTRAN cell (ms). 1280 ms is assumed in this test case.

This gives a total of 7.68 s, allowing 8s in the test case.

The normative reference for this requirement is TS 25.123 [2] clauses 5.5.2.2 and A.5.5.1.

#### 8.3.5.1.2.3 7,68 Mcps TDD option

The cell re-selection delay shall be less than 8 s.

NOTE:

The cell re-selection delay can be expressed as:  $T_{\text{evaluateTDD}} + T_{SI}$ , where:

$T_{\text{evaluateTDD}}$  A DRX cycle length of 1280ms is assumed for this test case, this leads to a  $T_{\text{evaluateTDD}}$  of 6.4s according to TS 25.123 [2] table 4.1B in clause 4.2.2.7.3.

$T_{SI}$  Maximum repetition period of relevant system info blocks that needs to be received by the UE to camp on a cell. 1280 ms is assumed in this test case.

This gives a total of 7.68 s, allow 8s in the test case.

The normative reference for this requirement is TS 25.123 [2] clauses 5.5.2.3 and A.5.5.1.

#### 8.3.5.1.3 Test purpose

This test verifies that the UE meets the minimum requirement for the cell re-selection delay in CELL\_PCH for the single carrier case

#### 8.3.5.1.4 Method of test

##### 8.3.5.1.4.1 3,84 Mcps TDD option

##### 8.3.5.1.4.1.1 Initial conditions

This scenario contains 6 cells operating on the same carrier frequency. The test parameters are given in Tables 8.3.5.1.1.1, and 8.3.5.1.1.2.

**Table 8.3.5.1.1.1: General test parameters for Cell Re-selection single carrier multi-cell case**

Parameter		Unit	Value	Comment
Initial condition	Active cell		Cell1	
	Neighbour cells		Cell2, Cell3, Cell4, Cell5, Cell6	
Final condition	Active cell		Cell2	
HCS			Not used	
UE_TXPWR_MAX_RACH		dBm	21	The value shall be used for all cells in the test.
Qrxlevmin		dBm	-102	The value shall be used for all cells in the test.
Access Service Class (ASC#0) - Persistence value			1	Selected so that no additional delay is caused by the random access procedure. The value shall be used for all cells in the test.
T <sub>SI</sub>		s	1,28	The value shall be used for all cells in the test.
DRX cycle length		s	1,28	The value shall be used for all cells in the test.
T1		s	15	
T2		s	15	

Table 8.3.5.1.1.2: Cell re-selection single carrier multi-cell case

Parameter	Unit	Cell 1				Cell 2				Cell 3			
		0		8		0		8		0		8	
Timeslot Number		T1	T2	T1	T2	T1	T2	T1	T2	T1	T2	T1	T2
UTRA RF Channel Number		Channel 1				Channel 1				Channel 1			
PCCPCH_Ec/lor	dB	-3	-3			-3	-3			-3	-3		
SCH_Ec/lor	dB	-9	-9	-9	-9	-9	-9	-9	-9	-9	-9	-9	-9
SCH_toffset		0	0	0	0	5	5	5	5	10	10	10	10
PICH_Ec/lor	dB			-3	-3			-3	-3			-3	-3
OCNS_Ec/lor	dB	-4,28	-4,28	-4,28	-4,28	-4,28	-4,28	-4,28	-4,28	-4,28	-4,28	-4,28	-4,28
$\hat{I}_{or}/I_{oc}$	dB	9	7	9	7	7	9	7	9	-1	-1	-1	-1
PCCPCH RSCP	dBm	-64	-66			-66	-64			-74	-74		
Qoffset <sub>1s,n</sub>	dB	C1, C2: 0; C1, C3:0; C1,C4:0 C1, C5:0; C1, C6:0				C2, C1: 0; C2, C3:0; C2,C4:0 C2, C5: 0; C2, C6:0				C3, C1: 0; C3, C2:0; C3,C4:0 C3, C5: 0; C3, C6:0			
Qhyst <sub>1s</sub>	dB	0				0				0			
Treselection	s	0				0				0			
Sintrasearch	dB	not sent				not sent				not sent			
Timeslot		Cell 4				Cell 5				Cell 6			
		0		8		0		8		0		8	
UTRA RF Channel Number		Channel 1				Channel 1				Channel 1			
PCCPCH_Ec/lor	dB	-3	-3			-3	-3			-3	-3		
SCH_Ec/lor	dB	-9	-9	-9	-9	-9	-9	-9	-9	-9	-9	-9	-9
SCH_toffset		15	15	15	15	20	20	20	20	25	25	25	25
PICH_Ec/lor	dB			-3	-3			-3	-3			-3	-3
OCNS_Ec/lor	dB	-4,28	-4,28	-4,28	-4,28	-4,28	-4,28	-4,28	-4,28	-4,28	-4,28	-4,28	-4,28
$\hat{I}_{or}/I_{oc}$	dB	-1	-1	-1	-1	-1	-1	-1	-1	-1	-1	-1	-1
PCCPCH RSCP	dBm	-74	-74			-74	-74			-74	-74		
Qoffset <sub>1s,n</sub>	dB	C4, C1: 0; C4, C2:0; C4,C3:0C4, C5:0; C4, C6:0				C5, C1: 0; C5, C2:0; C5,C3:0 C5, C4:0; C5, C6:0				C6, C1: 0; C6, C2:0; C6,C3:0 C6, C4:0; C6, C5:0			
Qhyst <sub>1s</sub>	dB	0				0				0			
Treselection	s	0				0				0			
Sintrasearch	dB	not sent				not sent				not sent			
$I_{oc}$	dBm/3,8 4 MHz	-70											
Propagation Condition		AWGN											



## 8.3.5.1.4.1.2 Procedure

- a) The SS activates cell 1-6 with T1 defined parameters.
- b) The UE is switched on.
- c) A call is set up according to the test procedure specified in TS 34.108 [3] subclause 7.4.2.7.1 to place the UE in the CELL\_PCH state on Cell 1 and then the SS waits for this process to complete.
- d) After 15 s from the completion of step c) or the beginning of T1, the parameters are changed as described for T2.
- e) If the UE responds on Cell 2 with a PRACH (CELL UPDATE message cause "cell reselection") within 8s, then a success is recorded, the SS shall transmit a CELL UPDATE CONFIRM message and then the procedure moves to step g).
- f) Since the UE has failed to respond with the correct message within the allowed time, a failure is recorded. The SS shall then wait for a total of 15s from the beginning of T2 and if no response is received, the UE shall be switched off and the procedure returns to step a). Otherwise the SS shall transmit a CELL UPDATE CONFIRM message and then the procedure continues with step g).
- g) After a total of 15 s from the beginning of T2, the parameters are changed as described for T1.
- h) If the UE responds on Cell 1 with a PRACH (CELL UPDATE message cause "cell reselection") within 8s, then a success is recorded and the procedure moves to step j).
- i) Since the UE has failed to respond with the correct message within the allowed time, a failure is recorded. The SS shall then wait for a total of 15s from the beginning of T1 and if no response is received the UE shall be switched off and the procedure returns to step a). Otherwise the SS shall transmit a CELL UPDATE CONFIRM message and then the procedure continues with step j).
- j) Repeat steps d) to i) [TBD] times.

NOTE: The time required for receiving all the relevant system information data according to the reception procedure and the RRC procedure delay of system information blocks defined in 25.331 for a UTRAN cell. Since the maximum repetition period of the relevant system info blocks that needs to be received by the UE to camp on a cell is 1280ms and the maximum RRC procedure delay for reception system information block is 100ms, 1380 ms is assumed in this test case. Therefore this gives a total of 7.78s (Minimum requirement + 100ms), allow 8s in the test case.

## Specific Message Contents

All messages indicated above shall use the same content as described in the default message content in clause 9 of 34.108 [3], with the following exceptions:

## RADIO BEARER SETUP (Step 3)

Information Element	Value/remark
RRC State Indicator	CELL_PCH
UTRAN DRX cycle length coefficient	7

8.3.5.1.4.2 1,28 Mcps TDD option

8.3.5.1.4.2.1 Initial conditions

This scenario contains 6 cells operating on the same carrier frequency. The test parameters are given in Tables 8.3.5.1.4.2.1 and 8.3.5.1.4.2.2.

**Table 8.3.5.1.4.2.1: General test parameters for 1,28 Mcps Cell Re-selection single carrier multi-cell case**

Parameter		Unit	Value	Comment
Initial condition	Active cell		Cell1	
	Neighbour cells		Cell2, Cell3, Cell4, Cell5, Cell6	
Final condition	Active cell		Cell2	
HCS			Not used	
UE_TXPWR_MAX_RACH		dBm	21	The value shall be used for all cells in the test.
Qrxlevmin		dBm	-103	The value shall be used for all cells in the test.
Access Service Class (ASC#0) -- Persistence value			1	Selected so that no additional delay is caused by the random access procedure. The value shall be used for all cells in the test.
T <sub>SI</sub>		s	1,28	The value shall be used for all cells in the test.
DRX cycle length		s	1,28	The value shall be used for all cells in the test.
T1		s	15	
T2		s	15	

Table 8.3.5.1.4.2.2: 1,28Mcps Cell re-selection single carrier multi-cell case

Parameter	Unit	Cell 1				Cell 2				Cell 3			
		0		DWPTS		0		DWPTS		0		DWPTS	
Timeslot Number		T1	T2	T1	T2	T1	T2	T1	T2	T1	T2	T1	T2
UTRA RF Channel Number		Channel 1				Channel 1				Channel 1			
PCCPCH_Ec/lor	dB	-3	-3			-3	-3			-3	-3		
DwPCH_Ec/lor	dB			0	0			0	0			0	0
OCNS_Ec/lor	dB	-3	-3			-3	-3			-3	-3		
$\hat{I}_{or}/I_{oc}$	dB	10	7	10	7	7	10	7	10	-1	-1	-1	-1
PCCPCH RSCP	dBm	-63	-66			-66	-63			-74	-74		
Qoffset <sub>1s,n</sub>	dB	C1, C2: 0; C1, C3:0; C1,C4:0 C1, C5:0; C1,C6:0				C2, C1: 0; C2, C3:0; C2,C4:0 C2, C5: 0; C2, C6:0				C3, C1: 0; C3, C2:0; C3,C4:0 C3, C5: 0; C3, C6:0			
Qhyst <sub>1s</sub>	dB	0				0				0			
Treselection	s	0				0				0			
Sintrasearch	dB	not sent				not sent				not sent			
Timeslot		Cell 4				Cell 5				Cell 6			
		0		DWPTS		0		DWPTS		0		DWPTS	
UTRA RF Channel Number		Channel 1				Channel 1				Channel 1			
PCCPCH_Ec/lor	dB	-3	-3			-3	-3			-3	-3		
DwPCH_Ec/lor	dB			0	0			0	0			0	0
OCNS_Ec/lor	dB	-3	-3			-3	-3			-3	-3		
$\hat{I}_{or}/I_{oc}$	dB	-1	-1	-1	-1	-1	-1	-1	-1	-1	-1	-1	-1
PCCPCH RSCP	dBm	-74	-74			-74	-74			-74	-74		
Qoffset <sub>1s,n</sub>	dB	C4, C1: 0; C4, C2:0; C4,C3:0 C4, C5:0; C4, C6:0				C5, C1: 0; C5, C2:0; C5,C3:0 C5, C4:0; C5, C6:0				C6, C1: 0; C6, C2:0; C6,C3:0 C6, C4:0; C6, C5:0			
Qhyst <sub>1s</sub>	dB	0				0				0			
Treselection	s	0				0				0			
Sintrasearch	dB	not sent				not sent				not sent			
$I_{oc}$	dBm/1,2 8 MHz	-70											
Propagation Condition		AWGN											

## 8.3.5.1.4.2.2 Procedure

- a) The SS activates cell 1-6 with T1 defined parameters.
- b) The UE is switched on.
- c) A call is set up according to the test procedure specified in TS 34.108 [3] subclause 7.4.2.7.1 to place the UE in the CELL\_PCH state on Cell 1 and then the SS waits for this process to complete.
- d) After 15 s from the completion of step c) or the beginning of T1, the parameters are changed as described for T2.
- e) If the UE responds on Cell 2 with a SYNCH-UL sequence in the UpPTS for sending CELL UPDATE message cause "cell reselection" within 8s, then a success is recorded. After receiving the CELL UPDATE message cause "cell reselection", the SS shall transmit a CELL UPDATE CONFIRM message and then the procedure moves to step g).
- f) If the UE has failed to respond with a SYNCH-UL sequence in the UpPTS within the allowed time, a failure is recorded. The SS shall then wait for a total of 15s from the beginning of T2 and if no response is received, the UE shall be switched off and the procedure returns to step a). Otherwise after receiving the CELL UPDATE message cause "cell reselection", the SS shall transmit a CELL UPDATE CONFIRM message and then the procedure continues with step g).
- g) After a total of 15 s from the beginning of T2, the parameters are changed as described for T1.
- h) If the UE responds on Cell 1 with a SYNCH-UL sequence in the UpPTS for sending CELL UPDATE message cause "cell reselection" within 8s, then a success is recorded and the procedure moves to step j).
- i) If the UE has failed to respond with SYNCH-UL sequence in the UpPTS within the allowed time, a failure is recorded. The SS shall then wait for a total of 15s from the beginning of T1 and if no response is received the UE shall be switched off and the procedure returns to step a). Otherwise after receiving the CELL UPDATE message cause "cell reselection", the SS shall transmit a CELL UPDATE CONFIRM message and then the procedure continues with step j).
- j) After another 15 s, the UE shall be switched off.
- k) Repeat steps a) to j) until the confidence level according to annex F.6.2 is achieved

NOTE: The time required for receiving all the relevant system information data according to the reception procedure and the RRC procedure delay of system information blocks defined in 25.331 for a UTRAN cell. Since the maximum repetition period of the relevant system info blocks that needs to be received by the UE to camp on a cell is 1280ms and the maximum RRC procedure delay for reception system information block is 100ms, 1380 ms is assumed in this test case. Therefore this gives a total of 7.78s (Minimum requirement + 100ms), so allow 8s in the test case.

## Specific Message Contents

All messages indicated above shall use the same content as described in the default message content in clause 9 of 34.108 [3], with the following exceptions:

## RADIO BEARER SETUP (Step 3)

Information Element	Value/remark
RRC State Indicator	CELL_PCH
UTRAN DRX cycle length coefficient	7

## 8.3.5.1.4.3 7,68 Mcps TDD option

## 8.3.5.1.4.3.1 Initial conditions

This scenario contains 6 cells operating on the same carrier frequency. The test parameters are given in Tables 8.3.5.1.4.3.1, and 8.3.5.1.4.3.2.

**Table 8.3.5.1.4.3.1: General test parameters for Cell Re-selection single carrier multi-cell case**

Parameter		Unit	Value	Comment
Initial condition	Active cell		Cell1	
	Neighbour cells		Cell2, Cell3, Cell4, Cell5, Cell6	
Final condition	Active cell		Cell2	
HCS			Not used	
UE_TXPWR_MAX_RACH		dBm	21	The value shall be used for all cells in the test.
Qrxlevmin		dBm	-102	The value shall be used for all cells in the test.
Access Service Class (ASC#0) - Persistence value			1	Selected so that no additional delay is caused by the random access procedure. The value shall be used for all cells in the test.
T <sub>SI</sub>		s	1.28	The value shall be used for all cells in the test.
DRX cycle length		s	1.28	The value shall be used for all cells in the test.
T1		s	15	
T2		s	15	

Table 8.3.5.1.4.3.2: Cell re-selection single carrier multi-cell case

Parameter	Unit	Cell 1				Cell 2				Cell 3			
Timeslot Number		0		8		0		8		0		8	
		T1	T2	T1	T2	T1	T2	T1	T2	T1	T2	T1	T2
UTRA RF Channel Number		Channel 1				Channel 1				Channel 1			
PCCPCH_Ec/lor	dB	-3	-3			-3	-3			-3	-3		
SCH_Ec/lor	dB	-9	-9	-9	-9	-9	-9	-9	-9	-9	-9	-9	-9
SCH_toffset		0	0	0	0	5	5	5	5	10	10	10	10
PICH_Ec/lor	dB			-3	-3			-3	-3			-3	-3
OCNS_Ec/lor	dB	-3,12	-3,12	-3,12	-3,12	-3,12	-3,12	-3,12	-3,12	-3,12	-3,12	-3,12	-3,12
$\hat{I}_{or}/I_{oc}$	dB	9	7	9	7	7	9	7	9	-1	-1	-1	-1
PCCPCH RSCP	dBm	-64	-66			-66	-64			-74	-74		
Qoffset <sub>1s,n</sub>	dB	C1, C2: 0; C1, C3:0; C1,C4:0 C1, C5:0; C1,C6:0				C2, C1: 0; C2, C3:0; C2,C4:0 C2, C5: 0; C2, C6:0				C3, C1: 0; C3, C2:0; C3,C4:0 C3, C5: 0; C3, C6:0			
Qhyst <sub>1s</sub>	dB	0				0				0			
Treselection	s	0				0				0			
Sintrasearch	dB	not sent				not sent				not sent			
		Cell 4				Cell 5				Cell 6			
Timeslot		0		8		0		8		0		8	
		T1	T2	T1	T2	T1	T2	T1	T2	T1	T2	T1	T2
UTRA RF Channel Number		Channel 1				Channel 1				Channel 1			
PCCPCH_Ec/lor	dB	-3	-3			-3	-3			-3	-3		
SCH_Ec/lor	dB	-9	-9	-9	-9	-9	-9	-9	-9	-9	-9	-9	-9
SCH_toffset		15	15	15	15	20	20	20	20	25	25	25	25
PICH_Ec/lor	dB			-3	-3			-3	-3			-3	-3
OCNS_Ec/lor	dB	-3,12	-3,12	-3,12	-3,12	-3,12	-3,12	-3,12	-3,12	-3,12	-3,12	-3,12	-3,12
$\hat{I}_{or}/I_{oc}$	dB	-1	-1	-1	-1	-1	-1	-1	-1	-1	-1	-1	-1
PCCPCH RSCP	dBm	-74	-74			-74	-74			-74	-74		
Qoffset <sub>1s,n</sub>	dB	C4, C1: 0; C4, C2:0; C4,C3:0 C4, C5:0; C4, C6:0				C5, C1: 0; C5, C2:0; C5,C3:0 C5, C4:0; C5, C6:0				C6, C1: 0; C6, C2:0; C6,C3:0 C6, C4:0; C6, C5:0			
Qhyst <sub>1s</sub>	dB	0				0				0			
Treselection	s	0				0				0			
Sintrasearch	dB	not sent				not sent				not sent			
$I_{oc}$	dBm/7,6 8 MHz	-70											
Propagation Condition		AWGN											

## 8.3.5.1.4.3.2 Procedure

- a) The SS activates cell 1-6 with T1 defined parameters.
- b) The UE is switched on.
- c) A call is set up according to the test procedure specified in TS 34.108 [3] subclause 7.4.2.7.1 to place the UE in the CELL\_PCH state on Cell 1 and then the SS waits for this process to complete.
- d) After 15 s from the completion of step c) or the beginning of T1, the parameters are changed as described for T2.
- e) If the UE responds on Cell 2 with a PRACH (CELL UPDATE message cause "cell reselection") within 8s, then a success is recorded, the SS shall transmit a CELL UPDATE CONFIRM message and then the procedure moves to step g).
- f) Since the UE has failed to respond with the correct message within the allowed time, a failure is recorded. The SS shall then wait for a total of 15s from the beginning of T2 and if no response is received, the UE shall be switched off and the procedure returns to step a). Otherwise the SS shall transmit a CELL UPDATE CONFIRM message and then the procedure continues with step g).
- g) After a total of 15 s from the beginning of T2, the parameters are changed as described for T1.
- h) If the UE responds on Cell 1 with a PRACH (CELL UPDATE message cause "cell reselection") within 8s, then a success is recorded and the procedure moves to step j).
- i) Since the UE has failed to respond with the correct message within the allowed time, a failure is recorded. The SS shall then wait for a total of 15s from the beginning of T1 and if no response is received the UE shall be switched off and the procedure returns to step a). Otherwise the SS shall transmit a CELL UPDATE CONFIRM message and then the procedure continues with step j).
- j) Repeat steps d) to i) until the confidence level according to annex F.6.2 is achieved..

NOTE: The time required for receiving all the relevant system information data according to the reception procedure and the RRC procedure delay of system information blocks defined in 25.331 for a UTRAN cell. Since the maximum repetition period of the relevant system info blocks that needs to be received by the UE to camp on a cell is 1280ms and the maximum RRC procedure delay for reception system information block is 100ms, 1380 ms is assumed in this test case. Therefore this gives a total of 7.78s (Minimum requirement + 100ms), allow 8s in the test case.

## Specific Message Contents

All messages indicated above shall use the same content as described in the default message content in clause 9 of 34.108 [3], with the following exceptions:

## RADIO BEARER SETUP (Step 3)

Information Element	Value/remark
RRC State Indicator	CELL_PCH
UTRAN DRX cycle length coefficient	7

## 8.3.5.1.5 Test Requirements

## 8.3.5.1.5.1 3,84 Mcps TDD option

For the test to pass, the total number of successful attempts shall be more than 90% with a confidence level of [FFS]% of the cases.

NOTE: If the above Test Requirement differs from the Minimum Requirement then the Test Tolerance applied for this test is non-zero. The Test Tolerance for this test is defined in clause F.2 and the explanation of how the Minimum Requirement has been relaxed by the Test Tolerance is given in clause F.4.

## 8.3.5.1.5.2 1,28 Mcps TDD option

For the test to pass, the total number of successful attempts shall be more than 90% with a confidence level of 95% of the cases.

NOTE: If the above Test Requirement differs from the Minimum Requirement then the Test Tolerance applied for this test is non-zero. The Test Tolerance for this test is defined in clause F.2 and the explanation of how the Minimum Requirement has been relaxed by the Test Tolerance is given in clause F.4.

#### 8.3.5.1.5.3 7,68 Mcps TDD option

For the test to pass, the total number of successful attempts shall be more than 90% with a confidence level of 95% of the cases.

NOTE: If the above Test Requirement differs from the Minimum Requirement then the Test Tolerance applied for this test is non-zero. The Test Tolerance for this test is defined in clause F.2 and the explanation of how the Minimum Requirement has been relaxed by the Test Tolerance is given in clause F.4.

### 8.3.5.2 Scenario 2: TDD/TDD cell re-selection multi carrier case

#### 8.3.5.2.1 Definition and applicability

##### 8.3.5.2.1.1 3,84 Mcps TDD option

The cell re-selection delay is defined as the time from a change of cell levels to the moment when this change causes the UE to camp on a new cell, and starts to send the CELL UPDATE message with cause value "cell reselection" in the new cell.

The requirements and this test apply to the 3,84 Mcps option TDD UE.

##### 8.3.5.2.1.2 1,28 Mcps TDD option

The cell re-selection delay is defined as the time from a change of cell levels to the moment when this change causes the UE to camp on a new cell, and starts to send SYNCH-UL sequence in the UpPTS for sending the CELL UPDATE with cause value "cell reselection".

The requirements and this test apply to the 1,28 Mcps TDD UE.

##### 8.3.5.2.1.3 7,68 Mcps TDD option

The cell re-selection delay is defined as the time from a change of cell levels to the moment when this change causes the UE to camp on a new cell, and starts to send the CELL UPDATE message with cause value "cell reselection" in the new cell.

The requirements and this test apply to the 7,68 Mcps TDD UE.

#### 8.3.5.2.2 Minimum requirement

##### 8.3.5.2.2.1 3,84 Mcps TDD option

The cell re-selection delay shall be less than 8 s.

NOTE:

The cell re-selection delay can be expressed as:  $T_{\text{evaluateTDD}} + T_{\text{SI}}$ , where:

$T_{\text{evaluateTDD}}$  A DRX cycle length of 1280ms is assumed for this test case, this leads to a  $T_{\text{evaluateTDD}}$  of 6.4s according to TS 25.123 [2] table 4.1 in clause 4.2.2.7.

$T_{\text{SI}}$  Maximum repetition period of relevant system info blocks that needs to be received by the UE to camp on a cell. 1280 ms is assumed in this test case.

This gives a total of 7.68 s, allow 8s in the test case.

The normative reference for this requirement is TS 25.123 [2] clauses 5.5 and A.5.5.2.

##### 8.3.5.2.2.2 1,28 Mcps TDD option

The cell re-selection delay shall be less than 8 s.

NOTE:

The cell re-selection delay can be expressed as:  $T_{\text{evaluateNTDD}} + T_{\text{SI}}$ , where:



- $T_{\text{evaluateNTDD}}$  A DRX cycle length of 1280ms is assumed for this test case, this leads to a  $T_{\text{evaluate TDD}}$  of 6.4s according to TS 25.123 [2] table 4.1a in clause 4.2.2.
- $T_{\text{SI}}$  Time required for receiving all the relevant system information data according to the reception procedure and the RRC procedure delay of system information blocks defined in 25.331 for a UTRAN cell (ms). 1280 ms is assumed in this test case.
- This gives a total of 7.68 s, allowing 8s in the test case.

The normative reference for this requirement is TS 25.123 [2] clauses 5.5.2 and A.5.5.2.2.

#### 8.3.5.2.2.3 7,68 Mcps TDD option

The cell re-selection delay shall be less than 8 s.

NOTE:

The cell re-selection delay can be expressed as:  $T_{\text{evaluateTDD}} + T_{\text{SI}}$ , where:

- $T_{\text{evaluateTDD}}$  A DRX cycle length of 1280ms is assumed for this test case, this leads to a  $T_{\text{evaluate TDD}}$  of 6.4s according to TS 25.123 [2] table 4.1B in clause 4.2.2.7.3.
- $T_{\text{SI}}$  Maximum repetition period of relevant system info blocks that needs to be received by the UE to camp on a cell. 1280 ms is assumed in this test case.
- This gives a total of 7.68 s, allow 8s in the test case.

The normative reference for this requirement is TS 25.123 [2] clauses 5.5.2 and A.5.5.2.

#### 8.3.5.2.3 Test purpose

This test verifies that the UE meets the requirement for the cell re-selection delay in CELL\_PCH for the multi carrier case.

#### 8.3.5.2.4 Method of test

##### 8.3.5.2.4.1 3,84 Mcps TDD option

##### 8.3.5.2.4.1.1 Initial conditions

This scenario contains 6 cells and 2 carrier frequencies. The test parameters are given in Tables 8.3.5.2.1.1 and 8.3.5.2.1.2.

**Table 8.3.5.2.1.1: General test parameters for Cell Re-selection in Multi carrier case**

Parameter	Unit	Value	Comment
Initial condition	Active cell	Cell1	
	Neighbour cells	Cell2, Cell3, Cell4, Cell5, Cell6	
Final condition	Active cell	Cell2	
HCS		Not used	
UE_TXPWR_MAX_RACH	dBm	21	The value shall be used for all cells in the test.
Qrxlevmin	dBm	-102	The value shall be used for all cells in the test.
Access Service Class (ASC#0) - Persistence value		1	Selected so that no additional delay is caused by the random access procedure. The value shall be used for all cells in the test.
$T_{\text{SI}}$	s	1,28	The value shall be used for all cells in the test.
DRX cycle length	s	1,28	The value shall be used for all cells in the test.
T1	s	30	
T2	s	15	

Table 8.3.5.2.1.2: Cell re-selection multi carrier multi cell case

Parameter	Unit	Cell 1				Cell 2				Cell 3			
		0		8		0		8		0		8	
Timeslot Number		T1	T2	T1	T2	T1	T2	T1	T2	T1	T2	T1	T2
UTRA RF Channel Number		Channel 1				Channel 2				Channel 1			
PCCPCH_Ec/lor	dB	-3	-3			-3	-3			-3	-3		
SCH_Ec/lor	dB	-9	-9	-9	-9	-9	-9	-9	-9	-9	-9	-9	-9
SCH_offset		0	0	0	0	5	5	5	5	10	10	10	10
PICH_Ec/lor	dB			-3	-3			-3	-3			-3	-3
OCNS_Ec/lor	dB	-4,28	-4,28	-4,28	-4,28	-4,28	-4,28	-4,28	-4,28	-4,28	-4,28	-4,28	-4,28
$\hat{I}_{or}/I_{oc}$	dB	6	0	6	0	0	6	0	6	-3	-3	-3	-3
PCCPCH RSCP	dBm	-67	-73			-73	-67			-76	-76		
Qoffset <sub>1s,n</sub>	dB	C1, C2: 0; C1, C3:0; C1,C4:0C1, C5:0; C1, C6:0				C2, C1: 0; C2, C3:0; C2,C4:0C2, C5:0; C2, C6:0				C3, C1: 0; C3, C2:0; C3,C4:0 C3, C5:0; C3, C6:0			
Qhyst <sub>1s</sub>	dB	0				0				0			
Treselection	s	0				0				0			
Sintrasearch	dB	not sent				not sent				not sent			
Sintersearch	dB	not sent				not sent				not sent			
		Cell 4				Cell 5				Cell 6			
Timeslot		0		8		0		8		0		8	
UTRA RF Channel Number		Channel 1				Channel 2				Channel 2			
PCCPCH_Ec/lor	dB	-3	-3			-3	-3			-3	-3		
SCH_Ec/lor	dB	-9	-9	-9	-9	-9	-9	-9	-9	-9	-9	-9	-9
SCH_offset		15	15	15	15	20	20	20	20	25	25	25	25
PICH_Ec/lor	dB			-3	-3			-3	-3			-3	-3
OCNS_Ec/lor	dB	-4,28	-4,28	-4,28	-4,28	-4,28	-4,28	-4,28	-4,28	-4,28	-4,28	-4,28	-4,28
$\hat{I}_{or}/I_{oc}$	dB	-3	-3	-3	-3	-3	-3	-3	-3	-3	-3	-3	-3
PCCPCH RSCP	dBm	-76	-76			-76	-76			-76	-76		
Qoffset <sub>1s,n</sub>	dB	C4, C1: 0; C4, C2:0; C4,C3:0 C4, C5:0; C4, C6:0				C5, C1: 0; C5, C2:0; C5,C3:0 C5, C4:0; C5, C6:0				C6, C1: 0; C6, C2:0; C6,C3:0 C6, C4:0; C6, C5:0			
Qhyst <sub>1s</sub>	dB	0				0				0			
Treselection	s	0				0				0			
Sintrasearch	dB	not sent				not sent				not sent			
Sintersearch	dB	not sent				not sent				not sent			
$I_{oc}$	dBm/3,8 4 MHz	-70											
Propagation Condition		AWGN											

## 8.3.5.2.4.1.2 Procedure

- a) The SS activates cell 1-6 with T1 defined parameters.
- b) The UE is switched on.
- c) A call is set up according to the test procedure specified in TS 34.108 [3] subclause 7.4.2.7.1 to place the UE in the CELL\_PCH state on Cell 1 and then the SS waits for this process to complete.
- d) After 15 s from the completion of step c) or the beginning of T1, the parameters are changed as described for T2.
- e) If the UE responds on Cell 2 with a PRACH (CELL UPDATE message cause "cell reselection") within 8s, then a success is recorded, the SS shall transmit a CELL UPDATE CONFIRM message and then the procedure moves to step g).
- f) Since the UE has failed to respond with the correct message within the allowed time, a failure is recorded. The SS shall then wait for a total of 15s from the beginning of T2 and if no response is received, the UE shall be switched off and the procedure returns to step a). Otherwise the SS shall transmit a CELL UPDATE CONFIRM message and then the procedure continues with step g).
- g) After a total of 15 s from the beginning of T2, the parameters are changed as described for T1.
- h) If the UE responds on Cell 1 with a PRACH (CELL UPDATE message cause "cell reselection") within 8s, then a success is recorded and the procedure moves to step j).
- i) Since the UE has failed to respond with the correct message within the allowed time, a failure is recorded. The SS shall then wait for a total of 15s from the beginning of T1 and if no response is received the UE shall be switched off and the procedure returns to step a). Otherwise the SS shall transmit a CELL UPDATE CONFIRM message and then the procedure continues with step j).
- j) Repeat steps d) to i) [TBD] times.

NOTE 1: T1 is initially 30 s to allow enough time for the UE to search for cells as it has no prior knowledge of these.

NOTE 2: The time required for receiving all the relevant system information data according to the reception procedure and the RRC procedure delay of system information blocks defined in 25.331 for a UTRAN cell. Since the maximum repetition period of the relevant system info blocks that needs to be received by the UE to camp on a cell is 1280ms and the maximum RRC procedure delay for reception system information block is 100ms, 1380 ms is assumed in this test case. Therefore this gives a total of 7.78s (Minimum requirement + 100ms), allow 8s in the test case.

## RADIO BEARER SETUP (Step 3)

Information Element	Value/remark
RRC State Indicator	CELL_PCH
UTRAN DRX cycle length coefficient	7

## 8.3.5.2.4.2 1,28 Mcps TDD option

## 8.3.5.2.4.2.1 Initial conditions

This scenario contains 6 cells and 2 carrier frequencies. The test parameters are given in Tables 8.3.5.2.4.2.1 and 8.3.5.2.4.2.2.

**Table 8.3.5.2.4.2.1: General test parameters for 1,28Mcps Cell Re-selection in Multi carrier case**

Parameter		Unit	Value	Comment
Initial condition	Active cell		Cell1	
	Neighbour cells		Cell2, Cell3, Cell4, Cell5, Cell6	
Final condition	Active cell		Cell2	
HCS			Not used	
UE_TXPWR_MAX_RACH		dBm	21	The value shall be used for all cells in the test.
Qrxlevmin		dBm	-103	The value shall be used for all cells in the test.
Access Service Class (ASC#0) - Persistence value			1	Selected so that no additional delay is caused by the random access procedure. The value shall be used for all cells in the test.
T <sub>SI</sub>		s	1,28	The value shall be used for all cells in the test.
DRX cycle length		s	1,28	The value shall be used for all cells in the test.
T1		s	30	
T2		s	15	

Table 8.3.5.2.4.2.2: Cell re-selection 1,28 Mcps multi carrier multi cell case

Parameter	Unit	Cell 1				Cell 2				Cell 3			
		0		DWPTS		0		DWPTS		0		DWPTS	
Timeslot Number		T1	T2	T1	T2	T1	T2	T1	T2	T1	T2	T1	T2
UTRA RF Channel Number		Channel 1				Channel 2				Channel 1			
PCCPCH_Ec/I <sub>or</sub>	dB	-3	-3			-3	-3			-3	-3		
DwPCH_Ec/I <sub>or</sub>	dB			0	0			0	0			0	0
OCNS_Ec/I <sub>or</sub>	dB	-3	-3			-3	-3			-3	-3		
$\hat{I}_{or}/I_{oc}$	dB	10	4	10	4	4	10	4	10	-1	-1	-1	-1
PCCPCH RSCP	dBm	-63	-69			-69	-63			-74	-74		
Qoffset1 <sub>s,n</sub>	dB	C1, C2: 0; C1, C3:0; C1,C4:0 C1, C5:0; C1, C6:0				C2, C1: 0; C2, C3:0; C2,C4:0C2, C5:0; C2, C6:0				C3, C1: 0; C3, C2:0; C3,C4:0 C3, C5:0; C3, C6:0			
Qhyst1 <sub>s</sub>	dB	0				0				0			
Treselection	s	0				0				0			
Sintrasearch	dB	not sent				not sent				not sent			
Sintersearch	dB	not sent				not sent				not sent			
		Cell 4				Cell 5				Cell 6			
Timeslot		0		DWPTS		0		DWPTS		0		DWPTS	
		T1	T2	T1	T2	T1	T2	T1	T2	T1	T2	T1	T2
UTRA RF Channel Number		Channel 1				Channel 2				Channel 1			
PCCPCH_Ec/I <sub>or</sub>	dB	-3	-3			-3	-3			-3	-3		
DwPCH_Ec/I <sub>or</sub>	dB			0	0			0	0			0	0
OCNS_Ec/I <sub>or</sub>	dB	-3	-3			-3	-3			-3	-3		
$\hat{I}_{or}/I_{oc}$	dB	-1	-1	-1	-1	-1	-1	-1	-1	-1	-1	-1	-1
PCCPCH RSCP	dBm	-74	-74			-74	-74			-74	-74		
Qoffset1 <sub>s,n</sub>	dB	C4, C1: 0; C4, C2:0; C4,C3:0 C4, C5:0; C4, C6:0				C5, C1: 0; C5, C2:0; C5,C3:0 C5, C4:0; C5, C6:0				C6, C1: 0; C6, C2:0; C6,C3:0 C6, C4:0; C6, C5:0			
Qhyst1 <sub>s</sub>	dB	0				0				0			
Treselection	s	0				0				0			
Sintrasearch	dB	not sent				not sent				not sent			
Sintersearch	dB	not sent				not sent				not sent			
$I_{oc}$	dBm/ 1,28 MHz	-70											
Propagation Condition		AWGN											

## 8.3.5.2.4.2.2 Procedure

- The SS activates cell 1-6 with T1 defined parameters.
- The UE is switched on.
- A call is set up according to the test procedure specified in TS 34.108 [3] subclause 7.4.2.7.1 to place the UE in the CELL\_PCH state on Cell 1 and then the SS waits for this process to complete.
- After 15 s from the completion of step c) or the beginning of T1, the parameters are changed as described for T2.
- If the UE responds on Cell 2 with a SYNCH-UL sequence in the UpPTS for sending CELL UPDATE message cause "cell reselection" within 8s, then a success is recorded. After receiving the CELL UPDATE message cause "cell reselection", the SS shall transmit a CELL UPDATE CONFIRM message and then the procedure moves to step g).
- If the UE has failed to respond with SYNCH-UL sequence in the UpPTS within the allowed time, a failure is recorded. The SS shall then wait for a total of 15s from the beginning of T2 and if no response is received, the UE shall be switched off and the procedure returns to step a). Otherwise after receiving the CELL UPDATE message cause "cell reselection", the SS shall transmit a CELL UPDATE CONFIRM message and then the procedure continues with step g).

- g) After a total of 15 s from the beginning of T2, the parameters are changed as described for T1.
- h) If the UE responds on Cell 1 with a SYNCH-UL sequence in the UpPTS for sending CELL UPDATE message cause "cell reselection" within 8s, then a success is recorded and the procedure moves to step j).
- i) If the UE has failed to respond with SYNCH-UL sequence in the UpPTS within the allowed time, a failure is recorded. The SS shall then wait for a total of 15s from the beginning of T1 and if no response is received the UE shall be switched off and the procedure returns to step a). Otherwise after receiving the CELL UPDATE message cause "cell reselection", the SS shall transmit a CELL UPDATE CONFIRM message and then the procedure continues with step j).
- j) After another 15 s, the UE shall be switched off.
- k) Repeat steps a) to j) until the confidence level according to annex F.6.2 is achieved

NOTE 1: T1 should initially be 30 s to allow enough time for the UE to search for cells as it has no prior knowledge of these.

NOTE 2: The time required for receiving all the relevant system information data according to the reception procedure and the RRC procedure delay of system information blocks defined in 25.331 for a UTRAN cell. Since the maximum repetition period of the relevant system info blocks that needs to be received by the UE to camp on a cell is 1280ms and the maximum RRC procedure delay for reception system information block is 100ms, 1380 ms is assumed in this test case. Therefore this gives a total of 7.78s (Minimum requirement + 100ms), allow 8s in the test case.

#### RADIO BEARER SETUP (Step 3)

Information Element	Value/remark
RRC State Indicator	CELL PCH
UTRAN DRX cycle length coefficient	7

8.3.5.2.4.3 7,68 Mcps TDD option

8.3.5.2.4.3.1 Initial conditions

This scenario contains 6 cells and 2 carrier frequencies. The test parameters are given in Tables 8.3.5.2.4.3.1 and 8.3.5.2.4.3.2.

**Table 8.3.5.2.4.3.1: General test parameters for Cell Re-selection in Multi carrier case**

Parameter	Unit	Value	Comment
Initial condition	Active cell	Cell1	
	Neighbour cells	Cell2, Cell3, Cell4, Cell5, Cell6	
Final condition	Active cell	Cell2	
HCS		Not used	
UE_TXPWR_MAX_RACH	dBm	21	The value shall be used for all cells in the test.
Qrxlevmin	dBm	-102	The value shall be used for all cells in the test.
Access Service Class (ASC#0) - Persistence value		1	Selected so that no additional delay is caused by the random access procedure. The value shall be used for all cells in the test.
T <sub>SI</sub>	s	1.28	The value shall be used for all cells in the test.
DRX cycle length	s	1.28	The value shall be used for all cells in the test.
T1	s	30	
T2	s	15	

Table 8.3.5.2.4.3.2: Cell re-selection multi carrier multi cell case

Parameter	Unit	Cell 1				Cell 2				Cell 3			
		0		8		0		8		0		8	
Timeslot Number		T1	T2	T1	T2	T1	T2	T1	T2	T1	T2	T1	T2
UTRA RF Channel Number		Channel 1				Channel 2				Channel 1			
PCCPCH_Ec/lor	dB	-3	-3			-3	-3			-3	-3		
SCH_Ec/lor	dB	-9	-9	-9	-9	-9	-9	-9	-9	-9	-9	-9	-9
SCH_offset		0	0	0	0	5	5	5	5	10	10	10	10
PICH_Ec/lor	dB			-3	-3			-3	-3			-3	-3
OCNS_Ec/lor	dB	-3,12	-3,12	-3,12	-3,12	-3,12	-3,12	-3,12	-3,12	-3,12	-3,12	-3,12	-3,12
$\hat{I}_{or}/I_{oc}$	dB	6	0	6	0	0	6	0	6	-3	-3	-3	-3
PCCPCH RSCP	dBm	-67	-73			-73	-67			-76	-76		
Qoffset1 <sub>s,n</sub>	dB	C1, C2: 0; C1, C3:0; C1,C4:0 C1, C5:0; C1, C6:0				C2, C1: 0; C2, C3:0; C2,C4:0 C2, C5:0; C2, C6:0				C3, C1: 0; C3, C2:0; C3,C4:0 C3, C5:0; C3, C6:0			
Qhyst1 <sub>s</sub>	dB	0				0				0			
Treselection	s	0				0				0			
Sintrasearch	dB	not sent				not sent				not sent			
Sintersearch	dB	not sent				not sent				not sent			
Timeslot		Cell 4				Cell 5				Cell 6			
		0		8		0		8		0		8	
UTRA RF Channel Number		T1	T2	T1	T2	T1	T2	T1	T2	T1	T2	T1	T2
UTRA RF Channel Number		Channel 1				Channel 2				Channel 2			
PCCPCH_Ec/lor	dB	-3	-3			-3	-3			-3	-3		
SCH_Ec/lor	dB	-9	-9	-9	-9	-9	-9	-9	-9	-9	-9	-9	-9
SCH_offset		15	15	15	15	20	20	20	20	25	25	25	25
PICH_Ec/lor	dB			-3	-3			-3	-3			-3	-3
OCNS_Ec/lor	dB	-3,12	-3,12	-3,12	-3,12	-3,12	-3,12	-3,12	-3,12	-3,12	-3,12	-3,12	-3,12
$\hat{I}_{or}/I_{oc}$	dB	-3	-3	-3	-3	-3	-3	-3	-3	-3	-3	-3	-3
PCCPCH RSCP	dBm	-76	-76			-76	-76			-76	-76		
Qoffset1 <sub>s,n</sub>	dB	C4, C1: 0; C4, C2:0; C4,C3:0 C4, C5:0; C4, C6:0				C5, C1: 0; C5, C2:0; C5,C3:0 C5, C4:0; C5, C6:0				C6, C1: 0; C6, C2:0; C6,C3:0 C6, C4:0; C6, C5:0			
Qhyst1 <sub>s</sub>	dB	0				0				0			
Treselection	s	0				0				0			
Sintrasearch	dB	not sent				not sent				not sent			
Sintersearch	dB	not sent				not sent				not sent			
$I_{oc}$	dBm/7,6 8 MHz	-70											
Propagation Condition		AWGN											

## 8.3.5.2.4.1.2 Procedure

- a) The SS activates cell 1-6 with T1 defined parameters.
- b) The UE is switched on.
- c) A call is set up according to the test procedure specified in TS 34.108 [3] subclause 7.4.2.7.1 to place the UE in the CELL\_PCH state on Cell 1 and then the SS waits for this process to complete.
- d) After 15 s from the completion of step c) or the beginning of T1, the parameters are changed as described for T2.
- e) If the UE responds on Cell 2 with a PRACH (CELL UPDATE message cause "cell reselection") within 8s, then a success is recorded, the SS shall transmit a CELL UPDATE CONFIRM message and then the procedure moves to step g).
- f) Since the UE has failed to respond with the correct message within the allowed time, a failure is recorded. The SS shall then wait for a total of 15s from the beginning of T2 and if no response is received, the UE shall be switched off and the procedure returns to step a). Otherwise the SS shall transmit a CELL UPDATE CONFIRM message and then the procedure continues with step g).
- g) After a total of 15 s from the beginning of T2, the parameters are changed as described for T1.
- h) If the UE responds on Cell 1 with a PRACH (CELL UPDATE message cause "cell reselection") within 8s, then a success is recorded and the procedure moves to step j).
- i) Since the UE has failed to respond with the correct message within the allowed time, a failure is recorded. The SS shall then wait for a total of 15s from the beginning of T1 and if no response is received the UE shall be switched off and the procedure returns to step a). Otherwise the SS shall transmit a CELL UPDATE CONFIRM message and then the procedure continues with step j).
- j) Repeat steps d) to i) until the confidence level according to annex F.6.2 is achieved..

NOTE 1: T1 is initially 30 s to allow enough time for the UE to search for cells as it has no prior knowledge of these.

NOTE 2: The time required for receiving all the relevant system information data according to the reception procedure and the RRC procedure delay of system information blocks defined in 25.331 for a UTRAN cell. Since the maximum repetition period of the relevant system info blocks that needs to be received by the UE to camp on a cell is 1280ms and the maximum RRC procedure delay for reception system information block is 100ms, 1380 ms is assumed in this test case. Therefore this gives a total of 7.78s(Minimum requirement + 100ms), allow 8s in the test case.

## RADIO BEARER SETUP (Step 3)

Information Element	Value/remark
RRC State Indicator	CELL_PCH
UTRAN DRX cycle length coefficient	7

## 8.3.5.2.5 Test Requirements

## 8.3.5.2.5.1 3,84 Mcps TDD option

For the test to pass, the total number of successful attempts shall be more than 90% with a confidence level of [FFS]% of the cases.

NOTE: If the above Test Requirement differs from the Minimum Requirement then the Test Tolerance applied for this test is non-zero. The Test Tolerance for this test is defined in clause F.2 and the explanation of how the Minimum Requirement has been relaxed by the Test Tolerance is given in clause F.4.

## 8.3.5.2.5.2 1,28 Mcps TDD option

For the test to pass, the total number of successful attempts shall be more than 90% with a confidence level of 95% of the cases.



NOTE: If the above Test Requirement differs from the Minimum Requirement then the Test Tolerance applied for this test is non-zero. The Test Tolerance for this test is defined in clause F.2 and the explanation of how the Minimum Requirement has been relaxed by the Test Tolerance is given in clause F.4.

#### 8.3.5.2.5.3 7,68 Mcps TDD option

For the test to pass, the total number of successful attempts shall be more than 90% with a confidence level of 95% of the cases.

NOTE: If the above Test Requirement differs from the Minimum Requirement then the Test Tolerance applied for this test is non-zero. The Test Tolerance for this test is defined in clause F.2 and the explanation of how the Minimum Requirement has been relaxed by the Test Tolerance is given in clause F.4.

### 8.3.6 Cell Re-selection in URA\_PCH

#### 8.3.6.1 Scenario 1: TDD/TDD cell re-selection single carrier case

##### 8.3.6.1.1 Definition and applicability

##### 8.3.6.1.1.1 3,84 Mcps TDD option

The cell re-selection delay is defined as the time from a change of cell levels to the moment when this change causes the UE to camp on a new cell, and starts to send the URA UPDATE message with cause value "change of URA" in the new cell.

The requirements and this test apply to the 3,84 Mcps TDD UE.

##### 8.3.6.1.1.2 1,28 Mcps TDD option

The cell re-selection delay is defined as the time from a change of cell levels to the moment when this change causes the UE to camp on a new cell, and starts to send the SYNCH-UL sequence in the UpPTS for sending URA UPDATE message with cause value "change of URA" in the new cell.

The requirements and this test apply to the 1,28 Mcps TDD UE. The two cells shall belong to different UTRAN Registration Areas (URAs).

##### 8.3.6.1.1.3 7,68 Mcps TDD option

The cell re-selection delay is defined as the time from a change of cell levels to the moment when this change causes the UE to camp on a new cell, and starts to send the URA UPDATE message with cause value "change of URA" in the new cell.

The requirements and this test apply to the 7,68 Mcps TDD UE.

##### 8.3.6.1.2 Minimum requirement

##### 8.3.6.1.2.1 3,84 Mcps TDD option

The cell re-selection delay shall be less than 8 s.

NOTE:

The cell re-selection delay can be expressed as:  $T_{\text{evaluateTDD}} + T_{\text{SI}}$ , where:

$T_{\text{evaluateTDD}}$  A DRX cycle length of 1280ms is assumed for this test case, this leads to a  $T_{\text{evaluateTDD}}$  of 6.4s according to TS25.123 [2] table 4.1 in clause 4.2.2.7.

$T_{\text{SI}}$  Maximum repetition period of relevant system info blocks that needs to be received by the UE to camp on a cell. 1280 ms is assumed in this test case.

This gives a total of 7.68 s, allow 8s in the test case.

The normative reference for this requirement is TS 25.123 [2] clauses 5.6 and A.5.6.1.

##### 8.3.6.1.2.2 1,28 Mcps TDD option

The cell re-selection delay shall be less than 8 s.

## NOTE:

The cell re-selection delay can be expressed as:  $T_{\text{evaluateNTDD}} + T_{\text{SI}}$ , where:

$T_{\text{evaluateNTDD}}$  A DRX cycle length of 1280ms is assumed for this test case, this leads to a  $T_{\text{evaluateTDD}}$  of 6.4s according to TS 25.123 [2] table 4.1a in clause 4.2.2.

$T_{\text{SI}}$  Time required for receiving all the relevant system information data according to the reception procedure and the RRC procedure delay of system information blocks defined in 25.331 for a UTRAN cell (ms). 1280 ms is assumed in this test case.

This gives a total of 7.68 s, allowing 8s in the test case.

The normative reference for this requirement is TS 25.123 [2] clauses 5.6 and A.5.6.1.

## 8.3.6.1.2.3 7,68 Mcps TDD option

The cell re-selection delay shall be less than 8 s.

## NOTE:

The cell re-selection delay can be expressed as:  $T_{\text{evaluateTDD}} + T_{\text{SI}}$ , where:

$T_{\text{evaluateTDD}}$  A DRX cycle length of 1280ms is assumed for this test case, this leads to a  $T_{\text{evaluateTDD}}$  of 6.4s according to TS25.123 [2] table 4.1B in clause 4.2.2.7.3.

$T_{\text{SI}}$  Maximum repetition period of relevant system info blocks that needs to be received by the UE to camp on a cell. 1280 ms is assumed in this test case.

This gives a total of 7.68 s, allow 8s in the test case.

The normative reference for this requirement is TS 25.123 [2] clauses 5.6 and A.5.6.1.

## 8.3.6.1.3 Test purpose

This test verifies that the UE meets the minimum requirement for the cell re-selection delay in URA\_PCH for the single carrier case.

## 8.3.6.1.4 Method of test

## 8.3.6.1.4.1 3,84 Mcps TDD option

## 8.3.6.1.4.1.1 Initial conditions

This scenario contains 6 cells operating on the same carrier frequency. The test parameters are given in Tables 8.3.6.1.1.1, and 8.3.6.1.1.2.

**Table 8.3.6.1.1.1: General test parameters for Cell Re-selection single carrier multi-cell case**

Parameter	Unit	Value	Comment
Initial condition	Active cell	Cell1	
	Neighbour cells	Cell2, Cell3, Cell4, Cell5, Cell6	
Final condition	Active cell	Cell2	
HCS		Not used	
UE_TXPWR_MAX_RACH	dBm	21	The value shall be used for all cells in the test.
Qrxlevmin	dBm	-102	The value shall be used for all cells in the test.
Access Service Class (ASC#0) - Persistence value		1	Selected so that no additional delay is caused by the random access procedure. The value shall be used for all cells in the test.
$T_{\text{SI}}$	s	1,28	The value shall be used for all cells in the test.
DRX cycle length	s	1,28	The value shall be used for all cells in the test.
T1	s	15	
T2	s	15	

Table 8.3.6.1.1.2: Cell re-selection single carrier multi-cell case

Parameter	Unit	Cell 1				Cell 2				Cell 3			
		0		8		0		8		0		8	
Timeslot Number		T1	T2	T1	T2	T1	T2	T1	T2	T1	T2	T1	T2
UTRA RF Channel Number		Channel 1				Channel 1				Channel 1			
PCCPCH_Ec/lor	dB	-3	-3			-3	-3			-3	-3		
SCH_Ec/lor	dB	-9	-9	-9	-9	-9	-9	-9	-9	-9	-9	-9	-9
SCH_toffset		0	0	0	0	5	5	5	5	10	10	10	10
PICH_Ec/lor	dB			-3	-3			-3	-3			-3	-3
OCNS_Ec/lor	dB	-3,12	-3,12	-3,12	-3,12	-3,12	-3,12	-3,12	-3,12	-3,12	-3,12	-3,12	-3,12
$\hat{I}_{or}/I_{oc}$	dB	9	7	9	7	7	9	7	9	-1	-1	-1	-1
PCCPCH RSCP	dBm	-64	-66			-66	-64			-74	-74		
Qoffset <sub>1s,n</sub>	dB	C1, C2: 0; C1, C3:0; C1,C4:0 C1, C5:0; C1,C6:0				C2, C1: 0; C2, C3:0; C2,C4:0 C2, C5: 0; C2, C6:0				C3, C1: 0; C3, C2:0; C3,C4:0 C3, C5: 0; C3, C6:0			
Qhyst <sub>1s</sub>	dB	0				0				0			
Treselection	s	0				0				0			
Sintrasearch	dB	not sent				not sent				not sent			
Timeslot		Cell 4				Cell 5				Cell 6			
		0		8		0		8		0		8	
UTRA RF Channel Number		Channel 1				Channel 1				Channel 1			
PCCPCH_Ec/lor	dB	-3	-3			-3	-3			-3	-3		
SCH_Ec/lor	dB	-9	-9	-9	-9	-9	-9	-9	-9	-9	-9	-9	-9
SCH_toffset		15	15	15	15	20	20	20	20	25	25	25	25
PICH_Ec/lor	dB			-3	-3			-3	-3			-3	-3
OCNS_Ec/lor	dB	-3,12	-3,12	-3,12	-3,12	-3,12	-3,12	-3,12	-3,12	-3,12	-3,12	-3,12	-3,12
$\hat{I}_{or}/I_{oc}$	dB	-1	-1	-1	-1	-1	-1	-1	-1	-1	-1	-1	-1
PCCPCH RSCP	dBm	-74	-74			-74	-74			-74	-74		
Qoffset <sub>1s,n</sub>	dB	C4, C1: 0; C4, C2:0; C4,C3:0C4, C5:0; C4, C6:0				C5, C1: 0; C5, C2:0; C5,C3:0 C5, C4:0; C5, C6:0				C6, C1: 0; C6, C2:0; C6,C3:0 C6, C4:0; C6, C5:0			
Qhyst <sub>1s</sub>	dB	0				0				0			
Treselection	s	0				0				0			
Sintrasearch	dB	not sent				not sent				not sent			
$I_{oc}$	dBm/3,8 4 MHz	-70											
Propagation Condition		AWGN											

## 8.3.6.1.4.1.2 Procedure

- a) The SS activates cell 1-6 with T1 defined parameters.
- b) The UE is switched on.
- c) A call is set up according to the test procedure specified in TS 34.108 [3] subclause 7.4.2.7.2 to place the UE in the URA\_PCH state on Cell 1 and then the SS waits for this process to complete.
- d) After 15 s from the completion of step c) or the beginning of T1, the parameters are changed as described for T2.
- e) If the UE responds on Cell 1 with a PRACH (URA UPDATE message cause "change of URA") within 8s, then a success is recorded, the SS shall transmit a URA UPDATE CONFIRM message and then the procedure moves to step g).
- f) Since the UE has failed to respond with the correct message within the allowed time, a failure is recorded. The SS shall then wait for a total of 15s from the beginning of T2 and if no response is received, the UE shall be switched off and the procedure returns to step a). Otherwise the SS shall transmit a URA UPDATE CONFIRM message and then the procedure continues with step g).
- g) After a total of 15 s from the beginning of T2, the parameters are changed as described for T1.
- h) If the UE responds on Cell 1 with a PRACH (URA UPDATE message cause "change of URA") within 8s, then a success is recorded and the procedure moves to step j).
- i) Since the UE has failed to respond with the correct message within the allowed time, a failure is recorded. The SS shall then wait for a total of 15s from the beginning of T1 and if no response is received the UE shall be switched off and the procedure returns to step a). Otherwise the SS shall transmit a URA UPDATE CONFIRM message and then the procedure continues with step j).
- j) Repeat steps d) to i) [TBD] times.

NOTE: The time required for receiving all the relevant system information data according to the reception procedure and the RRC procedure delay of system information blocks defined in 25.331 for a UTRAN cell. Since the maximum repetition period of the relevant system info blocks that needs to be received by the UE to camp on a cell is 1280ms and the maximum RRC procedure delay for reception system information block is 100ms, 1380 ms is assumed in this test case. Therefore this gives a total of 7.78s (Minimum requirement + 100ms), allow 8s in the test case.

## RADIO BEARER SETUP (Step 3)

Information Element	Value/remark
RRC State Indicator	URA PCH
UTRAN DRX cycle length coefficient	7

8.3.6.1.4.2 1,28 Mcps TDD option

8.3.6.1.4.2.1 Initial conditions

This scenario contains 6 cells operating on the same carrier frequency. The test parameters are given in Tables 8.3.6.1.4.2.1, and 8.3.6.1.4.2.2. Cell 1 and Cell 2 shall belong to different UTRAN Registration Areas (URAs).

**Table 8.3.6.1.4.2.1: General test parameters for Cell Re-selection single carrier multi-cell case**

Parameter		Unit	Value	Comment
Initial condition	Active cell		Cell1	
	Neighbour cells		Cell2, Cell3, Cell4, Cell5, Cell6	
Final condition	Active cell		Cell2	
HCS			Not used	
UE_TXPWR_MAX_RACH		dBm	21	The value shall be used for all cells in the test.
Qrxlevmin		dBm	-103	The value shall be used for all cells in the test.
Access Service Class (ASC#0) -- Persistence value			1	Selected so that no additional delay is caused by the random access procedure. The value shall be used for all cells in the test.
T <sub>SI</sub>		s	1,28	The value shall be used for all cells in the test.
DRX cycle length		s	1,28	The value shall be used for all cells in the test.
T1		s	15	
T2		s	15	

Table 8.3.6.1.4.2.2: Cell re-selection single carrier multi-cell case

Parameter	Unit	Cell 1				Cell 2				Cell 3			
		0		DWPTS		0		DWPTS		0		DWPTS	
Timeslot Number		T1	T2	T1	T2	T1	T2	T1	T2	T1	T2	T1	T2
UTRA RF Channel Number		Channel 1				Channel 1				Channel 1			
PCCPCH_Ec/lor	dB	-3	-3			-3	-3			-3	-3		
DwPCH_Ec/lor	dB			0	0			0	0			0	0
OCNS_Ec/lor	dB	-3	-3			-3	-3			-3	-3		
$\hat{I}_{or}/I_{oc}$	dB	10	7	10	7	7	10	7	10	-1	-1	-1	-1
PCCPCH RSCP	dBm	-63	-66			-66	-63			-74	-74		
Qoffset1 <sub>s,n</sub>	dB	C1, C2: 0; C1, C3:0; C1,C4:0 C1, C5:0; C1,C6:0				C2, C1: 0; C2, C3:0; C2,C4:0 C2, C5: 0; C2, C6:0				C3, C1: 0; C3, C2:0; C3,C4:0 C3, C5: 0; C3, C6:0			
Qhyst1 <sub>s</sub>	dB	0				0				0			
Treselection	s	0				0				0			
Sintrasearch	dB	not sent				not sent				not sent			
Timeslot		Cell 4				Cell 5				Cell 6			
		0		DWPTS		0		DWPTS		0		DWPTS	
UTRA RF Channel Number		Channel 1				Channel 1				Channel 1			
PCCPCH_Ec/lor	dB	-3	-3			-3	-3			-3	-3		
DwPCH_Ec/lor	dB			0	0			0	0			0	0
OCNS_Ec/lor	dB	-3	-3			-3	-3			-3	-3		
$\hat{I}_{or}/I_{oc}$	dB	-1	-1	-1	-1	-1	-1	-1	-1	-1	-1	-1	-1
PCCPCH RSCP	dBm	-74	-74			-74	-74			-74	-74		
Qoffset1 <sub>s,n</sub>	dB	C4, C1: 0; C4, C2:0; C4,C3:0 C4, C5:0; C4, C6:0				C5, C1: 0; C5, C2:0; C5,C3:0 C5, C4:0; C5, C6:0				C6, C1: 0; C6, C2:0; C6,C3:0 C6, C4:0; C6, C5:0			
Qhyst1 <sub>s</sub>	dB	0				0				0			
Treselection	s	0				0				0			
Sintrasearch	dB	not sent				not sent				not sent			
$I_{oc}$	dBm/1,28 MHz	-70											
Propagation Condition		AWGN											

## 8.3.6.1.4.2.2 Procedure

- a) The SS activates cell 1-6 with T1 defined parameters.
- b) The UE is switched on.
- c) A call is set up according to the test procedure specified in TS 34.108 [3] subclause 7.4.2.7.2 to place the UE in the URA\_PCH state on Cell 1 and then the SS waits for this process to complete.
- d) After 15 s from the completion of step c) or the beginning of T1, the parameters are changed as described for T2.
- e) If the UE responds on Cell 1 with a SYNCH-UL sequence in the UpPTS for sending URA UPDATE message cause "change of URA" within 8s, then a success is recorded. After receiving the URA UPDATE message cause "change of URA", the SS shall transmit a URA UPDATE CONFIRM message and then the procedure moves to step g).
- f) If the UE has failed to respond with a SYNCH-UL sequence in the UpPTS within the allowed time, a failure is recorded. The SS shall then wait for a total of 15s from the beginning of T2 and if no response is received, the UE shall be switched off and the procedure returns to step a). Otherwise after receiving the URA UPDATE message cause "change of URA", the SS shall transmit a URA UPDATE CONFIRM message and then the procedure continues with step g).
- g) After a total of 15 s from the beginning of T2, the parameters are changed as described for T1.
- h) If the UE responds on Cell 1 with a a SYNCH-UL sequence in the UpPTS for sending URA UPDATE message cause "change of URA" message within 8s, then a success is recorded and the procedure moves to step j).
- i) If the UE has failed to respond with a SYNCH-UL sequence in the UpPTS within the allowed time, a failure is recorded. The SS shall then wait for a total of 15s from the beginning of T1 and if no response is received the UE shall be switched off and the procedure returns to step a). Otherwise after receiving the URA UPDATE message cause "change of URA", the SS shall transmit a URA UPDATE CONFIRM message and then the procedure continues with step j).
- j) After another 15 s, the UE shall be switched off.
- k) Repeat steps a) to j) until the confidence level according to annex F.6.2 is achieved.

NOTE: The time required for receiving all the relevant system information data according to the reception procedure and the RRC procedure delay of system information blocks defined in 25.331 for a UTRAN cell. Since the maximum repetition period of the relevant system info blocks that needs to be received by the UE to camp on a cell is 1280ms and the maximum RRC procedure delay for reception system information block is 100ms, 1380 ms is assumed in this test case. Therefore this gives a total of 7.78s (Minimum requirement + 100ms), allow 8s in the test case.

## RADIO BEARER SETUP (Step 3)

Information Element	Value/remark
RRC State Indicator	URA PCH
UTRAN DRX cycle length coefficient	7

## 8.3.6.1.4.3 7,68 Mcps TDD option

## 8.3.6.1.4.3.1 Initial conditions

This scenario contains 6 cells operating on the same carrier frequency. The test parameters are given in Tables 8.3.6.1.4.3.1, and 8.3.6.1.4.3.2.

**Table 8.3.6.1.4.3.1: General test parameters for Cell Re-selection single carrier multi-cell case**

Parameter		Unit	Value	Comment
Initial condition	Active cell		Cell1	
	Neighbour cells		Cell2, Cell3, Cell4, Cell5, Cell6	
Final condition	Active cell		Cell2	
HCS			Not used	
UE_TXPWR_MAX_RACH		dBm	21	The value shall be used for all cells in the test.
Qrxlevmin		dBm	-102	The value shall be used for all cells in the test.
Access Service Class (ASC#0) - Persistence value			1	Selected so that no additional delay is caused by the random access procedure. The value shall be used for all cells in the test.
T <sub>SI</sub>		s	1.28	The value shall be used for all cells in the test.
DRX cycle length		s	1.28	The value shall be used for all cells in the test.
T1		s	15	
T2		s	15	



Table 8.3.6.1.4.3.2: Cell re-selection single carrier multi-cell case

Parameter	Unit	Cell 1				Cell 2				Cell 3			
		0		8		0		8		0		8	
Timeslot Number		T1	T2	T1	T2	T1	T2	T1	T2	T1	T2	T1	T2
UTRA RF Channel Number		Channel 1				Channel 1				Channel 1			
PCCPCH_Ec/lor	dB	-3	-3			-3	-3			-3	-3		
SCH_Ec/lor	dB	-9	-9	-9	-9	-9	-9	-9	-9	-9	-9	-9	-9
SCH_toffset		0	0	0	0	5	5	5	5	10	10	10	10
PICH_Ec/lor	dB			-3	-3			-3	-3			-3	-3
OCNS_Ec/lor	dB	-3,12	-3,12	-3,12	-3,12	-3,12	-3,12	-3,12	-3,12	-3,12	-3,12	-3,12	-3,12
$\hat{I}_{or}/I_{oc}$	dB	9	7	9	7	7	9	7	9	-1	-1	-1	-1
PCCPCH RSCP	dBm	-64	-66			-66	-64			-74	-74		
Qoffset1 <sub>s,n</sub>	dB	C1, C2: 0; C1, C3:0; C1,C4:0 C1, C5:0; C1,C6:0				C2, C1: 0; C2, C3:0; C2,C4:0 C2, C5: 0; C2, C6:0				C3, C1: 0; C3, C2:0; C3,C4:0 C3, C5: 0; C3, C6:0			
Qhyst1 <sub>s</sub>	dB	0				0				0			
Treselection	s	0				0				0			
Sintrasearch	dB	not sent				not sent				not sent			
		Cell 4				Cell 5				Cell 6			
Timeslot		0		8		0		8		0		8	
		T1	T2	T1	T2	T1	T2	T1	T2	T1	T2	T1	T2
UTRA RF Channel Number		Channel 1				Channel 1				Channel 1			
PCCPCH_Ec/lor	dB	-3	-3			-3	-3			-3	-3		
SCH_Ec/lor	dB	-9	-9	-9	-9	-9	-9	-9	-9	-9	-9	-9	-9
SCH_toffset		15	15	15	15	20	20	20	20	25	25	25	25
PICH_Ec/lor	dB			-3	-3			-3	-3			-3	-3
OCNS_Ec/lor	dB	-3,12	-3,12	-3,12	-3,12	-3,12	-3,12	-3,12	-3,12	-3,12	-3,12	-3,12	-3,12
$\hat{I}_{or}/I_{oc}$	dB	-1	-1	-1	-1	-1	-1	-1	-1	-1	-1	-1	-1
PCCPCH RSCP	dBm	-74	-74			-74	-74			-74	-74		
Qoffset1 <sub>s,n</sub>	dB	C4, C1: 0; C4, C2:0; C4,C3:0 C4, C5:0; C4, C6:0				C5, C1: 0; C5, C2:0; C5,C3:0 C5, C4:0; C5, C6:0				C6, C1: 0; C6, C2:0; C6,C3:0 C6, C4:0; C6, C5:0			
Qhyst1 <sub>s</sub>	dB	0				0				0			
Treselection	s	0				0				0			
Sintrasearch	dB	not sent				not sent				not sent			
$I_{oc}$	dBm/7,68 MHz	-70											
Propagation Condition		AWGN											

## 8.3.6.1.4.3.2 Procedure

- a) The SS activates cell 1-6 with T1 defined parameters.
- b) The UE is switched on.
- c) A call is set up according to the test procedure specified in TS 34.108 [3] subclause 7.4.2.7.2 to place the UE in the URA\_PCH state on Cell 1 and then the SS waits for this process to complete.
- d) After 15 s from the completion of step c) or the beginning of T1, the parameters are changed as described for T2.
- e) If the UE responds on Cell 1 with a PRACH (URA UPDATE message cause "change of URA") within 8s, then a success is recorded, the SS shall transmit a URA UPDATE CONFIRM message and then the procedure moves to step g).
- f) Since the UE has failed to respond with the correct message within the allowed time, a failure is recorded. The SS shall then wait for a total of 15s from the beginning of T2 and if no response is received, the UE shall be switched off and the procedure returns to step a). Otherwise the SS shall transmit a URA UPDATE CONFIRM message and then the procedure continues with step g).
- g) After a total of 15 s from the beginning of T2, the parameters are changed as described for T1.
- h) If the UE responds on Cell 1 with a PRACH (URA UPDATE message cause "change of URA") within 8s, then a success is recorded and the procedure moves to step j).
- i) Since the UE has failed to respond with the correct message within the allowed time, a failure is recorded. The SS shall then wait for a total of 15s from the beginning of T1 and if no response is received the UE shall be switched off and the procedure returns to step a). Otherwise the SS shall transmit a URA UPDATE CONFIRM message and then the procedure continues with step j).
- j) Repeat steps d) to i) until the confidence level according to annex F.6.2 is achieved..

NOTE: The time required for receiving all the relevant system information data according to the reception procedure and the RRC procedure delay of system information blocks defined in 25.331 for a UTRAN cell. Since the maximum repetition period of the relevant system info blocks that needs to be received by the UE to camp on a cell is 1280ms and the maximum RRC procedure delay for reception system information block is 100ms, 1380 ms is assumed in this test case. Therefore this gives a total of 7.78s (Minimum requirement + 100ms), allow 8s in the test case.

## RADIO BEARER SETUP (Step 3)

Information Element	Value/remark
RRC State Indicator	URA PCH
UTRAN DRX cycle length coefficient	7

## 8.3.6.1.5 Test Requirements

## 8.3.6.1.5.1 3,84 Mcps TDD option

For the test to pass, the total number of successful attempts shall be more than 90% with a confidence level of [FFS]% of the cases.

NOTE: If the above Test Requirement differs from the Minimum Requirement then the Test Tolerance applied for this test is non-zero. The Test Tolerance for this test is defined in clause F.2 and the explanation of how the Minimum Requirement has been relaxed by the Test Tolerance is given in clause F.4.

## 8.3.6.1.5.2 1,28 Mcps TDD option

For the test to pass, the total number of successful attempts shall be more than 90% with a confidence level of 95% of the cases.

NOTE: If the above Test Requirement differs from the Minimum Requirement then the Test Tolerance applied for this test is non-zero. The Test Tolerance for this test is defined in clause F.2 and the explanation of how the Minimum Requirement has been relaxed by the Test Tolerance is given in clause F.4.

## 8.3.6.1.5.3 7,68 Mcps TDD option

For the test to pass, the total number of successful attempts shall be more than 90% with a confidence level of 95% of the cases.

NOTE: If the above Test Requirement differs from the Minimum Requirement then the Test Tolerance applied for this test is non-zero. The Test Tolerance for this test is defined in clause F.2 and the explanation of how the Minimum Requirement has been relaxed by the Test Tolerance is given in clause F.4.

## 8.3.6.2 Scenario 2: TDD/TDD cell re-selection multi carrier case

## 8.3.6.2.1 Definition and applicability

## 8.3.6.2.1.1 3,84 Mcps TDD option

The cell re-selection delay is defined as the time from a change of cell levels to the moment when this change causes the UE to camp on a new cell , and starts to send the URA UPDATE message with cause value "change of URA" in the new cell.

The requirements and this test apply to the 3,84 Mcps TDD UE.

## 8.3.6.2.1.2 1,28 Mcps TDD option

The cell re-selection delay is defined as the time from a change of cell levels to the moment when this change causes the UE to camp on a new cell , and starts to send a SYNCH-UL sequence in the UpPTS for sending the URA UPDATE message with cause value "change of URA" in the new cell.

The requirements and this test apply to the 1,28 Mcps TDD UE. The cells shall belong to different UTRAN Registration Areas (URAs).

## 8.3.6.2.1.3 7,68 Mcps TDD option

The cell re-selection delay is defined as the time from a change of cell levels to the moment when this change causes the UE to camp on a new cell , and starts to send the URA UPDATE message with cause value "change of URA" in the new cell.

The requirements and this test apply to the 7,68 Mcps TDD UE.

## 8.3.6.2.2 Minimum requirement

## 8.3.6.2.2.1 3,84 Mcps TDD option

The cell re-selection delay shall be less than 8 s.

NOTE:

The cell re-selection delay can be expressed as:  $T_{\text{evaluateTDD}} + T_{\text{SI}}$ , where:

$T_{\text{evaluateTDD}}$  A DRX cycle length of 1280ms is assumed for this test case, this leads to a  $T_{\text{evaluateTDD}}$  of 6.4s according to TS25.123 [2] table 4.1 in clause 4.2.2.7.

$T_{\text{SI}}$  Maximum repetition period of relevant system info blocks that needs to be received by the UE to camp on a cell. 1280 ms is assumed in this test case.

This gives a total of 7.68 s, allow 8s in the test case.

The normative reference for this requirement is TS 25.123 [2] clauses 5.6 and A.5.6.1.

## 8.3.6.2.2.2 1,28 Mcps TDD option

The cell re-selection delay shall be less than 8 s.

NOTE:

The cell re-selection delay can be expressed as:  $T_{\text{evaluateNTDD}} + T_{\text{SI}}$ , where:

$T_{\text{evaluateNTDD}}$  A DRX cycle length of 1280ms is assumed for this test case, this leads to a  $T_{\text{evaluateTDD}}$  of 6.4s according to TS 25.123 [2] table 4.1a in clause 4.2.2.

$T_{SI}$  Time required for receiving all the relevant system information data according to the reception procedure and the RRC procedure delay of system information blocks defined in 25.331 for a UTRAN cell (ms). 1280 ms is assumed in this test case.

This gives a total of 7.68 s, allowing 8s in the test case.

The normative reference for this requirement is TS 25.123 [2] clauses 5.6.2 and A.5.6.2.1.2

#### 8.3.6.2.2.3 7,68 Mcps TDD option

The cell re-selection delay shall be less than 8 s.

##### NOTE:

The cell re-selection delay can be expressed as:  $T_{\text{evaluateTDD}} + T_{SI}$ , where:

$T_{\text{evaluateTDD}}$  A DRX cycle length of 1280ms is assumed for this test case, this leads to a  $T_{\text{evaluateTDD}}$  of 6.4s according to TS25.123 [2] table 4.1B in clause 4.2.2.7.3.

$T_{SI}$  Maximum repetition period of relevant system info blocks that needs to be received by the UE to camp on a cell. 1280 ms is assumed in this test case.

This gives a total of 7.68 s, allow 8s in the test case.

The normative reference for this requirement is TS 25.123 [2] clauses 5.6 and A.5.6.1.

#### 8.3.6.2.3 Test purpose

This test verifies that the UE meets the minimum requirement for the cell re-selection delay in URA\_PCH for the Multiple carrier case

#### 8.3.6.2.4 Method of test

##### 8.3.6.2.4.1 3,84 Mcps TDD option

##### 8.3.6.2.4.1.1 Initial conditions

This scenario contains 6 cells operating on the same carrier frequency. The test parameters are given in Tables 8.3.6.2.1.1, and 8.3.6.2.1.2.

**Table 8.3.6.2.1.1: General test parameters for Cell Re-selection single carrier multi-cell case**

Parameter		Unit	Value	Comment
Initial condition	Active cell		Cell1	
	Neighbour cells		Cell2, Cell3,Cell4, Cell5, Cell6	
Final condition	Active cell		Cell2	
HCS			Not used	
UE_TXPWR_MAX_RACH		dBm	21	The value shall be used for all cells in the test.
Qrxlevmin		dBm	-102	The value shall be used for all cells in the test.
Access Service Class (ASC#0) - Persistence value			1	Selected so that no additional delay is caused by the random access procedure. The value shall be used for all cells in the test.
$T_{SI}$		s	1,28	The value shall be used for all cells in the test.
DRX cycle length		s	1,28	The value shall be used for all cells in the test.
T1		s	15	
T2		s	15	

Table 8.3.6.2.1.2: Cell re-selection single carrier multi-cell case

Parameter	Unit	Cell 1				Cell 2				Cell 3			
		0		8		0		8		0		8	
Timeslot Number		T1	T2	T1	T2	T1	T2	T1	T2	T1	T2	T1	T2
UTRA RF Channel Number		Channel 1				Channel 1				Channel 1			
PCCPCH_Ec/lor	dB	-3	-3			-3	-3			-3	-3		
SCH_Ec/lor	dB	-9	-9	-9	-9	-9	-9	-9	-9	-9	-9	-9	-9
SCH_toffset		0	0	0	0	5	5	5	5	10	10	10	10
PICH_Ec/lor	dB			-3	-3			-3	-3			-3	-3
OCNS_Ec/lor	dB	-3,12	-3,12	-3,12	-3,12	-3,12	-3,12	-3,12	-3,12	-3,12	-3,12	-3,12	-3,12
$\hat{I}_{or}/I_{oc}$	dB	9	7	9	7	7	9	7	9	-1	-1	-1	-1
PCCPCH RSCP	dBm	-64	-66			-66	-64			-74	-74		
Qoffset <sub>1s,n</sub>	dB	C1, C2: 0; C1, C3:0; C1,C4:0 C1, C5:0; C1,C6:0				C2, C1: 0; C2, C3:0; C2,C4:0 C2, C5: 0; C2, C6:0				C3, C1: 0; C3, C2:0; C3,C4:0 C3, C5: 0; C3, C6:0			
Qhyst <sub>1s</sub>	dB	0				0				0			
Treselection	s	0				0				0			
Sintrasearch	dB	not sent				not sent				not sent			
Timeslot	Unit	Cell 4				Cell 5				Cell 6			
		0		8		0		8		0		8	
UTRA RF Channel Number		Channel 1				Channel 1				Channel 1			
PCCPCH_Ec/lor	dB	-3	-3			-3	-3			-3	-3		
SCH_Ec/lor	dB	-9	-9	-9	-9	-9	-9	-9	-9	-9	-9	-9	-9
SCH_toffset		15	15	15	15	20	20	20	20	25	25	25	25
PICH_Ec/lor	dB			-3	-3			-3	-3			-3	-3
OCNS_Ec/lor	dB	-3,12	-3,12	-3,12	-3,12	-3,12	-3,12	-3,12	-3,12	-3,12	-3,12	-3,12	-3,12
$\hat{I}_{or}/I_{oc}$	dB	-1	-1	-1	-1	-1	-1	-1	-1	-1	-1	-1	-1
PCCPCH RSCP	dBm	-74	-74			-74	-74			-74	-74		
Qoffset <sub>1s,n</sub>	dB	C4, C1: 0; C4, C2:0; C4,C3:0C4, C5:0; C4, C6:0				C5, C1: 0; C5, C2:0; C5,C3:0 C5, C4:0; C5, C6:0				C6, C1: 0; C6, C2:0; C6,C3:0 C6, C4:0; C6, C5:0			
Qhyst <sub>1s</sub>	dB	0				0				0			
Treselection	s	0				0				0			
Sintrasearch	dB	not sent				not sent				not sent			
$I_{oc}$	dBm/3,8 4 MHz	-70											
Propagation Condition		AWGN											

## 8.3.6.2.4.1.2 Procedure

- a) The SS activates cell 1-6 with T1 defined parameters.
- b) The UE is switched on.
- c) A call is set up according to the test procedure specified in TS 34.108 [3] subclause 7.4.2.7.2 to place the UE in the URA\_PCH state on Cell 1 and then the SS waits for this process to complete.
- d) After 15 s from the completion of step c) or the beginning of T1, the parameters are changed as described for T2.
- e) If the UE responds on Cell 1 with a PRACH (URA UPDATE message cause "change of URA") within 8s, then a success is recorded, the SS shall transmit a URA UPDATE CONFIRM message and then the procedure moves to step g).
- f) Since the UE has failed to respond with the correct message within the allowed time, a failure is recorded. The SS shall then wait for a total of 15s from the beginning of T2 and if no response is received, the UE shall be switched off and the procedure returns to step a). Otherwise the SS shall transmit a URA UPDATE CONFIRM message and then the procedure continues with step g).
- g) After a total of 15 s from the beginning of T2, the parameters are changed as described for T1.
- h) If the UE responds on Cell 1 with a PRACH (URA UPDATE message cause "change of URA") within 8s, then a success is recorded and the procedure moves to step j).
- i) Since the UE has failed to respond with the correct message within the allowed time, a failure is recorded. The SS shall then wait for a total of 15s from the beginning of T1 and if no response is received the UE shall be switched off and the procedure returns to step a). Otherwise the SS shall transmit a URA UPDATE CONFIRM message and then the procedure continues with step j).
- j) Repeat steps d) to i) [TBD] times.

NOTE: The time required for receiving all the relevant system information data according to the reception procedure and the RRC procedure delay of system information blocks defined in 25.331 for a UTRAN cell. Since the maximum repetition period of the relevant system info blocks that needs to be received by the UE to camp on a cell is 1280ms and the maximum RRC procedure delay for reception system information block is 100ms, 1380 ms is assumed in this test case. Therefore this gives a total of 7.78s (Minimum requirement + 100ms), allow 8s in the test case.

## RADIO BEARER SETUP (Step 3)

Information Element	Value/remark
RRC State Indicator	URA PCH
UTRAN DRX cycle length coefficient	7

8.3.6.2.4.2 1,28 Mcps TDD option

8.3.6.2.4.2.1 Initial conditions

This scenario contains 6 cells and 2 carrier frequencies. The test parameters are given in Tables 8.3.6.2.4.2.1, and 8.3.6.2.4.2.2.

Cell1 and Cell2 shall belong to different UTRAN Registration Areas (URA).

**Table A.5.6.7: General test parameters for 1,28Mcps Cell Re-selection in Multi carrier case**

Parameter	Unit	Value	Comment
Initial condition	Active cell	Cell1	
	Neighbour cells	Cell2, Cell3, Cell4, Cell5, Cell6	
Final condition	Active cell	Cell2	
HCS		Not used	
UE_TXPWR_MAX_RACH	dBm	21	The value shall be used for all cells in the test.
Qrxlevmin	dBm	-103	The value shall be used for all cells in the test.
Access Service Class (ASC#0) - Persistence value		1	Selected so that no additional delay is caused by the random access procedure. The value shall be used for all cells in the test.
T <sub>SI</sub>	s	1,28	The value shall be used for all cells in the test.
DRX cycle length	s	1,28	The value shall be used for all cells in the test.
T1	s	30	
T2	s	15	

**Table A.5.6.8: Cell re-selection 1,28Mcps multi carrier multi cell case**

Parameter	Unit	Cell 1				Cell 2				Cell 3			
		0		DWPTS		0		DWPTS		0		DWPTS	
Timeslot Number		T1	T2	T1	T2	T1	T2	T1	T2	T1	T2	T1	T2
UTRA RF Channel Number		Channel 1				Channel 2				Channel 1			
PCCPCH_Ec/I <sub>or</sub>	dB	-3	-3			-3	-3			-3	-3		
DwPCH_Ec/I <sub>or</sub>	dB			0	0			0	0			0	0
OCNS_Ec/I <sub>or</sub>	dB	-3	-3			-3	-3			-3	-3		
$\hat{I}_{or}/I_{oc}$	dB	10	4	10	4	4	10	4	10	-1	-1	-1	-1
PCCPCH RSCP	dBm	-63	-69			-69	-63			-74	-74		
Qoffset1 <sub>s,n</sub>	dB	C1, C2: 0; C1, C3:0; C1, C4:0 C1, C5:0; C1, C6:0				C2, C1: 0; C2, C3:0; C2, C4:0 C2, C5:0; C2, C6:0				C3, C1: 0; C3, C2:0; C3, C4:0 C3, C5:0; C3, C6:0			
Qhyst1 <sub>s</sub>	dB	0				0				0			
Treselection	s	0				0				0			
Sintrasearch	dB	not sent				not sent				not sent			
Sintersearch	dB	not sent				not sent				not sent			
Timeslot		Cell 4				Cell 5				Cell 6			
		0		DWPTS		0		DWPTS		0		DWPTS	
UTRA RF Channel Number		Channel 1				Channel 2				Channel 2			
PCCPCH_Ec/I <sub>or</sub>	dB	-3	-3			-3	-3			-3	-3		
DwPCH_Ec/I <sub>or</sub>	dB			0	0			0	0			0	0
OCNS_Ec/I <sub>or</sub>	dB	-3	-3			-3	-3			-3	-3		
$\hat{I}_{or}/I_{oc}$	dB	-1	-1	-1	-1	-1	-1	-1	-1	-1	-1	-1	-1
PCCPCH RSCP	dBm	-74	-74			-74	-74			-74	-74		
Qoffset1 <sub>s,n</sub>	dB	C4, C1: 0; C4, C2:0; C4, C3:0 C4, C5:0; C4, C6:0				C5, C1: 0; C5, C2:0; C5, C3:0 C5, C4:0; C5, C6:0				C6, C1: 0; C6, C2:0; C6, C3:0 C6, C4:0; C6, C5:0			
Qhyst1 <sub>s</sub>	dB	0				0				0			
Treselection	s	0				0				0			
Sintrasearch	dB	not sent				not sent				not sent			
Sintersearch	dB	not sent				not sent				not sent			
I <sub>oc</sub>	dBm/1,28 MHz	-70											
Propagation Condition		AWGN											

## 8.3.6.2.4.2.2 Procedure

- a) The SS activates cell 1-6 with T1 defined parameters.
- b) The UE is switched on.
- c) A call is set up according to the test procedure specified in TS 34.108 [3] subclause 7.4.2.7.2 to place the UE in the URA\_PCH state on Cell 1 and then the SS waits for this process to complete.
- d) After 15 s from the completion of step c) or the beginning of T1, the parameters are changed as described for T2.
- e) If the UE responds on Cell 1 with a SYNCH-UL sequence in the UpPTS for sending URA UPDATE message cause "change of URA" within 8s, then a success is recorded. After receiving the URA UPDATE message cause "change of URA", the SS shall transmit a URA UPDATE CONFIRM message and then the procedure moves to step g).
- f) If the UE has failed to respond with SYNCH-UL sequence in the UpPTS within the allowed time, a failure is recorded. The SS shall then wait for a total of 15s from the beginning of T2 and if no response is received, the UE shall be switched off and the procedure returns to step a). Otherwise after receiving the URA UPDATE message cause "change of URA", the SS shall transmit a URA UPDATE CONFIRM message and then the procedure continues with step g).
- g) After a total of 15 s from the beginning of T2, the parameters are changed as described for T1.
- h) If the UE responds on Cell 1 with a SYNCH-UL sequence in the UpPTS for sending URA UPDATE message cause "change of URA" within 8s, then a success is recorded and the procedure moves to step j).
- i) Since the UE has failed to respond with SYNCH-UL sequence in the UpPTS within the allowed time, a failure is recorded. The SS shall then wait for a total of 15s from the beginning of T1 and if no response is received the UE shall be switched off and the procedure returns to step a). Otherwise after receiving the URA UPDATE message cause "change of URA", the SS shall transmit a URA UPDATE CONFIRM message and then the procedure continues with step j).
- j) After another 15 s, the UE shall be switched off.
- k) Repeat steps a) to j) until the confidence level according to annex F.6.2 is achieved.

NOTE: The time required for receiving all the relevant system information data according to the reception procedure and the RRC procedure delay of system information blocks defined in 25.331 for a UTRAN cell. Since the maximum repetition period of the relevant system info blocks that needs to be received by the UE to camp on a cell is 1280ms and the maximum RRC procedure delay for reception system information block is 100ms, 1380 ms is assumed in this test case. Therefore this gives a total of 7.78s (Minimum requirement + 100ms), allow 8s in the test case.

## RADIO BEARER SETUP (Step 3)

Information Element	Value/remark
RRC State Indicator	URA PCH
UTRAN DRX cycle length coefficient	7

## 8.3.6.2.4.3 7,68 Mcps TDD option

## 8.3.6.2.4.3.1 Initial conditions

This scenario contains 6 cells operating on the same carrier frequency. The test parameters are given in Tables 8.3.6.2.4.3.1, and 8.3.6.2.4.3.2.



**Table 8.3.6.2.4.3.1: General test parameters for Cell Re-selection single carrier multi-cell case**

Parameter		Unit	Value	Comment
Initial condition	Active cell		Cell1	
	Neighbour cells		Cell2, Cell3, Cell4, Cell5, Cell6	
Final condition	Active cell		Cell2	
HCS			Not used	
UE_TXPWR_MAX_RACH		dBm	21	The value shall be used for all cells in the test.
Qrxlevmin		dBm	-102	The value shall be used for all cells in the test.
Access Service Class (ASC#0) - Persistence value			1	Selected so that no additional delay is caused by the random access procedure. The value shall be used for all cells in the test.
T <sub>SI</sub>		s	1.28	The value shall be used for all cells in the test.
DRX cycle length		s	1.28	The value shall be used for all cells in the test.
T1		s	30	
T2		s	15	

Table 8.3.6.2.4.3.2: Cell re-selection single carrier multi-cell case

Parameter	Unit	Cell 1				Cell 2				Cell 3			
		0		8		0		8		0		8	
Timeslot Number		T1	T2	T1	T2	T1	T2	T1	T2	T1	T2	T1	T2
UTRA RF Channel Number		Channel 1				Channel 2				Channel 1			
PCCPCH_Ec/lor	dB	-3	-3			-3	-3			-3	-3		
SCH_Ec/lor	dB	-9	-9	-9	-9	-9	-9	-9	-9	-9	-9	-9	-9
SCH_toffset		0	0	0	0	5	5	5	5	10	10	10	10
PICH_Ec/lor	dB			-3	-3			-3	-3			-3	-3
OCNS_Ec/lor	dB	-3,12	-3,12	-3,12	-3,12	-3,12	-3,12	-3,12	-3,12	-3,12	-3,12	-3,12	-3,12
$\hat{I}_{or}/I_{oc}$	dB	6	0	6	0	0	6	0	6	-3	-3	-3	-3
PCCPCH RSCP	dBm	-67	-73			-73	-67			-76	-76		
Qoffset1 <sub>s,n</sub>	dB	C1, C2: 0; C1, C3:0; C1,C4:0 C1, C5:0; C1, C6:0				C2, C1: 0; C2, C3:0; C2,C4:0C2, C5:0; C2, C6:0				C3, C1: 0; C3, C2:0; C3,C4:0 C3, C5:0; C3, C6:0			
Qhyst1 <sub>s</sub>	dB	0				0				0			
Treselection	s	0				0				0			
Sintrasearch	dB	not sent				not sent				not sent			
Sintersearch	dB	not sent				not sent				not sent			
		Cell 4				Cell 5				Cell 6			
Timeslot		0		8		0		8		0		8	
UTRA RF Channel Number		Channel 1				Channel 2				Channel 2			
PCCPCH_Ec/lor	dB	-3	-3			-3	-3			-3	-3		
SCH_Ec/lor	dB	-9	-9	-9	-9	-9	-9	-9	-9	-9	-9	-9	-9
SCH_toffset		15	15	15	15	20	20	20	20	25	25	25	25
PICH_Ec/lor	dB			-3	-3			-3	-3			-3	-3
OCNS_Ec/lor	dB	-3,12	-3,12	-3,12	-3,12	-3,12	-3,12	-3,12	-3,12	-3,12	-3,12	-3,12	-3,12
$\hat{I}_{or}/I_{oc}$	dB	-3	-3	-3	-3	-3	-3	-3	-3	-3	-3	-3	-3
PCCPCH RSCP	dBm	-76	-76			-76	-76			-76	-76		
Qoffset1 <sub>s,n</sub>	dB	C4, C1: 0; C4, C2:0; C4,C3:0 C4, C5:0; C4, C6:0				C5, C1: 0; C5, C2:0; C5,C3:0 C5, C4:0; C5, C6:0				C6, C1: 0; C6, C2:0; C6,C3:0 C6, C4:0; C6, C5:0			
Qhyst1 <sub>s</sub>	dB	0				0				0			
Treselection	s	0				0				0			
Sintrasearch	dB	not sent				not sent				not sent			
Sintersearch	dB	not sent				not sent				not sent			
$I_{oc}$	dBm/7,68 MHz	-70											
Propagation Condition		AWGN											

## 8.3.6.2.4.3.2 Procedure

- a) The SS activates cell 1-6 with T1 defined parameters.
- b) The UE is switched on.
- c) A call is set up according to the test procedure specified in TS 34.108 [3] subclause 7.4.2.7.2 to place the UE in the URA\_PCH state on Cell 1 and then the SS waits for this process to complete.
- d) After 15 s from the completion of step c) or the beginning of T1, the parameters are changed as described for T2.
- e) If the UE responds on Cell 1 with a PRACH (URA UPDATE message cause "change of URA") within 8s, then a success is recorded, the SS shall transmit a URA UPDATE CONFIRM message and then the procedure moves to step g).
- f) Since the UE has failed to respond with the correct message within the allowed time, a failure is recorded. The SS shall then wait for a total of 15s from the beginning of T2 and if no response is received, the UE shall be switched off and the procedure returns to step a). Otherwise the SS shall transmit a URA UPDATE CONFIRM message and then the procedure continues with step g).
- g) After a total of 15 s from the beginning of T2, the parameters are changed as described for T1.
- h) If the UE responds on Cell 1 with a PRACH (URA UPDATE message cause "change of URA") within 8s, then a success is recorded and the procedure moves to step j).
- i) Since the UE has failed to respond with the correct message within the allowed time, a failure is recorded. The SS shall then wait for a total of 15s from the beginning of T1 and if no response is received the UE shall be switched off and the procedure returns to step a). Otherwise the SS shall transmit a URA UPDATE CONFIRM message and then the procedure continues with step j).
- j) Repeat steps d) to i) until the confidence level according to annex F.6.2 is achieved..

NOTE: The time required for receiving all the relevant system information data according to the reception procedure and the RRC procedure delay of system information blocks defined in 25.331 for a UTRAN cell. Since the maximum repetition period of the relevant system info blocks that needs to be received by the UE to camp on a cell is 1280ms and the maximum RRC procedure delay for reception system information block is 100ms, 1380 ms is assumed in this test case. Therefore this gives a total of 7.78s (Minimum requirement + 100ms), allow 8s in the test case.

## RADIO BEARER SETUP (Step 3)

Information Element	Value/remark
RRC State Indicator	URA PCH
UTRAN DRX cycle length coefficient	7

## 8.3.6.2.5 Test Requirements

## 8.3.6.2.5.1 3,84 Mcps TDD option

For the test to pass, the total number of successful attempts shall be more than 90% with a confidence level of [FFS]% of the cases.

NOTE: If the above Test Requirement differs from the Minimum Requirement then the Test Tolerance applied for this test is non-zero. The Test Tolerance for this test is defined in clause F.2 and the explanation of how the Minimum Requirement has been relaxed by the Test Tolerance is given in clause F.4.

## 8.3.6.2.5.2 1,28 Mcps TDD option

For the test to pass, the total number of successful attempts shall be more than 90% with a confidence level of 95% of the cases.

NOTE: If the above Test Requirement differs from the Minimum Requirement then the Test Tolerance applied for this test is non-zero. The Test Tolerance for this test is defined in clause F.2 and the explanation of how the Minimum Requirement has been relaxed by the Test Tolerance is given in clause F.4.

### 8.3.6.2.5.3 7,68 Mcps TDD option

For the test to pass, the total number of successful attempts shall be more than 90% with a confidence level of 95% of the cases.

NOTE: If the above Test Requirement differs from the Minimum Requirement then the Test Tolerance applied for this test is non-zero. The Test Tolerance for this test is defined in clause F.2 and the explanation of how the Minimum Requirement has been relaxed by the Test Tolerance is given in clause F.4.8.4 RRC Connection Control

## 8.3.7 Serving HS-DSCH cell change

### 8.3.7.1 3.84 Mcps option (duplication)

Void.

### 8.3.7.2 1.28 Mcps option

#### 8.3.7.2.1 Definition and applicability

When the UE receives a RRC message implying HS-DSCH cell change with the activation time "now" or earlier than RRC procedure delay seconds from the end of the last TTI containing the RRC command, the UE shall be ready to receive the HS-SCCH channel from the new cell within  $T_{\text{cell\_change}}$  seconds from the end of the last TTI containing the RRC command.

The requirements and this test apply to the 1,28 Mcps TDD UE of release 5 and later supporting HSDPA.

#### 8.3.7.2.2 Minimum requirement

The UE shall also be able to start to receive the first HS-SCCH message from cell 2 less than 82 ms from the beginning of time period T3 and transmit the ACK or NAK which corresponds to the HS-SCCH message.

NOTE: The delay  $T_{\text{Dell change}} = T_{\text{RRC}} + T_{\text{handover}} + T_{\text{UIDISync}} + T_{\text{hs-ich/hs-scchInterval}} = 80 + 0 + 80 + 15 = 175\text{ms}$ . The RRC procedure delay  $T_{\text{RRC}}$  is defined in TS25.331 Section 13.5.2

#### 8.3.7.2.3 Test purpose

The purpose of this test is to verify the requirement for the delay when performing the serving HS-DSCH cell change in CELL\_DCH state.

#### 8.3.7.2.4 Method of test

##### 8.3.7.2.4.1 Initial conditions

Test environment: normal; see clauses G.2.1 and G.2.2.

Frequencies to be tested: mid range; see clause G.2.4.

The test parameters are given in Table 8.3.7.2-1, 8.3.7.2-2. The test consists of 3 successive time periods, with a time duration of T1, T2 and T3 respectively. At the start of time duration T1 the UE have cell 1 in active set and cell 1 as the serving HS-DSCH cell.

Table 8.3.7.2-1: General test parameters for serving HS-DSCH cell change

Parameter	Unit	Value	Comment
DCH parameters		DL and UL Reference Measurement Channel 12.2 kbps	As specified in TS 25.102 clause A.2.2.2 and A.2.1.2
Power Control		On	
Target quality value on DTCH	<b>BLER</b>	0.01	
HSDPA parameters		with QPSK modulation	TBD
Initial conditions	Active cell	Cell 1	Initial conditions
	Serving HS-DSCH cell	Cell 1	
Final condition	Active cell	Cell 2	Final condition
	Serving HS-DSCH cell	Cell 2	
O	dB	0	Cell individual offset. This value shall be used for all cells in the test.
Hysteresis	dB	0	
Time to Trigger	ms	0	
Filter coefficient		0	
Monitored cell list size		6 TD-SCDMA neighbours on Channel 1	
T1	s	5	
T2	s	5	
T3	s	5	

Table 8.3.7.2-2: Cell specific test parameters for serving HS-DSCH cell change, initial conditions

Parameter	Unit	Cell 1								
		0			DwPTS			5		
Timeslot Number		T1	T2	T3	T1	T2	T3	T1	T2	T3
UTRA RF Channel Number		Channel 1 (Note3)								
PCCPCH_Ec/lor	dB	-3						n.a.		
DwPCH_Ec/lor		n.a.			-3			n.a.		
DPCH_Ec/lor	dB	n.a.			n.a.			Note1		
HS-PDSCH_Ec/lor	dB	n.a.			n.a.			-1	-inf	
HS-SCCH_Ec/lor	dB	n.a.			n.a.			-4	-inf	
$\frac{DPCH_o - E_c}{I_{or}}$	dB	-3			n.a.			Note2		
$\hat{I}_{or}/I_{oc}$	dB	10	7		10	7		10	7	
$I_{oc}$	dBm/1.2 8MHz	-70								
PCCPCH_RSCP	dBm	-63	-66		n.a.			n.a.		
Propagation Condition		AWGN								
Parameter	Unit	Cell 2								
Timeslot Number		0			DwPTS			5		
		T1	T2	T3	T1	T2	T3	T1	T2	T3
UTRA RF Channel Number		Channel 1 (Note3)								
PCCPCH_Ec/lor	dB	-3						n.a.		
DwPCH_Ec/lor		n.a.			-3			n.a.		
DPCH_Ec/lor	dB	n.a.			n.a.			Note1		
HS-PDSCH_Ec/lor	dB	-inf.		-1	n.a.			-inf.	-1	
HS-SCCH_Ec/lor	dB	-inf.		-4	n.a.			-inf.	-4	
$\frac{DPCH_o - E_c}{I_{or}}$	dB	-3			n.a.			Note2		
$\hat{I}_{or}/I_{oc}$	dB	7	10		7	10		7	10	
$I_{oc}$	dBm/1.2 8MHz	-70								
PCCPCH_RSCP	dBm	-66	-63		n.a.			n.a.		
Propagation Condition		AWGN								
Note1: The DPCH level is controlled by the power control loop										
Note2: The power of the OCNS channel that is added shall make the total power from the cell to be equal to I <sub>or</sub> .										
Note3: In the multi-carrier networks, UTRA RF Channel Number is the main carrier channel number.										

## 8.3.7.2.4.2 Procedure

- The SS activates cell 1-2 with T1 defined parameters and monitors cell 1 and 2 for SYNCH-UL sequence in the UpPTS for sending for RRC CONNECTION REQUEST messages from the UE.
- The UE is switched on.
- Establish the HSDPA call according to the 3GPP TS 34.108 7.3.6 requirement and set Cell1 as the current service HS-DSCH cell.
- SS shall send a MEASUREMENT CONTROL message (event 1G)
- After 5 s, the parameters are changed as described for T2.
- During time period T2, UE shall transmit a MEASUREMENT REPORT message (intra frequency) triggered by event 1G for cell 2.
- SS shall transmit a PHYSICAL CHANNEL RECONFIGURATION message (cell 2 HS-DSCH serving cell) with activation time set to "now" changing serving HS-DSCH from cell 1 to cell 2.

- h) After 5 s, the parameters are changed as described for T3. SS immediately start transmitting HSDPA Data on cell 2. The SS shall not send any HSDPA data on cell 1 after the start of T3.
- i) SS shall measure the time from start of T3 until the start of the HS-SICH subframe where the UE starts transmitting ACK/NACK on cell 2
- j) If steps i fulfill the test requirements, then the number of successful tests is increased by one.
- k) The UE shall transmit a PHYSICAL CHANNEL RECONFIGURATION COMPLETE message on the UL DCCH of cell 2.
- l) The UE is switched off. After 5s, repeat step a-k until the confidence level according to annex F.6.2 is achieved

#### 8.3.7.2.5 Test Requirements

For the test to pass, the total number of successful tests shall be more than 90% with a confidence level of 95% of the cases.

##### Specific Message Contents

All messages indicated above shall use the same content as described in the default message content in clause 9 of 34.108, with the following exceptions:

## MEASUREMENT CONTROL message (Step d)

Information Element/Group name	Value/Remark
Message Type (10.2.17)	
<b>UE information elements</b>	
-RRC transaction identifier	0
-Integrity check info	Not Present
<b>Measurement Information elements</b>	
-Measurement Identity	1
-Measurement Command (10.3.7.46)	Modify
-CHOICE <i>Measurement type</i>	Intra-frequency measurement
-Intra-frequency measurement (10.3.7.36)	
-Intra-frequency measurement objects list (10.3.7.33)	Not Present
-Intra-frequency measurement quantity (10.3.7.38)	
-Filter coefficient (10.3.7.9)	0
-CHOICE <i>mode</i>	TD-SCDMA
-Measurement quantity list	1
-Measurement quantity	Primary CCPCH
-Intra-frequency reporting quantity (10.3.7.41)	
-Reporting quantities for active set cells (10.3.7.5)	
-SFN-SFN observed time difference reporting indicator	No report
-Cell synchronisation information reporting indicator	FALSE
-Cell Identity reporting indicator	TRUE
-CHOICE <i>mode</i>	TD-SCDMA
-Timeslot ISCP reporting indicator	FALSE
-Proposed TGSN Reporting Required	FALSE
-Primary CCPCH RSCP reporting indicator	TRUE
-Pathloss reporting indicator	FALSE
-Reporting quantities for monitored set cells (10.3.7.5)	
-SFN-SFN observed time difference reporting indicator	No report
-Cell synchronisation information reporting indicator	FALSE
-Cell Identity reporting indicator	TRUE
-CHOICE <i>mode</i>	TD-SCDMA
-Timeslot ISCP reporting indicator	FALSE
-Proposed TGSN reporting required	FALSE
-Primary CCPCH RSCP reporting indicator	TRUE
-Pathloss reporting indicator	FALSE
-Reporting quantities for detected set cells (10.3.7.5)	Not Present
-Measurement validity (10.3.7.51)	Not Present
-CHOICE <i>report criteria</i>	Intra-frequency measurement reporting criteria
-Intra-frequency measurement reporting criteria (10.3.7.39)	
-Parameters required for each event	1
-Intra-frequency event identity	Event 1G
-Hysteresis	0 dB
-Time to trigger	0 ms
-Reporting cell status	
-CHOICE <i>reported cell</i>	Report all active set cells + cells within monitored set on used frequency
-Maximum number of reported cells	2
-Measurement reporting mode	
-Measurement Report Transfer Mode	Acknowledged mode RLC
-Periodical Reporting / Event Trigger Reporting Mode	Event trigger
-Additional measurements list (10.3.7.1)	Not Present
<b>Physical channel information elements</b>	
-DPCH compressed mode status info (10.3.6.34)	Not Present
Information Element/Group name	Value/Remark
Message Type (10.2.17)	
<b>UE information elements</b>	
-RRC transaction identifier	0
-Integrity check info	Not Present
<b>Measurement Information elements</b>	
-Measurement Identity	1
-Measurement Command (10.3.7.46)	Modify
-CHOICE <i>Measurement type</i>	Intra-frequency measurement
-Intra-frequency measurement (10.3.7.36)	
-Intra-frequency measurement objects list (10.3.7.33)	Not Present
-Intra-frequency measurement quantity (10.3.7.38)	



Information Element/Group name	Value/Remark
-Filter coefficient (10.3.7.9)	0
-CHOICE <i>mode</i>	TD-SCDMA
-Measurement quantity list	1
-Measurement quantity	Primary CCPCH
-Intra-frequency reporting quantity (10.3.7.41)	
-Reporting quantities for active set cells (10.3.7.5)	
-SFN-SFN observed time difference reporting indicator	No report
-Cell synchronisation information reporting indicator	FALSE
-Cell Identity reporting indicator	TRUE
-CHOICE <i>mode</i>	TD-SCDMA
-Timeslot ISCP reporting indicator	

PHYSICAL CHANNEL RECONFIGURATION message (Setp g):

Information Element	Value/Remark
Message Type	
<b>UE Information Elements</b>	
-RRC transaction identifier	0
-Integrity check info	Not Present
-Integrity protection mode info	Not Present
-Ciphering mode info	Not Present
-Activation time	now
-New U-RNTI	Not Present
-New C-RNTI	Not Present
-New DSCH_RNTI	Not Present
-New H_RNTI	'0000000000000000'
-New Primary E_RNTI	Not Present
-New Secondary E_RNTI	Not Present
-RRC State Indicator	CELL_DCH
-UTRAN DRX cycle length coefficient	Not Present
<b>CN Information Elements</b>	
-CN Information info	Not Present
<b>UTRAN mobility information elements</b>	
-URA identity	Not Present
<b>RB information elements</b>	
-Downlink counter synchronisation info	Not Present
-RB with PDCP information list	Not Present
-RB with PDCP information	Not Present
- PDCP context relocation info	Not Present
<b>Downlink transport channels</b>	
- HARQ Info(10.3.5.7a)	
-Number of Processes	4
-CHOICE <i>Memory Partitioning</i>	
- Implicit	NULL
<b>PhyCH information elements</b>	
-Frequency info (10.3.6.36)	
-CHOICE <i>mode</i>	TD-SCDMA
-UARFCN (Nt)	Same UARFCN as used for cell 2
<b>Uplink radio resources</b>	
-Maximum allowed UL TX power	30 dBm
-CHOICE <i>channel requirement</i>	Uplink DPCH info
-Uplink DPCH info (10.3.6.88)	
-Uplink DPCH power control info (10.3.6.91)	
-CHOICE <i>mode</i>	TD-SCDMA
-CHOICE <i>TD-SCDMA option</i>	TD-SCDMA
-UL target SIR	
-CHOICE <i>UL OL PC info</i>	Individually signalled
-CHOICE <i>TD-SCDMA option</i>	TD-SCDMA
-TPC step size	1
-Primary CCPCH Tx Power	-80dBm
-UL Timeslot Interference	-90 dBm
-CHOICE <i>mode</i>	TD-SCDMA
-Uplink timing advance control (10.3.6.96)	
-CHOICE <i>Timing Advance</i>	Disabled
-UL CCTrCH list	1
-TFCS ID	1
-UL Target SIR	TBD dB
-Time Info (10.3.6.83)	
-Activation Time	now
-Duration	Infinite
-Common timeslot info	Not Present
-Uplink DPCH timeslots and codes LCR (10.3.6.94)	
-Dynamic SF Usage	False
-First individual timeslot info (10.3.6.37)	
-Timeslot Number (10.3.6.84)	
-CHOICE <i>TD-SCDMA option</i>	1.28 Mcps
-Timeslot number	1
-TFCI existence	True
-Midamble shift and burst type (10.3.6.41)	

Information Element	Value/Remark
-Choice <i>TD-SCDMA option</i>	1.28 Mcps
-Modulation	QPSK
-Midamble Allocation Mode	Default
-Midamble configuration	4
-Midamble shift	Not present
-CHOICE <i>TD-SCDMA option</i>	1.28 Mcps
-Modulation	QPSK
- SS-TPC Symbols	1
-Additional TPC-SS Symbols	Not present
-First timeslot code list	1
-Channelisation code	16/1
-Choice more timeslots	No more timeslots
<b>Downlink radio resources</b>	
-Downlink HS-PDSCH Information(10.3.6.23a)	
-HS-SCCH Info(10.3.6.36a)	
- HS-SCCH Set Configuration	
- Timeslot number	6
- First Channelisation code	16/15
- Second Channelisation code	16/16
- Midamble Allocation mode	Default
- Midamble Shift	Not present
- Midamble configuration	4
- BLER target	
- HS-SICH configuration	
- Timeslot number	1
- Channelisation code	16/3
- Midamble Allocation mode	Default
- Midamble Shift	Not present
- Midamble configuration	8
- Ack-Nack Power Offset	Not Present
- PRX <sub>HS-SICH</sub>	TBD
- TPC step size	1
-CHOICE <i>mode</i>	TD-SCDMA
-Downlink information common for all radio links (10.3.6.24)	
-Downlink DPCH info common for all RL (10.3.6.18)	
-Timing indicator	Initialise
-CFN-targetSFN frame offset	Not Present
-Downlink DPCH power control information (10.3.6.23)	
-CHOICE <i>mode</i>	TD-SCDMA
-TPC Step size	1 dB
-CHOICE <i>mode</i>	TD-SCDMA
-CHOICE <i>mode</i>	TD-SCDMA
-CHOICE <i>TD-SCDMA option</i>	1.28 Mcps
-tstd_indicator	FALSE
-Default DPCH Offset Value (10.3.6.16)	0
-Downlink information per radio link list	1
-Downlink information for each radio link (10.3.6.27)	
-CHOICE <i>mode</i>	TD-SCDMA
-Primary CCPCCH info (10.3.6.57)	
-CHOICE <i>mode</i>	TD-SCDMA
-CHOICE <i>TD-SCDMA option</i>	1.28 Mcps
<i>TSTD indicator</i>	TRUE
-Cell parameters ID	0
-SCTD indicator	False
-Downlink DPCH info for each RL (10.3.6.21)	
-CHOICE <i>mode</i>	TD-SCDMA
-DL CCTrCH list	1
-TFCS ID	Not Present
-Time Info (10.3.6.83)	
-Activation Time	now
-Duration	Infinite
-Common timeslot info	Not Present
-Downlink DPCH timeslots and codes (10.3.6.32)	
-First individual timeslot info (10.3.6.37)	
-Timeslot Number (10.3.6.84)	
-CHOICE <i>TD-SCDMA option</i>	1.28 Mcps
-Timeslot number	5

Information Element	Value/Remark
-TFCI existence	True
-Midamble shift and burst type (10.3.6.41)	
-CHOICE <i>TD-SCDMA option</i>	1.28 Mcps
-Midamble Allocation Mode	Default
-Midamble configuration	4
-Midamble shift	Not present
-CHOICE <i>TD-SCDMA option</i>	1.28 Mcps
-Modulation	QPSK
-SS-TPC Symbols	
-Additional TPC-SS Symbols	
-First timeslot channelisation codes (10.3.6.17)	
-CHOICE <i>codes representation</i>	Consecutive codes
-First channelisation code	16/1
-Last channelisation code	16/1
-CHOICE <i>more timeslots</i>	No more timeslots
-SCCPCH information for FACH (10.3.6.70)	Not Present

### 8.3.7.3 7.68 Mcps option

Void.

## 8.3.8 Inter-RAT cell change order from UTRAN TDD to GSM(GPRS)

### 8.3.8.1 Definition and applicability

#### 8.3.8.1.1 3,84 Mcps option

Void.

#### 8.3.8.1.2 1,28 Mcps option

The UTRAN to GPRS cell change order procedure delay is defined as the time from the end of the last TTI containing CELL CHANGE ORDER FROM UTRAN message to the transmission on the channel of GPRS.

The requirements and this test apply to the combined TDD 1.28Mcps and GPRS UE.

#### 8.3.8.1.3 7,68 Mcps option

Void.

### 8.3.8.2 Minimum requirement

#### 8.3.8.2.1 3,84 Mcps option

Void.

#### 8.3.8.2.2 1,28 Mcps option

The UE shall begin to transmit on the new RACH of the target cell less than  $190\text{ms} + T_{\text{BCCH}} + T_{\text{RA}}$  from the beginning of time period T3. The rate of correct handovers observed during repeated tests shall be at least 90% with a confidence level of 95 %.

NOTE: The test requirement in this case is expressed as:

$$T_{\text{CCO delay}} = 190\text{ms} + T_{\text{BCCH}} + T_{\text{RA}} \text{ or}$$

$$T_{\text{CCO delay}} = 90\text{ms} + T_{\text{BCCH}} + T_{\text{RA}}$$

190ms: delay switch from UTRAN to GSM when UE has not synchronised to the GSM cell before the CELL CHANGE ORDER FROM UTRAN is received.

90ms: delay switch from UTRAN to GSM when UE has synchronised to the GSM cell before the CELL CHANGE ORDER FROM UTRAN is received.

$T_{\text{BCCH}}$  is the maximum time allowed to read BCCH data from GSM cell. According to TS 45.002, the maximum time allowed to read the BCCH data, when being synchronized to a BCCH carrier, is 7.6s (in order to read System Information type 13).

$T_{\text{RA}}$  The additional delay caused by the random access procedure in the GSM cell, is 10 ms (2 GSM radio frames).

#### 8.3.8.2.3 7,68 Mcps option

Void.

#### 8.3.8.3 Test Purpose

##### 8.3.8.3.1 3,84 Mcps option

Void.

##### 8.3.8.3.2 1,28 Mcps option

To verify that the UE meets the minimum requirement.

##### 8.3.8.3.3 7,68 Mcps option

Void.

#### 8.3.8.4 Method of test

##### 8.3.8.4.1 3,84 Mcps option

Void.

##### 8.3.8.4.2 1,28 Mcps option

###### 8.3.8.4.2.1 Initial conditions

The test parameters are given in Table 8.3.8.2, Table 8.3.8.3, and Table 8.3.8.4.

The SS starts the UTRAN cell and brings the UE into PS-DCCH+DTCH\_DCH. The SS starts GPRS cell, then sends CELL CHANGE ORDER FROM UTRAN indicating the target cell description, GPRS cell, to the UE through DCCH of the serving UTRAN cell. After the UE receives the command it shall configure itself accordingly and switch to the new channel on the target GPRS cell. The SS checks whether the cell change is performed by checking that the SS receives a successful CHANNEL REQUEST message from the UE through GPRS cell. The test consists of three successive time periods, with a time duration of T1, T2 and T3 respectively. The UTRAN shall send CELL CHANGE ORDER FROM UTRAN message. The start of T3 is defined as the end of the last TTI containing the CELL CHANGE ORDER FROM UTRAN.

**Table 8.3.8.2: General test parameters for Correct reporting of UTRAN neighbours in AWGN propagation condition**

Parameter	Unit	Value	Comments
DCH parameters		DL Reference Measurement Channel 12.2 kbps	As specified in TS 34.122 clause C2.2
Power Control		On	
Target quality value on DTCH	BLER	0.01	
Initial conditions	Active cell	Cell 1	UTRAN TDD cell
	Neighbour cell	Cell 2	GSM cell
Final condition	Active cell	Cell 2	GSM cell
Inter-RAT measurement quantity		GSM Carrier RSSI	
Hysteresis	dB	0	
Time to Trigger	ms	0	
Filter coefficient		0	
Monitored cell list size	s	12 TD-SCDMA neighbours on Channel 1 6 GSM neighbours including ARFCN 1	Measurement control information is sent before the start of time period T1.
Tidentify abort	s	5	
Treconfirm abort	s	5	
T1	s	10	
T2	s	10	
T3	s	10	

**Table 8.3.8.3: Cell Specific Parameters for UTRAN to GPRS cell change order cell case (cell 1)**

Parameter	Unit	Cell 1					
		T1	T2	T3	T1	T2	T3
DL timeslot number		0			DwPTS		
UTRA RF Channel Number		Channel 1					
PCCPCH_Ec/lor	dB	-3			0		
DwPCH_Ec/lor	dB				0		
OCNS_Ec/lor	dB	-3					
$\hat{I}_{or}/I_{oc}$	dB	5			5		
$I_{oc}$	dBm/1.28 MHz	-70					
Propagation Condition		AWGN					

**Table 8.3.8.4: Cell Specific Parameters for UTRAN to GPRS cell change order cell case (cell 2)**

Parameter	Unit	Cell 2	
		T1	T2, T3
Absolute RF Channel Number		ARFCN 1	
RXLEV	dBm	-85	-75

## 8.3.8.4.2.2 Procedure

- 1) The RF parameters for cell 1 are set up according to T1.

- 2) The UE is switched on.
- 3) SS brings the UE into PS-DCCH+DTCH\_DCH.
- 4) Activates cell 2, the RF parameters for cell 2 are set up according to T1 with GPRS enabled.
- 5) After 10 seconds, the SS shall switch the power settings from T1 to T2.
- 6) SS sends CELL CHANGE ORDER FROM UTRAN message indicates: the target cell description for GPRS.  
The start of T3 is defined as the end of the last TTI containint the CELL CHANGE ORDER FROM UTRAN.
- 7) The SS shall switch the power settings from T2 to T3.
- 8) UE shall send CHANNEL REQUEST message through cell B. If UE sends message on RACH of the target cell less than 7.8s from the beginning of time period T3 then the number of successful tests is increased by one.
- 9) At the end of T3 UE is switched off.
- 10) Repeat step 1-9 until the confidence level according to annex F.6.2A is achieved.

#### Specific message contents

All messages indicated above shall use the same content as described in the default message content in clause 9 or clause 6 of 34.108, with the following exceptions:

#### SYSTEM INFORMATION BLOCK TYPE 1:

Information element	Value/remark
T309	8 s

#### CELL CHANGE ORDER FROM UTRAN:

Information Element	Value/remark
Message Type	Arbitrarily selects one integer between 0 to 3
RRC transaction identifier	
Integrity check info	SS calculates the value of MAC-I for this message and writes to this IE. SS provides the value of this IE, from its internal counter.
- Message authentication code	
- RRC Message sequence number	Now
Activation time	BSIC of Cell 2
Target cell description	
- CHOICE Radio Access Technology	Set to "GSM/ PCS 1900" if GSM/ PCS 1900 is used in this test. Otherwise set to "GSM/DCS 1800 Band"
- GSM	
- BSIC	Allocated BCCH ARFCN of Cell 2
- Band Indicator	
- BCCH ARFCN	NOT PRESENT
- NC mode	

8.3.8.4.3 7,68 Mcps option

Void.

8.3.8.5 Test requirement

8.3.8.5.1 3,84 Mcps option

Void.

8.3.8.5.2 1,28 Mcps option

The Cell Change Order procedure delay should less than 7.8s.

For the test to pass, the total number of successful tests shall be more than 90% of the cases with a confidence level of 95 %.

NOTE: If the above Test Requirement differs from the Minimum Requirement then the Test Tolerance applied for this test is non-zero. The Test Tolerance for this test is defined in clause F.2 and the explanation of how the Minimum Requirement has been relaxed by the Test Tolerance is given in clause F.4.

### 8.3.8.5.3 7,68 Mcps option

Void.

## 8.4.1 RRC re-establishment delay

### 8.4.1.1 3,84 Mcps TDD option

#### 8.4.1.1.1 RRC re-establishment delay to a known target cell

##### 8.4.1.1.1.1 Definition and applicability

For UTRA TDD, the UE re-establishment delay  $T_{UE-RE-ESTABLISH-REQ}$  is defined as the time between the moment when radio link failure is considered by the UE to when the UE starts sending the RRC CELL UPDATE message to the UTRAN on RACH.

$T_{UE-RE-ESTABLISH-REQ}$  is depending on whether the target cell is known by the UE or not. A cell is known if either or both of the following conditions are true:

- the UE has had a radio link connected to the cell during the last 5 seconds
- the cell has been measured by the UE during the last 5 seconds.

The requirements of this test apply to the TDD (3,84 Mcps option) UE.

##### 8.4.1.1.1.2 Minimum requirement

The RRC re-establishment delay  $T_{RE-ESTABLISH}$  to a known target cell shall be less than 2 s.

The rate of successful RRC re-establishments observed during repeated tests shall be at least 90%.

NOTE: The RRC re-establishment delay in this test case can be expressed as,

$$T_{RE-ESTABLISH} = T_{RRC-RE-ESTABLISH} + T_{UE-RE-ESTABLISH-REQ-KNOWN}$$

where,

$$T_{RRC-RE-ESTABLISH} = 160\text{ms} + (N_{313} - 1) * 10\text{ms} + T_{313}$$

$$T_{UE-RE-ESTABLISH-REQ-KNOWN} = 50\text{ms} + T_{SEARCH-KNOWN} + T_{SI} + T_{RA}$$

and,

$N_{313}$  Equal to 20 and therefore resulting in 200 ms delay.

$T_{313}$  Equal to 0 s.

$T_{SEARCH-KNOWN}$  Equal to 100 ms

$T_{SI}$  Equal to 1280 ms, the time required for receiving all the relevant system information data according to the reception procedure and the RRC procedure performance value of system information blocks defined in TS 25.331 [9] for a UTRAN cell.

$T_{RA}$  Equal to 40 ms, the additional delay caused by the random access procedure.

This gives a total of 1820ms, allow 2 s in the test case.

##### 8.4.1.1.1.3 Test purpose

The test purpose is to verify that the RRC re-establishment delay to a known target cell is within the specified limits.



8.4.1.1.1.4 Method of test

8.4.1.1.1.4.1 Initial conditions

Test environment: normal; see clauses G.2.1 and G.2.2.

Frequencies to be tested: mid range; see clause G.2.4.

The test parameters are given in table 8.4.1.1 and table 8.4.1.2 below. The maximum repetition period of the relevant system info blocks that needs to be received by the UE in order to camp on a cell shall be 1280 ms. DRX cycle length shall be 1280ms. In the measurement control information it is indicated to the UE that periodic reporting shall be used. The test consists of 2 successive time periods, with time durations of T1 and T2 respectively.

During T1, the DL DPCH in cell 1 shall be transmitted in timeslot 2 and the UL DPCH in cell 1 shall be transmitted in timeslot 10. At the beginning of time period T2, the DPCH shall be removed.

Cell 1 and cell shall be synchronised, i.e. share the same frame and timeslot timing.

**Table 8.4.1.1: General test parameters for RRC re-establishment delay, known target cell case**

Parameter		Unit	Value	Comment
DCH parameters			DL reference measurement channel 12.2 kbps	As specified in TS 25.102 section A.2.2
Power Control			On	
Target quality value on DTCH		BLER	0.01	
Initial conditions	Active cell		Cell 1	Cell 2 shall be included in the monitored set in Cell 1.
	Neighbour cell		Cell 2	
Final conditions	Active cell		Cell 2	
Access Service Class (ASC#0) - Persistence value		-	1	Selected so that no additional delay is caused by the random access procedure. The value shall be used for all cells in the test.
N313			20	
N315			1	
T313		Seconds	0	
T <sub>SI</sub>		ms	1280	
Monitored cell list size			24 TDD neighbours on Channel 1	
Reporting frequency		Seconds	4	
T1			10	
T2			6	

**Table 8.4.1.2: Cell specific parameters for RRC re-establishment delay test, known target cell case**

Parameter	Unit	Cell 1				Cell 2			
		0		8		0		8	
Timeslot Number		T1	T2	T1	T2	T1	T2	T1	T2
UTRA RF Channel Number		Channel 1				Channel 1			
PCCPCH_Ec/I <sub>or</sub>	dB	-3	-3	n.a.	n.a.	-3	-3	n.a.	n.a.
SCH_Ec/I <sub>or</sub>	dB	-9	-9	-9	-9	-9	-9	-9	-9
SCH_t <sub>offset</sub>		0	0	0	0	15	15	15	15
PICH_Ec/I <sub>or</sub>	dB	n.a.	n.a.	-3	-3	n.a.	n.a.	-3	-3
OCNS_Ec/I <sub>or</sub>	dB	-3,12	-3,12	-3,12	-3,12	-3,12	-3,12	-3,12	-3,12
$\hat{I}_{or}/I_{oc}$	dB	3	-13	3	-13	5	5	5	5
$I_{oc}$	dBm/ 3,84 MHz	-70							
P-CCPCH_RSCP	dB	-70	-86	n.a.	n.a.	-68	-68	n.a.	n.a.
Propagation Condition		AWGN							

#### 8.4.1.1.1.4.2 Procedure

- 1) The RF parameters are set up according to T1.
- 2) The UE is switched on.
- 3) A call is set up according to the test procedure specified in TS 34.108 [3] subclause 7.3.4.  
[Editor's note: subclause 7.3.4 in TS 34.108 [3] (Message sequence chart for Handover Test procedure) is not yet specified.
- 4) The SS waits for random access requests from the UE on cell 2.
- 5) 10 s after step3 has completed, the parameters are changed to that as described for T2.
- 6) If the UE responds on cell 2 within 2.0 s from the beginning of time period T2 with a CELL\_UPDATE command then the number of successful tests is increased by one.
- 7) SS shall transmit a RRC CONNECTION RELEASE message to make the UE transit to idle mode.
- 8) After 6 seconds from the beginning of time period T2, the RF parameters are set up according to T1.
- 9) The SS shall wait for 30s to make the UE complete cell reselection to cell1.
- 10) Repeat step 3-9 [TBD] times.

NOTE: The time required for receiving all the relevant system information data according to the reception procedure and the RRC procedure delay of system information blocks defined in TS 25.331 [9] for a UTRAN cell. Since the maximum repetition period of the relevant system info blocks that needs to be received by the UE to camp on a cell is 1280ms and the maximum RRC procedure delay for reception system information block is 100ms, 1380 ms is assumed in this test case. Therefore this gives a total of 1920ms (Minimum requirement + 100ms), allow 2 s in the test case.

#### 8.4.1.1.1.5 Test requirements

For the test to pass, the total number of successful tests shall be more than 90% with a confidence level of [FFS]% of the cases.

NOTE: If the above Test Requirement differs from the Minimum Requirement then the Test Tolerance applied for this test is non-zero. The Test Tolerance for this test is defined in clause F.2 and the explanation of how the Minimum Requirement has been relaxed by the Test Tolerance is given in clause F.4.

#### 8.4.1.1.2 RRC re-establishment delay to an unknown target cell

##### 8.4.1.1.2.1 Definition and applicability

For UTRA TDD, the UE re-establishment delay  $T_{UE-RE-ESTABLISH-REQ}$  is defined as the time between the moment when radio link failure is considered by the UE to when the UE starts sending the RRC CELL UPDATE message to the UTRAN on RACH.

$T_{UE-RE-ESTABLISH-REQ}$  is depending on whether the target cell is known by the UE or not. A cell is known if either or both of the following conditions are true:

- the UE has had a radio link connected to the cell during the last 5 seconds
- the cell has been measured by the UE during the last 5 seconds.

The requirements of this test apply to the TDD (3,84 Mcps option) UE.

##### 8.4.1.1.2.2 Minimum requirement

The RRC re-establishment delay  $T_{RE-ESTABLISH}$  to an unknown target cell shall be less than 3,7 s.

The rate of successful RRC re-establishments observed during repeated tests shall be at least 90%.

NOTE: The RRC re-establishment delay in this test case can be expressed as,

$$T_{\text{RE-ESTABLISH}} = T_{\text{RRC-RE-ESTABLISH}} + T_{\text{UE-RE-ESTABLISH-REQ-UNKNOWN}}$$

where,

$$T_{\text{RRC-RE-ESTABLISH}} = 160\text{ms} + (N_{313} - 1) * 10\text{ms} + T_{313}$$

$$T_{\text{UE-RE-ESTABLISH-REQ-KNOWN}} = 50\text{ms} + T_{\text{SEARCH-UNKNOWN}} * \text{NF} + T_{\text{SI}} + T_{\text{RA}},$$

and,

$N_{313}$  Equal to 20 and therefore resulting in 200 ms delay.

$T_{313}$  Equal to 0 s.

$T_{\text{SEARCH-UNKNOWN}}$  Equal to 800 ms

$\text{NF}$  Equal to 2, the number of different frequencies in the monitored set of cell 1.

$T_{\text{SI}}$  Equal to 1280 ms, the time required for receiving all the relevant system information data according to the reception procedure and the RRC procedure performance value of system information blocks defined in TS 25.331 [9] for a UTRAN cell.

$T_{\text{RA}}$  Equal to 40 ms, the additional delay caused by the random access procedure.

This gives a total of 3320ms, allow 3,7 s in the test case.

#### 8.4.1.1.2.3 Test purpose

The test purpose is to verify that the RRC re-establishment delay to an unknown target cell is within the specified limits.

#### 8.4.1.1.2.4 Method of test

##### 8.4.1.1.2.4.1 Initial conditions

Test environment: normal; see clauses G.2.1 and G.2.2.

Frequencies to be tested: mid range; see clause G.2.4.

The test parameters are given in table 8.4.1.3 and table 8.4.1.4 below. The maximum repetition period of the relevant system info blocks that needs to be received by the UE in order to camp on a cell shall be 1280 ms. DRX cycle length shall be 1280ms. In the measurement control information it is indicated to the UE that periodic reporting shall be used. The test consists of 2 successive time periods, with time durations of T1 and T2 respectively.

During T1, the DL DPCH in cell 1 shall be transmitted in timeslot 2 and the UL DPCH in cell 1 shall be transmitted in timeslot 10. At the beginning of time period T2, the DPCH shall be removed.

Cell 1 and cell shall be synchronised, i.e. share the same frame and timeslot timing.

**Table 8.4.1.3: General test parameters for RRC re-establishment delay, unknown target cell case**

Parameter		Unit	Value	Comment
DCH parameters			DL reference measurement channel 12.2 kbps	As specified in TS 25.102 section A.2.2
Power Control			On	
Target quality value on DTCH		BLER	0.01	
Initial conditions	Active cell		Cell 1	Cell 2 shall not be included in the monitored set in Cell 1.
	Neighbour cell		Cell 2	
Final conditions	Active cell		Cell 2	
Access Service Class (ASC#0) - Persistence value		-	1	Selected so that no additional delay is caused by the random access procedure. The value shall be used for all cells in the test.
N313			20	
N315			1	
T313		Seconds	0	
T <sub>SI</sub>		ms	1280	
Monitored cell list size			16 TDD neighbours on Channel 1 16 TDD neighbours on Channel 2	
Reporting frequency		Seconds	4	
T1			10	
T2			6	

**Table 8.4.1.4: Cell specific parameters for RRC re-establishment delay test, unknown target cell case**

Parameter	Unit	Cell 1				Cell 2			
		0		8		0		8	
Timeslot Number		T1	T2	T1	T2	T1	T2	T1	T2
UTRA RF Channel Number		Channel 1				Channel 2			
PCCPCH_Ec/lor	dB	-3	-3	n.a.	n.a.	-3	-3	n.a.	n.a.
SCH_Ec/lor	dB	-9	-9	-9	-9	-9	-9	-9	-9
SCH <sub>offset</sub>		0	0	0	0	15	15	15	15
PICH_Ec/lor	dB	n.a.	n.a.	-3	-3	n.a.	n.a.	-3	-3
OCNS_Ec/lor	dB	-3,12	-3,12	-3,12	-3,12	-3,12	-3,12	-3,12	-3,12
$\hat{I}_{or}/I_{oc}$	dB	3	-13	3	-13	5	5	5	5
$I_{oc}$	dBm/ 3,84 MHz	-70							
P-CCPCH_RSCP	dB	-70	-86	n.a.	n.a.	-68	-68	n.a.	n.a.
Propagation Condition		AWGN							

#### 8.4.1.1.2.4.2 Procedure

- 1) The RF parameters are set up according to T1.
- 2) The UE is switched on.
- 3) A call is set up according to the test procedure specified in TS 34.108 [3] subclause 7.3.

[Editor's note: subclause 7.3.4 in TS 34.108 (Message sequence chart for Handover Test procedure) is not yet specified]

- 4) The SS waits for random access requests from the UE on cell 2.
- 5) 10 s after step3 has completed, the parameters are changed to that as described for T2.
- 6) If the UE responds on cell 2 within 3.7 s from the beginning of time period T2 with a CELL\_UPDATE command then the number of successful tests is increased by one.

- 7) SS shall transmit a RRC CONNECTION RELEASE message to make the UE transit to idle mode.
- 8) After 6 seconds the RF parameters are set up according to T1.
- 9) The SS shall wait for 30s to make the UE complete cell reselection to cell1.
- 10) Repeat step 3-9 [TBD] times

NOTE: The time required for receiving all the relevant system information data according to the reception procedure and the RRC procedure delay of system information blocks defined in TS 25.331 [9] for a UTRAN cell. Since the maximum repetition period of the relevant system info blocks that needs to be received by the UE to camp on a cell is 1280ms and the maximum RRC procedure delay for reception system information block is 100ms, 1380 ms is assumed in this test case. Therefore this gives a total of 3420ms (Minimum requirement + 100ms), allow 3.7s in the test case.

#### 8.4.1.1.2.5 Test requirements

For the test to pass, the total number of successful tests shall be more than 90% with a confidence level of [FFS]% of the cases.

NOTE: If the above Test Requirement differs from the Minimum Requirement then the Test Tolerance applied for this test is non-zero. The Test Tolerance for this test is defined in clause F.2 and the explanation of how the Minimum Requirement has been relaxed by the Test Tolerance is given in clause F.4.

### 8.4.1.2 1,28 Mcps TDD option

#### 8.4.1.2.1 RRC re-establishment delay to an known target cell

##### 8.4.1.2.1.1 Definition and applicability

The UE Re-establishment delay requirement ( $T_{UE-RE-ESTABLISH-REQ}$ ) is defined as the time between the moment when radio link failure is considered by the UE, to when the UE starts to send SYNC-UL in the UpPTS for sending a CELL UPDATE message using the cause "radio link failure".

$T_{UE-RE-ESTABLISH-REQ}$  is depending on whether the target cell is known by the UE or not. A cell is known if either or both of the following conditions are true:

- the UE has had a dedicated connection to the cell during the last 5 seconds.
- the cell has been measured by the UE during the last 5 seconds.

The requirements of this test apply to the TDD UE, 1,28 Mcps option..

##### 8.4.1.2.1.2 Minimum requirement

The Re-establishment delay  $T_{RE-ESTABLISH}$  to a known cell shall be less than 1.9 s.

The rate of correct RRC re-establishments observed during repeated tests shall be at least 90%.

NOTE: The Re-establishment delay in this case can be expressed as

$$T_{RE-ESTABLISH} = T_{RRC-RE-ESTABLISH} + T_{UE-RE-ESTABLISH-REQ-KNOWN}$$

where

$$T_{RRC-RE-ESTABLISH} = 160\text{ms} + (N_{313} - 1) * 10\text{ms} + T_{313}$$

$$T_{UE-RE-ESTABLISH-REQ-KNOWN} = 50\text{ms} + T_{\text{search}} + T_{SI} + T_{RA}$$

$$N_{313} = 20$$

$$T_{313} = 0\text{s}$$

$$T_{\text{search}} = 100\text{ms}$$

$$T_{RA} = \text{The additional delay caused by the random access procedure. 35 ms is assumed in this test case.}$$

$T_{SI}$  is the time required for receiving all the relevant system information data according to the reception procedure and the RRC procedure delay of system information blocks defined in 25.331 for a UTRAN cell (ms). 1280 ms is assumed in this test case.

This gives a total of 1815ms, allow 1.9s in the test case.

#### 8.4.1.2.1.3 Test purpose

To verify that the UE meets the minimum requirement.

#### 8.4.1.2.1.4 Method of test

##### 8.4.1.2.1.4.1 Initial conditions

Test environment: normal; see clauses G.2.1 and G2.2

Frequencies to be tested: mid range; see clause G.2.4

The test parameters are given in table 8.4.1.5 and table 8.4.1.6 below. The maximum repetition period of the relevant system info blocks that needs to be received by the UE to camp on a cell shall be 1280 ms. And DRX cycle length shall be 1280ms. In the measurement control information it is indicated to the UE that periodic reporting shall be used. The test consist of 2 successive time periods, with a time duration of T1 and T2 respectively. At the start of time period T2, the dedicated channel is removed.

**Table 8.4.1.5: General test parameters for RRC re-establishment delay, Test 1**

Parameter	Unit	Value	Comment
DCH Parameters		DL and UL Reference measurement channel 12.2 kbps	As specified in clause C.3.1 and C.2.1
Power Control		On	
Active cell, Initial condition		Cell 1	
Active cell, Final condition		Cell 2	
N313		20	
N315		1	
T313	Seconds	0	
Monitored cell list size		24	Monitored set shall only include intra frequency neighbours.
Cell 2			Included in the monitored set
Reporting frequency	Seconds	4	
T1	s	10	
T2	s	6	

**Table 8.4.1.6: Cell specific parameters for RRC re-establishment delay test, Test 1**

Parameter	Unit	Cell 1		Cell 2	
Timeslot Number		0	5	0	5
		T0	T0	T0	T0
UTRA RF Channel Number		Channel 1		Channel 1	
DPCH_Ec/I <sub>or</sub>	dB	Not applicable	Note 2	Not applicable	
OCNS_Ec/I <sub>or</sub>	dB	Note 2	Note 2	Note 2	
PCCPCH_Ec/I <sub>or</sub>	dB	-3		-3	
$\hat{I}_{or}/I_{oc}$	dB	[3]	3	-infinity	
$I_{oc}$	dBm/ 1.28 MHz	-70			
PCCPCH_RSCP	dBm	-70	Not applicable	-infinity	
Propagation Condition		AWGN			
NOTE 1: The DPCH level is controlled by the power control loop.					
NOTE 2: The power of the OCNS channel that is added shall make the total power from the cell to be equal to I <sub>or</sub> .					

**Table 8.4.1.7: Cell specific parameters for RRC re-establishment delay test, Test 1**

Parameter	Unit	Cell 1				Cell 2			
Timeslot Number		0		5		0		5	
		T1	T2	T1	T2	T1	T2	T1	T2
UTRA RF Channel Number		Channel 1				Channel 1			
DPCH_Ec/I <sub>or</sub>	dB	Not applicable		Note 1	-infinity	Not applicable			
OCNS_Ec/I <sub>or</sub>	dB	Note 2		Note 2		Note 2			
PCCPCH_Ec/I <sub>or</sub>	dB	-3				-3			
$\hat{I}_{or}/I_{oc}$	dB	[3]	-infinity	3	-infinity	6	6		
$I_{oc}$	dBm/ 1.28 MHz	-70							
PCCPCH_RSCP	dBm	-70	-infinity	Not applicable		-67	-67		
Propagation Condition		AWGN							
NOTE 1: The DPCH level is controlled by the power control loop.									
NOTE 2: The power of the OCNS channel that is added shall make the total power from the cell to be equal to I <sub>or</sub> .									

#### 8.4.1.2.1.4.2 Procedure

- 1) The RF parameters are set up according to column T0 in table 8.4.1.6.
- 2) The UE is switched on.
- 3) A call is set up according to the test procedure specified in TS 34.108 [3] subclause 7.3.4
- 4) The RF parameters are set up according to column T1 in table 8.4.1.7.
- 5) 10 s after step4 has completed, the parameters are changed to that as described for column T2.
- 6) If the UE responds on cell 2 within 2.0 s from the beginning of time period T2 with a SYNC-UL in the UpPTS for sending CELL\_UPDATE command then the number of successful tests is increased by one.
- 7) SS shall transmit a RRC CONNECTION RELEASE message to make the UE transit to idle mode.
- 8) After 6 seconds from the beginning of time period T2, the RF parameters are set up according to T0.
- 9) The SS shall wait for 30s to make the UE complete cell reselection to cell1.
- 10) Repeat step 3-9 until the confidence level according to annex F.6.2A is achieved.

NOTE: The time required for receiving all the relevant system information data according to the reception procedure and the RRC procedure delay of system information blocks defined in 25.331 for a UTRAN cell. Since the maximum repetition period of the relevant system info blocks that needs to be received by the UE to camp on a cell is 1280ms and the maximum RRC procedure delay for reception system information block is 100ms, 1380 ms is assumed in this test case. Therefore this gives a total of 1915ms (Minimum requirement + 100ms), allow 2s in the test case.

#### 8.4.1.2.1.5 Test requirements

For the test to pass, the total number of successful tests shall be more than 90% with a confidence level of 95% of the cases.

NOTE: If the above Test Requirement differs from the Minimum Requirement then the Test Tolerance applied for this test is non-zero. The Test Tolerance for this test is defined in clause F.2 and the explanation of how the Minimum Requirement has been relaxed by the Test Tolerance is given in clause F.4.

#### 8.4.1.2.2 RRC re-establishment delay to an unknown target cell

##### 8.4.1.2.2.1 Definition and applicability

The UE Re-establishment delay requirement ( $T_{UE-RE-ESTABLISH-REQ}$ ) is defined as the time between the moment when radio link failure is considered by the UE, to when the UE starts to send SYNC-UL in the UpPTS for sending a CELL UPDATE message using the cause "radio link failure"

$T_{UE-RE-ESTABLISH-REQ}$  is depending on whether the target cell is known by the UE or not. A cell is NOT known if both of the following conditions are true:

- the UE has NOT had a dedicated connection to the cell during the last 5 conds.
- the cell has NOT been measured by the UE during the last 5 seconds.

The requirements of this test apply to the TDD UE, 1,28 Mcps option..

##### 8.4.1.2.2.2 Minimum requirement

The rate of correct RRC re-establishments observed during repeated tests shall be at least 90%.

NOTE: The Re-establishment delay in this case can be expressed as

$$T_{RE-ESTABLISH} = T_{RRC-RE-ESTABLISH} + T_{UE-RE-ESTABLISH-REQ-UNKNOWN}$$

where

$$T_{RRC-RE-ESTABLISH} = 160ms + (N_{313} - 1) * 10ms + T_{313}$$

$$T_{UE-RE-ESTABLISH-REQ-UNKNOWN} = 50ms + T_{search} * NF + T_{SI} + T_{RA}$$

$$N_{313} = 20$$

$$T_{313} = 0s$$

$$T_{search} = 800ms$$

$NF$  is the number of different frequencies in the monitored set. 3 frequencies are assumed in this test case.

$T_{RA}$  = The additional delay caused by the random access procedure. 35 ms is assumed in this test case.

$T_{SI}$  is the time required for receiving all the relevant system information data according to the reception procedure and the RRC procedure delay of system information blocks defined in 25.331 for a UTRAN cell (ms). 1280 ms is assumed in this test case.

This gives a total of 4115ms, allow 4.2s in the test case.

##### 8.4.1.2.2.3 Test purpose

To verify that the UE meets the minimum requirement



## 8.4.1.2.2.4 Method of test

## 8.4.1.2.2.4.1 Initial conditions

Test environment: normal; see clauses G.2.1 and G.2.2

Frequencies to be tested: mid range; see clause G.2.4

The test parameters are given in table 8.4.1.7 and table 8.4.1.8 below. The maximum repetition period of the relevant system info blocks that needs to be received by the UE to camp on a cell shall be 1280 ms. And DRX cycle length shall be 1280ms. In the measurement control information it is indicated to the UE that periodic reporting shall be used. The test consists of 2 successive time periods, with a time duration of T1 and T2 respectively. At the start of time period T2, the dedicated channel is removed.

**Table 8.4.1.7. General test parameters for RRC re-establishment delay, Test 2**

Parameter	Unit	Value	Comment
DCH Parameters		DL and UL Reference measurement channel 12.2 kbps	As specified in clause A.3.1 and A.2.1
Power Control		On	
Active cell, initial condition		Cell 1	
Active cell, final condition		Cell 2	
N313		20	
N315		1	
T313	Seconds	0	
Monitored cell list size		24	Monitored set shall include 2 additional frequencies.
Cell 2			Cell 2 is not included in the monitored set. Cell 2 is located on one of the 2 additional frequencies of the monitored set.
Reporting frequency	Seconds	4	
T1	s	10	
T2	s	6	

**Table 8.4.1.8 Cell specific parameters for RRC re-establishment delay test, Test 2**

Parameter	Unit	Cell 1				Cell 2			
		0		5		0			
Timeslot Number		T1	T2	T1	T2	T1	T2		
UTRA RF Channel Number		Channel 1				Channel 2			
PCCPCH_Ec/I <sub>or</sub>	dB	-3				-3			
DPCH_Ec/I <sub>or</sub>	dB	Not applicable		Note 1	-infinity	Not applicable			
OCNS_Ec/I <sub>or</sub>	dB	Note 2		Note 2		Note 2			
$\hat{I}_{or}/I_{oc}$	dB	3	-infinity	3	-infinity	-infinity	6		
$I_{oc}$	dBm/ 1.28 MHz	-70							
PCCPCH_RSCP	dBm	-70	-infinity	Not applicable		--infinity	-67		
Propagation Condition		AWGN							
NOTE 1: The DPCH level is controlled by the power control loop.									
NOTE 2: The power of the OCNS channel that is added shall make the total power from the cell to be equal to I <sub>or</sub> .									

## 8.4.1.2.2.4.2 Procedure

- 1) The RF parameters are set up according to column T1 in table 8.4.1.4.2.
- 2) The UE is switched on.
- 3) A call is set up according to the test procedure specified in TS 34.108 [3] subclause 7.3.4
- 4) The SS waits for random access requests from the UE on cell 2.

- 5) 10 s after step3 has completed, the parameters are changed to that as described for column T2.
- 6) If the UE responds on cell 2 within 4.3 s from the beginning of time period T2 with a SYNC-UL in the UpPTS for sending CELL\_UPDATE command then the number of successful tests is increased by one.
- 7) SS shall transmit a RRC CONNECTION RELEASE message to make the UE transit to idle mode.
- 8) After 6 seconds the RF parameters are set up according to T1.
- 9) The SS shall wait for 30s to make the UE complete cell reselection to cell1.
- 10) Repeat step 3-9 until the confidence level according to annex F.6.2A is achieved.

NOTE: The time required for receiving all the relevant system information data according to the reception procedure and the RRC procedure delay of system information blocks defined in 25.331 for a UTRAN cell. Since the maximum repetition period of the relevant system info blocks that needs to be received by the UE to camp on a cell is 1280ms and the maximum RRC procedure delay for reception system information block is 100ms, 1380 ms is assumed in this test case. Therefore this gives a total of 4215ms(Minimum requirement + 100ms), allow 4.3s in the test case.

#### 8.4.1.2.2.5 Test requirements

For the test to pass, the total number of successful tests shall be more than 90% with a confidence level of 95% of the cases.

Note: If the above Test Requirement differs from the Minimum Requirement then the Test Tolerance applied for this test is non-zero. The Test Tolerance for this test is defined in clause F.2 and the explanation of how the Minimum Requirement has been relaxed by the Test Tolerance is given in clause F.4.

### 8.4.1.3 7,68 Mcps TDD option

#### 8.4.1.3.1 RRC re-establishment delay to a known target cell

##### 8.4.1.3.1.1 Definition and applicability

For UTRA TDD, the UE re-establishment delay  $T_{\text{UE-RE-ESTABLISH-REQ}}$  is defined as the time between the moment when radio link failure is considered by the UE to when the UE starts sending the RRC CELL UPDATE message to the UTRAN on RACH.

$T_{\text{UE-RE-ESTABLISH-REQ}}$  is depending on whether the target cell is known by the UE or not. A cell is known if either or both of the following conditions are true:

- the UE has had a radio link connected to the cell during the last 5 seconds
- the cell has been measured by the UE during the last 5 seconds.

The requirements of this test apply to the TDD (7,68 Mcps option) UE.

##### 8.4.1.3.1.2 Minimum requirement

The RRC re-establishment delay  $T_{\text{RE-ESTABLISH}}$  to a known target cell shall be less than 2 s.

The rate of successful RRC re-establishments observed during repeated tests shall be at least 90%.

NOTE: The RRC re-establishment delay in this test case can be expressed as,

$$T_{\text{RE-ESTABLISH}} = T_{\text{RRC-RE-ESTABLISH}} + T_{\text{UE-RE-ESTABLISH-REQ-KNOWN}}$$

where,

$$T_{\text{RRC-RE-ESTABLISH}} = 160\text{ms} + (N_{313} - 1) * 10\text{ms} + T_{313}$$

$$T_{\text{UE-RE-ESTABLISH-REQ-KNOWN}} = 50\text{ms} + T_{\text{SEARCH-KNOWN}} + T_{\text{SI}} + T_{\text{RA}},$$

and,

$N_{313}$  Equal to 20 and therefore resulting in 200 ms delay.

$T_{313}$	Equal to 0 s.
$T_{\text{SEARCH-KNOWN}}$	Equal to 100 ms
$T_{\text{SI}}$	Equal to 1280 ms, the time required for receiving all the relevant system information data according to the reception procedure and the RRC procedure performance value of system information blocks defined in TS 25.331 [9] for a UTRAN cell.
$T_{\text{RA}}$	Equal to 40 ms, the additional delay caused by the random access procedure.

This gives a total of 1820ms, allow 2 s in the test case.

#### 8.4.1.3.1.3 Test purpose

The test purpose is to verify that the RRC re-establishment delay to a known target cell is within the specified limits.

#### 8.4.1.3.1.4 Method of test

##### 8.4.1.3.1.4.1 Initial conditions

Test environment: normal; see clauses G.2.1 and G.2.2.

Frequencies to be tested: mid range; see clause G.2.4.

The test parameters are given in table 8.4.1.3.1.4.1 and table 8.4.1.3.1.4.2 below. The maximum repetition period of the relevant system info blocks that needs to be received by the UE in order to camp on a cell shall be 1280 ms. DRX cycle length shall be 1280ms. In the measurement control information it is indicated to the UE that periodic reporting shall be used. The test consists of 2 successive time periods, with time durations of T1 and T2 respectively.

During T1, the DL DPCH in cell 1 shall be transmitted in timeslot 2 and the UL DPCH in cell 1 shall be transmitted in timeslot 10. At the beginning of time period T2, the DPCH shall be removed.

Cell 1 and cell shall be synchronised, i.e. share the same frame and timeslot timing.

**Table 8.4.1.3.1.4.1: General test parameters for RRC re-establishment delay, known target cell case**

Parameter	Unit	Value	Comment
DCH parameters		DL reference measurement channel 12.2 kbps	As specified in TS 25.102 section A.2.2
Power Control		On	
Target quality value on DTCH	BLER	0.01	
Initial conditions	Active cell	Cell 1	Cell 2 shall be included in the monitored set in Cell 1.
	Neighbour cell	Cell 2	
Final conditions	Active cell	Cell 2	
Access Service Class (ASC#0) - Persistence value	-	1	Selected so that no additional delay is caused by the random access procedure. The value shall be used for all cells in the test.
N313		20	
N315		1	
T313	Seconds	0	
$T_{\text{SI}}$	ms	1280	
Monitored cell list size		24 TDD neighbours on Channel 1	
Reporting frequency	Seconds	4	
T1		10	
T2		6	

**Table 8.4.1.3.1.4.2: Cell specific parameters for RRC re-establishment delay test, known target cell case**

Parameter	Unit	Cell 1				Cell 2			
		0		8		0		8	
Timeslot Number		T1	T2	T1	T2	T1	T2	T1	T2
UTRA RF Channel Number		Channel 1				Channel 1			
PCCPCH_Ec/Ior	dB	-3	-3	n.a.	n.a.	-3	-3	n.a.	n.a.
SCH_Ec/Ior	dB	-9	-9	-9	-9	-9	-9	-9	-9
SCH_offset		0	0	0	0	15	15	15	15
PICH_Ec/Ior	dB	n.a.	n.a.	-3	-3	n.a.	n.a.	-3	-3
OCNS_Ec/Ior	dB	-3,12	-3,12	-3,12	-3,12	-3,12	-3,12	-3,12	-3,12
$\hat{I}_{or}/I_{oc}$	dB	3	-13	3	-13	5	5	5	5
$I_{oc}$	dBm/ 7.68 MHz	-70							
P-CCPCH_RSCP	dB	-70	-86	n.a.	n.a.	-68	-68	n.a.	n.a.
Propagation Condition		AWGN							

**8.4.1.3.1.4.2 Procedure**

- 1) The RF parameters are set up according to T1.
- 2) The UE is switched on.
- 3) A call is set up according to the test procedure specified in TS 34.108 [3] subclause 7.3.4.  
[Editor's note: subclause 7.3.4 in TS 34.108 [3] (Message sequence chart for Handover Test procedure) is not yet specified.
- 4) The SS waits for random access requests from the UE on cell 2.
- 5) 10 s after step3 has completed, the parameters are changed to that as described for T2.
- 6) If the UE responds on cell 2 within 2.0 s from the beginning of time period T2 with a CELL\_UPDATE command then the number of successful tests is increased by one.
- 7) SS shall transmit a RRC CONNECTION RELEASE message to make the UE transit to idle mode.
- 8) After 6 seconds from the beginning of time period T2, the RF parameters are set up according to T1.
- 9) The SS shall wait for 30s to make the UE complete cell reselection to cell1.
- 10) Repeat step 3-9 until the confidence level according to annex F.6.2 is achieved.

NOTE: The time required for receiving all the relevant system information data according to the reception procedure and the RRC procedure delay of system information blocks defined in TS 25.331 [9] for a UTRAN cell. Since the maximum repetition period of the relevant system info blocks that needs to be received by the UE to camp on a cell is 1280ms and the maximum RRC procedure delay for reception system information block is 100ms, 1380 ms is assumed in this test case. Therefore this gives a total of 1920ms (Minimum requirement + 100ms), allow 2 s in the test case.

**8.4.1.3.1.5 Test requirements**

For the test to pass, the total number of successful tests shall be more than 90% with a confidence level of 95% of the cases.

NOTE: If the above Test Requirement differs from the Minimum Requirement then the Test Tolerance applied for this test is non-zero. The Test Tolerance for this test is defined in clause F.2 and the explanation of how the Minimum Requirement has been relaxed by the Test Tolerance is given in clause F.4.

### 8.4.1.3.2 RRC re-establishment delay to an unknown target cell

#### 8.4.1.3.2.1 Definition and applicability

For UTRA TDD, the UE re-establishment delay  $T_{UE-RE-ESTABLISH-REQ}$  is defined as the time between the moment when radio link failure is considered by the UE to when the UE starts sending the RRC CELL UPDATE message to the UTRAN on RACH.

$T_{UE-RE-ESTABLISH-REQ}$  is depending on whether the target cell is known by the UE or not. A cell is known if either or both of the following conditions are true:

- the UE has had a radio link connected to the cell during the last 5 seconds
- the cell has been measured by the UE during the last 5 seconds.

The requirements of this test apply to the TDD (7,68 Mcps option) UE.

#### 8.4.1.3.2.2 Minimum requirement

The RRC re-establishment delay  $T_{RE-ESTABLISH}$  to an unknown target cell shall be less than 3,7 s.

The rate of successful RRC re-establishments observed during repeated tests shall be at least 90%.

NOTE: The RRC re-establishment delay in this test case can be expressed as,

$$T_{RE-ESTABLISH} = T_{RRC-RE-ESTABLISH} + T_{UE-RE-ESTABLISH-REQ-UNKNOWN}$$

where,

$$T_{RRC-RE-ESTABLISH} = 160\text{ms} + (N_{313} - 1) * 10\text{ms} + T_{313}$$

$$T_{UE-RE-ESTABLISH-REQ-KNOWN} = 50\text{ms} + T_{SEARCH-UNKNOWN} * NF + T_{SI} + T_{RA},$$

and,

$N_{313}$  Equal to 20 and therefore resulting in 200 ms delay.

$T_{313}$  Equal to 0 s.

$T_{SEARCH-UNKNOWN}$  Equal to 800 ms

NF Equal to 2, the number of different frequencies in the monitored set of cell 1.

$T_{SI}$  Equal to 1280 ms, the time required for receiving all the relevant system information data according to the reception procedure and the RRC procedure performance value of system information blocks defined in TS 25.331 [9] for a UTRAN cell.

$T_{RA}$  Equal to 40 ms, the additional delay caused by the random access procedure.

This gives a total of 3320ms, allow 3,7 s in the test case.

#### 8.4.1.3.2.3 Test purpose

The test purpose is to verify that the RRC re-establishment delay to an unknown target cell is within the specified limits.

#### 8.4.1.3.2.4 Method of test

##### 8.4.1.3.2.4.1 Initial conditions

Test environment: normal; see clauses G.2.1 and G.2.2.

Frequencies to be tested: mid range; see clause G.2.4.

The test parameters are given in table 8.4.1.3.2.4.1 and table 8.4.1.3.2.4.2 below. The maximum repetition period of the relevant system info blocks that needs to be received by the UE in order to camp on a cell shall be 1280 ms. DRX cycle length shall be 1280ms. In the measurement control information it is indicated to the UE that periodic reporting shall be used. The test consists of 2 successive time periods, with time durations of T1 and T2 respectively.

During T1, the DL DPCH in cell 1 shall be transmitted in timeslot 2 and the UL DPCH in cell 1 shall be transmitted in timeslot 10. At the beginning of time period T2, the DPCH shall be removed.

Cell 1 and cell shall be synchronised, i.e. share the same frame and timeslot timing.

**Table 8.4.1.3.2.4.1: General test parameters for RRC re-establishment delay, unknown target cell case**

Parameter	Unit	Value	Comment
DCH parameters		DL reference measurement channel 12.2 kbps	As specified in TS 25.102 section A.2.2
Power Control		On	
Target quality value on DTCH	BLER	0.01	
Initial conditions	Active cell	Cell 1	Cell 2 shall not be included in the monitored set in Cell 1.
	Neighbour cell	Cell 2	
Final conditions	Active cell	Cell 2	
Access Service Class (ASC#0) - Persistence value	-	1	Selected so that no additional delay is caused by the random access procedure. The value shall be used for all cells in the test.
N313		20	
N315		1	
T313	Seconds	0	
T <sub>SI</sub>	ms	1280	
Monitored cell list size		16 TDD neighbours on Channel 1 16 TDD neighbours on Channel 2	
Reporting frequency	Seconds	4	
T1		10	
T2		6	

**Table 8.4.1.3.2.4.2: Cell specific parameters for RRC re-establishment delay test, unknown target cell case**

Parameter	Unit	Cell 1				Cell 2			
		0		8		0		8	
Timeslot Number		T1	T2	T1	T2	T1	T2	T1	T2
UTRA RF Channel Number		Channel 1				Channel 2			
PCCPCH_Ec/I <sub>or</sub>	dB	-3	-3	n.a.	n.a.	-3	-3	n.a.	n.a.
SCH_Ec/I <sub>or</sub>	dB	-9	-9	-9	-9	-9	-9	-9	-9
SCH_t <sub>offset</sub>		0	0	0	0	15	15	15	15
PICH_Ec/I <sub>or</sub>	dB	n.a.	n.a.	-3	-3	n.a.	n.a.	-3	-3
OCNS_Ec/I <sub>or</sub>	dB	-3,12	-3,12	-3,12	-3,12	-3,12	-3,12	-3,12	-3,12
$\hat{I}_{or}/I_{oc}$	dB	3	-13	3	-13	5	5	5	5
I <sub>oc</sub>	dBm/ 7.68 MHz	-70							
P-CCPCH_RSCP	dB	-70	-86	n.a.	n.a.	-68	-68	n.a.	n.a.
Propagation Condition		AWGN							

#### 8.4.1.3.2.4.2 Procedure

- 1) The RF parameters are set up according to T1.
- 2) The UE is switched on.
- 3) A call is set up according to the test procedure specified in TS 34.108 [3] subclause 7.3.

[Editor's note: subclause 7.3.4 in TS 34.108 (Message sequence chart for Handover Test procedure) is not yet specified]

- 4) The SS waits for random access requests from the UE on cell 2.
- 5) 10 s after step3 has completed, the parameters are changed to that as described for T2.
- 6) If the UE responds on cell 2 within 3.7 s from the beginning of time period T2 with a CELL\_UPDATE command then the number of successful tests is increased by one.
- 7) SS shall transmit a RRC CONNECTION RELEASE message to make the UE transit to idle mode.
- 8) After 6 seconds the RF parameters are set up according to T1.
- 9) The SS shall wait for 30s to make the UE complete cell reselection to cell1.
- 10) Repeat step 3-9 until the confidence level according to annex F.6.2 is achieved.

NOTE: The time required for receiving all the relevant system information data according to the reception procedure and the RRC procedure delay of system information blocks defined in TS 25.331 [9] for a UTRAN cell. Since the maximum repetition period of the relevant system info blocks that needs to be received by the UE to camp on a cell is 1280ms and the maximum RRC procedure delay for reception system information block is 100ms, 1380 ms is assumed in this test case. Therefore this gives a total of 3420ms (Minimum requirement + 100ms), allow 3.7s in the test case.

#### 8.4.1.3.2.5 Test requirements

For the test to pass, the total number of successful tests shall be more than 90% with a confidence level of 95% of the cases.

NOTE: If the above Test Requirement differs from the Minimum Requirement then the Test Tolerance applied for this test is non-zero. The Test Tolerance for this test is defined in clause F.2 and the explanation of how the Minimum Requirement has been relaxed by the Test Tolerance is given in clause F.4.

### 8.4.1A Random Access

#### 8.4.1A.1 3,84 Mcps TDD option

Void.

#### 8.4.1A.2 1,28 Mcps TDD option

##### 8.4.1A.2.1 Correct behaviour when receiving FPACH

###### 8.4.1A.2.1.1 Definition and applicability

The random access procedure is used when establishing the layer 1 communication between the UE and UTRAN. The random access shall provide a fast access but without disturbing ongoing connections. The random access is specified in clause 5.6 of TS 25.224 and the control of the RACH transmission is specified in clause 11.2.3.2 of TS 25.321. A random access transmit sequence is described in clause 6.7.3.2 of TS 25.303.

The requirements and this test apply to all types of 1.28 Mcps TDD UE.

###### 8.4.1A.2.1.2 Minimum requirement

The UE shall have capability to calculate initial power according to the open loop algorithm :

$$P_{UpPCH} = L_{PCCPCH} + PRX_{UpPCHdes} + (i-1) * Pwr_{ramp}$$

and apply this power level for the transmission of SYNC\_UL.

The absolute power applied to the first SYNC\_UL shall have an accuracy as specified in table 6.4.1.2 of TS 25.102. The accuracy is  $\pm 9$ dB in the case of normal condition or  $\pm 12$ dB in the case of extreme condition.

There is a relative powers, which is the power difference for SYNC\_UL ramping. From the test parameter in the table 1-3, the test requirement of the power difference for all SYNC\_UL ramping is 0~3dB ( $Pwr_{ramp}$ ). The accuracy is specified in table 1-1.

**Table 8.4.1A.2.1: Transmitter power difference tolerance for SYNC\_UL ramping**

Power step size $Pwr_{ramp}$ [dB]	Transmitter power difference tolerance [dB]
0	+/- 1
1	+/- 1
2	+/- 1.5
3	+/- 2

The UE shall stop transmitting SYNC\_UL when FPACH has been received correctly and then transmit PRACH. The UE shall transmit  $i$  SYNC\_UL and 1 PRACH.  $i=1 \dots \text{Max SYNC\_UL Transmissions}$ .

#### 8.4.1A.2.1.3 Test purpose

The purpose of this test is to verify that the behaviour of the random access procedure is according to the requirements.

#### 8.4.1A.2.1.4 Method of test

##### 8.4.1A.2.1.4.1 Initial conditions

Test environment: normal; see clauses G.2.1 and G.2.2

Frequencies to be tested: mid range; see clause G.2.4.

**Table 8.4.1A.2.1A: RF Parameters for Random Access test**

Parameter	Unit	Cell 1
UTRA RF Channel Number		Channel 1
PCCPCH_Ec/I <sub>or</sub>	dB	-3
OCNS_Ec/I <sub>or</sub>	dB	-3
$\hat{I}_{or}/I_{oc}$	dB	10
$I_{oc}$	dBm/1.28 MHz	-70
PCCPCH_RSCP	dBm/1.28MHz	-63
Propagation Condition		AWGN

The test parameters "System Information Block (SIB) type 5 (ASC #0)" defined in clause 6.1 of TS 34.108, shall be used in all random access tests. Crucial parameters for the test requirements are repeated in tables 1-3 and these overrule the parameters defined in SIB type 5. A parameter of AC-to-ASC mapping (AC0-9) in SIB5 of clause 6.1 of TS 34.108 shall be set to 0 in the case of all random access tests.

**Table 8.4.1A.2.1B: UE/SS parameters for Random Access test**

Parameter	Unit	Value
Access Service Class (ASC#0)		
- Persistence value	0..1	1
PCCPCH Power -Broadcast	dB	18
Max SYNC_UL Transmissions		8
Power step when no acquisition indicator is received ( $Pwr_{ramp}$ )	dB	1~3
Maximum allowed UL TX power	dBm	21
Desired UpPCH RX power at the cell's receiver ( $PRX_{UpPCHdes}$ )	dBm	-100dBm

#### 8.4.1A.2.1.4.2 Procedure

- 1) A call is set up according to the Generic call setup procedure. The test parameters are set up according to table 1-2, and table 1-3, set the value of  $Pwr_{ramp}$  as 1dB.



- 2) The PRACH procedure within the call setup is used for the test. It is necessary that an ACK on FPACH shall be transmitted after 6 SYNC\_UL have been received by the SS.
- 3) Measure the first SYNC\_UL output power, and the each power difference for SYNC\_UL ramping. If power difference for SYNC\_UL fulfills test requirement in table 1-4, the successful times plus 1, otherwise failed times plus 1.
- 4) The call procedure is set up successfully, and SS release RRC connection.
- 5) Reconfigure the value of  $P_{wr\_ramp}$  as 2dB, repeat step 1)~4).
- 6) Reconfigure the value of  $P_{wr\_ramp}$  as 3dB, repeat step 1)~4).

#### 8.4.1A.2.1.5 Test requirements

The accuracy of the first SYNC\_UL as specified in clause 6.4.1.2 of TS 25.102 shall not be verified in this test. It is verified under the section 5.4.1.3, Open loop power control.

**Table 8.4.1A.2.1C: Test requirement for power difference**

	Power difference for all SYNC_UL	
Test requirement	1dB	$\pm 1.7$ dB
	2dB	$\pm 2.2$ dB
	3dB	$\pm 2.7$ dB

In each call setup procedure UE shall stop transmitting SYNC\_UL when correct FPACH has been received and then transmit PRACH. The UE shall transmit 6 SYNC\_UL.

#### 8.4.1A.2.2 Correct behaviour when reaching maximum allowed UL transmit power

##### 8.4.1A.2.2.1 Definition and applicability

The random access procedure is used when establishing the layer 1 communication between the UE and UTRAN. The random access shall provide a fast access but without disturbing ongoing connections. The random access is specified in clause 6 of TS 25.224 and the control of the RACH transmission is specified in clause 11.2 of TS 25.321.

The requirements and this test apply to all types of 1.28 Mcps TDD UE.

##### 8.4.1A.2.2.2 Minimum requirement

The UE shall not exceed the maximum allowed UL TX power, which is specified in table 8.4.1A.2.2 and configured by the SS, with more than the accuracy tolerances as defined in section 9.1.2.1.1 of TS 25.123.

Section 6A.3 of TS 25.123 states that for UE output powers that are outside the range covered by the UE transmitted power measurement the UE output power shall not exceed the Maximum allowed UL TX Power with more than the tolerances specified for the UL power control in TS 25.102.

No FPACH shall be sent by SS during this test.

##### 8.4.1A.2.2.3 Test purpose

The purpose of this test is to verify that the SYNC\_UL power behavior when reaching Maximum allowed UL TX power is correct.

##### 8.4.1A.2.2.4 Method of test

###### 8.4.1A.2.2.4.1 Initial conditions

Test environment: normal; see clauses G.2.1 and G.2.2

Frequencies to be tested: mid range; see clause G.2.4.

See TS 34.108 [3] for details regarding generic call setup procedure.

**Table 8.4.1A.2.2: Test parameters for correct behaviour when reaching maximum transmit power**

Parameter	Unit	Cell 1
UTRA RF Channel Number		Channel 1
PCCPCH_Ec/I <sub>or</sub>	dB	-3
DwPCH_Ec/I <sub>or</sub>	dB	0
OCNS_Ec/I <sub>or</sub>	dB	-3
$\hat{I}_{or}/I_{oc}$	dB	7
$I_{oc}$	dBm/1.28 MHz	-70
PCCPCH RSCP	dBm	-66
broadcasted Primary CCPCH transmit power on BCH	dBm	24
Access Service Class (ASC#0)		
- Persistence value	0..1	1
SYNC_UL code bitmap		11111111
PRXUppchdes	dbm	-95
Power Ramp step	dB	3
Max SYNC_UL Transmissions		8
Mmax		4
Maximum allowed UL TX power	dBm	0
Propagation Condition		AWGN

#### 8.4.1A.2.2.4.2 Procedure

- 1) A call is set up according to the Generic call setup procedure. The test parameters are set up according to table 8.4.1A.2.2. The PRACH procedure within the call setup is used for the test. It is necessary that SS shall transmit no FPACH.
- 2) Set the TX output level of the SS to obtain  $\hat{I}_{or}$  at the UE antenna connector.  $\hat{I}_{or}$  shall be according to table 8.4.1A.2.2A.
- 3) Measure all SYNC\_UL output power of the UE.

#### 8.4.1A.2.2.5 Test requirements

The UE shall not exceed the Maximum allowed UL TX power configured by the SS with more than the tolerance specified in table 8.4.1A.2.2A.

**Table 8.4.1A.2.2A: Test requirement for maximum SYNC\_UL power**

	Maximum SYNC_UL power	
Test requirement(normal)	0dBm	±10 dB
Test requirement(extreme)	0dBm	±13 dB

NOTE: If the above Test Requirement differs from the Minimum Requirement then the Test Tolerance applied for this test is non-zero. The Test Tolerance for this test is defined in clause F.2 and the explanation of how the Minimum Requirement has been relaxed by the Test Tolerance is given in clause F.4.

#### 8.4.1A.3 7.68 Mcps TDD option

Void.

## 8.4.2 Transport Format Combination selection in UE

### 8.4.2.1 Interactive or Background, PS, UL: 64 kbps

#### 8.4.2.1.1 Definition and applicability

##### 8.4.2.1.1.1 3,84 Mcps TDD option

When the UE estimates that a certain TFC would require more power than the maximum transmit power, it shall limit the usage of transport format combinations for the assigned transport format combination set. This in order to make it possible for the network operator to maximise the coverage. Transport format combination selection is described in section 11.4 of TS 25.321 [14].

##### 8.4.2.1.1.1A 1,28 Mcps TDD option

When the UE estimates that a certain TFC would require more power than the maximum transmit power, it shall limit the usage of transport format combinations for the assigned transport format combination set. This allows the network operator to maximise the coverage. Transport format combination selection is described in section 11.4 of TS 25.321 [14].

The requirements and this test apply to all types of 1.28 Mcps TDD UE.

##### 8.4.2.1.1.2 7,68 Mcps TDD option

When the UE estimates that a certain TFC would require more power than the maximum transmit power, it shall limit the usage of transport format combinations for the assigned transport format combination set. This in order to make it possible for the network operator to maximise the coverage. Transport format combination selection is described in section 11.4 of TS 25.321 [14].

#### 8.4.2.1.2 Minimum requirements

##### 8.4.2.1.2.1 3,84 Mcps TDD option

The UE shall continuously evaluate based on the *Elimination*, *Recovery* and *Blocking* criteria defined below, how TFCs can be used for the purpose of TFC selection. The evaluation shall be performed using the estimated UE transmit power of a given CCTrCH in its associated timeslots.

In the case of a single CCTrCH or multiple CCTrCHs having mutually exclusive timeslot assignments, the UE shall consider the *Elimination* criterion for a given TFC of a CCTrCH to be fulfilled if for 3 successive frames the estimated UE transmit power is greater than the Maximum UE transmitter power for at least one timeslot associated with the CCTrCH in each frame.

In the case of multiple CCTrCHs not having mutually exclusive timeslot assignments, if for a given CCTrCH for 3 successive frames the estimated UE transmit power is greater than the Maximum UE transmitter power for at least one timeslot associated with the CCTrCH in each frame, the UE shall consider the *Elimination* criterion for a given TFC to be fulfilled if the use of this TFC will cause the estimated UE transmit power to continue to be greater than the Maximum UE transmitter power in at least one timeslot associated with the CCTrCH.

In the case of multi-frame operation of UL Physical Channels, the UE shall only consider active frames for the evaluation of the *Elimination* criterion.

If the *Elimination* criterion for a given TFC is fulfilled, the MAC in the UE shall consider that the TFC is in Excess-Power state for the purpose of TFC selection.

MAC in the UE shall indicate the available bitrate for each logical channel to upper layers within  $T_{\text{notify}}$  from the moment the *Elimination* criterion was fulfilled.

The UE shall not consider the *Recovery* criterion for a given TFC to be fulfilled until the use of this TFC will not cause the estimated UE transmit power to be greater than the Maximum UE transmitter power for all UL timeslots associated with the TFC for a minimum of 3 successive frames.

In the case of multi-frame operation of UL Physical Channels, the UE shall only consider active frames for the evaluation of the *Recovery* criterion.

If the *Recovery* criterion for a given TFC is fulfilled, the MAC in the UE shall consider that the TFC is in Supported state for the purpose of TFC selection.

MAC in the UE shall indicate the available bitrate for each logical channel to upper layers within  $T_{\text{notify}}$  from the moment the *Recovery* criterion was fulfilled.

The UE shall consider the *Blocking* criterion for a given TFC to be fulfilled at the latest at the start of the longest uplink TTI after the moment at which the TFC will have been in Excess-Power state for a duration of

$$(T_{\text{notify}} + T_{\text{modify}} + T_{L1\_proc}).$$

where:

$T_{\text{notify}}$  equals 15 ms, and

$T_{\text{modify}}$  equals  $\text{MAX}(T_{\text{adapt\_max}}, T_{\text{TTI}})$ , and

$T_{L1\_proc}$  equals 35 ms, and

$T_{\text{adapt\_max}}$  equals  $\text{MAX}(T_{\text{adapt\_1}}, T_{\text{adapt\_2}}, \dots, T_{\text{adapt\_N}})$ , and

N equals the number of logical channels that need to change rate, and

$T_{\text{adapt\_n}}$  equals the time it takes for higher layers to provide data to MAC in a new supported bitrate, for logical channel n. Table 6A.1 defines  $T_{\text{adapt}}$  times for different services. For services where no codec is used  $T_{\text{adapt}}$  shall be considered to be equal to 0 ms.

**Table 8.4.2.1.1:  $T_{\text{adapt}}$**

Service	$T_{\text{adapt}}$ [ms]
UMTS AMR	40
UMTS AMR 2	60

$T_{\text{TTI}}$  equals the longest uplink TTI of the selected TFC (ms).

The Maximum UE transmitter power is defined as follows

$$\text{Maximum UE transmitter power} = \text{MIN}(\text{Maximum allowed UL TX Power, UE maximum transmit power})$$

where

Maximum allowed UL TX Power is set by SS and defined in TS 25.331 [9], and

UE maximum transmit power is defined by the UE power class, and specified in TS 25.102 [1].

The normative reference for these requirements is TS 25.123 [2] clauses 6A.2 and A.6A.2.

#### 8.4.2.1.2.1A 1,28 Mcps TDD option

The UE shall continuously evaluate based on the *Elimination*, *Recovery* and *Blocking* criteria defined below, how TFCs can be used for the purpose of TFC selection. The evaluation shall be performed using the estimated UE transmit power of a given TFC. The UE transmit power estimation shall be made using the UE transmitted power measured over the measurement period and the gain factors of the corresponding TFC.

The UE shall consider the *Elimination* criterion for a given TFC to be fulfilled if the estimated UE transmit power needed for this TFC is greater than the Maximum UE transmitter power for at least X out of Y successive measurement periods. The MAC in the UE shall consider that the TFC is in Excess-Power state for the purpose of TFC selection.

MAC in the UE shall indicate the available bitrate for each logical channel to upper layers within [15 ms] from the moment the *Elimination* criterion was fulfilled.

The UE shall consider the *Recovery* criterion for a given TFC to be fulfilled if the estimated UE transmit power needed for this TFC has not been greater than the Maximum UE transmitter power for at least Y successive measurement periods. The MAC in the UE shall consider that the TFC is in Supported state for the purpose of TFC selection.

MAC in the UE shall indicate the available bitrate for each logical channel to upper layers within  $T_{\text{notify}}$  from the moment the *Recovery* criterion was fulfilled.

The UE shall consider the *Blocking* criterion for a given TFC to be fulfilled at the latest at the start of the longest uplink TTI after the moment at which the TFC will have been in Excess-Power state for a duration of  $(T_{\text{notify}} + T_{\text{modify}} + T_{\text{L1\_proc}})$ .

where:

$T_{\text{notify}}$  equals [15] ms, and

$T_{\text{modify}}$  equals  $\text{MAX}(T_{\text{adapt\_max}}, T_{\text{TTI}})$ , and

$T_{\text{L1\_proc}}$  equals 15 ms, and

$T_{\text{adapt\_max}}$  equals  $\text{MAX}(T_{\text{adapt\_1}}, T_{\text{adapt\_2}}, \dots, T_{\text{adapt\_N}})$ , and

$N$  equals the number of logical channels that need to change rate, and

$T_{\text{adapt\_n}}$  equals the time it takes for higher layers to provide data to MAC in a new supported bitrate, for logical channel  $n$ . Table 8.4.2.1.1A defines  $T_{\text{adapt}}$  times for different services. For services where no codec is used  $T_{\text{adapt}}$  shall be considered to be equal to 0 ms.

**Table 8.4.2.1.1A  $T_{\text{adapt}}$  (1,28Mcps)**

Service	$T_{\text{adapt}}$ [ms]
AMR	40

$T_{\text{TTI}}$  equals the longest uplink TTI of the selected TFC (ms).

The Maximum UE transmitter power is defined as follows

Maximum UE transmitter power =  $\text{MIN}(\text{Maximum allowed UL TX Power}, \text{UE maximum transmit power})$

Where

Maximum allowed UL TX Power is set by SS and defined in TS 25.331 [9], and

UE maximum transmit power is defined by the UE power class, and specified in TS 25.102 [1].

The normative reference for these requirements is TS 25.123 [2] clauses 6A.2.2.2 and A.6.A2.2.2

#### 8.4.2.1.2.2 7,68 Mcps TDD option

The UE shall continuously evaluate based on the *Elimination*, *Recovery* and *Blocking* criteria defined below, how TFCs can be used for the purpose of TFC selection. The evaluation shall be performed using the estimated UE transmit power of a given CCTrCH in its associated timeslots.

In the case of a single CCTrCH or multiple CCTrCHs having mutually exclusive timeslot assignments, the UE shall consider the *Elimination* criterion for a given TFC of a CCTrCH to be fulfilled if for 3 successive frames the estimated UE transmit power is greater than the Maximum UE transmitter power for at least one timeslot associated with the CCTrCH in each frame.

In the case of multiple CCTrCHs not having mutually exclusive timeslot assignments, if for a given CCTrCH for 3 successive frames the estimated UE transmit power is greater than the Maximum UE transmitter power for at least one timeslot associated with the CCTrCH in each frame, the UE shall consider the *Elimination* criterion for a given TFC to be fulfilled if the use of this TFC will cause the estimated UE transmit power to continue to be greater than the Maximum UE transmitter power in at least one timeslot associated with the CCTrCH.

In the case of multi-frame operation of UL Physical Channels, the UE shall only consider active frames for the evaluation of the *Elimination* criterion.

If the *Elimination* criterion for a given TFC is fulfilled, the MAC in the UE shall consider that the TFC is in Excess-Power state for the purpose of TFC selection.

MAC in the UE shall indicate the available bitrate for each logical channel to upper layers within  $T_{\text{notify}}$  from the moment the *Elimination* criterion was fulfilled.

The UE shall not consider the *Recovery* criterion for a given TFC to be fulfilled until the use of this TFC will not cause the estimated UE transmit power to be greater than the Maximum UE transmitter power for all UL timeslots associated with the TFC for a minimum of 3 successive frames.

In the case of multi-frame operation of UL Physical Channels, the UE shall only consider active frames for the evaluation of the *Recovery* criterion.

If the *Recovery* criterion for a given TFC is fulfilled, the MAC in the UE shall consider that the TFC is in Supported state for the purpose of TFC selection.

MAC in the UE shall indicate the available bitrate for each logical channel to upper layers within  $T_{\text{notify}}$  from the moment the *Recovery* criterion was fulfilled.

The UE shall consider the *Blocking* criterion for a given TFC to be fulfilled at the latest at the start of the longest uplink TTI after the moment at which the TFC will have been in Excess-Power state for a duration of

$$(T_{\text{notify}} + T_{\text{modify}} + T_{\text{L1\_proc}}).$$

where:

$T_{\text{notify}}$  equals 15 ms, and

$T_{\text{modify}}$  equals  $\text{MAX}(T_{\text{adapt\_max}}, T_{\text{TTI}})$ , and

$T_{\text{L1\_proc}}$  equals 35 ms, and

$T_{\text{adapt\_max}}$  equals  $\text{MAX}(T_{\text{adapt\_1}}, T_{\text{adapt\_2}}, \dots, T_{\text{adapt\_N}})$ , and

$N$  equals the number of logical channels that need to change rate, and

$T_{\text{adapt\_n}}$  equals the time it takes for higher layers to provide data to MAC in a new supported bitrate, for logical channel  $n$ . Table 6A.1 defines  $T_{\text{adapt}}$  times for different services. For services where no codec is used  $T_{\text{adapt}}$  shall be considered to be equal to 0 ms.

**Table 8.4.2.1.1:  $T_{\text{adapt}}$**

Service	$T_{\text{adapt}}$ [ms]
UMTS AMR	40
UMTS AMR 2	60

$T_{\text{TTI}}$  equals the longest uplink TTI of the selected TFC (ms).

The Maximum UE transmitter power is defined as follows

$$\text{Maximum UE transmitter power} = \text{MIN}(\text{Maximum allowed UL TX Power}, \text{UE maximum transmit power})$$

where

Maximum allowed UL TX Power is set by SS and defined in TS 25.331 [9], and

UE maximum transmit power is defined by the UE power class, and specified in TS 25.102 [1].

The normative reference for these requirements is TS 25.123 [2] clauses 6A.2 and A.6A.2.

### 8.4.2.1.3 Test purpose

#### 8.4.2.1.3.1 3,84 Mcps TDD option

The purpose is to verify the UE blocks (stops using) a currently used TFC when the UE output power is not sufficient to support that TFC. This test will verify the general requirement on TFC selection in section 8.4.2.1.2 for a RAB intended for packet data services, i.e. Interactive or Background, PS, UL: 64kbps as defined in TS 34.108 [3].

## 8.4.2.1.3.1A 1,28 Mcps TDD option

The purpose is to verify the UE blocks (stops using) a currently used TFC when the UE output power is not sufficient to support that TFC. This test will verify the general requirement on TFC selection in section 8.4.2.1.2A for a RAB intended for packet data services, i.e. Interactive or Background, PS, UL: 64kbps as defined in TS 34.108 [3].

## 8.4.2.1.3.2 7,68 Mcps TDD option

The purpose is to verify the UE blocks (stops using) a currently used TFC when the UE output power is not sufficient to support that TFC. This test will verify the general requirement on TFC selection in section 8.4.2.1.2 for a RAB intended for packet data services, i.e. Interactive or Background, PS, UL: 64kbps as defined in TS 34.108 [3].

## 8.4.2.1.4 Method of test

## 8.4.2.1.4.1 Initial conditions

## 8.4.2.1.4.1.1 3,84 Mcps TDD option

Test environment: normal, TL/VL, TL/VH, TH/VL, TH/VH; see clauses G.2.1 and G.2.2.

Frequencies to be tested: mid range; see clause G.2.4.

The test parameters are given in Tables 8.4.2.1.2, 8.4.2.1.3, Table 8.4.2.1.4 and Table 8.4.2.1.5 below. The test consists of 2 successive time periods, with a time duration of T1 and T2 respectively.

Details on the UL reference RAB in table 8.4.2.1.3 can be found in TS 34.108 [3] section "Interactive or background / UL:64 DL: 64 kbps / PS RAB + UL:3.4 DL:3.4 kbps SRBs for DCCH".

**Table 8.4.2.1.2: General test parameters**

Parameter	Unit	Value	Comment
TFCS size		10	
TFCS		UL_TFC0, UL_TFC1, UL_TFC2, UL_TFC3, UL_TFC4, UL_TFC5, UL_TFC6, UL_TFC7, UL_TFC8, UL_TFC9	Gain factors for TFC0 to TFC9 shall be set to 1.
Power Control		On	
Active cell		Cell 1	
Maximum allowed UL TX power	dBm	0	Value of IE "Maximum allowed UL Tx power"
Primary CCPCH Tx power	dBm	18	Value of IE "Primary CCPCH Tx power"
UL timeslot interference	dBm	-80	Value of IE "UL timeslot interference" This value shall apply to all timeslots
$\alpha$		1	IE "Alpha" either not sent or explicitly set to value
UL target SIR	dB	6	
DPCH constant offset	dB	adjustable	Value of IE "DPCH constant power"
T1	s	10	
T2	s	10	

**Table 8.4.2.1.3: Transport channel parameters for UL reference RAB, Interactive or Background and DCCH**

Parameter	Unit	64 kbps RAB	DCCH 3.4kbps
Transport Channel Number		1	2
Transmission Time Interval	ms	20	40
Type of Error Protection		Turbo coding	Convolutional coding
Coding Rate		1/3	
Size of CRC	bits	16	
Transport Block Size	bits	336	148
Transport Block Set Size	bits	336*B (B=0,1,2,3,4)	148*B (B=0,1)
Transport Format Set	bits		
TF0		0x336	0x148
TF1		1x336	1x148
TF2		2x336	N/A
TF3		3x336	N/A
TF4		4x336	N/A

**Table 8.4.2.1.4: UL TFCI**

TFCI	(64 kbps RAB, DCCH)
UL_TFC0	(TF0, TF0)
UL_TFC1	(TF0, TF1)
UL_TFC2	(TF1, TF0)
UL_TFC3	(TF1, TF1)
UL_TFC4	(TF2, TF0)
UL_TFC5	(TF2, TF1)
UL_TFC6	(TF3, TF0)
UL_TFC7	(TF3, TF1)
UL_TFC8	(TF4, TF0)
UL_TFC9	(TF4, TF1)

**Table 8.4.2.1.5: Physical channel parameters**

Parameter	Unit	Value
UL timeslot		7
Burst type		1
Resource units		{(spreading factor 16 x 1 code) + (spreading factor 4 x 1 code)} x 1 time slot
TFCI	Bits	16
TPC	Bits	2
Frame allocation		Continuous

The test shall be performed in AWGN channel propagation conditions. The P-CCPCH in the DL shall be transmitted in timeslot 0.

The amount of available user data shall be sufficient to allow uplink transmission at the highest bit rate (UL\_TFC8 or UL\_TFC9) during the entire test and it shall be ensured that the UE is using UL\_TFC8 or UL\_TFC9 at the end of T1.

#### 8.4.2.1.4.1.1A 1,28 Mcps TDD option

Test environment: normal, TL/VL, TL/VH, TH/VL, TH/VH; see clauses G.2.1 and G.2.2.

Frequencies to be tested: mid range; see clause G.2.4.

The test parameters are given in Tables 8.4.2.1.5A , 8.4.2.1.5B and Table 8.4.2.1.5C below. The test consists of 2 successive time periods, with a time duration of T1 and T2 respectively.

Details on the UL reference RAB in table 8.4.2.1.3 can be found in TS 34.108 [3] section "Interactive or background / UL:64 DL: 64 kbps / PS RAB + UL:3.4 DL:3.4 kbps SRBs for DCCH".



**Table 8.4.2.1.5A General test parameters**

Parameter	Unit	Value	Comment
TFCS size		10	
TFCS		UL_TFC0, UL_TFC1, UL_TFC2, UL_TFC3, UL_TFC4, UL_TFC5, UL_TFC6, UL_TFC7, UL_TFC8, UL_TFC9	
Power Control		On	
TPC step size	dB	1	
Maximum allowed UL TX power	dBm	21	
T1	s	30	
T2	s	10	

**Table 8.4.2.1.5B: UL Reference RAB interactive or background**

	TFI	64 kbps RAB (20ms TTI)	DCCH 3.4kbps (40ms TTI)
TFS	TF0, bits	0x336	0x148
	TF1, bits	1x336	1x148
	TF2, bits	2x336	N/A
	TF3, bits	3x336	N/A
	TF4, bits	4x336	N/A

**Table 8.4.2.1.5C: UL TFCI**

TFCI	(64 kbps RAB, DCCH)
UL_TFC0	(TF0, TF0)
UL_TFC1	(TF0, TF1)
UL_TFC2	(TF1, TF0)
UL_TFC3	(TF1, TF1)
UL_TFC4	(TF2, TF0)
UL_TFC5	(TF2, TF1)
UL_TFC6	(TF3, TF0)
UL_TFC7	(TF3, TF1)
UL_TFC8	(TF4, TF0)
UL_TFC9	(TF4, TF1)

The test shall be performed in AWGN channel propagation conditions.

The amount of available user data shall be sufficient to allow uplink transmission at the highest bit rate (UL\_TFC8 or UL\_TFC9) during the entire test and it shall be ensured that the UE is using UL\_TFC8 or UL\_TFC9 at the end of T1

#### 8.4.2.1.4.1.2 7,68 Mcps TDD option

Test environment: normal, TL/VL, TL/VH, TH/VL, TH/VH; see clauses G.2.1 and G.2.2.

Frequencies to be tested: mid range; see clause G.2.4.

The test parameters are given in Tables 8.4.2.1.4.1.2.1, 8.4.2.1.4.1.2.2, 8.4.2.1.4.1.2.3 and 8.4.2.1.4.1.2.4 below. The test consists of 2 successive time periods, with a time duration of T1 and T2 respectively.

Details on the UL reference RAB in table 8.4.2.1.4.1.2.2 can be found in TS 34.108 [3] section "Interactive or background / UL:64 DL: 64 kbps / PS RAB + UL:3.4 DL:3.4 kbps SRBs for DCCH".

**Table 8.4.2.1.4.1.2.1: General test parameters**

Parameter	Unit	Value	Comment
TFCS size		10	
TFCS		UL_TFC0, UL_TFC1, UL_TFC2, UL_TFC3, UL_TFC4, UL_TFC5, UL_TFC6, UL_TFC7, UL_TFC8, UL_TFC9	Gain factors for TFC0 to TFC9 shall be set to 1.
Power Control		On	
Active cell		Cell 1	
Maximum allowed UL TX power	dBm	0	Value of IE "Maximum allowed UL Tx power"
Primary CCPCH Tx power	dBm	18	Value of IE "Primary CCPCH Tx power"
UL timeslot interference	dBm	-80	Value of IE "UL timeslot interference" This value shall apply to all timeslots
$\alpha$		1	IE "Alpha" either not sent or explicitly set to value
UL target SIR	dB	6	
DPCH constant offset	dB	adjustable	Value of IE "DPCH constant power"
T1	s	10	
T2	s	10	

**Table 8.4.2.1.4.1.2.2: Transport channel parameters for UL reference RAB, Interactive or Background and DCCH**

Parameter	Unit	64 kbps RAB	DCCH 3.4kbps
Transport Channel Number		1	2
Transmission Time Interval	ms	20	40
Type of Error Protection		Turbo coding	Convolutional coding
Coding Rate		1/3	
Size of CRC	bits	16	
Transport Block Size	bits	336	148
Transport Block Set Size	bits	336*B (B=0,1,2,3,4)	148*B (B=0,1)
Transport Format Set	bits		
TF0		0x336	0x148
TF1		1x336	1x148
TF2		2x336	N/A
TF3		3x336	N/A
TF4		4x336	N/A

**Table 8.4.2.1.4.1.2.3: UL TFCI**

TFCI	(64 kbps RAB, DCCH)
UL_TFC0	(TF0, TF0)
UL_TFC1	(TF0, TF1)
UL_TFC2	(TF1, TF0)
UL_TFC3	(TF1, TF1)
UL_TFC4	(TF2, TF0)
UL_TFC5	(TF2, TF1)
UL_TFC6	(TF3, TF0)
UL_TFC7	(TF3, TF1)
UL_TFC8	(TF4, TF0)
UL_TFC9	(TF4, TF1)

**Table 8.4.2.1.4.1.2.4: Physical channel parameters**

Parameter	Unit	Value
UL timeslot		7
Burst type		1
Resource units		{{(spreading factor 32 x 1 code) + (spreading factor 8 x 1 code)} x 1 time slot
TFCI	Bits	16
TPC	Bits	2
Frame allocation		Continuous

The test shall be performed in AWGN channel propagation conditions. The P-CCPCH in the DL shall be transmitted in timeslot 0.

The amount of available user data shall be sufficient to allow uplink transmission at the highest bit rate (UL\_TFC8 or UL\_TFC9) during the entire test and it shall be ensured that the UE is using UL\_TFC8 or UL\_TFC9 at the end of T1.

#### 8.4.2.1.4.2 Procedure

##### 8.4.2.1.4.2.1 3,84 Mcps TDD option

- 1) The UE is switched on.
- 2) The SS shall signal to the UE the allowed TFCS according to table 8.4.2.1.2.
- 3) For T1=30 secs the SS shall ensure that the received P-CCPCH power level in the UE is set to -60dBm and that the value of the DPCH constant value is adjusted such that the mean UE output power is -10dBm.
- 4) The SS shall decrease the received P-CCPCH power level in the UE by 20 dB.
- 5) The time from the beginning of T2 until the UE blocks (stops using) UL\_TFC8 and UL\_TFC9 shall be measured by the SS. The UE shall stop using UL\_TFC8 and UL\_TFC9 within 170 ms from beginning of time period T2.
- 6) Repeat steps 3-5 [50] times.

##### 8.4.2.1.4.2.1A 1,28 Mcps TDD option

1. The UE is switched on.
2. The SS shall signal to the UE the allowed TFCS according to table above.
3. For T1=30 secs the SS shall ensure that the received P-CCPCH power level in the UE is set to -60dBm and that the value of the DPCH constant value is adjusted such that the mean UE output power is 10dB below the UE Maximum allowed UL TX power..
4. The system simulator shall continuously send TPC\_cmd=Up to the UE from the beginning of T2 until the end of T2.

NOTE: This will guarantee that UL\_TFC8 to UL\_TFC9 can not be supported because the UE reaches the maximum UL Tx power and the UTRAN SS continues sending power-up commands.

1. The time from the beginning of T2 until the UE blocks (stops using) UL\_TFC8 and UL\_TFC9 shall be measured by the SS. The UE shall stop using UL\_TFC8 and UL\_TFC9 within [250] ms from beginning of time period T2.
2. Repeat steps 3-5 until the confidence level according to annex F.6.2 is achieved.

NOTE: The delay from the beginning of T2 can be expressed as:  $T_{\text{ramp}} + T_{\text{detect\_block}} + T_{\text{notify}} + T_{\text{modify}} + T_{\text{L1\_proc}} + T_{\text{align\_TTI}}$ , where:

$T_{\text{ramp}}$  Margin added for the increase of UE output power to the UE maximum power. A margin of 7 frames (70ms) is used, i.e. 14 TPC commands.

$T_{\text{detect\_block}}$	The time needed to detect that UL_TFC8 and UL_TFC9 can no longer be supported, i.e. defines the maximum time to detect that the <i>Limited TFC Set</i> criterion is fulfilled for UL_TFC8 and UL_TFC9. This figure is currently TBD as X and Y in the general requirement, see section 6.4.2 of TS25.123 [2], are not finalised yet.
$T_{\text{notify}}$	Equal to [15] ms, the time allowed for MAC to indicate to higher layers that UL_TFC8 and UL_TFC9 can no longer be supported.
$T_{\text{modify}}$	Equal to $\text{MAX}(T_{\text{adapt\_max}}, T_{\text{TTI}}) = \text{MAX}(0, 40) = 40\text{ms}$
$T_{\text{adapt\_max}}$	Equals to 0ms for the case without codec.
$T_{\text{LL\_proc}}$	Equals 15ms.
$T_{\text{align\_TTI}}$	Align with the longest uplink TTI where the new TFC can be selected. The worst case equals 40ms in this test case.
$T_{\text{TTI}}$	Equals 40 ms in the test case.

This gives a maximum delay of  $(70 + T_{\text{detect\_block}} + [15] + 40 + 15 + 40)$  ms from the beginning of T2.

#### 8.4.2.1.4.2.2 7.68 Mcps TDD option

- 1) The UE is switched on.
- 2) The SS shall signal to the UE the allowed TFCS according to table 8.4.2.1.4.1.2.1.
- 3) For  $T1=30$  secs the SS shall ensure that the received P-CCPCH power level in the UE is set to  $-60\text{dBm}$  and that the value of the DPCH constant value is adjusted such that the mean UE output power is  $-10\text{dBm}$ .
- 4) The SS shall decrease the received P-CCPCH power level in the UE by 20 dB.
- 5) The time from the beginning of T2 until the UE blocks (stops using) UL\_TFC8 and UL\_TFC9 shall be measured by the SS. The UE shall stop using UL\_TFC8 and UL\_TFC9 within 170 ms from beginning of time period T2.
- 6) Repeat steps 3-5 [50] times.

#### 8.4.2.1.5 Test requirements

##### 8.4.2.1.5.1 3,84 Mcps TDD option

For the test to pass, the total number of successful tests shall be more than 90% with a confidence level of [FFS]% of the cases.

Note: If the above Test Requirement differs from the Minimum Requirement then the Test Tolerance applied for this test is non-zero. The Test Tolerance for this test is defined in clause F.2 and the explanation of how the Minimum Requirement has been relaxed by the Test Tolerance is given in clause F.4.

##### 8.4.2.1.5.1A 1,28 Mcps TDD option

For the test to pass, the total number of successful tests shall be more than 90% with a confidence level of 95% of the cases.

Note: If the above Test Requirement differs from the Minimum Requirement then the Test Tolerance applied for this test is non-zero. The Test Tolerance for this test is defined in clause F.2 and the explanation of how the Minimum Requirement has been relaxed by the Test Tolerance is given in clause F.

##### 8.4.2.1.5.2 7,68 Mcps TDD option

For the test to pass, the total number of successful tests shall be more than 90% with a confidence level of 95% of the cases.

Note: If the above Test Requirement differs from the Minimum Requirement then the Test Tolerance applied for this test is non-zero. The Test Tolerance for this test is defined in clause F.2 and the explanation of how the Minimum Requirement has been relaxed by the Test Tolerance is given in clause F.4.

### 8.4.3 E-TFC selection in UE

#### 8.4.3.1 3.84 Mcps option

Void.

#### 8.4.3.2 1.28 Mcps option

##### 8.4.3.2.1 5ms TTI E-DCH E-TFC selection

###### 8.4.3.2.1.1 Definition and applicability

The E-TFC selection delay is defined as the time from the moment SS starts to send TPC\_Cmd=+1 to the moment UE E-TFCI becomes 0. UE E-TFC selection is specified in section 11.9.1.4 in TS25.321.

The requirements and this test apply to the 1,28 Mcps TDD UE of release 7 and later supporting HSUPA.

###### 8.4.3.2.1.2 Minimum requirements

E-TFC selection is allowed only in the CELL\_DCH state.

UE will calculate the power of E-PUCH according to the expressions as follows: (Which is stated in TS 25.224 clause 4.2.2.4)

$$P_{E-PUCH} = P_{e-base} + L + \beta_e + K_{E-PUCH}$$

maximum supported transmission power for a certain E-TFC = max(maximum UE transmission power, E-PUCH transmission power).

where maximum UE transmission power is the maximum transmission power of UE.

E-PUCH transmission power is calculated by the expressions above with  $\beta_e = (AG + \alpha_e)_0$ .

The UE shall consider the *Blocking* criterion for a given E-TFC to be fulfilled if the estimated power of E-PUCH is larger than maximum supported transmission power for a certain E-TFC.

###### 8.4.3.2.1.3 Test Purpose

The purpose is to verify the UE stops using a currently used E-TFC when its power is not sufficient to support that E-TFC, and resumes using that E-TFC when its power is sufficient to support it.

This test is to verify the requirement for the cell re-selection delay in the single carrier case.

###### 8.4.3.2.1.4 Method of test

###### 8.4.3.2.1.4.1 Initial conditions

Test environment: normal, TL/VL, TL/VH, TH/VL, TH/VH; see clauses G.2.1 and G.2.2.

Frequencies to be tested: mid range; see clause G.2.4.

- 1) Connect the SS (node B emulator) to the UE antenna connector as shown in figure A.1.
- 2) The UL Reference Measurement Channel and the Fixed Reference Channels (FRC 1, QPSK) are specified in Annex C.6.1.2.1.

The test parameters are given in Table 8.4.3.2.1-1 and 8.4.3.2.1-2 below. The test consists of 3 time periods, with a time duration of T1, T2 and T3 respectively.

An E-DCH radio bearer shall be configured, so that UE is transmitting E-PUCH in the initial condition before the time T1, defined as T0.

Table 8.4.3.2.1-1: General test parameters

Parameter	Unit	Value	Comment
UL DPCH configuration		12.2kbps reference measurement channel	
E-DCH Transport Block Size Table		5ms TTI E-DCH Transport Block Size Table 0 according to TS 25.321 annex BC.1	
UL Power Control		On	
Active cell		Cell 1	
Maximum allowed UL TX power	dBm	24	For a class 4 UE maximum allowed TX power can still be signalled as 24dBm however the UE only has capability to transmit 21dBm
Propagation condition		AWGN	
$\Delta_{\text{harq}}$	dB	0	
Periodicity for Scheduling Info		Every TTI	
E-DCH MAC-D flow maximum number of retransmissions		0	
T1	S	30	
T2	S	10	
T3	S	10	

Table 8.4.3.2.1-2: Additional cell specific parameters

Parameter	Unit	Cell 1					
		0			DwPTS		
		T0	T1	T2	T0	T1	T2
UTRA RF Channel Number		Channel 1					
PCCPCH_Ec/lor		-3					
DwPCH_Ec/lor	dB	-3					
HS-SCCH_Ec/lor	dB	-1					
HS-SICH_Ec/lor	dB	-1					
HS-PDSCH_Ec/lor	dB	0					
E-AGCH_Ec/lor	dB	-10					
E-HICH_Ec/lor	dB	-10					
OCNS_Ec/lor	dB	Note 1					
$\hat{I}_{or}$	dBm/1.28 MHz	-65					

## 8.4.3.2.1.4.2 Procedure

- The SS activates cell 1 with T0 parameters defined in table 8.4.3.2.1-2.
- The UE is switched on.
- An E-DCH call is set up according to TS 34.108 [3] 7.3.9 with the following exceptions in the RADIO BEARER SETUP messages. These exceptions are derived from Table 8.4.3.2.1-3.
- Enter the UE into loopback mode 1 looping back E-DCH and start the loopback test. This way the UE is configured to transmit a data stream on the E-PUCH.
- The SS signals AG value = 31 on the E-AGCH continuously to give UE grants to make use of the maximum possible data rate.
- For T1=30 secs the SS shall send sufficient consecutive TPC\_cmd = +1 to the UE until the E-TFC of UE changes.
- From the start of T2 the system simulator shall send sufficient consecutive TPC\_cmd = +1 to the UE, and UE

shall decrease continuously the value of E-TFCI until E-TFCI becomes 0

- h) From the start of T3 the system simulator shall send shall send continuously TPC\_cmd = -1 (15 times )to the UE.
- i) Repeat steps f)-h) until the confidence level according to Annex F.6.2 is achieved.

#### 8.4.3.2.1.5 Test Requirements

- 1) In step d) and h), the amount of available user data shall be sufficient to allow E-DCH uplink transmission at the highest possible bit rate with E-DCH TB index 58.
- 2) In step g), the UE shall decrease E-TFCI to 0 within 150ms.

For the test to pass, the total number of successful tests shall be more than 90% with a confidence level of 95% of the cases.

#### Specific Message Contents

All messages indicated above shall use the same content as described in the default message content in clause 9 of 34.108, with the following exceptions:

Table 8.4.3.2.1-3 Contents of RADIO BEARER SETUP message: AM or UM (E-DCH and HSDPA)

Information Element/Group name	Value/Remark
E-PUCH Info(TDD only)	
>E-TFCS information	
>>Reference Beta Information QPSK list	
>>>Reference Code Rate	0.1
>>>Reference Beta	-15
>>Reference Beta Information QPSK list	
>>>Reference Code Rate	0.2
>>>Reference Beta	-14
>>Reference Beta Information QPSK list	
>>>Reference Code Rate	0.3
>>>Reference Beta	-13
>>Reference Beta Information QPSK list	
>>>Reference Code Rate	0.4
>>>Reference Beta	-12
>>Reference Beta Information QPSK list	
>>>Reference Code Rate	0.5
>>>Reference Beta	-10
>>Reference Beta Information QPSK list	
>>>Reference Code Rate	0.6
>>>Reference Beta	-9
>>Reference Beta Information QPSK list	
>>>Reference Code Rate	0.7
>>>Reference Beta	-8
>>Reference Beta Information QPSK list	
>>>Reference Code Rate	0.8
>>>Reference Beta	-7
>>Reference Beta Information QPSK list	
>>>Reference Code Rate	0.9
>>>Reference Beta	-6
>>Reference Beta Information 16QAM list	
>>>Reference Code Rate	0.2
>>>Reference Beta	-9
>>Reference Beta Information 16QAM list	
>>>Reference Code Rate	0.3
>>>Reference Beta	-8
>>Reference Beta Information 16QAM list	
>>>Reference Code Rate	0.4
>>>Reference Beta	-6
>>Reference Beta Information 16QAM list	
>>>Reference Code Rate	0.5
>>>Reference Beta	-5
>>Reference Beta Information 16QAM list	
>>>Reference Code Rate	0.6
>>>Reference Beta	-4
>>Reference Beta Information 16QAM list	
>>>Reference Code Rate	0.7
>>>Reference Beta	-2
>>Reference Beta Information 16QAM	



list	
>>>Reference Code Rate	0.8
>>>Reference Beta	-1
>>Reference Beta Information 16QAM	
list	
>>>Reference Code Rate	0.9
>>>Reference Beta	0
>CHOICE TDD mode	
>>1.28 Mcps TDD	
>>>PRXdes_base	-85
>>>Beacon PL Est.	
>>>TPC step size	1
>>>E-PUCH TS configuration list	
>>>>TS number	1
>>>>Minimum allowed code rate	0.1
>>>>Maximum allowed code rate	0.8

### 8.4.3.3 7.68 Mcps option

void

## 8.5 Timing Characteristics

### 8.5.1 UE Timing Advance

#### 8.5.1.1 3,84 Mcps TDD Option

##### 8.5.1.1.1 Definition and applicability

Timing advance is the correction to UE transmit timing required in order to avoid large delay spread at the Node B. The timing advance value is provided to the UE by UTRAN.

The requirements and this test apply to the TDD (3,84 Mcps option) UE.

##### 8.5.1.1.2 Minimum requirement

The UE shall adjust the timing of its transmissions with an accuracy better than or equal to  $\pm 0.5$  chip to the signalled timing advance value.

The normative reference for this requirement is TS 25.123 [2] clauses 7.1.1. and A.7.1.1

##### 8.5.1.1.3. Test purpose

To verify that the UE meets the minimum requirement.

##### 8.5.1.1.4 Method of test

###### 8.5.1.1.4.1 Initial conditions

Test environment: normal; see clauses G.2.1 and G.2.2.

Frequencies to be tested: mid range; see clause G.2.4.

The test parameters are given in table 8.5.1.1 and table 8.5.1.2. The test consists of two successive time periods, with a time duration of T1 and T2 respectively. At the start of time duration T1, the UE shall transmit with the Uplink Timing Advance value set to zero, i.e. Timing Advance disabled.

During time period T1, UTRAN shall send an Uplink Physical Channel control message with activation time at the beginning of T2. The Uplink Physical Channel Control message shall be sent to the UE such that the delay between the end of the last received TTI containing the message and the beginning of T2 is greater than or equal to the RRC procedure delay as defined in [9].

Table 8.5.1.1: General test parameters for Timing Advance test

Parameter		Unit	Value	Comment
DCH parameters			DL Reference Measurement Channel 12.2 kbps	As specified in TS 25.102 section A.2.2
Power Control			On	
Target quality value on DTCH		BLER	0.01	
Initial conditions	Timing Advance value		0	IE "Uplink timing advance control" value disabled.
Final condition	Timing Advance value		5	IE "Uplink timing advance" value set to 5.
Monitored cell list size			6 TDD neighbors on Channel 1	
	$T_{SI}$	S	1,28	The value shall be used for all cells in the test.
	T1	S	5	
	T2	S	5	

Table 8.5.1.2: Cell specific test parameters for Timing Advance test

Parameter	Unit	Cell 1			
		0		2	
DL timeslot number		T1	T2	T1	T2
UTRA RF Channel Number		Channel 1			
PCCPCH_Ec/I <sub>or</sub>	dB	-3		n.a.	
SCH_Ec/I <sub>or</sub>	dB	-9		n.a.	
SCH_t <sub>offset</sub>	dB	0		n.a.	
DPCH_Ec/I <sub>or</sub>	dB	n.a.		Note 1	
OCNS_Ec/I <sub>or</sub>	dB	-3,12		Note 2	
$\hat{I}_{or}/I_{oc}$	dB	3			
$I_{oc}$	dBm/ 3,84 MHz	-70			
Propagation Condition		AWGN			
Note 1: The DPCH level is controlled by the power control loop					
Note 2: The power of the OCNS channel that is added shall make the total power from the cell to be equal to I <sub>or</sub> .					

#### 8.5.1.1.4.2 Procedure

- 1) The RF parameters are set up according to T1.
- 2) The UE is switched on.
- 3) A call is set up according to the generic set-up procedure specified in TS 34.108 [3] subclause 7.4.2 to place the UE in CELL\_DCH.
- 4) At the start of time interval T1, the SS shall transmit an UPLINK PHYSICAL CHANNEL CONTROL message with timing advance disabled
- 5) During the interval T1, the SS shall transmit an UPLINK PHYSICAL CHANNEL CONTROL message with timing advance enabled and the timing advance value set to 5.
- 6) UE shall apply the signalled timing advance value.
- 7) After 10 seconds, the UE is switched off.
- 8) Repeat Step 1-7 [TBD] times

#### Specific Message Contents

All messages indicated above shall use the same content as described in the default message content in clause 9 of 34.108 [3] with the following exceptions:

UPLINK PHYSICAL CHANNEL CONTROL message (step 4):

Information Element/Group name	Value/Remark
Message Type (10.2.17)	
<b>UE information elements</b>	
-RRC transaction identifier	0
-Integrity check info	Not Present
<b>PhyCH Information elements</b>	
-CCTrCH Power Control Info	Not Present
-Choice <i>TDD Option</i>	3,84 Mcps TDD
-Alpha	Not Present
-Special Burst Scheduling	Not Present
-Timing Advance Control (10.3.6.96)	
-Choice <i>Timing Advance</i>	Disabled
-PRACH Constant Value	Not Present
-PUSCH Constant Value	Not Present
-UE positioning related parameters	Not Present

UPLINK PHYSICAL CHANNEL CONTROL message (step 5):

Information Element/Group name	Value/Remark
Message Type (10.2.17)	
<b>UE information elements</b>	
-RRC transaction identifier	0
-Integrity check info	Not Present
<b>PhyCH Information elements</b>	
-CCTrCH Power Control Info	Not Present
-Choice <i>TDD Option</i>	3,84 Mcps TDD
-Alpha	Not Present
-Special Burst Scheduling	Not Present
-Timing Advance Control (10.3.6.96)	
-Choice <i>Timing Advance</i>	Enabled
-Choice <i>TDD Option</i>	3,84 Mcps TDD
-UL Timing Advance (10.3.6.9.95)	5
-Activation Time	At T2
-PRACH Constant Value	Not Present
-PUSCH Constant Value	Not Present
-UE positioning related parameters	Not Present

### 8.5.1.1.5 Test requirements

The UE shall apply the signalled Timing Advance value to the UL DPCH transmission timing at the designated activation time, i.e the beginning of time period T2. The Timing Advance adjustment accuracy shall be within  $\pm 0.5$  chip.

For the test to pass, the total number of successful tests shall be more than 90% with a confidence level of [FFS]% of the cases.

### 8.5.1.2 1,28 Mcps TDD Option

#### 8.5.1.2.1 Definition and applicability

Timing advance is applied to adjust the UE transmit time in order to ensure that all the signal received by the BS is synchronised. The timing advance value is provided to the UE by UTRAN.

The requirements and this test apply to the TDD (1.28 Mcps TDD option) UE.

#### 8.5.1.2.2 Minimum requirement

The UE transmitter shall have the capability of changing the transmission timing with a step size of  $1/8, 2/8, 3/8, \dots, 1$  chip according to the value of  $\Delta_{SS}$ , within  $n=(1,2,\dots,6)$  time slots excluding special timeslots (DwPTS, GP, UpPTS) after the SS\_cmd arrived (closed loop). For the open loop any step being a multiple of  $1/8$  chip has to be allowed.

The minimum transmission timing step  $\Delta_{SS,min}$  due to closed loop uplink synchronization control shall be within the range shown in Table 8.5.1.1A.

**Table 8.5.1.1A: Uplink synchronisation control range**

SS_cmd	Uplink synchronisation control range for minimum step	
	1/8 chip step size	
	Lower	Upper
Up	1/9 chip	1/7 chip
Down	1/9 chip	1/7 chip

**8.5.1.2.3. Test purpose**

The purpose of this test is to verify the ability of the UE to adjust its timing advance according to the SS commands within the specified accuracy defined in TS 25.123 [2] section 7.1.2.

**8.5.1.2.4 Method of test****8.5.1.2.4.1 Initial conditions**

Test environment: normal; see clauses G.2.1 and G.2.2.

Frequencies to be tested: mid range; see clause G.2.4.

The test parameters are given in table 8.5.1.1A and table 8.5.1.2A.

**Table 8.5.1.2A: General test parameters for Timing Advance test**

Parameter	Unit	Value	Comment
DCH parameters		DL and UL Reference Measurement Channel 12.2 kbps	As specified in TS 25.102 section A.2.2
Power Control		On	
Target quality value on DTCH	BLER	0.01	
Monitored cell list size		6 TDD neighbours on Channel 1	

**Table 8.5.1.3A: Cell specific test parameters for Timing Advance test**

Parameter	Unit	Cell 1
Timeslot Number		0 DwPTS
UTRA RF Channel Number		Channel 1
PCCPCH_Ec/lor	dB	-3
DwPCH_Ec/lor	dB	0
OCNS_Ec/lor	dB	-3
$\hat{I}_{or}/I_{oc}$	dB	6
$I_{oc}$	dBm/ 1.28 MHz	-80
PCCPCH RSCP	dBm	-77
Propagation Condition		AWGN

**8.5.1.2.4.2 Procedure**

- 1) The RF parameters are set up according to table 8.5.1.2A..
- 2) Connect the SS to the UE antenna connector as shown in figure A.1.
- 3) A call is set up according to the Generic call setup procedure.
- 4) Enter the UE into loopback test mode and start the loopback test.  
See TS 34.108 [3] and TS 34.109 [4] for details regarding generic call setup procedure and loopback test.
- 5) Configure the uplink channel to set UE transmitter to enable synchronisation steps of size 1/8 chip.
- 6) Send a synchronisation shift (SS) commands with the value "00"(Down )to the UE under test
- 7) Send a synchronisation shift (SS) commands with the value "11"(Up) to the UE under test
- 8) Repeat steps 6-7 until [TBD] times.

## Specific Message Contents

All messages indicated above shall use the same content as described in the default message content in clause 9 of 34.108 [3] with the following exceptions:

### 8.5.1.2.5 Test requirements

In step 6 and step7, The UE transmitter timing due to closed loop uplink synchronization control shall be within the range shown in 8.5.1.4A.

**Table 8.5.1.4A: Uplink synchronisation control range**

SS_cmd	Lower	Upper
Up	1/9 chip-[TBD]ns	1/7 chip+[TBD]ns
Down	1/9 chip-[TBD]ns	1/7 chip+[TBD]ns

For the test to pass, the total number of successful tests shall be more than 90% with a confidence level of 95% of the cases.

### 8.5.1.3 7,68 Mcps TDD Option

#### 8.5.1.3.1 Definition and applicability

Timing advance is the correction to UE transmit timing required in order to avoid large delay spread at the Node B. The timing advance value is provided to the UE by UTRAN.

The requirements and this test apply to the TDD (7,68 Mcps option) UE.

#### 8.5.1.3.2 Minimum requirement

The UE shall adjust the timing of its transmissions with an accuracy better than or equal to  $\pm 0.5$  chip to the signalled timing advance value.

The normative reference for this requirement is TS 25.123 [2] clauses 7.1.3. and A.7.1.3

#### 8.5.1.3.3 Test purpose

To verify that the UE meets the minimum requirement.

#### 8.5.1.3.4 Method of test

##### 8.5.1.3.4.1 Initial conditions

Test environment: normal; see clauses G.2.1 and G.2.2.

Frequencies to be tested: mid range; see clause G.2.4.

The test parameters are given in table 8.5.1.3.4.1.1 and table 8.5.1.3.4.1.2. The test consists of two successive time periods, with a time duration of T1 and T2 respectively. At the start of time duration T1, the UE shall transmit with the Uplink Timing Advance value set to zero, i.e. Timing Advance disabled.

During time period T1, UTRAN shall send an Uplink Physical Channel control message with activation time at the beginning of T2. The Uplink Physical Channel Control message shall be sent to the UE such that the delay between the end of the last received TTI containing the message and the beginning of T2 is greater than or equal to the RRC procedure delay as defined in [9].

**Table 8.5.1.3.4.1.1: General test parameters for Timing Advance test**

Parameter		Unit	Value	Comment
DCH parameters			DL Reference Measurement Channel 12.2 kbps	As specified in TS 25.102 section A.2.2
Power Control			On	
Target quality value on DTCH		BLER	0.01	
Initial conditions	Timing Advance value		0	IE "Uplink timing advance" value zero or IE "Uplink timing advance control" value disabled.
Final condition	Timing Advance value		5	IE "Uplink timing advance" value set to 5.
Monitored cell list size			6 TDD neighbors on Channel 1	
	T <sub>SI</sub>	s	1.28	The value shall be used for all cells in the test.
	T1	s	5	
	T2	s	5	

**Table 8.5.1.3.4.1.2: Cell specific test parameters for Timing Advance test**

Parameter	Unit	Cell 1			
		0		2	
DL timeslot number		T1	T2	T1	T2
UTRA RF Channel Number		Channel 1			
PCCPCH_Ec/I <sub>or</sub>	dB	-3		n.a.	
SCH_Ec/I <sub>or</sub>	dB	-9		n.a.	
SCH_t <sub>offset</sub>	dB	0		n.a.	
DPCH_Ec/I <sub>or</sub>	dB	n.a.		Note 1	
OCNS_Ec/I <sub>or</sub>	dB	-3,12		Note 2	
$\hat{I}_{or}/I_{oc}$	dB	3			
I <sub>oc</sub>	dBm/ 7,68 MHz	-70			
Propagation Condition		AWGN			
Note 1: The DPCH level is controlled by the power control loop					
Note 2: The power of the OCNS channel that is added shall make the total power from the cell to be equal to I <sub>or</sub> .					

#### 8.5.1.3.4.2 Procedure

- 1) The RF parameters are set up according to T1.
- 2) The UE is switched on.
- 3) A call is set up according to the generic set-up procedure specified in TS 34.108 [3] subclause 7.4.2 to place the UE in CELL\_DCH.
- 4) At the start of time interval T1, the SS shall transmit an UPLINK PHYSICAL CHANNEL CONTROL message with timing advance disabled
- 5) During the interval T1, the SS shall transmit an UPLINK PHYSICAL CHANNEL CONTROL message with timing advance enabled and the timing advance value set to 5.
- 6) UE shall apply the signalled timing advance value.
- 9) After 10 seconds, the UE is switched off.
- 10) Repeat Step 1-7 until the confidence level according to annex F.6.2 is achieved.

#### Specific Message Contents

All messages indicated above shall use the same content as described in the default message content in clause 9 of 34.108 [3] with the following exceptions:

UPLINK PHYSICAL CHANNEL CONTROL message (step 4):

Information Element/Group name	Value/Remark
Message Type (10.2.17)	
<b>UE information elements</b>	
-RRC transaction identifier	0
-Integrity check info	Not Present
<b>PhyCH Information elements</b>	
-CCTrCH Power Control Info	Not Present
-Choice <i>TDD Option</i>	7,68 Mcps TDD
-Alpha	Not Present
-Special Burst Scheduling	Not Present
-Timing Advance Control (10.3.6.96)	
-Choice <i>Timing Advance</i>	Disabled
-PRACH Constant Value	Not Present
-PUSCH Constant Value	Not Present
-UE positioning related parameters	Not Present
-HS-SICH power control info	Not Present

UPLINK PHYSICAL CHANNEL CONTROL message (step 5):

Information Element/Group name	Value/Remark
Message Type (10.2.17)	
<b>UE information elements</b>	
-RRC transaction identifier	0
-Integrity check info	Not Present
<b>PhyCH Information elements</b>	
-CCTrCH Power Control Info	Not Present
-Choice <i>TDD Option</i>	7,68 Mcps TDD
-Alpha	Not Present
-Special Burst Scheduling	Not Present
-Timing Advance Control (10.3.6.96)	
-Choice <i>Timing Advance</i>	Enabled
-Choice <i>TDD Option</i>	7,68 Mcps TDD
-Extended UL Timing Advance (10.3.6.9.95a)	10
-Activation Time	At T2
-PRACH Constant Value	Not Present
-PUSCH Constant Value	Not Present
-UE positioning related parameters	Not Present

### 8.5.1.3.5 Test requirements

The UE shall apply the signalled Timing Advance value to the UL DPCH transmission timing at the designated activation time, i.e the beginning of time period T2. The Timing Advance adjustment accuracy shall be within  $\pm 0.5$  chip.

For the test to pass, the total number of successful tests shall be more than 90% with a confidence level of [FFS]% of the cases.

## 8.5.2 UE Transmit Timing

Void.

## 8.5.3 UE Uplink Synchronization

### 8.5.3.1 3,84 Mcps TDD option

Void.

### 8.5.3.2 1,28 Mcps TDD option

#### 8.5.3.2.1 Uplink synchronization control for PRACH

##### 8.5.3.2.1.1 Definition and applicability

The establishment of uplink synchronization is done during the random access procedure and involves the UpPCH and the PRACH. To update timing advance of a UE, the UTRAN measures SYNC-UL Timing deviation. Uplink synchronization control for PRACH is used to adjust its synchronisation shift by means of signalling the received position of the UpPTS in the FPACH.

The random access is specified in clause 5.6 of TS 25.224 and the random access transmit sequence is described in clause 6.7.3.2 of TS 25.303 and the uplink synchronization control for PRACH is defined in clause 5.2 of TS25.224.

The requirements and this test apply to all types of 1.28 Mcps TDD UE.

##### 8.5.3.2.1.2 Minimum requirement

The time of the beginning of the PRACH  $T_{TX-PRACH}$  is given by:

$$T_{TX-PRACH} = T_{RX-PRACH} - (UpPCH_{ADV} + UpPCH_{POS} - 8*16 T_C)$$

in multiple of 1/8 chips.

Then the timing advance for PRACH is given by:

$$T_{ADV-PRACH} = T_{RX-PRACH} - T_{TX-PRACH} = (UpPCH_{ADV} + UpPCH_{POS} - 8*16 T_C)$$

$T_{TX-PRACH}$  is the beginning time of PRACH transmission with the UE's timing,

$T_{RX-PRACH}$  is the beginning time of PRACH reception with the UE's timing if the PRACH was a DL channel.

$UpPCH_{POS}$  is the received SYNC-UL timing deviation measured by UTRAN.

$UpPCH_{ADV}$  is the timing advance of SYNC-UL given by UE.

The uplink synchronization accuracy for PRACH is defined as PRACH timing deviation between received PRACH position and desired PRACH position. The accuracy requirements of uplink synchronization control for PRACH are decided by the accuracy of UpPCH timing advance  $UpPCH_{ADV}$  measured by UE and the accuracy of SYNC-UL timing deviation  $UpPCH_{POS}$  measured by UTRAN, which refer to clause 9.1.2.2 and clause 9.2.1.10 of TS 25.123.

**Table 8.5.3.2.1.1: Uplink synchronisation control accuracy requirements for PRACH**

Parameter	Unit	Accuracy [chip]	Conditions
			$I_0$ [dBm/ 1.28 MHz]
Uplink synchronization control for PRACH	chip	+/- 0.5	-94...-50

##### 8.5.3.2.1.3 Test purpose

The purpose of this test is to verify the ability of the UE to archive its uplink synchronization control for PRACH within the specified accuracy according to the requirements.

##### 8.5.3.2.1.4 Method of test

###### 8.5.3.2.1.4.1 Initial conditions

Test environment: normal; see clauses G.2.1 and G2.2

Frequencies to be tested: mid range; see clause G.2.4.



**Table 8.5.3.2.1.2: RF Parameters for Random Access test**

Parameter	Unit	Cell 1
UTRA RF Channel Number		Channel 1
PCCPCH_Ec/Ior	dB	-3
OCNS_Ec/Ior	dB	-3
$\hat{I}_{or}/I_{oc}$	dB	10
$I_{oc}$	dBm/1.28 MHz	-70
PCCPCH_RSCP	dBm/1.28MHz	-63
Propagation Condition		AWGN

The test parameters "System Information Block (SIB) type 5 (ASC #0)" defined in clause 6.1 of TS 34.108 , shall be used in all random access tests. Crucial parameters for the test requirements are repeated in tables 8.5.3.2.1.3 and these overrule the parameters defined in SIB type 5.A parameter of AC-to-ASC mapping(AC0-9) in SIB5 of clause 6.1 of TS 34.108 shall be set to 0 in the case of all random access tests.

**Table 8.5.3.2.1.3: UE/SS parameters for Random Access test**

Parameter	Unit	Value
Access Service Class (ASC#0)	0..1	1
- Persistence value		
PCCPCH Power -Broadcast	dB	18
Max SYNC_UL Transmissions		8
Power step when no acquisition indicator is received (Pwr <sub>ramp</sub> )	dB	1
Maximum allowed UL TX power	dBm	21
Desired UpPCH RX power at the cell's receiver (PRX <sub>UpPCHdes</sub> )	dBm	-100

#### 8.5.3.2.1.4.2 Procedure

- 1) A call is set up according to the Generic call setup procedure. The test parameters are set up according to Table 8.5.3.2.1.2, and Table 8.5.3.2.1.3, set the value of Pwr<sub>ramp</sub> as 1dB.
- 2) The PRACH procedure within the call setup is used for the test. It is necessary that an ACK on FPACH with correct UpPCH<sub>POS</sub> shall be transmitted by the SS.
- 3) Measure the first PRACH timing position and calculate the timing deviation between received PRACH position and desired PRACH position. If PRACH timing deviation fulfills test requirement in Table 8.5.3.2.1.4,the correct counter is accumulated by 1.Otherwise the incorrect counter is accumulated by 1.
- 4) The call procedure is set up successfully and SS release RRC connection.

#### 8.5.3.2.1.5 Test requirements

The UE shall not exceed the accuracy requirements as Table 8.5.3.2.1.4.

**Table 8.5.3.2.1.4: Uplink synchronisation control accuracy requirements for PRACH**

Parameter	Unit	Accuracy [chip]	Conditions
			Io [dBm/ 1.28 MHz]
Uplink synchronization control for PRACH	chip	+/- 0.5	-94...-50

The rate of correct uplink synchronisation control observed during repeated tests shall be at least 90%.

### 8.5.3.2.2 Uplink synchronization control during handover

#### 8.5.3.2.2.1 Scenario 1: Handover to intra-frequency cell

This test case is applicable for UE handovers in single frequency network and UE handovers from primary frequency to primary frequency in multi-frequency network.

##### 8.5.3.2.2.1.1 Definition and applicability

The closed loop uplink synchronisation control uses layer 1 symbols (SS commands) for DPCH and PUSCH. After establishment of the uplink synchronisation, NodeB and UE start to use the closed loop UL synchronisation control procedure. This procedure is continuous during connected mode.

During a handover the UE shall transmit in the new cell with timing advance TA adjusted by the relative timing difference  $\Delta t$  between the new and the old cell if indicated by higher layers:

$$TA_{\text{new}} = TA_{\text{old}} + 2\Delta t.$$

$TA_{\text{new}}$  is the timing advance of the new cell.

$TA_{\text{old}}$  is the timing advance of the old cell,

$\Delta t$  is the relative timing difference between the new and the old cell, which is measured by UE as SFN-SFN observed time difference type 2.

The uplink synchronization accuracy during handover is defined as timing deviation between the initial actual uplink synchronization position and the desired position of the first uplink DPCH on the target cell.

The requirements and this test apply to all types of 1.28 Mcps TDD UE.

##### 8.5.3.2.2.1.2 Minimum requirement

The UE shall not exceed the accuracy requirements as Table 8.5.3.2.2.1.

**Table 8.5.3.2.2.1: Uplink synchronisation control accuracy requirements**

Parameter	Unit	Accuracy [chip]	Conditions
			$I_0$ [dBm/ 1.28 MHz]
Uplink synchronization control during handover	chip	+/- 0.5	-94...-50

The rate of correct uplink synchronisation control observed during repeated tests shall be at least 90% with a confidence level of 95%.

##### 8.5.3.2.2.1.3 Test purpose

The purpose of this test is to verify the requirement for the uplink synchronization control during intra-frequency handover in CELL\_DCH state in minimum requirement .

##### 8.5.3.2.2.1.4 Initial conditions

The test parameters are given in Table 8.5.3.2.2.2 and 8.5.3.2.2.3 as below. The test consists of three successive time periods, with a time duration of T1, T2 and T3 respectively. At the start of time duration T1, the UE may not have any timing information of cell 2.

UTRAN shall send a Physical Channel reconfiguration with activation time "now" at the beginning of T3 with a new active cell, cell 2, after the UE has reported event 1G. The starting point of T3 is defined as the end of the last TTI containing the physical channel reconfiguration message.

**Table 8.5.3.2.2.2: General test parameters for intra-frequency handover**

Parameter		Unit	Value	Comment
DPCH parameters			DL and UL Reference Measurement Channel 12.2 kbps	As specified in TS 25.102 section A.2.2.2 and A.2.1.2
Power Control			On	
Target quality value on DPCH		BLER	0.01	
Initial conditions	Active cell		Cell 1	In the case of multi-frequency network, the UE has a RRC connection on the primary frequency in cell 1.
	Neighbouring cell		Cell 2	
Final condition	Active cell		Cell 2	In the case of multifrequency network, UE will handover to the primary frequency in cell 2.
O		dB	0	cell-individual-offset The value shall be used for all cells in the test.
Hysteresis		dB	0	
Time to Trigger		ms	0	
Filter coefficient			0	
Monitored cell list size			6 TDD neighbours on Channel 1	
T1		s	5	
T2		s	5	
T3		s	5	

Table 8.5.3.2.2.3: Cell specific test parameters for intra-frequency handover

Parameter	Unit	Cell 1								
		0			DwPTS			5		
Timeslot Number		T1	T2	T3	T1	T2	T3	T1	T2	T3
UTRA RF Channel Number(Note3)		Channel 1								
PCCPCH_Ec/Ior	dB	-3						n.a.		
DwPCH_Ec/Ior					0					
DPCH_Ec/Ior	dB	n.a.			n.a.			Note1	n.a.	
OCNS_Ec/Ior	dB	-3						Note2		
$\hat{I}_{or}/I_{oc}$	dB	3			3			3		
$I_{oc}$	dBm/ 1.28 MHz	-70								
PCCPCH_RSCP	dBm	-70			n.a.			n.a.		
Propagation Condition		AWGN								
Parameter	Unit	Cell 2								
Timeslot Number		0			DwPTS			5		
Timeslot Number		T1	T2	T3	T1	T2	T3	T1	T2	T3
UTRA RF Channel Number(Note3)		Channel 1								
PCCPCH_Ec/Ior	dB	-3						n.a.		
DwPCH_Ec/Ior					0					
DPCH_Ec/Ior	dB	n.a.			n.a.			n.a.	Note1	
OCNS_Ec/Ior	dB	-3						Note2		
$\hat{I}_{or}/I_{oc}$	dB	-Inf.	6		-Inf.	6		-Inf.	6	
$I_{oc}$	dBm/ 1.28 MHz	-70								
PCCPCH_RSCP	dBm	-Inf.	-67		n.a.			n.a.		
Propagation Condition		AWGN								
Note 1: The DPCH level is controlled by the power control loop Note 2: The power of the OCNS channel that is added shall make the total power from the cell to be equal to $I_{or}$ . Note 3: In the case of multi-frequency network, the UTRA RF Channel Number is the primary frequency's channel number.										

## 8.5.3.2.2.1.5 Procedure

- 1) The RF parameters are set up according to T1.
- 2) The UE is switched on.
- 3) A call is set up according to the test procedure specified in TS 34.108 [3] subclause 7.3.4.
- 4) SS shall transmit a MEASUREMENT CONTROL message.
- 5) After 5 seconds, the SS shall switch the power settings from T1 to T2.
- 6) UE shall transmit a MEASUREMENT REPORT message triggered by event 1G.
- 7) SS shall transmit a PHYSICAL CHANNEL RECONFIGURATION message with activation time "now".
- 8) After 5 seconds, the SS shall switch the power settings from T2 to T3
- 9) The UE transmits the UL DPCH to cell 2 less than 1 s from the beginning of time period T3 and UTRAN measures the initial uplink synchronization timing position of the first UL DPCH on cell2 and compares it with the desired position. If the timing deviation is less than the accuracy requirement as specified in Table 8.5.3.2.2.4, the number of successful tests is increased by one. And UE shall transmit a PHYSICAL CHANNEL RECONFIGURATION COMPLETE message on the UL DCCH of cell 2.
- 10) After 5 seconds, the UE is switched off. Any timing information of cell 2 is deleted in the UE.

11) Repeat step 1-10 until the confidence level according to annex F.6.2 is achieved.

#### Specific Message Contents

All messages indicated above shall use the same content as described in the default message content in clause 9 of 34.108 [3] with the following exceptions:

MEASUREMENT CONTROL message (step 4):

Information Element/Group name	Value/Remark
Message Type (10.2.17)	
<b>UE information elements</b>	
-RRC transaction identifier	0
-Integrity check info	Not Present
<b>Measurement Information elements</b>	
-Measurement Identity	1
-Measurement Command (10.3.7.46)	Modify
-Measurement Reporting Mode (10.3.7.49)	AM RLC
-Periodical Reporting / Event Trigger Reporting Mode	Event trigger
-Additional measurements list (10.3.7.1)	Not Present
-CHOICE <i>Measurement type</i>	Intra-frequency measurement
-Intra-frequency measurement (10.3.7.36)	
-Intra-frequency measurement objects list (10.3.7.33)	Not Present
-Intra-frequency measurement quantity (10.3.7.38)	
-Filter coefficient (10.3.7.9)	0
-CHOICE <i>mode</i>	TDD
-Measurement quantity list	1
-Measurement quantity	Primary CCPCH
-Intra-frequency reporting quantity (10.3.7.41)	
-Reporting quantities for active set cells (10.3.7.5)	No report
-SFN-SFN observed time difference reporting indicator	TRUE (Note 1)
-Cell synchronisation information reporting indicator	TRUE
-Cell Identity reporting indicator	TRUE
-CHOICE <i>mode</i>	TDD
-Timeslot ISCP reporting indicator	TRUE
-Primary CCPCH RSCP reporting indicator	TRUE
-Pathloss reporting indicator	TRUE
-Reporting quantities for monitored set cells (10.3.7.5)	No report
-SFN-SFN observed time difference reporting indicator	TRUE (Note 1)
-Cell synchronisation information reporting indicator	TRUE
-Cell Identity reporting indicator	TRUE
-CHOICE <i>mode</i>	TDD
-Timeslot ISCP reporting indicator	TRUE
-Proposed TGSN reporting required	FALSE
-Primary CCPCH RSCP reporting indicator	TRUE
-Pathloss reporting indicator	TRUE
-Reporting quantities for detected set cells (10.3.7.5)	Not Present
-Reporting cell status (10.3.7.61)	
-CHOICE <i>reported cell</i>	Report all active set cells + cells within monitored set on used frequency
-Maximum number of reported cells	2
-Measurement validity (10.3.7.51)	Not Present
-CHOICE <i>report criteria</i>	Intra-frequency measurement reporting criteria
-Intra-frequency measurement reporting criteria (10.3.7.39)	
-Parameters required for each event	1
-Intra-frequency event identity	Event 1G
-Triggering condition 2	Not Present
-Reporting Range Constant	Not Present
-Cells forbidden to affect Reporting Range	Not Present
-W	Not Present
-Hysteresis	0 dB
-Threshold used frequency	Not Present
-Reporting deactivation threshold	Not Present
-Replacement activation threshold	Not Present
-Time to trigger	0 ms
-Amount of reporting	Infinity
-Reporting interval	0 ms (Note 2)
-Reporting cell status	Not Present
<b>Physical channel information elements</b>	
-DPCH compressed mode status info (10.3.6.34)	Not Present

Information Element/Group name	Value/Remark
Note 1:	The SFN-CFN observed time difference is calculated from the OFF and Tm parameters contained in the IE "Cell synchronisation information", TS 25.331, clause 10.3.7.6. According to TS 25.331, 8.6.7.7, this IE is included in MEASUREMENT REPORT if IE "Cell synchronisation information reporting indicator" in IE "Cell reporting quantities" TS 25.331, clause 10.3.7.5 is set to TRUE in MEASUREMENT CONTROL.
Note 2:	Reporting interval = 0 ms means no periodical reporting

## PHYSICAL CHANNEL RECONFIGURATION message (step 7):

Information Element	Value/Remark
Message Type	
<b>UE Information Elements</b>	
-RRC transaction identifier	0
-Integrity check info	Not Present
-Integrity protection mode info	Not Present
-Ciphering mode info	Not Present
-Activation time	At T3
-New U-RNTI	Not Present
-New C-RNTI	Not Present
-RRC State Indicator	CELL_DCH
-UTRAN DRX cycle length coefficient	Not Present
<b>CN Information Elements</b>	
-CN Information info	Not Present
<b>UTRAN mobility information elements</b>	
-URA identity	Not Present
<b>RB information elements</b>	
-Downlink counter synchronisation info	Not Present
-RB with PDCP information list	Not Present
-RB with PDCP information	Not Present
<b>PhyCH information elements</b>	
-Frequency info (10.3.6.36)	
-CHOICE <i>mode</i>	TDD
-UARFCN (Nt)	Same UARFCN as used for cell 2
<b>Uplink radio resources</b>	
-Maximum allowed UL TX power	30 dBm
-CHOICE <i>channel requirement</i>	Uplink DPCH info
-Uplink DPCH info (10.3.6.88)	
-Uplink DPCH power control info (10.3.6.91)	
-CHOICE <i>mode</i>	TDD
-TDD	1,28 Mcps TDD
-UL target SIR	Not Present
-CHOICE <i>UL OL PC info</i>	Individually signalled
-CHOICE <i>TDD option</i>	
--1,28 Mcps TDD	1
-TPC step size	1
-CHOICE <i>mode</i>	TDD
-Uplink timing advance control (10.3.6.96)	
-CHOICE <i>Timing Advance</i>	Disabled
-UL CCTrCH list	1
-UL Target SIR	9 dB
-Time Info (10.3.6.83)	
-Activation Time	now
-Duration	Infinite
-Common timeslot info	Not Present
-Uplink DPCH timeslots and codes (10.3.6.94)	
-Dynamic SF Usage	False
-First individual timeslot info (10.3.6.37)	
-Timeslot Number (10.3.6.84)	
-CHOICE <i>TDD option</i>	1,28 Mcps
-Timeslot number	2
-TFCl existence	True
-Midamble shift and burst type (10.3.6.41)	
-Choice <i>TDD option</i>	1,28 Mcps
-Midamble Allocation Mode	Default
-Midamble configuration	16
-Midamble shift	Not present
-CHOICE <i>TDD option</i>	1,28 Mcps
-Modulation	QPSK
-SS-TPC Symbols	
-Additional TPC-SS Symbols	
-First timeslot code list	1
-Channelisation code	8/1
-Choice more timeslots	No more timeslots
<b>Downlink radio resources</b>	
-CHOICE <i>mode</i>	TDD



Information Element	Value/Remark
-Downlink information common for all radio links (10.3.6.24)	
-Downlink DPCH info common for all RL (10.3.6.18)	
-Timing indicator	Initialise
-CFN-targetSFN frame offset	Not Present
-Downlink DPCH power control information (10.3.6.23)	
-CHOICE <i>mode</i>	TDD
-TPC Step size	1 dB
-CHOICE <i>mode</i>	TDD
-CHOICE <i>mode</i>	TDD
-CHOICE <i>TDD option</i>	1,28 Mcps
- <i>TSTD indicator</i> (10.3.6.85a)	TRUE
-Default DPCH Offset Value (10.3.6.16)	0
-Downlink information per radio link list	1
-Downlink information for each radio link (10.3.6.27)	
-CHOICE <i>mode</i>	TDD
-Primary CCPCH info (10.3.6.57)	
-CHOICE <i>mode</i>	TDD
-CHOICE <i>TDD option</i>	1,28 Mcps
<i>TSTD indicator</i>	TRUE
-Cell parameters ID	0
-SCTD indicator	False
-Downlink DPCH info for each RL (10.3.6.21)	
-CHOICE <i>mode</i>	TDD
-DL CCTrCH list	1
-TFCS ID	Not Present
-Time Info (10.3.6.83)	
-Activation Time	now
-Duration	Infinite
-Common timeslot info	Not Present
-Downlink DPCH timeslots and codes (10.3.6.32)	
-First individual timeslot info (10.3.6.37)	
-Timeslot Number (10.3.6.84)	
-CHOICE <i>TDD option</i>	1,28 Mcps
-Timeslot number	5
-TFCI existence	True
-Midamble shift and burst type (10.3.6.41)	
-CHOICE <i>TDD option</i>	1,28 Mcps
-Midamble Allocation Mode	Default
-Midamble configuration	16
-Midamble shift	Not present
-CHOICE <i>TDD option</i>	1,28 Mcps
-Modulation	QPSK
-SS-TPC Symbols	
-Additional TPC-SS Symbols	
-First timeslot channelisation codes (10.3.6.17)	
-CHOICE <i>codes representation</i>	Consecutive codes
-First channelisation code	16/1
-Last channelisation code	16/2
-CHOICE <i>more timeslots</i>	No more timeslots
-SCCPCH information for FACH (10.3.6.70)	Not Present

MEASUREMENT REPORT message for Intra frequency test cases

This message is common for all intra frequency test cases in clause 8.7 and is described in Annex I.

#### 8.5.3.2.2.1.6 Test requirements

The UE shall not exceed the accuracy requirements as Table 8.5.3.2.2.4.

**Table 8.5.3.2.2.4: Uplink synchronisation control accuracy requirements**

Parameter	Unit	Accuracy [chip]	Conditions
			Io [dBm/ 1.28 MHz]
Uplink synchronization control during handover	chip	+/- 0.5	-94...-50

The rate of correct handovers observed during repeated tests shall be at least 90% with a confidence level of 95%.

#### 8.5.3.2.2.2 Scenario 2: Handover to inter-frequency cell

This test case is applicable for UE handovers in single frequency network and UE handovers from primary frequency to secondary frequency in multi-frequency network.

##### 8.5.3.2.2.2.1 Definition and applicability

The closed loop uplink synchronisation control uses layer 1 symbols (SS commands) for DPCH and PUSCH. After establishment of the uplink synchronisation, NodeB and UE start to use the closed loop UL synchronisation control procedure. This procedure is continuous during connected mode.

During a handover the UE shall transmit in the new cell with timing advance TA adjusted by the relative timing difference  $\Delta t$  between the new and the old cell if indicated by higher layers:

$$TA_{\text{new}} = TA_{\text{old}} + 2\Delta t.$$

$TA_{\text{new}}$  is the timing advance of the new cell.

$TA_{\text{old}}$  is the timing advance of the old cell,

$\Delta t$  is the relative timing difference between the new and the old cell, which is measured by UE as SFN-SFN observed time difference type 2.

The uplink synchronization accuracy during handover is defined as timing deviation between the initial actual uplink synchronization position and the desired position of the first uplink DPCH on the target cell.

The requirements and this test apply to all types of 1.28 Mcps TDD UE.

##### 8.5.3.2.2.2.2 Minimum requirement

The UE shall not exceed the accuracy requirements as Table 8.5.3.2.2.5.

**Table 8.5.3.2.2.5: Uplink synchronisation control accuracy requirements**

Parameter	Unit	Accuracy [chip]	Conditions
			$I_0$ [dBm/ 1.28 MHz]
Uplink synchronization control during handover	chip	+/- 0.5	-94...-50

The rate of correct uplink synchronisation control observed during repeated tests shall be at least 90% with a confidence level of 95%.

##### 8.5.3.2.2.1.3 Test purpose

The purpose of this test is to verify the requirement for the uplink synchronization control during intra-frequency handover in CELL\_DCH state in minimum requirement .

##### 8.5.3.2.2.2.4 Initial conditions

The test parameters are given in Table 8.5.3.2.2.6 and 8.5.3.2.2.7 as below. The test consists of three successive time periods, with a time duration of T1, T2 and T3 respectively. At the start of time duration T1, the UE may not have any timing information of cell 2.

UTRAN shall send a Physical Channel reconfiguration with activation time "now" at the beginning of T3 with a new active cell, cell 2, after the UE has reported event 1G. The starting point of T3 is defined as the end of the last TTI containing the physical channel reconfiguration message.

**Table 8.5.3.2.2.6: General test parameters for inter-frequency handover**

Parameter		Unit	Value	Comment
DPCH parameters			DL and UL Reference Measurement Channel 12.2 kbps	As specified in TS 25.102 section A.2.2.2 and A.2.1.2
Power Control			On	
Target quality value on DPCH		BLER	0.01	
Initial conditions	Active cell		Cell 1	The UE has a RRC connection on the secondary frequency in cell 1.
	Neighbour cell		Cell 2	
Final conditions	Active cell		Cell 2	The UE will handover to the primary frequency in cell 2.
Threshold non used frequency		dBm	-75	Absolute RSCP threshold for event 2C
O		dB	0	cell-individual-offset The value shall be used for all cells in the test.
Hysteresis		dB	0	
Time to Trigger		ms	0	
Filter coefficient			0	
Monitored cell list size			6 TDD neighbours on Channel 1 6 TDD neighbours on Channel 2	
T1		s	5	
T2		s	10	
T3		s	5	

Table 8.5.3.2.2.7: Cell Specific parameters for inter-frequency handover

Parameter	Unit	Cell 1								
		0			DwPTS			5		
Timeslot Number		T1	T2	T3	T1	T2	T3	T1	T2	T3
UTRA RF Channel Number(Note 3)		Channel 1								
UTRA RF Channel Number(Note 4)		Channel 2								
PCCPCH_Ec/Ior	dB	-3						n.a.		
DwPCH_Ec/Ior					0					
DPCH_Ec/Ior	dB	n.a.			n.a.			Note1	n.a.	
OCNS_Ec/Ior	dB	-3						Note2		
$\hat{I}_{or}/I_{oc}$	dB	3			3			3		
$I_{oc}$	dBm/ 1.28 MHz	-70								
PCCPCH_RSCP	dBm	-70			n.a.			n.a.		
Propagation Condition		AWGN								
Parameter	Unit	Cell 2								
Timeslot Number		0			DwPTS			5		
		T1	T2	T3	T1	T2	T3	T1	T2	T3
UTRA RF Channel Number(Note 3)		Channel 1								
UTRA RF Channel Number(Note 4)		Channel 2								
PCCPCH_Ec/Ior	dB	-3						n.a.		
DwPCH_Ec/Ior					0					
DPCH_Ec/Ior	dB	n.a.			n.a.			n.a.	Note1	
OCNS_Ec/Ior	dB	-3						Note2		
$\hat{I}_{or}/I_{oc}$	dB	-Inf.	4		-Inf.	4		-Inf.	4	
$I_{oc}$	dBm/ 1.28 MHz	-70								
PCCPCH_RSCP	dBm	-Inf.	-69		n.a.			n.a.		
Propagation Condition		AWGN								
Note 1: The DPCH level is controlled by the power control loop Note 2: The power of the OCNS channel that is added shall make the total power from the cell to be equal to $I_{or}$ . Note3: The UTRA RF Channel Number is the primary frequency's channel number. Note4: The UTRA RF Channel Number is the secondary frequency's channel number.										

## 8.5.3.2.2.2.5 Procedure

- 1) The RF parameters are set up according to T1.
- 2) The UE is switched on.
- 3) A call is set up according to the test procedure specified in TS 34.108 [3] subclause 7.3.4.
- 4) SS shall transmit a MEASUREMENT CONTROL message.
- 5) After 5 seconds, the SS shall switch the power settings from T1 to T2.
- 6) UE shall transmit a MEASUREMENT REPORT message triggered by event 1G.
- 7) SS shall transmit a PHYSICAL CHANNEL RECONFIGURATION message with activation time "now".
- 8) After 10 seconds, the SS shall switch the power settings from T2 to T3
- 9) The UE transmits the UL DPCH to cell 2 less than 1 s from the beginning of time period T3 and UTRAN measures the initial uplink synchronization timing position of the first UL DPCH on cell2 and compares it with the desired position. If the timing deviation is less than the accuracy requirement as specified in Table

8.5.3.2.2.4, the number of successful tests is increased by one. And UE shall transmit a PHYSICAL CHANNEL RECONFIGURATION COMPLETE message on the UL DCCH of cell 2.

10) After 5 seconds, the UE is switched off. Any timing information of cell 2 is deleted in the UE.

11) Repeat steps 1-10 until the confidence level according to annex F.6.2 is achieved.

#### Specific Message Contents

All messages indicated above shall use the same content as described in the default message content in clause 9 of 34.108 [3] with the following exceptions:

MEASUREMENT CONTROL message, event 2C (step 4):

Information Element/Group name	Value/Remark
Message Type (10.2.17)	
<b>UE information elements</b>	
-RRC transaction identifier	0
-Integrity check info	Not Present
<b>Measurement Information elements</b>	
-Measurement Identity	1
-Measurement Command (10.3.7.46)	Modify
-Measurement Reporting Mode (10.3.7.49)	AM RLC
-Periodical Reporting / Event Trigger Reporting Mode	Event trigger
-Additional measurements list (10.3.7.1)	Not Present
-CHOICE <i>Measurement type</i>	Intra-frequency measurement
-Intra-frequency measurement (10.3.7.36)	
-Intra-frequency measurement objects list (10.3.7.33)	Not Present
-Intra-frequency measurement quantity (10.3.7.38)	
-Filter coefficient (10.3.7.9)	0
-CHOICE <i>mode</i>	TDD
-Measurement quantity list	1
-Measurement quantity	Primary CCPCH
-Intra-frequency reporting quantity (10.3.7.41)	
-Reporting quantities for active set cells (10.3.7.5)	No report
-SFN-SFN observed time difference reporting indicator	TRUE (Note 1)
-Cell synchronisation information reporting indicator	TRUE
-Cell Identity reporting indicator	TRUE
-CHOICE <i>mode</i>	TDD
-Timeslot ISCP reporting indicator	TRUE
-Primary CCPCH RSCP reporting indicator	TRUE
-Pathloss reporting indicator	TRUE
-Reporting quantities for monitored set cells (10.3.7.5)	No report
-SFN-SFN observed time difference reporting indicator	TRUE (Note 1)
-Cell synchronisation information reporting indicator	TRUE
-Cell Identity reporting indicator	TRUE
-CHOICE <i>mode</i>	TDD
-Timeslot ISCP reporting indicator	TRUE
-Proposed TGSN reporting required	FALSE
-Primary CCPCH RSCP reporting indicator	TRUE
-Pathloss reporting indicator	TRUE
-Reporting quantities for detected set cells (10.3.7.5)	Not Present
-Reporting cell status (10.3.7.61)	
-CHOICE <i>reported cell</i>	Report all active set cells + cells within monitored set on used frequency
-Maximum number of reported cells	2
-Measurement validity (10.3.7.51)	Not Present
-CHOICE <i>report criteria</i>	Intra-frequency measurement reporting criteria
-Intra-frequency measurement reporting criteria (10.3.7.39)	
-Parameters required for each event	1
-Intra-frequency event identity	Event 1G
-Triggering condition 2	Not Present
-Reporting Range Constant	Not Present
-Cells forbidden to affect Reporting Range	Not Present
-W	Not Present
-Hysteresis	0 dB
-Threshold used frequency	Not Present
-Reporting deactivation threshold	Not Present
-Replacement activation threshold	Not Present
-Time to trigger	0 ms
-Amount of reporting	Infinity
-Reporting interval	0 ms (Note 2)
-Reporting cell status	Not Present
<b>Physical channel information elements</b>	
-DPCH compressed mode status info (10.3.6.34)	Not Present

Information Element/Group name	Value/Remark
Note 1:	The SFN-CFN observed time difference is calculated from the OFF and Tm parameters contained in the IE "Cell synchronisation information", TS 25.331, clause 10.3.7.6. According to TS 25.331, 8.6.7.7, this IE is included in MEASUREMENT REPORT if IE "Cell synchronisation information reporting indicator" in IE "Cell reporting quantities" TS 25.331, clause 10.3.7.5 is set to TRUE in MEASUREMENT CONTROL.
Note 2:	Reporting interval = 0 ms means no periodical reporting

## PHYSICAL CHANNEL RECONFIGURATION message (step 7):

Information Element	Value/Remark
Message Type	
<b>UE Information Elements</b>	
-RRC transaction identifier	0
-Integrity check info	Not Present
-Integrity protection mode info	Not Present
-Ciphering mode info	Not Present
-Activation time	At T3
-New U-RNTI	Not Present
-New C-RNTI	Not Present
-RRC State Indicator	CELL_DCH
-UTRAN DRX cycle length coefficient	Not Present
<b>CN Information Elements</b>	
-CN Information info	Not Present
<b>UTRAN mobility information elements</b>	
-URA identity	Not Present
<b>RB information elements</b>	
-Downlink counter synchronisation info	Not Present
-RB with PDCP information list	Not Present
-RB with PDCP information	Not Present
<b>PhyCH information elements</b>	
-Frequency info (10.3.6.36)	
-CHOICE <i>mode</i>	TDD
-UARFCN (Nt)	Same UARFCN as used for cell 2
<b>Uplink radio resources</b>	
-Maximum allowed UL TX power	30 dBm
-CHOICE <i>channel requirement</i>	Uplink DPCH info
-Uplink DPCH info (10.3.6.88)	
-Uplink DPCH power control info (10.3.6.91)	
-CHOICE <i>mode</i>	TDD
-TDD	1,28 Mcps TDD
-UL target SIR	Not Present
-CHOICE <i>UL OL PC info</i>	Individually signalled
-CHOICE <i>TDD option</i>	
--1,28 Mcps TDD	1
-TPC step size	1
-CHOICE <i>mode</i>	TDD
-Uplink timing advance control (10.3.6.96)	
-CHOICE <i>Timing Advance</i>	Disabled
-UL CCTrCH list	1
-UL Target SIR	9 dB
-Time Info (10.3.6.83)	
-Activation Time	now
-Duration	Infinite
-Common timeslot info	Not Present
-Uplink DPCH timeslots and codes (10.3.6.94)	
-Dynamic SF Usage	False
-First individual timeslot info (10.3.6.37)	
-Timeslot Number (10.3.6.84)	
-CHOICE <i>TDD option</i>	1,28 Mcps
-Timeslot number	2
-TFCl existence	True
-Midamble shift and burst type (10.3.6.41)	
-Choice <i>TDD option</i>	1,28 Mcps
-Midamble Allocation Mode	Default
-Midamble configuration	16
-Midamble shift	Not present
-CHOICE <i>TDD option</i>	1,28 Mcps
-Modulation	QPSK
-SS-TPC Symbols	
-Additional TPC-SS Symbols	
-First timeslot code list	1
-Channelisation code	8/1
-Choice more timeslots	No more timeslots
<b>Downlink radio resources</b>	
-CHOICE <i>mode</i>	TDD



Information Element	Value/Remark
-Downlink information common for all radio links (10.3.6.24)	
-Downlink DPCH info common for all RL (10.3.6.18)	
-Timing indicator	Initialise
-CFN-targetSFN frame offset	Not Present
-Downlink DPCH power control information (10.3.6.23)	
-CHOICE <i>mode</i>	TDD
-TPC Step size	1 dB
-CHOICE <i>mode</i>	TDD
-CHOICE <i>mode</i>	TDD
-CHOICE <i>TDD option</i>	1,28 Mcps
- <i>TSTD indicator</i> (10.3.6.85a)	TRUE
-Default DPCH Offset Value (10.3.6.16)	0
-Downlink information per radio link list	1
-Downlink information for each radio link (10.3.6.27)	
-CHOICE <i>mode</i>	TDD
-Primary CCPCH info (10.3.6.57)	
-CHOICE <i>mode</i>	TDD
-CHOICE <i>TDD option</i>	1,28 Mcps
<i>TSTD indicator</i>	TRUE
-Cell parameters ID	0
-SCTD indicator	False
-Downlink DPCH info for each RL (10.3.6.21)	
-CHOICE <i>mode</i>	TDD
-DL CCTrCH list	1
-TFCS ID	Not Present
-Time Info (10.3.6.83)	
-Activation Time	now
-Duration	Infinite
-Common timeslot info	Not Present
-Downlink DPCH timeslots and codes (10.3.6.32)	
-First individual timeslot info (10.3.6.37)	
-Timeslot Number (10.3.6.84)	
-CHOICE <i>TDD option</i>	1,28 Mcps
-Timeslot number	5
-TFCI existence	True
-Midamble shift and burst type (10.3.6.41)	
-CHOICE <i>TDD option</i>	1,28 Mcps
-Midamble Allocation Mode	Default
-Midamble configuration	16
-Midamble shift	Not present
-CHOICE <i>TDD option</i>	1,28 Mcps
-Modulation	QPSK
-SS-TPC Symbols	
-Additional TPC-SS Symbols	
-First timeslot channelisation codes (10.3.6.17)	
-CHOICE <i>codes representation</i>	Consecutive codes
-First channelisation code	16/1
-Last channelisation code	16/2
-CHOICE <i>more timeslots</i>	No more timeslots
-SCCPCH information for FACH (10.3.6.70)	Not Present

MEASUREMENT REPORT message for Inter frequency test cases

This message is common for all inter frequency TDD test cases in clause 8.7 and is described in Annex I.

8.5.3.2.2.2.6 Test requirements

The UE shall not exceed the accuracy requirements as Table 8.5.3.2.2.8.

**Table 8.5.3.2.2.8: Uplink synchronisation control accuracy requirements**

Parameter	Unit	Accuracy [chip]	Conditions
			Io [dBm/ 1.28 MHz]
Uplink synchronization control during handover	chip	+/- 0.5	-94...-50

The rate of correct handovers observed during repeated tests shall be at least 90% with a confidence level of 95%.

### 8.5.3.3 7.68 Mcps TDD option

Void.

## 8.6 UE Measurements Procedures

### 8.6.1 TDD intra frequency measurements

#### 8.6.1.1 Event 1G triggered reporting in AWGN propagation conditions

##### 8.6.1.1.1 Definition and applicability

##### 8.6.1.1.1.1 3,84 Mcps TDD Option

In the event triggered reporting period the measurement reporting delay is defined as the time between any event that will trigger a measurement report until the UE starts to transmit over the Uu interface. This requirement assumes that the measurement report is not delayed by other RRC signalling on the DCCH. This measurement reporting delay excludes a delay uncertainty resulted when inserting the measurement report to the TTI of the uplink DCCH. The delay uncertainty is twice the TTI of the uplink DCCH.

The requirements and this test apply to the TDD (3,84 Mcps option) UE.

##### 8.6.1.1.1.2 1,28 Mcps TDD Option

In the event triggered reporting period the measurement reporting delay is defined as the time between any event that will trigger a measurement report until the UE starts to transmit over the Uu interface. This requirement assumes that the measurement report is not delayed by other RRC signalling on the DCCH. This measurement reporting delay excludes a delay uncertainty resulted when inserting the measurement report to the TTI of the uplink DCCH. The delay uncertainty is twice the TTI of the uplink DCCH.

The requirements and this test apply to the 1.28 Mcps option TDD UE.

##### 8.6.1.1.1.3 7,68 Mcps TDD Option

In the event triggered reporting period the measurement reporting delay is defined as the time between any event that will trigger a measurement report until the UE starts to transmit over the Uu interface. This requirement assumes that the measurement report is not delayed by other RRC signalling on the DCCH. This measurement reporting delay excludes a delay uncertainty resulted when inserting the measurement report to the TTI of the uplink DCCH. The delay uncertainty is twice the TTI of the uplink DCCH.

The requirements and this test apply to the TDD (7,68 Mcps option) UE.

##### 8.6.1.1.2 Minimum requirement

##### 8.6.1.1.2.1 3,84 Mcps TDD Option

The UE shall be able to identify a new detectable intra-frequency TDD cell belonging to the monitored set within  $T_{\text{identify intra}}$  ms, where  $T_{\text{identify intra}} = 800$  ms.

When L3 filtering is used, an additional delay can be expected.

In CELL\_DCH state, the UE shall be capable of performing P-CCPCH RSCP measurements for  $X_{\text{measurement intra}}$  identified intra-frequency TDD cells of the monitored set with a measurement period for intra-frequency P-CCPCH RSCP measurements  $T_{\text{measurement period intra}}$ , where

$$X_{\text{measurement intra}} = 6 \text{ (cells)}$$

$$T_{\text{measurement period intra}} = 200 \text{ ms}$$

The UE physical layer shall be capable of reporting these measurements to higher layers with the measurement period  $T_{\text{measurement period intra}}$ .

If the UE has identified more than  $X_{\text{measurement intra}}$  intra-frequency TDD cells, the UE shall perform measurements of all identified cells but the reporting rate of P-CCPCH RSCP measurements of cells from the UE physical layer to higher layers may be decreased.. The measurement accuracy for all measured cells shall be as specified in the section 9.

The normative reference for this requirement is TS 25.123 [2] clauses 8.1.2.2.1, 8.1.2.2.2 and A.8.1.1

#### 8.6.1.1.2.2 1,28 Mcps TDD Option

The UE shall be able to identify a new intra frequency TDD cell belonging to the monitored set within

$$T_{\text{identify intra}} = T_{\text{basic identify TDD, intra}} \cdot \frac{N_{\text{Period, Intra}}}{N_{\text{Intra}}} \text{ ms}$$

$T_{\text{basic\_identify\_TDD, intra}} = 800$  ms. This is the time period used in the intra frequency equation where the maximum allowed time for the UE to identify a new TDD cell is defined.

$N_{\text{Period, Intra}}$ : = 40 Number of subframes in  $T_{\text{Measurement\_Period, Intra}}$ .

$N_{\text{Intra}}$ : This is the minimum number of sub-frame in that the period of TS0, DwPTS and main guard period is available for intra frequency measurements, during the measurement period.

$T_{\text{Measurement\_Period, Intra}} = 200$  ms. The measurement period for Intra frequency P-CCPCH RSCP measurements.

If a cell belonging to monitored set has been detectable at least for the time period  $T_{\text{identify intra}}$  and then enters or leaves the reporting range, the event triggered measurement reporting delay shall be less than 200ms when the L3 filter has not been used and the UE P-CCPCH measurement capabilities of Section 8.1A.2.2.2 in [2] are valid.

The event triggered measurement reporting delay on cells not belonging to monitored set, measured without L3 filtering, shall be less than the above defined  $T_{\text{identify detected set}}$ .

#### 8.6.1.1.2.3 7,68 Mcps TDD Option

The UE shall be able to identify a new detectable intra-frequency TDD cell belonging to the monitored set within  $T_{\text{identify intra}}$  ms, where  $T_{\text{identify intra}} = 800$  ms.

When L3 filtering is used, an additional delay can be expected.

In CELL\_DCH state, the UE shall be capable of performing P-CCPCH RSCP measurements for  $X_{\text{measurement intra}}$  identified intra-frequency TDD cells of the monitored set with a measurement period for intra-frequency P-CCPCH RSCP measurements  $T_{\text{measurement period intra}}$ , where

$X_{\text{measurement intra}} = 6$  (cells)

$T_{\text{measurement period intra}} = 200$  ms

The UE physical layer shall be capable of reporting these measurements to higher layers with the measurement period  $T_{\text{measurement period intra}}$ .

If the UE has identified more than  $X_{\text{measurement intra}}$  intra-frequency TDD cells, the UE shall perform measurements of all identified cells but the reporting rate of P-CCPCH RSCP measurements of cells from the UE physical layer to higher layers may be decreased.. The measurement accuracy for all measured cells shall be as specified in the section 9.

The normative reference for this requirement is TS 25.123 [2] clauses 8.1B.2.2.1, 8.1B.2.2.2 and A.8.1.1

#### 8.6.1.1.3 Test purpose

##### 8.6.1.1.3.1 3,84 Mcps TDD Option

To verify that the UE meets the minimum requirement.

##### 8.6.1.1.3.2 1,28 Mcps TDD Option

To verify the UE meets the minimum requirements.

## 8.6.1.1.3.3 7,68 Mcps TDD Option

To verify the UE meets the minimum requirements.

## 8.6.1.1.4 Method of test

## 8.6.1.1.4.1 3,84 Mcps TDD Option

## 8.6.1.1.4.1.1 Initial conditions

Test environment: normal; see clauses G.2.1 and G.2.2.

Frequencies to be tested: mid range; see clause G.2.4.

The test parameters are given in Table 8.6.1.1.1 and 8.6.1.1.2. The test consists of three successive time periods, with time durations of T1, T2 and T3 respectively. Three cells shall be present in the test, cell 1 being the serving cell and cell 2 and cell 3 being neighbour cells on the used frequency. All cells shall be synchronised, i.e. share the same frame and timeslot timing.

In the measurement control information it is indicated to the UE that event-triggered reporting with Event 1G shall be used, and that P-CCPCH RSCP shall be reported together with Event 1G. The Measurement control message shall be sent to the UE such that the delay between the end of the last received TTI containing the message and the beginning of T1 is at least equal to the RRC procedure delay as defined in [9].

The second Beacon timeslot shall be provided in timeslot 8 for both cell 1 and cell 2. The DL DPCH shall be transmitted in timeslot 2 and the UL DPCH shall be transmitted in timeslot 10. The TTI of the uplink DCCH shall be 20ms.

**Table 8.6.1.1.1: General test parameters for Event 1G triggered reporting in AWGN propagation condition**

Parameter	Unit	Value	Comment
DCH parameters		DL Reference Measurement Channel 12.2 kbps	As specified in TS 25.102 section A.2.2
Power Control		On	
Target quality value on DTCH	BLER	0.01	
Initial conditions	Active cell	Cell 1	
	Neighbour cell	Cell 2, Cell 3	
Final condition	Active cell	Cell 1	
O	dB	0	Cell individual offset. This value shall be used for all cells in the test.
Hysteresis	dB	0	
Time to Trigger	ms	0	
Threshold used frequency	dBm	-70	Applicable for Event 1G
Filter coefficient		0	
Monitored cell list size		12 TDD neighbours on Channel 1	
T1	s	6	
T2	s	6	
T3	s	6	

**Table 8.6.1.1.2: Cell specific parameters for Event 1G triggered correct reporting in AWGN propagation condition**

Parameter	Unit	Cell 1			Cell 2			Cell 3		
		T1	T2	T3	T1	T2	T3	T1	T2	T3
DL timeslot number		0			0			0		
UTRA RF Channel Number		Channel 1			Channel 1			Channel 1		
PCCPCH_Ec/lor	dB	-3			-3			-3		
SCH_Ec/lor	dB	-9			-9			-9		
SCH_toffset		0			5			10		
OCNS_Ec/lor	dB	-3,12			-3,12			-3,12		
$\hat{I}_{or}/I_{oc}$	dB	7	5		5	7	-Inf	-Inf		7
PCCPCH RSCP	dBm	-66	-68		-68	-66	-Inf	-Inf		-66
$I_{oc}$	dBm / 3,84 MHz	-70								
Propagation Condition		AWGN								

#### 8.6.1.1.4.1.2 Procedure

- 1) The RF parameters are set up according to T1.
- 2) The UE is switched on.
- 3) A call is set up according to the generic set-up procedure specified in TS 34.108 [3] subclause 7.4.2 to place the UE in CELL\_DCH.
- 4) SS shall transmit a MEASUREMENT CONTROL message.
- 5) After 6 seconds from the beginning of T1, the SS shall switch the power settings from T1 to T2.
- 6) UE shall transmit a MEASUREMENT REPORT message triggered by event 1G for cell 2. The measurement reporting delay from the beginning of T2 shall be less than 240 ms. If the UE fails to report the event within the required delay, then a failure is recorded. If the reporting delay for this event is within the required limit, the number of successful tests is increased by one.
- 7) After 6 seconds from the beginning of T2, the SS shall switch the power settings from T2 to T3.
- 8) UE shall transmit a MEASUREMENT REPORT message triggered by event 1G for cell 3. The measurement reporting delay from the beginning of T3 shall be less than 840 ms. If the reporting delay for this event is within the required limit, the number of successful tests is increased by one.
- 9) After 6 seconds from the beginning of T3, the UE is switched off. Any timing information of cell 2 is deleted in the UE.
- 10) Repeat steps 1-9 [TBD] times.

#### Specific Message Contents

All messages indicated above shall use the same content as described in the default message content in clause 9 of 34.108 [3] with the following exceptions:

MEASUREMENT CONTROL message (step 4):

Information Element/Group name	Value/Remark
Message Type (10.2.17)	
<b>UE information elements</b>	
-RRC transaction identifier	0
-Integrity check info	Not Present
<b>Measurement Information elements</b>	
-Measurement Identity	1
-Measurement Command (10.3.7.46)	Modify
-Measurement Reporting Mode (10.3.7.49)	AM RLC
-Periodical Reporting / Event Trigger Reporting Mode	Event trigger
-Additional measurements list (10.3.7.1)	Not Present
-CHOICE <i>Measurement type</i>	Intra-frequency measurement
-Intra-frequency measurement (10.3.7.36)	
-Intra-frequency measurement objects list (10.3.7.33)	Not Present
-Intra-frequency measurement quantity (10.3.7.38)	
-Filter coefficient (10.3.7.9)	0
-CHOICE <i>mode</i>	TDD
-Measurement quantity list	1
-Measurement quantity	Primary CCPCH
-Intra-frequency reporting quantity (10.3.7.41)	
-Reporting quantities for active set cells (10.3.7.5)	No report
-SFN-SFN observed time difference reporting indicator	FALSE
-Cell synchronisation information reporting indicator	TRUE
-Cell Identity reporting indicator	TRUE
-CHOICE <i>mode</i>	TDD
-Timeslot ISCP reporting indicator	TRUE
-Primary CCPCH RSCP reporting indicator	TRUE
-Pathloss reporting indicator	TRUE
-Reporting quantities for monitored set cells (10.3.7.5)	No report
-SFN-SFN observed time difference reporting indicator	FALSE
-Cell synchronisation information reporting indicator	TRUE
-Cell Identity reporting indicator	TRUE
-CHOICE <i>mode</i>	TDD
-Timeslot ISCP reporting indicator	FALSE
-Proposed TGSN reporting required	FALSE
-Primary CCPCH RSCP reporting indicator	TRUE
-Pathloss reporting indicator	FALSE
-Reporting quantities for detected set cells (10.3.7.5)	Not Present
-Reporting cell status (10.3.7.61)	
-CHOICE <i>reported cell</i>	Report all active set cells + cells within monitored set on used frequency
-Maximum number of reported cells	1
-Measurement validity (10.3.7.51)	Not Present
-CHOICE <i>report criteria</i>	Intra-frequency measurement reporting criteria
-Intra-frequency measurement reporting criteria (10.3.7.39)	
-Parameters required for each event	1
-Intra-frequency event identity	Event 1G
-Triggering condition 2	Not Present
-Reporting Range Constant	Not Present
-Cells forbidden to affect Reporting Range	Not Present
-W	Not Present
-Hysteresis	0 dB
-Threshold used frequency	Not Present
-Reporting deactivation threshold	Not Present
-Replacement activation threshold	Not Present
-Time to trigger	0 ms
-Amount of reporting	Infinity
-Reporting interval	0 ms (Note 1)
-Reporting cell status	Not Present
<b>Physical channel information elements</b>	
-DPCH compressed mode status info (10.3.6.34)	Not Present
Note 1: Reporting interval = 0 ms means no periodical reporting	

## MEASUREMENT REPORT message (step 6)

Information Element	Value/remark
Message Type (10.2.17)	
Integrity check info	Not Present
Measurement identity	1
Measured Results (10.3.7.44)	
-CHOICE Measurement	Intra-frequency Measured results list
-Intra-frequency measured results	1
-Cell measured results (10.3.7.3)	
-Cell identity	Not Present
-SFN-SFN observed time difference	Not Present
-Cell synchronisation info	Not Present
-CHOICE mode	TDD
-Cell parameters ID	Set to Cell parameters ID of Cell 2
-Proposed TGSN	Not Present
-Primary CCPCH RSCP	Checked that this IE is present
-Pathloss	Not Present
-Timeslot list	Not Present
Measured results on RACH	Not Present
Additional measured results	Not Present
Event results (10.3.7.7)	
-CHOICE event result	Intra-frequency measurement event results
-Intra-frequency event identity	1G
-Cell measurement event results (10.3.7.4)	
-CHOICE mode	TDD
-Primary CCPCH info (10.3.6.57)	
-CHOICE mode	TDD
-Cell parameters ID	Set to Cell parameters ID of Cell 2

## MEASUREMENT REPORT message (step 8)

Information Element	Value/remark
Message Type (10.2.17)	
Integrity check info	Not Present
Measurement identity	1
Measured Results (10.3.7.44)	
-CHOICE Measurement	Intra-frequency Measured results list
-Intra-frequency measured results	1
-Cell measured results (10.3.7.3)	
-Cell identity	Not Present
-SFN-SFN observed time difference	Not Present
-Cell synchronisation info	Not Present
-CHOICE mode	TDD
-Cell parameters ID	Set to Cell parameters ID of Cell 3
-Proposed TGSN	Not Present
-Primary CCPCH RSCP	Checked that this IE is present
-Pathloss	Not Present
-Timeslot list	Not Present
Measured results on RACH	Not Present
Additional measured results	Not Present
Event results (10.3.7.7)	
-CHOICE event result	Intra-frequency measurement event results
-Intra-frequency event identity	1G
-Cell measurement event results (10.3.7.4)	
-CHOICE mode	TDD
-Primary CCPCH info (10.3.6.57)	
-CHOICE mode	TDD
-Cell parameters ID	Set to Cell parameters ID of Cell 3

8.6.1.1.4.2 1,28 Mcps TDD Option

Test environment : normal; see clauses G.2.1 and G.2.2.

Frequencies to be tested : mid range ;see clauses G.2.4.

The test parameters are given in Table 8.6.1.1.4A and 8.6.1.1.4B below. The test consists of three successive time periods, with time durations of T1, T2 and T3 respectively. Three cells shall be present in the test, cell 1 being the serving cell and cell 2 and cell 3 being neighbour cells on the used frequency. All cells shall be synchronised, i.e. share the same frame and timeslot timing.

In the measurement control information it is indicated to the UE that event-triggered reporting with Event 1G shall be used, and that P-CCPCH RSCP shall be reported together with Event 1G reporting. The Measurement control message shall be sent to the UE such that the delay between the end of the last received TTI containing the message and the beginning of T1 is at least equal to the RRC procedure delay as defined in [9]. The cell specific test parameters are given in Table 8.6.1.1B below.

The TTI of the uplink DCCH shall be 40ms.

**Table 8.6.1.1.4A: General test parameters for Event 1G triggered reporting in AWGN propagation condition 1,28Mcps option**

Parameter	Unit	Value	Comment
DPCH parameters active cell		DL and UL Reference Measurement Channel 12.2 kbps	As specified in TS 25.102 section A. The DPCH is located in an other timeslot than 0
Power Control		On	
Target quality value on DTCH	BLER	0.01	
Active cell		Cell 1	
Neighbour cell		Cell 2, Cell 3	
O	DB	0	Cell individual offset. This value shall be used for all cells in the test.
Hysteresis	DB	0	
Time to Trigger	Ms	0	
Filter coefficient		0	
Monitored cell list size		12 TDD neighbours on Channel 1	
T1	S	6	
T2	S	6	
T3	S	6	



Table 8.6.1.1.4B: Cell specific parameters for Event 1G triggered correct reporting in AWGN propagation condition 1,28 Mcps option

Parameter	Unit	Cell 1						Cell 2						Cell 3					
		0			DwPTS			0			DwPTS			0			DwPTS		
DL timeslot number		T1	T2	T3	T1	T2	T3	T1	T2	T3	T1	T2	T3	T1	T2	T3	T1	T2	T3
UTRA RF Channel Number		Channel 1						Channel 1						Channel 1					
PCCPCH_Ec/lor	dB	-3						-3						-3					
DwPCH_Ec/lor	dB				0						0						0		
OCNS_Ec/lor	dB	-3						-3						-3					
$\hat{I}_{or}/I_{oc}$	dB	7	4		7	4		4	7	-Inf	4	7	-Inf	-Inf	7		-Inf	7	
PCCPCH RSCP	dBm	-66	-69					-69	-66	-Inf				-Inf	-66				
$I_{oc}$	dBm / 1,28 MHz	-70																	
Propagation Condition		AWGN																	

NOTE: The DPCH of all cells are located in a timeslot other than 0.

- 1) The RF parameters are set up according to T1.
- 2) The UE is switched on.
- 3) A call is set up according to the generic set-up procedure specified in TS 34.108 [3] subclause 7.4.2 to place the UE in CELL\_DCH.
- 4) SS shall transmit a MEASUREMENT CONTROL message.
- 5) After 6 seconds from the beginning of T1, the SS shall switch the power settings from T1 to T2.
- 6) UE shall transmit a MEASUREMENT REPORT message triggered by event 1G for cell 2. The measurement reporting delay from the beginning of T2 shall be less than 280 ms. If the UE fails to report the event within the required delay, then a failure is recorded. If the reporting delay for this event is within the required limit, the number of successful tests is increased by one.
- 7) After 6 seconds from the beginning of T2, the SS shall switch the power settings from T2 to T3.
- 8) UE shall transmit a MEASUREMENT REPORT message triggered by event 1G for cell 3. The measurement reporting delay from the beginning of T3 shall be less than 880 ms. If the reporting delay for this event is within the required limit, the number of successful tests is increased by one.
- 9) After 6 seconds from the beginning of T3, the UE is switched off. Any timing information of cell 2 is deleted in the UE.
- 10) Repeat steps 1-9 until the confidence level according to annex F.6.2 is achieved.

#### Specific Message Contents

All messages indicated above shall use the default message content in clause 9 of 34.108 [3], with the following exceptions:

MEASUREMENT CONTROL message (step 4):

Information Element/Group name	Value/Remark
Message Type (10.2.17)	
<b>UE information elements</b>	
-RRC transaction identifier	0
-Integrity check info	Not Present
<b>Measurement Information elements</b>	
-Measurement Identity	1
-Measurement Command (10.3.7.46)	Modify
-Measurement Reporting Mode (10.3.7.49)	AM RLC
-Periodical Reporting / Event Trigger Reporting Mode	Event trigger
-Additional measurements list (10.3.7.1)	Not Present
-CHOICE <i>Measurement type</i>	Intra-frequency measurement
-Intra-frequency measurement (10.3.7.36)	
-Intra-frequency measurement objects list (10.3.7.33)	Not Present
-Intra-frequency measurement quantity (10.3.7.38)	
-Filter coefficient (10.3.7.9)	0
-CHOICE <i>mode</i>	TDD
-Measurement quantity list	1
-Measurement quantity	Primary CCPCH
-Intra-frequency reporting quantity (10.3.7.41)	
-Reporting quantities for active set cells (10.3.7.5)	No report
-SFN-SFN observed time difference reporting indicator	FALSE
-Cell synchronisation information reporting indicator	TRUE
-Cell Identity reporting indicator	TDD
-CHOICE <i>mode</i>	TRUE
-Timeslot ISCP reporting indicator	TRUE
-Primary CCPCH RSCP reporting indicator	TRUE
-Pathloss reporting indicator	TRUE
-Reporting quantities for monitored set cells (10.3.7.5)	No report
-SFN-SFN observed time difference reporting indicator	FALSE
-Cell synchronisation information reporting indicator	TRUE
-Cell Identity reporting indicator	TDD
-CHOICE <i>mode</i>	FALSE
-Timeslot ISCP reporting indicator	FALSE
-Proposed TGSN reporting required	FALSE
-Primary CCPCH RSCP reporting indicator	TRUE
-Pathloss reporting indicator	FALSE
-Reporting quantities for detected set cells (10.3.7.5)	Not Present
-Reporting cell status (10.3.7.61)	
-CHOICE <i>reported cell</i>	Report all active set cells + cells within monitored set on used frequency
-Maximum number of reported cells	1
-Measurement validity (10.3.7.51)	Not Present
-CHOICE <i>report criteria</i>	Intra-frequency measurement reporting criteria
-Intra-frequency measurement reporting criteria (10.3.7.39)	
-Parameters required for each event	1
-Intra-frequency event identity	Event 1G
-Triggering condition 2	Not Present
-Reporting Range Constant	Not Present
-Cells forbidden to affect Reporting Range	Not Present
-W	Not Present
-Hysteresis	0 dB
-Threshold used frequency	Not Present
-Reporting deactivation threshold	Not Present
-Replacement activation threshold	Not Present
-Time to trigger	0 ms
-Amount of reporting	Infinity
-Reporting interval	0 ms (Note 1)
-Reporting cell status	Not Present
<b>Physical channel information elements</b>	
-DPCH compressed mode status info (10.3.6.34)	Not Present
Note 1: Reporting interval = 0 ms means no periodical reporting	

## MEASUREMENT REPORT message (step 6)

Information Element	Value/remark
Message Type (10.2.17)	
Integrity check info	Not Present
Measurement identity	1
Measured Results (10.3.7.44)	
-CHOICE Measurement	Intra-frequency Measured results list
-Intra-frequency measured results	1
-Cell measured results (10.3.7.3)	
-Cell identity	Not Present
-SFN-SFN observed time difference	Not Present
-Cell synchronisation info	Not Present
-CHOICE mode	TDD
-Cell parameters ID	Set to Cell parameters ID of Cell 2
-Proposed TGSN	Not Present
-Primary CCPCH RSCP	Checked that this IE is present
-Pathloss	Not Present
-Timeslot list	Not Present
Measured results on RACH	Not Present
Additional measured results	Not Present
Event results (10.3.7.7)	
-CHOICE event result	Intra-frequency measurement event results
-Intra-frequency event identity	1G
-Cell measurement event results (10.3.7.4)	
-CHOICE mode	TDD
-Primary CCPCH info (10.3.6.57)	
-CHOICE mode	TDD
-CHOICE TDD Option	1.28 Mcps TDD
-Cell parameters ID	Set to Cell parameters ID of Cell 2

## MEASUREMENT REPORT message (step 8)

Information Element	Value/remark
Message Type (10.2.17)	
Integrity check info	Not Present
Measurement identity	1
Measured Results (10.3.7.44)	
-CHOICE Measurement	Intra-frequency Measured results list
-Intra-frequency measured results	1
-Cell measured results (10.3.7.3)	
-Cell identity	Not Present
-SFN-SFN observed time difference	Not Present
-Cell synchronisation info	Not Present
-CHOICE mode	TDD
-Cell parameters ID	Set to Cell parameters ID of Cell 3
-Proposed TGSN	Not Present
-Primary CCPCH RSCP	Checked that this IE is present
-Pathloss	Not Present
-Timeslot list	Not Present
Measured results on RACH	Not Present
Additional measured results	Not Present
Event results (10.3.7.7)	
-CHOICE event result	Intra-frequency measurement event results
-Intra-frequency event identity	1G
-Cell measurement event results (10.3.7.4)	
-CHOICE mode	TDD
-Primary CCPCH info (10.3.6.57)	
-CHOICE mode	TDD
-CHOICE TDD Option	1.28 Mcps TDD
-Cell parameters ID	Set to Cell parameters ID of Cell 3

8.6.1.1.4.3 7,68 Mcps TDD Option

8.6.1.1.4.3.1 Initial conditions

Test environment: normal; see clauses G.2.1 and G.2.2.

Frequencies to be tested: mid range; see clause G.2.4.

The test parameters are given in Table 8.6.1.1.4.3.1.1 and 8.6.1.1.4.3.1.2. The test consists of three successive time periods, with time durations of T1, T2 and T3 respectively. Three cells shall be present in the test, cell 1 being the serving cell and cell 2 and cell 3 being neighbour cells on the used frequency. All cells shall be synchronised, i.e. share the same frame and timeslot timing.

In the measurement control information it is indicated to the UE that event-triggered reporting with Event 1G shall be used, and that P-CCPCH RSCP shall be reported together with Event 1G. The Measurement control message shall be sent to the UE such that the delay between the end of the last received TTI containing the message and the beginning of T1 is at least equal to the RRC procedure delay as defined in [9].

The second Beacon timeslot shall be provided in timeslot 8 for both cell 1 and cell 2. The DL DPCH shall be transmitted in timeslot 2 and the UL DPCH shall be transmitted in timeslot 10. The TTI of the uplink DCCH shall be 20ms.

**Table 8.6.1.1.4.3.1.1: General test parameters for Event 1G triggered reporting in AWGN propagation condition**

Parameter	Unit	Value	Comment
DCH parameters		DL Reference Measurement Channel 12.2 kbps	As specified in TS 25.102 section A.2.2
Power Control		On	
Target quality value on DTCH	BLER	0.01	
Initial conditions	Active cell	Cell 1	
	Neighbour cell	Cell 2, Cell 3	
Final condition	Active cell	Cell 1	
O	dB	0	Cell individual offset. This value shall be used for all cells in the test.
Hysteresis	dB	0	
Time to Trigger	ms	0	
Threshold used frequency	dBm	-70	Applicable for Event 1G
Filter coefficient		0	
Monitored cell list size		12 TDD neighbours on Channel 1	
T1	s	6	
T2	s	6	
T3	s	6	

**Table 8.6.1.1.4.3.1.2: Cell specific parameters for Event 1G triggered correct reporting in AWGN propagation condition**

Parameter	Unit	Cell 1			Cell 2			Cell 3		
		T1	T2	T3	T1	T2	T3	T1	T2	T3
<b>DL timeslot number</b>		0			0			0		
UTRA RF Channel Number		Channel 1			Channel 1			Channel 1		
PCCPCH_Ec/lor	dB	-3			-3			-3		
SCH_Ec/lor	dB	-9			-9			-9		
SCH_t <sub>offset</sub>		0			5			10		
OCNS_Ec/lor	dB	-3,12			-3,12			-3,12		
$\hat{I}_{or}/I_{oc}$	dB	7	5		5	7	-Inf	-Inf	7	
PCCPCH RSCP	dBm	-66	-68		-68	-66	-Inf	-Inf	-66	
$I_{oc}$	dBm / 7,68 MHz	-70								
Propagation Condition		AWGN								

#### 8.6.1.1.4.3.2 Procedure

- 1) The RF parameters are set up according to T1.
- 2) The UE is switched on.
- 3) A call is set up according to the generic set-up procedure specified in TS 34.108 [3] subclause 7.4.2 to place the UE in CELL\_DCH.
- 4) SS shall transmit a MEASUREMENT CONTROL message.
- 5) After 6 seconds from the beginning of T1, the SS shall switch the power settings from T1 to T2.
- 6) UE shall transmit a MEASUREMENT REPORT message triggered by event 1G for cell 2. The measurement reporting delay from the beginning of T2 shall be less than 240 ms. If the UE fails to report the event within the required delay, then a failure is recorded. If the reporting delay for this event is within the required limit, the number of successful tests is increased by one.
- 7) After 6 seconds from the beginning of T2, the SS shall switch the power settings from T2 to T3.
- 8) UE shall transmit a MEASUREMENT REPORT message triggered by event 1G for cell 3. The measurement reporting delay from the beginning of T3 shall be less than 840 ms. If the reporting delay for this event is within the required limit, the number of successful tests is increased by one.
- 9) After 6 seconds from the beginning of T3, the UE is switched off. Any timing information of cell 2 is deleted in the UE.
- 10) Repeat steps 1-9 until the confidence level according to annex F.6.2 is achieved.

#### Specific Message Contents

All messages indicated above shall use the same content as described in the default message content in clause 9 of 34.108 [3] with the following exceptions:

MEASUREMENT CONTROL message (step 4):

Information Element/Group name	Value/Remark
Message Type (10.2.17)	
<b>UE information elements</b>	
-RRC transaction identifier	0
-Integrity check info	Not Present
<b>Measurement Information elements</b>	
-Measurement Identity	1
-Measurement Command (10.3.7.46)	Modify
-Measurement Reporting Mode (10.3.7.49)	AM RLC
-Periodical Reporting / Event Trigger Reporting Mode	Event trigger
-Additional measurements list (10.3.7.1)	Not Present
-CHOICE <i>Measurement type</i>	Intra-frequency measurement
-Intra-frequency measurement (10.3.7.36)	
-Intra-frequency measurement objects list (10.3.7.33)	Not Present
-Intra-frequency measurement quantity (10.3.7.38)	
-Filter coefficient (10.3.7.9)	0
-CHOICE <i>mode</i>	TDD
-Measurement quantity list	1
-Measurement quantity	Primary CCPCH
-Intra-frequency reporting quantity (10.3.7.41)	
-Reporting quantities for active set cells (10.3.7.5)	No report
-SFN-SFN observed time difference reporting indicator	FALSE
-Cell synchronisation information reporting indicator	TRUE
-Cell Identity reporting indicator	TRUE
-CHOICE <i>mode</i>	TDD
-Timeslot ISCP reporting indicator	TRUE
-Primary CCPCH RSCP reporting indicator	TRUE
-Pathloss reporting indicator	TRUE
-Reporting quantities for monitored set cells (10.3.7.5)	No report
-SFN-SFN observed time difference reporting indicator	FALSE
-Cell synchronisation information reporting indicator	TRUE
-Cell Identity reporting indicator	TRUE
-CHOICE <i>mode</i>	TDD
-Timeslot ISCP reporting indicator	FALSE
-Proposed TGSN reporting required	FALSE
-Primary CCPCH RSCP reporting indicator	TRUE
-Pathloss reporting indicator	FALSE
-Reporting quantities for detected set cells (10.3.7.5)	Not Present
-Reporting cell status (10.3.7.61)	
-CHOICE <i>reported cell</i>	Report all active set cells + cells within monitored set on used frequency
-Maximum number of reported cells	1
-Measurement validity (10.3.7.51)	Not Present
-CHOICE <i>report criteria</i>	Intra-frequency measurement reporting criteria
-Intra-frequency measurement reporting criteria (10.3.7.39)	
-Parameters required for each event	1
-Intra-frequency event identity	Event 1G
-Triggering condition 2	Not Present
-Reporting Range Constant	Not Present
-Cells forbidden to affect Reporting Range	Not Present
-CHOICE <i>mode</i>	TDD
-Primary CCPCH info (10.3.6.57)	
-CHOICE <i>mode</i>	TDD
-CHOICE <i>TDD option</i>	7,68 Mcps TDD
-CHOICE <i>Sync case</i>	2
-Timeslot	0
-Cell parameters ID	0
-SCTD indicator	FALSE
-W	Not Present
-Hysteresis	0 dB
-Threshold used frequency	Not Present
-Reporting deactivation threshold	Not Present
-Replacement activation threshold	Not Present
-Time to trigger	0 ms

Information Element/Group name	Value/Remark
-Amount of reporting	Infinity
-Reporting interval	0 ms (Note 1)
-Reporting cell status	Not Present
<b>Physical channel information elements</b>	
-DPCH compressed mode status info (10.3.6.34)	Not Present
Note 1: Reporting interval = 0 ms means no periodical reporting	

## MEASUREMENT REPORT message (step 6)

Information Element	Value/remark
Message Type (10.2.17)	
Integrity check info	Not Present
Measurement identity	1
Measured Results (10.3.7.44)	
-CHOICE Measurement	Intra-frequency Measured results list
-Intra-frequency measured results	1
-Cell measured results (10.3.7.3)	
-Cell identity	Not Present
-SFN-SFN observed time difference	Not Present
-Cell synchronisation info	Not Present
-CHOICE mode	TDD
-Cell parameters ID	Set to Cell parameters ID of Cell 2
-Proposed TGSN	Not Present
-Primary CCPCH RSCP	Checked that this IE is present
-Pathloss	Not Present
-Timeslot list	Not Present
Measured results on RACH	Not Present
Additional measured results	Not Present
Event results (10.3.7.7)	
-CHOICE event result	Intra-frequency measurement event results
-Intra-frequency event identity	1G
-Cell measurement event results (10.3.7.4)	
-CHOICE mode	TDD
-Primary CCPCH info (10.3.6.57)	
-CHOICE mode	TDD
-CHOICE TDD option	7,68 Mcps TDD
-CHOICE Sync case	Not present
-Cell parameters ID	Set to Cell parameters ID of Cell 2
-SCTD indicator	FALSE



## MEASUREMENT REPORT message (step 8)

Information Element	Value/remark
Message Type (10.2.17)	
Integrity check info	Not Present
Measurement identity	1
Measured Results (10.3.7.44)	
-CHOICE Measurement	Intra-frequency Measured results list
-Intra-frequency measured results	1
-Cell measured results (10.3.7.3)	
-Cell identity	Not Present
-SFN-SFN observed time difference	Not Present
-Cell synchronisation info	Not Present
-CHOICE mode	TDD
-Cell parameters ID	Set to Cell parameters ID of Cell 3
-Proposed TGSN	Not Present
-Primary CCPCH RSCP	Checked that this IE is present
-Pathloss	Not Present
-Timeslot list	Not Present
Measured results on RACH	Not Present
Additional measured results	Not Present
Event results (10.3.7.7)	
-CHOICE event result	Intra-frequency measurement event results
-Intra-frequency event identity	1G
-Cell measurement event results (10.3.7.4)	
-CHOICE mode	TDD
-Primary CCPCH info (10.3.6.57)	
-CHOICE mode	TDD
-CHOICE TDD option	7,68 Mcps TDD
-CHOICE Sync case	Not Present
-Cell parameters ID	Set to Cell parameters ID of Cell 3
-SCTD indicator	FALSE

## 8.6.1.1.5 Test requirements

## 8.6.1.1.5.1 3,84 Mcps TDD Option

The UE shall send one Event 1G triggered measurement report for Cell 2 with a measurement reporting delay less than 240ms from the beginning of time period T2.

The UE shall send one Event 1G triggered measurement report for Cell 3 with a measurement reporting delay less than 840ms from the beginning of time period T3.

The UE shall not send event triggered measurement reports, as long as the reporting criteria are not fulfilled.

For the test to pass, the total number of successful tests shall be more than 90% with a confidence level of [FFS]% of the cases.

## 8.6.1.1.5.2 1,28 Mcps TDD Option

The UE shall send one Event 1G triggered measurement report for Cell 2 with a measurement reporting delay less than 280ms from the beginning of time period T2.

The UE shall send one Event 1G triggered measurement report for Cell 3 with a measurement reporting delay less than 880ms from the beginning of time period T3.

The UE shall not send any incorrect event triggered measurement reports, as long as the reporting criteria are not fulfilled.

For the test to pass, the total number of successful tests shall be more than 90% with a confidence level of 95% of the cases.

## 8.6.1.1.5.3 7,68 Mcps TDD Option

The UE shall send one Event 1G triggered measurement report for Cell 2 with a measurement reporting delay less than 240ms from the beginning of time period T2.

The UE shall send one Event 1G triggered measurement report for Cell 3 with a measurement reporting delay less than 840ms from the beginning of time period T3.

The UE shall not send event triggered measurement reports, as long as the reporting criteria are not fulfilled.

For the test to pass, the total number of successful tests shall be more than 90% with a confidence level of 95% of the cases.

### 8.6.1.2 Event 1H and 1I triggered reporting in AWGN propagation condition

#### 8.6.1.2.1 Definition and applicability

##### 8.6.1.2.1.1 3,84 Mcps TDD Option

In the event triggered reporting, the measurement reporting delay is defined as the time between any event that will trigger a measurement report until the UE starts to transmit over the Uu interface. This requirement assumes that the measurement report is not delayed by other RRC signalling on the DCCH. This measurement reporting delay excludes a delay uncertainty resulted when inserting the measurement report to the TTI of the uplink DCCH. The delay uncertainty is twice the TTI of the uplink DCCH.

The requirements and this test apply to the TDD (3,84 Mcps option) UE.

##### 8.6.1.2.1.2 1,28 Mcps TDD Option

The purpose of this test is to verify that the UE makes correct reporting of events 1H (timeslot ISCP below threshold) and 1I (timeslot ISCP above threshold). This test will partly verify the requirements in [2]

The requirements and this test apply to all types of 1.28 Mcps TDD UE.

##### 8.6.1.2.1.3 7,68 Mcps TDD Option

In the event triggered reporting, the measurement reporting delay is defined as the time between any event that will trigger a measurement report until the UE starts to transmit over the Uu interface. This requirement assumes that the measurement report is not delayed by other RRC signalling on the DCCH. This measurement reporting delay excludes a delay uncertainty resulted when inserting the measurement report to the TTI of the uplink DCCH. The delay uncertainty is twice the TTI of the uplink DCCH.

The requirements and this test apply to the TDD (7,68 Mcps option) UE.

#### 8.6.1.2.2 Minimum requirement

##### 8.6.1.2.2.1 3,84 Mcps TDD Option

In CELL\_DCH state the measurement period for intra frequency Timeslot ISCP measurements on arbitrary DL timeslots, including Beacon timeslots is 400 ms. When no inter frequency measurement is scheduled, the UE shall be capable of performing Timeslot ISCP measurements for a total of 10 different combinations of an arbitrary DL timeslot and an intra-frequency cell, including the current serving cell.

The normative reference for this requirement is TS 25.123 [2] clauses 8.1.2.2.2.A and A.8.1.2

##### 8.6.1.2.2.2 1,28 Mcps TDD Option

The UE shall send one event 1I triggered measurement report, with a measurement reporting delay less than 400 ms from the beginning of time period T2 as defined in the test method below.

The UE shall send one event 1H triggered measurement report, with a measurement reporting delay less than 400 ms from the beginning of time period T3 as defined in the test method below.

The UE shall send one event 1H triggered measurement report, with a measurement reporting delay less than 400 ms from the beginning of time period T4 as defined in the test method below.

##### 8.6.1.2.2.3 7,68 Mcps TDD Option

In CELL\_DCH state the measurement period for intra frequency Timeslot ISCP measurements on arbitrary DL timeslots, including Beacon timeslots is 400 ms. When no inter frequency measurement is scheduled, the UE shall be

capable of performing Timeslot ISCP measurements for a total of 10 different combinations of an arbitrary DL timeslot and an intra-frequency cell, including the current serving cell.

The normative reference for this requirement is TS 25.123 [2] clauses 8.1B.2.2.3 and A.8.1.2

#### 8.6.1.2.3 Test purpose

##### 8.6.1.2.3.1 3,84 Mcps TDD Option

To verify that the UE meets the minimum requirement.

##### 8.6.1.2.3.2 1,28 Mcps TDD Option

To verify that the UE meets the minimum requirements.

##### 8.6.1.2.3.3 7,68 Mcps TDD Option

To verify that the UE meets the minimum requirements.

#### 8.6.1.2.4 Method of test

##### 8.6.1.2.4.1 3,84 Mcps TDD Option

###### 8.6.1.2.4.1.1 Initial conditions

Test environment: normal; see clauses G.2.1 and G.2.2.

Frequencies to be tested: mid range; see clause G.2.4.

The test parameters are given in Tables 8.6.1.2.1, 8.6.1.2.2 and 8.6.1.2.3. The test consists of five successive time periods, with a time duration of T1, T2, T3, T4 and T5 respectively. Two cells shall be present in the test, cell 1 being the current serving cell and cell 2 being a neighbour cell on the used frequency.

In the measurement control information it shall be indicated to the UE that event-triggered reporting with event 1H and event 1I shall be used and that Timeslot ISCP and P-CCPCH RSCP shall be reported together with event 1H and 1I. Measurement control information shall be sent to the UE before the beginning of time period T1.

The second Beacon timeslot shall be provided in timeslot 8 for both cell 1 and cell 2. The UL DPCH shall be transmitted in timeslot 10. In addition, timeslots 3 and 4 shall be allocated as DL timeslots. Cell 1 and cell 2 shall be synchronised, i.e. share the same frame and timeslot timing.

**Table 8.6.1.2.1: General test parameters for correct event 1H and event 1I reporting in AWGN propagation condition**

Parameter		Unit	Value	Comment
DCH parameters			DL Reference Measurement Channel 12.2 kbps	As specified in TS 25.102 section A.2.2
Power Control			On	
Target quality value on DTCH		BLER	0.01	
Initial conditions	Active cell		Cell 1	
	Neighbour cell		Cell 2	
Final condition	Active cell		Cell 1	
HCS			Not used	
O		dB	0	Cell individual offset. This value shall be used for all cells in the test.
Timeslot list cell 1			2, 3, 4	Timeslot numbers in IE "Cell info" for Cell 1
Timeslot list cell 2			4	Timeslot numbers in IE "Cell info" for Cell 2
Threshold used frequency		dBm	-68	Threshold 1 applicable for event 1H, cell 1 timeslots 2, 4 and cell 2 timeslot 4
Threshold used frequency		dBm	-73	Threshold 2 applicable for event 1H, cell 1 timeslots 2, 3, 4 and cell 2 timeslot 4
Threshold used frequency		dBm	-67	Applicable for event 1I, cell 1 timeslots 2, 4 and cell 2 timeslot 4
Hysteresis		dB	0	
Time to Trigger		ms	0	
Filter coefficient			0	
Monitored cell list size			6 TDD neighbours on Channel 1	Cell 2 shall belong to the monitored set
T1		s	5	
T2		s	5	
T3		s	5	
T4		s	5	
T5		s	5	

**Table 8.6.1.2.2: Cell 1 specific parameters for correct event 1H and 1I reporting in AWGN propagation condition**

Parameter	Unit	Cell 1									
		T1	T2	T3	T4	T5	T1	T2	T3	T4	T5
UTRA RF Channel Number		Channel 1									
<b>DL timeslot number</b>		<b>0</b>					<b>2</b>				
PCCPCH_Ec/lor	dB	-3					n.a.				
SCH_Ec/lor	dB	-9					n.a.				
SCH_t <sub>offset</sub>	dB	5					n.a.				
DPCH_Ec/lor	dB	n.a.					Note 1				
OCNS_Ec/lor	dB	-3,12					Note 2				
$\hat{I}_{or}/I_{oc}$	dB	4					4				
PCCPCH RSCP	dBm	-69					n.a.				
$I_{oc}$	dBm / 3,84 MHz	-70									
Propagation Condition		AWGN									
<b>DL timeslot number</b>		<b>3</b>					<b>4</b>				
PCCPCH_Ec/lor	dB	n.a.					n.a.				
SCH_Ec/lor	dB	n.a.					n.a.				
SCH_t <sub>offset</sub>	dB	n.a.					n.a.				
DPCH_Ec/lor	dB	n.a.					n.a.				
OCNS_Ec/lor	dB	0					0				
$\hat{I}_{or}/I_{oc}$	dB	3					0			6	
PCCPCH RSCP	dBm	n.a.					n.a.				
$I_{oc}$	dBm / 3,84 MHz	-70									
Propagation Condition		AWGN									
Note 1: The DPCH level is controlled by the power control loop											
Note 2: The power of the OCNS channel that is added shall make the total power from the cell to be equal to lor											

**Table 8.6.1.2.3: Cell 2 specific parameters for correct event 1H and 1I reporting in AWGN propagation condition**

Parameter	Unit	Cell 2									
		T1	T2	T3	T4	T5	T1	T2	T3	T4	T5
UTRA RF Channel Number		Channel 1									
<b>DL timeslot number</b>		<b>0</b>					<b>2</b>				
PCCPCH_Ec/lor	dB	-3					n.a.				
SCH_Ec/lor	dB	-9					n.a.				
SCH_t <sub>offset</sub>	dB	10					n.a.				
DPCH_Ec/lor	dB	n.a.					n.a.				
OCNS_Ec/lor	dB	-3,12					0				
$\hat{I}_{or}/I_{oc}$	dB	1					0	6	0		
PCCPCH RSCP	dBm	-72					n.a.				
$I_{oc}$	dBm / 3,84 MHz	-70									
Propagation Condition		AWGN									
<b>DL timeslot number</b>		<b>3</b>					<b>4</b>				
PCCPCH_Ec/lor	dB	n.a.					n.a.				
SCH_Ec/lor	dB	n.a.					n.a.				
SCH_t <sub>offset</sub>	dB	n.a.					n.a.				
DPCH_Ec/lor	dB	n.a.					n.a.				
OCNS_Ec/lor	dB	0					0				
$\hat{I}_{or}/I_{oc}$	dB	3					6			0	
PCCPCH RSCP	dBm	n.a.					n.a.				
$I_{oc}$	dBm / 3,84 MHz	-70									
Propagation Condition		AWGN									

## 8.6.1.2.4.1.2 Procedure

- 1) The RF parameters are set up according to T1.
- 2) The UE is switched on.
- 3) A call is set up according to the generic set-up procedure specified in TS 34.108 [3] subclause 7.4.2 to place the UE in CELL\_DCH.
- 4) SS shall transmit a MEASUREMENT CONTROL message.
- 5) After 5 seconds from the beginning of T1, the SS shall switch the power settings from T1 to T2.
- 6) UE shall transmit a MEASUREMENT REPORT message triggered by event 1I for cell 1 in timeslot 2. The measurement reporting delay from the beginning of T2 shall be less than 480 ms. If the UE fails to report the event within the required delay, then a failure is recorded. If the reporting delay for this event is within the required limit, the number of successful tests is increased by one.
- 7) After 5 seconds from the beginning of T2, the SS shall switch the power settings from T2 to T3.
- 8) UE shall transmit a MEASUREMENT REPORT message triggered by event 1H for cell 1 in timeslot 2. The measurement reporting delay from the beginning of T3 shall be less than 480 ms. If the reporting delay for this event is within the required limit, the number of successful tests is increased by one.
- 9) After 5 seconds from the beginning of T3, the SS shall switch the power settings from T3 to T4.
- 10) UE shall transmit a MEASUREMENT REPORT message triggered by event 1H for cell 1 in timeslot 4. The measurement reporting delay from the beginning of T3 shall be less than 480 ms. If the reporting delay for this event is within the required limit, the number of successful tests is increased by one.
- 11) After 5 seconds from the beginning of T4, the SS shall switch the power settings from T4 to T5.
- 12) UE shall transmit a MEASUREMENT REPORT message triggered by event 1I for cell 2 in timeslot 4. The measurement reporting delay from the beginning of T3 shall be less than 480 ms. If the reporting delay for this event is within the required limit, the number of successful tests is increased by one.
- 13) After 5 seconds from the beginning of T5, the UE is switched off. Any timing information of cell 2 is deleted in the UE.
- 14) Repeat steps 1-13 [TBD] times.

## Specific Message Contents

All messages indicated above shall use the same content as described in the default message content in clause 9 of 34.108 [3] with the following exceptions:

MEASUREMENT CONTROL message (step 4):

Information Element/Group name	Value/Remark
Message Type (10.2.17)	
<b>UE information elements</b>	
-RRC transaction identifier	0
-Integrity check info	Not Present
<b>Measurement Information elements</b>	
-Measurement Identity	1
-Measurement Command (10.3.7.46)	Modify
-Measurement Reporting Mode (10.3.7.49)	AM RLC
-Periodical Reporting / Event Trigger Reporting Mode	Event trigger
-Additional measurements list (10.3.7.1)	Not Present
-CHOICE <i>Measurement type</i>	Intra-frequency measurement
-Intra-frequency measurement (10.3.7.36)	
-Intra-frequency measurement objects list (10.3.7.33)	Not Present
-Intra-frequency measurement quantity (10.3.7.38)	
-Filter coefficient (10.3.7.9)	0
-CHOICE <i>mode</i>	TDD
-Measurement quantity list	1
-Measurement quantity	Timeslot ISCP
-Intra-frequency reporting quantity (10.3.7.41)	
-Reporting quantities for active set cells (10.3.7.5)	No report
-SFN-SFN observed time difference reporting indicator	FALSE
-Cell synchronisation information reporting indicator	FALSE
-Cell Identity reporting indicator	FALSE
-CHOICE <i>mode</i>	TDD
-Timeslot ISCP reporting indicator	TRUE
-Proposed TGSN reporting required	FALSE
-Primary CCPCH RSCP reporting indicator	TRUE
-Pathloss reporting indicator	FALSE
-Reporting quantities for monitored set cells (10.3.7.5)	No report
-SFN-SFN observed time difference reporting indicator	FALSE
-Cell synchronisation information reporting indicator	TRUE
-Cell Identity reporting indicator	TRUE
-CHOICE <i>mode</i>	TDD
-Timeslot ISCP reporting indicator	TRUE
-Proposed TGSN reporting required	FALSE
-Primary CCPCH RSCP reporting indicator	TRUE
-Pathloss reporting indicator	FALSE
-Reporting quantities for detected set cells (10.3.7.5)	Not Present
-Reporting cell status (10.3.7.61)	
-CHOICE <i>reported cell</i>	Report all active set cells + cells within monitored set on used frequency
-Maximum number of reported cells	1
-Measurement validity (10.3.7.51)	Not Present
-CHOICE <i>report criteria</i>	Intra-frequency measurement reporting criteria
-Intra-frequency measurement reporting criteria (10.3.7.39)	
-Parameters required for each event	2
-Intra-frequency event identity	Event 1H
-Triggering condition 2	Not Present
-Reporting Range Constant	Not Present
-Cells forbidden to affect Reporting Range	Not Present
-W	Not Present
-Hysteresis	0 dB
-Threshold used frequency	-68
-Reporting deactivation threshold	Not Present
-Replacement activation threshold	Not Present
-Time to trigger	0 ms
-Amount of reporting	Infinity
-Reporting interval	0 ms (Note 1)
-Reporting cell status	Not Present
-Intra-frequency event identity	Event 1H
-Triggering condition 2	Not Present
-Reporting Range Constant	Not Present
-Cells forbidden to affect Reporting Range	Not Present

Information Element/Group name	Value/Remark
-W -Hysteresis -Threshold used frequency -Reporting deactivation threshold -Replacement activation threshold -Time to trigger -Amount of reporting -Reporting interval -Reporting cell status	Not Present 0 dB -73 Not Present Not Present 0 ms Infinity 0 ms (Note 1) Not Present
-Intra-frequency event identity -Triggering condition 2 -Reporting Range Constant -Cells forbidden to affect Reporting Range -W -Hysteresis -Threshold used frequency -Reporting deactivation threshold -Replacement activation threshold -Time to trigger -Amount of reporting -Reporting interval -Reporting cell status	Event 11 Not Present Not Present Not Present Not Present 0 dB -67 Not Present Not Present 0 ms Infinity 0 ms (Note 1) Not Present
<b>Physical channel information elements</b> -DPCH compressed mode status info (10.3.6.34)	Not Present
Note 1: Reporting interval = 0 ms means no periodical reporting	

## MEASUREMENT REPORT message (step 6)

Information Element	Value/remark
Message Type (10.2.17)	
Integrity check info	Not Present
Measurement identity	1
Measured Results (10.3.7.44)	
-CHOICE Measurement	Intra-frequency Measured results list
-Intra-frequency measured results	1
-Cell measured results (10.3.7.3)	
-Cell identity	Not Present
-SFN-SFN observed time difference	Not Present
-Cell synchronisation info	Not Present
-CHOICE mode	TDD
-Cell parameters ID	Set to Cell parameters ID of cell 1
-Proposed TGSN	Not Present
-Primary CCPCH RSCP	Checked that this IE is present
-Pathloss	Not Present
-Timeslot list	4
-Timeslot ISCP	Checked that this IE is present for 4 timeslots
Measured results on RACH	Not Present
Additional measured results	Not Present
Event results (10.3.7.7)	
-CHOICE event result	Intra-frequency measurement event results
-Intra-frequency event identity	11
-Cell measurement event results (10.3.7.4)	
-CHOICE mode	TDD
-Primary CCPCH info (10.3.6.57)	
-CHOICE mode	TDD
-Cell parameters ID	Set to Cell parameters ID of cell 1



## MEASUREMENT REPORT message (step 8)

Information Element	Value/remark
Message Type (10.2.17)	
Integrity check info	Not Present
Measurement identity	1
Measured Results (10.3.7.44)	
-CHOICE Measurement	Intra-frequency Measured results list
-Intra-frequency measured results	1
-Cell measured results (10.3.7.3)	
-Cell identity	Not Present
-SFN-SFN observed time difference	Not Present
-Cell synchronisation info	Not Present
-CHOICE mode	TDD
-Cell parameters ID	Set to Cell parameters ID of cell 1
-Proposed TGSN	Not Present
-Primary CCPCH RSCP	Checked that this IE is present
-Pathloss	Not Present
-Timeslot list	4
-Timeslot ISCP	Checked that this IE is present for 4 timeslots
Measured results on RACH	Not Present
Additional measured results	Not Present
Event results (10.3.7.7)	
-CHOICE event result	Intra-frequency measurement event results
-Intra-frequency event identity	1H
-Cell measurement event results (10.3.7.4)	
-CHOICE mode	TDD
-Primary CCPCH info (10.3.6.57)	
-CHOICE mode	TDD
-Cell parameters ID	Set to Cell parameters ID of cell 1

## MEASUREMENT REPORT message (step 10)

Information Element	Value/remark
Message Type (10.2.17)	
Integrity check info	Not Present
Measurement identity	1
Measured Results (10.3.7.44)	
-CHOICE Measurement	Intra-frequency Measured results list
-Intra-frequency measured results	1
-Cell measured results (10.3.7.3)	
-Cell identity	Not Present
-SFN-SFN observed time difference	Not Present
-Cell synchronisation info	Not Present
-CHOICE mode	TDD
-Cell parameters ID	Set to Cell parameters ID of cell 1
-Proposed TGSN	Not Present
-Primary CCPCH RSCP	Checked that this IE is present
-Pathloss	Not Present
-Timeslot list	4
-Timeslot ISCP	Checked that this IE is present for 4 timeslots
Measured results on RACH	Not Present
Additional measured results	Not Present
Event results (10.3.7.7)	
-CHOICE event result	Intra-frequency measurement event results
-Intra-frequency event identity	1H
-Cell measurement event results (10.3.7.4)	
-CHOICE mode	TDD
-Primary CCPCH info (10.3.6.57)	
-CHOICE mode	TDD
-Cell parameters ID	Set to Cell parameters ID of cell 1

## MEASUREMENT REPORT message (step 12)

Information Element	Value/remark
Message Type (10.2.17)	
Integrity check info	Not Present
Measurement identity	1
Measured Results (10.3.7.44)	
-CHOICE Measurement	Intra-frequency Measured results list
-Intra-frequency measured results	1
-Cell measured results (10.3.7.3)	
-Cell identity	Not Present
-SFN-SFN observed time difference	Not Present
-Cell synchronisation info	Not Present
-CHOICE mode	TDD
-Cell parameters ID	Set to Cell parameters ID of cell 2
-Proposed TGSN	Not Present
-Primary CCPCH RSCP	Checked that this IE is present
-Pathloss	Not Present
-Timeslot list	1
-Timeslot ISCP	Checked that this IE is present
Measured results on RACH	Not Present
Additional measured results	Not Present
Event results (10.3.7.7)	
-CHOICE event result	Intra-frequency measurement event results
-Intra-frequency event identity	11
-Cell measurement event results (10.3.7.4)	
-CHOICE mode	TDD
-Primary CCPCH info (10.3.6.57)	
-CHOICE mode	TDD
-Cell parameters ID	Set to Cell parameters ID of cell 2

## 8.6.1.2.4.2 1,28 Mcps TDD Option

Test environment : normal; see clauses G.2.1 and G.2.2.

Frequencies to be tested : mid range ;see clauses G.2.4.

The test parameters are given in Table 8.6.1.2.4.2A, Table 8.6.1.2.4.2B and Table 8.6.1.2.4.2C below. The test consists of four successive time periods, with a time duration of T1, T2, T3 and T4 respectively. Two cells shall be present in the test, cell 1 being the current serving cell and cell 2 being a neighbour cell on the used frequency.

In the measurement control information it shall be indicated to the UE that event-triggered reporting with event 1H and event 1I shall be used and that Timeslot ISCP and P-CCPCH RSCP shall be reported together with event 1H and 1I. Measurement control information shall be sent to the UE before the beginning of time period T1.

The UL DPCH shall be transmitted in timeslot 2. In addition, timeslots 5 and 6 shall be allocated as DL timeslots.

**Table 8.6.1.2.4.2A: General test parameters for correct event 1H and 1I reporting in AWGN propagation condition 1,28Mcps option**

Parameter		Unit	Value	Comment
DCH parameters active cell			DL Reference Measurement Channel 12.2 kbps	As specified in TS 25.102 section A.
Power Control			On	
Target quality value on DTCH		BLER	0.01	
Initial conditions	Active cell		Cell 1	
	Neighbour cell		Cell 2	
Final condition	Active cell		Cell 1	
O		dB	0	Cell individual offset. This value shall be used for all cells in the test.
Timeslot list cell 1			5, 6	Timeslot numbers in IE "Cell info" for Cell 1
Timeslot list cell 2			6	Timeslot numbers in IE "Cell info" for Cell 2
Threshold used frequency		dBm	-68	Applicable for event 1H, cell 1 timeslots 5, 6 and cell 2 timeslot 6
Threshold used frequency		dBm	-66	Applicable for event 1I, cell 1 timeslots 5, 6 and cell 2 timeslot 6
Hysteresis		dB	0	
Time to Trigger		ms	0	
Filter coefficient			0	
Monitored cell list size			6 TDD neighbours on Channel 1	Cell 2 shall belong to the monitored set
T1		s	5	
T2		s	5	
T3		s	5	
T4		s	5	

**Table 8.6.1.2.4.2B: Cell 1 specific test parameters for correct event 1H and 1I reporting in AWGN propagation condition 1,28Mcps Option**

Parameter	Unit	Cell 1											
		T1	T2	T3	T4	T1	T2	T3	T4	T1	T2	T3	T4
UTRA RF Channel Number		Channel 1											
DL timeslot number		0			5			6					
PCCPCH_Ec/I <sub>or</sub>	dB	-3											
DPCH_Ec/I <sub>or</sub>	dB	Note 1											
OCNS_Ec/I <sub>or</sub>	dB	-3			Note 2			0					
$\hat{I}_{or}/I_{oc}$	dB	4			3			4	20		4		
PCCPCH RSCP	dBm	-79			n.a.			n.a.					
ISCP	dBm	Note 3			Note 3			-60	-60	-	-	74.5	74.5
$I_{oc}$	dBm / 1,28 MHz	-80											
Note 1: The DPCH level is controlled by the power control loop Note 2: The power of the OCNS channel that is added shall make the total power from the cell to be equal to I <sub>or</sub> Note 3: ISCP of TS0 and TS5 remains changeless.													

**Table 8.6.1.2.4.2C: Cell 2 specific test parameters for correct event 1H and 1I reporting in AWGN propagation condition 1,28Mcps option**

Parameter	Unit	Cell 2							
		T1	T2	T3	T4	T1	T2	T3	T4
UTRA RF Channel Number		Channel 1							
DL timeslot number		0				6			
PCCPCH_Ec/lor	dB	-3							
DPCH_Ec/lor	dB								
OCNS_Ec/lor	dB	-3				0			
$\hat{I}_{or}/I_{oc}$	dB	4				20		4	
PCCPCH RSCP	dBm	-79				n.a.			
ISCP	dBm	Note1				-74.54	-60	-60	-74.54
$I_{oc}$	dBm / 1,28 MHz	-80							
Note1: ISCP of TS0 remains changeless									

### Procedure

- 1) The RF parameters are set up according to T1.
- 2) The UE is switched on.
- 3) A call is set up according to the generic set-up procedure specified in TS 34.108 [3] subclause 7.4.2 to place the UE in CELL\_DCH.
- 4) SS shall transmit a MEASUREMENT CONTROL message.
- 5) After 5 seconds from the beginning of T1, the SS shall switch the power settings from T1 to T2.
- 6) UE shall transmit a MEASUREMENT REPORT message triggered by event 1I for cell 2 in timeslot 6. The measurement reporting delay from the beginning of T2 shall be less than 480 ms. If the UE fails to report the event within the required delay, then a failure is recorded. If the reporting delay for this event is within the required limit, the number of successful tests is increased by one.
- 7) After 5 seconds from the beginning of T2, the SS shall switch the power settings from T2 to T3.
- 8) UE shall transmit a MEASUREMENT REPORT message triggered by event 1H for cell 1 in timeslot 6. The measurement reporting delay from the beginning of T3 shall be less than 480 ms. If the reporting delay for this event is within the required limit, the number of successful tests is increased by one.
- 9) After 5 seconds from the beginning of T3, the SS shall switch the power settings from T3 to T4.
- 10) UE shall transmit a MEASUREMENT REPORT message triggered by event 1H for cell 2 in timeslot 6. The measurement reporting delay from the beginning of T3 shall be less than 480 ms. If the reporting delay for this event is within the required limit, the number of successful tests is increased by one.
- 11) After 5 seconds from the beginning of T4, the UE is switched off. Any timing information of cell 2 is deleted in the UE.
- 12) Repeat steps 1-13 [TBD] times.

### Specific Message Contents

All messages indicated above shall use the same content as described in the default message content in clause 9 of 34.108 [3], with the following exceptions:

MEASUREMENT CONTROL message (step 4):

Information Element/Group name	Value/Remark
Message Type (10.2.17)	
<b>UE information elements</b>	
-RRC transaction identifier	0
-Integrity check info	Not Present
<b>Measurement Information elements</b>	
-Measurement Identity	1
-Measurement Command (10.3.7.46)	Modify
-Measurement Reporting Mode (10.3.7.49)	AM RLC
-Periodical Reporting / Event Trigger Reporting Mode	Event trigger
-Additional measurements list (10.3.7.1)	Not Present
-CHOICE <i>Measurement type</i>	Intra-frequency measurement
-Intra-frequency measurement (10.3.7.36)	
-Intra-frequency measurement objects list (10.3.7.33)	Not Present
-Intra-frequency measurement quantity (10.3.7.38)	
-Filter coefficient (10.3.7.9)	0
-CHOICE <i>mode</i>	TDD
-Measurement quantity list	1
-Measurement quantity	Timeslot ISCP
-Intra-frequency reporting quantity (10.3.7.41)	
-Reporting quantities for active set cells (10.3.7.5)	No report
-SFN-SFN observed time difference reporting indicator	FALSE
-Cell synchronisation information reporting indicator	FALSE
-Cell Identity reporting indicator	FALSE
-CHOICE <i>mode</i>	TDD
-Timeslot ISCP reporting indicator	TRUE
-Proposed TGSN reporting required	FALSE
-Primary CCPCH RSCP reporting indicator	TRUE
-Pathloss reporting indicator	FALSE
-Reporting quantities for monitored set cells (10.3.7.5)	No report
-SFN-SFN observed time difference reporting indicator	FALSE
-Cell synchronisation information reporting indicator	TRUE
-Cell Identity reporting indicator	TRUE
-CHOICE <i>mode</i>	TDD
-Timeslot ISCP reporting indicator	TRUE
-Proposed TGSN reporting required	FALSE
-Primary CCPCH RSCP reporting indicator	TRUE
-Pathloss reporting indicator	FALSE
-Reporting quantities for detected set cells (10.3.7.5)	Not Present
-Reporting cell status (10.3.7.61)	
-CHOICE <i>reported cell</i>	Report all active set cells + cells within monitored set on used frequency
-Maximum number of reported cells	1
-Measurement validity (10.3.7.51)	Not Present
-CHOICE <i>report criteria</i>	Intra-frequency measurement reporting criteria
-Intra-frequency measurement reporting criteria (10.3.7.39)	
-Parameters required for each event	2
-Intra-frequency event identity	Event 1H
-Triggering condition 2	Not Present
-Reporting Range Constant	Not Present
-Cells forbidden to affect Reporting Range	Not Present
-W	Not Present
-Hysteresis	0 dB
-Threshold used frequency	-68
-Reporting deactivation threshold	Not Present
-Replacement activation threshold	Not Present
-Time to trigger	0 ms
-Amount of reporting	Infinity
-Reporting interval	0 ms (Note 1)
-Reporting cell status	Not Present
-Intra-frequency event identity	Event 1I
-Triggering condition 2	Not Present
-Reporting Range Constant	Not Present
-Cells forbidden to affect Reporting Range	Not Present

Information Element/Group name	Value/Remark
-W	Not Present
-Hysteresis	0 dB
-Threshold used frequency	-66
-Reporting deactivation threshold	Not Present
-Replacement activation threshold	Not Present
-Time to trigger	0 ms
-Amount of reporting	Infinity
-Reporting interval	0 ms (Note 1)
-Reporting cell status	Not Present
<b>Physical channel information elements</b>	
-DPCH compressed mode status info (10.3.6.34)	Not Present
Note 1: Reporting interval = 0 ms means no periodical reporting	

MEASUREMENT REPORT message (step 6)

MEASUREMENT REPORT message (step 6)

Information Element	Value/remark
Message Type (10.2.17)	
Integrity check info	Not Present
Measurement identity	1
Measured Results (10.3.7.44)	
-CHOICE Measurement	Intra-frequency Measured results list
-Intra-frequency measured results	1
-Cell measured results (10.3.7.3)	
-Cell identity	Not Present
-SFN-SFN observed time difference	Not Present
-Cell synchronisation info	Not Present
-CHOICE mode	TDD
-Cell parameters ID	Set to Cell parameters ID of cell 2
-Proposed TGSN	Not Present
-Primary CCPCH RSCP	Checked that this IE is present
-Pathloss	Not Present
-Timeslot list	6
-Timeslot ISCP	Checked that this IE is present for 4 timeslots
Measured results on RACH	Not Present
Additional measured results	Not Present
Event results (10.3.7.7)	
-CHOICE event result	Intra-frequency measurement event results
-Intra-frequency event identity	11
-Cell measurement event results (10.3.7.4)	
-CHOICE mode	TDD
-Primary CCPCH info (10.3.6.57)	
-CHOICE mode	TDD
-Cell parameters ID	Set to Cell parameters ID of cell 2

## MEASUREMENT REPORT message (step 8)

Information Element	Value/remark
Message Type (10.2.17)	
Integrity check info	Not Present
Measurement identity	1
Measured Results (10.3.7.44)	
-CHOICE Measurement	Intra-frequency Measured results list
-Intra-frequency measured results	1
-Cell measured results (10.3.7.3)	
-Cell identity	Not Present
-SFN-SFN observed time difference	Not Present
-Cell synchronisation info	Not Present
-CHOICE mode	TDD
-Cell parameters ID	Set to Cell parameters ID of cell 1
-Proposed TGSN	Not Present
-Primary CCPCH RSCP	Checked that this IE is present
-Pathloss	Not Present
-Timeslot list	6
-Timeslot ISCP	Checked that this IE is present for 4 timeslots
Measured results on RACH	Not Present
Additional measured results	Not Present
Event results (10.3.7.7)	
-CHOICE event result	Intra-frequency measurement event results
-Intra-frequency event identity	1H
-Cell measurement event results (10.3.7.4)	
-CHOICE mode	TDD
-Primary CCPCH info (10.3.6.57)	
-CHOICE mode	TDD
-Cell parameters ID	Set to Cell parameters ID of cell 1

## MEASUREMENT REPORT message (step 10)

Information Element	Value/remark
Message Type (10.2.17)	
Integrity check info	Not Present
Measurement identity	1
Measured Results (10.3.7.44)	
-CHOICE Measurement	Intra-frequency Measured results list
-Intra-frequency measured results	1
-Cell measured results (10.3.7.3)	
-Cell identity	Not Present
-SFN-SFN observed time difference	Not Present
-Cell synchronisation info	Not Present
-CHOICE mode	TDD
-Cell parameters ID	Set to Cell parameters ID of cell 2
-Proposed TGSN	Not Present
-Primary CCPCH RSCP	Checked that this IE is present
-Pathloss	Not Present
-Timeslot list	6
-Timeslot ISCP	Checked that this IE is present for 4 timeslots
Measured results on RACH	Not Present
Additional measured results	Not Present
Event results (10.3.7.7)	
-CHOICE event result	Intra-frequency measurement event results
-Intra-frequency event identity	1H
-Cell measurement event results (10.3.7.4)	
-CHOICE mode	TDD
-Primary CCPCH info (10.3.6.57)	
-CHOICE mode	TDD
-Cell parameters ID	Set to Cell parameters ID of cell 2

## 8.6.1.2.4.3 7,68 Mcps TDD Option

## 8.6.1.2.4.3.1 Initial conditions

Test environment: normal; see clauses G.2.1 and G.2.2.

Frequencies to be tested: mid range; see clause G.2.4.

The test parameters are given in Tables 8.6.1.2.4.3.1.1, 8.6.1.2.4.3.1.2 and 8.6.1.2.4.3.1.3. The test consists of five successive time periods, with a time duration of T1, T2, T3, T4 and T5 respectively. Two cells shall be present in the test, cell 1 being the current serving cell and cell 2 being a neighbour cell on the used frequency.

In the measurement control information it shall be indicated to the UE that event-triggered reporting with event 1H and event 1I shall be used and that Timeslot ISCP and P-CCPCH RSCP shall be reported together with event 1H and 1I. Measurement control information shall be sent to the UE before the beginning of time period T1.

The second Beacon timeslot shall be provided in timeslot 8 for both cell 1 and cell 2. The UL DPCH shall be transmitted in timeslot 10. In addition, timeslots 3 and 4 shall be allocated as DL timeslots. Cell 1 and cell 2 shall be synchronised, i.e. share the same frame and timeslot timing.

**Table 8.6.1.2.4.3.1.1: General test parameters for correct event 1H and event 1I reporting in AWGN propagation condition**

Parameter	Unit	Value	Comment
DCH parameters		DL Reference Measurement Channel 12.2 kbps	As specified in TS 25.102 section A.2.2
Power Control		On	
Target quality value on DTCH	BLER	0.01	
Initial conditions	Active cell	Cell 1	
	Neighbour cell	Cell 2	
Final condition	Active cell	Cell 1	
HCS		Not used	
O	dB	0	Cell individual offset. This value shall be used for all cells in the test.
Timeslot list cell 1		2, 3, 4	Timeslot numbers in IE "Cell info" for Cell 1
Timeslot list cell 2		4	Timeslot numbers in IE "Cell info" for Cell 2
Threshold used frequency	dBm	-68	Threshold 1 applicable for event 1H, cell 1 timeslots 2, 4 and cell 2 timeslot 4
Threshold used frequency	dBm	-73	Threshold 2 applicable for event 1H, cell 1 timeslots 2, 3, 4 and cell 2 timeslot 4
Threshold used frequency	dBm	-67	Applicable for event 1I, cell 1 timeslots 2, 4 and cell 2 timeslot 4
Hysteresis	dB	0	
Time to Trigger	ms	0	
Filter coefficient		0	
Monitored cell list size		6 TDD neighbours on Channel 1	Cell 2 shall belong to the monitored set
T1	s	5	
T2	s	5	
T3	s	5	
T4	s	5	
T5	s	5	



**Table 8.6.1.2.4.3.1.2: Cell 1 specific parameters for correct event 1H and 1I reporting in AWGN propagation condition**

Parameter	Unit	Cell 1									
		T1	T2	T3	T4	T5	T1	T2	T3	T4	T5
UTRA RF Channel Number		Channel 1									
<b>DL timeslot number</b>		<b>0</b>					<b>2</b>				
PCCPCH_Ec/lor	dB	-3					n.a.				
SCH_Ec/lor	dB	-9					n.a.				
SCH_t_offset	dB	5					n.a.				
DPCH_Ec/lor	dB	n.a.					Note 1				
OCNS_Ec/lor	dB	-3,12					Note 2				
$\hat{I}_{or}/I_{oc}$	dB	4					4				
PCCPCH RSCP	dBm	-69					n.a.				
$I_{oc}$	dBm / 7,68 MHz	-70									
Propagation Condition		AWGN									
<b>DL timeslot number</b>		<b>3</b>					<b>4</b>				
PCCPCH_Ec/lor	dB	n.a.					n.a.				
SCH_Ec/lor	dB	n.a.					n.a.				
SCH_t_offset	dB	n.a.					n.a.				
DPCH_Ec/lor	dB	n.a.					n.a.				
OCNS_Ec/lor	dB	0					0				
$\hat{I}_{or}/I_{oc}$	dB	3					0			6	
PCCPCH RSCP	dBm	n.a.					n.a.				
$I_{oc}$	dBm / 7,68 MHz	-70									
Propagation Condition		AWGN									
Note 1:	The DPCH level is controlled by the power control loop										
Note 2:	The power of the OCNS channel that is added shall make the total power from the cell to be equal to lor										

**Table 8.6.1.2.4.3.1.3: Cell 2 specific parameters for correct event 1H and 1I reporting in AWGN propagation condition**

Parameter	Unit	Cell 2									
		T1	T2	T3	T4	T5	T1	T2	T3	T4	T5
UTRA RF Channel Number		Channel 1									
<b>DL timeslot number</b>		<b>0</b>					<b>2</b>				
PCCPCH_Ec/lor	dB	-3					n.a.				
SCH_Ec/lor	dB	-9					n.a.				
SCH_t_offset	dB	10					n.a.				
DPCH_Ec/lor	dB	n.a.					n.a.				
OCNS_Ec/lor	dB	-3,12					0				
$\hat{I}_{or}/I_{oc}$	dB	1					0	6	0		
PCCPCH RSCP	dBm	-72					n.a.				
$I_{oc}$	dBm / 7,68 MHz	-70									
Propagation Condition		AWGN									
<b>DL timeslot number</b>		<b>3</b>					<b>4</b>				
PCCPCH_Ec/lor	dB	n.a.					n.a.				
SCH_Ec/lor	dB	n.a.					n.a.				
SCH_t_offset	dB	n.a.					n.a.				
DPCH_Ec/lor	dB	n.a.					n.a.				
OCNS_Ec/lor	dB	0					0				
$\hat{I}_{or}/I_{oc}$	dB	3					6			0	
PCCPCH RSCP	dBm	n.a.					n.a.				
$I_{oc}$	dBm / 7,68 MHz	-70									
Propagation Condition		AWGN									

## 8.6.1.2.4.3.2 Procedure

- 1) The RF parameters are set up according to T1.
- 2) The UE is switched on.
- 3) A call is set up according to the generic set-up procedure specified in TS 34.108 [3] subclause 7.4.2 to place the UE in CELL\_DCH.
- 4) SS shall transmit a MEASUREMENT CONTROL message.
- 5) After 5 seconds from the beginning of T1, the SS shall switch the power settings from T1 to T2.
- 6) UE shall transmit a MEASUREMENT REPORT message triggered by event 1I for cell 1 in timeslot 2. The measurement reporting delay from the beginning of T2 shall be less than 480 ms. If the UE fails to report the event within the required delay, then a failure is recorded. If the reporting delay for this event is within the required limit, the number of successful tests is increased by one.
- 7) After 5 seconds from the beginning of T2, the SS shall switch the power settings from T2 to T3.
- 8) UE shall transmit a MEASUREMENT REPORT message triggered by event 1H for cell 1 in timeslot 2. The measurement reporting delay from the beginning of T3 shall be less than 480 ms. If the reporting delay for this event is within the required limit, the number of successful tests is increased by one.
- 9) After 5 seconds from the beginning of T3, the SS shall switch the power settings from T3 to T4.
- 10) UE shall transmit a MEASUREMENT REPORT message triggered by event 1H for cell 1 in timeslot 4. The measurement reporting delay from the beginning of T3 shall be less than 480 ms. If the reporting delay for this event is within the required limit, the number of successful tests is increased by one.
- 11) After 5 seconds from the beginning of T4, the SS shall switch the power settings from T4 to T5.
- 12) UE shall transmit a MEASUREMENT REPORT message triggered by event 1I for cell 2 in timeslot 4. The measurement reporting delay from the beginning of T3 shall be less than 480 ms. If the reporting delay for this event is within the required limit, the number of successful tests is increased by one.
- 13) After 5 seconds from the beginning of T5, the UE is switched off. Any timing information of cell 2 is deleted in the UE.
- 14) Repeat steps 1-13 until the confidence level according to annex F.6.2 is achieved.

## Specific Message Contents

All messages indicated above shall use the same content as described in the default message content in clause 9 of 34.108 [3] with the following exceptions:

MEASUREMENT CONTROL message (step 4):

Information Element/Group name	Value/Remark
Message Type (10.2.17)	
<b>UE information elements</b>	
-RRC transaction identifier	0
-Integrity check info	Not Present
<b>Measurement Information elements</b>	
-Measurement Identity	1
-Measurement Command (10.3.7.46)	Modify
-Measurement Reporting Mode (10.3.7.49)	AM RLC
-Periodical Reporting / Event Trigger Reporting Mode	Event trigger
-Additional measurements list (10.3.7.1)	Not Present
-CHOICE <i>Measurement type</i>	Intra-frequency measurement
-Intra-frequency measurement (10.3.7.36)	
-Intra-frequency measurement objects list (10.3.7.33)	Not Present
-Intra-frequency measurement quantity (10.3.7.38)	
-Filter coefficient (10.3.7.9)	0
-CHOICE <i>mode</i>	TDD
-Measurement quantity list	1
-Measurement quantity	Timeslot ISCP
-Intra-frequency reporting quantity (10.3.7.41)	
-Reporting quantities for active set cells (10.3.7.5)	No report
-SFN-SFN observed time difference reporting indicator	FALSE
-Cell synchronisation information reporting indicator	FALSE
-Cell Identity reporting indicator	FALSE
-CHOICE <i>mode</i>	TDD
-Timeslot ISCP reporting indicator	TRUE
-Proposed TGSN reporting required	FALSE
-Primary CCPCH RSCP reporting indicator	TRUE
-Pathloss reporting indicator	FALSE
-Reporting quantities for monitored set cells (10.3.7.5)	No report
-SFN-SFN observed time difference reporting indicator	FALSE
-Cell synchronisation information reporting indicator	TRUE
-Cell Identity reporting indicator	TRUE
-CHOICE <i>mode</i>	TDD
-Timeslot ISCP reporting indicator	TRUE
-Proposed TGSN reporting required	FALSE
-Primary CCPCH RSCP reporting indicator	TRUE
-Pathloss reporting indicator	FALSE
-Reporting quantities for detected set cells (10.3.7.5)	Not Present
-Reporting cell status (10.3.7.61)	
-CHOICE <i>reported cell</i>	Report all active set cells + cells within monitored set on used frequency
-Maximum number of reported cells	1
-Measurement validity (10.3.7.51)	Not Present
-CHOICE <i>report criteria</i>	Intra-frequency measurement reporting criteria
-Intra-frequency measurement reporting criteria (10.3.7.39)	
-Parameters required for each event	2
-Intra-frequency event identity	Event 1H
-Triggering condition 2	Not Present
-Reporting Range Constant	Not Present
-Cells forbidden to affect Reporting Range	Not Present
-W	Not Present
-Hysteresis	0 dB
-Threshold used frequency	-68
-Reporting deactivation threshold	Not Present
-Replacement activation threshold	Not Present
-Time to trigger	0 ms
-Amount of reporting	Infinity
-Reporting interval	0 ms (Note 1)
-Reporting cell status	Not Present
-Intra-frequency event identity	Event 1H
-Triggering condition 2	Not Present
-Reporting Range Constant	Not Present
-Cells forbidden to affect Reporting Range	Not Present

Information Element/Group name	Value/Remark
-W -Hysteresis -Threshold used frequency -Reporting deactivation threshold -Replacement activation threshold -Time to trigger -Amount of reporting -Reporting interval -Reporting cell status	Not Present 0 dB -73 Not Present Not Present 0 ms Infinity 0 ms (Note 1) Not Present
-Intra-frequency event identity -Triggering condition 2 -Reporting Range Constant -Cells forbidden to affect Reporting Range -W -Hysteresis -Threshold used frequency -Reporting deactivation threshold -Replacement activation threshold -Time to trigger -Amount of reporting -Reporting interval -Reporting cell status	Event 11 Not Present Not Present Not Present Not Present 0 dB -67 Not Present Not Present 0 ms Infinity 0 ms (Note 1) Not Present
<b>Physical channel information elements</b> -DPCH compressed mode status info (10.3.6.34)	Not Present
Note 1: Reporting interval = 0 ms means no periodical reporting	

## MEASUREMENT REPORT message (step 6)

Information Element	Value/remark
Message Type (10.2.17)	
Integrity check info	Not Present
Measurement identity	1
Measured Results (10.3.7.44)	
-CHOICE Measurement	Intra-frequency Measured results list
-Intra-frequency measured results	1
-Cell measured results (10.3.7.3)	
-Cell identity	Not Present
-SFN-SFN observed time difference	Not Present
-Cell synchronisation info	Not Present
-CHOICE mode	TDD
-Cell parameters ID	Set to Cell parameters ID of cell 1
-Proposed TGSN	Not Present
-Primary CCPCH RSCP	Checked that this IE is present
-Pathloss	Not Present
-Timeslot list	4
-Timeslot ISCP	Checked that this IE is present for 4 timeslots
Measured results on RACH	Not Present
Additional measured results	Not Present
Event results (10.3.7.7)	
-CHOICE event result	Intra-frequency measurement event results
-Intra-frequency event identity	11
-Cell measurement event results (10.3.7.4)	
-CHOICE mode	TDD
-Primary CCPCH info (10.3.6.57)	
-CHOICE mode	TDD
-CHOICE <i>TDD option</i>	7,68 Mcps TDD
-CHOICE <i>Sync case</i>	Not Present
-Cell parameters ID	Set to Cell parameters ID of Cell 1
-SCTD indicator	FALSE

## MEASUREMENT REPORT message (step 8)

Information Element	Value/remark
Message Type (10.2.17)	
Integrity check info	Not Present
Measurement identity	1
Measured Results (10.3.7.44)	
-CHOICE Measurement	Intra-frequency Measured results list
-Intra-frequency measured results	1
-Cell measured results (10.3.7.3)	
-Cell identity	Not Present
-SFN-SFN observed time difference	Not Present
-Cell synchronisation info	Not Present
-CHOICE mode	TDD
-Cell parameters ID	Set to Cell parameters ID of cell 1
-Proposed TGSN	Not Present
-Primary CCPCH RSCP	Checked that this IE is present
-Pathloss	Not Present
-Timeslot list	4
-Timeslot ISCP	Checked that this IE is present for 4 timeslots
Measured results on RACH	Not Present
Additional measured results	Not Present
Event results (10.3.7.7)	
-CHOICE event result	Intra-frequency measurement event results
-Intra-frequency event identity	1H
-Cell measurement event results (10.3.7.4)	
-CHOICE mode	TDD
-Primary CCPCH info (10.3.6.57)	
-CHOICE mode	TDD
-CHOICE <i>TDD option</i>	7,68 Mcps TDD
-CHOICE <i>Sync case</i>	Not Present
-Cell parameters ID	Set to Cell parameters ID of Cell 1
-SCTD indicator	FALSE

## MEASUREMENT REPORT message (step 10)

Information Element	Value/remark
Message Type (10.2.17)	
Integrity check info	Not Present
Measurement identity	1
Measured Results (10.3.7.44)	
-CHOICE Measurement	Intra-frequency Measured results list
-Intra-frequency measured results	1
-Cell measured results (10.3.7.3)	
-Cell identity	Not Present
-SFN-SFN observed time difference	Not Present
-Cell synchronisation info	Not Present
-CHOICE mode	TDD
-Cell parameters ID	Set to Cell parameters ID of cell 1
-Proposed TGSN	Not Present
-Primary CCPCH RSCP	Checked that this IE is present
-Pathloss	Not Present
-Timeslot list	4
-Timeslot ISCP	Checked that this IE is present for 4 timeslots
Measured results on RACH	Not Present
Additional measured results	Not Present
Event results (10.3.7.7)	
-CHOICE event result	Intra-frequency measurement event results
-Intra-frequency event identity	1H
-Cell measurement event results (10.3.7.4)	
-CHOICE mode	TDD
-Primary CCPCH info (10.3.6.57)	
-CHOICE mode	TDD
-CHOICE <i>TDD option</i>	7,68 Mcps TDD
-CHOICE <i>Sync case</i>	Not Present
-Cell parameters ID	Set to Cell parameters ID of Cell 1
-SCTD indicator	FALSE

## MEASUREMENT REPORT message (step 12)

Information Element	Value/remark
Message Type (10.2.17)	
Integrity check info	Not Present
Measurement identity	1
Measured Results (10.3.7.44)	
-CHOICE Measurement	Intra-frequency Measured results list
-Intra-frequency measured results	1
-Cell measured results (10.3.7.3)	
-Cell identity	Not Present
-SFN-SFN observed time difference	Not Present
-Cell synchronisation info	Not Present
-CHOICE mode	TDD
-Cell parameters ID	Set to Cell parameters ID of cell 2
-Proposed TGSN	Not Present
-Primary CCPCH RSCP	Checked that this IE is present
-Pathloss	Not Present
-Timeslot list	1
-Timeslot ISCP	Checked that this IE is present
Measured results on RACH	Not Present
Additional measured results	Not Present
Event results (10.3.7.7)	
-CHOICE event result	Intra-frequency measurement event results
-Intra-frequency event identity	11
-Cell measurement event results (10.3.7.4)	
-CHOICE mode	TDD
-Primary CCPCH info (10.3.6.57)	
-CHOICE mode	TDD
-CHOICE <i>TDD option</i>	7,68 Mcps TDD
-CHOICE <i>Sync case</i>	Not Present
-Cell parameters ID	Set to Cell parameters ID of Cell 2
-SCTD indicator	FALSE

## 8.6.1.2.5 Test requirements

## 8.6.1.2.5.1 3,84 Mcps TDD Option

The UE shall send one event 1I triggered measurement report, with a measurement reporting delay less than 480 ms from the beginning of time period T2.

The UE shall send one event 1H triggered measurement report, with a measurement reporting delay less than 480 ms from the beginning of time period T3.

The UE shall send one event 1H triggered measurement report, with a measurement reporting delay less than 480 ms from the beginning of time period T4.

The UE shall send one event 1I triggered measurement report, with a measurement reporting delay less than 480 ms from the beginning of time period T5.

The UE shall not send event 1H or 1I triggered measurement reports, as long as the reporting criteria are not fulfilled.

For the test to pass, the total number of successful tests shall be more than 90% with a confidence level of [FFS]% of the cases.

## 8.6.1.2.5.2 1,28 Mcps TDD Option

The UE shall not send event 1H or 1I triggered measurement reports, as long as the reporting criteria are not fulfilled.

The rate of correct events observed during repeated tests shall be at least 90%.

## 8.6.1.2.5.3 7,68 Mcps TDD Option

The UE shall send one event 1I triggered measurement report, with a measurement reporting delay less than 480 ms from the beginning of time period T2.

The UE shall send one event 1H triggered measurement report, with a measurement reporting delay less than 480 ms from the beginning of time period T3.

The UE shall send one event 1H triggered measurement report, with a measurement reporting delay less than 480 ms from the beginning of time period T4.

The UE shall send one event 1I triggered measurement report, with a measurement reporting delay less than 480 ms from the beginning of time period T5.

The UE shall not send event 1H or 1I triggered measurement reports, as long as the reporting criteria are not fulfilled.

For the test to pass, the total number of successful tests shall be more than 90% with a confidence level of 95% of the cases.

### 8.6.1.3 Correct reporting of neighbours in fading propagation conditions

#### 8.6.1.3.1 3,84 Mcps TDD Option

##### 8.6.1.3.1.1 Definition and applicability

In the event triggered reporting, the measurement reporting delay is defined as the time between any event that will trigger a measurement report until the UE starts to transmit over the Uu interface. This requirement assumes that the measurement report is not delayed by other RRC signalling on the DCCH. This measurement reporting delay excludes a delay uncertainty resulted when inserting the measurement report to the TTI of the uplink DCCH. The delay uncertainty is twice the TTI of the uplink DCCH.

The requirements and this test apply to the TDD (3,84 Mcps option) UE.

##### 8.6.1.3.1.2 Minimum requirement

The requirements are the same as in sub clause 8.6.1.1.2

The normative reference for this requirement is TS 25.123 [2] clauses 8.1.2.2.2.1, 8.1.2.2.2 and A.8.1.3

##### 8.6.1.3.1.3 Test purpose

To verify that the UE meets the minimum requirements and also verify that the UE performs sufficient layer 1 filtering of the measurements. The test is performed in fading propagation conditions.

##### 8.6.1.3.1.4 Method of test

###### 8.6.1.3.1.4.1 Initial conditions

Test environment: normal; see clauses G.2.1 and G.2.2.

Frequencies to be tested: mid range; see clause G.2.4.

The test parameters are given in Tables 8.6.1.3.1 and 8.6.1.3.2. The test consists of one time period with time duration of T1. Two cells shall be present in the test, cell 1 being the current serving cell and cell 2 being a neighbour cell on the used frequency. Cell 1 and cell 2 shall be synchronised, i.e. share the same frame and timeslot timing.

In the measurement control information it is indicated to the UE that event-triggered reporting with Event 1G shall be used, and that P-CCPCH RSCP shall be reported together with Event 1G.

The DL DPCH shall be transmitted in timeslot 4 and the UL DPCH shall be transmitted in timeslot 12. The TTI of the UL DCCH shall be 20ms.



**Table 8.6.1.3.1: General test parameters for correct reporting of neighbours in fading propagation condition**

Parameter		Unit	Value	Comment
DCH parameters			DL Reference Measurement Channel 12.2 kbps	As specified in TS 25.102 section A.2.2
Power Control			On	
Target quality value on DTCH		BLER	0.01	
Initial conditions	Active cell		Cell 1	
	Neighbour cell		Cell 2	
Final condition	Active cell		Cell 1	
O		dB	0	Cell individual offset. This value shall be used for all cells in the test.
Hysteresis		dB	0	
Time to Trigger		ms	200	
Filter coefficient			0	
Monitored cell list size			6 TDD neighbours on Channel 1	Sent before the beginning of time period T1
T1		s	200	

**Table 8.6.1.3.2: Cell specific test parameters for correct reporting of neighbours in fading propagation condition**

Parameter	Unit	Cell 1		Cell 2	
		T1	T1	T1	T1
DL timeslot number		0	8	0	8
UTRA RF Channel Number		Channel 1		Channel 1	
PCCPCH_Ec/lor	dB	-3	n.a.	-3	n.a.
SCH_Ec/lor	dB	-9	-9	-9	-9
SCH_t <sub>offset</sub>		0	0	2	2
PICH_Ec/lor	dB	n.a.	-3	n.a.	-3
OCNS_Ec/lor	dB	-3,12	-3,12	-3,12	-3,12
$\hat{I}_{or}/I_{oc}$	dB	7	7	2	2
PCCPCH RSCP	dBm	-66	n.a.	-71	n.a.
$I_{oc}$	dBm/ 3,84 MHz	-70			
Propagation Condition		Case 4 as specified in Annex DTS25.102 Annex B			

#### 8.6.1.3.1.4.2 Procedure

- 1) The RF parameters are set up according to T1.
- 2) The UE is switched on.
- 3) A call is set up according to the generic set-up procedure specified in TS 34.108 [3] subclause 7.4.2 to place the UE in CELL\_DCH.
- 4) SS shall transmit a MEASUREMENT CONTROL message.
- 5) After 200 seconds from the beginning of T1, the UE is switched off.
- 6) Repeat steps 1-5 [TBD] times.

#### Specific Message Contents

All messages indicated above shall use the same content as described in the default message content in clause 9 of 34.108 [3] with the following exceptions:

MEASUREMENT CONTROL message (step 4):

Information Element/Group name	Value/Remark
Message Type (10.2.17)	
<b>UE information elements</b>	
-RRC transaction identifier	0
-Integrity check info	Not Present
<b>Measurement Information elements</b>	
-Measurement Identity	1
-Measurement Command (10.3.7.46)	Modify
-Measurement Reporting Mode (10.3.7.49)	AM RLC
-Periodical Reporting / Event Trigger Reporting Mode	Event trigger
-Additional measurements list (10.3.7.1)	Not Present
-CHOICE <i>Measurement type</i>	Intra-frequency measurement
-Intra-frequency measurement (10.3.7.36)	
-Intra-frequency measurement objects list (10.3.7.33)	Not Present
-Intra-frequency measurement quantity (10.3.7.38)	
-Filter coefficient (10.3.7.9)	0
-CHOICE <i>mode</i>	TDD
-Measurement quantity list	1
-Measurement quantity	Primary CCPCH
-Intra-frequency reporting quantity (10.3.7.41)	
-Reporting quantities for active set cells (10.3.7.5)	No report
-SFN-SFN observed time difference reporting indicator	FALSE
-Cell synchronisation information reporting indicator	FALSE
-Cell Identity reporting indicator	TDD
-CHOICE <i>mode</i>	FALSE
-Timeslot ISCP reporting indicator	TRUE
-Primary CCPCH RSCP reporting indicator	FALSE
-Pathloss reporting indicator	FALSE
-Reporting quantities for monitored set cells (10.3.7.5)	No report
-SFN-SFN observed time difference reporting indicator	FALSE
-Cell synchronisation information reporting indicator	FALSE
-Cell Identity reporting indicator	TDD
-CHOICE <i>mode</i>	FALSE
-Timeslot ISCP reporting indicator	FALSE
-Proposed TGSN reporting required	FALSE
-Primary CCPCH RSCP reporting indicator	TRUE
-Pathloss reporting indicator	FALSE
-Reporting quantities for detected set cells (10.3.7.5)	Not Present
-Reporting cell status (10.3.7.61)	
-CHOICE <i>reported cell</i>	Report all active set cells + cells within monitored set on used frequency
-Maximum number of reported cells	1
-Measurement validity (10.3.7.51)	Not Present
-CHOICE <i>report criteria</i>	Intra-frequency measurement reporting criteria
-Intra-frequency measurement reporting criteria (10.3.7.39)	
-Parameters required for each event	1
-Intra-frequency event identity	Event 1G
-Triggering condition 2	Not Present
-Reporting Range Constant	Not Present
-Cells forbidden to affect Reporting Range	Not Present
-W	Not Present
-Hysteresis	0 dB
-Threshold used frequency	Not Present
-Reporting deactivation threshold	Not Present
-Replacement activation threshold	Not Present
-Time to trigger	0 ms
-Amount of reporting	Infinity
-Reporting interval	0 ms (Note 1)
-Reporting cell status	Not Present
<b>Physical channel information elements</b>	
-DPCH compressed mode status info (10.3.6.34)	Not Present
Note 1: Reporting interval = 0 ms means no periodical reporting	

#### 8.6.1.3.1.5 Test requirements

The number of Event 1G triggered measurement reports during time period T1 shall be less than 60.

For the test to pass, the total number of successful tests shall be more than 90% with a confidence level of [FFS]% of the cases.

#### 8.6.1.3.2 1,28 Mcps TDD Option

Void.

#### 8.6.1.3.3 7,68 Mcps TDD Option

##### 8.6.1.3.3.1 Definition and applicability

In the event triggered reporting, the measurement reporting delay is defined as the time between any event that will trigger a measurement report until the UE starts to transmit over the Uu interface. This requirement assumes that the measurement report is not delayed by other RRC signalling on the DCCH. This measurement reporting delay excludes a delay uncertainty resulted when inserting the measurement report to the TTI of the uplink DCCH. The delay uncertainty is twice the TTI of the uplink DCCH.

The requirements and this test apply to the TDD (7,68 Mcps option) UE.

##### 8.6.1.3.3.2 Minimum requirement

The requirements are the same as in sub clause 8.6.1.1.2

The normative reference for this requirement is TS 25.123 [2] clauses , 8.1B.2.2.2 and A.8.1.3.3

##### 8.6.1.3.3.3 Test purpose

To verify that the UE meets the minimum requirements and also verify that the UE performs sufficient layer 1 filtering of the measurements. The test is performed in fading propagation conditions.

##### 8.6.1.3.3.4 Method of test

###### 8.6.1.3.3.4.1 Initial conditions

Test environment: normal; see clauses G.2.1 and G.2.2.

Frequencies to be tested: mid range; see clause G.2.4.

The test parameters are given in Tables 8.6.1.3.3.4.1.1 and 8.6.1.3.3.4.1.2. The test consists of one time period with time duration of T1. Two cells shall be present in the test, cell 1 being the current serving cell and cell 2 being a neighbour cell on the used frequency. Cell 1 and cell 2 shall be synchronised, i.e. share the same frame and timeslot timing.

In the measurement control information it is indicated to the UE that event-triggered reporting with Event 1G shall be used, and that P-CCPCH RSCP shall be reported together with Event 1G.

The DL DPCH shall be transmitted in timeslot 4 and the UL DPCH shall be transmitted in timeslot 12. The TTI of the UL DCCH shall be 20ms.

**Table 8.6.1.3.3.4.1.1: General test parameters for correct reporting of neighbours in fading propagation condition**

Parameter		Unit	Value	Comment
DCH parameters			DL Reference Measurement Channel 12.2 kbps	As specified in TS 25.102 section A.2.2
Power Control			On	
Target quality value on DTCH		BLER	0.01	
Initial conditions	Active cell		Cell 1	
	Neighbour cell		Cell 2	
Final condition	Active cell		Cell 1	
O		dB	0	Cell individual offset. This value shall be used for all cells in the test.
Hysteresis		dB	0	
Time to Trigger		ms	200	
Filter coefficient			0	
Monitored cell list size			6 TDD neighbours on Channel 1	Sent before the beginning of time period T1
T1		s	200	

**Table 8.6.1.3.3.4.1.2: Cell specific test parameters for correct reporting of neighbours in fading propagation condition**

Parameter	Unit	Cell 1		Cell 2	
		T1	T1	T1	T1
<b>DL timeslot number</b>		<b>0</b>	<b>8</b>	<b>0</b>	<b>8</b>
UTRA RF Channel Number		Channel 1		Channel 1	
PCCPCH_Ec/lor	dB	-3	n.a.	-3	n.a.
SCH_Ec/lor	dB	-9	-9	-9	-9
SCH_t_offset		0	0	2	2
PICH_Ec/lor	dB	n.a.	-3	n.a.	-3
OCNS_Ec/lor	dB	-3,12	-3,12	-3,12	-3,12
$\hat{I}_{or}/I_{oc}$	dB	7	7	2	2
PCCPCH RSCP	dBm	-66	n.a.	-71	n.a.
$I_{oc}$	dBm/ 7,68 MHz	-70			
Propagation Condition		Case 4 as specified in TS25.102 Annex B			

**8.6.1.3.3.4.2 Procedure**

- 1) The RF parameters are set up according to T1.
- 2) The UE is switched on.
- 3) A call is set up according to the generic set-up procedure specified in TS 34.108 [3] subclause 7.4.2 to place the UE in CELL\_DCH.
- 4) SS shall transmit a MEASUREMENT CONTROL message.
- 5) After 200 seconds from the beginning of T1, the UE is switched off.
- 6) Repeat steps 1-5 until the confidence level according to annex F.6.2 is achieved..

**Specific Message Contents**

All messages indicated above shall use the same content as described in the default message content in clause 9 of 34.108 [3] with the following exceptions:

MEASUREMENT CONTROL message (step 4):

Information Element/Group name	Value/Remark
Message Type (10.2.17)	
<b>UE information elements</b>	
-RRC transaction identifier	0
-Integrity check info	Not Present
<b>Measurement Information elements</b>	
-Measurement Identity	1
-Measurement Command (10.3.7.46)	Modify
-Measurement Reporting Mode (10.3.7.49)	AM RLC
-Periodical Reporting / Event Trigger Reporting Mode	Event trigger
-Additional measurements list (10.3.7.1)	Not Present
-CHOICE <i>Measurement type</i>	Intra-frequency measurement
-Intra-frequency measurement (10.3.7.36)	
-Intra-frequency measurement objects list (10.3.7.33)	Not Present
-Intra-frequency measurement quantity (10.3.7.38)	
-Filter coefficient (10.3.7.9)	0
-CHOICE <i>mode</i>	TDD
-Measurement quantity list	1
-Measurement quantity	Primary CCPCH
-Intra-frequency reporting quantity (10.3.7.41)	
-Reporting quantities for active set cells (10.3.7.5)	No report
-SFN-SFN observed time difference reporting indicator	FALSE
-Cell synchronisation information reporting indicator	FALSE
-Cell Identity reporting indicator	TDD
-CHOICE <i>mode</i>	FALSE
-Timeslot ISCP reporting indicator	TRUE
-Primary CCPCH RSCP reporting indicator	FALSE
-Pathloss reporting indicator	FALSE
-Reporting quantities for monitored set cells (10.3.7.5)	No report
-SFN-SFN observed time difference reporting indicator	FALSE
-Cell synchronisation information reporting indicator	FALSE
-Cell Identity reporting indicator	TDD
-CHOICE <i>mode</i>	FALSE
-Timeslot ISCP reporting indicator	FALSE
-Proposed TGSN reporting required	FALSE
-Primary CCPCH RSCP reporting indicator	TRUE
-Pathloss reporting indicator	FALSE
-Reporting quantities for detected set cells (10.3.7.5)	Not Present
-Reporting cell status (10.3.7.61)	
-CHOICE <i>reported cell</i>	Report all active set cells + cells within monitored set on used frequency
-Maximum number of reported cells	1
-Measurement validity (10.3.7.51)	Not Present
-CHOICE <i>report criteria</i>	Intra-frequency measurement reporting criteria
-Intra-frequency measurement reporting criteria (10.3.7.39)	
-Parameters required for each event	1
-Intra-frequency event identity	Event 1G
-Triggering condition 2	Not Present
-Reporting Range Constant	Not Present
-Cells forbidden to affect Reporting Range	Not Present
-W	Not Present
-Hysteresis	0 dB
-Threshold used frequency	Not Present
-Reporting deactivation threshold	Not Present
-Replacement activation threshold	Not Present
-Time to trigger	0 ms
-Amount of reporting	Infinity
-Reporting interval	0 ms (Note 1)
-Reporting cell status	Not Present
<b>Physical channel information elements</b>	
-DPCH compressed mode status info (10.3.6.34)	Not Present
Note 1: Reporting interval = 0 ms means no periodical reporting	

### 8.6.1.3.3.5 Test requirements

The number of Event 1G triggered measurement reports during time period T1 shall be less than 60.

For the test to pass, the total number of successful tests shall be more than 90% with a confidence level of 95% of the cases.

## 8.6.2 TDD inter frequency measurements

### 8.6.2.1 Correct reporting of neighbours in AWGN propagation condition

#### 8.6.2.1.1 Definition and applicability

##### 8.6.2.1.1.1 3,84 Mcps TDD Option

In the event triggered reporting period the measurement reporting delay is defined as the time between any event that will trigger a measurement report until the UE starts to transmit over the Uu interface. This requirement assumes that the measurement report is not delayed by other RRC signalling on the DCCH. This measurement reporting delay excludes a delay uncertainty resulted when inserting the measurement report to the TTI of the uplink DCCH. The delay uncertainty is twice the TTI of the uplink DCCH.

The requirements and this test apply to the TDD (3,84 Mcps option) UE.

##### 8.6.2.1.1.2 1,28 Mcps TDD Option

The purpose of this test is to verify that the UE makes correct reporting of an event within the required times when doing inter frequency measurements on a neighbouring TDD cell. The test will partly verify the requirements in section 8.1A.2 and 9.1. of [2]. The requirements and this test apply to the TDD (1.28 Mcps option) UE.

##### 8.6.2.1.1.3 7,68 Mcps TDD Option

In the event triggered reporting period the measurement reporting delay is defined as the time between any event that will trigger a measurement report until the UE starts to transmit over the Uu interface. This requirement assumes that the measurement report is not delayed by other RRC signalling on the DCCH. This measurement reporting delay excludes a delay uncertainty resulted when inserting the measurement report to the TTI of the uplink DCCH. The delay uncertainty is twice the TTI of the uplink DCCH.

The requirements and this test apply to the TDD (7,68 Mcps option) UE.

#### 8.6.2.1.2 Minimum requirement

##### 8.6.2.1.2.1 3,84 Mcps TDD Option

When idle intervals are used for inter-frequency TDD measurements, the UE shall be able to identify a new detectable inter-frequency TDD cell belonging to the monitored set within

$$T_{\text{identify inter}} = \text{Max} \left\{ 5000, N_{\text{basic identify TDD inter}} \cdot \frac{T_{\text{measurement period TDD inter}}}{N_{\text{TDD inter}}} \cdot N_{\text{Freq}} \right\} \text{ms}$$

If the UE does not require idle intervals to perform inter-frequency TDD measurements, the UE shall be able to identify a new detectable inter-frequency TDD cell belonging to the monitored set within 5000 ms.

When idle intervals are used for TDD inter frequency measurements, the UE shall be capable of performing P-CCPCH RSCP measurements for  $X_{\text{measurement TDD inter}}$  inter-frequency TDD cells per TDD frequency of the monitored set.

The UE physical layer shall be capable of reporting measurements to higher layers with measurement accuracy as specified in section 9 and with a measurement period of  $T_{\text{measurement inter}}$ .

$$T_{\text{measurement inter}} = \text{Max} \left\{ T_{\text{measurement period TDD inter}}, N_{\text{basic measurement TDD inter}} \cdot \frac{T_{\text{measurement period TDD inter}}}{N_{\text{TDD inter}}} \cdot N_{\text{Freq}} \right\} \text{ms}$$

If the UE does not require idle intervals to perform TDD inter-frequency measurements, the measurement period for inter frequency P-CCPCH RSCP measurements shall be 480 ms.

Where,

$$X_{\text{measurement\_TDD\_inter}} = 6 \text{ (cells)}$$

$T_{\text{measurement\_period\_inter}} = 480$  ms. The time period used for calculating the measurement period  $T_{\text{measurement\_inter}}$  for inter frequency P-CCPCH RSCP measurements.

$N_{\text{TDD\_inter}}$ : This is the available number of measurement opportunities for a Beacon timeslot of an inter-frequency TDD cell during the time period  $T_{\text{TDD\_inter}}$ . The UE shall consider that a measurement opportunity on a Beacon timeslot of an inter-frequency TDD cell is provided if an idle interval of length equal to or greater than 3 timeslots less  $2 \cdot 0.5$  ms implementation margin for frequency switching per idle interval completely overlaps in time with the Beacon timeslot of the inter-frequency TDD cell.

$N_{\text{basic\_identify\_TDD\_inter}} = 80$ . This is a number of measurement opportunities for a Beacon timeslot of an inter-frequency TDD cell during the time period used in the inter frequency TDD equation where the maximum allowed time for the UE to identify a new detectable inter-frequency TDD cell is defined.

$N_{\text{basic\_measurement\_TDD\_inter}} = 5$ . This is a number of measurement opportunities for a Beacon timeslot of an inter-frequency TDD cell during the time period  $T_{\text{TDD\_inter}}$  used in the inter-frequency TDD equation where the measurement period for inter-frequency P-CCPCH RSCP measurements is defined.

$N_{\text{Freq\_TDD}}$ : This is the number of TDD frequencies indicated in the inter frequency measurement control information.

The event triggered measurement reporting delay, measured without L3 filtering shall be less than  $T_{\text{identify\_inter}}$  defined in 25.123 [2]. When L3 filtering is used, an additional delay can be expected.

The normative reference for this requirement is TS 25.123 [2] clauses 8.1.2.3.1, 8.1.2.3.2 and A.8.2.1

#### 8.6.2.1.2.2 1,28 Mcps TDD Option

When idle intervals are used for inter-frequency TDD measurements, the UE shall be able to identify a new detectable cell belonging to the monitored set within

$$T_{\text{identify\_inter}} = \text{Max} \left\{ 5000, N_{\text{basic\_identify\_TDD\_inter}} \cdot \frac{T_{\text{Measurement\_Period\_Inter}}}{N_{\text{Inter}}} \cdot N_{\text{Freq}} \right\} \text{ms}$$

when

$N_{\text{Inter}}$ : This is the minimum number of sub-frame in that the signal of P-CCPCH and DwPCH can be received for inter frequency target cell during the period  $T_{\text{Measurement\_Period\_inter}}$  with an arbitrarily chosen timing. It depends on the channel allocation and is calculated by assuming  $2 \cdot 0.1$ ms for implementation margin (for the description of the idle intervals see Annex A of 25.225).

$T_{\text{basic\_identify\_TDD\_inter}} = 800$ ms. This is the time period used in the inter frequency equation where the maximum allowed time for the UE to identify a new TDD cell is defined.

$T_{\text{Measurement\_Period\_Inter}} = 480$  ms. The period used for calculating the measurement period  $T_{\text{measurement\_inter}}$  for inter frequency P-CCPCH RSCP measurements.

$N_{\text{Freq}}$ : Number of TDD frequencies indicated in the inter frequency measurement control information.

If the UE does not require idle intervals to perform inter-frequency TDD measurements, the UE shall be able to identify a new detectable inter-frequency TDD cell belonging to the monitored set within 5000 ms.

A cell shall be considered detectable when P-CCPCH  $E_c/I_0 \geq -8$  dB and DwPCH  $E_c/I_0 \geq -5$  dB. When L3 filtering is used an additional delay can be expected.

The test consist of 2 successive time periods, with a time duration T1 and T2. The test parameters are given in tables A.8.2C and A.8.2D below. Two cells shall be present in the test, cell 1 being the active cell and cell 2 being a 1.28Mcps TDD option neighbour cell on the unused frequency.

In the measurement control information it is indicated to the UE that event-triggered reporting with Event 2C shall be used. P-CCPCH RSCP of the best cell on the unused frequency shall be reported together with Event 2C reporting. The measurement control message shall be sent to the UE such that the delay between the end of the last received TTI containing the message and the beginning of T1 is at least equal to the RRC procedure delay as defined in 25.331 [9]

### 8.6.2.1.2.3 7,68 Mcps TDD Option

When idle intervals are used for inter-frequency TDD measurements, the UE shall be able to identify a new detectable inter-frequency TDD cell belonging to the monitored set within

$$T_{\text{identify\_inter}} = \text{Max} \left\{ 5000, N_{\text{basic\_identify\_TDD\_inter}} \cdot \frac{T_{\text{measurement\_period\_TDD\_inter}}}{N_{\text{TDD\_inter}}} \cdot N_{\text{Freq}} \right\} \text{ms}$$

If the UE does not require idle intervals to perform inter-frequency TDD measurements, the UE shall be able to identify a new detectable inter-frequency TDD cell belonging to the monitored set within 5000 ms.

When idle intervals are used for TDD inter frequency measurements, the UE shall be capable of performing P-CCPCH RSCP measurements for  $X_{\text{measurement\_TDD\_inter}}$  inter-frequency TDD cells per TDD frequency of the monitored set.

The UE physical layer shall be capable of reporting measurements to higher layers with measurement accuracy as specified in section 9 and with a measurement period of  $T_{\text{measurement\_inter}}$ .

$$T_{\text{measurement\_inter}} = \text{Max} \left\{ T_{\text{measurement\_period\_TDD\_inter}}, N_{\text{basic\_measurement\_TDD\_inter}} \cdot \frac{T_{\text{measurement\_period\_TDD\_inter}}}{N_{\text{TDD\_inter}}} \cdot N_{\text{Freq}} \right\} \text{ms}$$

If the UE does not require idle intervals to perform TDD inter-frequency measurements, the measurement period for inter frequency P-CCPCH RSCP measurements shall be 480 ms.

Where,

$$X_{\text{measurement\_TDD\_inter}} = 6 \text{ (cells)}$$

$T_{\text{measurement\_period\_inter}} = 480$  ms. The time period used for calculating the measurement period  $T_{\text{measurement\_inter}}$  for inter frequency P-CCPCH RSCP measurements.

$N_{\text{TDD\_inter}}$ : This is the available number of measurement opportunities for a Beacon timeslot of an inter-frequency TDD cell during the time period  $T_{\text{TDD\_inter}}$ . The UE shall consider that a measurement opportunity on a Beacon timeslot of an inter-frequency TDD cell is provided if an idle interval of length equal to or greater than 3 timeslots less  $2 \cdot 0.5$  ms implementation margin for frequency switching per idle interval completely overlaps in time with the Beacon timeslot of the inter-frequency TDD cell.

$N_{\text{basic\_identify\_TDD\_inter}} = 80$ . This is a number of measurement opportunities for a Beacon timeslot of an inter-frequency TDD cell during the time period used in the inter frequency TDD equation where the maximum allowed time for the UE to identify a new detectable inter-frequency TDD cell is defined.

$N_{\text{basic\_measurement\_TDD\_inter}} = 5$ . This is a number of measurement opportunities for a Beacon timeslot of an inter-frequency TDD cell during the time period  $T_{\text{TDD\_inter}}$  used in the inter-frequency TDD equation where the measurement period for inter-frequency P-CCPCH RSCP measurements is defined.

$N_{\text{Freq\_TDD}}$ : This is the number of TDD frequencies indicated in the inter frequency measurement control information.

The event triggered measurement reporting delay, measured without L3 filtering shall be less than  $T_{\text{identify\_inter}}$  defined in 25.123 [2]. When L3 filtering is used, an additional delay can be expected.

The normative reference for this requirement is TS 25.123 [2] clauses 8.1B.2.3.1, 8.1B.2.3.2 and A.8.2.1

### 8.6.2.1.3 Test purpose

#### 8.6.2.1.3.1 3,84 Mcps TDD Option

To verify that the UE meets the minimum requirement.

#### 8.6.2.1.3.2 1,28 Mcps TDD Option

To verify that the UE meets the minimum time requirements for identifying neighbouring TDD cells

#### 8.6.2.1.3.3 7,68 Mcps TDD Option

To verify that the UE meets the minimum time requirements for identifying neighbouring interfrequency TDD cells.



## 8.6.2.1.4 Method of test

## 8.6.2.1.4.1 3,84 Mcps TDD Option

## 8.6.2.1.4.1.1 Initial conditions

Test environment: normal; see clauses G.2.1 and G.2.2.

Frequencies to be tested: mid range; see clause G.2.4.

The test parameters are given in Table 8.6.2.1.1 and 8.6.2.1.2. The test consists of 2 successive time periods, with a time duration T1 and T2. Two cells shall be present in the test, cell 1 being the serving cell and cell 2 being a UTRA TDD neighbour cell on the unused frequency. All cells shall be synchronised, i.e. share the same frame and timeslot timing.

In the measurement control information it is indicated to the UE that event-triggered reporting with Event 2C shall be used. P-CCPCH RSCP of the best cell on the unused frequency shall be reported together with Event 2C reporting. The Measurement control message shall be sent to the UE such that the delay between the end of the last received TTI containing the message and the beginning of T1 is at least equal to the RRC procedure delay as defined in [9].

The second Beacon timeslot shall be provided in timeslot 8 for both cell 1 and cell 2. The DL DPCH shall be transmitted in timeslot 1 and the UL DPCH shall be transmitted in timeslot 3. The TTI of the uplink DCCH shall be 20 ms.

**Table 8.6.2.1.1: General test parameters for Correct reporting of TDD inter-frequency neighbours in AWGN propagation condition (3,84 Mcps option)**

Parameter	Unit	Value	Comment
DPCH parameters		DL Reference Measurement Channel 12.2 kbps	As specified in Annex CTS 25.102 annex A.2.2
Power Control		On	
Target quality value on DTCH	BLER	0.01	
Initial conditions	Active cell	Cell 1	UTRA TDD cell
	Neighbour cell	Cell 2	UTRA TDD cell
Threshold non used frequency	dB	-71	Applicable for event 2C
Hysteresis	dB	0	Applicable for event 2C
Time to Trigger	ms	0	
Filter coefficient		0	
Monitored cell list size		24 on channel 1 16 on channel 2	
T1	s	10	
T2	s	10	

**Table 8.6.2.1.2: Cell specific parameters for Correct reporting of TDD inter-frequency neighbours in AWGN propagation condition (3,84 Mcps option)**

Parameter	Unit	Cell 1				Cell 2			
		0		8		0		8	
Timeslot Number		T1	T2	T1	T2	T1	T2	T1	T2
UTRA RF Channel Number		Channel 1				Channel 2			
PCCPCH_Ec/I <sub>or</sub>	dB	-3	-3			-3	-3		
SCH_Ec/I <sub>or</sub>	dB	-9	-9	-9	-9	-9	-9	-9	-9
SCH_t <sub>offset</sub>		0	0	0	0	15	15	15	15
PICH_Ec/I <sub>or</sub>				-3	-3			-3	-3
OCNS		-4,28	-4,28	-4,28	-4,28	-4,28	-4,28	-4,28	-4,28
$\hat{I}_{or}/I_{oc}$	dB	3	3	3	3	-Infinity	9	-Infinity	9
$I_{oc}$	dBm/3,84 MHz	-70							
PCCPCH_RSCP	dB	-70	-70			-Infinity	-64		
Propagation Condition		AWGN							

**8.6.2.1.4.1.2 Procedure**

- 1) The RF parameters are set up according to T1.
- 2) The UE is switched on.
- 3) A call is set up according to the generic set-up procedure specified in TS 34.108 [3] subclause 7.4.2 to place the UE in CELL\_DCH.
- 4) SS shall transmit a MEASUREMENT CONTROL message.
- 5) After 10 seconds from the beginning of T1, the SS shall switch the power settings from T1 to T2.
- 6) UE shall transmit a MEASUREMENT REPORT message triggered by event 2c for cell 2. The measurement reporting delay from the beginning of T2 shall be less than 5080 ms. If the UE fails to report the event within the required delay, then a failure is recorded. If the reporting delay for this event is within the required limit, the number of successful tests is increased by one.
- 7) After 10 seconds from the beginning of T3, the UE is switched off. Any timing information of cell 2 is deleted in the UE.
- 8) Repeat steps 1-7 [TBD] times.

**Specific Message Contents**

All messages indicated above shall use the same content as described in the default message content in clause 9 of 34.108 [3] with the following exceptions:

NOTE: Numbers in brackets after an item e.g. "Message Type (10.2.17)" in the IE description are references to clause numbers in TS 25.331 [9] describing that item in more detail. MEASUREMENT CONTROL message (step 4):

Information Element/Group name	Value/Remark
Message Type (10.2.17)	
<b>UE information elements</b>	
-RRC transaction identifier	0
-Integrity check info	Not Present
<b>Measurement Information elements</b>	
-Measurement Identity	1
-Measurement Command (10.3.7.46)	Modify
-Measurement Reporting Mode (10.3.7.49)	AM RLC
-Measurement Report Transfer Mode	Event trigger
-Periodical Reporting / Event Trigger Reporting Mode	Not Present
-Additional measurements list (10.3.7.1)	
-CHOICE <i>Measurement type</i>	Inter-frequency measurement
-Inter-frequency measurement (10.3.7.16)	
-Inter-frequency measurement objects list (10.3.7.13)	
-CHOICE <i>inter-frequency cell removal</i>	No inter-frequency cells removed
-New inter-frequency cells	1
-Inter-frequency cell id	1
-Frequency info (10.3.6.36)	
-CHOICE <i>mode</i>	TDD
-UARFCN(Nt)	Same frequency as channel 2
-Cell info (10.3.7.2)	
-Cell individual offset	Not Present
-Reference time difference to cell	Not Present
-Read SFN indicator	False
-CHOICE <i>mode</i>	TDD
-Primary CCPCH info (10.3.6.57)	
-CHOICE <i>mode</i>	TDD
-CHOICE TDD option	3,84 Mcps TDD
-CHOICE Sync case	2
-Timeslot	0
-cell parameters ID	Set to cell parameters ID of cell 2
-SCTD indicator	FALSE
-Primary CCPCH Tx power	Set to Primary CCPCH Tx power of cell 2 as described in Table 8.6.2.1.2
-Timeslot list	Not Present
-Cell selection and re-selection info	Not Present
-Cell for measurement	Not Present
-Inter-frequency measurement quantity (10.3.7.18)	
-CHOICE <i>reporting criteria</i>	Inter-frequency reporting criteria
-Filter coefficient (10.3.7.9)	0
-CHOICE <i>mode</i>	TDD
-Measurement quantity for frequency quality estimate	Primary CCPCH RSCP
-Inter-frequency reporting quantity (10.3.7.21)	
-UTRA carrier RSSI	
-Frequency quality estimate	
-Non frequency related cell reporting quantities (10.3.7.5)	
-SFN-SFN observed time difference reporting indicator	No report
-Cell synchronisation information reporting indicator	FALSE
-Cell identity reporting indicator	FALSE
-CHOICE <i>mode</i>	TDD
-Timeslot ISCP reporting indicator	FALSE
-Proposed TGSN Reporting required	FALSE
-Primary CCPCH RSCP reporting indicator	TRUE
-Pathloss reporting indicator	FALSE
-Reporting cell status (10.3.7.61)	Not Present
-Measurement validity (10.3.7.51)	Not Present
-CHOICE <i>report criteria</i>	Inter-frequency measurement reporting criteria
-Inter-frequency measurement reporting criteria (10.3.7.19)	
-Parameters required for each event	1
-Intra-frequency event identity	Event 2C
-Threshold used frequency	Not Present
-W Used frequency	Not Present
-Hysteresis	0 dB
-Time to trigger	0 ms
-Reporting Cell Status (10.3..61)	
-CHOICE reported cell	Report cells within active and/or monitored

Information Element/Group name	Value/Remark
-Maximum number of reported cells -Parameters required for each non-used frequenc - Threshold non-used frequency - W non-used frequency	set on used frequency or within virtual active and/or monitored set on non-used frequency 3 -71 1
<b>Physical channel information elements</b> -DPCH compressed mode status info (10.3.6.34)	Not Present

## MEASUREMENT REPORT message (step 6)

Information Element	Value/remark
Message Type (10.2.17)	
Integrity check info	Not Present
Measurement identity	1
Measured Results (10.3.7.44)	
-CHOICE Measurement	Inter-frequency Measured results list
-Inter-frequency measured results	1
-Frequency info	
-CHOICE mode	TDD
-UARFCN(Nt)	Same frequency as channel 2
-UTRA carrier RSSI	Not Present
-Inter-frequency cell measured results	1
-Cell measured results (10.3.7.3)	
-Cell identity	Not Present
-SFN-SFN observed time difference	Not Present
-Cell synchronisation info	Not Present
-CHOICE mode	TDD
-Cell parameters ID	Set to cell parameters ID of Cell 2
-Proposed TGSN	Not Present
-Primary CCPCH RSCP	Checked that this IE is present
-Pathloss	Not Present
-Timeslot list	Not Present
Measured results on RACH	Not Present
Additional measured results	Not Present
Event results (10.3.7.7)	
-CHOICE event result	Inter-frequency measurement event results
-Inter-frequency event identity	2C
-Inter-frequency cells	1
-Frequency Info	
-CHOICE mode	TDD
-UARFCN(Nt)	Same frequency as channel 2
-CHOICE mode	TDD
-Primary CCPCH Info	
-CHOICE mode	TDD
-CHOICE TDD Option	3,84 Mcps TDD
-CHOICE Sync Case	Not Present
-Cell Parameters ID	Set to cell parameters ID of Cell 2
-SCTD Indicator	FALSE

## 8.6.2.1.4.2 1,28 Mcps TDD Option

Test environment : normal; see clauses G.2.1 and G.2.2.

Frequencies to be tested : mid range ;see clauses G.2.4.

Cell 1 is the active cell, Cell 2 is a neighbour cell on the unused frequency. The power level on Cell 1 is kept constant and the power level of Cell 2 is changed using "change of best cell event". General test parameters are given in the table 8.6.2.1.3 below and they are signalled from test device. In the measurement control information it is indicated to the UE that event-triggered reporting with Event 2C shall be used. P-CCPCH RSCP of the best cell has to be reported together with Event 2C reporting. New measurement control information, which defines neighbour cells etc., is always sent before the event starts. The cell specific test parameters are shown in Table 8.6.2.1.4.

**Table 8.6.2.1.3: General test parameters for correct reporting of TDD inter frequency neighbours in AWGN propagation condition 1,28Mcps option**

Parameter	Unit	Value	Comment
DPCH parameters active cell		DL and UL Reference Measurement Channel 12.2 kbps	As specified in TS 25.102 section A.2.2. The DPCH is located in an other timeslot than 0
Power Control		On	
Target quality value on DTCH	BLER	0.01	
Initial conditions	Active cell	Cell 1	1.28Mcps TDD cell
	Neighbour cell	Cell 2	1.28Mcps TDD cell
Final conditions	Active cell	Cell 1	
Threshold non used frequency	dBm	-71	Absolute P-CCPCH RSCP threshold for event 2C
W non-used frequency		1	Applicable for event 2C
Hysteresis	dB	0	
Time to Trigger	ms	0	
Filter coefficient		0	
Monitored cell list size		24 on channel 1 16 on channel 2	Measurement control information is sent before T1 starts.
T1	s	10	
T2	s	10	

**Table 8.6.2.1.4 Cell Specific Parameters for Correct Reporting of Neighbours in AWGN Propagation Condition 1,28Mcps option**

Parameter	Unit	Cell 1				Cell 2			
		0		DwPTS		0		DwPTS	
Timeslot Number		T1	T2	T1	T2	T1	T2	T1	T2
UTRA RF Channel Number		Channel 1				Channel 2			
PCCPCH_Ec/Ior	dB	-3				-3			
DwPCH_Ec/Ior	dB			0				0	
OCNS_Ec/Ior	dB	-3				-3			
$\hat{I}_{or}/I_{oc}$	dB	3	3			-Infinity	8		
$I_{oc}$	dBm/1.28 MHz	-70							
PCCPCH_RSCP	dBm	-70	-70			-Infinity	-65		
Propagation Condition		AWGN							

NOTE: The DPCH of all cells are located in a timeslot other than 0.

#### 8.6.2.1.4.2.2 Test Procedure

- 1) The RF parameters are set up according to T1.
- 2) The UE is switched on.
- 3) A call is set up according to the generic set-up procedure specified in TS 34.108 [3] subclause 7.4.2 to place the UE in CELL\_DCH.
- 4) SS shall transmit a MEASUREMENT CONTROL message.
- 5) After 10 seconds from the beginning of T1, the SS shall switch the power settings from T1 to T2.
- 6) UE shall transmit a MEASUREMENT REPORT message triggered by event 2c for cell 2. The measurement reporting delay from the beginning of T2 shall be less than 5080 ms. If the UE fails to report the event within the required delay, then a failure is recorded. If the reporting delay for this event is within the required limit, the number of successful tests is increased by one.
- 7) After 10 seconds from the beginning of T2, the UE is switched off. Any timing information of cell 2 is deleted in the UE.

8) Repeat steps 1-7 until the confidence level according to annex F.6.2 is achieved.

#### Specific Message Contents

All messages indicated above shall use the same content as described in the default message content in clause 9 of 34.108 [3] and in Annex A of 34.123-1 [21], with the following exceptions:

Note: Numbers in brackets after an item e.g “Message Type (10.2.17)” in the IE description are references to clause numbers in TS 25.331 [9] describing that item in more detail.

MEASUREMENT CONTROL message (step 4):

Information Element/Group name	Value/Remark
Message Type (10.2.17)	
<b>UE information elements</b>	
-RRC transaction identifier	0
-Integrity check info	Not Present
<b>Measurement Information elements</b>	
-Measurement Identity	1
-Measurement Command (10.3.7.46)	Modify
-Measurement Reporting Mode (10.3.7.49)	AM RLC
-Periodical Reporting / Event Trigger Reporting Mode	Event trigger
-Additional measurements list (10.3.7.1)	Not Present
-CHOICE <i>Measurement type</i>	Inter-frequency measurement
-Inter-frequency measurement (10.3.7.16)	
-Inter-frequency measurement objects list (10.3.7.13)	
-CHOICE <i>inter-frequency cell removal</i>	No inter-frequency cells removed
-New inter-frequency cells	1
-Inter-frequency cell id	1
-Frequency info (10.3.6.36)	
-CHOICE <i>mode</i>	TDD
-UARFCN(Nt)	Same frequency as channel 2
-Cell info (10.3.7.2)	
-Cell individual offset	Not Present
-Reference time difference to cell	Not Present
-Read SFN indicator	False
-CHOICE <i>mode</i>	TDD
-Primary CCPCH info (10.3.6.57)	
-CHOICE <i>mode</i>	TDD
-CHOICE TDD option	1,28 Mcps TDD
-cell parameters ID	Set to cell parameters ID of cell 2
-SCTD indicator	FALSE
-Primary CCPCH Tx power	Set to Primary CCPCH Tx power of cell 2 as described in Table 8.6.2.1.2
-Timeslot list	Not Present
-Cell selection and re-selection info	Not Present
-Cell for measurement	Not Present
-Inter-frequency measurement quantity (10.3.7.18)	
-CHOICE <i>reporting criteria</i>	Inter-frequency reporting criteria
-Filter coefficient (10.3.7.9)	0
-CHOICE <i>mode</i>	TDD
-Measurement quantity for frequency quality estimate	Primary CCPCH RSCP
-Inter-frequency reporting quantity (10.3.7.21)	
-UTRA carrier RSSI	FALSE
-Frequency quality estimate	FALSE
-Non frequency related cell reporting quantities (10.3.7.5)	
-SFN-SFN observed time difference reporting indicator	No report
-Cell synchronisation information reporting indicator	FALSE
-Cell identity reporting indicator	FALSE
-CHOICE <i>mode</i>	TDD
-Timeslot ISCP reporting indicator	FALSE
-Proposed TGSN Reporting required	FALSE
-Primary CCPCH RSCP reporting indicator	TRUE
-Pathloss reporting indicator	FALSE
-Reporting cell status (10.3.7.61)	Not Present
-Measurement validity (10.3.7.51)	Not Present
-CHOICE <i>report criteria</i>	Inter-frequency measurement reporting criteria
-Inter-frequency measurement reporting criteria (10.3.7.19)	
-Parameters required for each event	1
-Intra-frequency event identity	Event 2C
-Threshold used frequency	Not Present
-W Used frequency	Not Present
-Hysteresis	0 dB
-Time to trigger	0 ms
-Reporting Cell Status (10.3.61)	
-CHOICE reported cell	Report cells within active and/or monitored

Information Element/Group name	Value/Remark
-Maximum number of reported cells -Parameters required for each non-used frequenc - Threshold non-used frequency - W non-used frequency	set on used frequency or within virtual active and/or monitored set on non-used frequency 3 -71 1
<b>Physical channel information elements</b> -DPCH compressed mode status info (10.3.6.34)	Not Present

## MEASUREMENT REPORT message (step 6)

Information Element	Value/remark
Message Type (10.2.17)	
Integrity check info	Not Present
Measurement identity	1
Measured Results (10.3.7.44)	
-CHOICE Measurement	Inter-frequency Measured results list
-Inter-frequency measured results	1
-Frequency info	
-CHOICE mode	TDD
-UARFCN(Nt)	Same frequency as channel 2
-UTRA carrier RSSI	Not Present
-Inter-frequency cell measured results	1
-Cell measured results (10.3.7.3)	
-Cell identity	Not Present
-SFN-SFN observed time difference	Not Present
-Cell synchronisation info	Not Present
-CHOICE mode	TDD
-Cell parameters ID	Set to cell parameters ID of Cell 2
-Proposed TGSN	Not Present
-Primary CCPCH RSCP	Checked that this IE is present
-Pathloss	Not Present
-Timeslot list	Not Present
Measured results on RACH	Not Present
Additional measured results	Not Present
Event results (10.3.7.7)	
-CHOICE event result	Inter-frequency measurement event results
-Inter-frequency event identity	2C
-Inter-frequency cells	1
-Frequency Info	
-CHOICE mode	TDD
-UARFCN(Nt)	Same frequency as channel 2
-Non frequency related measurement event results	
-CHOICE mode	TDD
-Primary CCPCH Info	
-CHOICE mode	TDD
-CHOICE TDD Option	1.28 Mcps TDD
-TSTD indicator	TRUE
-Cell Parameters ID	Set to cell parameters ID of Cell 2
-SCTD Indicator	FALSE

8.6.2.1.4.3 7,68 Mcps TDD Option

8.6.2.1.4.3.1 Initial conditions

Test environment: normal; see clauses G.2.1 and G.2.2.

Frequencies to be tested: mid range; see clause G.2.4.

The test parameters are given in Table 8.6.2.1.4.3.1.1 and 8.6.2.1.4.3.1.2. The test consists of 2 successive time periods, with a time duration T1 and T2. Two cells shall be present in the test, cell 1 being the serving cell and cell 2 being a UTRA TDD neighbour cell on the unused frequency. All cells shall be synchronised, i.e. share the same frame and timeslot timing.



In the measurement control information it is indicated to the UE that event-triggered reporting with Event 2C shall be used. P-CCPCH RSCP of the best cell on the unused frequency shall be reported together with Event 2C reporting. The Measurement control message shall be sent to the UE such that the delay between the end of the last received TTI containing the message and the beginning of T1 is at least equal to the RRC procedure delay as defined in [9].

The second Beacon timeslot shall be provided in timeslot 8 for both cell 1 and cell 2. The DL DPCH shall be transmitted in timeslot 1 and the UL DPCH shall be transmitted in timeslot 3. The TTI of the uplink DCCH shall be 20 ms.

**Table 8.6.2.1.4.3.1.1: General test parameters for Correct reporting of TDD inter-frequency neighbours in AWGN propagation condition (7,68 Mcps option)**

Parameter	Unit	Value	Comment
DPCH parameters		DL Reference Measurement Channel 12.2 kbps	As specified in TS 25.102 annex A.2.2
Power Control		On	
Target quality value on DTCH	BLER	0.01	
Initial conditions	Active cell	Cell 1	UTRA TDD cell
	Neighbour cell	Cell 2	UTRA TDD cell
Threshold non used frequency	dB	-71	Applicable for event 2C
Hysteresis	dB	0	Applicable for event 2C
Time to Trigger	ms	0	
Filter coefficient		0	
Monitored cell list size		24 on channel 1 16 on channel 2	
T1	s	10	
T2	s	10	

**Table 8.6.2.1.4.3.1.2: Cell specific parameters for Correct reporting of TDD inter-frequency neighbours in AWGN propagation condition (7,68 Mcps option)**

Parameter	Unit	Cell 1				Cell 2			
		0		8		0		8	
Timeslot Number		T1	T2	T1	T2	T1	T2	T1	T2
UTRA RF Channel Number		Channel 1				Channel 2			
PCCPCH_Ec/Ior	dB	-3	-3			-3	-3		
SCH_Ec/Ior	dB	-9	-9	-9	-9	-9	-9	-9	-9
SCH_toffset		0	0	0	0	15	15	15	15
PICH_Ec/Ior				-3	-3			-3	-3
OCNS		-4,28	-4,28	-4,28	-4,28	-4,28	-4,28	-4,28	-4,28
$\hat{I}_{or}/I_{oc}$	dB	3	3	3	3	-Infinity	9	-Infinity	9
$I_{oc}$	dBm/7.68 MHz	-70							
PCCPCH_RSCP	dB	-70	-70			-Infinity	-64		
Propagation Condition		AWGN							

#### 8.6.2.1.4.3.2 Procedure

- 1) The RF parameters are set up according to T1.
- 2) The UE is switched on.
- 3) A call is set up according to the generic set-up procedure specified in TS 34.108 [3] subclause 7.4.2 to place the UE in CELL\_DCH.
- 4) SS shall transmit a MEASUREMENT CONTROL message.
- 5) After 10 seconds from the beginning of T1, the SS shall switch the power settings from T1 to T2.
- 6) UE shall transmit a MEASUREMENT REPORT message triggered by event 2c for cell 2. The measurement reporting delay from the beginning of T2 shall be less than 5080 ms. If the UE fails to report the event within the

required delay, then a failure is recorded. If the reporting delay for this event is within the required limit, the number of successful tests is increased by one.

- 7) After 10 seconds from the beginning of T3, the UE is switched off. Any timing information of cell 2 is deleted in the UE.
- 8) Repeat steps 1-7 until the confidence level according to annex F.6.2 is achieved..

#### Specific Message Contents

All messages indicated above shall use the same content as described in the default message content in clause 9 of 34.108 [3] with the following exceptions:

Note: Numbers in brackets after an item e.g. "Message Type (10.2.17)" in the IE description are references to clause numbers in TS 25.331 [9] describing that item in more detail. MEASUREMENT CONTROL message (step 4):

Information Element/Group name	Value/Remark
Message Type (10.2.17)	
<b>UE information elements</b>	
-RRC transaction identifier	0
-Integrity check info	Not Present
<b>Measurement Information elements</b>	
-Measurement Identity	1
-Measurement Command (10.3.7.46)	Modify
-Measurement Reporting Mode (10.3.7.49)	AM RLC
-Measurement Report Transfer Mode	Event trigger
-Periodical Reporting / Event Trigger Reporting Mode	Not Present
-Additional measurements list (10.3.7.1)	
-CHOICE <i>Measurement type</i>	Inter-frequency measurement
-Inter-frequency measurement (10.3.7.16)	
-Inter-frequency measurement objects list (10.3.7.13)	
-CHOICE <i>inter-frequency cell removal</i>	No inter-frequency cells removed
-New inter-frequency cells	1
-Inter-frequency cell id	1
-Frequency info (10.3.6.36)	
-CHOICE <i>mode</i>	TDD
-UARFCN(Nt)	Same frequency as channel 2
-Cell info (10.3.7.2)	
-Cell individual offset	Not Present
-Reference time difference to cell	Not Present
-Read SFN indicator	False
-CHOICE <i>mode</i>	TDD
-Primary CCPCH info (10.3.6.57)	
-CHOICE <i>mode</i>	TDD
-CHOICE TDD option	7,68 Mcps TDD
-CHOICE Sync case	2
-Timeslot	0
-cell parameters ID	Set to cell parameters ID of cell 2
-SCTD indicator	FALSE
-Primary CCPCH Tx power	Set to Primary CCPCH Tx power of cell 2 as described in Table 8.6.2.1.2
-Timeslot list	Not Present
-Cell selection and re-selection info	Not Present
-Cell for measurement	Not Present
-Inter-frequency measurement quantity (10.3.7.18)	
-CHOICE <i>reporting criteria</i>	Inter-frequency reporting criteria
-Filter coefficient (10.3.7.9)	0
-CHOICE <i>mode</i>	TDD
-Measurement quantity for frequency quality estimate	Primary CCPCH RSCP
-Inter-frequency reporting quantity (10.3.7.21)	
-UTRA carrier RSSI	
-Frequency quality estimate	
-Non frequency related cell reporting quantities (10.3.7.5)	
-SFN-SFN observed time difference reporting indicator	No report
-Cell synchronisation information reporting indicator	FALSE
-Cell identity reporting indicator	FALSE
-CHOICE <i>mode</i>	TDD
-Timeslot ISCP reporting indicator	FALSE
-Proposed TGSN Reporting required	FALSE
-Primary CCPCH RSCP reporting indicator	TRUE
-Pathloss reporting indicator	FALSE
-Reporting cell status (10.3.7.61)	Not Present
-Measurement validity (10.3.7.51)	Not Present
-CHOICE <i>report criteria</i>	Inter-frequency measurement reporting criteria
-Inter-frequency measurement reporting criteria (10.3.7.19)	
-Parameters required for each event	1
-Intra-frequency event identity	Event 2C
-Threshold used frequency	Not Present
-W Used frequency	Not Present
-Hysteresis	0 dB
-Time to trigger	0 ms
-Reporting Cell Status (10.3..61)	
-CHOICE reported cell	Report cells within active and/or monitored

Information Element/Group name	Value/Remark
-Maximum number of reported cells -Parameters required for each non-used frequenc - Threshold non-used frequency - W non-used frequency	set on used frequency or within virtual active and/or monitored set on non-used frequency 3 -71 1
<b>Physical channel information elements</b> -DPCH compressed mode status info (10.3.6.34)	Not Present

## MEASUREMENT REPORT message (step 6)

Information Element	Value/remark
Message Type (10.2.17)	
Integrity check info	Not Present
Measurement identity	1
Measured Results (10.3.7.44)	
-CHOICE Measurement	Inter-frequency Measured results list
-Inter-frequency measured results	1
-Frequency info	
-CHOICE mode	TDD
-UARFCN(Nt)	Same frequency as channel 2
-UTRA carrier RSSI	Not Present
-Inter-frequency cell measured results	1
-Cell measured results (10.3.7.3)	
-Cell identity	Not Present
-SFN-SFN observed time difference	Not Present
-Cell synchronisation info	Not Present
-CHOICE mode	TDD
-Cell parameters ID	Set to cell parameters ID of Cell 2
-Proposed TGSN	Not Present
-Primary CCPCH RSCP	Checked that this IE is present
-Pathloss	Not Present
-Timeslot list	Not Present
Measured results on RACH	Not Present
Additional measured results	Not Present
Event results (10.3.7.7)	
-CHOICE event result	Inter-frequency measurement event results
-Inter-frequency event identity	2C
-Inter-frequency cells	1
-Frequency Info	
-CHOICE mode	TDD
-UARFCN(Nt)	Same frequency as channel 2
-CHOICE mode	TDD
-Primary CCPCH Info	
-CHOICE mode	TDD
-CHOICE TDD Option	7,68 Mcps TDD
-CHOICE Sync Case	Not Present
-Cell Parameters ID	Set to cell parameters ID of Cell 2
-SCTD Indicator	FALSE

## 8.6.2.1.5 Test requirements

## 8.6.2.1.5.1 3,84 Mcps TDD Option

The UE shall send one Event 2C triggered measurement report for Cell 2 with a measurement reporting delay less than 5080ms from the beginning of time period T2.

The UE shall not send event triggered measurement reports, as long as the reporting criteria are not fulfilled.

For the test to pass, the total number of successful tests shall be more than 90% with a confidence level of [FFS]% of the cases.

## 8.6.2.1.5.2 1,28 Mcps TDD Option

The UE shall send an EVENT 2C message of cell 2 within 5080ms from the beginning of the time T2

The UE shall not send any event triggered measurement reports, as long as the reporting criteria are not fulfilled.

For the test to pass, the total number of successful tests shall be more than 90% with a confidence level of 95% of the cases.

#### 8.6.2.1.5.3 7,68 Mcps TDD Option

The UE shall send one Event 2C triggered measurement report for Cell 2 with a measurement reporting delay less than 5080ms from the beginning of time period T2.

The UE shall not send event triggered measurement reports, as long as the reporting criteria are not fulfilled.

For the test to pass, the total number of successful tests shall be more than 90% with a confidence level of 95% of the cases.

### 8.6.3 FDD measurements

#### 8.6.3.1 Correct reporting of FDD neighbours in AWGN propagation condition

##### 8.6.3.1.1 Definition and applicability

###### 8.6.3.1.1.1 3,84 Mcps TDD Option

In the event triggered reporting period the measurement reporting delay is defined as the time between any event that will trigger a measurement report until the UE starts to transmit over the Uu interface. This requirement assumes that the measurement report is not delayed by other RRC signalling on the DCCH. This measurement reporting delay excludes a delay uncertainty resulted when inserting the measurement report to the TTI of the uplink DCCH. The delay uncertainty is twice the TTI of the uplink DCCH.

The requirements and this test apply to the combined FDD and TDD (3,84 Mcps option) UE.

###### 8.6.3.1.1.2 1,28 Mcps TDD Option

The purpose of this test is to verify that the UE makes correct reporting of an event when measuring on UTRA FDD cells. This test will partly verify the requirements in section 8.1A.2 and 9.1. of [2]

The test consists of two successive time periods, with a time duration T1 and T2. Two cells shall be present in the test, cell 1 being current active 1.28Mcps TDD cell and cell 2 being a UTRA FDD neighbouring cell.

In the measurement control information it is indicated to the UE that event-triggered reporting with Event 2C shall be used and the CPICH RSCP of the best cell on the unused frequency shall be reported together with Event 2C. The measurement control message shall be sent to the UE such that the delay between the end of the last received TTI containing the message and the beginning of T1 is at least equal to the RRC procedure delay as defined in 25.331 [9].

The requirements and this test apply to all types of 1.28 Mcps TDD UE.

###### 8.6.3.1.1.3 7,68 Mcps TDD Option

In the event triggered reporting period the measurement reporting delay is defined as the time between any event that will trigger a measurement report until the UE starts to transmit over the Uu interface. This requirement assumes that the measurement report is not delayed by other RRC signalling on the DCCH. This measurement reporting delay excludes a delay uncertainty resulted when inserting the measurement report to the TTI of the uplink DCCH. The delay uncertainty is twice the TTI of the uplink DCCH.

The requirements and this test apply to the combined FDD and TDD (7,68 Mcps option) UE.

##### 8.6.3.1.2 Minimum requirement

###### 8.6.3.1.2.1 3,84 Mcps TDD Option

When idle intervals are used for inter-frequency FDD measurements, the UE shall be able to identify a new detectable inter-frequency FDD cell belonging to the monitored set within

$$T_{\text{identify FDD inter}} = \text{Max} \left\{ 5000, T_{\text{basic identify FDD inter}} \cdot \frac{T_{\text{measurement period FDD inter}}}{T_{\text{FDD inter}}} \cdot N_{\text{Freq}} \right\} \text{ms}$$

If the UE does not require idle intervals to perform FDD inter-frequency measurements, the UE shall be able to identify a new detectable inter-frequency FDD cell belonging to the monitored set within 5000 ms.

When L3 filtering is used an additional delay can be expected.

An inter-frequency FDD cell shall be considered detectable, when CPICH Ec/Io  $\geq$  -20 dB, SCH\_Ec/Io  $\geq$  -17 dB and SCH\_Ec/Ior is equally divided between primary synchronisation code and secondary synchronisation code.

When idle intervals are used for FDD inter frequency measurements, the UE physical layer shall be capable of reporting measurements to higher layers with measurement period given by

$$T_{\text{measurement FDD inter}} = \text{Max} \left\{ T_{\text{measurement period FDD inter}}, T_{\text{basic measurement FDD inter}} \cdot \frac{T_{\text{measurement period FDD inter}}}{T_{\text{FDD inter available}}} \cdot N_{\text{Freq,FDD}} \right\} \text{ms}$$

If the UE does not require idle intervals to perform FDD inter-frequency measurements, the measurement period for inter frequency CPICH measurements shall be 480 ms.

The UE shall be capable of performing CPICH measurements for  $X_{\text{measurement FDD inter}}$  inter-frequency FDD cells per frequency of the monitored set and the UE physical layer shall be capable of reporting measurements to higher layers with the measurement period of  $T_{\text{measurement FDD inter}}$ .

$$X_{\text{basic measurement FDD inter}} = 6 \text{ (cells)}$$

$T_{\text{measurement period FDD inter}} = 480$  ms. The time period used for calculating the measurement period  $T_{\text{measurement FDD inter}}$  for inter frequency CPICH measurements.

$T_{\text{FDD inter available}}$ : This is the available time for measurements on inter-frequency FDD cells.  $T_{\text{FDD inter available}}$  shall be derived from  $T_{\text{FDD inter}}$  by assuming 2\*0.5 ms implementation margin for frequency switching per idle interval and by only taking into account the remaining number of full timeslots per idle interval. Idle intervals smaller than 3 timeslots shall not be taken into account for calculating  $T_{\text{FDD inter available}}$ .

$T_{\text{basic identify FDD inter}} = 800$  ms. This is the time period used in the inter frequency equation where the maximum allowed time for the UE to identify a new detectable inter-frequency FDD cell is defined.

$T_{\text{basic measurement FDD inter}} = 50$  ms. This is the time period used in the inter-frequency equation for defining the measurement period for inter frequency CPICH measurements.

$N_{\text{Freq}}$ : This is the number of FDD frequencies indicated in the inter frequency measurement control information.

The event triggered measurement reporting delay, measured without L3 filtering shall be less than  $T_{\text{identify inter}}$  defined in 25.123 [2]. When L3 filtering is used, an additional delay can be expected.

The normative reference for this requirement is TS 25.123 [2] clauses 8.1.2.4 and A.8.3.1

#### 8.6.3.1.2.2 1,28 Mcps TDD Option

The UE shall send the Event 2C triggered measurement report, with a measurement reporting delay less than 5.08 s from the beginning of time period T2.

#### 8.6.3.1.2.3 7,68 Mcps TDD Option

When idle intervals are used for inter-frequency FDD measurements, the UE shall be able to identify a new detectable inter-frequency FDD cell belonging to the monitored set within

$$T_{\text{identify FDD inter}} = \text{Max} \left\{ 5000, T_{\text{basic identify FDD inter}} \cdot \frac{T_{\text{measurement period FDD inter}}}{T_{\text{FDD inter}}} \cdot N_{\text{Freq}} \right\} \text{ms}$$

If the UE does not require idle intervals to perform FDD inter-frequency measurements, the UE shall be able to identify a new detectable inter-frequency FDD cell belonging to the monitored set within 5000 ms.

When L3 filtering is used an additional delay can be expected.

An inter-frequency FDD cell shall be considered detectable, when CPICH Ec/Io  $\geq$  -20 dB, SCH\_Ec/Io  $\geq$  -17 dB and SCH\_Ec/Ior is equally divided between primary synchronisation code and secondary synchronisation code.

When idle intervals are used for FDD inter frequency measurements, the UE physical layer shall be capable of reporting measurements to higher layers with measurement period given by

$$T_{\text{measurement FDD inter}} = \text{Max} \left\{ T_{\text{measurement period FDD inter}}, T_{\text{basic measurement FDD inter}} \cdot \frac{T_{\text{measurement period FDD inter}}}{T_{\text{FDD inter available}}} \cdot N_{\text{Freq,FDD}} \right\} \text{ms}$$

If the UE does not require idle intervals to perform FDD inter-frequency measurements, the measurement period for inter frequency CPICH measurements shall be 480 ms.

The UE shall be capable of performing CPICH measurements for  $X_{\text{measurement FDD inter}}$  inter-frequency FDD cells per frequency of the monitored set and the UE physical layer shall be capable of reporting measurements to higher layers with the measurement period of  $T_{\text{measurement FDD inter}}$ .

$$X_{\text{basic measurement FDD inter}} = 6 \text{ (cells)}$$

$T_{\text{measurement\_period FDD inter}} = 480$  ms. The time period used for calculating the measurement period  $T_{\text{measurement\_FDD inter}}$  for inter frequency CPICH measurements.

$T_{\text{FDD inter: available}}$ : This is the available time for measurements on inter-frequency FDD cells.  $T_{\text{FDD inter available}}$  shall be derived from  $T_{\text{FDD inter}}$  by assuming  $2 \cdot 0.5$  ms implementation margin for frequency switching per idle interval and by only taking into account the remaining number of full timeslots per idle interval. Idle intervals smaller than 3 timeslots shall not be taken into account for calculating  $T_{\text{FDD inter available}}$ .

$T_{\text{basic\_identify\_FDD inter}} = 800$  ms. This is the time period used in the inter frequency equation where the maximum allowed time for the UE to identify a new detectable inter-frequency FDD cell is defined.

$T_{\text{basic\_measurement\_FDD inter}} = 50$  ms. This is the time period used in the inter-frequency equation for defining the measurement period for inter frequency CPICH measurements.

$N_{\text{Freq}}$ : This is the number of FDD frequencies indicated in the inter frequency measurement control information.

The event triggered measurement reporting delay, measured without L3 filtering shall be less than  $T_{\text{identify inter}}$  defined in 25.123 [2]. When L3 filtering is used, an additional delay can be expected.

The normative reference for this requirement is TS 25.123 [2] clauses 8.1B.2.4 and A.8.3.1

### 8.6.3.1.3 Test purpose

#### 8.6.3.1.3.1 3,84 Mcps TDD Option

To verify that the UE meets the minimum requirement.

#### 8.6.3.1.3.2 1,28 Mcps TDD Option

To verify that the UE meets the minimum time requirements for identifying neighbouring FDD cells.

#### 8.6.3.1.3.3 7,68 Mcps TDD Option

To verify that the UE meets the minimum time requirements for identifying neighbouring FDD cells.

### 8.6.3.1.4 Method of test

#### 8.6.3.1.4.1 3,84 Mcps TDD Option

##### 8.6.3.1.4.1.1 Initial conditions

Test environment: normal; see clauses G.2.1 and G.2.2.

Frequencies to be tested: mid range; see clause G.2.4.

The test parameters are given in Table 8.6.3.1.1 and 8.6.3.1.2. The test consists of two successive time periods, with time durations of T1 and T2 respectively. Two cells shall be present in the test, cell 1 being the serving UTRA TDD cell and cell 2 being a UTRA FDD neighbour cells on the unused frequency.

In the measurement control information it is indicated to the UE that event-triggered reporting with Event 2C shall be used and that CPICH Ec/I0 of the best cell on the unused frequency shall be reported together with Event 2C. The

Measurement control message shall be sent to the UE such that the delay between the end of the last received TTI containing the message and the beginning of T1 is at least equal to the RRC procedure delay as defined in [9].

The second Beacon timeslot shall be provided in timeslot 8 for cell 1. The DL DPCH shall be transmitted in timeslot 1 and the UL DPCH shall be transmitted in timeslot 3. The TTI of the uplink DCCH shall be 20 ms.

**Table 8.6.3.1.1: General test parameters for Correct reporting of FDD inter-frequency neighbours in AWGN propagation condition (3,84 Mcps option)**

Parameter	Unit	Value	Comment
DPCH parameters		DL Reference Measurement Channel 12.2 kbps	As specified in TS 25.102 section A.2.2
Power Control		On	
Target quality value on DTCH	BLER	0.01	
Initial conditions	Active cell	Cell 1	UTRA TDD cell
	Neighbour cell	Cell 2	UTRA FDD cell
Final conditions	Active cell	Cell 1	
Threshold non used frequency	dB	-18	Applicable for event 2C
W non-used frequency		1	Applicable for event 2C
Hysteresis	dB	0	Applicable for event 2C
Time to Trigger	ms	0	
Filter coefficient		0	
Monitored cell list size		6 TDD neighbours on channel 1 6 FDD neighbours on channel 2	
T1	s	15	
T2	s	10	

**Table 8.6.3.1.2: Cell specific parameters for Correct reporting of FDD inter-frequency neighbours in AWGN propagation condition (3,84 Mcps option)**

Parameter	Unit	Cell 1				Cell 2	
		0		8		n.a	
Timeslot Number		T1	T2	T1	T2	T1	T2
UTRA RF Channel Number		Channel 1				Channel 2	
CPICH_Ec/lor	dB	n.a.		n.a.		-10	
PCCPCH_Ec/lor	dB	-3	-3			-12	
SCH_Ec/lor	dB	-9	-9	-9	-9	-12	
SCH_offset		0	0	0	0	n.a.	
PICH_Ec/lor				-3	-3	-15	
OCNS	dB	-4,28	-4,28	-4,28	-4,28	-0,941	
$\hat{I}_{or}/I_{oc}$	dB	3	3	3	3	-infinity	-1.8
$I_{oc}$	dBm/ 3,84 MHz	-70				-70	
CPICH_Ec/lo		n.a.				-infinity	-14
PCCPCH_RSCP	dB	-70	-70	-70	-70	n.a.	
Propagation Condition		AWGN				AWGN	

#### 8.6.3.1.4.1.2 Procedure

- 1) The RF parameters are set up according to T1.
- 2) The UE is switched on.
- 3) A call is set up according to the generic set-up procedure specified in TS 34.108 [3] subclause 7.4.2 to place the UE in CELL\_DCH.
- 4) SS shall transmit a MEASUREMENT CONTROL message.
- 5) After 15 seconds from the beginning of T1, the SS shall switch the power settings from T1 to T2.



- 6) UE shall transmit a MEASUREMENT REPORT message triggered by event 2C for cell 2. The measurement reporting delay from the beginning of T2 shall be less than 5040 ms. If the UE fails to report the event within the required delay, then a failure is recorded. If the reporting delay for this event is within the required limit, the number of successful tests is increased by one.
- 7) After 10 seconds from the beginning of T2, the UE is switched off. Any timing information of cell 2 is deleted in the UE.
- 8) Repeat steps 1-7 [TBD] times.

#### Specific Message Contents

All messages indicated above shall use the same content as described in the default message content in clause 9 of 34.108 [3] with the following exceptions:

Note: 10.x.y.z in the IE description refers to clauses in TS 25.331 [9].

MEASUREMENT CONTROL message (step 4):

Information Element/Group name	Value/Remark
Message Type (10.2.17)	
<b>UE information elements</b>	
-RRC transaction identifier	0
-Integrity check info	Not Present
<b>Measurement Information elements</b>	
-Measurement Identity	1
-Measurement Command (10.3.7.46)	Modify
-Measurement Reporting Mode (10.3.7.49)	AM RLC
-Periodical Reporting / Event Trigger Reporting Mode	Event trigger
-Additional measurements list (10.3.7.1)	Not Present
-CHOICE <i>Measurement type</i>	Inter-frequency measurement
-Inter-frequency measurement (10.3.7.16)	
-Inter-frequency measurement objects list (10.3.7.13)	
-CHOICE <i>inter-frequency cell removal</i>	No inter-frequency cells removed
-New inter-frequency cells	1
-Inter-frequency cell id	1
-Frequency info (10.3.6.36)	
-CHOICE <i>mode</i>	FDD
-UARFCN uplink (Nu)	Not Present
-UARFCN downlink (Nd)	Same frequency as channel 2
-Cell info (10.3.7.2)	
-Cell individual offset	Not Present
-Reference time difference to cell	Not Present
-Read SFN indicator	False
-CHOICE <i>mode</i>	FDD
-Primary CPICH info	
-Primary scrambling code	Set to Primary scrambling code of Cell2
-Primary CPICH Tx Power	Set to Primary CPICH Tx Power of Cell2 described in Table 8.6.3.1.2
-Tx Diversity Indicator	FALSE
-Cell selection and re-selection info	Not Present
-Cell for measurement	Not Present
-Inter-frequency measurement quantity (10.3.7.18)	
-CHOICE <i>reporting criteria</i>	Inter-frequency reporting criteria
-Filter coefficient (10.3.7.9)	0
-CHOICE <i>mode</i>	FDD
-Measurement quantity for frequency quality estimate	CPICH_Ec/No
-Inter-frequency reporting quantity (10.3.7.21)	
-UTRA carrier RSSI	
-Frequency quality estimate	
-Non frequency related cell reporting quantities (10.3.7.5)	
-SFN-SFN observed time difference reporting indicator	No report
-Cell synchronisation information reporting indicator	FALSE
-Cell identity reporting indicator	FALSE
-CHOICE <i>mode</i>	FDD
-CPICH Ec/No reporting indicator	TRUE
-CPICH RSCP reporting indicator	FALSE
-Pathloss reporting indicator	FALSE
-Reporting cell status (10.3.7.61)	Not Present
-Measurement validity (10.3.7.51)	Not Present
-CHOICE <i>report criteria</i>	Inter-frequency measurement reporting criteria
-Inter-frequency measurement reporting criteria (10.3.7.19)	
-Parameters required for each event	1
-Intra-frequency event identity	Event 2C
-Threshold used frequency	Not Present
-W Used frequency	Not Present
-Hysteresis	0 dB
-Time to trigger	0 ms
-Reporting Cell Status (10.3.61)	
-CHOICE reported cell	Report cells within active and/or monitored set on used frequency or within virtual active and/or monitored set on non-used frequency
-Maximum number of reported cells	3

Information Element/Group name	Value/Remark
-Parameters required for each non-used frequenc - Threshold non-used frequency - W non-used frequency	-18 1
<b>Physical channel information elements</b> -DPCH compressed mode status info (10.3.6.34)	Not Present

## MEASUREMENT REPORT message (step 6)

Information Element	Value/remark
Message Type (10.2.17)	
Integrity check info	Not Present
Measurement identity	1
Measured Results (10.3.7.44)	
-CHOICE Measurement	Inter-frequency Measured results list
-Inter-frequency measured results	1
-Frequency info	
-CHOICE mode	FDD
-UARFCN uplink (Nu)	Not Present
-UARFCN downlink (Nd)	Same frequency as channel 2
-UTRA carrier RSSI	Not Present
-Inter-frequency cell measured results	1
-Cell measured results (10.3.7.3)	
-Cell identity	Not Present
-SFN-SFN observed time difference	Not Present
-Cell synchronisation info	Not Present
-CHOICE mode	FDD
-Primary CPICH Info	
-Primary scrambling code	Set to Primary scrambling code of Cell2
-CPICH Ec/No	Checked that this IE is present
-CPICH RSCP	Not Present
-Pathloss	Not Present
Measured results on RACH	Not Present
Additional measured results	Not Present
Event results (10.3.7.7)	
-CHOICE event result	Inter-frequency measurement event results
-Inter-frequency event identity	2C
-Inter-frequency cells	1
-Frequency Info	
-CHOICE mode	FDD
-UARFCN uplink (Nu)	Not Present
-UARFCN downlink (Nd)	Same frequency as channel 2
-CHOICE mode	FDD
-Primary CPICH info	
-Primary Scrambling Code	Set to Primary scrambling code of Cell2

## 8.6.3.1.4.2 1,28 Mcps TDD Option

Cell 1 is current active TDD cell, Cell 2 is a FDD cell. The power level of CPICH RSCP of cell 2 and the P-CCPCH RSCP of cell 1 is changed. General test parameters are given in the table 8.6.3.1.3 below and they are signalled from test device. New measurement control information, which defines neighbour cells etc., is always sent before the handover starts. The test parameters are given in Table 8.6.3.1.4 below.

**Table 8.6.3.1.3: General test parameters for Correct reporting of FDD neighbours in AWGN propagation condition 1,28Mcps option**

Parameter		Unit	Value	Comment
DPCH parameters active cell			DL Reference Measurement Channel 12.2 kbps	As specified in TS 25.102 section A. The DPCH is located in an other timeslot than 0.
Power Control			On	
Target quality value on DTCH		BLER	0.01	
Active cell Initial conditions	Active cell		Cell 1	1.28Mcps TDD cell
	Neighbour cell		Cell2	FDD cell
Final conditions	Active cell		Cell 1	1.28Mcps TDD cell
Threshold non used frequency		dBm	-86	Absolute CPICH RSCP threshold for event 2C
Hysteresis		dB	0	
W non-used frequency			1	Applicable for event 2C
Time to Trigger		ms	0	
Filter coefficient			0	
Monitored cell list size			6 TDD neighbours on Channel 1 6 FDD neighbours on Channel 2	Measurement control information is sent before T1 starts.
T1		s	10	
T2		s	10	

**Table 8.6.3.1.4 Cell Specific parameters for Correct reporting of FDD neighbours in AWGN propagation condition: 1,28Mcps option**

Parameter	Unit	Cell 1				Cell 2	
		0		DwPTS		n.a.	n.a.
Timeslot Number		T1	T2	T1	T2	T1	T2
UTRA RF Channel Number		Channel 1				Channel 2	
CPICH_Ec/lor	dB	n.a.		n.a.		-10	-10
PCCPCH_Ec/lor	dB	-3	-3			-12	-12
SCH_Ec/lor	dB	n.a.	n.a.	n.a.	n.a.	-12	-12
PICH_Ec/lor	dB	n.a.	n.a.	n.a.	n.a.	-15	-15
DwPCH_Ec/lor	dB			0	0	n.a.	n.a.
OCNS	dB	-3	-3			-0,941	-0,941
$\hat{I}_{or}/I_{oc}$	dB	3	3	3	3	-Infinity	-2
$I_{oc}$	dBm/1.28 MHz	-70					
$I_{oc}$	dBm/3.84 MHz					-70	
CPICH_RSCP	dBm	n.a.				-Infinity	-82
PCCPCH_RSCP	dBm	-70	-70			n.a.	n.a.
Propagation Condition		AWGN				AWGN	

Note: The DPCH of cell 1 is located in a timeslot other than 0.

#### 8.6.3.1.4.2.1 Test Procedure

- 1) The RF parameters are set up according to T1.
- 2) The UE is switched on.
- 3) A call is set up according to the generic set-up procedure specified in TS 34.108 [3] subclause 7.4.2 to place the UE in CELL\_DCH.
- 4) SS shall transmit a MEASUREMENT CONTROL message.
- 5) After 15 seconds from the beginning of T1, the SS shall switch the power settings from T1 to T2.

- 6) UE shall transmit a MEASUREMENT REPORT message triggered by event 2C for cell 2. The measurement reporting delay from the beginning of T2 shall be less than 5040 ms. If the UE fails to report the event within the required delay, then a failure is recorded. If the reporting delay for this event is within the required limit, the number of successful tests is increased by one.
- 7) After 10 seconds from the beginning of T2, the UE is switched off. Any timing information of cell 2 is deleted in the UE.
- 8) Repeat steps 1-7 [TBD] times.

#### Specific Message Contents

All messages indicated above shall use the same content as described in the default message content in clause 9 of 34.108 [3] and in Annex A of 34.123-1 [21], with the following exceptions:

Note: 10.x.y.z in the IE description refers to clauses in TS 25.331 [9].

MEASUREMENT CONTROL message (step 4):

Information Element/Group name	Value/Remark
Message Type (10.2.17)	
<b>UE information elements</b>	
-RRC transaction identifier	0
-Integrity check info	Not Present
<b>Measurement Information elements</b>	
-Measurement Identity	1
-Measurement Command (10.3.7.46)	Modify
-Measurement Reporting Mode (10.3.7.49)	AM RLC
-Periodical Reporting / Event Trigger Reporting Mode	Event trigger
-Additional measurements list (10.3.7.1)	Not Present
-CHOICE <i>Measurement type</i>	Inter-frequency measurement
-Inter-frequency measurement (10.3.7.16)	
-Inter-frequency measurement objects list (10.3.7.13)	
-CHOICE <i>inter-frequency cell removal</i>	No inter-frequency cells removed
-New inter-frequency cells	1
-Inter-frequency cell id	1
-Frequency info (10.3.6.36)	
-CHOICE <i>mode</i>	FDD
-UARFCN uplink (Nu)	Not Present
-UARFCN downlink (Nd)	Same frequency as channel 2
-Cell info (10.3.7.2)	
-Cell individual offset	Not Present
-Reference time difference to cell	Not Present
-Read SFN indicator	False
-CHOICE <i>mode</i>	FDD
-Primary CPICH info	
-Primary scrambling code	Set to Primary scrambling code of Cell2
-Primary CPICH Tx Power	Set to Primary CPICH Tx Power of Cell2 described in Table 8.6.3.1.2
-Tx Diversity Indicator	FALSE
-Cell selection and re-selection info	Not Present
-Cell for measurement	Not Present
-Inter-frequency measurement quantity (10.3.7.18)	
-CHOICE <i>reporting criteria</i>	Inter-frequency reporting criteria
-Filter coefficient (10.3.7.9)	0
-CHOICE <i>mode</i>	FDD
-Measurement quantity for frequency quality estimate	CPICH_RSCP
-Inter-frequency reporting quantity (10.3.7.21)	
-UTRA carrier RSSI	
-Frequency quality estimate	
-Non frequency related cell reporting quantities (10.3.7.5)	
-SFN-SFN observed time difference reporting indicator	No report
-Cell synchronisation information reporting indicator	FALSE
-Cell identity reporting indicator	FALSE
-CHOICE <i>mode</i>	FDD
-CPICH Ec/N0 reporting indicator	TRUE
-CPICH RSCP reporting indicator	FALSE
-Pathloss reporting indicator	FALSE
-Reporting cell status (10.3.7.61)	Not Present
-Measurement validity (10.3.7.51)	Not Present
-CHOICE <i>report criteria</i>	Inter-frequency measurement reporting criteria
-Inter-frequency measurement reporting criteria (10.3.7.19)	
-Parameters required for each event	1
-Intra-frequency event identity	Event 2C
-Threshold used frequency	Not Present
-W Used frequency	Not Present
-Hysteresis	0 dB
-Time to trigger	0 ms
-Reporting Cell Status (10.3.61)	
-CHOICE reported cell	Report cells within active and/or monitored set on used frequency or within virtual active and/or monitored set on non-used frequency
-Maximum number of reported cells	3

Information Element/Group name	Value/Remark
-Parameters required for each non-used frequenc - Threshold non-used frequency - W non-used frequency	-86 1
<b>Physical channel information elements</b> -DPCH compressed mode status info (10.3.6.34)	Not Present

## MEASUREMENT REPORT message (step 6)

Information Element	Value/remark
Message Type (10.2.17)	Not Present
Integrity check info	1
Measurement identity	1
Measured Results (10.3.7.44)	Inter-frequency Measured results list
-CHOICE Measurement	1
-Inter-frequency measured results	1
-Frequency info	FDD
-CHOICE mode	Not Present
-UARFCN uplink (Nu)	Same frequency as channel 2
-UARFCN downlink (Nd)	Not Present
-UTRA carrier RSSI	Not Present
-Inter-frequency cell measured results	1
-Cell measured results (10.3.7.3)	Not Present
-Cell identity	Not Present
-SFN-SFN observed time difference	Not Present
-Cell synchronisation info	Not Present
-CHOICE mode	FDD
-Primary CPICH Info	Set to Primary scrambling code of Cell2
-Primary scrambling code	Checked that this IE is present
-CPICH Ec/No	Not Present
-CPICH RSCP	Not Present
-Pathloss	Not Present
Measured results on RACH	Not Present
Additional measured results	Not Present
Event results (10.3.7.7)	Inter-frequency measurement event results
-CHOICE event result	2C
-Inter-frequency event identity	1
-Inter-frequency cells	1
-Frequency Info	FDD
-CHOICE mode	Not Present
-UARFCN uplink (Nu)	Same frequency as channel 2
-UARFCN downlink (Nd)	FDD
-CHOICE mode	FDD
-Primary CPICH info	Set to Primary scrambling code of Cell2
-Primary Scrambling Code	Set to Primary scrambling code of Cell2

8.6.3.1.4.3 7,68 Mcps TDD Option

8.6.3.1.4.3.1 Initial conditions

Test environment: normal; see clauses G.2.1 and G.2.2.

Frequencies to be tested: mid range; see clause G.2.4.

The test parameters are given in Table 8.6.3.1.4.3.1.1 and 8.6.3.1.4.3.1.2. The test consists of two successive time periods, with time durations of T1 and T2 respectively. Two cells shall be present in the test, cell 1 being the serving UTRA TDD cell and cell 2 being a UTRA FDD neighbour cells on the unused frequency.

In the measurement control information it is indicated to the UE that event-triggered reporting with Event 2C shall be used and that CPICH Ec/I0 of the best cell on the unused frequency shall be reported together with Event 2C. The Measurement control message shall be sent to the UE such that the delay between the end of the last received TTI containing the message and the beginning of T1 is at least equal to the RRC procedure delay as defined in [9].

The second Beacon timeslot shall be provided in timeslot 8 for cell 1. The DL DPCH shall be transmitted in timeslot 1 and the UL DPCH shall be transmitted in timeslot 3. The TTI of the uplink DCCH shall be 20 ms.

**Table 8.6.3.1.4.3.1.1: General test parameters for Correct reporting of FDD inter-frequency neighbours in AWGN propagation condition (7,68 Mcps option)**

Parameter		Unit	Value	Comment
DPCH parameters			DL Reference Measurement Channel 12.2 kbps	As specified in TS 25.102 section A.2.2
Power Control			On	
Target quality value on DTCH		BLER	0.01	
Initial conditions	Active cell		Cell 1	UTRA TDD cell
	Neighbour cell		Cell 2	UTRA FDD cell
Final conditions	Active cell		Cell 1	
Threshold non used frequency		dB	-18	Applicable for event 2C
W non-used frequency			1	Applicable for event 2C
Hysteresis		dB	0	Applicable for event 2C
Time to Trigger		ms	0	
Filter coefficient			0	
Monitored cell list size			6 TDD neighbours on channel 1 6 FDD neighbours on channel 2	
T1		s	15	
T2		s	10	

**Table 8.6.3.1.4.3.1.2: Cell specific parameters for Correct reporting of FDD inter-frequency neighbours in AWGN propagation condition (7,68 Mcps option)**

Parameter	Unit	Cell 1				Cell 2	
		0		8		n.a.	
Timeslot Number		T1	T2	T1	T2	T1	T2
UTRA RF Channel Number		Channel 1				Channel 2	
CPICH_Ec/I <sub>or</sub>	dB	n.a.		n.a.		-10	
PCCPCH_Ec/I <sub>or</sub>	dB	-3	-3			-12	
SCH_Ec/I <sub>or</sub>	dB	-9	-9	-9	-9	-12	
SCH_offset		0	0	0	0	n.a.	
PICH_Ec/I <sub>or</sub>				-3	-3	-15	
OCNS	dB	-4,28	-4,28	-4,28	-4,28	-0,941	
$\hat{I}_{or}/I_{oc}$	dB	3	3	3	3	-infinity	-1.8
$I_{oc}$	dBm/ 7.68 MHz	-70				-70	
CPICH_Ec/I <sub>o</sub>		n.a.				-infinity	-14
PCCPCH_RSCP	dB	-70	-70	-70	-70	n.a.	
Propagation Condition		AWGN				AWGN	

#### 8.6.3.1.4.3.2 Procedure

- 1) The RF parameters are set up according to T1.
- 2) The UE is switched on.
- 3) A call is set up according to the generic set-up procedure specified in TS 34.108 [3] subclause 7.4.2 to place the UE in CELL\_DCH.
- 4) SS shall transmit a MEASUREMENT CONTROL message.
- 5) After 15 seconds from the beginning of T1, the SS shall switch the power settings from T1 to T2.
- 6) UE shall transmit a MEASUREMENT REPORT message triggered by event 2C for cell 2. The measurement reporting delay from the beginning of T2 shall be less than 5040 ms. If the UE fails to report the event within the required delay, then a failure is recorded. If the reporting delay for this event is within the required limit, the number of successful tests is increased by one.



- 7) After 10 seconds from the beginning of T2, the UE is switched off. Any timing information of cell 2 is deleted in the UE.
- 8) Repeat steps 1-7 until the confidence level according to annex F.6.2 is achieved..

#### Specific Message Contents

All messages indicated above shall use the same content as described in the default message content in clause 9 of 34.108 [3] with the following exceptions:

Note: 10.x.y.z in the IE description refers to clauses in TS 25.331 [9].

MEASUREMENT CONTROL message (step 4):

Information Element/Group name	Value/Remark
Message Type (10.2.17)	
<b>UE information elements</b>	
-RRC transaction identifier	0
-Integrity check info	Not Present
<b>Measurement Information elements</b>	
-Measurement Identity	1
-Measurement Command (10.3.7.46)	Modify
-Measurement Reporting Mode (10.3.7.49)	AM RLC
-Periodical Reporting / Event Trigger Reporting Mode	Event trigger
-Additional measurements list (10.3.7.1)	Not Present
-CHOICE <i>Measurement type</i>	Inter-frequency measurement
-Inter-frequency measurement (10.3.7.16)	
-Inter-frequency measurement objects list (10.3.7.13)	
-CHOICE <i>inter-frequency cell removal</i>	No inter-frequency cells removed
-New inter-frequency cells	1
-Inter-frequency cell id	1
-Frequency info (10.3.6.36)	
-CHOICE <i>mode</i>	FDD
-UARFCN uplink (Nu)	Not Present
-UARFCN downlink (Nd)	Same frequency as channel 2
-Cell info (10.3.7.2)	
-Cell individual offset	Not Present
-Reference time difference to cell	Not Present
-Read SFN indicator	False
-CHOICE <i>mode</i>	FDD
-Primary CPICH info	
-Primary scrambling code	Set to Primary scrambling code of Cell2
-Primary CPICH Tx Power	Set to Primary CPICH Tx Power of Cell2 described in Table 8.6.3.1.2
-Tx Diversity Indicator	FALSE
-Cell selection and re-selection info	Not Present
-Cell for measurement	Not Present
-Inter-frequency measurement quantity (10.3.7.18)	
-CHOICE <i>reporting criteria</i>	Inter-frequency reporting criteria
-Filter coefficient (10.3.7.9)	0
-CHOICE <i>mode</i>	FDD
-Measurement quantity for frequency quality estimate	CPICH_Ec/No
-Inter-frequency reporting quantity (10.3.7.21)	
-UTRA carrier RSSI	
-Frequency quality estimate	
-Non frequency related cell reporting quantities (10.3.7.5)	
-SFN-SFN observed time difference reporting indicator	No report
-Cell synchronisation information reporting indicator	FALSE
-Cell identity reporting indicator	FALSE
-CHOICE <i>mode</i>	FDD
-CPICH Ec/No reporting indicator	TRUE
-CPICH RSCP reporting indicator	FALSE
-Pathloss reporting indicator	FALSE
-Reporting cell status (10.3.7.61)	Not Present
-Measurement validity (10.3.7.51)	Not Present
-CHOICE <i>report criteria</i>	Inter-frequency measurement reporting criteria
-Inter-frequency measurement reporting criteria (10.3.7.19)	
-Parameters required for each event	1
-Intra-frequency event identity	Event 2C
-Threshold used frequency	Not Present
-W Used frequency	Not Present
-Hysteresis	0 dB
-Time to trigger	0 ms
-Reporting Cell Status (10.3.61)	
-CHOICE reported cell	Report cells within active and/or monitored set on used frequency or within virtual active and/or monitored set on non-used frequency
-Maximum number of reported cells	3

Information Element/Group name	Value/Remark
-Parameters required for each non-used frequenc - Threshold non-used frequency - W non-used frequency	-18 1
<b>Physical channel information elements</b> -DPCH compressed mode status info (10.3.6.34)	Not Present

## MEASUREMENT REPORT message (step 6)

Information Element	Value/remark
Message Type (10.2.17)	
Integrity check info	Not Present
Measurement identity	1
Measured Results (10.3.7.44)	
-CHOICE Measurement	Inter-frequency Measured results list
-Inter-frequency measured results	1
-Frequency info	
-CHOICE mode	FDD
-UARFCN uplink (Nu)	Not Present
-UARFCN downlink (Nd)	Same frequency as channel 2
-UTRA carrier RSSI	Not Present
-Inter-frequency cell measured results	1
-Cell measured results (10.3.7.3)	
-Cell identity	Not Present
-SFN-SFN observed time difference	Not Present
-Cell synchronisation info	Not Present
-CHOICE mode	FDD
-Primary CPICH Info	
-Primary scrambling code	Set to Primary scrambling code of Cell2
-CPICH Ec/No	Checked that this IE is present
-CPICH RSCP	Not Present
-Pathloss	Not Present
Measured results on RACH	Not Present
Additional measured results	Not Present
Event results (10.3.7.7)	
-CHOICE event result	Inter-frequency measurement event results
-Inter-frequency event identity	2C
-Inter-frequency cells	1
-Frequency Info	
-CHOICE mode	FDD
-UARFCN uplink (Nu)	Not Present
-UARFCN downlink (Nd)	Same frequency as channel 2
-CHOICE mode	FDD
-Primary CPICH info	
-Primary Scrambling Code	Set to Primary scrambling code of Cell2

## 8.6.3.1.5 Test requirements

## 8.6.3.1.5.1 3,84 Mcps TDD Option

The UE shall send one Event 2C triggered measurement report for Cell 2 with a measurement reporting delay less than 5040ms from the beginning of time period T2.

The UE shall not send event triggered measurement reports, as long as the reporting criteria are not fulfilled.

For the test to pass, the total number of successful tests shall be more than 90% with a confidence level of [FFS]% of the cases.

## 8.6.3.1.5.2 1,28 Mcps TDD Option

The UE shall send one Event 2C triggered measurement report, with a measurement reporting delay less than 5080ms from the beginning of time period T2.

The UE shall not send any measurement reports, as long as the reporting criteria are not fulfilled.

The rate of correct events observed during repeated tests shall be at least 90%.

#### 8.6.3.1.5.3 7,68 Mcps TDD Option

The UE shall send one Event 2C triggered measurement report for Cell 2 with a measurement reporting delay less than 5040ms from the beginning of time period T2.

The UE shall not send event triggered measurement reports, as long as the reporting criteria are not fulfilled.

For the test to pass, the total number of successful tests shall be more than 90% with a confidence level of 95% of the cases.

### 8.6.4 GSM measurements

#### 8.6.4.1 Correct reporting of GSM neighbours in AWGN propagation condition

##### 8.6.4.1.1 3,84 Mcps TDD option

FFS

##### 8.6.4.1.2 1,28 Mcps TDD option

###### 8.6.4.1.2.1 Definition and applicability

.In the event triggered reporting period the measurement reporting delay is defined as the time between any event that will trigger a measurement report until the UE starts to transmit over the Uu interface. This requirement assumes that the measurement report is not delayed by other RRC signalling on the DCCH. This measurement reporting delay excludes a delay uncertainty resulted when inserting the measurement report to the TTI of the uplink DCCH. The delay uncertainty is twice the TTI of the uplink DCCH. The purpose of this test is to verify that the UE makes correct reporting of an event when doing inter frequency measurements on a neighbouring GSM cell. The test will partly verify the requirements in section 8.4 of [2].

The requirements and this test apply to the combined GSM and TDD (1,28Mcps option) UE.

###### 8.6.4.1.2.2 Minimum requirement

The purpose of this test is to verify that the UE makes correct reporting of an event when doing inter-RAT GSM measurements.

###### 8.6.4.1.2.3 Test purpose

To verify that the UE meets the minimum time requirements for identifying neighbouring GSM cells.

###### 8.6.4.1.2.4 Method of test

###### 8.6.4.1.2.4.1 Initial condition of Test 1

Test 1 is with BSIC verification required case.

Two cells shall be present in the test, Cell 1 is current active TDD cell, cell 2 is a GSM cell. The test consists of three successive time periods, with a time duration of T1, T2 and T3 respectively. The test parameters are given in Tables 8.6.4.1.2.1 and 8.6.4.1.2.2 below. In the measurement control information it is indicated to the UE that event-triggered reporting with Event 3B and 3C shall be used. At the start of time duration T1, the UE may not have any timing information of cell 2. The power level of cell 2 is increased and then reduced, and a measurement report should be triggered at each transition.

**Table 8.6.4.1.2.1 General test parameters for Correct reporting of GSM neighbours in AWGN propagation condition**

Parameter	Unit	Value	Comment
DCH parameters		DL Reference Measurement Channel 12.2 kbps	As specified in TS 25.102 section A.2.2. The DPCH is located in an other timeslot than 0.
Power Control		On	
Target quality value on DTCH	BLER	0.01	
Active cell		Cell 1	
Inter-RAT measurement quantity		GSM Carrier RSSI	
BSIC verification required		Required	
Threshold other system	dBm	-80	Absolute GSM carrier RSSI threshold for event 3B and 3C.
Hysteresis	dB	0	
Time to Trigger	ms	0	
Filter coefficient		0	
Monitored cell list size		12 TDD neighbours on Channel 1 6 GSM neighbours including ARFCN 1	Measurement control information is sent before T1 starts.
T Identify abort	s	5.0	
T Reconfirm abort	s	5.0	
T1	s	5	
T2	s	7	
T3	s	5	

**Table 8.6.4.1.2.2 Cell specific test parameters for Correct reporting of GSM neighbours in AWGN propagation condition (cell 1) LCR TDD**

Parameter	Unit	Cell 1	
		T1, T2, T3	
Timeslot Number		0	DwPTS
UTRA RF Channel Number		Channel 1	
PCCPCH_Ec/lor	dB	-3	
DwPCH_Ec/lor	dB		0
OCNS_Ec/lor	dB	-3	
$\hat{I}_{or}/I_{oc}$	dB	3	
$I_{oc}$	dBm/1.28 MHz	-70	
PCCPCH_RSCP	dBm	-70	
Propagation Condition		AWGN	
Note 1: The power of the OCNS channel that is added shall make the total power from the cell to be equal to lor.			
Note 2: PCCPCH RSCP levels have been calculated from other parameters for information purposes. They are not settable parameters themselves.			

**Table 8.6.4.1.2.3 Cell specific test parameters for Correct reporting of GSM neighbours in AWGN propagation condition (cell 2) GSM**

Parameter	Unit	Cell 2		
		T1	T2	T3
Absolute RF Channel Number		ARFCN 1		
RXLEV	dBm	-infinity	-75	-85

## 8.6.4.1.2.4.1 Initial condition of Test 2

Test 2 is without BSIC verification required case.

Two cells shall be present in the test, Cell 1 is current active TDD cell, cell 2 is a GSM cell. The test consists of three successive time periods, with a time duration of T1, T2 and T3 respectively. The test parameters are given in Tables 8.6.4.1.2.4 and 8.6.4.1.2.5 below. In the measurement control information it is indicated to the UE that event-triggered reporting with Event 3B and 3C shall be used. At the start of time duration T1, the UE may not have any timing information of cell 2. The power level of cell 2 is increased and then reduced, and a measurement report should be triggered at each transition.

**Table 8.6.4.1.2.4 General test parameters for Correct reporting of GSM neighbours in AWGN propagation condition**

Parameter	Unit	Value	Comment
DCH parameters		DL Reference Measurement Channel 12.2 kbps	As specified in TS 25.102 section A.2.2. The DPCH is located in an other timeslot than 0.
Power Control		On	
Target quality value on DTCH	BLER	0.01	
Active cell		Cell 1	
Inter-RAT measurement quantity		GSM Carrier RSSI	
BSIC verification required		Required	
Threshold other system	dBm	-80	Absolute GSM carrier RSSI threshold for event 3B and 3C.
Hysteresis	dB	0	
Time to Trigger	ms	0	
Filter coefficient		0	
Monitored cell list size		12 TDD neighbours on Channel 1 6 GSM neighbours including ARFCN 1	Measurement control information is sent before T1 starts.
T Identify abort	s	5.0	
T Reconfirm abort	s	5.0	
T1	s	5	
T2	s	2	
T3	s	5	

**Table 8.6.4.1.2.5 Cell specific test parameters for Correct reporting of GSM neighbours in AWGN propagation condition (cell 1) LCR TDD**

Parameter	Unit	Cell 1	
		T1, T2, T3	
Timeslot Number		0	DwPTS
UTRA RF Channel Number		Channel 1	
PCCPCH_Ec/Ior	dB	-3	
DwPCH_Ec/Ior	dB		0
OCNS_Ec/Ior	dB	-3	
$\hat{I}_{or}/I_{oc}$	dB	3	
$I_{oc}$	dBm/1.28 MHz	-70	
PCCPCH_RSCP	dBm	-70	
Propagation Condition		AWGN	
Note 1: The power of the OCNS channel that is added shall make the total power from the cell to be equal to Ior.			
Note 2: PCCPCH RSCP levels have been calculated from other parameters for information purposes. They are not settable parameters themselves.			

**Table 8.6.4.1.2.6 Cell specific test parameters for Correct reporting of GSM neighbours in AWGN propagation condition (cell 2) GSM**

Parameter	Unit	Cell 2		
		T1	T2	T3
Absolute RF Channel Number		ARFCN 1		
RXLEV	dBm	-infinity	-75	-85

## 8.6.4.1.2.5 Test Procedure

## 8.6.4.1.2.5.1 Test 1

- 1) The RF parameters are set up according to test T1.( see Table 8.6.4.1.2.2 and Table 8.6.4.1.2.3)
- 2) The UE is switched on.
- 3) A call is set up according to the generic set-up procedure specified in TS 34.108 [3] subclause 7.4.2 to place the UE in CELL\_DCH.
- 4) SS shall transmit the MEASUREMENT CONTROL message.
- 5) After 5seconds from the beginning of T1, the SS shall switch the GSM level setting from T1 to T2.
- 6) UE shall transmit a MEASUREMENT REPORT message triggered by event 3C for cell 2. The measurement reporting delay from the beginning of T2 shall be less than 6.04s. If the UE fails to report the event within the required delay, then a failure is recorded. If the reporting delay for this event is within the required limit, the number of successful tests is increased by one.
- 7) After 7seconds from the beginning of T2, the SS shall switch the GSM level setting from T2 to T3.
- 8) UE shall transmit a MEASUREMENT REPORT message triggered by event 3B for cell 2. The measurement reporting delay from the beginning of T3 shall be less than 1040ms. If the UE fails to report the event within the required delay, then a failure is recorded. If the reporting delay for this event is within the required limit, the number of successful tests is increased by one.
- 9) After the SS receives the measurement report message in step 8 ) or 5 seconds from the beginning of T3, the UE is switched off. Any timing information of cell 2 is deleted in the UE.
- 11) Repeat steps 1-9 according to Annex F.6.2 Table F.6.2.8.

## Specific Message Contents

All messages indicated above shall use the same content as described in the default message content in clause 9 of 34.108 [3] with the following exceptions.:

Note: Numbers in brackets after an item e.g “Message Type (10.2.17)” in the IE description are references to clause numbers in TS 25.331 [9] describing that item in more detail.

MEASUREMENT CONTROL message (step 4):

Information Element/Group name	Value/Remark
Message Type (10.2.17)	
<b>UE information elements</b>	
-RRC transaction identifier	0
-Integrity check info	
<b>Measurement Information elements</b>	
-Measurement Identity	2
-Measurement Command (10.3.7.46)	Setup
-Measurement Reporting Mode (10.3.7.49)	
-Measurement Report Transfer Mode	AM RLC
-Periodical Reporting / Event Trigger Reporting Mode	Event trigger
-Additional measurements list (10.3.7.1)	Not Present
-CHOICE <i>Measurement type</i>	Inter-RAT measurement
-Inter-RAT measurement (10.3.7.27)	
-Inter-RAT measurement objects list (10.3.7.23)	Not Present
-Inter-RAT measurement quantity (10.3.7.29)	
-Measurement quantity for UTRAN quality estimate (10.3.7.38)	
-Filter coefficient	0
-CHOICE mode	TDD
-Measurement quantity	PCcPCH_RSCP
-CHOICE system	GSM
-Measurement quantity	GSM Carrier RSSI
-Filter coefficient	0
-BSIC verification required	Required
-Inter-RAT reporting quantity (10.3.7.32)	
-Reporting cell status (10.3.7.61)	Not Present
-CHOICE report criteria	Inter-RAT measurement reporting criteria
-Inter-RAT measurement reporting criteria (10.3.7.30)	
-Parameters required for each event	2
-Inter-RAT event identity (10.3.7.24)	Event 3B
-Threshold own system	Not Present
-W	Not Present
-Threshold other system	-80 dBm
-Hysteresis	0 dB
-Time to trigger	0 ms
-Reporting cell status (10.3.7.61)	
-CHOICE reported cell	Report cells within active set or within virtual active set or of the other RAT
-Maximum number of reported cells	2
-Inter-RAT event identity (10.3.7.24)	Event 3C
-Threshold own system	Not Present
-W	Not Present
-Threshold other system	-80 dBm
-Hysteresis	0 dB
-Time to trigger	0 ms
-Reporting cell status (10.3.7.61)	
-CHOICE reported cell	Report cells within active set or within virtual active set or of the other RAT
-Maximum number of reported cells	2
<b>Physical channel information elements</b>	
-DPCH compressed mode status info (10.3.6.34)	Not Present



First MEASUREMENT REPORT message (step 6)

Information Element	Value/remark
Message Type (10.2.17)	
Integrity check info	Not Present
Measurement identity	1
Measured Results (10.3.7.44)	
-CHOICE Measurement	Inter-frequency Measured results list
-Inter-frequency measured results	1
-Frequency info	
-CHOICE mode	GSM
-UARFCN uplink (Nu)	Not Present
-UARFCN downlink (Nd)	Same frequency as channel 2
-UTRA carrier RSSI	Not Present
Event results (10.3.7.7)	
-CHOICE event result	Inter-frequency measurement event results
-Inter-frequency event identity	3C
-Inter-frequency cells	1

Second MEASUREMENT REPORT message (step 8)

Information Element	Value/remark
Message Type (10.2.17)	
Integrity check info	Not Present
Measurement identity	1
Measured Results (10.3.7.44)	
-CHOICE Measurement	Inter-frequency Measured results list
-Inter-frequency measured results	1
-Frequency info	
-CHOICE mode	GSM
-UARFCN uplink (Nu)	Not Present
-UARFCN downlink (Nd)	Same frequency as channel 2
-UTRA carrier RSSI	Not Present
Event results (10.3.7.7)	
-CHOICE event result	Inter-frequency measurement event results
-Inter-frequency event identity	3B
-Inter-frequency cells	1

#### 8.6.4.1.2.5.2 Test 2

- 1) The RF parameters are set up according to test T1.( see Table 8.6.4.1.2.5 and Table 8.6.4.1.2.6)
- 2) The UE is switched on.
- 3) A call is set up according to the generic set-up procedure specified in TS 34.108 [3] subclause 7.4.2 to place the UE in CELL\_DCH.
- 4) SS shall transmit the MEASUREMENT CONTROL message.
- 5) After 5 seconds from the beginning of T1, the SS shall switch the GSM level setting from T1 to T2.
- 6) UE shall transmit a MEASUREMENT REPORT message triggered by event 3C for cell 2. The measurement reporting delay from the beginning of T2 shall be less than 1040ms. If the UE fails to report the event within the required delay, then a failure is recorded. If the reporting delay for this event is within the required limit, the number of successful tests is increased by one.
- 7) After 2 seconds from the beginning of T2, the SS shall switch the GSM level setting from T2 to T3.
- 8) UE shall transmit a MEASUREMENT REPORT message triggered by event 3B for cell 2. The measurement reporting delay from the beginning of T3 shall be less than 1040ms. If the UE fails to report the event within the required delay, then a failure is recorded. If the reporting delay for this event is within the required limit, the number of successful tests is increased by one.
- 9) After the SS receives the measurement report message in step 8 ) or 5 seconds from the beginning of T3, the UE is switched off. Any timing information of cell 2 is deleted in the UE.

10) Repeat steps 1-9 according to Annex F.6.2 Table F.6.2.8.

### Specific Message Contents

All messages indicated above shall use the same content as described in the default message content in clause 9 of 34.108 [3] with the following exceptions.:

Note: Numbers in brackets after an item e.g “Message Type (10.2.17)” in the IE description are references to clause numbers in TS 25.331 [9] describing that item in more detail.

MEASUREMENT CONTROL message (step 4):

Information Element/Group name	Value/Remark
Message Type (10.2.17)	
<b>UE information elements</b>	
-RRC transaction identifier	0
-Integrity check info	
<b>Measurement Information elements</b>	
-Measurement Identity	2
-Measurement Command (10.3.7.46)	Setup
-Measurement Reporting Mode (10.3.7.49)	
-Measurement Report Transfer Mode	AM RLC
-Periodical Reporting / Event Trigger Reporting Mode	Event trigger
-Additional measurements list (10.3.7.1)	Not Present
-CHOICE <i>Measurement type</i>	Inter-RAT measurement
-Inter-RAT measurement (10.3.7.27)	
-Inter-RAT measurement objects list (10.3.7.23)	Not Present
-Inter-RAT measurement quantity (10.3.7.29)	
-Measurement quantity for UTRAN quality estimate (10.3.7.38)	
-Filter coefficient	0
-CHOICE mode	TDD
-Measurement quantity	PCcPCH_RSCP
-CHOICE system	GSM
-Measurement quantity	GSM Carrier RSSI
-Filter coefficient	0
-BSIC verification required	Not Required
-Inter-RAT reporting quantity (10.3.7.32)	
-Reporting cell status (10.3.7.61)	Not Present
-CHOICE report criteria	Inter-RAT measurement reporting criteria
-Inter-RAT measurement reporting criteria (10.3.7.30)	
-Parameters required for each event	2
-Inter-RAT event identity (10.3.7.24)	Event 3B
-Threshold own system	Not Present
-W	Not Present
-Threshold other system	-80 dBm
-Hysteresis	0 dB
-Time to trigger	0 ms
-Reporting cell status (10.3.7.61)	
-CHOICE reported cell	Report cells within active set or within virtual active set or of the other RAT
-Maximum number of reported cells	2
-Inter-RAT event identity (10.3.7.24)	Event 3C
-Threshold own system	Not Present
-W	Not Present
-Threshold other system	-80 dBm
-Hysteresis	0 dB
-Time to trigger	0 ms
-Reporting cell status (10.3.7.61)	
-CHOICE reported cell	Report cells within active set or within virtual active set or of the other RAT
-Maximum number of reported cells	2
<b>Physical channel information elements</b>	
-DPCH compressed mode status info (10.3.6.34)	Not Present

First MEASUREMENT REPORT message (step 6)

Information Element	Value/remark
Message Type (10.2.17)	
Integrity check info	Not Present
Measurement identity	1
Measured Results (10.3.7.44)	
-CHOICE Measurement	Inter-frequency Measured results list
-Inter-frequency measured results	1
-Frequency info	
-CHOICE <i>mode</i>	GSM
-UARFCN uplink (Nu)	Not Present

-UARFCN downlink (Nd) -UTRA carrier RSSI Event results (10.3.7.7) -CHOICE event result -Inter-frequency event identity -Inter-frequency cells	Same frequency as channel 2 Not Present  Inter-frequency measurement event results 3C 1
--	--

## Second MEASUREMENT REPORT message (step 8)

Information Element	Value/remark
Message Type (10.2.17)	
Integrity check info	Not Present
Measurement identity	1
Measured Results (10.3.7.44)	
-CHOICE Measurement	Inter-frequency Measured results list
-Inter-frequency measured results	1
-Frequency info	
-CHOICE <i>mode</i>	GSM
-UARFCN uplink (Nu)	Not Present
-UARFCN downlink (Nd)	Same frequency as channel 2
-UTRA carrier RSSI	Not Present
Event results (10.3.7.7)	
-CHOICE event result	Inter-frequency measurement event results
-Inter-frequency event identity	3B
-Inter-frequency cells	1

## 8.6.4.1.2.6 Test requirements

## 8.6.4.1.2.6.1 Test 1

The UE shall send one Event 3C triggered measurement report for cell 2, with a measurement reporting delay less than 6.04s from the beginning of time period T2.

The UE shall send one Event 3B triggered measurement report for cell 2, with a measurement reporting delay less than 1040 ms from the beginning of time period T3.

The UE shall not send event triggered measurement reports, as long as the reporting criteria are not fulfilled.

The rate of events correctly reported during repeated tests shall be at least 90%.

## 8.6.4.1.2.6.2 Test 2

The UE shall send one Event 3C triggered measurement report for cell 2, with a measurement reporting delay less than 1040ms from the beginning of time period T2.

The UE shall send one Event 3B triggered measurement report for cell 2, with a measurement reporting delay less than 1040 ms from the beginning of time period T3.

The UE shall not send event triggered measurement reports, as long as the reporting criteria are not fulfilled.

The rate of events correctly reported during repeated tests shall be at least 90%.

## 8.6.4.1.3 7,68 Mcps TDD option

## 8.6.4.1.3.1 Definition and applicability

.In the event triggered reporting period the measurement reporting delay is defined as the time between any event that will trigger a measurement report until the UE starts to transmit over the Uu interface. This requirement assumes that the measurement report is not delayed by other RRC signalling on the DCCH. This measurement reporting delay excludes a delay uncertainty resulted when inserting the measurement report to the TTI of the uplink DCCH. The delay uncertainty is twice the TTI of the uplink DCCH. The purpose of this test is to verify that the UE makes correct reporting of an event when doing inter frequency measurements on a neighbouring GSM cell. The test will partly verify the requirements in section 8.4 of [2].

The requirements and this test apply to the combined GSM and TDD (7,68Mcps option) UE.

## 8.6.4.1.3.2 Minimum requirement

The purpose of this test is to verify that the UE makes correct reporting of an event when doing inter-RAT GSM measurements.

## 8.6.4.1.3.3 Test purpose

To verify that the UE meets the minimum time requirements for identifying neighbouring GSM cells.

## 8.6.4.1.3.4 Method of test

## 8.6.4.1.3.4.1 Initial conditions

Test environment: normal; see clauses G.2.1 and G.2.2.

Frequencies to be tested: mid range; see clause G.2.4.

Two cells shall be present in the test, Cell 1 is current active TDD cell, cell 2 is a GSM cell. The test consists of three successive time periods, with a time duration of T1, T2 and T3 respectively. The test parameters are given in Tables 8.6.4.1.3.4.1.1, 8.6.4.1.3.4.1.2 and 8.6.4.1.3.4.1.3 below. In the measurement control information it is indicated to the UE that event-triggered reporting with Event 3B and 3C shall be used. At the start of time duration T1, the UE may not have any timing information of cell 2. The power level of cell 2 is increased and then reduced, and a measurement report should be triggered at each transition.

**Table 8.6.4.1.3.4.1.1: General test parameters for correct reporting of GSM neighbours in AWGN propagation condition**

Parameter	Unit	Value	Comment
DCH parameters		DL Reference Measurement Channel 12.2 kbps	As specified in TS 25.102 section A.2.2
Power Control		On	
Target quality value on DTCH	BLER	0.01	
Active cell		Cell 1	
Inter-RAT measurement quantity		GSM carrier RSSI	
BSIC verification required		Required	
Threshold other system	dBm	-80	Absolute GSM carrier RSSI threshold for Events 3B and 3C.
Hysteresis	dB	0	
Time to Trigger	ms	0	
Filter coefficient		0	
Monitored cell list size		12 TDD neighbours on Channel 1 6 GSM neighbours including ARFCN 1	Measurement control information is sent before the start of time period T1.
T <sub>identify abort</sub>	s	5	As specified in section 8.1.2B.5 of [2]
T <sub>reconfirm abort</sub>	s	5	As specified in section 8.1.2B.5 of [2]
T1	s	10	
T2	s	10	
T3	s	10	

**Table 8.6.4.1.3.4.1.2: Cell specific parameters for correct reporting of GSM neighbours in AWGN propagation condition (cell 1)**

Parameter	Unit	Cell 1	
		T1, T2, T3	
DL timeslot number		0	1
UTRA RF Channel number		Channel 1	
PCCPCH_Ec/lor	dB	-3	n.a.
SCH_Ec/lor	dB	-9	n.a.
SCH_offset		0	n.a.
OCNS_Ec/lor	dB	-3,12	Note 2
DPCH_Ec/lor	dB	n.a.	Note 1
lor/loc	dB	6	6
Io, Note 1	dBm / 7.68 MHz	-70	
Propagation condition		AWGN	
Note 1: The DPCH level is controlled by the power control loop			
Note 2: The power of the OCNS channel that is added shall make the total power from the cell to be equal to lor.			

**Table 8.6.4.1.3.4.1.3: Cell specific parameters for correct reporting of GSM neighbours in AWGN propagation condition (cell 2)**

Parameter	Unit	Cell 2		
		T1	T2	T3
Absolute RF Channel Number		ARFCN 1		
RXLEV	dBm	-85	-75	-85

**8.6.4.1.3.4.2 Test Procedure**

- 1) The RF parameters are set up according to test T1.( see Table 8.6.4.1.3.4.1.2 and Table 8.6.4.1.3.4.1.3)
- 2) The UE is switched on.
- 3) A call is set up according to the generic set-up procedure specified in TS 34.108 [3] subclause 7.4.2 to place the UE in CELL\_DCH.
- 4) SS shall transmit the MEASUREMENT CONTROL message.
- 5) After 5seconds from the beginning of T1, the SS shall switch the GSM level setting from T1 to T2.
- 6) UE shall transmit a MEASUREMENT REPORT message triggered by event 3C for cell 2. The measurement reporting delay from the beginning of T2 shall be less than 1040ms. If the UE fails to report the event within the required delay, then a failure is recorded. If the reporting delay for this event is within the required limit, the number of successful tests is increased by one.
- 7) After 7seconds from the beginning of T2, the SS shall switch the GSM level setting from T2 to T3.
- 8) UE shall transmit a MEASUREMENT REPORT message triggered by event 3B for cell 2. The measurement reporting delay from the beginning of T3 shall be less than 1040ms. If the UE fails to report the event within the required delay, then a failure is recorded. If the reporting delay for this event is within the required limit, the number of successful tests is increased by one.
- 9) After the SS receives the measurement report message in step 8 ) or 5 seconds from the beginning of T3, the UE is switched off. Any timing information of cell 2 is deleted in the UE.
- 11) Repeat steps 1-until the confidence level according to annex F.6.2 is achieved.

**Specific Message Contents**

All messages indicated above shall use the same content as described in the default message content in clause 9 of 34.108 [3] with the following exceptions.:

Note: Numbers in brackets after an item e.g “Message Type (10.2.17)” in the IE description are references to clause numbers in TS 25.331 [9] describing that item in more detail.

MEASUREMENT CONTROL message (step 4):

Information Element/Group name	Value/Remark
Message Type (10.2.17)	
<b>UE information elements</b>	
-RRC transaction identifier	0
-Integrity check info	
<b>Measurement Information elements</b>	
-Measurement Identity	2
-Measurement Command (10.3.7.46)	Setup
-Measurement Reporting Mode (10.3.7.49)	
-Measurement Report Transfer Mode	AM RLC
-Periodical Reporting / Event Trigger Reporting Mode	Event trigger
-Additional measurements list (10.3.7.1)	Not Present
-CHOICE <i>Measurement type</i>	Inter-RAT measurement
-Inter-RAT measurement (10.3.7.27)	
-Inter-RAT measurement objects list (10.3.7.23)	Not Present
-Inter-RAT measurement quantity (10.3.7.29)	
-Measurement quantity for UTRAN quality estimate (10.3.7.38)	
-Filter coefficient	0
-CHOICE mode	TDD
-Measurement quantity	PCCPCH_RSCP
-CHOICE system	GSM
-Measurement quantity	GSM Carrier RSSI
-Filter coefficient	0
-BSIC verification required	Required
-Inter-RAT reporting quantity (10.3.7.32)	Not Present
-Reporting cell status (10.3.7.61)	Not Present
-CHOICE report criteria	Inter-RAT measurement reporting criteria
-Inter-RAT measurement reporting criteria (10.3.7.30)	
-Parameters required for each event	2
-Inter-RAT event identity (10.3.7.24)	Event 3B
-Threshold own system	Not Present
-W	Not Present
-Threshold other system	-80 dBm
-Hysteresis	0 dB
-Time to trigger	0 ms
-Reporting cell status (10.3.7.61)	
-CHOICE reported cell	Report cells within active set or within virtual active set or of the other RAT
-Maximum number of reported cells	2
-Inter-RAT event identity (10.3.7.24)	Event 3C
-Threshold own system	Not Present
-W	Not Present
-Threshold other system	-80 dBm
-Hysteresis	0 dB
-Time to trigger	0 ms
-Reporting cell status (10.3.7.61)	
-CHOICE reported cell	Report cells within active set or within virtual active set or of the other RAT
-Maximum number of reported cells	2
<b>Physical channel information elements</b>	
-DPCH compressed mode status info (10.3.6.34)	Not Present

First MEASUREMENT REPORT message (step 6)

Information Element	Value/remark
Message Type (10.2.17)	
Integrity check info	Not Present
Measurement identity	1
Measured Results (10.3.7.44)	
-CHOICE Measurement	Inter-frequency Measured results list
-Inter-frequency measured results	1
-Frequency info	
-CHOICE mode	GSM
-UARFCN uplink (Nu)	Not Present
-UARFCN downlink (Nd)	Same frequency as channel 2
-UTRA carrier RSSI	Not Present
Event results (10.3.7.7)	
-CHOICE event result	Inter-frequency measurement event results
-Inter-frequency event identity	3C
-Inter-frequency cells	1
Inter-RAT cell info indication	Not present

Second MEASUREMENT REPORT message (step 8)

Information Element	Value/remark
Message Type (10.2.17)	
Integrity check info	Not Present
Measurement identity	1
Measured Results (10.3.7.44)	
-CHOICE Measurement	Inter-frequency Measured results list
-Inter-frequency measured results	1
-Frequency info	
-CHOICE mode	GSM
-UARFCN uplink (Nu)	Not Present
-UARFCN downlink (Nd)	Same frequency as channel 2
-UTRA carrier RSSI	Not Present
Event results (10.3.7.7)	
-CHOICE event result	Inter-frequency measurement event results
-Inter-frequency event identity	3B
-Inter-frequency cells	1
Inter-RAT cell info indication	Not present

#### 8.6.4.1.3.4.3 Method of test

The UE shall send one Event 3C triggered measurement report for cell 2, with a measurement reporting delay less than 1040 ms from the start of time period T2.

The UE shall send one Event 3B triggered measurement report for cell 2, with a measurement reporting delay less than 1040 ms from the start of time period T3.

The UE shall not send any Event 3B or 3C triggered measurement reports, as long as the reporting criteria are not fulfilled.

The rate of correct events observed during repeated tests shall be at least 90%.

#### 8.6.4.2 Combined UTRA TDD inter-frequency and GSM Cell search under AWGN propagation condition

*Editor's note: This section is incomplete. The following aspects are either missing or not yet determined:*

- The Test system uncertainties applicable to this test are undefined
- The Test tolerances applicable to this test are undefined



## 8.6.4.2.2 1.28 Mcps TDD option

### 8.6.4.2.2.1 Definition and applicability

In the event triggered reporting period the measurement reporting delay is defined as the time between any event that will trigger a measurement report until the UE starts to transmit over the Uu interface. This requirement assumes that the measurement report is not delayed by other RRC signalling on the DCCH. This measurement reporting delay excludes a delay uncertainty resulted when inserting the measurement report to the TTI of the uplink DCCH.

The requirements and this test apply to the combined GSM and TDD (1,28Mcps option) UE.

### 8.6.4.2.2.2 Minimum requirement

This test is to verify that the UE makes correct reporting of an event when doing inter frequency measurements and GSM measurements.

### 8.6.4.2.2.3 Test Purpose

This test is to verify that the UE makes correct reporting of an event when doing inter frequency measurements and GSM measurements. The test will partly verify the requirements in TS 25.123 section 8.1A.2.3 combined 8.1A.2.6 [2] under AWGN propagation conditions.

### 8.6.4.2.2.4 Method of test

This test scenario comprised of 2 UTRA TDD cells working on different frequency, and 1 GSM cell. Test parameters are given in Table 8.6.4.2.2.1, 8.6.4.2.2.2, and 8.6.4.2.2.3. Scheduled idle interval of 80ms period as defined in TS25.331 is provided. Two UTRA TDD cells shall be synchronized, i.e. sharing the same frame and timeslot timing.

The test consists of 3 successive time periods, with time duration T1, T2 and T3. In the measurement control information it is indicated to the UE that event-triggered reporting with Event 2C and 3C shall be used.

**Table 8.6.4.2.2.1: General test parameters for combined UTRA TDD inter-frequency and GSM cells search under AWGN propagation conditions**

Parameter	Unit	Value	Comment
DPCCH parameters active cell		DL Reference Measurement Channel 12.2 kbps	As specified in TS 25.102 section A.2.2.
Power Control		On	
Target quality value on DTCH	BLER	0.01	
Active cell		Cell 1	1.28Mcps TDD cell operating on channel 1
Neighbour cell		Cell 2	1.28Mcps TDD cell operating on channel 2
		Cell 3	GSM cell
$T_{\text{non used 2c}}$	dBm	-71	Absolute P-CCPCH RSCP threshold for event 2C
Inter-RAT measurement quantity		GSM carrier RSSI	
BSIC verification required		Required	
$T_{\text{other\_RAT}}$	dBm	-80	Absolute GSM carrier RSSI threshold for event 3C
$H_{2c}$	dB	0	The hysteresis parameter for the event 2C
$H_{3c}$	dB	0	The hysteresis parameter for the event 3C
TimeToTrigger	ms	0	
Filter coefficient		0	L3 filtering is not used
Monitored cell list size		16 TDD neighbour on channel 1 6 GSM neighbours including ARFCN 1	
Propagation Condition		AWGN	
T1	s	5	During T1, cell 2 and cell 3 shall be powered off.
T2	s	6	
T3	s	8	

**Table 8.6.4.2.2.2: Cell specific test parameters for combined UTRA TDD inter-frequency and E-UTRA FDD cell search under fading propagation conditions (cell 1 and cell 2)**

Parameter	Unit	Cell 1 (UTRA)						Cell 2 (UTRA)						
		0			DwPTS			0			DwPTS			
Timeslot Number		T1	T2	T3	T1	T2	T3	T1	T2	T3	T1	T2	T3	
UTRA RF Channel Number*		Channel 1						Channel 2						
PCCPCH_Ec/I <sub>or</sub>	dB	-3						-3						
DwPCH_Ec/I <sub>or</sub>	dB				0						0			
OCNS_Ec/I <sub>or</sub>	dB	-3						-3						
$\hat{I}_{or}/I_{oc}$	dB	3		3				-	Infin	ity	6			
$I_{oc}$	dBm/ 1.28 MHz	-70						-70						
PCCPCH RSCP	dBm	-70						-	Infin	ity	-67			
Propagation Condition		AWGN												

**Table 8.6.4.2.2.3: Cell specific test parameters for combined UTRA TDD inter-frequency and GSM cell search under AWGN propagation conditions (cell 3)**

Parameter	Unit	Cell 3		
		T1	T2	T3
Absolute RF Channel Number		ARFCN 1		
RXLEV	dBm	-Infinity		-75

**8.6.4.2.2.5 Test Procedure**

- 1) The RF parameters are set up according to test T1.( see Table 8.6.6.1.2.2 and Table 8.6.6.1.2.2).
- 2) The UE is switched on.
- 3) A call is set up according to the generic set-up procedure specified in TS 34.108 [3] subclause 7.4.2 to place the UE in CELL\_DCH.
- 4) SS shall transmit the MEASUREMENT CONTROL message(inter frequency).
- 5) SS shall transmit the MEASUREMENT CONTROL message(event triggered inter RAT).
- 6) After 5seconds from the beginning of T1, the SS shall switch the power setting of cell 2 from T1 to T2.
- 7) UE shall transmit a MEASUREMENT REPORT message triggered by event 2C for cell 2. The measurement reporting delay from the beginning of T2 shall be less than 5.04s. If the UE fails to report the event within the required delay, then a failure is recorded. If the reporting delay for this event is within the required limit, the number of successful tests is increased by one.
- 8) After 6seconds from the beginning of T2, the SS shall switch the GSM level setting from T2 to T3.
- 9) UE shall transmit a MEASUREMENT REPORT message triggered by event 3C for cell 2. The measurement reporting delay from the beginning of T3 shall be less than 6.04s. If the UE fails to report the event within the required delay, then a failure is recorded. If the reporting delay for this event is within the required limit, the number of successful tests is increased by one.
- 10) After the SS receives the measurement report message in step 8 ) or 8 seconds from the beginning of T3, the UE is switched off. Any timing information of cell 2 and cell 3 is deleted in the UE.
- 11) Repeat steps 1-9 according to Annex F.6.2 Table F.6.2.8.

**Specific Message Contents**

All messages indicated above shall use the same content as described in the default message content in clause 9 of 34.108 [3] with the following exceptions:

## MEASUREMENT CONTROL (Step 4)

Information Element/Group name	Value/Remark
Message Type	
UE information elements -RRC transaction identifier -Integrity check info	0 Not Present
Measurement Information elements -Measurement Identity -Measurement Command -Measurement Reporting Mode -Measurement Report Transfer Mode -Periodical Reporting / Event Trigger Reporting Mode -Additional measurements list	1 Modify  AM RLC Event trigger Not Present
-CHOICE <i>Measurement type</i> -Inter-frequency measurement -Inter-frequency measurement objects list -CHOICE inter-frequency cell removal -New inter-frequency cells -Inter-frequency cell id -Frequency info -CHOICE mode -UARFCN(Nt) -Cell info -Cell individual offset -Reference time difference to cell -Read SFN indicator -CHOICE mode -Primary CCPCH info -CHOICE mode -CHOICE TDD option -cell parameters ID -SCTD indicator -Primary CCPCH Tx power  -Timeslot list -Cell selection and re-selection info -Cell for measurement -Inter-frequency measurement quantity -CHOICE reporting criteria -Filter coefficient -CHOICE mode -Measurement quantity for frequency quality estimate	Inter-frequency measurement  No inter-frequency cells removed 1 1  TDD Same frequency as channel 2  Not Present Not Present False TDD  TDD 1,28 Mcps TDD Set to cell parameters ID of cell 2 FALSE Set to Primary CCPCH Tx power of cell 2 as described in Table 8.6.2.1.2 Not Present Not Present Not Present  Inter-frequency reporting criteria 0 TDD Primary CCPCH RSCP
-Inter-frequency reporting quantity	
-UTRA carrier RSSI	FALSE
-Frequency quality estimate	FALSE
-Non frequency related cell reporting quantities	
-SFN-SFN observed time difference reporting indicator	No report
-Cell synchronisation information reporting indicator	FALSE
-Cell identity reporting indicator	FALSE
-CHOICE mode -Timeslot ISCP reporting indicator -Proposed TGSN Reporting required -Primary CCPCH RSCP reporting indicator -Pathloss reporting indicator	TDD FALSE FALSE TRUE FALSE
-Reporting cell status -Measurement validity -CHOICE <i>report criteria</i>  -Inter-frequency measurement reporting criteria -Parameters required for each event	Not Present Not Present Inter-frequency measurement reporting criteria  1
-Inter-frequency event identity -Parameters required for each non-used frequenc - Threshold non-used frequency - W non-used frequency	Event 2C  -71 1
Physical channel information elements -DPCH compressed mode status info	Not Present

## MEASUREMENT CONTROL (Step 5)

Information Element/Group name	Value/Remark
Message Type	
<b>UE information elements</b>	
-RRC transaction identifier	0
-Integrity check info	No present
<b>Measurement Information elements</b>	
-Measurement Identity	2
-Measurement Command	Setup
-Measurement Reporting Mode	
-Measurement Report Transfer Mode	AM RLC
-Periodical Reporting / Event Trigger Reporting Mode	Event trigger
-Additional measurements list	Not Present
-CHOICE <i>Measurement type</i>	Inter-RAT measurement
-Inter-RAT measurement	
-Inter-RAT measurement objects list	Not Present
-Inter-RAT measurement quantity	
-Measurement quantity for UTRAN quality estimate	
-Filter coefficient	0
-CHOICE mode	TDD
-Measurement quantity	PCCPCH RSCP
-CHOICE system	GSM
-Measurement quantity	GSM Carrier RSSI
-Filter coefficient	0
-BSIC verification required	Required
-Inter-RAT reporting quantity	
- UTRAN estimated quality	FALSE
- CHOICE system	GSM
- Observed time difference to GSM cell reporting indicator	FALSE
- GSM Carrier RSSI reporting indicator	TRUE
-Reporting cell status	Not Present
-CHOICE report criteria	Inter-RAT measurement reporting criteria
-Inter-RAT measurement reporting criteria	
-Inter-RAT event identity	Event 3C
-Threshold other system	-80
-Hysteresis	0 dB
-Time to trigger	0 ms
-Reporting cell status	
-CHOICE reported cell	Report cells within active set or within virtual active set or of the other RAT
-Maximum number of reported cells	2
<b>Physical channel information elements</b>	
-DPCH compressed mode status info	Not present.

## MEASUREMENT REPORT (Step 7)

Information Element	Value/remark
Message Type	Not Present
Integrity check info	1
Measurement identity	1
Measured Results	Inter-frequency Measured results list
-CHOICE Measurement	1
-Inter-frequency measured results	1
-Frequency info	TDD
-CHOICE <i>mode</i>	Same frequency as channel 2
-UARFCN(Nt)	Not Present
-UTRA carrier RSSI	Not Present
-Inter-frequency cell measured results	1
-Cell measured results	Not Present
-Cell identity	Not Present
-SFN-SFN observed time difference	Not Present
-Cell synchronisation info	Not Present
-CHOICE mode	TDD
-Cell parameters ID	Set to cell parameters ID of Cell 2
-Proposed TGSN	Not Present
-Primary CCPCH RSCP	Checked that this IE is present
-Pathloss	Not Present
-Timeslot list	Not Present
Measured results on RACH	Not Present
Additional measured results	Not Present
Event results	Not Present
-CHOICE event result	Inter-frequency measurement event results
-Inter-frequency event identity	2C
-Inter-frequency cells	1
-Frequency Info	TDD
-CHOICE <i>mode</i>	Same frequency as channel 2
-UARFCN(Nt)	Same frequency as channel 2
-Non frequency related measurement event results	TDD
-CHOICE mode	TDD
-Primary CCPCH Info	TDD
-CHOICE mode	TDD
-CHOICE TDD Option	1.28 Mcps TDD
-TSTD indicator	TRUE
-Cell Parameters ID	Set to cell parameters ID of Cell 2
-SCTD Indicator	FALSE

## MEASUREMENT REPORT(Step 9)

Information Element	Value/remark
Message Type	Not Present
Integrity check info	2
Measurement identity	2
Event results	Inter-RAT measurement event results
-CHOICE event result	3C
-Inter-frequency event identity	3C
- CHOICE <i>BSIC</i>	3C
- Non verified BSIC	3C
- BCCH ARFCN	Same as cell 3

## 8.6.4.2.2.6 Test Requirement

The UE shall send one Event 2C triggered measurement report, with a measurement reporting delay less than 5080ms from the beginning of time period T2.

The UE shall send one Event 3C triggered measurement report for cell 3, with a measurement reporting delay less than 6040ms from the beginning of time period T3.

The UE shall not send event triggered measurement reports, as long as the reporting criteria are not fulfilled.

The rate of events correctly reported during repeated tests shall be at least 90%.

## 8.6.5 E-UTRA measurements

### 8.6.5.1 UTRA TDD to E-UTRA FDD cell search under fading propagation conditions

#### 8.6.5.1.1 Definition and applicability

8.6.5.1.1.1 3,84 Mcps TDD Option

8.6.5.1.1.2 1,28 Mcps TDD Option

The purpose of this test is to verify that the UE makes correct reporting of an event when measuring on E-UTRA FDD cells. This test will partly verify the E-UTRA FDD cell search requirements in TS 25.123 [2] section 8.1A.2.6 under fading propagation conditions.

The requirements and this test apply to the combined TDD (1.28 Mcps option) and E-UTRA FDD UE of Release 8 and later.

8.6.5.1.1.3 7,68 Mcps TDD Option

#### 8.6.5.1.2 Minimum requirement

8.6.5.1.2.1 3,84 Mcps TDD Option

8.6.5.1.2.2 1,28 Mcps TDD Option

The requirements in this section apply only to UEs supporting 1.28Mcps TDD and E-UTRAN FDD.

1) For a UE requiring idle intervals to perform E-UTRAN FDD measurements:

- a minimum idle interval of 6ms shall be scheduled by the network.
- when signalled by UTRAN, the UE shall continuously measure previously detected E-UTRAN FDD cells and search for new E-UTRAN FDD cells.

2) For a UE not requiring idle intervals to perform E-UTRAN FDD measurements:

- the UE shall measure either all E-UTRAN FDD cells present in the monitored set or, if only frequencies are provided in the neighbour cell list, the strongest cells present in the detected set, up to the monitoring capabilities of the UE.
- the relevant requirements for E-UTRAN FDD dedicated mode when a [TBD] channel is assigned in 3GPP TS 36.133 [26] shall apply. This is further detailed in the following subclauses.

When idle intervals are used for E-UTRAN FDD measurements, the UE shall be able to identify a new detectable E-UTRAN FDD cell within

$$T_{\text{Identify E-UTRAN FDD}} = T_{\text{Basic\_Identify\_E-UTRAN FDD}} \cdot \frac{T_{\text{Measurement\_Period\_E-UTRAN FDD}}}{T_{\text{E-UTRAN FDD}}} \quad \text{ms};$$

If the UE does not need idle intervals to perform E-UTRAN FDD measurements, the UE shall be able to identify a new detectable E-UTRAN FDD cell within  $T_{\text{Basic\_Identify\_E-UTRAN FDD}}$  ms.

Where:

$T_{\text{E-UTRAN FDD}}$ : This is the minimum time that is available for E-UTRAN FDD measurements during the measurement period  $T_{\text{Measurement\_Period\_E-UTRAN FDD}}$  with an arbitrarily chosen timing. The minimum time per idle interval is calculated by assuming  $2 \cdot 0.5$  ms for implementation margin.

$$T_{\text{Basic\_Identify\_E-UTRAN FDD}} = 480 \text{ ms}$$

When L3 filtering is used an additional delay can be expected.

An E-UTRAN FDD cell shall be considered detectable when:

- RSRP related side condition given in Section 9.1 of TS 36.133 [26] are fulfilled for a corresponding Band<sub>2</sub>,
- $SCH\_RP|_{dBm} \geq -127$  dBm for Bands 1, 4, 6, 10, defined in TS 36.101 [27] and  $SCH\_E_s/I_{ot} \geq -4$  dB,
- $SCH\_RP|_{dBm} \geq -126$  dBm for Band 9 defined in [26] and  $SCH\_E_s/I_{ot} \geq -4$  dB,
- $SCH\_RP|_{dBm} \geq -125$  dBm for Bands 2, 5, 7, 11, 17 defined in TS 36.101 [27] and  $SCH\_E_s/I_{ot} \geq -4$  dB,
- $SCH\_RP|_{dBm} \geq -124$  dBm for Bands 3, 8, 12, 13, 14 defined in TS 36.101 [27] and  $SCH\_E_s/I_{ot} \geq -4$  dB.

When idle intervals are scheduled for E-UTRAN FDD measurements the UE physical layer shall be capable of reporting measurements to higher layers with measurement accuracy as specified in TS 25.123 [2] sub-clause 9.1.1.5a and 9.1.1.5b with measurement period of  $T_{Measurement\_Period\_E-UTRAN\_FDD} = 480 \times N_{Freq}$  ms where  $N_{Freq}$  is the number of FDD frequencies indicated in the E-UTRAN measurement control information.

The UE shall be capable of performing RSRP measurements of at least 4 E-UTRAN FDD cells per E-UTRAN FDD frequency for up to 3 FDD E-UTRAN frequencies.

Reported measurements contained in periodically triggered measurement reports shall meet the requirements in TS 25.123 [2] section 9.

Reported measurements contained in event triggered measurement reports shall meet the requirements in TS 25.123 [2] section 9.

The UE shall not send any event triggered measurement reports, as long as no reporting criteria are fulfilled.

The measurement reporting delay is defined as the time between an event that will trigger a measurement report and the point when the UE starts to transmit the measurement report over the air interface. This requirement assumes that the measurement report is not delayed by other RRC signalling on the DCCH. This measurement reporting delay excludes a delay uncertainty resulted when inserting the measurement report to the TTI of the uplink DCCH. The delay uncertainty is:  $[2] \times TTI_{DCCH}$ . This measurement reporting delay excludes a delay which caused by no UL resources for UE to send the measurement report.

The event triggered measurement reporting delay, measured without L3 filtering shall be less than  $T_{identify\_E-UTRAN\_FDD}$  defined in TS 25.123 [2] Section 8.1A.2.6.1. When L3 filtering is used an additional delay can be expected.

If a cell has been detectable at least for the time period  $T_{identify\_E-UTRAN\_FDD}$  and then enters or leaves the reporting range, the event triggered measurement reporting delay shall be less than  $T_{Measurement\_Period\_E-UTRAN\_FDD}$  provided the timing to that cell has not changed more than [FFS] while idle interval has not been available and the L3 filter has not been used.

The normative reference for this requirement is TS 25.123 [2] clause 8.1A.2.6 and A.8.5.1.

8.6.5.1.2.3            7,68 Mcps TDD Option

8.6.5.1.3            Test purpose

8.6.5.1.3.1           3,84 Mcps TDD Option

8.6.5.1.3.2           1,28 Mcps TDD Option

To verify that the UE makes correct reporting of an event when measuring on E-UTRA FDD cells.

8.6.5.1.3.3           7,68 Mcps TDD Option

8.6.5.1.4            Method of test

8.6.5.1.4.1           3,84 Mcps TDD Option

8.6.5.1.4.2           1,28 Mcps TDD Option

8.6.5.1.4.2.1        Initial conditions

Test environment : normal; see clauses G.2.1 and G.2.2.

Frequencies to be tested : mid range ;see clauses G.2.4.



This test scenario comprised of 1 UTRA TDD serving cell, and 1 E-UTRA FDD cell to be searched. Test parameters are given in Table 8.6.5.1.4.2.1-1, 8.6.5.1.4.2.1-2, and 8.6.5.1.4.2.1-3. Idle interval of 80ms period as defined in TS25.331 [9] is provided.

In the measurement control information, it is indicated to the UE that event-triggered reporting with Event 3c is used. The test consists of two successive time periods, with time duration of T1 and T2 respectively.

**Table 8.6.5.1.4.2.1-1: General test parameters for UTRA TDD to E-UTRA FDD cell search under fading propagation conditions**

Parameter	Unit	Value	Comment
DPCH parameters active cell		DL Reference Measurement Channel 12.2 kbps	As specified in TS 25.102 section A. The DPCH is located in an other timeslot than 0.
Active cell		Cell 1	1.28Mcps TDD cell
Neighbour cell		Cell 2	E-UTRA FDD cell
CP length of cell 2		normal	
Idle intervals period	ms	80	As specified in TS 25.331 [9]
$T_{\text{other\_RAT}}$	dBm	-98	Absolute RSRP threshold for event 3c
$CIO_{\text{other\_RAT}}$	dB	0	Cell individual offset
$H_{3c}$	dB	0	Hysteresis parameter for event 3c
TimeToTrigger	dB	0	
Filter coefficient		0	L3 filtering is not used
T1	s	5	During T1, cell 2 shall be powered off, and during the off time the physical layer cell identity shall be changed.
T2	s	10	

**Table 8.6.5.1.4.2.1-2: Cell specific test parameters for cell search UTRA TDD to E-UTRA FDD test case (cell 1)**

Parameter	Unit	Cell 1 (UTRA)			
		0		DwPTS	
Timeslot Number		T1	T2	T1	T2
UTRA RF Channel Number*		Channel 1			
PCCPCH_Ec/lor	dB	-3	-3		
DwPCH_Ec/lor	dB			0	0
OCNS_Ec/lor	dB	-3	-3		
$\hat{I}_{or} / I_{oc}$	dB	3	3	3	3
$I_{oc}$	dBm/1.28 MHz	-70			
PCCPCH RSCP	dBm	-70	-70	n.a.	n.a.
Propagation Condition		Case 3			
* Note: In the case of multi-frequency cell, the UTRA RF Channel Number is the primary frequency's channel number.					

**Table 8.6.5.1.4.2.1-3: Cell specific test parameters for cell search UTRA TDD to E-UTRA FDD test case (cell 2)**

Parameter	Unit	Cell 2	
		T1	T2
E-UTRA RF Channel Number		2	
$BW_{channel}$	MHz	10	
OCNG Pattern defined in A.3.2.1.2 (OP.2 FDD) in [24]		OP.2 FDD	OP.2 FDD
PBCH_RA	dB	0	0
PBCH_RB	dB		
PSS_RB	dB		
SSS_RB	dB		
PCFICH_PA	dB		
PHICH_PA	dB		
PHICH_PB	dB		
PDCCH_PA	dB		
PDCCH_PB	dB		
PDSCH_PA	dB		
PDSCH_PB	dB		
OCNG_RA <sup>Note1</sup>	dB		
OCNG_RB <sup>Note1</sup>	dB		
$\hat{E}_s / N_{oc}$	dB		
$N_{oc}$	dBm/15kHz	-98	
$\hat{E}_s / I_{ot}$	dB	-Infinity	9
RSRP	dBm/15kHz	-Infinity	-89
SCH_RP	dBm/15kHz	-Infinity	-89
Propagation Condition		ETU70	
Note 1: OCNG shall be used such that cell is fully allocated and a constant total transmitted power spectral density is achieved for all OFDM symbols.			
Note 2: The resources for uplink transmission are assigned to the UE prior to the start of time period T2.			

**8.6.5.1.4.2.2 Test Procedure**

- 1) The RF parameters are set up according to T1.
- 2) The UE is switched on.
- 3) A call is set up according to the generic set-up procedure specified in TS 34.108 [3] subclause 7.4.2 to place the UE in CELL\_DCH.
- 4) SS shall transmit a MEASUREMENT CONTROL message.
- 5) After 5 seconds from the beginning of T1, the SS shall switch the E-UTRA FDD Cell 2 power settings from T1 to T2.
- 6) UE shall transmit a MEASUREMENT REPORT message triggered by event 3c for Cell 2. The measurement reporting delay from the beginning of T2 shall be less than 7.7s. If the UE fails to report the event within the required delay, then a failure is recorded. If the reporting delay for this event is within the required limit, the number of successful tests is increased by one.
- 7) After 10 seconds from the beginning of T2, the UE is switched off. Any timing information of cell 2 is deleted in the UE.
- 8) Repeat steps 1-7 until the confidence level according to annex F.6.2 is achieved.

**Specific Message Contents**

All messages indicated above shall use the same content as described in the default message content in clause 9 of 34.108 [3] and in Annex A of 34.123-1 [21], with the following exceptions:

NOTE: Numbers in brackets after an item e.g “Message Type (10.2.17)” in the IE description are references to clause numbers in TS 25.331 [9] describing that item in more detail.

MEASUREMENT CONTROL message (step 4):

Information Element/Group name	Value/Remark
Message Type (10.2.17)	
<b>UE information elements</b>	
-RRC transaction identifier	0
-Integrity check info	
<b>Measurement Information elements</b>	
-Measurement Identity	1
-Measurement Command (10.3.7.46)	Setup
-Measurement Reporting Mode (10.3.7.49)	
-Measurement Report Transfer Mode	AM RLC
-Periodical Reporting / Event Trigger Reporting Mode	Event trigger
-Additional measurements list (10.3.7.1)	Not Present
-CHOICE <i>Measurement type</i>	Inter-RAT measurement
-Inter-RAT measurement (10.3.7.27)	
-Inter-RAT measurement objects list (10.3.7.23)	Not Present
-Inter-RAT measurement quantity (10.3.7.29)	
-Measurement quantity for UTRAN quality estimate (10.3.7.38)	
-Filter coefficient	0
-CHOICE mode	FDD
-Measurement quantity	Primary CCPCH RSCP
-CHOICE system	E-UTRA
-Measurement quantity	RSRP
-Filter coefficient	0
-Inter-RAT reporting quantity (10.3.7.32)	
-UTRAN estimated quality	FALSE
-CHOICE system	E-UTRA
- Reporting quantity	'measurement_quantity'
-Reporting cell status (10.3.7.61)	Not Present
-CHOICE report criteria	Inter-RAT measurement reporting criteria
-Inter-RAT measurement reporting criteria (10.3.7.30)	
-Parameters required for each event	1
-Inter-RAT event identity (10.3.7.24)	3c
-Threshold own system	Not Present
-W	Not Present
-Threshold other system	-98 dBm
-Hysteresis	0 dB
-Time to trigger	0 ms
-Reporting cell status (10.3.7.61)	
-CHOICE reported cell	Report cells within active set or within virtual active set or of the other RAT
-Maximum number of reported cells	2
<b>Physical channel information elements</b>	
-DPCH compressed mode status info (10.3.6.34)	Not Present

## MEASUREMENT REPORT message (step 6)

Information Element	Value/remark
Message Type (10.2.17)	
Integrity check info	Not Present
Measurement identity	1
E-UTRA Measured Results (10.3.7.6c)	
- E-UTRA measured results list	1
- E-UTRA Carrier Frequency	Carrier Frequency of Cell 2
-Measured E-UTRA cells	1
-Physical Cell Identity	Physical cell id of Cell 2
-RSRP	
E-UTRA event results (10.3.7.6a)	
- Inter-RAT event identity	3c
- E-UTRA events results list	1
- E-UTRA Carrier Frequency	Carrier Frequency of Cell 2
- Reported cells	1
- Physical Cell Identity	Physical cell id of Cell 2

8.6.5.1.4.3 7,68 Mcps TDD Option

8.6.5.1.5 Test requirements

8.6.5.1.5.1 3,84 Mcps TDD Option

8.6.5.1.5.2 1,28 Mcps TDD Option

The UE shall send one Event 3c triggered measurement report, with a measurement reporting delay less than 7.7s from the beginning of time period T2.

The UE shall not send event triggered measurement reports, as long as the reporting criteria are not fulfilled.

For the test to pass, the total number of successful tests shall be more than 90% with a confidence level of 95% of the cases.

NOTE: The actual overall delays measured in the test may be up to  $2xTTI_{DCCH}$  higher than the measurement reporting delays above because of TTI insertion uncertainty of the measurement report in DCCH.

8.6.5.1.5.3 7,68 Mcps TDD Option

8.6.5.2 UTRA TDD to E-UTRA TDD cell search under fading propagation conditions

8.6.5.2.1 Definition and applicability

8.6.5.2.1.1 3,84 Mcps TDD Option

8.6.5.2.1.2 1,28 Mcps TDD Option

The purpose of this test is to verify that the UE makes correct reporting of an event when measuring on E-UTRA TDD cells. This test will partly verify the E-UTRA TDD cell search requirements in TS 25.123 [2] section 8.1A.2.7 under fading propagation conditions.

The requirements and this test apply to the combined TDD (1.28 Mcps option) and E-UTRA TDD UE of Release 8 and later.

8.6.5.2.1.3 7,68 Mcps TDD Option

8.6.5.2.2 Minimum requirement

8.6.5.2.2.1 3,84 Mcps TDD Option

8.6.5.2.2.2 1,28 Mcps TDD Option

The requirements in this section apply only to UEs supporting 1.28Mcps TDD and E-UTRAN TDD.

1) For a UE requiring idle intervals to perform E-UTRAN TDD measurements:

- a minimum idle interval of 6ms shall be scheduled by the network.
- when signalled by UTRAN, the UE shall continuously measure previously detected E-UTRAN TDD cells and search for new E-UTRAN TDD cells.

2) For a UE not requiring idle intervals to perform E-UTRAN TDD measurements:

- the UE shall measure either all E-UTRAN TDD cells present in the monitored set or, if only frequencies are provided in the neighbour cell list, the strongest cells present in the detected set, up to the monitoring capabilities of the UE.
- the relevant requirements for E-UTRAN TDD dedicated mode when a [TBD] channel is assigned in 3GPP TS 36.133 [26] shall apply. This is further detailed in the following subclauses.

When idle intervals are used for E-UTRAN measurements, the UE shall be able to identify a new detectable E-UTRAN TDD cell within

$$T_{\text{Identify E-UTRAN TDD}} = T_{\text{Basic\_Identify\_E-UTRAN TDD}} \cdot \frac{T_{\text{Measurement\_Period\_E-UTRAN TDD}}}{T_{\text{E-UTRAN TDD}}} \text{ ms};$$

If the UE does not need idle intervals to perform E-UTRAN TDD measurements, the UE shall be able to identify a new detectable E-UTRAN TDD cell within  $T_{\text{Basic\_Identify\_E-UTRAN TDD}}$  ms.

Where:

$T_{\text{E-UTRAN TDD}}$ : This is the minimum time that is available for E-UTRAN TDD measurements during the measurement period  $T_{\text{Measurement\_Period\_E-UTRAN TDD}}$  with an arbitrarily chosen timing. The minimum time per idle interval is calculated by assuming  $2 \cdot 0.5$  ms for implementation margin.

$$T_{\text{Basic\_Identify\_E-UTRAN TDD}} = 480 \text{ ms}$$

When L3 filtering is used an additional delay can be expected.

An E-UTRAN TDD cell shall be considered detectable when

- RSRP related side condition given in Section 9.1 of TS 36.133 [26] are fulfilled for a corresponding Band,
- $SCH\_RP|_{dBm} \geq -127$  dBm for Bands 33, 34, 35, 36, 37, 38, 39 and 40 defined in TS 36.101 [27] and  $SCH \hat{E}s/Iot \geq -4$  dB,

When idle intervals are scheduled for E-UTRAN TDD measurements the UE physical layer shall be capable of reporting measurements to higher layers with measurement accuracy as specified in TS 25.123 [2] sub-clause 9.1.1.5a and 9.1.1.5b with measurement period of  $T_{\text{Measurement\_Period\_E-UTRAN TDD}} = 480 \times N_{\text{Freq}}$  ms where  $N_{\text{Freq}}$  is the number of TDD frequencies indicated in the E-UTRAN measurement control information.

The UE shall be capable of performing RSRP measurements of at least 4 E-UTRAN TDD cells per E-UTRAN TDD frequency for up to 3 E-UTRAN TDD frequencies.

Reported measurements contained in periodically triggered measurement reports shall meet the requirements in TS 25.123 [2] section 9.

Reported measurements contained in event triggered measurement reports shall meet the requirements in section TS 25.123 [2] 9.

The UE shall not send any event triggered measurement reports, as long as no reporting criteria are fulfilled.

The measurement reporting delay is defined as the time between an event that will trigger a measurement report and the point when the UE starts to transmit the measurement report over the air interface. This requirement assumes that the measurement report is not delayed by other RRC signalling on the DCCH. This measurement reporting delay excludes a delay uncertainty resulted when inserting the measurement report to the TTI of the uplink DCCH. The delay uncertainty is:  $[2] \times TTI_{\text{DCCH}}$ . This measurement reporting delay excludes a delay which caused by no UL resources for UE to send the measurement report.

The event triggered measurement reporting delay, measured without L3 filtering shall be less than  $T_{\text{Identify E-UTRAN TDD}}$  defined in TS 25.123 [2] Section 8.1A.2.7.1. When L3 filtering is used an additional delay can be expected.

If a cell has been detectable at least for the time period  $T_{\text{Identify E-UTRAN TDD}}$  and then enters or leaves the reporting range, the event triggered measurement reporting delay shall be less than  $T_{\text{Measurement_Period_E-UTRAN_TDD}}$  provided the timing to that cell has not changed more than [FFS] while idle interval has not been available and the L3 filter has not been used.

The normative reference for this requirement is TS 25.123 [2] clause 8.1A.2.7 and A.8.5.2

8.6.5.2.2.3 7,68 Mcps TDD Option

8.6.5.2.3 Test purpose

8.6.5.2.3.1 3,84 Mcps TDD Option

8.6.5.2.3.2 1,28 Mcps TDD Option

To verify that the UE makes correct reporting of an event when measuring on E-UTRA TDD cells.

8.6.5.2.3.3 7,68 Mcps TDD Option

8.6.5.2.4 Method of test

8.6.5.2.4.1 3,84 Mcps TDD Option

8.6.5.2.4.2 1,28 Mcps TDD Option

8.6.5.2.4.2.1 Initial conditions

Test environment : normal; see clauses G.2.1 and G.2.2.

Frequencies to be tested : mid range ;see clauses G.2.4.

This test scenario comprised of Cell 1 UTRA TDD serving cell, and Cell 2 E-UTRA TDD cell to be searched. Test parameters are given in Table A.8.5.2.1.2-1, A.8.5.2.1.2-2, and A.8.5.2.1.2-3. Idle interval of 80ms period as defined in TS25.331 is provided.

In the measurement control information, it is indicated to the UE that event-triggered reporting with Event 3c is used. The test consists of two successive time periods, with time duration of T1 and T2 respectively.

**Table 8.6.5.2.4.2.1-1: General test parameters for UTRA TDD to E-UTRA TDD cell search under fading propagation conditions**

Parameter	Unit	Value	Comment
DPCH parameters active cell		DL Reference Measurement Channel 12.2 kbps	As specified in TS 25.102 section A. The DPCH is located in an other timeslot than 0.
Active cell		Cell 1	1.28Mcps TDD cell
Neighbour cell		Cell 2	E-UTRA TDD cell
Uplink-downlink configuration of cell 2		1	As specified in table 4.2.2 in TS 36.211
Special subframe configuration of cell 2		6	As specified in table 4.2.1 in TS 36.211
CP length of cell 2		normal	
Idle intervals period	ms	80	As specified in TS 25.331
$T_{\text{other\_RAT}}$	dBm	-98	Absolute RSRP threshold for event 3c
$CIO_{\text{other\_RAT}}$	dB	0	Cell individual offset
$H_{3c}$	dB	0	Hysteresis parameter for event 3c
TimeToTrigger	dB	0	
Filter coefficient		0	L3 filtering is not used
T1	s	5	During T1, cell 2 shall be powered off, and during the off time the physical layer cell identity shall be changed.
T2	s	10	

**Table 8.6.5.2.4.2.1-2: Cell specific test parameters for cell search UTRA TDD to E-UTRA TDD test case (cell 1)**

Parameter	Unit	Cell 1 (UTRA)			
		0		DwPTS	
Timeslot Number		T1	T2	T1	T2
UTRA RF Channel Number*		Channel 1			
PCCPCH_Ec/I <sub>or</sub>	dB	-3	-3		
DwPCH_Ec/I <sub>or</sub>	dB			0	0
OCNS_Ec/I <sub>or</sub>	dB	-3	-3		
$\hat{I}_{or} / I_{oc}$	dB	3	3	3	3
$I_{oc}$	dBm/1.28 MHz	-70			
PCCPCH RSCP	dBm	-70	-70	n.a.	n.a.
Propagation Condition		Case 3			
* Note: In the case of multi-frequency cell, the UTRA RF Channel Number is the primary frequency's channel number.					

**Table 8.6.5.1.4.2.1-3: Cell specific test parameters for cell search UTRA TDD to E-UTRA TDD test case (cell 2)**

Parameter	Unit	Cell 2	
		T1	T2
E-UTRA RF Channel Number		2	
BW <sub>channel</sub>	MHz	10	
OCNG Pattern defined in A.3.2.2.2 (OP.2 TDD) in [24]		OP.2 TDD	OP.2 TDD
PBCH_RA	dB	0	0
PBCH_RB	dB		
PSS_RB	dB		
SSS_RB	dB		
PCFICH_PA	dB		
PHICH_PA	dB		
PHICH_PB	dB		
PDCCH_PA	dB		
PDCCH_PB	dB		
PDSCH_PA	dB		
PDSCH_PB	dB		
OCNG_RA <sup>Note1</sup>	dB		
OCNG_RB <sup>Note1</sup>	dB		
$\hat{E}_s / N_{oc}$	dB	-Infinity	9
$N_{oc}$	dBm/15kHz	-98	
$\hat{E}_s / I_{ot}$	dB	-Infinity	9
RSRP	dBm/15kHz	-Infinity	-89
SCH_RP	dBm/15kHz	-Infinity	-89
Propagation Condition		ETU70	
Note 1: OCNG shall be used such that cell is fully allocated and a constant total transmitted power spectral density is achieved for all OFDM symbols.			
Note 2: The resources for uplink transmission are assigned to the UE prior to the start of time period T2.			

**8.6.5.2.4.2.2 Test Procedure**

- 1) The RF parameters are set up according to T1.
- 2) The UE is switched on.
- 3) A call is set up according to the generic set-up procedure specified in TS 34.108 [3] subclause 7.4.2 to place the UE in CELL\_DCH.

- 4) SS shall transmit a MEASUREMENT CONTROL message.
- 5) After 5 seconds from the beginning of T1, the SS shall switch the E-UTRA TDD Cell 2 power settings from T1 to T2.
- 6) UE shall transmit a MEASUREMENT REPORT message triggered by event 3c for Cell 2. The measurement reporting delay from the beginning of T2 shall be less than 7.7s. If the UE fails to report the event within the required delay, then a failure is recorded. If the reporting delay for this event is within the required limit, the number of successful tests is increased by one.
- 7) After 10 seconds from the beginning of T2, the UE is switched off. Any timing information of cell 2 is deleted in the UE.
- 8) Repeat steps 1-7 until the confidence level according to annex F.6.2 is achieved.

#### Specific Message Contents

All messages indicated above shall use the same content as described in the default message content in clause 9 of 34.108 [3] and in Annex A of 34.123-1 [21], with the following exceptions:

NOTE: Numbers in brackets after an item e.g. "Message Type (10.2.17)" in the IE description are references to clause numbers in TS 25.331 [9] describing that item in more detail.



MEASUREMENT CONTROL message (step 4):

Information Element/Group name	Value/Remark
Message Type (10.2.17)	
<b>UE information elements</b>	
-RRC transaction identifier	0
-Integrity check info	
<b>Measurement Information elements</b>	
-Measurement Identity	1
-Measurement Command (10.3.7.46)	Setup
-Measurement Reporting Mode (10.3.7.49)	
-Measurement Report Transfer Mode	AM RLC
-Periodical Reporting / Event Trigger Reporting Mode	Event trigger
-Additional measurements list (10.3.7.1)	Not Present
-CHOICE <i>Measurement type</i>	Inter-RAT measurement
-Inter-RAT measurement (10.3.7.27)	
-Inter-RAT measurement objects list (10.3.7.23)	Not Present
-Inter-RAT measurement quantity (10.3.7.29)	
-Measurement quantity for UTRAN quality estimate (10.3.7.38)	
-Filter coefficient	0
-CHOICE mode	TDD
-Measurement quantity	Primary CCPCH RSCP
-CHOICE system	E-UTRA
-Measurement quantity	RSRP
-Filter coefficient	0
-Inter-RAT reporting quantity (10.3.7.32)	
-UTRAN estimated quality	FALSE
-CHOICE system	E-UTRA
- Reporting quantity	'measurement_quantity'
-Reporting cell status (10.3.7.61)	Not Present
-CHOICE report criteria	Inter-RAT measurement reporting criteria
-Inter-RAT measurement reporting criteria (10.3.7.30)	
-Parameters required for each event	1
-Inter-RAT event identity (10.3.7.24)	3c
-Threshold own system	Not Present
-W	Not Present
-Threshold other system	-98 dBm
-Hysteresis	0 dB
-Time to trigger	0 ms
-Reporting cell status (10.3.7.61)	
-CHOICE reported cell	Report cells within active set or within virtual active set or of the other RAT
-Maximum number of reported cells	2
<b>Physical channel information elements</b>	
-DPCH compressed mode status info (10.3.6.34)	Not Present

MEASUREMENT REPORT message (step 6)

Information Element	Value/remark
Message Type (10.2.17)	
Integrity check info	Not Present
Measurement identity	1
E-UTRA Measured Results (10.3.7.6c)	
- E-UTRA measured results list	1
- E-UTRA Carrier Frequency	Carrier Frequency of Cell 2
-Measured E-UTRA cells	1
-Physical Cell Identity	Physical cell id of Cell 2
-RSRP	
E-UTRA event results (10.3.7.6a)	
- Inter-RAT event identity	3c
- E-UTRA events results list	1
- E-UTRA Carrier Frequency	Carrier Frequency of Cell 2
- Reported cells	1
- Physical Cell Identity	Physical cell id of Cell 2

8.6.5.2.4.3 7,68 Mcps TDD Option

8.6.5.2.5 Test requirements

8.6.5.2.5.1 3,84 Mcps TDD Option

8.6.5.2.5.2 1,28 Mcps TDD Option

The UE shall send one Event 3c triggered measurement report, with a measurement reporting delay less than 7.7s from the beginning of time period T2.

The UE shall not send event triggered measurement reports, as long as the reporting criteria are not fulfilled.

For the test to pass, the total number of successful tests shall be more than 90% with a confidence level of 95% of the cases.

NOTE: The actual overall delays measured in the test may be up to  $2xTTI_{DCCH}$  higher than the measurement reporting delays above because of TTI insertion uncertainty of the measurement report in DCCH.

8.6.5.2.5.3 7,68 Mcps TDD Option

8.6.5.3 Combined UTRA TDD inter-frequency and E-UTRA FDD cell search under fading propagation conditions

*Editor's note: This test case is incomplete. The following aspects are either missing or not yet determined:*

- *The Test system uncertainties applicable to this test are undefined*
- *The Test tolerances applicable to this test are undefined*
- *Message contents are incomplete*

8.6.5.3.1 Definition and applicability

8.6.5.3.1.1 3,84 Mcps TDD Option

8.6.5.3.1.2 1,28 Mcps TDD Option

The cell search delay is defined as the time from the beginning of a cell becoming detectable and fulfilling an event triggering condition, to the moment when the UE sends event triggered measurement report for this cell. This requirement assumes that the measurement report is not delayed by other RRC signalling on the DCCH.

The requirements and this test apply to the combined TDD (1.28 Mcps option) and E-UTRA FDD UE of Release 8 and later.

8.6.5.3.1.3 7,68 Mcps TDD Option

8.6.5.3.2 Minimum requirement

8.6.5.3.2.1 3,84 Mcps TDD Option

8.6.5.3.2.2 1,28 Mcps TDD Option

The UE shall send one Event 2B triggered measurement report for inter-frequency UTRA TDD cell (Cell2), with a measurement reporting delay less than 5s from the beginning of time period T2.

The UE shall send one Event 3a triggered measurement report for E-UTRA FDD cell (Cell3), with a measurement reporting delay less than 4270ms from the beginning of time period T2.

The UE shall not send event triggered measurement reports, as long as the reporting criteria are not fulfilled.

The rate of correct events observed during repeated tests shall be at least 90%.

NOTE: The actual overall delays measured in the test may be up to  $2xTTI_{DCCH}$  higher than the measurement reporting delays above because of TTI insertion uncertainty of the measurement report in DCCH.

8.6.5.3.2.3 7,68 Mcps TDD Option

8.6.5.3.3 Test purpose

8.6.5.3.3.1 3,84 Mcps TDD Option

8.6.5.3.3.2 1,28 Mcps TDD Option

The purpose of this test is to verify that the UE makes correct reporting of an event within the required times when doing inter frequency and E-UTRA FDD measurements. To verify that the UE meets the minimum time requirements for identifying neighbouring inter-frequency TDD cell and E-UTRA FDD cell. The test will partly verify the requirements in section 8.1A.2.3 combined 8.1A.2.6 and 9.1 of [2] under fading propagation conditions.

8.6.5.3.3.3 7,68 Mcps TDD Option

8.6.5.3.4 Method of test

8.6.5.3.4.1 3,84 Mcps TDD Option

8.6.5.3.4.2 1,28 Mcps TDD Option

8.6.5.3.4.2.1 Initial conditions

Test environment : normal; see clauses G.2.1 and G.2.2.

Frequencies to be tested : mid range; see clauses G.2.4.

This test scenario comprised of 2 UTRA TDD cells working on different frequency, and 1 E-UTRA FDD cell. General test parameters are given in the table 8.6.5.3.4.2-1, and they are signalled from test device. In the measurement control information it is indicated to the UE that event-triggered reporting with Event 2B and Event 3A shall be used. New measurement control information, which defines neighbour cells etc., is always sent before the event starts. Scheduled idle interval of 80ms period as defined in TS25.331 is provided. Two UTRA TDD cells shall be synchronised, i.e. sharing the same frame and timeslot timing.

The test consists of two successive time periods, with time duration of T1 and T2 respectively. The cell specific test parameters are shown in table 8.6.5.3.4.2-2 and table 8.6.5.3.4.2-3.

**Table 8.6.5.3.4.2-1: General test parameters for combined UTRA TDD inter-frequency and E-UTRA FDD cells search under fading propagation conditions**

Parameter	Unit	Value	Comment
DPCH parameters active cell		DL Reference Measurement Channel 12.2 kbps	As specified in TS 25.102 section A.2.2. The DPCH is located in an other timeslot than 0.
Active cell		Cell 1	1.28Mcps TDD cell operating on channel 1
Neighbour cell		Cell 2	1.28Mcps TDD cell operating on channel 2
		Cell 3	E-UTRA FDD cell
CP length of cell 3		Normal	
Idle intervals period	ms	80	As specified in TS 25.331
$T_{used\ 2b}$	dBm	-73	Absolute P-CCPCH RSCP threshold for event 2B
$T_{non\ used\ 2b}$	dBm	-80	Absolute P-CCPCH RSCP threshold for event 2B
$T_{used}$	dBm	-73	Absolute P-CCPCH RSCP threshold for event 3A
$T_{other\ RAT}$	dBm	-98	Absolute RSRP threshold for event 3A
$H_{2b}$	dB	0	The hysteresis parameter for the event 2B
$H_{3a}$	dB	0	The hysteresis parameter for the event 3A
$CIO_{other\ RAT}$	dB	0	Cell individual offset for the cell of the other system
TimeToTrigger	ms	0	
Filter coefficient		0	L3 filtering is not used
Monitored cell list size		24 on channel 1 16 on channel 2	
T1	s	5	During T1, cell 2 and cell 3 shall be powered off, and during the off time the physical layer cell identity shall be changed.
T2	s	7	

**Table 8.6.5.3.4.2-2: Cell specific test parameters for combined UTRA TDD inter-frequency and E-UTRA FDD cell search under fading propagation conditions (cell 1 and cell 2)**

Parameter	Unit	Cell 1 (UTRA)				Cell 2 (UTRA)			
		0		DwPTS		0		DwPTS	
Timeslot Number		T1	T2	T1	T2	T1	T2	T1	T2
UTRA RF Channel Number*		Channel 1				Channel 2			
PCCPCH_Ec/Ior	dB	-3				-3			
DwPCH_Ec/Ior	dB	0				0			
OCNS_Ec/Ior	dB	-3				-3			
$\hat{I}_{or}/I_{oc}$	dB	4+TT	4+TT	4+TT	4+TT	-Infinity	12+TT	-Infinity	12+TT
$I_{oc}$	dBm/ 1.28 MHz	-80							
PCCPCH RSCP	dBm	-79+TT	-79+TT	n.a.		-Infinity	-71+TT	n.a.	
Propagation Condition		AWGN				Case 3			
NOTE1: The DPCH of all cells are located in a timeslot other than 0.									
NOTE2: In the case of multi-frequency network, the UTRA RF Channel Number can be set for the primary frequency in this test.									

**Table 8.6.5.3.4.2-3: Cell specific test parameters for combined UTRA TDD inter-frequency and E-UTRA FDD cell search under fading propagation conditions (cell 3)**

Parameter	Unit	Cell 3	
		T1	T2
E-UTRA RF Channel Number		3	
BW <sub>channel</sub>	MHz	10	
OCNG Pattern defined in A.3.2.1.2 (OP.2 FDD) in [24]		OP.2 FDD	OP.2 FDD
PBCH_RA	dB	0	0
PBCH_RB	dB		
PSS_RB	dB		
SSS_RB	dB		
PCFICH_PA	dB		
PHICH_PA	dB		
PHICH_PB	dB		
PDCCH_PA	dB		
PDCCH_PB	dB		
PDSCH_PA	dB		
PDSCH_PB	dB		
OCNG_RANote1	dB		
OCNG_RBNote1	dB		
$\hat{E}_s/N_{oc}$	dB		
$N_{oc}$	dBm/15kHz	-98	
$\hat{E}_s/I_{ot}$	dB	-Infinity	9+TT
RSRP <sup>Note 3</sup>	dBm/15kHz	-Infinity	-89+TT
SCH RP	dBm/15kHz	-Infinity	-89+TT
Propagation Condition		ETU70 (Note 4)	
Note 1: OCNG shall be used such that cell is fully allocated and a constant total transmitted power spectral density is achieved for all OFDM symbols.			
Note 2: The resources for uplink transmission are assigned to the UE prior to the start of time period T2.			
Note 3: RSRP levels have been derived from other parameters for information purposes. They are not settable parameters themselves.			
Note 4: ETU70 propagation conditions are specified in Annex B.2 of 3GPP TS 36.101.			

#### 8.6.5.3.4.2.2 Test Procedure

- 1) The UE is switched on.
- 2) The RF parameters are set up according to T1.
- 3) A call is set up according to the generic set-up procedure specified in TS 34.108 [3] subclause 7.4.2 to place the UE in CELL\_DCH.
- 4) SS shall transmit a MEASUREMENT CONTROL message.
- 5) After 5 seconds from the beginning of T1, the SS shall switch the power settings from T1 to T2.
- 6) UE shall transmit a MEASUREMENT REPORT message triggered by event 3A for cell 3. The measurement reporting delay from the beginning of T2 shall be less than 4270ms. If the UE fails to report the event within the required delay, then a failure is recorded. If the reporting delay for this event is within the required limit, the number of successful tests is increased by one.
- 7) UE shall transmit a MEASUREMENT REPORT message triggered by event 2B for cell 2. The measurement reporting delay from the beginning of T2 shall be less than 5s. If the UE fails to report the event within the required delay, then a failure is recorded. If the reporting delay for this event is within the required limit, the number of successful tests is increased by one.
- 8) After 7 seconds from the beginning of T2, the connection will be released, and the UE will enter IDLE state.
- 9) Repeat steps 2-8 until the confidence level according to annex F.6.2 is achieved.

#### Specific Message Contents

All messages indicated above shall use the same content as described in the default message content in clause 9 of 34.108 [3] and in Annex A of 34.123-1 [21], with the following exceptions:

- NOTE: Numbers in brackets after an item e.g “Message Type (10.2.17)” in the IE description are references to clause numbers in TS 25.331 [9] describing that item in more detail.

MEASUREMENT CONTROL message (step 4):

Information Element/Group name	Value/Remark
Message Type (10.2.17)	
<b>UE information elements</b>	
-RRC transaction identifier	0
-Integrity check info	Not Present
<b>Measurement Information elements</b>	
-Measurement Identity	1
-Measurement Command (10.3.7.46)	Modify
-Measurement Reporting Mode (10.3.7.49)	AM RLC
-Periodical Reporting / Event Trigger Reporting Mode	Event trigger
-Additional measurements list (10.3.7.1)	Not Present
-CHOICE <i>Measurement type</i>	Inter-frequency measurement
-Inter-frequency measurement (10.3.7.16)	
-Inter-frequency measurement objects list (10.3.7.13)	
-CHOICE <i>inter-frequency cell removal</i>	No inter-frequency cells removed
-New inter-frequency cells	1
-Inter-frequency cell id	1
-Frequency info (10.3.6.36)	
-CHOICE <i>mode</i>	TDD
-UARFCN(Nt)	Same frequency as channel 2
-Cell info (10.3.7.2)	
-Cell individual offset	Not Present
-Reference time difference to cell	Not Present
-Read SFN indicator	False
-CHOICE <i>mode</i>	TDD
-Primary CCPCH info (10.3.6.57)	
-CHOICE <i>mode</i>	TDD
-CHOICE TDD option	1,28 Mcps TDD
-cell parameters ID	Set to cell parameters ID of cell 2
-SCTD indicator	FALSE
-Primary CCPCH Tx power	Set to Primary CCPCH Tx power of cell 2 as described in Table 8.6.2.1.2
-Timeslot list	Not Present
-Cell selection and re-selection info	Not Present
-Cell for measurement	Not Present
-Inter-frequency measurement quantity (10.3.7.18)	
-CHOICE <i>reporting criteria</i>	Inter-frequency reporting criteria
-Filter coefficient (10.3.7.9)	0
-CHOICE <i>mode</i>	TDD
-Measurement quantity for frequency quality estimate	Primary CCPCH RSCP
-Inter-frequency reporting quantity (10.3.7.21)	
-UTRA carrier RSSI	FALSE
-Frequency quality estimate	FALSE
-Non frequency related cell reporting quantities (10.3.7.5)	
-SFN-SFN observed time difference reporting indicator	No report
-Cell synchronisation information reporting indicator	FALSE
-Cell identity reporting indicator	FALSE
-CHOICE <i>mode</i>	TDD
-Timeslot ISCP reporting indicator	FALSE
-Proposed TGSN Reporting required	FALSE
-Primary CCPCH RSCP reporting indicator	TRUE
-Pathloss reporting indicator	FALSE
-Reporting cell status (10.3.7.61)	Not Present
-Measurement validity (10.3.7.51)	Not Present
-CHOICE <i>report criteria</i>	Inter-frequency measurement reporting criteria
-Inter-frequency measurement reporting criteria (10.3.7.19)	
-Parameters required for each event	1
-Inter-frequency event identity	Event 2B
-Threshold used frequency	-73
-W Used frequency	0
-Hysteresis	0 dB
-Time to trigger	0 ms
-Reporting Cell Status (10.3.61)	
-CHOICE reported cell	Report cells within active and/or monitored

Information Element/Group name	Value/Remark
-Maximum number of reported cells -Parameters required for each non-used frequenc - Threshold non-used frequency - W non-used frequency	set on used frequency or within virtual active and/or monitored set on non-used frequency 3  -80 0
<b>Physical channel information elements</b> -DPCH compressed mode status info (10.3.6.34)	Not Present

## MEASUREMENT REPORT message (step 6)

Information Element	Value/remark
Message Type (10.2.17)	
Integrity check info	Not Present
Measurement identity	1
Measured Results (10.3.7.44)	
-CHOICE Measurement	Inter-frequency Measured results list
-Inter-frequency measured results	1
-Frequency info	
-CHOICE mode	TDD
-UARFCN(Nt)	Same frequency as channel 2
-UTRA carrier RSSI	Not Present
-Inter-frequency cell measured results	1
-Cell measured results (10.3.7.3)	
-Cell identity	Not Present
-SFN-SFN observed time difference	Not Present
-Cell synchronisation info	Not Present
-CHOICE mode	TDD
-Cell parameters ID	Set to cell parameters ID of Cell 2
-Proposed TGSN	Not Present
-Primary CCPCH RSCP	Checked that this IE is present
-Pathloss	Not Present
-Timeslot list	Not Present
Measured results on RACH	Not Present
Additional measured results	Not Present
Event results (10.3.7.7)	
-CHOICE event result	Inter-frequency measurement event results
-Inter-frequency event identity	2B
-Inter-frequency cells	1
-Frequency Info	
-CHOICE mode	TDD
-UARFCN(Nt)	Same frequency as channel 2
-Non frequency related measurement event results	
-CHOICE mode	TDD
-Primary CCPCH Info	
-CHOICE mode	TDD
-CHOICE TDD Option	1.28 Mcps TDD
-TSTD indicator	TRUE
-Cell Parameters ID	Set to cell parameters ID of Cell 2
-SCTD Indicator	FALSE

8.6.5.3.4.2.3 7,68 Mcps TDD Option

8.6.5.3.5 Test requirements

8.6.5.3.5.1 3,84 Mcps TDD Option

8.6.5.3.5.2 1,28 Mcps TDD Option

The UE shall not send any event triggered measurement reports, as long as the reporting criteria are not fulfilled.

For the test to pass, the total number of successful tests shall be more than 90% with a confidence level of 95% of the cases.

8.6.5.3.5.3 7,68 Mcps TDD Option

## 8.7 Measurements Performance Requirements

Unless explicitly stated:

- Reported measurements shall be within defined range in 90 % of the cases.
- Measurement channel is 12.2 kbps as defined in annex C, sub-clause C.3.1. This measurement channel is used in active cell and cells to be measured.
- Cell 1 is the active cell.
- Single task reporting.
- Power control is active.

### 8.7.1 P-CCPCH RSCP

#### 8.7.1.1 Intra frequency measurement accuracy for 3,84 Mcps TDD Option

##### 8.7.1.1.1 Absolute accuracy requirement

###### 8.7.1.1.1.1 Definition and applicability

The absolute accuracy of P-CCPCH RSCP is defined as the P-CCPCH RSCP measured from one cell compared to the actual P-CCPCH RSCP power from the same cell.

The requirements and this test apply to all types of UTRA TDD UE.

###### 8.7.1.1.1.2 Minimum Requirements

The absolute accuracy requirements in table 8.7.1.1.1.1 are valid under the following conditions:

P-CCPCH RSCP  $\geq$  -102 dBm.

$$\left( \frac{P - CCPCH - E_c}{I_o} \right)_{in \text{ dB}} \geq -8dB$$

$$\left( \frac{SCH - E_c}{I_o} \right)_{in \text{ dB}} \geq -13dB$$

**Table 8.7.1.1.1.1: P-CCPCH\_RSCP absolute accuracy**

Parameter	Unit	Accuracy [dB]		Conditions
		Normal condition	Extreme condition	$I_o$ [dBm/3.84MHz ]
P-CCPCH_RSCP	dBm	$\pm 6$	$\pm 9$	-94...-70
	dBm	$\pm 8$	$\pm 11$	-70...-50

The normative reference for this requirement is TS 25.123 [2] clauses 9.1.1.1.1 and A.9.1.1.1.1.

###### 8.7.1.1.1.3 Test Purpose

The purpose of this test is to verify that the absolute P-CCPCH RSCP measurement accuracy is within the specified limits.



## 8.7.1.1.1.4 Method of test

## 8.7.1.1.1.4.1 Initial conditions

Test environment: normal, TL/VL, TL/VH, TH/VL, TH/VH; see clauses G.2.1 and G.2.2.

Frequencies to be tested: mid range; see clause G.2.4.

In this case all cells are on the same frequency. Cell 1 and cell 2 shall be synchronised, i.e. share the same frame and timeslot timing. The DL DPCH shall be transmitted in timeslot 4 and the UL DPCH shall be transmitted in timeslot 12. The second Beacon timeslot shall be provided in timeslot 8 for both cell 1 and cell 2. P-CCPCH RSCP intra frequency absolute accuracy requirements are tested by using test parameters in table 8.7.1.1.1.2.

**Table 8.7.1.1.1.2: P-CCPCH RSCP intra frequency test parameters**

Parameter	Unit	Test 1		Test 2		Test 3	
		Cell 1	Cell 2	Cell 1	Cell 2	Cell 1	Cell 2
DL timeslot number		0	0	0	0	0	0
UTRA RF Channel number		Channel 1		Channel 1		Channel 1	
PCCPCH_Ec/lor	dB	-3		-3		-3	
SCH_Ec/lor	dB	-9		-9		-9	
SCH_t <sub>offset</sub>		0	5	0	5	0	5
OCNS_Ec/lor	dB	-3,12		-3,12		-3,12	
loc	dBm / 3,84 MHz	-75.7		-59.8		-98.7	
lor/loc	dB	5	2	9	2	3	0
PCCPCH RSCP, Note 1	dBm	-73.7	-76.7	-53.8	-60.8	-98.7	-101.7
lo, Note 1	dBm / 3,84 MHz	-69		-50		-94	
Propagation condition		AWGN		AWGN		AWGN	
NOTE 1: PCCPCH RSCP and lo levels have been calculated from other parameters for information purposes. They are not settable parameters themselves.							

- 1) A call is set up according to the test procedure specified in TS 34.108 [3] clause 7.3.2.3. The RF parameters for Test 1 are set up according to table 8.7.1.1.1.2.

## 8.7.1.1.1.4.2 Procedure

- 1) SS shall transmit MEASUREMENT CONTROL message.
- 2) UE shall transmit periodically MEASUREMENT REPORT messages.
- 3) SS shall check PCCPCH\_RSCP value in MEASUREMENT REPORT messages. PCCPCH\_RSCP power of Cell 1 reported by UE is compared to actual PCCPCH\_RSCP power for each MEASUREMENT REPORT message.
- 4) SS shall count number of MEASUREMENT REPORT messages transmitted by UE. After 1000 MEASUREMENT REPORT messages have been received from UE, the RF parameters are set up according to table 8.7.1.1.1.2 for Test 2. While RF parameters are being set up, MEASUREMENT REPORT messages from UE are ignored. SS shall wait for additional 1s and ignore the MEASUREMENT REPORT messages during this period. Then, steps 2) and 3) above are repeated. After further 1000 MEASUREMENT REPORT messages have been received from UE, the RF parameters are set up according to table 8.7.1.1.1.2 for Test 3. While RF parameters are being set up, MEASUREMENT REPORT messages from UE are ignored. SS shall wait for additional 1s and ignore the MEASUREMENT REPORT messages during this period. Then, steps 2) and 3) above are repeated.
- 5) After further 1000 MEASUREMENT REPORT messages have been received from UE, the SS shall transmit RRC CONNECTION RELEASE message.
- 6) UE shall transmit RRC CONNECTION RELEASE COMPLETE message.

## Specific Message Contents

All messages indicated above shall use the same content as described in the default message content in clause 9 of 34.108 [3] and in Annex I, with the following exceptions:

MEASUREMENT CONTROL message (Step 1):

Information Element/Group name	Value/Remark
Message Type (10.2.17)	
UE information elements	
-RRC transaction identifier	0
-Integrity check info	Not Present
Measurement Information elements	
-Measurement Identity	1
-Measurement Command (10.3.7.46)	Modify
-Measurement Reporting Mode (10.3.7.49)	
-Measurement Report Transfer Mode	AM RLC
-Periodical Reporting / Event Trigger Reporting Mode	Periodical reporting
-Additional measurements list (10.3.7.1)	Not Present
-CHOICE <i>Measurement type</i>	Intra-frequency measurement
-Intra-frequency measurement (10.3.7.36)	
-Intra-frequency measurement objects list (10.3.7.33)	Not Present
-Intra-frequency measurement quantity (10.3.7.38)	
-Filter coefficient (10.3.7.9)	0
-CHOICE <i>mode</i>	TDD
-Measurement quantity list	1
-Measurement quantity	Primary CCPCH RSCP
-Intra-frequency reporting quantity (10.3.7.41)	
-Reporting quantities for active set cells (10.3.7.5)	
-SFN-SFN observed time difference reporting indicator	No report
-Cell synchronisation information reporting indicator	FALSE
-Cell Identity reporting indicator	TRUE
-CHOICE <i>mode</i>	TDD
-Timeslot ISCP reporting indicator	FALSE
-Primary CCPCH RSCP reporting indicator	TRUE
-Pathloss reporting indicator	FALSE
-Reporting quantities for monitored set cells (10.3.7.5)	
-SFN-SFN observed time difference reporting indicator	No report
-Cell synchronisation information reporting indicator	FALSE
-Cell Identity reporting indicator	TRUE
-CHOICE <i>mode</i>	TDD
-Timeslot ISCP reporting indicator	FALSE
-Proposed TGSN reporting required	FALSE
-Primary CCPCH RSCP reporting indicator	TRUE
-Pathloss reporting indicator	FALSE
-Reporting quantities for detected set cells (10.3.7.5)	Not Present
-Reporting cell status (10.3.7.61)	
-CHOICE <i>reported cell</i>	Report all active set cells + cells within monitored set on used frequency
-Maximum number of reported cells	1
-Measurement validity (10.3.7.51)	Not Present
-CHOICE <i>report criteria</i> (10.3.7.	
-Periodical reporting criteria (10.3.7.53)	
-Amount of reporting	Infinity
-Reporting interval	250 ms
Physical channel information elements	
-DPCH compressed mode status info (10.3.6.34)	Not Present

#### 8.7.1.1.1.5 Test requirements

The PCCPCH RSCP measurement accuracy shall meet the requirements in clause 8.7.1.1.1.2 for at least 900 of the measurement reports at each input level in step 4.

NOTE: If the above Test Requirement differs from the Minimum Requirement then the Test Tolerance applied for this test is non-zero. The Test Tolerance for this test is defined in clause F.2 and the explanation of how the Minimum Requirement has been relaxed by the Test Tolerance is given in clause F.4.

### 8.7.1.1.2 Relative accuracy requirement

#### 8.7.1.1.2.1 Definition and applicability

The relative accuracy of PCCPCH RSCP is defined as the PCCPCH RSCP measured from one cell compared to the PCCPCH RSCP measured from another cell on the same frequency.

The requirements and this test apply to all types of UTRA TDD UE.

#### 8.7.1.1.2.2 Minimum Requirements

The relative accuracy requirements in table 8.7.1.1.2.1 are valid under the following conditions:

P-CCPCH RSCP  $\geq$  -102 dBm.

$$\left( \frac{P - CCPCH - E_c}{I_o} \right)_{in\ dB} \geq -8dB$$

$$\left( \frac{SCH - E_c}{I_o} \right)_{in\ dB} \geq -13dB$$

$$\left| P - CCPCH\ RSCP1 \Big|_{in\ dB} - P - CCPCH\ RSCP2 \Big|_{in\ dB} \right| \leq 20dB$$

Relative  $I_o$  difference [dB]  $\leq$  relative RSCP difference [dB]

It is assumed that the measurements of P-CCPCH RSCP1 and P-CCPCH RSCP2 can be performed within 20ms due to slot allocations in the cells concerned.

**Table 8.7.1.1.2.1: P-CCPCH\_RSCP intra-frequency relative accuracy**

Parameter	Unit	Accuracy [dB]		Conditions	
		Normal condition	Extreme condition	$I_o$ [dBm/3.8 4MHz]	relative RSCP difference [dB]
P-CCPCH_RSCP	dBm	$\pm 1$	$\pm 1$	-94...-50	<2
		$\pm 2$	$\pm 2$		2...14
		$\pm 3$	$\pm 3$		>14

The normative reference for this requirement is TS 25.123 [2] clauses 9.1.1.1.2 and A.9.1.1.1.1.

#### 8.7.1.1.2.3 Test Purpose

The purpose of this test is to verify that the relative P-CCPCH RSCP measurement accuracy is within the specified limits.

#### 8.7.1.1.2.4 Method of test

##### 8.7.1.1.2.4.1 Initial conditions

Test environment: normal, TL/VL, TL/VH, TH/VL, TH/VH; see clauses G.2.1 and G.2.2.

Frequencies to be tested: mid range; see clause G.2.4.

In this case all cells are on the same frequency. Cell 1 and cell 2 shall be synchronised, i.e. share the same frame and timeslot timing. The DL DPCH shall be transmitted in timeslot 4 and the UL DPCH shall be transmitted in timeslot 12. The second Beacon timeslot shall be provided in timeslot 8 for both cell 1 and cell 2. P-CCPCH RSCP intra frequency relative accuracy requirements are tested by using test parameters in table 8.7.1.1.1.2.

- 1) A call is set up according to the test procedure specified in TS 34.108 [3] clause 7.3.2.3. The RF parameters for Test 1 are set up according to table 8.7.1.1.1.2.

#### 8.7.1.1.2.4.2 Procedure

- 1) SS shall transmit MEASUREMENT CONTROL message.
- 2) UE shall transmit periodically MEASUREMENT REPORT messages.
- 3) SS shall check PCCPCH\_RSCP value of Cell 1 and Cell 2 in MEASUREMENT REPORT messages. PCCPCH RSCP power value measured from Cell 1 is compared to PCCPCH RSCP power value measured from Cell 2 for each MEASUREMENT REPORT message.
- 4) The result of step 3) is compared to actual power level difference of PCCPCH RSCP of Cell 1 and Cell 2.
- 5) SS shall count number of MEASUREMENT REPORT messages transmitted by UE. After 1000 MEASUREMENT REPORT messages have been received from UE, the RF parameters are set up according to table 8.7.1.1.1.2 for Test 2. While RF parameters are being set up, MEASUREMENT REPORT messages from UE are ignored. SS shall wait for additional 1s and ignore the MEASUREMENT REPORT messages during this period. Then, steps 3) and 4) above are repeated. After further 1000 MEASUREMENT REPORT messages have been received from UE, the RF parameters are set up according to table 8.7.1.1.1.2 for Test 3. While RF parameters are being set up, MEASUREMENT REPORT messages from UE are ignored. SS shall wait for additional 1s and ignore the MEASUREMENT REPORT messages during this period. Then, steps 3) and 4) above are repeated.
- 6) After further 1000 MEASUREMENT REPORT messages have been received from UE, the SS shall transmit RRC CONNECTION RELEASE message.
- 7) UE shall transmit RRC CONNECTION RELEASE COMPLETE message.

#### Specific Message Contents

All messages indicated above shall use the same content as described in the default message content in clause 9 of 34.108 [3] and in Annex I, with the following exceptions:

MEASUREMENT CONTROL message for intra frequency measurement in clause 8.7.1.1.1.4.2 shall be used.

#### 8.7.1.1.2.5 Test requirements

The PCCPCH RSCP measurement accuracy shall meet the requirements in clause 8.7.1.1.2.2 for at least 900 of the measurement reports at each input level in step 4.

NOTE: If the above Test Requirement differs from the Minimum Requirement then the Test Tolerance applied for this test is non-zero. The Test Tolerance for this test is defined in clause F.2 and the explanation of how the Minimum Requirement has been relaxed by the Test Tolerance is given in clause F.4.

### 8.7.1.1A Intra frequency measurement accuracy for 1,28 Mcps TDD Option

#### 8.7.1.1A.1 Absolute accuracy requirement

##### 8.7.1.1A.1.1 Definition and applicability

The absolute accuracy of P-CCPCH RSCP is defined as the P-CCPCH RSCP measured from one cell compared to the actual P-CCPCH RSCP power from the same cell.

The requirements and this test apply to all types of UTRA TDD UE 1,28 Mcps option.

##### 8.7.1.1A.1.2 Minimum Requirements

The absolute accuracy requirements in table 8.7.1.1A.1.1 are valid under the following conditions:

P-CCPCH RSCP  $\geq$  -102 dBm.

$$\left( \frac{P - CCPCH - E_c}{I_o} \right)_{in \text{ dB}} \geq -8dB$$

$$\left( \frac{DwPCH - E_c}{I_o} \right)_{in \text{ dB}} \geq -5dB$$

Table 8.7.1.1A.1.1: P-CCPCH\_RSCP absolute accuracy

Parameter	Unit	Accuracy [dB]		Conditions
		Normal condition	Extreme condition	$I_o$ [dBm/1.28MHz]
P-CCPCH_RSCP	dBm	$\pm 6$	$\pm 9$	-94...-70
	dBm	$\pm 8$	$\pm 11$	-70...-50

The rate of correct measurements observed during repeated tests shall be at least 90%.

The normative reference for this requirement is TS 25.123 [2] clauses 9.1.1.1.1 and A.9.2.1.1.1.

#### 8.7.1.1A.1.3 Test Purpose

The purpose of this test is to verify that the absolute P-CCPCH RSCP measurement accuracy is within the specified limits.

#### 8.7.1.1A.1.4 Method of test

##### 8.7.1.1A.1.4.1 Initial conditions

Test environment: normal, TL/VL, TL/VH, TH/VL, TH/VH; see clauses G.2.1 and G.2.2.

Frequencies to be tested: mid range; see clause G.2.4.

In this case all cells are on the same frequency. Cell 1 and cell 2 shall be synchronised, i.e. share the same frame and timeslot timing. The DL DPCH shall be transmitted in timeslot 5 and the UL DPCH shall be transmitted in timeslot 2. P-CCPCH RSCP intra frequency absolute accuracy requirements are tested by using test parameters in table 8.7.1.1A.1.2.

Table 8.7.1.1A.1.2: P-CCPCH RSCP Intra frequency test parameters

		Test 1			
Parameter	Unit	Cell 1		Cell 2	
Timeslot Number		0	DwPTS	0	DwPTS
UTRA RF Channel Number		Channel 1		Channel 1	
PCCPCH_Ec/Ior	dB	-3		-3	
DwPCH_Ec/Ior	dB		0		0
OCNS_Ec/Ior	dB	-3		-3	
$\hat{I}_{or}/I_{oc}$	dB	5		2	
$I_{oc}$	dBm/ 1,28 MHz	-76.6			
PCCPCH RSCP, Note 1	dBm	-74.6		-77.6	
Io, Note 1	dBm/ 1,28 MHz	-69			
Propagation condition		AWGN			
		Test 2			
Parameter	Unit	Cell 1		Cell 2	
Timeslot Number		0	DwPTS	0	DwPTS
UTRA RF Channel Number		Channel 1		Channel 1	
PCCPCH_Ec/Ior	dB	-3		-3	
DwPCH_Ec/Ior	dB		0		0
OCNS_Ec/Ior	dB	-3		-3	
$\hat{I}_{or}/I_{oc}$	dB	9		2	
$I_{oc}$	dBm/ 1,28 MHz	-60.2			
PCCPCH RSCP, Note 1	dBm	-54.2		-61.2	
Io, Note 1	dBm/ 1,28 MHz	-50			
Propagation condition		AWGN			
		Test 3			
Parameter	Unit	Cell 1		Cell 2	
Timeslot Number		0	DwPTS	0	DwPTS
UTRA RF Channel Number		Channel 1		Channel 1	
PCCPCH_Ec/Ior	dB	-3		-3	
DwPCH_Ec/Ior	dB		0		0
OCNS_Ec/Ior	dB	-3		-3	
$\hat{I}_{or}/I_{oc}$	dB	5		3	
$I_{oc}$	dBm/ 1,28 MHz	-101.9			
PCCPCH RSCP, Note 1	dBm	-99.9		-101.9	
Io, Note 1	dBm/ 1,28 MHz	-94			
Propagation condition		AWGN			
NOTE 1: PCCPCH RSCP and Io levels have been calculated from other parameters for information purposes. They are not settable parameters themselves.					

- 1) A call is set up according to the test procedure specified in TS 34.108 [3] clause 7.3.2.3. The RF parameters for Test 1 are set up according to table 8.7.1.1A.1.2.

#### 8.7.1.1A.1.4.2 Procedure

- 1) SS shall transmit MEASUREMENT CONTROL message.
- 2) UE shall transmit periodically MEASUREMENT REPORT messages.
- 3) SS shall check PCCPCH\_RSCP value in MEASUREMENT REPORT messages. PCCPCH\_RSCP power of Cell 1 reported by UE is compared to actual PCCPCH\_RSCP power for each MEASUREMENT REPORT message.

- 4) SS shall count number of MEASUREMENT REPORT messages transmitted by UE. After 1000 MEASUREMENT REPORT messages have been received from UE, the RF parameters are set up according to table 8.7.1.1A.1.2 for Test 2. While RF parameters are being set up, MEASUREMENT REPORT messages from UE are ignored. SS shall wait for additional 1s and ignore the MEASUREMENT REPORT messages during this period. Then, step 3) above is repeated. After further 1000 MEASUREMENT REPORT messages have been received from UE, the RF parameters are set up according to table 8.7.1.1A.1.2 for Test 3. While RF parameters are being set up, MEASUREMENT REPORT messages from UE are ignored. SS shall wait for additional 1s and ignore the MEASUREMENT REPORT messages during this period. Then, step 3) above is repeated.
- 5) After further 1000 MEASUREMENT REPORT messages have been received from UE, the SS shall transmit RRC CONNECTION RELEASE message.
- 6) UE shall transmit RRC CONNECTION RELEASE COMPLETE message.

#### Specific Message Contents

All messages indicated above shall use the same content as described in the default message content in clause 9 of 34.108 [3] and in Annex I, with the following exceptions:

MEASUREMENT CONTROL message (Step 1):

Information Element/Group name	Value/Remark
Message Type (10.2.17)	
UE information elements	
-RRC transaction identifier	0
-Integrity check info	Not Present
Measurement Information elements	
-Measurement Identity	1
-Measurement Command (10.3.7.46)	setup
-Measurement Reporting Mode (10.3.7.49)	
-Measurement Report Transfer Mode	AM RLC
-Periodical Reporting / Event Trigger Reporting Mode	Periodical reporting
-Additional measurements list (10.3.7.1)	Not Present
-CHOICE <i>Measurement type</i>	Intra-frequency measurement
-Intra-frequency measurement (10.3.7.36)	
-Intra-frequency measurement objects list (10.3.7.33)	Not Present
-Intra-frequency measurement quantity (10.3.7.38)	
-Filter coefficient (10.3.7.9)	0
-CHOICE <i>mode</i>	TDD
-Measurement quantity list	1
-Measurement quantity	Primary CCPCH RSCP
-Intra-frequency reporting quantity (10.3.7.41)	
-Reporting quantities for active set cells (10.3.7.5)	
-SFN-SFN observed time difference reporting indicator	No report
-Cell synchronisation information reporting indicator	FALSE
-Cell Identity reporting indicator	TRUE
-CHOICE <i>mode</i>	TDD
-Timeslot ISCP reporting indicator	FALSE
-Primary CCPCH RSCP reporting indicator	TRUE
-Pathloss reporting indicator	FALSE
-Reporting quantities for monitored set cells (10.3.7.5)	
-SFN-SFN observed time difference reporting indicator	No report
-Cell synchronisation information reporting indicator	FALSE
-Cell Identity reporting indicator	TRUE
-CHOICE <i>mode</i>	TDD
-Timeslot ISCP reporting indicator	FALSE
-Proposed TGSN reporting required	FALSE
-Primary CCPCH RSCP reporting indicator	TRUE
-Pathloss reporting indicator	FALSE
-Reporting quantities for detected set cells (10.3.7.5)	Not Present
-Reporting cell status (10.3.7.61)	
-CHOICE <i>reported cell</i>	Report all active set cells + cells within monitored set on used frequency
-Maximum number of reported cells	1
-Measurement validity (10.3.7.51)	Not Present
-CHOICE <i>report criteria</i> (10.3.7.	
-Periodical reporting criteria (10.3.7.53)	
-Amount of reporting	Infinity
-Reporting interval	250 ms
Physical channel information elements	
-DPCH compressed mode status info (10.3.6.34)	Not Present

#### 8.7.1.1A.1.5 Test requirements

The PCCPCH RSCP measurement accuracy shall meet the requirements in clause 8.7.1.1A.1.2 for at least 900 of the measurement reports at each input level in step 4.

NOTE: If the above Test Requirement differs from the Minimum Requirement then the Test Tolerance applied for this test is non-zero. The Test Tolerance for this test is defined in clause F.2 and the explanation of how the Minimum Requirement has been relaxed by the Test Tolerance is given in clause F.4.



### 8.7.1.1A.2 Relative accuracy requirement

#### 8.7.1.1A.2.1 Definition and applicability

The relative accuracy of PCCPCH RSCP is defined as the PCCPCH RSCP measured from one cell compared to the PCCPCH RSCP measured from another cell on the same frequency.

The requirements and this test apply to all types of UTRA TDD UE 1,28 Mcps option.

#### 8.7.1.1A.2.2 Minimum Requirements

The relative accuracy requirements in table 8.7.1.1A.2.1 are valid under the following conditions:

P-CCPCH RSCP  $\geq$  -102 dBm.

$$\left( \frac{P - CCPCH - E_c}{I_o} \right) \Big|_{in \text{ dB}} \geq -8dB$$

$$\left( \frac{DwPCH - E_c}{I_o} \right) \Big|_{in \text{ dB}} \geq -5dB$$

$$\left| P - CCPCH \text{ RSCP1} \Big|_{in \text{ dBm}} - P - CCPCH \text{ RSCP2} \Big|_{in \text{ dBm}} \right| \leq 8dB$$

It is assumed that the measurements of P-CCPCH RSCP1 and P-CCPCH RSCP2 can be performed within 20ms due to slot allocations in the cells concerned.

**Table 8.7.1.1A.2.1: P-CCPCH\_RSCP intra-frequency relative accuracy**

Parameter	Unit	Accuracy [dB]		Condition s
		Normal condition	Extreme condition	Io [dBm /1.28 MHz]
P-CCPCH_RSCP	dBm	$\pm 3$	$\pm 3$	-94...-50

The normative reference for this requirement is TS 25.123 [2] clauses 9.1.1.1.2 and A.9.2.1.1.1.

#### 8.7.1.1A.2.3 Test Purpose

The purpose of this test is to verify that the relative P-CCPCH RSCP measurement accuracy is within the specified limits.

#### 8.7.1.1A.2.4 Method of test

##### 8.7.1.1A.2.4.1 Initial conditions

Test environment: normal, TL/VL, TL/VH, TH/VL, TH/VH; see clauses G.2.1 and G.2.2.

Frequencies to be tested: mid range; see clause G.2.4.

In this case all cells are on the same frequency. Cell 1 and cell 2 shall be synchronised, i.e. share the same frame and timeslot timing. The DL DPCH shall be transmitted in timeslot 5 and the UL DPCH shall be transmitted in timeslot 2. P-CCPCH RSCP intra frequency relative accuracy requirements are tested by using test parameters in table 8.7.1.1A.1.2.

- 1) A call is set up according to the test procedure specified in TS 34.108 [3] clause 7.3.2.3. The RF parameters for Test 1 are set up according to table 8.7.1.1A.1.2.

##### 8.7.1.1A.2.4.2 Procedure

- 1) SS shall transmit MEASUREMENT CONTROL message.

- 2) UE shall transmit periodically MEASUREMENT REPORT messages.
- 3) SS shall check PCCPCH\_RSCP value of Cell 1 and Cell 2 in MEASUREMENT REPORT messages. PCCPCH RSCP power value measured from Cell 1 is compared to PCCPCH RSCP power value measured from Cell 2 for each MEASUREMENT REPORT message.
- 4) The result of step 3) is compared to actual power level difference of PCCPCH RSCP of Cell 1 and Cell 2.
- 5) SS shall count number of MEASUREMENT REPORT messages transmitted by UE. After 1000 MEASUREMENT REPORT messages have been received from UE, the RF parameters are set up according to table 8.7.1.1A.1.2 for Test 2. While RF parameters are being set up, MEASUREMENT REPORT messages from UE are ignored. SS shall wait for additional 1s and ignore the MEASUREMENT REPORT messages during this period. Then, steps 3) and 4) above are repeated. After further 1000 MEASUREMENT REPORT messages have been received from UE, the RF parameters are set up according to table 8.7.1.1A.1.2 for Test 3. While RF parameters are being set up, MEASUREMENT REPORT messages from UE are ignored. SS shall wait for additional 1s and ignore the MEASUREMENT REPORT messages during this period. Then, steps 3) and 4) above are repeated.
- 6) After further 1000 MEASUREMENT REPORT messages have been received from UE, the SS shall transmit RRC CONNECTION RELEASE message.
- 7) UE shall transmit RRC CONNECTION RELEASE COMPLETE message.

### Specific Message Contents

All messages indicated above shall use the same content as described in the default message content in clause 9 of 34.108 [3] and in Annex I, with the following exceptions:

MEASUREMENT CONTROL message for intra frequency measurement in clause 8.7.1.1A.1.4.2 shall be used.

#### 8.7.1.1A.2.5 Test requirements

The PCCPCH RSCP measurement accuracy shall meet the requirements in clause 8.7.1.1A.2.2 for at least 900 of the measurement reports at each input level in step 4.

**NOTE:** If the above Test Requirement differs from the Minimum Requirement then the Test Tolerance applied for this test is non-zero. The Test Tolerance for this test is defined in clause F.2 and the explanation of how the Minimum Requirement has been relaxed by the Test Tolerance is given in clause F.4.

#### 8.7.1.1A.3 Absolute accuracy requirement with two neighbouring cells

##### 8.7.1.1A.3.1 Definition and applicability

The absolute accuracy of P-CCPCH RSCP is defined as the P-CCPCH RSCP measured from one cell compared to the actual P-CCPCH RSCP power from the same cell.

##### 8.7.1.1A.3.2 Minimum Requirements

In each case, at least 900 of the 1000 measurement reports must meet the requirements.

##### 8.7.1.1A.3.3 Test purpose

The purpose of the test is to verify that in multi-cell environment with frequency offset, phase offset, and inter-cell delay, the P-CCPCH RSCP absolute accuracy of all cells measured by the UE meets the requirements of the specifications. In this way, the multi-cell detection performance of the UE can be checked.

##### 8.7.1.1A.3.4 Method of test

###### 8.7.1.1A.3.4.1 Initial conditions

Test environment: normal; see clauses G.2.1 and G.2.2.

Frequencies to be tested: mid range; see clause G.2.4.

Cell condition:

Three 1.28Mcps TDD intra-frequency cells are configured.

Signal propagation condition: AWGN

P-CCPCH RSCP –102 dBm.

$$\left( \frac{P - CCPCH - E_c}{I_o} \right) \Big|_{in \text{ dB}} \geq -8dB$$

$$\left( \frac{DwPCH - E_c}{I_o} \right) \Big|_{in \text{ dB}} \geq -5dB$$

Table 8.7.1.1A.3.1: P-CCPCH RSCP Intra-frequency test parameters

Test 1							
Parameter	Unit	Cell 1		Cell 2		Cell 3	
Timeslot Number		0	DwPTS	0	DwPTS	0	DwPTS
UTRA RF Channel Number		Channel 1		Channel 1		Channel 1	
PCCPCH_Ec/lor	dB	-3		-3		-3	
DwPCH_Ec/lor	dB		0		0		0
OCNS_Ec/lor	dB	-3		-3		-3	
$\hat{I}_{or}/I_{oc}$	dB	9		3		1	
$I_{oc}$	dBm/ 1.28 MHz	-79.5					
PCCPCH RSCP (Note 1)	dBm	-73.5		-79.5		-81.5	
Io (Note 1)	dBm/ 1.28 MHz	-69					
Initial Time Delay ( $C_{init}$ ) (Note 2)	Chip	1		5		7	
Initial Frequency Shift ( $f_{init}$ ) (Note 3)	Hz	20		40		-40	
Initial Phase ( $\phi_{init}$ ) (Note 4)	Degree	0		$\pi/2$		$\pi$	
Propagation condition		AWGN					
Test 2							
Parameter	Unit	Cell 1		Cell 2		Cell 3	
Timeslot Number		0	DwPTS	0	DwPTS	0	DwPTS
UTRA RF Channel Number		Channel 1		Channel 1		Channel 1	
PCCPCH_Ec/lor	dB	-3		-3		-3	
DwPCH_Ec/lor	dB		0		0		0
OCNS_Ec/lor	dB	-3		-3		-3	
$\hat{I}_{or}/I_{oc}$	dB	7		7		1	
$I_{oc}$	dBm/ 1.28 MHz	-60.5					
PCCPCH RSCP (Note 1)	dBm	-56.5		-56.5		-62.5	
Io (Note 1)	dBm/ 1.28 MHz	-50					
Initial Time Delay ( $C_{init}$ ) (Note 2)	Chip	1		5		7	
Initial Frequency Shift ( $f_{init}$ ) (Note 3)	Hz	20		40		-40	
Initial Phase ( $\phi_{init}$ ) (Note 4)	Degree	0		$\pi/2$		$\pi$	
Propagation condition		AWGN					
Test 3							
Parameter	Unit	Cell 1		Cell 2		Cell 3	
Timeslot Number		0	DwPTS	0	DwPTS	0	DwPTS
UTRA RF Channel Number		Channel 1		Channel 1		Channel 1	
PCCPCH_Ec/lor	dB	-3		-3		-3	

DwPCH_Ec/lor	dB		0		0		0
OCNS_Ec/lor	dB	-3		-3		-3	
$\hat{I}_{or}/I_{oc}$	dB	3		3		3	
$I_{oc}$	dBm/ 1.28 MHz	-101.8					
PCCPCH RSCP (Note 1)	dBm	-101.8		-101.8		-101.8	
Io (Note 1)	dBm/ 1.28 MHz	-94					
Initial Time Delay ( $c_{init}$ ) (Note 2)	Chip	1		5		7	
Initial Frequency Shift ( $f_{init}$ ) (Note 3)	Hz	20		40		-40	
Initial Phase ( $\phi_{init}$ ) (Note 4)	Degree	0		$\pi/2$		$\pi$	
Propagation condition		AWGN					

Note 1: PCCPCH RSCP and Io levels are calculated from other parameters for information purposes.

Note 2: The delay of each base station ( $c$ ) is moving between [0chips, 2chips] around the base point,

that is, the initial cell delay ( $c_{init}$ ). The delay variation interval is  $\frac{1}{8}$  chip / 5ms.  $c_n$  is the current subframe delay. The definition is as follows:

$$\begin{cases} c_n = c_{init} + \frac{1}{8} \times (n \bmod 16), & \lfloor n/16 \rfloor \bmod 2 = 0 \\ c_n = c_{init} + 2 - \frac{1}{8} \times (n \bmod 16), & \lfloor n/16 \rfloor \bmod 2 = 1 \end{cases}$$

Here,  $n$  is the difference between the current subframe and initial subframe in the cell.

Note 3: Frequency offset ( $f$ ) is the difference between the actual transmit frequency and the nominal frequency in the cell.  $f_{init}$  is the frequency offset of the initial subframe,  $f_n$  is the frequency offset of the current subframe, and  $f_{n+1}$  is the frequency offset of the next subframe. The frequency offset variation interval is 1Hz / 5ms. The definition is as follows:

$$\begin{cases} f_{n+1} = f_n + \Delta \\ \Delta_{init} = 1 \\ \Delta = -\Delta, \text{ (if } f_n = \pm 100\text{Hz)} \end{cases}$$

Here,  $n$  is the difference between the current subframe and initial subframe in the cell.

Note 4: The cell phase ( $\phi$ ) is changing continuously in the range of  $[0, 2\pi)$ .  $\phi_{init}$  is the initial phase of the cell,  $\phi_n$  is the current subframe cell phase, and the phase variation interval is

$$\frac{\pi}{16} / 5\text{ms}. \text{ The definition is as follows:}$$

$$\phi_n = (\phi_{init} + n \times \frac{\pi}{16}) \bmod 2\pi$$

Here,  $n$  is the difference between the current subframe and initial subframe in the cell.

MEASUREMENT CONTROL message in P-CCPCH RSCP absolute accuracy measurement (step 1)

Information Element/Group Name	Value/Remark
Message Type (10.2.17)	
UE information elements	
-RRC transaction identifier	0
-Integrity check info	Not Present
Measurement Information elements	
-Measurement Identity	1
-Measurement Command (10.3.7.46)	setup
-Measurement Reporting Mode (10.3.7.49)	
-Measurement Report Transfer Mode	AM RLC
-Periodical Reporting/Event Trigger Reporting Mode	Periodical reporting
-Additional measurements list (10.3.7.1)	Not Present
-CHOICE Measurement type	Intra-frequency measurement
-Intra-frequency measurement (10.3.7.36)	
-Intra-frequency measurement objects list (10.3.7.33)	Not Present
-Intra-frequency measurement quantity (10.3.7.38)	
-Filter coefficient (10.3.7.9)	0
-CHOICE mode	TDD
-Measurement quantity list	1
-Measurement quantity	Primary CCPCH RSCP
-Intra-frequency reporting quantity (10.3.7.41)	
-Reporting quantities for active set cells (10.3.7.5)	
-SFN-SFN observed time difference reporting indicator	No report
-Cell synchronization information reporting indicator	FALSE
-Cell Identity reporting indicator	TRUE
-CHOICE mode	TDD
-Timeslot ISCP reporting indicator	FALSE
-Primary CCPCH RSCP reporting indicator	TRUE
-Pathloss reporting indicator	FALSE
-Reporting quantities for monitored set cells (10.3.7.5)	
-SFN-SFN observed time difference reporting indicator	No report
-Cell synchronization information reporting indicator	FALSE
-Cell Identity reporting indicator	TRUE
-CHOICE mode	TDD
-Timeslot ISCP reporting indicator	FALSE
-Proposed TGSN reporting required	FALSE
-Primary CCPCH RSCP reporting indicator	TRUE
-Pathloss reporting indicator	FALSE
-Reporting quantities for detected set cells (10.3.7.5)	Not Present
-Reporting cell status (10.3.7.61)	
-CHOICE reported cell	Report all active set cells + cells within monitored set on used frequency
-Maximum number of reported cells	2
-Measurement validity (10.3.7.51)	Not Present
-CHOICE report criteria (10.3.7.	
-Periodical reporting criteria (10.3.7.53)	
-Amount of reporting	Infinity
-Reporting interval	250 ms
Physical channel information elements	
-DPCH compressed mode status info (10.3.6.34)	Not Present

#### 8.7.1.1A.3.4.2 Procedure

- 1) A call is set up according to the test procedure specified in 3GPP TS 34.108 sub-clause 7.3.2.3.
- 2) The RF parameters for Test 1 are set up according to table1.
- 3) SS shall transmit MEASUREMENT CONTROL message.
- 4) UE shall transmit periodically MEASUREMENT REPORT messages.

- 5) SS shall check PCCPCH\_RSCP value in MEASUREMENT REPORT messages. PCCPCH\_RSCP power of Cell 1, Cell 2, and Cell 3 reported by UE is compared to actual PCCPCH\_RSCP power for each MEASUREMENT REPORT message.
- 6) SS shall count number of MEASUREMENT REPORT messages transmitted by UE. After 1000 MEASUREMENT REPORT messages have been received from UE, the RF parameters are set up according to table1 for Test 2. While RF parameters are set up, MEASUREMENT REPORT messages from UE are ignored. SS shall wait for additional 1s and ignore the MEASUREMENT REPORT messages during this period. Then, repeat steps 3 and 4. After further 1000 MEASUREMENT REPORT messages have been received from UE, the RF parameters are set up according to table1 for Test 3. While RF parameters are set up, MEASUREMENT REPORT messages from UE are ignored. SS shall wait for additional 1s and ignore the MEASUREMENT REPORT messages during this period. Then, repeat steps 3 and 4.
- 7) After further 1000 MEASUREMENT REPORT messages have been received from UE, the SS shall transmit RRC CONNECTION RELEASE message.
- 8) UE shall transmit RRC CONNECTION RELEASE COMPLETE message.

#### 8.7.1.1A.3.5 Test requirements

##### P-CCPCH\_RSCP intra-frequency measurement accuracy

Parameter	Unit	Accuracy [dB]		Conditions
		Normal condition	Extreme condition	Io [dBm/ 1.28 MHz]
P-CCPCH_RSCP	dBm	± 6	± 9	-94...-70
	dBm	± 8	± 11	-70...-50

In each case, at least 900 of the 1000 measurement reports must meet the requirements.

#### 8.7.1.1B Intra frequency measurement accuracy for 7,68 Mcps TDD Option

##### 8.7.1.1B.1 Absolute accuracy requirement

###### 8.7.1.1B.1.1 Definition and applicability

The absolute accuracy of P-CCPCH RSCP is defined as the P-CCPCH RSCP measured from one cell compared to the actual P-CCPCH RSCP power from the same cell.

The requirements and this test apply to all types of UTRA TDD UE.

###### 8.7.1.1B.1.2 Minimum Requirements

The absolute accuracy requirements in table 8.7.1.1B.1.2.1 are valid under the following conditions:

P-CCPCH RSCP ≥ -102 dBm.

$$\left( \frac{P-CCPCH - E_c}{I_o} \right)_{in \text{ dB}} \geq -11dB$$

$$\left( \frac{SCH - E_c}{I_o} \right)_{in \text{ dB}} \geq -13dB$$

**Table 8.7.1.1B.1.2.1: P-CCPCH\_RSCP absolute accuracy**

Parameter	Unit	Accuracy [dB]		Conditions
		Normal condition	Extreme condition	Io [dBm/3.84MHz]
P-CCPCH_RSCP	dBm	± 6	± 9	-94...-70
	dBm	± 8	± 11	-70...-50

The normative reference for this requirement is TS 25.123 [2] clauses 9.1.1.1.3 and A.9.3.1.1.1.

#### 8.7.1.1B.1.3 Test Purpose

The purpose of this test is to verify that the absolute P-CCPCH RSCP measurement accuracy is within the specified limits.

#### 8.7.1.1B.1.4 Method of test

##### 8.7.1.1B.1.4.1 Initial conditions

Test environment: normal, TL/VL, TL/VH, TH/VL, TH/VH; see clauses G.2.1 and G.2.2.

Frequencies to be tested: mid range; see clause G.2.4.

In this case all cells are on the same frequency. Cell 1 and cell 2 shall be synchronised, i.e. share the same frame and timeslot timing. The DL DPCH shall be transmitted in timeslot 4 and the UL DPCH shall be transmitted in timeslot 12. The second Beacon timeslot shall be provided in timeslot 8 for both cell 1 and cell 2. P-CCPCH RSCP intra frequency absolute accuracy requirements are tested by using test parameters in table 8.7.1.1B.1.4.1.1.

**Table 8.7.1.1B.1.4.1.1: P-CCPCH RSCP intra frequency test parameters**

Parameter	Unit	Test 1		Test 2		Test 3	
		Cell 1	Cell 2	Cell 1	Cell 2	Cell 1	Cell 2
DL timeslot number		0	0	0	0	0	0
UTRA RF Channel number		Channel 1		Channel 1		Channel 1	
PCCPCH_Ec/Ior	dB	-3		-3		-3	
SCH_Ec/Ior	dB	-9		-9		-9	
SCH_t <sub>offset</sub>		0	5	0	5	0	5
OCNS_Ec/Ior	dB	-3,12		-3,12		-3,12	
Ioc	dBm / 7.68 MHz	-75.7		-59.8		-98.7	
Ior/Ioc	dB	5	2	9	2	3	0
PCCPCH RSCP, Note 1	dBm	-73.7	-76.7	-53.8	-60.8	-98.7	-101.7
Io, Note 1	dBm / 7.68 MHz	-69		-50		-94	
Propagation condition		AWGN		AWGN		AWGN	
NOTE 1: PCCPCH RSCP and Io levels have been calculated from other parameters for information purposes. They are not settable parameters themselves.							

- 1) A call is set up according to the test procedure specified in TS 34.108 [3] clause 7.3.2.3. The RF parameters for Test 1 are set up according to table 8.7.1.1B.1.4.1.1.

#### 8.7.1.1B.1.4.2 Procedure

- 1) SS shall transmit MEASUREMENT CONTROL message.
- 2) UE shall transmit periodically MEASUREMENT REPORT messages.
- 3) SS shall check PCCPCH\_RSCP value in MEASUREMENT REPORT messages. PCCPCH\_RSCP power of Cell 1 reported by UE is compared to actual PCCPCH\_RSCP power for each MEASUREMENT REPORT message.
- 4) SS shall count number of MEASUREMENT REPORT messages transmitted by UE. After 1000 MEASUREMENT REPORT messages have been received from UE, the RF parameters are set up according to table 8.7.1.1.1.2 for Test 2. While RF parameters are being set up, MEASUREMENT REPORT messages from UE are ignored. SS shall wait for additional 1s and ignore the MEASUREMENT REPORT messages during this period. Then, steps 2) and 3) above are repeated. After further 1000 MEASUREMENT REPORT messages have been received from UE, the RF parameters are set up according to table 8.7.1.1.1.2 for Test 3. While RF parameters are being set up, MEASUREMENT REPORT messages from UE are ignored. SS shall wait for additional 1s and ignore the MEASUREMENT REPORT messages during this period. Then, steps 2) and 3) above are repeated.
- 5) After further 1000 MEASUREMENT REPORT messages have been received from UE, the SS shall transmit RRC CONNECTION RELEASE message.
- 6) UE shall transmit RRC CONNECTION RELEASE COMPLETE message.



## Specific Message Contents

All messages indicated above shall use the same content as described in the default message content in clause 9 of 34.108 [3] and in Annex I, with the following exceptions:

## MEASUREMENT CONTROL message (Step 1):

Information Element/Group name	Value/Remark
Message Type (10.2.17)	
UE information elements -RRC transaction identifier -Integrity check info	0 Not Present
Measurement Information elements -Measurement Identity -Measurement Command (10.3.7.46) -Measurement Reporting Mode (10.3.7.49) -Measurement Report Transfer Mode -Periodical Reporting / Event Trigger Reporting Mode -Additional measurements list (10.3.7.1)	1 Modify AM RLC Periodical reporting Not Present
-CHOICE <i>Measurement type</i> -Intra-frequency measurement (10.3.7.36) -Intra-frequency measurement objects list (10.3.7.33) -Intra-frequency measurement quantity (10.3.7.38) -Filter coefficient (10.3.7.9) -CHOICE <i>mode</i> -Measurement quantity list	Intra-frequency measurement Not Present 0 TDD 1
-Measurement quantity	Primary CCPCH RSCP
-Intra-frequency reporting quantity (10.3.7.41)	
-Reporting quantities for active set cells (10.3.7.5) -SFN-SFN observed time difference reporting indicator -Cell synchronisation information reporting indicator -Cell Identity reporting indicator -CHOICE <i>mode</i> -Timeslot ISCP reporting indicator -Primary CCPCH RSCP reporting indicator -Pathloss reporting indicator	No report FALSE TRUE TDD FALSE TRUE FALSE
-Reporting quantities for monitored set cells (10.3.7.5) -SFN-SFN observed time difference reporting indicator -Cell synchronisation information reporting indicator -Cell Identity reporting indicator -CHOICE <i>mode</i> -Timeslot ISCP reporting indicator -Proposed TGSN reporting required -Primary CCPCH RSCP reporting indicator -Pathloss reporting indicator	No report FALSE TRUE TDD FALSE FALSE TRUE FALSE
-Reporting quantities for detected set cells (10.3.7.5)	Not Present
-Reporting cell status (10.3.7.61) -CHOICE <i>reported cell</i>  -Maximum number of reported cells -Measurement validity (10.3.7.51) -CHOICE <i>report criteria</i> -Periodical reporting criteria (10.3.7.53) -Amount of reporting -Reporting interval	Report all active set cells + cells within monitored set on used frequency 1 Not Present Infinity 250 ms
Physical channel information elements -DPCH compressed mode status info (10.3.6.34)	Not Present

## 8.7.1.1B.1.5 Test requirements

The PCCPCH RSCP measurement accuracy shall meet the requirements in clause 8.7.1.1B.1.2 for at least 900 of the measurement reports at each input level in step 4.

NOTE: If the above Test Requirement differs from the Minimum Requirement then the Test Tolerance applied for this test is non-zero. The Test Tolerance for this test is defined in clause F.2 and the explanation of how the Minimum Requirement has been relaxed by the Test Tolerance is given in clause F.4.

### 8.7.1.1B.2 Relative accuracy requirement

#### 8.7.1.1B.2.1 Definition and applicability

The relative accuracy of PCCPCH RSCP is defined as the PCCPCH RSCP measured from one cell compared to the PCCPCH RSCP measured from another cell on the same frequency.

The requirements and this test apply to all types of UTRA TDD UE.

#### 8.7.1.1B.2.2 Minimum Requirements

The relative accuracy requirements in table 8.7.1.1B.2.2.1 are valid under the following conditions:

P-CCPCH RSCP  $\geq$  -102 dBm.

$$\left( \frac{P - CCPCH - E_c}{I_o} \right) \Big|_{in \text{ dB}} \geq -11 \text{ dB}$$

$$\left( \frac{SCH - E_c}{I_o} \right) \Big|_{in \text{ dB}} \geq -13 \text{ dB}$$

$$\left| P - CCPCH \text{ RSCP1} \Big|_{in \text{ dB}} - P - CCPCH \text{ RSCP2} \Big|_{in \text{ dB}} \right| \leq 20 \text{ dB}$$

Relative  $I_o$  difference [dB]  $\leq$  relative RSCP difference [dB]

It is assumed that the measurements of P-CCPCH RSCP1 and P-CCPCH RSCP2 can be performed within 20ms due to slot allocations in the cells concerned.

**Table 8.7.1.1B.2.2.1: P-CCPCH\_RSCP intra-frequency relative accuracy**

Parameter	Unit	Accuracy [dB]		Conditions	
		Normal condition	Extreme condition	Io [dBm/ 7.68MHz]	relative RSCP difference [dB]
P-CCPCH_RSCP	dBm	$\pm 1$	$\pm 1$	-94...-50	<2
		$\pm 2$	$\pm 2$		2...14
		$\pm 3$	$\pm 3$		>14

The normative reference for this requirement is TS 25.123 [2] clauses 9.1.1.1.2.3 and A.9.3.1.1.1.

#### 8.7.1.1B.2.3 Test Purpose

The purpose of this test is to verify that the relative P-CCPCH RSCP measurement accuracy is within the specified limits.

#### 8.7.1.1B.2.4 Method of test

##### 8.7.1.1B.2.4.1 Initial conditions

Test environment: normal, TL/VL, TL/VH, TH/VL, TH/VH; see clauses G.2.1 and G.2.2.

Frequencies to be tested: mid range; see clause G.2.4.

In this case all cells are on the same frequency. Cell 1 and cell 2 shall be synchronised, i.e. share the same frame and timeslot timing. The DL DPCH shall be transmitted in timeslot 4 and the UL DPCH shall be transmitted in timeslot 12. The second Beacon timeslot shall be provided in timeslot 8 for both cell 1 and cell 2. P-CCPCH RSCP intra frequency relative accuracy requirements are tested by using test parameters in table 8.7.1.1B.1.4.1.1.

- 1) A call is set up according to the test procedure specified in TS 34.108 [3] clause 7.3.2.3. The RF parameters for Test 1 are set up according to table 8.7.1.1.1.2.

#### 8.7.1.1B.2.4.2 Procedure

- 1) SS shall transmit MEASUREMENT CONTROL message.
- 2) UE shall transmit periodically MEASUREMENT REPORT messages.
- 3) SS shall check PCCPCH\_RSCP value of Cell 1 and Cell 2 in MEASUREMENT REPORT messages. PCCPCH RSCP power value measured from Cell 1 is compared to PCCPCH RSCP power value measured from Cell 2 for each MEASUREMENT REPORT message.
- 4) The result of step 3) is compared to actual power level difference of PCCPCH RSCP of Cell 1 and Cell 2.
- 5) SS shall count number of MEASUREMENT REPORT messages transmitted by UE. After 1000 MEASUREMENT REPORT messages have been received from UE, the RF parameters are set up according to table 8.7.1.1.1.2 for Test 2. While RF parameters are being set up, MEASUREMENT REPORT messages from UE are ignored. SS shall wait for additional 1s and ignore the MEASUREMENT REPORT messages during this period. Then, steps 3) and 4) above are repeated. After further 1000 MEASUREMENT REPORT messages have been received from UE, the RF parameters are set up according to table 8.7.1.1.1.2 for Test 3. While RF parameters are being set up, MEASUREMENT REPORT messages from UE are ignored. SS shall wait for additional 1s and ignore the MEASUREMENT REPORT messages during this period. Then, steps 3) and 4) above are repeated.
- 6) After further 1000 MEASUREMENT REPORT messages have been received from UE, the SS shall transmit RRC CONNECTION RELEASE message.
- 7) UE shall transmit RRC CONNECTION RELEASE COMPLETE message.

#### Specific Message Contents

All messages indicated above shall use the same content as described in the default message content in clause 9 of 34.108 [3] and in Annex I, with the following exceptions:

MEASUREMENT CONTROL message for intra frequency measurement in clause 8.7.1.1B.1.4.2 shall be used.

#### 8.7.1.1B.2.5 Test requirements

The PCCPCH RSCP measurement accuracy shall meet the requirements in clause 8.7.1.1B.2.2 for at least 900 of the measurement reports at each input level in step 4.

NOTE: If the above Test Requirement differs from the Minimum Requirement then the Test Tolerance applied for this test is non-zero. The Test Tolerance for this test is defined in clause F.2 and the explanation of how the Minimum Requirement has been relaxed by the Test Tolerance is given in clause F.4.

### 8.7.1.2 Inter frequency measurement accuracy for 3,84 Mcps TDD Option

#### 8.7.1.2.1 Relative accuracy requirement

##### 8.7.1.2.1.1 Definition and applicability

The P-CCPCH\_RSCP inter-frequency relative accuracy is defined as the P-CCPCH\_RSCP measured from one cell compared to the P-CCPCH\_RSCP measured from another cell on a different frequency.

The requirements and this test apply to all types of UTRA TDD UE.

##### 8.7.1.2.1.2 Minimum Requirements

The relative accuracy requirements in table 8.7.1.2.1.1 are valid under the following conditions:

P-CCPCH RSCP  $\geq$  -102 dBm.

$$\left| P - \text{CCPCH RSCP1} \Big|_{in \text{ dB}} - P - \text{CCPCH RSCP2} \Big|_{in \text{ dB}} \right| \leq 20 \text{ dB}$$

$$\left( \frac{P - \text{CCPCH} - E_c}{I_o} \right)_{in \text{ dB}} \geq -8 \text{ dB}$$

$$\left( \frac{\text{SCH} - E_c}{I_o} \right)_{in \text{ dB}} \geq -13 \text{ dB}$$

**Table 8.7.1.2.1.1 P-CCPCH\_RSCP inter-frequency relative accuracy**

Parameter	Unit	Accuracy [dB]		Conditions I <sub>o</sub> [dBm/3.84MHz ]
		Normal condition	Extreme condition	
P-CCPCH_RSCP	dBm	± 6	± 6	-94...-50

The normative reference for this requirement is TS 25.123 [2] clauses 9.1.1.1.2 and A.9.1.1.

#### 8.7.1.2.1.3 Test Purpose

The purpose of this test is to verify that the relative P-CCPCH RSCP measurement accuracy is within the specified limits for the inter frequency case.

#### 8.7.1.2.1.4 Method of test

##### 8.7.1.2.1.4.1 Initial conditions

Test environment: normal, TL/VL, TL/VH, TH/VL, TH/VH; see clauses G.2.1 and G.2.2.

Frequencies to be tested: mid range; see clause G.2.4.

In this case both cells are on different frequencies. The second Beacon timeslot shall be provided in timeslot 8 for cell 1 and in timeslot 10 for cell 2. P-CCPCH RSCP inter frequency relative accuracy requirements are tested by using test parameters in table 8.7.1.2.1.2.

**Table 8.7.1.2.1.2: P-CCPCH RSCP inter frequency test parameters**

Parameter	Unit	Test 1		Test 2		Test 3	
		Cell 1	Cell 2	Cell 1	Cell 2	Cell 1	Cell 2
DL timeslot number		0	2	0	2	0	2
UTRA RF Channel number		Channel 1	Channel 2	Channel 1	Channel 2	Channel 1	Channel 2
PCCPCH_Ec/I <sub>or</sub>	dB	-3		-3		-3	
SCH_Ec/I <sub>or</sub>	dB	-9		-9		-9	
SCH_t <sub>offset</sub>		0	5	0	5	0	5
OCNS_Ec/I <sub>or</sub>	dB	-3,12		-3,12		-3,12	
I <sub>oc</sub>	dBm / 3,84 MHz	-75.2	-75.2	-57.8	-54.1	-98.7	-97
I <sub>or</sub> /I <sub>oc</sub>	dB	5	5	7	2	3	0
PCCPCH RSCP, Note 1	dBm	-73.2	-73.2	-54.8	-55.1	-98.7	-100
I <sub>o</sub> , Note 1	dBm / 3,84 MHz	-69		-50		-94	
Propagation condition		AWGN		AWGN		AWGN	
NOTE 1: PCCPCH RSCP and I <sub>o</sub> levels have been calculated from other parameters for information purposes. They are not settable parameters themselves.							

- 1) A call is set up according to the test procedure specified in TS 34.108 [3] clause 7.3.2.3. The RF parameters for Test 1 are set up according to table 8.7.1.2.1.2.

## 8.7.1.2.1.4.2 Procedure

- 1) SS shall transmit the MEASUREMENT CONTROL messages for intra frequency and inter frequency measurements.
- 2) UE shall transmit periodically MEASUREMENT REPORT messages.
- 3) SS shall check PCCPCH\_RSCP value of Cell 1 and Cell 2 in MEASUREMENT REPORT messages. PCCPCH RSCP power value measured from Cell 1 is compared to PCCPCH RSCP power value measured from Cell 2 for each MEASUREMENT REPORT message.
- 4) The result of step 3) is compared to actual power level difference of PCCPCH RSCP of Cell 1 and Cell 2.
- 5) SS shall count number of MEASUREMENT REPORT messages transmitted by UE. After 1000 MEASUREMENT REPORT messages have been received from UE, the RF parameters are set up according to table 8.7.1.2.1.2 for Test 2. While RF parameters are being set up, MEASUREMENT REPORT messages from UE are ignored. SS shall wait for additional 1s and ignore the MEASUREMENT REPORT messages during this period. Then, steps 3) and 4) above are repeated.
- 6) After further 1000 MEASUREMENT REPORT messages have been received from UE, the SS shall transmit RRC CONNECTION RELEASE message.
- 7) UE shall transmit RRC CONNECTION RELEASE COMPLETE message.

## Specific Message Contents

All messages indicated above shall use the same content as described in the default message content in clause 9 of 34.108 [3] and in Annex I, with the following exceptions:

First MEASUREMENT CONTROL message for intra frequency measurements (Step 1):

Information Element/Group name	Value/Remark
Message Type (10.2.17)	
UE information elements	
-RRC transaction identifier	0
-Integrity check info	Not Present
Measurement Information elements	
-Measurement Identity	1
-Measurement Command (10.3.7.46)	Modify
-Measurement Reporting Mode (10.3.7.49)	
-Measurement Report Transfer Mode	AM RLC
-Periodical Reporting / Event Trigger Reporting Mode	Periodical reporting
-Additional measurements list (10.3.7.1)	Not Present
-CHOICE <i>Measurement type</i>	Intra-frequency measurement
-Intra-frequency measurement (10.3.7.36)	
-Intra-frequency measurement objects list (10.3.7.33)	Not Present
-Intra-frequency measurement quantity (10.3.7.38)	
-Filter coefficient (10.3.7.9)	0
-CHOICE <i>mode</i>	TDD
-Measurement quantity list	1
-Measurement quantity	Primary CCPCH RSCP
-Intra-frequency reporting quantity (10.3.7.41)	
-Reporting quantities for active set cells (10.3.7.5)	
-SFN-SFN observed time difference reporting indicator	No report
-Cell synchronisation information reporting indicator	FALSE
-Cell Identity reporting indicator	FALSE
-CHOICE <i>mode</i>	TDD
-Timeslot ISCP reporting indicator	FALSE
-Primary CCPCH RSCP reporting indicator	TRUE
-Pathloss reporting indicator	FALSE
-Reporting quantities for monitored set cells (10.3.7.5)	
-SFN-SFN observed time difference reporting indicator	No report
-Cell synchronisation information reporting indicator	FALSE
-Cell Identity reporting indicator	FALSE
-CHOICE <i>mode</i>	TDD
-Timeslot ISCP reporting indicator	FALSE
-Proposed TGSN reporting required	FALSE
-Primary CCPCH RSCP reporting indicator	TRUE
-Pathloss reporting indicator	FALSE
-Reporting quantities for detected set cells (10.3.7.5)	Not Present
-Reporting cell status (10.3.7.61)	
-CHOICE <i>reported cell</i>	Report all active set cells + cells within monitored set on used frequency
-Maximum number of reported cells	1
-Measurement validity (10.3.7.51)	Not Present
-CHOICE <i>report criteria</i> (10.3.7.	
-Periodical reporting criteria (10.3.7.53)	
-Amount of reporting	Infinity
-Reporting interval	250 ms
Physical channel information elements	
-DPCH compressed mode status info (10.3.6.34)	Not Present

Second MEASUREMENT CONTROL message for inter frequency measurements (Step 1):

Information Element/Group name	Value/Remark
Message Type (10.2.17)	
<b>UE information elements</b>	
-RRC transaction identifier	0
-Integrity check info	Not Present
<b>Measurement Information elements</b>	
-Measurement Identity	2
-Measurement Command (10.3.7.46)	Setup
-Measurement Reporting Mode (10.3.7.49)	
-Measurement Report Transfer Mode	AM RLC
-Periodical Reporting / Event Trigger Reporting Mode	Periodical reporting
-Additional measurements list (10.3.7.1)	Not Present
-CHOICE <i>Measurement type</i>	Inter-frequency measurement
-Inter-frequency measurement (10.3.7.16)	
-Inter-frequency measurement objects list (10.3.7.13)	
-CHOICE <i>inter-frequency cell removal</i>	Not present
-New inter-frequency cells	Cell 2 information is included
-Cell for measurement	Not Present
-Inter-frequency measurement quantity (10.3.7.18)	
-CHOICE <i>reporting criteria</i>	Inter-frequency reporting criteria
-Filter coefficient (10.3.7.9)	0
-CHOICE <i>mode</i>	TDD
-Measurement quantity for frequency quality estimate	Primary CCPCH RSCP
-Inter-frequency reporting quantity (10.3.7.21)	
-UTRA carrier RSSI	FALSE
-Frequency quality estimate	TRUE
-Non frequency related cell reporting quantities (10.3.7.5)	
-SFN-SFN observed time difference reporting indicator	No report
-Cell synchronisation information reporting indicator	FALSE
-Cell identity reporting indicator	FALSE
-CHOICE <i>mode</i>	TDD
-Timeslot ISCP reporting indicator	FALSE
-Proposed TGSN Reporting required	FALSE
-Primary CCPCH RSCP reporting indicator	TRUE
-Pathloss reporting indicator	FALSE
-Reporting cell status (10.3.7.61)	
-CHOICE <i>reported cell</i>	Report all active set cells + cells within monitored set on used frequency
-Maximum number of reported cells	Virtual/active set cells + 2
-Measurement validity (10.3.7.51)	Not present
-Inter-frequency set update	Not present
-CHOICE <i>report criteria</i> (10.3.7.	
-Periodical reporting criteria (10.3.7.53)	
-Amount of reporting	Infinity
-Reporting interval	500 ms
<b>Physical channel information elements</b>	
-DPCH compressed mode status info (10.3.6.34)	Not Present

#### 8.7.1.2.1.5 Test requirements

The PCCPCH RSCP measurement accuracy shall meet the requirements in clause 8.7.1.2.1.2 for at least 900 of the measurement reports at each input level in step 4.

NOTE: If the above Test Requirement differs from the Minimum Requirement then the Test Tolerance applied for this test is non-zero. The Test Tolerance for this test is defined in clause F.2 and the explanation of how the Minimum Requirement has been relaxed by the Test Tolerance is given in clause F.4.

## 8.7.1.2A Inter frequency measurement accuracy for 1,28 Mcps TDD Option

### 8.7.1.2A.1 Relative accuracy requirement

#### 8.7.1.2A.1.1 Definition and applicability

The P-CCPCH\_RSCP inter-frequency relative accuracy is defined as the P-CCPCH\_RSCP measured from one cell compared to the P-CCPCH\_RSCP measured from another cell on a different frequency.

The requirements and this test apply to all types of UTRA TDD UE 1,28 Mcps option.

#### 8.7.1.2A.1.2 Minimum Requirements

The relative accuracy requirements in table 8.7.1.2A.1.1 are valid under the following conditions:

P-CCPCH RSCP  $\geq$  -102 dBm.

$$\left| P - CCPCH RSCP1 \Big|_{in\ dB} - P - CCPCH RSCP2 \Big|_{in\ dB} \right| \leq 20dB$$

$$\left( \frac{P - CCPCH - E_c}{I_o} \right) \Big|_{in\ dB} \geq -8dB$$

$$\left( \frac{DwPCH - E_c}{I_o} \right) \Big|_{in\ dB} \geq -5dB$$

**Table 8.7.1.2A.1.1 P-CCPCH\_RSCP inter-frequency relative accuracy**

Parameter	Unit	Accuracy [dB]		Conditions I <sub>o</sub> [dBm/1.28MHz ]
		Normal condition	Extreme condition	
P-CCPCH_RSCP	dBm	$\pm 6$	$\pm 6$	-94...-50

The rate of correct measurements observed during repeated tests shall be at least 90%.

The normative reference for this requirement is TS 25.123 [2] clauses 9.1.1.1.2 and A.9.2.1.

#### 8.7.1.2A.1.3 Test Purpose

The purpose of this test is to verify that the relative P-CCPCH RSCP measurement accuracy is within the specified limits for the inter frequency case.

#### 8.7.1.2A.1.4 Method of test

##### 8.7.1.2A.1.4.1 Initial conditions

Test environment: normal, TL/VL, TL/VH, TH/VL, TH/VH; see clauses G.2.1 and G.2.2.

Frequencies to be tested: mid range; see clause G.2.4.

In this case both cells are on different frequencies. P-CCPCH RSCP inter frequency relative accuracy requirements are tested by using test parameters in table 8.7.1.2A.1.2.



Table 8.7.1.2A.1.2: P-CCPCH RSCP Inter frequency test parameters

		Test 1			
Parameter	Unit	Cell 1		Cell 2	
Timeslot Number		0	DwPTS	0	DwPTS
UTRA RF Channel Number		Channel 1		Channel 2	
PCCPCH_Ec/Ior	dB	-3		-3	
DwPCH_Ec/Ior	dB		0		0
OCNS_Ec/Ior	dB	-3		-3	
$\hat{I}_{or}/I_{oc}$	dB	5		5	
$I_{oc}$	dBm/ 1,28 MHz	-75.2		-75.2	
PCCPCH RSCP, Note 1	dBm	-73.2		-73.2	
Io, Note 1	dBm/ 1,28 MHz	-69			
Propagation condition		AWGN			
		Test 2			
Parameter	Unit	Cell 1		Cell 2	
Timeslot Number		0	DwPTS	0	DwPTS
UTRA RF Channel Number		Channel 1		Channel 2	
PCCPCH_Ec/Ior	dB	-3		-3	
DwPCH_Ec/Ior	dB		0		0
OCNS_Ec/Ior	dB	-3		-3	
$\hat{I}_{or}/I_{oc}$	dB	7		2	
$I_{oc}$	dBm/ 1,28 MHz	-57.8		-54.1	
PCCPCH RSCP, Note 1	dBm	-53.8		-55.1	
Io, Note 1	dBm/ 1,28 MHz	-50			
Propagation condition		AWGN			
		Test 3			
Parameter	Unit	Cell 1		Cell 2	
Timeslot Number		0	DwPTS	0	DwPTS
UTRA RF Channel Number		Channel 1		Channel 2	
PCCPCH_Ec/Ior	dB	-3		-3	
DwPCH_Ec/Ior	dB		0		0
OCNS_Ec/Ior	dB	-3		-3	
$\hat{I}_{or}/I_{oc}$	dB	3		0	
$I_{oc}$	dBm/ 1,28 MHz	-98.7		-97	
PCCPCH RSCP, Note 1	dBm	-98.7		-100	
Io, Note 1	dBm/ 1,28 MHz	-94			
Propagation condition		AWGN			
NOTE 1: PCCPCH RSCP and Io levels have been calculated from other parameters for information purposes. They are not settable parameters themselves.					

- 1) A call is set up according to the test procedure specified in TS 34.108 [3] clause 7.3.2.3. The RF parameters for Test 1 are set up according to table 8.7.1.2A.1.2.

#### 8.7.1.2A.1.4.2 Procedure

- 1) SS shall transmit MEASUREMENT CONTROL message.
- 2) UE shall transmit periodically MEASUREMENT REPORT messages.

- 3) SS shall check PCCPCH\_RSCP value of Cell 1 and Cell 2 in MEASUREMENT REPORT messages. PCCPCH RSCP power value measured from Cell 1 is compared to PCCPCH RSCP power value measured from Cell 2 for each MEASUREMENT REPORT message.
- 4) The result of step 3) is compared to actual power level difference of PCCPCH RSCP of Cell 1 and Cell 2.
- 5) SS shall count number of MEASUREMENT REPORT messages transmitted by UE. After 1000 MEASUREMENT REPORT messages have been received from UE, the RF parameters are set up according to table 8.7.1.2A.1.2 for Test 2. While RF parameters are being set up, MEASUREMENT REPORT messages from UE are ignored. SS shall wait for additional 1s and ignore the MEASUREMENT REPORT messages during this period. Then, steps 3) and 4) above are repeated.
- 6) After further 1000 MEASUREMENT REPORT messages have been received from UE, the SS shall transmit RRC CONNECTION RELEASE message.
- 7) UE shall transmit RRC CONNECTION RELEASE COMPLETE message.

#### Specific Message Contents

All messages indicated above shall use the same content as described in the default message content in clause 9 of 34.108 [3], with the following exceptions:

First MEASUREMENT CONTROL message for Intra frequency measurement (Step 1):

Information Element	Value/Remark
Message Type	
UE information elements	
-RRC transaction identifier	0
Measurement Information elements	
-Measurement Identity	1
-Measurement Command	setup
-Measurement Reporting Mode	Acknowledged mode RLC
- Measurement Report Transfer Mode	Periodical reporting
- Periodical Reporting / Event Trigger Reporting Mode	Not Present
-Additional measurement list	Intra-frequency measurement
-CHOICE Measurement Type	
-Intra-frequency measurement	
- Intra-frequency measurement objects list	Not Present
-Intra-frequency cell info list	
-Intra-frequency measurement quantity	0
-Filter coefficient	TDD
-CHOICE mode	PCCPCH RSCP
-Measurement quantity	
-Intra-frequency reporting quantity	
-Reporting quantities for active set cells	TRUE
-Cell synchronisation information reporting indicator	TRUE
-Cell Identity reporting indicator	TDD
-CHOICE mode	FALSE
- Timeslot ISCP reporting indicator	FALSE
- Proposed TGSN Reporting required	TRUE
- Primary CCPCH RSCP reporting indicator	FALSE
-Pathloss reporting indicator	
-Reporting quantities for monitored set cells	FALSE
-Cell synchronisation information reporting indicator	TRUE
-Cell Identity reporting indicator	FDD
-CHOICE mode	FALSE
- Timeslot ISCP reporting indicator	FALSE
- Proposed TGSN Reporting required	TRUE
PCCPCH RSCP reporting indicator	FALSE
-Pathloss reporting indicator	Not Present
-Reporting quantities for detected set cells	
-Reporting cell status	Report all active set cells + cells within monitored set on used frequency
-CHOICE reported cell	Virtual/active set cells + 2
-Maximum number of reported cells	Not Present
-Measurement validity	Periodical reporting criteria
-CHOICE <i>report criteria</i>	Infinity
-Amount of reporting	250 ms
-Reporting interval	
Physical channel information elements	
-DPCH compressed mode status info	Not Present

Second MEASUREMENT CONTROL message for Inter frequency measurement (step 1):

Information Element	Value/Remark
Message Type	
UE information elements	
-RRC transaction identifier	0
Measurement Information elements	
-Measurement Identity	2
-Measurement Command	Setup
-Measurement Reporting Mode	
- Measurement Report Transfer Mode	Acknowledged mode RLC
- Periodical Reporting / Event Trigger Reporting Mode	Periodical reporting
-Additional measurement list	Not Present
-CHOICE Measurement Type	Inter-frequency measurement
-Inter-frequency measurement object list	
-CHOICE Inter-frequency cell removal	Not Present
-New inter-frequency cells	Cell 2 information is included
-Cell for measurement	Not Present
-Inter-frequency measurement quantity	
-CHOICE reporting criteria	Inter-frequency reporting criteria
-Filter coefficient	0
-CHOICE mode	TDD
-Measurement quantity for frequency quality estimate	PCCPCH RSCP
-Inter-frequency reporting quantity	
-UTRA Carrier RSSI	TRUE
-Frequency quality estimate	TRUE
-Non frequency related cell reporting quantities	
-Cell synchronisation information reporting indicator	TRUE
-Cell Identity reporting indicator	TRUE
-CHOICE mode	FDD
-Timeslot ISCP reporting indicator	FALSE
- Proposed TGSN Reporting required	FALSE
-PCCPCH RSCP reporting indicator	TRUE
-Pathloss reporting indicator	FALSE
-Reporting cell status	Report cells within monitored set on non-used frequency
-CHOICE reported cell	
-Maximum number of reported cells	2
-Measurement validity	Not Present
-Inter-frequency set update	Not Present
-CHOICE report criteria	
-Amount of reporting	Periodical reporting criteria
-Reporting interval	Infinity 500 ms
Physical channel information elements	
-DPCH compressed mode status info	Not Present

MEASUREMENT REPORT message for Inter frequency test cases

This message is common for all inter frequency test cases in clause 8.7 and is described in Annex I.

#### 8.7.1.2A.1.5 Test requirements

The PCCPCH RSCP measurement accuracy shall meet the requirements in clause 8.7.1.2A.1.2 for at least 900 of the measurement reports at each input level in step 4.

NOTE: If the above Test Requirement differs from the Minimum Requirement then the Test Tolerance applied for this test is non-zero. The Test Tolerance for this test is defined in clause F.2 and the explanation of how the Minimum Requirement has been relaxed by the Test Tolerance is given in clause F.4.

## 8.7.1.2A.2 Absolute accuracy requirement

### 8.7.1.2A.2.1 Definition and applicability

The absolute accuracy of P-CCPCH RSCP is defined as the P-CCPCH RSCP measured from one cell compared to the actual P-CCPCH RSCP power from the same cell.

The requirements and this test apply to all types of 1.28 Mcps TDD UE.

### 8.7.1.2A.2.2 Minimum Requirements

In each case, at least 900 of the 1000 measurement reports must meet the requirements.

### 8.7.1.2A.2.3 Test Purpose

The purpose of the test is to verify that the absolute accuracy of P-CCPCH RSCP in inter-frequency case meets the requirements of the specifications.

### 8.7.1.2A.2.4 Method of test

#### 8.7.1.2A.2.4.1 Initial conditions

Test environment: normal, TL/VL, TL/VH, TH/VL, TH/VH; see clauses G.2.1 and G.2.2.

Frequencies to be tested: mid range; see clause G.2.4.

Cell condition:

Two 1.28Mcps TDD inter-frequency cells are configured.

Signal propagation condition: AWGN

Test instrument: AWGN noise source

P-CCPCH RSCP –102 dBm.

$$\left| P - \text{CCPCH RSCP1} \Big|_{in \text{ dB}} - P - \text{CCPCH RSCP2} \Big|_{in \text{ dB}} \right| \leq 20 \text{ dB}$$

$$\left( \frac{P - \text{CCPCH} - E_c}{I_o} \right) \Big|_{in \text{ dB}} \geq -8 \text{ dB}$$

$$\left( \frac{DwPCH - E_c}{I_o} \right) \Big|_{in \text{ dB}} \geq -5 \text{ dB}$$

Table 8.7.1.2A.2.1: P-CCPCH RSCP Inter frequency test parameter

Test 1					
Parameter	Unit	Cell 1		Cell 2	
Timeslot Number		0	DwPTS	0	DwPTS
UTRA RF Channel Number		Channel 1		Channel 2	
PCCPCH_Ec/lor	dB	-3		-3	
DwPCH_Ec/lor	dB		0		0
OCNS_Ec/lor	dB	-3		-3	
$\hat{I}_{or}/I_{oc}$	dB	5		5	
$I_{oc}$	dBm/1.28 MHz	-75.2		-75.2	
PCCPCH RSCP (Note 1)	dBm	-73.2		-73.2	
Io (Note 1)	dBm/1.28 MHz	-69			
Propagation condition		AWGN			
Test 2					
Parameter	Unit	Cell 1		Cell 2	
Timeslot Number		0	DwPTS	0	DwPTS
UTRA RF Channel Number		Channel 1		Channel 2	
PCCPCH_Ec/lor	dB	-3		-3	
DwPCH_Ec/lor	dB		0		0
OCNS_Ec/lor	dB	-3		-3	
$\hat{I}_{or}/I_{oc}$	dB	7		2	
$I_{oc}$	dBm/1.28 MHz	-57.8		-54.1	
PCCPCH RSCP (Note 1)	dBm	-53.8		-55.1	
Io (Note 1)	dBm/1.28 MHz	-50			
Propagation condition		AWGN			
Test 3					
Parameter	Unit	Cell 1		Cell 2	
Timeslot Number		0	DwPTS	0	DwPTS
UTRA RF Channel Number		Channel 1		Channel 2	
PCCPCH_Ec/lor	dB	-3		-3	
DwPCH_Ec/lor	dB		0		0
OCNS_Ec/lor	dB	-3		-3	
$\hat{I}_{or}/I_{oc}$	dB	3		0	
$I_{oc}$	dBm/1.28 MHz	-98.7		-97	
PCCPCH RSCP (Note 1)	dBm	-98.7		-100	
Io (Note 1)	dBm/1.28 MHz	-94			
Propagation condition		AWGN			
Note 1: PCCPCH RSCP and Io levels are calculated from other parameters for information purposes.					

#### 8.7.1.2A.2.4.2 Procedure

- 1) A call is set up according to the test procedure specified in 3GPP TS 34.108 sub-clause 7.3.2.3.
- 2) The RF parameters for Test 1 are set up according to table 1.
- 3) SS shall transmit MEASUREMENT CONTROL message.
- 4) UE shall transmit periodically MEASUREMENT REPORT messages.
- 5) SS shall check PCCPCH\_RSCP value in MEASUREMENT REPORT messages. PCCPCH\_RSCP power of Cell 1 and CELL 2 reported by UE is compared to actual PCCPCH\_RSCP power for each MEASUREMENT REPORT message.
- 6) SS shall count number of MEASUREMENT REPORT messages transmitted by UE. After 1000 MEASUREMENT REPORT messages have been received from UE, the RF parameters are set up according to table 1 for Test 2. While RF parameters are set up, MEASUREMENT REPORT messages from UE are ignored. SS shall wait for additional 1s and ignore the MEASUREMENT REPORT messages during this period. Then, repeat steps 3 and 4. After further 1000 MEASUREMENT REPORT messages have been received from UE, the RF parameters are set up according to table 1 for Test 3. While RF parameters are set up, MEASUREMENT REPORT messages from UE are ignored. SS shall wait for additional 1s and ignore the MEASUREMENT REPORT messages during this period. Then, repeat steps 3 and 4.
- 7) After further 1000 MEASUREMENT REPORT messages have been received from UE, the SS shall transmit RRC CONNECTION RELEASE message.
- 8) UE shall transmit RRC CONNECTION RELEASE COMPLETE message.

#### Specific Message Contents

All messages indicated above shall use the same content as described in the default message content in clause 9 of 34.108 [3], with the following exceptions:

First MEASUREMENT CONTROL message for Intra frequency measurement (step 1)

Information Element	Value/Remark
Message Type	
UE information elements	
-RRC transaction identifier	0
Measurement Information elements	
-Measurement Identity	1
-Measurement Command	setup
-Measurement Reporting Mode	Acknowledged mode RLC
- Measurement Report Transfer Mode	Periodical reporting
- Periodical Reporting/Event Trigger Reporting Mode	
-Additional measurement list	Not Present
-CHOICE Measurement Type	Intra-frequency measurement
-Intra-frequency measurement	
- Intra-frequency measurement objects list	
-Intra-frequency cell info list	Not Present
-Intra-frequency measurement quantity	
-Filter coefficient	
-CHOICE mode	0
-Measurement quantity	TDD
-Intra-frequency reporting quantity	PCCPCH RSCP
-Reporting quantities for active set cells	
-Cell synchronization information reporting indicator	
-Cell Identity reporting indicator	TRUE
-CHOICE mode	TRUE
-Timeslot ISCP reporting indicator	TDD
-Proposed TGSN Reporting required	FALSE
-PCCPCH RSCP reporting indicator	FALSE
-Pathloss reporting indicator	TRUE
-Reporting quantities for monitored set cells	FALSE
-Cell synchronization information reporting indicator	
-Cell Identity reporting indicator	FALSE
-CHOICE mode	TRUE
-Timeslot ISCP reporting indicator	TDD
-Proposed TGSN Reporting required	FALSE
-PCCPCH RSCP reporting indicator	FALSE
-Pathloss reporting indicator	TRUE
-Reporting quantities for detected set cells	FALSE
-Reporting cell status	Not Present
-CHOICE reported cell	
-Maximum number of reported cells	Report all active set cells + cells within monitored set on used frequency
-Measurement validity	Virtual/active set cells + 2
-CHOICE report criteria	Not Present
-Amount of reporting	Periodical reporting criteria
-Reporting interval	Infinity 250 ms
Physical channel information elements	
-DPCH compressed mode status info	Not Present



Second MEASUREMENT CONTROL message for Inter frequency measurement (step 1)

Information Element	Value/Remark
Message Type	
UE information elements	
-RRC transaction identifier	0
Measurement Information elements	
-Measurement Identity	2
-Measurement Command	Setup
-Measurement Reporting Mode	
- Measurement Report Transfer Mode	Acknowledged mode RLC
- Periodical Reporting/Event Trigger Reporting Mode	Periodical reporting
-Additional measurement list	Not Present
-CHOICE Measurement Type	Inter-frequency measurement
-Inter-frequency measurement object list	
-CHOICE Inter-frequency cell removal	Not Present
-New inter-frequency cells	Cell 2 information is included
-Cell for measurement	Not Present
-Inter-frequency measurement quantity	
-CHOICE reporting criteria	Inter-frequency reporting criteria
-Filter coefficient	0
-CHOICE mode	TDD
-Measurement quantity for frequency quality estimate	PCCPCH RSCP
-Inter-frequency reporting quantity	
-UTRA Carrier RSSI	TRUE
-Frequency quality estimate	TRUE
-Non frequency related cell reporting quantities	
-Cell synchronization information reporting indicator	
-Cell Identity reporting indicator	TRUE
-CHOICE mode	TRUE
-Timeslot ISCP reporting indicator	TDD
-Proposed TGSN Reporting required	FALSE
-PCCPCH RSCP reporting indicator	FALSE
-Pathloss reporting indicator	TRUE
-Reporting cell status	FALSE
-CHOICE reported cell	Report cells within monitored set on non-used frequency
-Maximum number of reported cells	
-Measurement validity	2
-Inter-frequency set update	Not Present
-CHOICE report criteria	Not Present
-Amount of reporting	Periodical reporting criteria
-Reporting interval	Infinity 500 ms
Physical channel information elements	
-DPCH compressed mode status info	Not Present

#### 8.7.1.2A.2.5 Test requirements

**Table 8.7.1.2A.2.2: P-CCPCH RSCP Inter frequency absolute accuracy**

Parameter	Unit	Accuracy [dB]		Condition
		Normal Condition	Extreme Condition	Io[dBm/1.28 MHz]
P-CCPCH_RSCP	dBm	± 6	± 9	-94...-70
	dBm	± 8	± 11	-70...-50

In each case, at least 900 of the 1000 measurement reports must meet the requirements.

The rate of correct measurement observed during repeated tests shall be at least 90% with a confidence level of 95%.

## 8.7.1.2B Inter frequency measurement accuracy for 7,68 Mcps TDD Option

### 8.7.1.2B.1 Relative accuracy requirement

#### 8.7.1.2B.1.1 Definition and applicability

The P-CCPCH\_RSCP inter-frequency relative accuracy is defined as the P-CCPCH\_RSCP measured from one cell compared to the P-CCPCH\_RSCP measured from another cell on a different frequency.

The requirements and this test apply to all types of UTRA TDD UE.

#### 8.7.1.2B.1.2 Minimum Requirements

The relative accuracy requirements in table 8.7.1.2B.1.2.1 are valid under the following conditions:

$$P\text{-CCPCH RSCP} \geq -102 \text{ dBm.}$$

$$\left| P\text{-CCPCH RSCP1}_{in \text{ dB}} - P\text{-CCPCH RSCP2}_{in \text{ dB}} \right| \leq 20 \text{ dB}$$

$$\left( \frac{P\text{-CCPCH} - E_c}{I_o} \right)_{in \text{ dB}} \geq -11 \text{ dB}$$

$$\left( \frac{SCH - E_c}{I_o} \right)_{in \text{ dB}} \geq -13 \text{ dB}$$

**Table 8.7.1.2B.1.2.1 P-CCPCH\_RSCP inter-frequency relative accuracy**

Parameter	Unit	Accuracy [dB]		Conditions
		Normal condition	Extreme condition	Io [dBm/7.68 MHz]
P-CCPCH_RSCP	dBm	± 6	± 6	-94...-50

The normative reference for this requirement is TS 25.123 [2] clauses 9.1.1.1.2.3 and A.9.3.1.

#### 8.7.1.2B.1.3 Test Purpose

The purpose of this test is to verify that the relative P-CCPCH RSCP measurement accuracy is within the specified limits for the inter frequency case.

#### 8.7.1.2B.1.4 Method of test

##### 8.7.1.2B.1.4.1 Initial conditions

Test environment: normal, TL/VL, TL/VH, TH/VL, TH/VH; see clauses G.2.1 and G.2.2.

Frequencies to be tested: mid range; see clause G.2.4.

In this case both cells are on different frequencies. The second Beacon timeslot shall be provided in timeslot 8 for cell 1 and in timeslot 10 for cell 2. P-CCPCH RSCP inter frequency relative accuracy requirements are tested by using test parameters in table 8.7.1.2B.1.4.1.1.

**Table 8.7.1.2B.1.4.1.1: P-CCPCH RSCP inter frequency test parameters**

Parameter	Unit	Test 1		Test 2		Test 3	
		Cell 1	Cell 2	Cell 1	Cell 2	Cell 1	Cell 2
DL timeslot number		0	2	0	2	0	2
UTRA RF Channel number		Channel 1	Channel 2	Channel 1	Channel 2	Channel 1	Channel 2
PCCPCH_Ec/Ior	dB	-3		-3		-3	
SCH_Ec/Ior	dB	-9		-9		-9	
SCH_t_offset		0	5	0	5	0	5
OCNS_Ec/Ior	dB	-3,12		-3,12		-3,12	
Ior	dBm / 7.68 MHz	-75.2	-75.2	-57.8	-54.1	-98.7	-97
Ior/Ior	dB	5	5	7	2	3	0
PCCPCH RSCP, Note 1	dBm	-73.2	-73.2	-54.8	-55.1	-98.7	-100
Ior, Note 1	dBm / 7.68 MHz	-69		-50		-94	
Propagation condition		AWGN		AWGN		AWGN	
NOTE 1: PCCPCH RSCP and Ior levels have been calculated from other parameters for information purposes. They are not settable parameters themselves.							

- 1) A call is set up according to the test procedure specified in TS 34.108 [3] clause 7.3.2.3. The RF parameters for Test 1 are set up according to table 8.7.1.2B.1.4.1.1.

#### 8.7.1.2B.1.4.2 Procedure

- 1) SS shall transmit the MEASUREMENT CONTROL messages for intra frequency and inter frequency measurements.
- 2) UE shall transmit periodically MEASUREMENT REPORT messages.
- 3) SS shall check PCCPCH\_RSCP value of Cell 1 and Cell 2 in MEASUREMENT REPORT messages. PCCPCH RSCP power value measured from Cell 1 is compared to PCCPCH RSCP power value measured from Cell 2 for each MEASUREMENT REPORT message.
- 4) The result of step 3) is compared to actual power level difference of PCCPCH RSCP of Cell 1 and Cell 2.
- 5) SS shall count number of MEASUREMENT REPORT messages transmitted by UE. After 1000 MEASUREMENT REPORT messages have been received from UE, the RF parameters are set up according to table 8.7.1.2.1.2 for Test 2. While RF parameters are being set up, MEASUREMENT REPORT messages from UE are ignored. SS shall wait for additional 1s and ignore the MEASUREMENT REPORT messages during this period. Then, steps 3) and 4) above are repeated.
- 6) After further 1000 MEASUREMENT REPORT messages have been received from UE, the SS shall transmit RRC CONNECTION RELEASE message.
- 7) UE shall transmit RRC CONNECTION RELEASE COMPLETE message.

#### Specific Message Contents

All messages indicated above shall use the same content as described in the default message content in clause 9 of 34.108 [3] and in Annex I, with the following exceptions:

First MEASUREMENT CONTROL message for intra frequency measurements (Step 1):

Information Element/Group name	Value/Remark
Message Type (10.2.17)	
UE information elements	
-RRC transaction identifier	0
-Integrity check info	Not Present
Measurement Information elements	
-Measurement Identity	1
-Measurement Command (10.3.7.46)	Modify
-Measurement Reporting Mode (10.3.7.49)	
-Measurement Report Transfer Mode	AM RLC
-Periodical Reporting / Event Trigger Reporting Mode	Periodical reporting
-Additional measurements list (10.3.7.1)	Not Present
-CHOICE <i>Measurement type</i>	Intra-frequency measurement
-Intra-frequency measurement (10.3.7.36)	
-Intra-frequency measurement objects list (10.3.7.33)	Not Present
-Intra-frequency measurement quantity (10.3.7.38)	
-Filter coefficient (10.3.7.9)	0
-CHOICE <i>mode</i>	TDD
-Measurement quantity list	1
-Measurement quantity	Primary CCPCH RSCP
-Intra-frequency reporting quantity (10.3.7.41)	
-Reporting quantities for active set cells (10.3.7.5)	
-SFN-SFN observed time difference reporting indicator	No report
-Cell synchronisation information reporting indicator	FALSE
-Cell Identity reporting indicator	FALSE
-CHOICE <i>mode</i>	TDD
-Timeslot ISCP reporting indicator	FALSE
-Primary CCPCH RSCP reporting indicator	TRUE
-Pathloss reporting indicator	FALSE
-Reporting quantities for monitored set cells (10.3.7.5)	
-SFN-SFN observed time difference reporting indicator	No report
-Cell synchronisation information reporting indicator	FALSE
-Cell Identity reporting indicator	FALSE
-CHOICE <i>mode</i>	TDD
-Timeslot ISCP reporting indicator	FALSE
-Proposed TGSN reporting required	FALSE
-Primary CCPCH RSCP reporting indicator	TRUE
-Pathloss reporting indicator	FALSE
-Reporting quantities for detected set cells (10.3.7.5)	Not Present
-Reporting cell status (10.3.7.61)	
-CHOICE <i>reported cell</i>	Report all active set cells + cells within monitored set on used frequency
-Maximum number of reported cells	1
-Measurement validity (10.3.7.51)	Not Present
-CHOICE <i>report criteria</i> (10.3.7.	
-Periodical reporting criteria (10.3.7.53)	
-Amount of reporting	Infinity
-Reporting interval	250 ms
Physical channel information elements	
-DPCH compressed mode status info (10.3.6.34)	Not Present

Second MEASUREMENT CONTROL message for inter frequency measurements (Step 1):

Information Element/Group name	Value/Remark
Message Type (10.2.17)	
<b>UE information elements</b>	
-RRC transaction identifier	0
-Integrity check info	Not Present
<b>Measurement Information elements</b>	
-Measurement Identity	2
-Measurement Command (10.3.7.46)	Setup
-Measurement Reporting Mode (10.3.7.49)	
-Measurement Report Transfer Mode	AM RLC
-Periodical Reporting / Event Trigger Reporting Mode	Periodical reporting
-Additional measurements list (10.3.7.1)	Not Present
-CHOICE <i>Measurement type</i>	Inter-frequency measurement
-Inter-frequency measurement (10.3.7.16)	
-Inter-frequency measurement objects list (10.3.7.13)	
-CHOICE <i>inter-frequency cell removal</i>	Not present
-New inter-frequency cells	Cell 2 information is included
-Cell for measurement	Not Present
-Inter-frequency measurement quantity (10.3.7.18)	
-CHOICE <i>reporting criteria</i>	Inter-frequency reporting criteria
-Filter coefficient (10.3.7.9)	0
-CHOICE <i>mode</i>	TDD
-Measurement quantity for frequency quality estimate	Primary CCPCH RSCP
-Inter-frequency reporting quantity (10.3.7.21)	
-UTRA carrier RSSI	FALSE
-Frequency quality estimate	TRUE
-Non frequency related cell reporting quantities (10.3.7.5)	
-SFN-SFN observed time difference reporting indicator	No report
-Cell synchronisation information reporting indicator	FALSE
-Cell identity reporting indicator	FALSE
-CHOICE <i>mode</i>	TDD
-Timeslot ISCP reporting indicator	FALSE
-Proposed TGSN Reporting required	FALSE
-Primary CCPCH RSCP reporting indicator	TRUE
-Pathloss reporting indicator	FALSE
-Reporting cell status (10.3.7.61)	
-CHOICE <i>reported cell</i>	Report all active set cells + cells within monitored set on used frequency
-Maximum number of reported cells	Virtual/active set cells + 2
-Measurement validity (10.3.7.51)	Not present
-Inter-frequency set update	Not present
-CHOICE <i>report criteria</i> (10.3.7.	
-Periodical reporting criteria (10.3.7.53)	
-Amount of reporting	Infinity
-Reporting interval	500 ms
<b>Physical channel information elements</b>	
-DPCH compressed mode status info (10.3.6.34)	Not Present

#### 8.7.1.2B.1.5 Test requirements

The PCCPCH RSCP measurement accuracy shall meet the requirements in clause 8.7.1.2B.1.2 for at least 900 of the measurement reports at each input level in step 4.

NOTE: If the above Test Requirement differs from the Minimum Requirement then the Test Tolerance applied for this test is non-zero. The Test Tolerance for this test is defined in clause F.2 and the explanation of how the Minimum Requirement has been relaxed by the Test Tolerance is given in clause F.4.

#### 8.7.1.3 Local cell accuracy for 3.84 Mcps TDD option

Void

### 8.7.1.3A Local cell accuracy for 1.28 Mcps TDD option

#### 8.7.1.3A.1 Absolute accuracy requirement

##### 8.7.1.3A.1.1 Definition and applicability

The absolute accuracy of P-CCPCH RSCP is defined as the P-CCPCH RSCP measured from one cell compared to the actual P-CCPCH RSCP power from the same cell.

The requirements and this test apply to all types of 1.28 Mcps TDD UE.

##### 8.7.1.3A.1.2 Minimum Requirements

Parameter	Unit	Accuracy		Condition
		Normal Condition	Extreme Condition	Io[dBm/1.28 MHz]
P-CCPCH_RSCP	dBm	± 6	± 9	-94...-70
	dBm	± 8	± 11	-70...-50

##### 8.7.1.3A.1.3 Test purpose

The purpose of this test is to verify that the Single-Cell Absolute Accuracy is within the specified limits.

##### 8.7.1.3A.1.4 Method of test

###### 8.7.1.3A.1.4.1 Initial conditions

Test environment: normal, TL/VL, TL/VH, TH/VL, TH/VH; see clauses G.2.1 and G.2.2.

Frequencies to be tested: mid range; see clause G.2.4.

Cell condition:

One 1.28Mcps TDD cell must be configured. The DL DPCH is configured in timeslot 5, and the UL DPCH is configured in timeslot 2.

P-CCPCH RSCP □ -102 dBm.

$$\left( \frac{P - CCPCH - E_c}{I_o} \right) \Big|_{in \text{ dB}} \geq -8dB \quad \left( \frac{DwPCH - E_c}{I_o} \right) \Big|_{in \text{ dB}} \geq -5dB$$

Table 8.7.1.3A.1.1: P-CCPCH RSCP local cell test parameters

		Test 1	
Parameter	Unit	Cell 1	
Timeslot Number		0	DwPTS
UTRA RF Channel Number		Channel 1	
PCCPCH_Ec/lor	dB	0	
DwPCH_Ec/lor	dB		0
$\hat{I}_{or}$	dBm/1.28 MHz	-76.6	
PCCPCH RSCP	dBm	-76.6	
		Test 2	
Parameter	Unit	Cell 1	
Timeslot Number		0	DwPTS
UTRA RF Channel Number		Channel 1	
PCCPCH_Ec/lor	dB	0	
DwPCH_Ec/lor	dB		0
$\hat{I}_{or}$	dBm/1.28 MHz	-85	
PCCPCH RSCP	dBm	-85	
		Test 3	
Parameter	Unit	Cell 1	
Timeslot Number		0	DwPTS
UTRA RF Channel Number		Channel 1	
PCCPCH_Ec/lor	dB	0	
DwPCH_Ec/lor	dB		0
$\hat{I}_{or}$	dBm/1.28 MHz	-90	
PCCPCH RSCP	dBm	-90	
		Test 4	
Parameter	Unit	Cell 1	
Timeslot Number		0	DwPTS
UTRA RF Channel Number		Channel 1	
PCCPCH_Ec/lor	dB	0	
DwPCH_Ec/lor	dB		0
$\hat{I}_{or}$	dBm/1.28 MHz	-95	
PCCPCH RSCP	dBm	-95	

MEASUREMENT CONTROL message in P-CCPCH RSCP absolute accuracy measurement (step 1)

Information Element/Group Name	Value/Remark
Message Type (10.2.17)	
UE information elements	
-RRC transaction identifier	0
-Integrity check info	Not Present
Measurement Information elements	
-Measurement Identity	1
-Measurement Command (10.3.7.46)	setup
-Measurement Reporting Mode (10.3.7.49)	
-Measurement Report Transfer Mode	AM RLC
-Periodical Reporting/Event Trigger Reporting Mode	Periodical reporting
-Additional measurements list (10.3.7.1)	Not Present
-CHOICE Measurement type	Intra-frequency measurement
-Intra-frequency measurement (10.3.7.36)	
-Intra-frequency measurement objects list (10.3.7.33)	Not Present
-Intra-frequency measurement quantity (10.3.7.38)	
-Filter coefficient (10.3.7.9)	0
-CHOICE mode	TDD
-Measurement quantity list	1
-Measurement quantity	Primary CCPCH RSCP
-Intra-frequency reporting quantity (10.3.7.41)	
-Reporting quantities for active set cells (10.3.7.5)	
-SFN-SFN observed time difference reporting indicator	No report
-Cell synchronization information reporting indicator	FALSE
-Cell Identity reporting indicator	TRUE
-CHOICE mode	TDD
-Timeslot ISCP reporting indicator	FALSE
-Primary CCPCH RSCP reporting indicator	TRUE
-Pathloss reporting indicator	FALSE
-Reporting quantities for monitored set cells (10.3.7.5)	
-SFN-SFN observed time difference reporting indicator	No report
-Cell synchronization information reporting indicator	FALSE
-Cell Identity reporting indicator	TRUE
-CHOICE mode	TDD
-Timeslot ISCP reporting indicator	FALSE
-Proposed TGSN reporting required	FALSE
-Primary CCPCH RSCP reporting indicator	TRUE
-Pathloss reporting indicator	FALSE
-Reporting quantities for detected set cells (10.3.7.5)	Not Present
-Reporting cell status (10.3.7.61)	
-CHOICE reported cell	Report all active set cells + cells within monitored set on used frequency
-Maximum number of reported cells	1
-Measurement validity (10.3.7.51)	Not Present
-CHOICE report criteria (10.3.7.	
-Periodical reporting criteria (10.3.7.53)	
-Amount of reporting	Infinity
-Reporting interval	250 ms
Physical channel information elements	
-DPCH compressed mode status info (10.3.6.34)	Not Present

#### 8.7.1.3A.1.4.2 Procedure

- 1) A call is set up according to the test procedure specified in 3GPP TS 34.108 sub-clause 7.3.2.3. The RF parameters for Test 1 are set up according to table1.
- 2) SS shall transmit MEASUREMENT CONTROL message.
- 3) UE shall transmit periodically MEASUREMENT REPORT messages.



- 4) SS shall check PCCPCH\_RSCP value in MEASUREMENT REPORT messages. PCCPCH\_RSCP power of Cell 1 reported by UE is compared to actual PCCPCH\_RSCP power for each MEASUREMENT REPORT message.
- 5) SS shall count number of MEASUREMENT REPORT messages transmitted by UE. After 1000 MEASUREMENT REPORT messages have been received from UE, the RF parameters are set up according to table1 for Test 2. While RF parameters are being set up, MEASUREMENT REPORT messages from UE are ignored. SS shall wait for additional 1s and ignore the MEASUREMENT REPORT messages during this period. Then, repeat steps 3 and 4. After further 1000 MEASUREMENT REPORT messages have been received from UE, the RF parameters are set up according to table1 for Test 3. While RF parameters are being set up, MEASUREMENT REPORT messages from UE are ignored. SS shall wait for additional 1s and ignore the MEASUREMENT REPORT messages during this period. Then, steps 3 and 4 are repeated.
- 6) After further 1000 MEASUREMENT REPORT messages have been received from UE, the SS shall transmit RRC CONNECTION RELEASE message.
- 7) UE shall transmit RRC CONNECTION RELEASE COMPLETE message.

#### 8.7.1.3A.1.5 Test requirements

Parameter	Unit	Accuracy		Condition
		Normal Condition	Extreme Condition	Io[dBm/1.28 MHz]
P-CCPCH_RSCP	dBm	± 6	± 9	-94...-70
	dBm	± 8	± 11	-70...-50

The success rate shall be more than 90% and the confidence level shall be more than 95%.

#### 8.7.1.3B Local cell accuracy for 7.86 Mcps TDD option

Void

#### 8.7.1.4 Local cell absolute accuracy in white noise for 3.84 Mcps TDD

Void

#### 8.7.1.4A Local cell absolute accuracy in white noise for 1.28 Mcps TDD

##### 8.7.1.4A.1 Absolute accuracy requirement

##### 8.7.1.4A.1.1 Definition and applicability

The absolute accuracy of P-CCPCH RSCP is defined as the P-CCPCH RSCP measured from one cell compared to the actual P-CCPCH RSCP power from the same cell.

The requirements and this test apply to all types of 1.28 Mcps TDD UE.

##### 8.7.1.4A.1.2 Minimum Requirements

Parameter	Unit	Accuracy		Condition
		Normal condition	Extreme condition	Io[dBm/1.28 MHz]
P-CCPCH_RSCP	dBm	± 6	± 9	-94...-70
	dBm	± 8	± 11	-70...-50

##### 8.7.1.4A.1.3 Test purpose

The purpose of this test is to verify that the Single-Cell White Noise Environment Measurement Absolute Accuracy is within the specified limits.

##### 8.7.1.4A.1.4 Method of test

##### 8.7.1.4A.1.4.1 Initial conditions

Test environment: normal, TL/VL, TL/VH, TH/VL, TH/VH; see clauses G.2.1 and G.2.2.

Frequencies to be tested: mid range; see clause G.2.4.

Cell condition:

One 1.28Mcps TDD cell must be configured. The DL DPCH is configured in timeslot 5, and the UL DPCH is configured in timeslot 2.

Table 8.7.1.4A.1.1: P-CCPCH RSCP single-cell white noise measurement parameters

		Test 1	
Parameter	Unit	Cell 1	
Timeslot Number		0	DwPTS
UTRA RF Channel Number		Channel 1	
PCCPCH_Ec/lor	dB	0	
DwPCH_Ec/lor	dB		0
$\hat{I}_{or}/I_{oc}$	dB	2	
$I_{oc}$	dBm/1.28 MHz	-76.6	
PCCPCH RSCP (Note 1)	dBm	-74.6	
Propagation condition		AWGN	
		Test 2	
Parameter	Unit	Cell 1	
Timeslot Number		0	DwPTS
UTRA RF Channel Number		Channel 1	
PCCPCH_Ec/lor	dB	0	
DwPCH_Ec/lor	dB		0
$\hat{I}_{or}/I_{oc}$	dB	2	
$I_{oc}$	dBm/1.28 MHz	-87	
PCCPCH RSCP (Note 1)	dBm	-85	
Propagation condition		AWGN	
		Test 3	
Parameter	Unit	Cell 1	
Timeslot Number		0	DwPTS
UTRA RF Channel Number		Channel 1	
PCCPCH_Ec/lor	dB	0	
DwPCH_Ec/lor	dB		0
$\hat{I}_{or}/I_{oc}$	dB	2	
$I_{oc}$	dBm/1.28 MHz	-92	
PCCPCH RSCP (Note 1)	dBm	-90	
Propagation condition		AWGN	
		Test 4	
Parameter	Unit	Cell 1	
Timeslot Number		0	DwPTS
UTRA RF Channel Number		Channel 1	
PCCPCH_Ec/lor	dB	0	
DwPCH_Ec/lor	dB		0
$\hat{I}_{or}/I_{oc}$	dB	2	
$I_{oc}$	dBm/1.28 MHz	-97	
PCCPCH RSCP (Note 1)	dBm	-95	
Propagation condition		AWGN	

Note 1: PCCPCH RSCP and  $I_{oc}$  levels are calculated from other parameters for information purposes.

MEASUREMENT CONTROL message in P-CCPCH RSCP absolute accuracy measurement (step 1)

Information Element/Group Name	Value/Remark
Message Type (10.2.17)	
UE information elements	
-RRC transaction identifier	0
-Integrity check info	Not Present
Measurement Information elements	
-Measurement Identity	1
-Measurement Command (10.3.7.46)	setup
-Measurement Reporting Mode (10.3.7.49)	
-Measurement Report Transfer Mode	AM RLC
-Periodical Reporting/Event Trigger Reporting Mode	Periodical reporting
-Additional measurements list (10.3.7.1)	Not Present
-CHOICE Measurement type	Intra-frequency measurement
-Intra-frequency measurement (10.3.7.36)	
-Intra-frequency measurement objects list (10.3.7.33)	Not Present
-Intra-frequency measurement quantity (10.3.7.38)	
-Filter coefficient (10.3.7.9)	0
-CHOICE mode	TDD
-Measurement quantity list	1
-Measurement quantity	Primary CCPCH RSCP
-Intra-frequency reporting quantity (10.3.7.41)	
-Reporting quantities for active set cells (10.3.7.5)	
-SFN-SFN observed time difference reporting indicator	No report
-Cell synchronization information reporting indicator	FALSE
-Cell Identity reporting indicator	TRUE
-CHOICE mode	TDD
-Timeslot ISCP reporting indicator	FALSE
-Primary CCPCH RSCP reporting indicator	TRUE
-Pathloss reporting indicator	FALSE
-Reporting quantities for monitored set cells (10.3.7.5)	
-SFN-SFN observed time difference reporting indicator	No report
-Cell synchronization information reporting indicator	FALSE
-Cell Identity reporting indicator	TRUE
-CHOICE mode	TDD
-Timeslot ISCP reporting indicator	FALSE
-Proposed TGSN reporting required	FALSE
-Primary CCPCH RSCP reporting indicator	TRUE
-Pathloss reporting indicator	FALSE
-Reporting quantities for detected set cells (10.3.7.5)	Not Present
-Reporting cell status (10.3.7.61)	
-CHOICE reported cell	Report all active set cells + cells within monitored set on used frequency
-Maximum number of reported cells	1
-Measurement validity (10.3.7.51)	Not Present
-CHOICE report criteria (10.3.7.	
-Periodical reporting criteria (10.3.7.53)	
-Amount of reporting	Infinity
-Reporting interval	250 ms
Physical channel information elements	
-DPCH compressed mode status info (10.3.6.34)	Not Present

#### 8.7.1.4A.1.4.2 Procedure

- 1) A call is set up according to the test procedure specified in 3GPP TS 34.108 sub-clause 7.3.2.3. The RF parameters for Test 1 are set up according to table 1.
- 2) SS shall transmit MEASUREMENT CONTROL message.
- 3) UE shall transmit periodically MEASUREMENT REPORT messages.
- 4) SS shall check PCCPCH\_RSCP value in MEASUREMENT REPORT messages. PCCPCH\_RSCP power of Cell 1 reported by UE is compared to actual PCCPCH\_RSCP power for each MEASUREMENT REPORT message.

- 5) SS shall count number of MEASUREMENT REPORT messages transmitted by UE. After 1000 MEASUREMENT REPORT messages have been received from UE, the RF parameters are set up according to table1 for Test 2. While RF parameters are set up, MEASUREMENT REPORT messages from UE are ignored. SS shall wait for additional 1s and ignore the MEASUREMENT REPORT messages during this period. Then, repeat steps 3 and 4. After further 1000 MEASUREMENT REPORT messages have been received from UE, the RF parameters are set up according to table1 for Test 3. While RF parameters are set up, MEASUREMENT REPORT messages from UE are ignored. SS shall wait for additional 1s and ignore the MEASUREMENT REPORT messages during this period. Then, repeat steps 3 and 4.
- 6) After further 1000 MEASUREMENT REPORT messages have been received from UE, the SS shall transmit RRC CONNECTION RELEASE message.
- 7) UE shall transmit RRC CONNECTION RELEASE COMPLETE message.

#### 8.7.1.4A.1.5 Test requirements

Parameter	Unit	Accuracy		Condition
		Normal condition	Extreme condition	Io[dBm/1.28 MHz]
P-CCPCH_RSCP	dBm	± 6	± 9	-94...-70
	dBm	± 8	± 11	-70...-50

The success rate shall be more than 90% and the confidence level shall be more than 95%.

#### 8.7.1.4B Local cell absolute accuracy in white noise for 3.84 Mcps TDD

Void

### 8.7.2 CPICH measurements (FDD)

#### 8.7.2.1 CPICH RSCP

##### 8.7.2.1.1 Absolute measurement accuracy for 3,84 Mcps TDD Option

###### 8.7.2.1.1.1 Definition and applicability

The absolute accuracy of CPICH RSCP is defined as the CPICH RSCP measured in an UTRA FDD cell on one frequency compared to the actual CPICH RSCP power of that cell on the same frequency.

The requirements and this test apply only to UE supporting both UTRA TDD and UTRA FDD.

###### 8.7.2.1.1.2 Minimum Requirements

The accuracy requirements in table 8.7.2.1.1.1 are valid under the following conditions:

- $CPICH\_RSCP_{1,2}|_{dBm} \geq -114$  dBm.

$$- \left( \frac{I_o}{\hat{I}_{or}} \right) \Big|_{in \text{ dB}} - \left( \frac{CPICH - E_c}{I_{or}} \right) \Big|_{in \text{ dB}} \leq 20dB .$$

**Table 8.7.2.1.1.1: CPICH RSCP inter frequency absolute accuracy**

Parameter	Unit	Accuracy [dB]		Conditions
		Normal condition	Extreme condition	Io [dBm/ 3,84 MHz]
CPICH_RSCP	dBm	± 6	± 9	-94...-70
	dBm	± 8	± 11	-70...-50

The normative reference for this requirement is TS 25.123 [2] clauses 9.1.1.2.1 and A.9.1.2.1.

###### 8.7.2.1.1.3 Test purpose

The purpose of this test is to verify that the CPICH RSCP absolute measurement accuracy is within the specified limits.

8.7.2.1.1.4 Method of test

8.7.2.1.1.4.1 Initial conditions

Test environment: normal, TL/VL, TL/VH, TH/VL, TH/VH; see clauses G.2.1 and G.2.2.

Frequencies to be tested: mid range; see clause G.2.4.

In this case both cells are on different frequencies. Cell 1 is a UTRA TDD cell and cell 2 is a UTRA FDD cell. The DL DPCH shall be transmitted in timeslot 1 and the UL DPCH shall be transmitted in timeslot 3. No second Beacon timeslot shall be provided for cell 1. CPICH RSCP inter frequency absolute accuracy requirements are tested by using test parameters in table 8.7.2.1.1.2.

**Table 8.7.2.1.1.2: CPICH RSCP inter frequency tests parameters**

Parameter	Unit	Test 1		Test 2	
		Cell 1	Cell 2	Cell 1	Cell 2
DL timeslot number		0	n.a.	0	n.a.
UTRA RF Channel number		Channel 1	Channel 2	Channel 1	Channel 2
CPICH_Ec/lor	dB	n.a.	-10	n.a.	-10
PCCPCH_Ec/lor	dB	-3	-12	-3	-12
SCH_Ec/lor	dB	-9	-12	-9	-12
SCH_toffset		5	n.a.	5	n.a.
PICH_Ec/lor	dB	n.a.	-15	n.a.	-15
OCNS_Ec/lor	dB	-3.12	-0.94	-3.12	-0.94
loc	dBm/ 3,84 MHz	-57.7	-60	-84.7	-84
lor/loc	dB	7	9.54	3	0
PCCPCH RSCP, Note 1	dBm	-53.7	n.a.	-84.7	n.a.
CPICH RSCP, Note 1	dBm	n.a.	-60.46	n.a.	-94
lo, Note 1	dBm/ 3,84 MHz	-50	-50	-80	-81
Propagation condition	-	AWGN		AWGN	
NOTE 1: PCCPCH RSCP, CPICH RSCP and lo levels have been calculated from other parameters for information purposes. They are not settable parameters themselves.					

A call is set up according to the test procedure specified in TS 34.108 [3] clause 7.3.2.3. The RF parameters for Test 1 are set up according to table 8.7.2.1.1.2.

8.7.2.1.1.4.2 Procedure

- 1) SS shall transmit the MEASUREMENT CONTROL message for inter frequency measurement.
- 2) UE shall transmit periodically MEASUREMENT REPORT messages.
- 3) SS shall check CPICH RSCP value of Cell 2 in the MEASUREMENT REPORT messages. CPICH RSCP levels of Cell 2 reported by the UE is compared to the actual CPICH RSCP value of Cell 2 for each MEASUREMENT REPORT message.
- 4) SS shall count number of MEASUREMENT REPORT messages transmitted by UE. After 1000 MEASUREMENT REPORT messages have been received from UE, the RF parameters are set up according to table 8.7.2.1.1.2 for Test 2. While RF parameters are being set up, MEASUREMENT REPORT messages from UE are ignored. SS shall wait for additional 1s and ignore the MEASUREMENT REPORT messages during this period. Then, steps 2) and 3) above are repeated.
- 6) After further 1000 MEASUREMENT REPORT messages have been received from UE, the SS shall transmit RRC CONNECTION RELEASE message.
- 7) UE shall transmit RRC CONNECTION RELEASE COMPLETE message.

Specific Message Contents

All messages indicated above shall use the same content as described in the default message content in clause 9 of 34.108 [3] and in Annex I, with the following exceptions:

MEASUREMENT CONTROL message for inter frequency measurement (Step 1):

Information Element	Value/Remark
Message Type	
UE information elements	
-RRC transaction identifier	0
-Integrity check info	Not Present
Measurement Information elements	
-Measurement Identity	2
-Measurement Command	Setup
-Measurement Reporting Mode	
- Measurement Report Transfer Mode	Acknowledged mode RLC
- Periodical Reporting / Event Trigger Reporting Mode	Periodical reporting
-Additional measurement list	Not Present
-CHOICE Measurement Type	Inter-frequency measurement
-Inter-frequency measurement object list	
-CHOICE Inter-frequency cell removal	Not Present
-New inter-frequency cells	Cell 2 information is included
-Cell for measurement	Not Present
-Inter-frequency measurement quantity	
-CHOICE reporting criteria	Inter-frequency reporting criteria
-Filter coefficient	0
-CHOICE mode	FDD
-Measurement quantity for frequency quality estimate	CPICH RSCP
-Inter-frequency reporting quantity	
-UTRA Carrier RSSI	FALSE
-Frequency quality estimate	TRUE
-Non frequency related cell reporting quantities	
-SFN-SFN observed time difference reporting indicator	No report
-Cell synchronisation information reporting indicator	FALSE
-Cell Identity reporting indicator	FALSE
-CHOICE mode	FDD
-CPICH Ec/N0 reporting indicator	FALSE
-CPICH RSCP reporting indicator	TRUE
-Pathloss reporting indicator	FALSE
-Reporting cell status	
-CHOICE reported cell	Report all active set cells + cells within monitored set on used frequency
-Maximum number of reported cells	Virtual/active set cells + 2
-Measurement validity	Not Present
-Inter-frequency set update	Not Present
-CHOICE report criteria	Periodical reporting criteria
-Amount of reporting	Infinity
-Reporting interval	500 ms
Physical channel information elements	
-DPCH compressed mode status info	Not Present

#### 8.7.2.1.1.5 Test requirements

The CPICH RSCP measurement accuracy shall meet the requirements in clause 8.7.2.1.1.2.

NOTE: If the above Test Requirement differs from the Minimum Requirement then the Test Tolerance applied for this test is non-zero. The Test Tolerance for this test is defined in clause F.2 and the explanation of how the Minimum Requirement has been relaxed by the Test Tolerance is given in clause F.4.

#### 8.7.2.1A.1 Absolute measurement accuracy for 1,28 Mcps TDD Option

##### 8.7.2.1A.1.1 Definition and applicability

The absolute accuracy of CPICH RSCP is defined as the CPICH RSCP measured in an UTRA FDD cell on one frequency compared to the actual CPICH RSCP power of that cell on the same frequency.

The requirements and this test apply only to UE supporting both UTRA TDD and UTRA FDD.

## 8.7.2.1A.1.2 Minimum Requirements

The accuracy requirements in table 8.7.2.1A.1.1 are valid under the following conditions:

- CPICH\_RSCP1,2|<sub>dBm</sub> ≥ -114 dBm.

$$- \left. \frac{I_o}{\hat{I}_{or}} \right|_{in \text{ dB}} - \left. \left( \frac{CPICH - E_c}{I_{or}} \right) \right|_{in \text{ dB}} \leq 20dB .$$

**Table 8.7.2.1A.1.1: FDD CPICH RSCP inter frequency absolute accuracy**

Parameter	Unit	Accuracy [dB]		Conditions
		Normal condition	Extreme condition	Io [dBm/ 3,84 MHz]
CPICH_RSCP	dBm	± 6	± 9	-94...-70
	dBm	± 8	± 11	-70...-50

The normative reference for this requirement is TS 25.123 [2] clauses 9.1.1.2.1 and A.9.1.2.1.

## 8.7.2.1A.1.3 Test purpose

The purpose of this test is to verify that the CPICH RSCP absolute measurement accuracy is within the specified limits.

## 8.7.2.1A.1.4 Method of test

## 8.7.2.1A.1.4.1 Initial conditions

Test environment: normal, TL/VL, TL/VH, TH/VL, TH/VH; see clauses G.2.1 and G.2.2.

Frequencies to be tested: mid range; see clause G.2.4.

In this case both cells are on different frequencies. Cell 1 is a UTRA 1,28Mcps TDD cell and cell 2 is a UTRA FDD cell. The DL DPCH shall be transmitted in timeslot 1 and the UL DPCH shall be transmitted in timeslot 3. No second Beacon timeslot shall be provided for cell 1. CPICH RSCP inter frequency absolute accuracy requirements are tested by using test parameters in table 8.7.2.1A.1.2.



Table 8.7.2.1A.1.2: CPICH RSCP inter frequency tests parameters

Parameter	Unit	Test 1		Test 2			
		Cell 1	Cell 2	Cell 1	Cell 2		
DL timeslot number		0	DwPTS	n.a.	0	DwPTS	n.a.
UTRA RF Channel number		Channel 1		Channel 2		Channel 1	
CPICH_Ec/Ior	dB	n.a.		-10		n.a.	
PCCPCH_Ec/Ior	dB	-3		-12	-3		-12
DwPCH_Ec/Ior	dB		0	n.a.		0	n.a.
SCH_Ec/Ior	dB	n.a.		-12		n.a.	
PICH_Ec/Ior	dB	n.a.		-15		n.a.	
OCNS_Ec/Ior	dB	-3		-0.94	-3		-0.94
Ior, Note 2	dBm/ 3.84 MHz	n.a.		-60		n.a.	
Ior, Note 2	dBm/ 1.28 MHz	-57.7		n.a.		-84.7	
Ior/Ior	dB	7		9.54		3	
PCCPCH RSCP, Note 1	dBm	-53.7		n.a.	-84.7		n.a.
CPICH RSCP, Note 1	dBm	n.a.		-60.46		n.a.	
Ior, Notes 1, 2	dBm/3.84 MHz	n.a.		-50		n.a.	
Ior, Notes 1, 2	dBm/1.28 MHz	-50		n.a.		-80	
Propagation condition	-	AWGN		AWGN		AWGN	
NOTE 1: PCCPCH RSCP, CPICH RSCP and Ior levels have been calculated from other parameters for information purposes. They are not settable parameters themselves.							
NOTE 2: Ior and Ior are given independently for TDD and FDD cells.							

A call is set up according to the test procedure specified in TS 34.108 [3] clause 7.3.2.3. The RF parameters for Test 1 are set up according to table 8.7.2.1A.1.2.

#### 8.7.2.1A.1.4.2 Procedure

- 1) SS shall transmit the MEASUREMENT CONTROL message for inter frequency measurement.
- 2) UE shall transmit periodically MEASUREMENT REPORT messages.
- 3) SS shall check CPICH RSCP value of Cell 2 in the MEASUREMENT REPORT messages. CPICH RSCP levels of Cell 2 reported by the UE is compared to the actual CPICH RSCP value of Cell 2 for each MEASUREMENT REPORT message.
- 4) SS shall count number of MEASUREMENT REPORT messages transmitted by UE.
- 5) After 1000 MEASUREMENT REPORT messages have been received from UE, the RF parameters are set up according to table 8.7.2.1A.1.2 for Test 2. While RF parameters are being set up, MEASUREMENT REPORT messages from UE are ignored. SS shall wait for additional 1s and ignore the MEASUREMENT REPORT messages during this period. Then, steps 2) and 3) above are repeated.
- 6) After further 1000 MEASUREMENT REPORT messages have been received from UE, the SS shall transmit RRC CONNECTION RELEASE message.
- 7) UE shall transmit RRC CONNECTION RELEASE COMPLETE message.

#### Specific Message Contents

All messages indicated above shall use the same content as described in the default message content in clause 9 of 34.108 [3], with the following exceptions:

MEASUREMENT CONTROL message for inter frequency measurement (Step 1):

Information Element	Value/Remark
Message Type	
UE information elements	
-RRC transaction identifier	0
-Integrity check info	Not Present
Measurement Information elements	
-Measurement Identity	2
-Measurement Command	Setup
-Measurement Reporting Mode	
- Measurement Report Transfer Mode	Acknowledged mode RLC
- Periodical Reporting / Event Trigger Reporting Mode	Periodical reporting
-Additional measurement list	Not Present
-CHOICE Measurement Type	Inter-frequency measurement
-Inter-frequency measurement object list	
-CHOICE Inter-frequency cell removal	Not Present
-New inter-frequency cells	Cell 2 information is included
-Cell for measurement	Not Present
-Inter-frequency measurement quantity	
-CHOICE reporting criteria	Inter-frequency reporting criteria
-Filter coefficient	0
-CHOICE mode	FDD
-Measurement quantity for frequency quality estimate	CPICH RSCP
-Inter-frequency reporting quantity	
-UTRA Carrier RSSI	FALSE
-Frequency quality estimate	TRUE
-Non frequency related cell reporting quantities	
-SFN-SFN observed time difference reporting indicator	No report
-Cell synchronisation information reporting indicator	FALSE
-Cell Identity reporting indicator	FALSE
-CHOICE mode	FDD
-CPICH Ec/N0 reporting indicator	FALSE
-CPICH RSCP reporting indicator	TRUE
-Pathloss reporting indicator	FALSE
-Reporting cell status	
-CHOICE reported cell	Report all active set cells + cells within monitored set on used frequency
-Maximum number of reported cells	Virtual/active set cells + 2
-Measurement validity	Not Present
-Inter-frequency set update	Not Present
-CHOICE report criteria	Periodical reporting criteria
-Amount of reporting	Infinity
-Reporting interval	500 ms
Physical channel information elements	
-DPCH compressed mode status info	Not Present

#### 8.7.2.1.1.5 Test requirements

The CPICH RSCP measurement accuracy shall meet the requirements in clause 8.7.2.1A.1.2 in at least 900 of the measurements in each test.

NOTE: If the above Test Requirement differs from the Minimum Requirement then the Test Tolerance applied for this test is non-zero. The Test Tolerance for this test is defined in clause F.2 and the explanation of how the Minimum Requirement has been relaxed by the Test Tolerance is given in clause F.4.

#### 8.7.2.1B.1 Absolute measurement accuracy for 7,68 Mcps TDD Option

##### 8.7.2.1B.1.1 Definition and applicability

The absolute accuracy of CPICH RSCP is defined as the CPICH RSCP measured in an UTRA FDD cell on one frequency compared to the actual CPICH RSCP power of that cell on the same frequency.

The requirements and this test apply only to UE supporting both UTRA TDD and UTRA FDD.

### 8.7.2.1B.1.2 Minimum Requirements

The accuracy requirements in table 8.7.2.1B.1.2.1 are valid under the following conditions:

- $CPICH\_RSCP_{1,2}|_{dBm} \geq -114$  dBm.

$$- \left( \frac{I_o}{\hat{I}_{or}} \right) \Big|_{in\ dB} - \left( \frac{CPICH\_E_c}{I_{or}} \right) \Big|_{in\ dB} \leq 20dB.$$

**Table 8.7.2.1B.1.2.1: CPICH RSCP inter frequency absolute accuracy**

Parameter	Unit	Accuracy [dB]		Conditions
		Normal condition	Extreme condition	Io [dBm/ 3,84 MHz]
CPICH_RSCP	dBm	± 6	± 9	-94...-70
	dBm	± 8	± 11	-70...-50

The normative reference for this requirement is TS 25.123 [2] clauses 9.1.1.2.1 and A.9.3.2.1.

### 8.7.2.1B.1.3 Test purpose

The purpose of this test is to verify that the CPICH RSCP absolute measurement accuracy is within the specified limits.

### 8.7.2.1B.1.4 Method of test

#### 8.7.2.1B.1.4.1 Initial conditions

Test environment: normal, TL/VL, TL/VH, TH/VL, TH/VH; see clauses G.2.1 and G.2.2.

Frequencies to be tested: mid range; see clause G.2.4.

In this case both cells are on different frequencies. Cell 1 is a UTRA TDD cell and cell 2 is a UTRA FDD cell. The DL DPCH shall be transmitted in timeslot 1 and the UL DPCH shall be transmitted in timeslot 3. No second Beacon timeslot shall be provided for cell 1. CPICH RSCP inter frequency absolute accuracy requirements are tested by using test parameters in table 8.7.2.1B.1.4.1.1.

**Table 8.7.2.1B.1.4.1.1: CPICH RSCP inter frequency tests parameters**

Parameter	Unit	Test 1		Test 2	
		Cell 1	Cell 2	Cell 1	Cell 2
DL timeslot number		0	n.a.	0	n.a.
UTRA RF Channel number		Channel 1	Channel 2	Channel 1	Channel 2
CPICH_Ec/Ior	dB	n.a.	-10	n.a.	-10
PCCPCH_Ec/Ior	dB	-3	-12	-3	-12
SCH_Ec/Ior	dB	-9	-12	-9	-12
SCH_t_offset		5	n.a.	5	n.a.
PICH_Ec/Ior	dB	n.a.	-15	n.a.	-15
OCNS_Ec/Ior	dB	-3.12	-0.94	-3.12	-0.94
Io	dBm/ 3,84 MHz	-57.7	-60	-84.7	-84
Ior/Ioc	dB	7	9.54	3	0
PCCPCH RSCP, Note 1	dBm	-53.7	n.a.	-84.7	n.a.
CPICH RSCP, Note 1	dBm	n.a.	-60.46	n.a.	-94
Io, Note 1	dBm/ 3,84 MHz	-50	-50	-80	-81
Propagation condition	-	AWGN		AWGN	
NOTE 1: PCCPCH RSCP, CPICH RSCP and Io levels have been calculated from other parameters for information purposes. They are not settable parameters themselves.					

A call is set up according to the test procedure specified in TS 34.108 [3] clause 7.3.2.3. The RF parameters for Test 1 are set up according to table 8.7.2.1B.1.4.1.1.

#### 8.7.2.1B.1.4.2 Procedure

- 1) SS shall transmit the MEASUREMENT CONTROL message for inter frequency measurement.
- 2) UE shall transmit periodically MEASUREMENT REPORT messages.
- 3) SS shall check CPICH RSCP value of Cell 2 in the MEASUREMENT REPORT messages. CPICH RSCP levels of Cell 2 reported by the UE is compared to the actual CPICH RSCP value of Cell 2 for each MEASUREMENT REPORT message.
- 4) SS shall count number of MEASUREMENT REPORT messages transmitted by UE. After 1000 MEASUREMENT REPORT messages have been received from UE, the RF parameters are set up according to table 8.7.2.1.1.2 for Test 2. While RF parameters are being set up, MEASUREMENT REPORT messages from UE are ignored. SS shall wait for additional 1s and ignore the MEASUREMENT REPORT messages during this period. Then, steps 2) and 3) above are repeated.
- 6) After further 1000 MEASUREMENT REPORT messages have been received from UE, the SS shall transmit RRC CONNECTION RELEASE message.
- 7) UE shall transmit RRC CONNECTION RELEASE COMPLETE message.

#### Specific Message Contents

All messages indicated above shall use the same content as described in the default message content in clause 9 of 34.108 [3] and in Annex I, with the following exceptions:

MEASUREMENT CONTROL message for inter frequency measurement (Step 1):

Information Element	Value/Remark
Message Type	
UE information elements	
-RRC transaction identifier	0
-Integrity check info	Not Present
Measurement Information elements	
-Measurement Identity	2
-Measurement Command	Setup
-Measurement Reporting Mode	
- Measurement Report Transfer Mode	Acknowledged mode RLC
- Periodical Reporting / Event Trigger Reporting Mode	Periodical reporting
-Additional measurement list	Not Present
-CHOICE Measurement Type	Inter-frequency measurement
-Inter-frequency measurement object list	
-CHOICE Inter-frequency cell removal	Not Present
-New inter-frequency cells	Cell 2 information is included
-Cell for measurement	Not Present
-Inter-frequency measurement quantity	
-CHOICE reporting criteria	Inter-frequency reporting criteria
-Filter coefficient	0
-CHOICE mode	FDD
-Measurement quantity for frequency quality estimate	CPICH RSCP
-Inter-frequency reporting quantity	
-UTRA Carrier RSSI	FALSE
-Frequency quality estimate	TRUE
-Non frequency related cell reporting quantities	
-SFN-SFN observed time difference reporting indicator	No report
-Cell synchronisation information reporting indicator	FALSE
-Cell Identity reporting indicator	FALSE
-CHOICE mode	FDD
-CPICH Ec/N0 reporting indicator	FALSE
-CPICH RSCP reporting indicator	TRUE
-Pathloss reporting indicator	FALSE
-Reporting cell status	
-CHOICE reported cell	Report all active set cells + cells within monitored set on used frequency
-Maximum number of reported cells	Virtual/active set cells + 2
-Measurement validity	Not Present
-Inter-frequency set update	Not Present
-CHOICE report criteria	Periodical reporting criteria
-Amount of reporting	Infinity
-Reporting interval	500 ms
Physical channel information elements	
-DPCH compressed mode status info	Not Present

#### 8.7.2.1B.1.5 Test requirements

The CPICH RSCP measurement accuracy shall meet the requirements in clause 8.7.2.1B.1.2.

NOTE: If the above Test Requirement differs from the Minimum Requirement then the Test Tolerance applied for this test is non-zero. The Test Tolerance for this test is defined in clause F.2 and the explanation of how the Minimum Requirement has been relaxed by the Test Tolerance is given in clause F.4.

#### 8.7.2.2 CPICH Ec/Io

Void

NOTE: This section is included for consistency with numbering in TS 25.123 [2] currently no test covering requirements in section 9.1.1.3 of [2] exists.

## 8.7.3 Timeslot ISCP

### 8.7.3.1 Intra frequency measurement accuracy for 3,84 Mcps TDD Option

#### 8.7.3.1.1 Absolute accuracy requirement

##### 8.7.3.1.1.1 Definition and applicability

The absolute accuracy of Timeslot ISCP is defined as the Timeslot ISCP measured from one cell / timeslot combination compared to the actual Timeslot ISCP level for the same cell / timeslot combination.

The requirements and this test apply to all types of UTRA TDD UE.

##### 8.7.3.1.1.2 Minimum Requirements

The absolute accuracy requirements in table 8.7.3.1.1.1 are valid under the following conditions:

P-CCPCH RSCP  $\geq$  -102 dBm.

$$\left( \frac{P - CCPCH - E_c}{I_o} \right)_{in \ dB} \geq -8dB$$

$$\left( \frac{SCH - E_c}{I_o} \right)_{in \ dB} \geq -13dB$$

**Table 8.7.3.1.1.1: UE Timeslot ISCP intra frequency absolute accuracy (3,84Mcps option)**

Parameter	Unit	Accuracy [dB]		Conditions
		Normal condition	Extreme condition	Io [dBm/ 3.84 MHz]
Timeslot_ISCP	dBm	$\pm 6$	$\pm 9$	-94...-70
	dBm	$\pm 8$	$\pm 11$	-70...-50

The normative reference for this requirement is TS 25.123 [2] clauses 9.2.1.2.1.1 and A.9.1.3.

##### 8.7.3.1.1.3 Test Purpose

The purpose of this test is to verify that the Timeslot ISCP measurement accuracy is within the specified limits.

##### 8.7.3.1.1.4 Method of test

##### 8.7.3.1.1.4.1 Initial conditions

Test environment: normal, TL/VL, TL/VH, TH/VL, TH/VH; see clauses G.2.1 and G.2.2.

Frequencies to be tested: mid range; see clause G.2.4.

In this case all cells are on the same frequency. Cell 1 and cell 2 shall be synchronised, i.e. share the same frame and timeslot timing. The DL DPCH shall be transmitted in timeslot 4 and the UL DPCH shall be transmitted in timeslot 12. The second Beacon timeslot shall be provided in timeslot 8 for both cell 1 and cell 2. The Timeslot ISCP intra frequency absolute accuracy requirements are tested by using test parameters in table 8.7.3.1.1.2.

Table 8.7.3.1.1.2: Timeslot ISCP intra frequency test parameters

Parameter	Unit	Test 1		Test 2		Test 3	
		Cell 1	Cell 2	Cell 1	Cell 2	Cell 1	Cell 2
DL timeslot number		0	0	0	0	0	0
UTRA RF Channel number		Channel 1		Channel 1		Channel 1	
PCCPCH_Ec/Ior	dB	-3		-3		-3	
SCH_Ec/Ior	dB	-9		-9		-9	
SCH_t <sub>offset</sub>		0	5	0	5	0	5
OCNS_Ec/Ior	dB	-3,12		-3,12		-3,12	
I <sub>oc</sub>	dBm / 3,84 MHz	-75.7		-59.8		-98.7	
I <sub>or</sub> /I <sub>oc</sub>	dB	5	2	9	2	3	0
Timeslot ISCP, Note 1	dBm	-73.7	-70.7	-57.8	-50.8	-98.7	-95.7
I <sub>o</sub> , Note 1	dBm / 3,84 MHz	-69		-50		-94	
Propagation condition		AWGN		AWGN		AWGN	

NOTE 1: Timeslot ISCP and I<sub>o</sub> levels have been calculated from other parameters for information purposes. They are not settable parameters themselves.

- 1) A call is set up according to the test procedure specified in TS 34.108 [3] clause 7.3.2.3. The RF parameters for Test 1 are set up according to table 8.7.3.1.1.2.

#### 8.7.3.1.1.4.2 Procedure

- 1) SS shall transmit MEASUREMENT CONTROL message.
- 2) UE shall transmit periodically MEASUREMENT REPORT messages.
- 3) SS shall check Timeslot ISCP values for Cell 1 / Timeslot 0 and Cell 2 / Timeslot 0 combinations in MEASUREMENT REPORT messages. These Timeslot ISCP values reported by the UE are compared to the actual Timeslot ISCP levels for each MEASUREMENT REPORT message.
- 4) SS shall count number of MEASUREMENT REPORT messages transmitted by UE. After 1000 MEASUREMENT REPORT messages have been received from UE, the RF parameters are set up according to table 8.7.3.1.1.2 for Test 2. While RF parameters are being set up, MEASUREMENT REPORT messages from UE are ignored. SS shall wait for additional 1s and ignore the MEASUREMENT REPORT messages during this period. Then, steps 2) and 3) above are repeated. After further 1000 MEASUREMENT REPORT messages have been received from UE, the RF parameters are set up according to table 8.7.3.1.1.2 for Test 3. While RF parameters are being set up, MEASUREMENT REPORT messages from UE are ignored. SS shall wait for additional 1s and ignore the MEASUREMENT REPORT messages during this period. Then, steps 2) and 3) above are repeated.
- 5) After further 1000 MEASUREMENT REPORT messages have been received from UE, the SS shall transmit RRC CONNECTION RELEASE message.
- 6) UE shall transmit RRC CONNECTION RELEASE COMPLETE message.

#### Specific Message Contents

All messages indicated above shall use the same content as described in the default message content in clause 9 of 34.108 [3] and in Annex I, with the following exceptions:

## MEASUREMENT CONTROL message (Step 1):

Information Element/Group name	Value/Remark
Message Type (10.2.17)	
UE information elements	
-RRC transaction identifier	0
-Integrity check info	Not Present
Measurement Information elements	
-Measurement Identity	1
-Measurement Command (10.3.7.46)	Modify
-Measurement Reporting Mode (10.3.7.49)	
-Measurement Report Transfer Mode	AM RLC
-Periodical Reporting / Event Trigger Reporting Mode	Periodical reporting
-Additional measurements list (10.3.7.1)	Not Present
-CHOICE <i>Measurement type</i>	Intra-frequency measurement
-Intra-frequency measurement (10.3.7.36)	
-Intra-frequency measurement objects list (10.3.7.33)	
-CHOICE <i>Intra-frequency cell removal</i>	Not present
-New intra-frequency cells	2
-Intra-frequency cell id	1
-Cell info	
-Cell individual offset	0
-Reference time difference to cell	Not present
-Read SFN indicator	FALSE
-CHOICE <i>mode</i>	TDD
-Primary CCPCH info (10.3.6.57)	
-CHOICE <i>mode</i>	TDD
-CHOICE <i>TDD option</i>	3,84 Mcps TDD
-CHOICE <i>Sync case</i>	2
-Timeslot	0
-Cell parameters ID	Set to cell parameter ID of cell 1
-SCTD indicator	FALSE
-Primary CCPCH Tx power	Set to Primary CCPCH Tx power of cell 1 as described in Table 8.7.3.1.2.
-Timeslot number	0
-Burst type	1
-Intra-frequency cell id	2
-Cell info	
-Cell individual offset	0
-Reference time difference to cell	Not present
-Read SFN indicator	FALSE
-CHOICE <i>mode</i>	TDD
-Primary CCPCH info (10.3.6.57)	
-CHOICE <i>mode</i>	TDD
-CHOICE <i>TDD option</i>	3,84 Mcps TDD
-CHOICE <i>Sync case</i>	2
-Timeslot	0
-Cell parameters ID	Set to cell parameter ID of cell 2
-SCTD indicator	FALSE
-Primary CCPCH Tx power	Set to Primary CCPCH Tx power of cell 2 as described in Table 8.7.3.1.2.
-Timeslot number	0
-Burst type	1
-Intra-frequency measurement quantity (10.3.7.38)	
-Filter coefficient (10.3.7.9)	0
-CHOICE <i>mode</i>	TDD
-Measurement quantity list	1
-Measurement quantity	Timeslot ISCP
-Intra-frequency reporting quantity (10.3.7.41)	
-Reporting quantities for active set cells (10.3.7.5)	
-SFN-SFN observed time difference reporting indicator	No report
-Cell synchronisation information reporting indicator	FALSE
-Cell Identity reporting indicator	FALSE
-CHOICE <i>mode</i>	TDD
-Timeslot ISCP reporting indicator	TRUE
-Primary CCPCH RSCP reporting indicator	TRUE
-Pathloss reporting indicator	FALSE
-Reporting quantities for monitored set cells (10.3.7.5)	



Information Element/Group name	Value/Remark
-SFN-SFN observed time difference reporting indicator	No report
-Cell synchronisation information reporting indicator	FALSE
-Cell Identity reporting indicator	FALSE
-CHOICE <i>mode</i>	TDD
-Timeslot ISCP reporting indicator	TRUE
-Proposed TGSN reporting required	FALSE
-Primary CCPCH RSCP reporting indicator	TRUE
-Pathloss reporting indicator	FALSE
-Reporting quantities for detected set cells (10.3.7.5)	Not Present
-Reporting cell status (10.3.7.61)	Report all active set cells + cells within monitored set on used frequency
-CHOICE <i>reported cell</i>	
-Maximum number of reported cells	Virtual / active set cells + 1
-Measurement validity (10.3.7.51)	Not Present
-CHOICE <i>report criteria</i> (10.3.7.	Infinity
-Periodical reporting criteria (10.3.7.53)	
-Amount of reporting	
-Reporting interval	
Physical channel information elements	500 ms
-DPCH compressed mode status info (10.3.6.34)	
	Not Present

#### 8.7.3.1.1.5 Test requirements

The Timeslot ISCP measurement accuracy shall meet the requirements in clause 8.7.3.1.1.2 for at least 900 of the reported Timeslot ISCP levels at each input level in step 4 for both Cell 1 / Timeslot 0 and Cell 2 / Timeslot 0 combinations.

NOTE: If the above Test Requirement differs from the Minimum Requirement then the Test Tolerance applied for this test is non-zero. The Test Tolerance for this test is defined in clause F.2 and the explanation of how the Minimum Requirement has been relaxed by the Test Tolerance is given in clause F.4.

#### 8.7.3.1A Intra frequency measurement accuracy for 1,28 Mcps TDD Option

##### 8.7.3.1A.1 Absolute accuracy requirement

###### 8.7.3.1A.1.1 Definition and applicability

The absolute accuracy of Timeslot ISCP is defined as the Timeslot ISCP measured from one cell / timeslot combination compared to the actual Timeslot ISCP level for the same cell / timeslot combination.

The requirements and this test apply to all types of UTRA TDD UE.

###### 8.7.3.1A.1.2 Minimum Requirements

The absolute accuracy requirements in table 8.7.3.1A.1.1 are valid under the following conditions:

P-CCPCH RSCP  $\geq$  -102 dBm.

$$\left( \frac{P - CCPCH - E_c}{I_o} \right) \Bigg|_{in \text{ dB}} \geq -8dB$$

$$\left( \frac{DwPCH - E_c}{I_o} \right) \Bigg|_{in \text{ dB}} \geq -5dB$$

**Table 8.7.3.1A.1.1: UE TDD Timeslot ISCP intra frequency absolute accuracy (1,28 Mcps option)**

Parameter	Unit	Accuracy [dB]		Conditions
		Normal condition	Extreme condition	Io [dBm/ 1.28MHz]
Timeslot_ISCP	dBm	$\pm 6$	$\pm 9$	-94...-70
	dBm	$\pm 8$	$\pm 11$	-70...-50

The normative reference for this requirement is TS 25.123 [2] clauses 9.2.1.2.1.2

#### 8.7.3.1A.1.3 Test Purpose

The purpose of this test is to verify that the Timeslot ISCP measurement accuracy is within the specified limits.

#### 8.7.3.1A.1.4 Method of test

##### 8.7.3.1A.1.4.1 Initial conditions

Test environment: normal, TL/VL, TL/VH, TH/VL, TH/VH; see clauses G.2.1 and G.2.2.

Frequencies to be tested: mid range; see clause G.2.4.

In this case all cells are on the same frequency. Cell 1 and cell 2 shall be synchronised, i.e. share the same frame and timeslot timing. The Timeslot ISCP intra frequency absolute accuracy requirements are tested by using test parameters in table 8.7.3.1A.1.2.

Table 8.7.3.1A.1.2: Timeslot ISCP intra frequency test parameters

		Test 1			
Parameter	Unit	Cell 1		Cell 2	
Timeslot Number		0	DwPTS	0	DwPTS
UTRA RF Channel Number		Channel 1		Channel 1	
PCCPCH_Ec/lor	dB	-3		-3	
DwPCH_Ec/lor	dB		0		0
OCNS_Ec/lor	dB	-3		-3	
$\hat{I}_{or}/I_{oc}$	dB	5		2	
$I_{oc}$	dBm/1.28 MHz	-76.6			
TS ISCP, Note 1	dBm	-74.6		-71.6	
Io, Note 1	dBm/1.28 MHz	-69			
Propagation condition		AWGN			
		Test 2			
Parameter	Unit	Cell 1		Cell 2	
Timeslot Number		0	DwPTS	0	DwPTS
UTRA RF Channel Number		Channel 1		Channel 1	
PCCPCH_Ec/lor	dB	-3		-3	
DwPCH_Ec/lor	dB		0		0
OCNS_Ec/lor	dB	-3		-3	
$\hat{I}_{or}/I_{oc}$	dB	9		2	
$I_{oc}$	dBm/1.28 MHz	-60.2			
TS ISCP, Note 1	dBm	-58.2		-51.2	
Io, Note 1	dBm/1.28 MHz	-50			
Propagation condition		AWGN			
		Test 3			
Parameter	Unit	Cell 1		Cell 2	
Timeslot Number		0	DwPTS	0	DwPTS
UTRA RF Channel Number		Channel 1		Channel 1	
PCCPCH_Ec/lor	dB	-3		-3	
DwPCH_Ec/lor	dB		0		0
OCNS_Ec/lor	dB	-3		-3	
$\hat{I}_{or}/I_{oc}$	dB	5		3	
$I_{oc}$	dBm/1.28 MHz	-101.9			
TS ISCP, Note 1	dBm	-98.9		-96.9	
Io, Note 1	dBm/1.28 MHz	-94			
Propagation condition		AWGN			
NOTE 1: TS ISCP and Io levels have been calculated from other parameters for information purposes. They are not settable parameters themselves.					

- 1) A call is set up according to the test procedure specified in TS 34.108 [3] clause 7.3.2.3. The RF parameters for Test 1 are set up according to table 8.7.3.1A.1.2.

#### 8.7.3.1A.1.4.2 Procedure

- 1) SS shall transmit MEASUREMENT CONTROL message.
- 2) UE shall transmit periodically MEASUREMENT REPORT messages.
- 3) SS shall check Timeslot ISCP values for Cell 1 / Timeslot 0 and Cell 2 / Timeslot 0 combinations in MEASUREMENT REPORT messages. These Timeslot ISCP values reported by the UE are compared to the actual Timeslot ISCP levels for each MEASUREMENT REPORT message.

- 4) SS shall count number of MEASUREMENT REPORT messages transmitted by UE. After 1000 MEASUREMENT REPORT messages have been received from UE, the RF parameters are set up according to table 8.7.3.1.1.2 for Test 2. While RF parameters are being set up, MEASUREMENT REPORT messages from UE are ignored. SS shall wait for additional 1s and ignore the MEASUREMENT REPORT messages during this period. Then, steps 2) and 3) above are repeated. After further 1000 MEASUREMENT REPORT messages have been received from UE, the RF parameters are set up according to table 8.7.3.1A.1.2 for Test 3. While RF parameters are being set up, MEASUREMENT REPORT messages from UE are ignored. SS shall wait for additional 1s and ignore the MEASUREMENT REPORT messages during this period. Then, steps 2) and 3) above are repeated.
- 5) After further 1000 MEASUREMENT REPORT messages have been received from UE, the SS shall transmit RRC CONNECTION RELEASE message.
- 6) UE shall transmit RRC CONNECTION RELEASE COMPLETE message.

#### Specific Message Contents

All messages indicated above shall use the same content as described in the default message content in clause 9 of 34.108 [3], with the following exceptions:

## MEASUREMENT CONTROL message (Step 1):

Information Element/Group name	Value/Remark
Message Type (10.2.17)	
UE information elements	
-RRC transaction identifier	0
-Integrity check info	Not Present
Measurement Information elements	
-Measurement Identity	1
-Measurement Command (10.3.7.46)	Modify
-Measurement Reporting Mode (10.3.7.49)	AM RLC
-Periodical Reporting / Event Trigger Reporting Mode	Periodical reporting
-Additional measurements list (10.3.7.1)	Not Present
-CHOICE <i>Measurement type</i>	Intra-frequency measurement
-Intra-frequency measurement (10.3.7.36)	
-Intra-frequency measurement objects list (10.3.7.33)	
-CHOICE <i>Intra-frequency cell removal</i>	Not present
-New intra-frequency cells	2
-Intra-frequency cell id	1
-Cell info	
-Cell individual offset	0
-Reference time difference to cell	Not present
-Read SFN indicator	FALSE
-CHOICE <i>mode</i>	TDD
-Primary CCPCH info (10.3.6.57)	
-CHOICE <i>mode</i>	TDD
-CHOICE <i>TDD option</i>	1,28 Mcps TDD
-Timeslot	0
-Cell parameters ID	Set to cell parameter ID of cell 1
-SCTD indicator	FALSE
-Primary CCPCH Tx power	Set to Primary CCPCH Tx power of cell 1 as described in Table 8.7.3.1A.2.
-Timeslot number	0
-Burst type	1
-Intra-frequency cell id	2
-Cell info	
-Cell individual offset	0
-Reference time difference to cell	Not present
-Read SFN indicator	FALSE
-CHOICE <i>mode</i>	TDD
-Primary CCPCH info (10.3.6.57)	
-CHOICE <i>mode</i>	TDD
-CHOICE <i>TDD option</i>	1,28 Mcps TDD
-Timeslot	0
-Cell parameters ID	Set to cell parameter ID of cell 2
-SCTD indicator	FALSE
-Primary CCPCH Tx power	Set to Primary CCPCH Tx power of cell 2 as described in Table 8.7.3.1A.2.
-Timeslot number	0
-Burst type	1
-Intra-frequency measurement quantity (10.3.7.38)	
-Filter coefficient (10.3.7.9)	0
-CHOICE <i>mode</i>	TDD
-Measurement quantity list	1
-Measurement quantity	Timeslot ISCP
-Intra-frequency reporting quantity (10.3.7.41)	
-Reporting quantities for active set cells (10.3.7.5)	
-SFN-SFN observed time difference reporting indicator	No report
-Cell synchronisation information reporting indicator	FALSE
-Cell Identity reporting indicator	FALSE
-CHOICE <i>mode</i>	TDD
-Timeslot ISCP reporting indicator	TRUE
-Primary CCPCH RSCP reporting indicator	TRUE
-Pathloss reporting indicator	FALSE
-Reporting quantities for monitored set cells (10.3.7.5)	

Information Element/Group name	Value/Remark
-SFN-SFN observed time difference reporting indicator	No report
-Cell synchronisation information reporting indicator	FALSE
-Cell Identity reporting indicator	FALSE
-CHOICE <i>mode</i>	TDD
-Timeslot ISCP reporting indicator	TRUE
-Proposed TGSN reporting required	FALSE
-Primary CCPCH RSCP reporting indicator	TRUE
-Pathloss reporting indicator	FALSE
-Reporting quantities for detected set cells (10.3.7.5)	Not Present
-Reporting cell status (10.3.7.61)	Report all active set cells + cells within monitored set on used frequency
-CHOICE <i>reported cell</i>	
-Maximum number of reported cells	Virtual / active set cells + 1
-Measurement validity (10.3.7.51)	Not Present
-CHOICE <i>report criteria</i> (10.3.7.	Infinity
-Periodical reporting criteria (10.3.7.53)	
-Amount of reporting	
-Reporting interval	
Physical channel information elements	500 ms
-DPCH compressed mode status info (10.3.6.34)	

#### 8.7.3.1A.1.5 Test requirements

The Timeslot ISCP measurement accuracy shall meet the requirements in clause 8.7.3.1A.1.2 for at least 900 of the reported Timeslot ISCP levels at each input level in step 4 for both Cell 1 / Timeslot 0 and Cell 2 / Timeslot 0 combinations.

NOTE: If the above Test Requirement differs from the Minimum Requirement then the Test Tolerance applied for this test is non-zero. The Test Tolerance for this test is defined in clause F.2 and the explanation of how the Minimum Requirement has been relaxed by the Test Tolerance is given in clause F.4.

#### 8.7.3.1B Intra frequency measurement accuracy for 7,68 Mcps TDD Option

##### 8.7.3.1B.1 Absolute accuracy requirement

###### 8.7.3.1B.1.1 Definition and applicability

The absolute accuracy of Timeslot ISCP is defined as the Timeslot ISCP measured from one cell / timeslot combination compared to the actual Timeslot ISCP level for the same cell / timeslot combination.

The requirements and this test apply to all types of UTRA TDD UE.

###### 8.7.3.1B.1.2 Minimum Requirements

The absolute accuracy requirements in table 8.7.3.1B.1.2.1 are valid under the following conditions:

P-CCPCH RSCP  $\geq$  -102 dBm.

$$\left( \frac{P - CCPCH - E_c}{I_o} \right) \Big|_{in \text{ dB}} \geq -11dB$$

$$\left( \frac{SCH - E_c}{I_o} \right) \Big|_{in \text{ dB}} \geq -13dB$$

**Table 8.7.3.1B.1.2.1: UE Timeslot ISCP intra frequency absolute accuracy (7,68Mcps option)**

Parameter	Unit	Accuracy [dB]		Conditions
		Normal condition	Extreme condition	Io [dBm/ 7.68 MHz]
Timeslot_ISCP	dBm	± 6	± 9	-94...-70
	dBm	± 8	± 11	-70...-50

The normative reference for this requirement is TS 25.123 [2] clauses 9.1.1.3.1.3. and A.9.3.3.

#### 8.7.3.1B.1.3 Test Purpose

The purpose of this test is to verify that the Timeslot ISCP measurement accuracy is within the specified limits.

#### 8.7.3.1B.1.4 Method of test

##### 8.7.3.1B.1.4.1 Initial conditions

Test environment: normal, TL/VL, TL/VH, TH/VL, TH/VH; see clauses G.2.1 and G.2.2.

Frequencies to be tested: mid range; see clause G.2.4.

In this case all cells are on the same frequency. Cell 1 and cell 2 shall be synchronised, i.e. share the same frame and timeslot timing. The DL DPCH shall be transmitted in timeslot 4 and the UL DPCH shall be transmitted in timeslot 12. The second Beacon timeslot shall be provided in timeslot 8 for both cell 1 and cell 2. The Timeslot ISCP intra frequency absolute accuracy requirements are tested by using test parameters in table 8.7.3.1B.1.4.1.1.

**Table 8.7.3.1B.1.4.1.1: Timeslot ISCP intra frequency test parameters**

Parameter	Unit	Test 1		Test 2		Test 3	
		Cell 1	Cell 2	Cell 1	Cell 2	Cell 1	Cell 2
DL timeslot number		0	0	0	0	0	0
UTRA RF Channel number		Channel 1		Channel 1		Channel 1	
PCCPCH_Ec/Ior	dB	-3		-3		-3	
SCH_Ec/Ior	dB	-9		-9		-9	
SCH_I_offset		0	5	0	5	0	5
OCNS_Ec/Ior	dB	-3,12		-3,12		-3,12	
Ioc	dBm / 7.68 MHz	-75.7		-59.8		-98.7	
Ior/Ioc	dB	5	2	9	2	3	0
Timeslot ISCP, Note 1	dBm	-73.7	-70.7	-57.8	-50.8	-98.7	-95.7
Io, Note 1	dBm / 7.68 MHz	-69		-50		-94	
Propagation condition		AWGN		AWGN		AWGN	
NOTE 1: Timeslot ISCP and Io levels have been calculated from other parameters for information purposes. They are not settable parameters themselves.							

- 1) A call is set up according to the test procedure specified in TS 34.108 [3] clause 7.3.2.3. The RF parameters for Test 1 are set up according to table 8.7.3.1B.1.4.1.1.

#### 8.7.3.1B.1.4.2 Procedure

- 1) SS shall transmit MEASUREMENT CONTROL message.
- 2) UE shall transmit periodically MEASUREMENT REPORT messages.
- 3) SS shall check Timeslot ISCP values for Cell 1 / Timeslot 0 and Cell 2 / Timeslot 0 combinations in MEASUREMENT REPORT messages. These Timeslot ISCP values reported by the UE are compared to the actual Timeslot ISCP levels for each MEASUREMENT REPORT message.
- 4) SS shall count number of MEASUREMENT REPORT messages transmitted by UE. After 1000 MEASUREMENT REPORT messages have been received from UE, the RF parameters are set up according to table 8.7.3.1.1.2 for Test 2. While RF parameters are being set up, MEASUREMENT REPORT messages from UE are ignored. SS shall wait for additional 1s and ignore the MEASUREMENT REPORT messages during this period. Then, steps 2) and 3) above are repeated. After further 1000 MEASUREMENT REPORT messages have

been received from UE, the RF parameters are set up according to table 8.7.3.1.1.2 for Test 3. While RF parameters are being set up, MEASUREMENT REPORT messages from UE are ignored. SS shall wait for additional 1s and ignore the MEASUREMENT REPORT messages during this period. Then, steps 2) and 3) above are repeated.

- 5) After further 1000 MEASUREMENT REPORT messages have been received from UE, the SS shall transmit RRC CONNECTION RELEASE message.
- 6) UE shall transmit RRC CONNECTION RELEASE COMPLETE message.

#### Specific Message Contents

All messages indicated above shall use the same content as described in the default message content in clause 9 of 34.108 [3] and in Annex I, with the following exceptions:



## MEASUREMENT CONTROL message (Step 1):

Information Element/Group name	Value/Remark
Message Type (10.2.17)	
UE information elements	
-RRC transaction identifier	0
-Integrity check info	Not Present
Measurement Information elements	
-Measurement Identity	1
-Measurement Command (10.3.7.46)	Modify
-Measurement Reporting Mode (10.3.7.49)	AM RLC
-Periodical Reporting / Event Trigger Reporting Mode	Periodical reporting
-Additional measurements list (10.3.7.1)	Not Present
-CHOICE <i>Measurement type</i>	Intra-frequency measurement
-Intra-frequency measurement (10.3.7.36)	
-Intra-frequency measurement objects list (10.3.7.33)	
-CHOICE <i>Intra-frequency cell removal</i>	Not present
-New intra-frequency cells	2
-Intra-frequency cell id	1
-Cell info	
-Cell individual offset	0
-Reference time difference to cell	Not present
-Read SFN indicator	FALSE
-CHOICE <i>mode</i>	TDD
-Primary CCPCH info (10.3.6.57)	
-CHOICE <i>mode</i>	TDD
-CHOICE <i>TDD option</i>	7,68 Mcps TDD
-CHOICE <i>Sync case</i>	2
-Timeslot	0
-Cell parameters ID	Set to cell parameter ID of cell 1
-SCTD indicator	FALSE
-Primary CCPCH Tx power	Set to Primary CCPCH Tx power of cell 1 as described in Table 8.7.3.1.2.
-Timeslot number	0
-Burst type	1
-Intra-frequency cell id	2
-Cell info	
-Cell individual offset	0
-Reference time difference to cell	Not present
-Read SFN indicator	FALSE
-CHOICE <i>mode</i>	TDD
-Primary CCPCH info (10.3.6.57)	
-CHOICE <i>mode</i>	TDD
-CHOICE <i>TDD option</i>	7,68 Mcps TDD
-CHOICE <i>Sync case</i>	2
-Timeslot	0
-Cell parameters ID	Set to cell parameter ID of cell 2
-SCTD indicator	FALSE
-Primary CCPCH Tx power	Set to Primary CCPCH Tx power of cell 2 as described in Table 8.7.3.1.2.
-Timeslot number	0
-Burst type	1
-Intra-frequency measurement quantity (10.3.7.38)	
-Filter coefficient (10.3.7.9)	0
-CHOICE <i>mode</i>	TDD
-Measurement quantity list	1
-Measurement quantity	Timeslot ISCP
-Intra-frequency reporting quantity (10.3.7.41)	
-Reporting quantities for active set cells (10.3.7.5)	
-SFN-SFN observed time difference reporting indicator	No report
-Cell synchronisation information reporting indicator	FALSE
-Cell Identity reporting indicator	FALSE
-CHOICE <i>mode</i>	TDD
-Timeslot ISCP reporting indicator	TRUE
-Primary CCPCH RSCP reporting indicator	TRUE
-Pathloss reporting indicator	FALSE
-Reporting quantities for monitored set cells (10.3.7.5)	

Information Element/Group name	Value/Remark
-SFN-SFN observed time difference reporting indicator	No report
-Cell synchronisation information reporting indicator	FALSE
-Cell Identity reporting indicator	FALSE
-CHOICE <i>mode</i>	TDD
-Timeslot ISCP reporting indicator	TRUE
-Proposed TGSN reporting required	FALSE
-Primary CCPCH RSCP reporting indicator	TRUE
-Pathloss reporting indicator	FALSE
-Reporting quantities for detected set cells (10.3.7.5)	Not Present
-Reporting cell status (10.3.7.61)	Report all active set cells + cells within monitored set on used frequency
-CHOICE <i>reported cell</i>	
-Maximum number of reported cells	Virtual / active set cells + 1
-Measurement validity (10.3.7.51)	Not Present
-CHOICE <i>report criteria</i> (10.3.7.	Infinity
-Periodical reporting criteria (10.3.7.53)	
-Amount of reporting	
-Reporting interval	
Physical channel information elements	500 ms
-DPCH compressed mode status info (10.3.6.34)	
	Not Present

### 8.7.3.1B.1.5 Test requirements

The Timeslot ISCP measurement accuracy shall meet the requirements in clause 8.7.3.1B.1.2 for at least 900 of the reported Timeslot ISCP levels at each input level in step 4 for both Cell 1 / Timeslot 0 and Cell 2 / Timeslot 0 combinations.

NOTE: If the above Test Requirement differs from the Minimum Requirement then the Test Tolerance applied for this test is non-zero. The Test Tolerance for this test is defined in clause F.2 and the explanation of how the Minimum Requirement has been relaxed by the Test Tolerance is given in clause F.4.

## 8.7.4 UTRA carrier RSSI

### 8.7.4.1 Absolute measurement accuracy for 3,84 Mcps TDD Option

#### 8.7.4.1.1 Definition and applicability

The absolute accuracy of UTRA carrier RSSI is defined as the UTRA carrier RSSI measured from one frequency compared to the actual UTRA carrier RSSI power of that same frequency.

The requirements and this test apply to all types of UTRA TDD UE.

#### 8.7.4.1.2 Minimum Requirements

**Table 8.7.4.1.1: UTRA carrier RSSI inter frequency absolute accuracy**

Parameter	Unit	Accuracy [dB]		Conditions
		Normal condition	Extreme condition	Io [dBm/ 3,84 MHz]
UTRA carrier RSSI	dBm	± 4	± 7	-94...-70
	dBm	± 6	± 9	-70...-50

The normative reference for this requirement is TS 25.123 [2] clause 9.1.1.4.

#### 8.7.4.1.3 Test Purpose

The purpose of this test is to verify that the UTRA carrier RSSI measurement accuracy is within the specified limits.

#### 8.7.4.1.4 Method of test

##### 8.7.4.1.4.1 Initial conditions

Test environment: normal, TL/VL, TL/VH, TH/VL, TH/VH; see clauses G.2.1 and G.2.2.

Frequencies to be tested: mid range; see clause G.2.4.

In this case both cells are on different frequencies. Cell 1 and cell 2 shall be synchronised, i.e. share the same frame and timeslot timing. The DL DPCH shall be transmitted in timeslot 4 and the UL DPCH shall be transmitted in timeslot 12. The second Beacon timeslot shall be provided in timeslot 8 for cell 1 and in timeslot 10 for cell 2. UTRA carrier RSSI absolute accuracy requirements are tested by using test parameters in table 8.7.4.1.2.

**Table 8.7.4.1.2: UTRA carrier RSSI inter frequency test parameters**

Parameter	Unit	Test 1		Test 2		Test 3	
		Cell 1	Cell 2	Cell 1	Cell 2	Cell 1	Cell 2
DL timeslot number		0	2	0	2	0	2
UTRA RF Channel number		Channel 1	Channel 2	Channel 1	Channel 2	Channel 1	Channel 2
PCCPCH_Ec/Ior	dB	-3		-3		-3	
SCH_Ec/Ior	dB	-9		-9		-9	
SCH_t_offset		0	5	0	5	0	5
OCNS_Ec/Ior	dB	-3,12		-3,12		-3,12	
Ioc	dBm / 3,84 MHz	-75.2	-75.2	-57.8	-54.1	-98.7	-97
Ior/Ioc	dB	5	5	7	2	3	0
Io, Note 1	dBm / 3,84 MHz	-69		-50		-94	
Propagation condition		AWGN		AWGN		AWGN	
NOTE 1: I <sub>o</sub> levels have been calculated from other parameters for information purposes. They are not settable parameters themselves.							

- 1) A call is set up according to the test procedure specified in TS 34.108 [3] subclause 7.3.2.3. The RF parameters for Test 1 are set up according to table 8.7.4.1.2.

#### 8.7.4.1.4.2 Procedure

- 1) SS shall transmit the MEASUREMENT CONTROL message for inter frequency measurements.
- 2) UE shall transmit periodically the MEASUREMENT REPORT messages.
- 3) SS shall check UTRA carrier RSSI value of Channel 2 in MEASUREMENT REPORT messages. UTRA carrier RSSI power of Channel 2 reported by UE is compared to actual UTRA carrier RSSI value of Channel 2 for each MEASUREMENT REPORT message.
- 4) SS shall count number of MEASUREMENT REPORT messages transmitted by UE. After 1000 MEASUREMENT REPORT messages have been received from UE, the RF parameters are set up according to table 8.7.4.1.2 for Test 2. While RF parameters are being set up, MEASUREMENT REPORT messages from UE are ignored. SS shall wait for additional 1s and ignore the MEASUREMENT REPORT messages during this period. Then, step 2) and 3) above are repeated. After further 1000 MEASUREMENT REPORT messages have been received from UE, the RF parameters are set up according to table 8.7.4.1.2 for Test 3. While RF parameters are being set up, MEASUREMENT REPORT messages from UE are ignored. SS shall wait for additional 1s and ignore the MEASUREMENT REPORT messages during this period. Then, steps 2) and 3) above are repeated.
- 5) After further 1000 MEASUREMENT REPORT messages have been received from UE, the SS shall transmit RRC CONNECTION RELEASE message.
- 6) UE shall transmit RRC CONNECTION RELEASE COMPLETE message.

#### Specific Message Contents

All messages indicated above shall use the same content as described in the default message content in clause 9 of 34.108 [3] and in Annex I, with the following exceptions:

MEASUREMENT CONTROL message for inter frequency measurement (Step 1):

Information Element/Group name	Value/Remark
Message Type (10.2.17)	
<b>UE information elements</b>	
-RRC transaction identifier	0
-Integrity check info	Not Present
<b>Measurement Information elements</b>	
-Measurement Identity	2
-Measurement Command (10.3.7.46)	Setup
-Measurement Reporting Mode (10.3.7.49)	AM RLC
-Periodical Reporting / Event Trigger Reporting Mode	Periodical reporting
-Additional measurements list (10.3.7.1)	Not Present
-CHOICE <i>Measurement type</i>	Inter-frequency measurement
-Inter-frequency measurement (10.3.7.16)	
-Inter-frequency measurement objects list (10.3.7.13)	
-CHOICE <i>inter-frequency cell removal</i>	Not present
-New inter-frequency cells	Cell 2 information is included
-Cell for measurement	Not Present
-Inter-frequency measurement quantity (10.3.7.18)	
-CHOICE <i>reporting criteria</i>	Inter-frequency reporting criteria
-Filter coefficient (10.3.7.9)	0
-CHOICE <i>mode</i>	TDD
-Measurement quantity for frequency quality estimate	Primary CCPCH RSCP
-Inter-frequency reporting quantity (10.3.7.21)	
-UTRA carrier RSSI	TRUE
-Frequency quality estimate	TRUE
-Non frequency related cell reporting quantities (10.3.7.5)	
-SFN-SFN observed time difference reporting indicator	No report
-Cell synchronisation information reporting indicator	FALSE
-Cell identity reporting indicator	FALSE
-CHOICE <i>mode</i>	TDD
-Timeslot ISCP reporting indicator	FALSE
-Proposed TGSN Reporting required	FALSE
-Primary CCPCH RSCP reporting indicator	TRUE
-Pathloss reporting indicator	FALSE
-Reporting cell status (10.3.7.61)	
-CHOICE <i>reported cell</i>	Report all active set cells + cells within monitored set on used frequency
-Maximum number of reported cells	Virtual/active set cells + 2
-Measurement validity (10.3.7.51)	Not present
-Inter-frequency set update	Not present
-CHOICE <i>report criteria</i> (10.3.7.	
-Periodical reporting criteria (10.3.7.53)	
-Amount of reporting	Infinity
-Reporting interval	500 ms
<b>Physical channel information elements</b>	
-DPCH compressed mode status info (10.3.6.34)	Not Present

#### 8.7.4.1.5 Test requirements

The UTRA carrier RSSI absolute measurement accuracy shall meet the requirements in clause 8.7.4.1.2. The effect of assumed thermal noise and noise generated in the receiver (-99 dBm) shall be added into the required accuracy defined in subclause 8.7.4.1.2 as shown in table 8.7.4.1.3.

**Table 8.7.4.1.3: UTRA carrier RSSI absolute accuracy**

Parameter	Unit	Accuracy [dB]		Conditions I <sub>o</sub> [dBm/3,84 MHz]
		Normal condition	Extreme condition	
UTRA carrier RSSI	dBm	-4...5.2	-7...8.2	-94...-87
	dBm	± 4	± 7	-87...-70
	dBm	± 6	± 9	-70...-50

The normative reference for this requirement is TS 25.123 [2] clause A.9.1.4.

NOTE: If the above Test Requirement differs from the Minimum Requirement then the Test Tolerance applied for this test is non-zero. The Test Tolerance for this test is defined in clause F.2 and the explanation of how the Minimum Requirement has been relaxed by the Test Tolerance is given in clause F.4.

### 8.7.4.1A Absolute measurement accuracy for 1,28 Mcps TDD Option

#### 8.7.4.1A.1 Definition and applicability

The absolute accuracy of UTRA carrier RSSI is defined as the UTRA carrier RSSI measured from one frequency compared to the actual UTRA carrier RSSI power of that same frequency.

The requirements and this test apply to all types of UTRA TDD UE.

#### 8.7.4.1A.2 Minimum Requirements

**Table 8.7.4.1A.1: 1,28Mcps UTRA carrier RSSI inter frequency absolute accuracy**

Parameter	Unit	Accuracy [dB]		Conditions
		Normal condition	Extreme condition	Io [dBm/ 1,28 MHz]
UTRA carrier RSSI	dBm	$\pm 4$	$\pm 7$	-94...-70
	dBm	$\pm 6$	$\pm 9$	-70...-50

The normative reference for this requirement is TS 25.123 [2] clause 9.1.1.4.

#### 8.7.4.1A.3 Test Purpose

The purpose of this test is to verify that the UTRA carrier RSSI measurement accuracy is within the specified limits.

#### 8.7.4.1A.4 Method of test

##### 8.7.4.1A.4.1 Initial conditions

Test environment: normal, TL/VL, TL/VH, TH/VL, TH/VH; see clauses G.2.1 and G.2.2.

Frequencies to be tested: mid range; see clause G.2.4.

In this case both cells are on different frequencies. Cell 1 and cell 2 shall be synchronised, i.e. share the same frame and timeslot timing.. UTRA carrier RSSI absolute accuracy requirements are tested by using test parameters in table 8.7.4.1A.2.

Table 8.7.4.1A.2: 1,28Mcps UTRA carrier RSSI inter frequency test parameters

		Test 1			
Parameter	Unit	Cell 1		Cell 2	
Timeslot Number		0	DwPTS	0	DwPTS
UTRA RF Channel Number		Channel 1		Channel 2	
PCCPCH_Ec/Ior	dB	-3		-3	
DwPCH_Ec/Ior	dB		0		0
OCNS_Ec/Ior	dB	-3		-3	
$\hat{I}_{or}/I_{oc}$	dB	5		5	
$I_{oc}$	dBm/1.28 MHz	-75.2		-75.2	
Io, Note 1	dBm/1.28 MHz	-69			
Propagation condition		AWGN			
		Test 2			
Parameter	Unit	Cell 1		Cell 2	
Timeslot Number		0	DwPTS	0	DwPTS
UTRA RF Channel Number		Channel 1		Channel 2	
PCCPCH_Ec/Ior	dB	-3		-3	
DwPCH_Ec/Ior	dB		0		0
OCNS_Ec/Ior	dB	-3		-3	
$\hat{I}_{or}/I_{oc}$	dB	7		2	
$I_{oc}$	dBm/1.28 MHz	-57.8		-54.1	
Io, Note 1	dBm/1.28 MHz	-50			
Propagation condition		AWGN			
		Test 3			
Parameter	Unit	Cell 1		Cell 2	
Timeslot Number		0	DwPTS	0	DwPTS
UTRA RF Channel Number		Channel 1		Channel 2	
PCCPCH_Ec/Ior	dB	-3		-3	
DwPCH_Ec/Ior	dB		0		0
OCNS_Ec/Ior	dB	-3		-3	
$\hat{I}_{or}/I_{oc}$	dB	3		0	
$I_{oc}$	dBm/1.28 MHz	-98.7		-97	
Io, Note 1	dBm/1.28 MHz	-94			
Propagation condition		AWGN			
NOTE 1: Io levels have been calculated from other parameters for information purposes. They are not settable parameters themselves.					

- 1) A call is set up according to the test procedure specified in TS 34.108 [3] subclause 7.3.2.3. The RF parameters for Test 1 are set up according to table 8.7.4.1A.2.

#### 8.7.4.1A.4.2 Procedure

- 1) SS shall transmit the MEASUREMENT CONTROL message for inter frequency measurements.
- 2) UE shall transmit periodically the MEASUREMENT REPORT messages.
- 3) SS shall check UTRA carrier RSSI value of Channel 2 in MEASUREMENT REPORT messages. UTRA carrier RSSI power of Channel 2 reported by UE is compared to actual UTRA carrier RSSI value of Channel 2 for each MEASUREMENT REPORT message.
- 4) SS shall count number of MEASUREMENT REPORT messages transmitted by UE.
- 5) After 1000 MEASUREMENT REPORT messages have been received from UE, the RF parameters are set up according to table 8.7.4.1A.2 for Test 2. While RF parameters are being set up, MEASUREMENT REPORT

messages from UE are ignored. SS shall wait for additional 1s and ignore the MEASUREMENT REPORT messages during this period. Then, step 2) and 3) above are repeated.

- 6) After further 1000 MEASUREMENT REPORT messages have been received from UE, the RF parameters are set up according to table 8.7.4.1A.2 for Test 3. While RF parameters are being set up, MEASUREMENT REPORT messages from UE are ignored. SS shall wait for additional 1s and ignore the MEASUREMENT REPORT messages during this period. Then, steps 2) and 3) above are repeated.
- 7) After further 1000 MEASUREMENT REPORT messages have been received from UE, the SS shall transmit RRC CONNECTION RELEASE message.
- 8) UE shall transmit RRC CONNECTION RELEASE COMPLETE message.

#### Specific Message Contents

All messages indicated above shall use the same content as described in the default message content in clause 9 of 34.108 [3]

MEASUREMENT CONTROL message for inter frequency measurement (Step 1):

Information Element/Group name	Value/Remark
Message Type (10.2.17)	
<b>UE information elements</b>	
-RRC transaction identifier	0
-Integrity check info	Not Present
<b>Measurement Information elements</b>	
-Measurement Identity	2
-Measurement Command (10.3.7.46)	Setup
-Measurement Reporting Mode (10.3.7.49)	AM RLC
-Periodical Reporting / Event Trigger Reporting Mode	Periodical reporting
-Additional measurements list (10.3.7.1)	Not Present
-CHOICE <i>Measurement type</i>	Inter-frequency measurement
-Inter-frequency measurement (10.3.7.16)	
-Inter-frequency measurement objects list (10.3.7.13)	
-CHOICE <i>inter-frequency cell removal</i>	Not present
-New inter-frequency cells	Cell 2 information is included
-Cell for measurement	Not Present
-Inter-frequency measurement quantity (10.3.7.18)	
-CHOICE <i>reporting criteria</i>	Inter-frequency reporting criteria
-Filter coefficient (10.3.7.9)	0
-CHOICE <i>mode</i>	TDD
-Measurement quantity for frequency quality estimate	Primary CCPCH RSCP
-Inter-frequency reporting quantity (10.3.7.21)	
-UTRA carrier RSSI	TRUE
-Frequency quality estimate	TRUE
-Non frequency related cell reporting quantities (10.3.7.5)	
-SFN-SFN observed time difference reporting indicator	No report
-Cell synchronisation information reporting indicator	FALSE
-Cell identity reporting indicator	FALSE
-CHOICE <i>mode</i>	TDD
-Timeslot ISCP reporting indicator	FALSE
-Proposed TGSN Reporting required	FALSE
-Primary CCPCH RSCP reporting indicator	TRUE
-Pathloss reporting indicator	FALSE
-Reporting cell status (10.3.7.61)	
-CHOICE <i>reported cell</i>	Report all active set cells + cells within monitored set on used frequency
-Maximum number of reported cells	Virtual/active set cells + 2
-Measurement validity (10.3.7.51)	Not present
-Inter-frequency set update	Not present
-CHOICE <i>report criteria</i> (10.3.7.	
-Periodical reporting criteria (10.3.7.53)	
-Amount of reporting	Infinity
-Reporting interval	500 ms
<b>Physical channel information elements</b>	
-DPCH compressed mode status info (10.3.6.34)	Not Present

#### 8.7.4.1A.5 Test requirements

The UTRA carrier RSSI absolute measurement accuracy shall meet the requirements in clause 8.7.4.1A.2 for at least 900 of the reported RSSI levels at each input level. The effect of assumed thermal noise and noise generated in the receiver (-99 dBm) shall be added into the required accuracy defined in subclause 8.7.4.1A.2 as shown in table 8.7.4.1A.3. (only relevant for the lowest power test 3)

**Table 8.7.4.1A.3: 1,28Mcps UTRA carrier RSSI absolute accuracy (corrected for RX noise)**

Parameter	Unit	Accuracy [dB]		Conditions
		Normal condition	Extreme condition	Io [dBm/1,28 MHz]
UTRA carrier RSSI	dBm	-4...5.2	-7...8.2	-94...-87
	dBm	± 4	± 7	-87...-70
	dBm	± 6	± 9	-70...-50



The normative reference for this requirement is TS 25.123 [2] clause A.9.1.4.

NOTE: If the above Test Requirement differs from the Minimum Requirement then the Test Tolerance applied for this test is non-zero. The Test Tolerance for this test is defined in clause F.2 and the explanation of how the Minimum Requirement has been relaxed by the Test Tolerance is given in clause F.4.

### 8.7.4.1B Absolute measurement accuracy for 7,68 Mcps TDD Option

#### 8.7.4.1B.1 Definition and applicability

The absolute accuracy of UTRA carrier RSSI is defined as the UTRA carrier RSSI measured from one frequency compared to the actual UTRA carrier RSSI power of that same frequency.

The requirements and this test apply to all types of UTRA TDD UE.

#### 8.7.4.1B.2 Minimum Requirements

**Table 8.7.4.1B.2.1: UTRA carrier RSSI inter frequency absolute accuracy**

Parameter	Unit	Accuracy [dB]		Conditions
		Normal condition	Extreme condition	Io [dBm/ 7.68 MHz]
UTRA Carrier RSSI	dBm	$\pm 4$	$\pm 7$	-94...-70
	dBm	$\pm 6$	$\pm 9$	-70...-50

The normative reference for this requirement is TS 25.123 [2] clause 9.1.1.4.1.3 and A9.3.4

#### 8.7.4.1B.3 Test Purpose

The purpose of this test is to verify that the UTRA carrier RSSI measurement accuracy is within the specified limits.

#### 8.7.4.1B.4 Method of test

##### 8.7.4.1B.4.1 Initial conditions

Test environment: normal, TL/VL, TL/VH, TH/VL, TH/VH; see clauses G.2.1 and G.2.2.

Frequencies to be tested: mid range; see clause G.2.4.

In this case both cells are on different frequencies. Cell 1 and cell 2 shall be synchronised, i.e. share the same frame and timeslot timing. The DL DPCH shall be transmitted in timeslot 4 and the UL DPCH shall be transmitted in timeslot 12. The second Beacon timeslot shall be provided in timeslot 8 for cell 1 and in timeslot 10 for cell 2. UTRA carrier RSSI absolute accuracy requirements are tested by using test parameters in table 8.7.4.1B.4.1.1.

**Table 8.7.4.1B.4.1.1: UTRA carrier RSSI inter frequency test parameters**

Parameter	Unit	Test 1		Test 2		Test 3	
		Cell 1	Cell 2	Cell 1	Cell 2	Cell 1	Cell 2
DL timeslot number		0	2	0	2	0	2
UTRA RF Channel number		Channel 1	Channel 2	Channel 1	Channel 2	Channel 1	Channel 2
PCCPCH_Ec/Ior	dB	-3		-3		-3	
SCH_Ec/Ior	dB	-9		-9		-9	
SCH_t_offset		0	5	0	5	0	5
OCNS_Ec/Ior	dB	-3,12		-3,12		-3,12	
Ior	dBm / 7.68 MHz	-75.2	-75.2	-57.8	-54.1	-98.7	-97
Ior/Ior	dB	5	5	7	2	3	0
Ior, Note 1	dBm / 7.68 MHz	-69		-50		-94	
Propagation condition		AWGN		AWGN		AWGN	
NOTE 1: Ior levels have been calculated from other parameters for information purposes. They are not settable parameters themselves.							

- 1) A call is set up according to the test procedure specified in TS 34.108 [3] subclause 7.3.2.3. The RF parameters for Test 1 are set up according to table 8.7.4.1B.4.1.1.

#### 8.7.4.1B.4.2 Procedure

- 1) SS shall transmit the MEASUREMENT CONTROL message for inter frequency measurements.
- 2) UE shall transmit periodically the MEASUREMENT REPORT messages.
- 3) SS shall check UTRA carrier RSSI value of Channel 2 in MEASUREMENT REPORT messages. UTRA carrier RSSI power of Channel 2 reported by UE is compared to actual UTRA carrier RSSI value of Channel 2 for each MEASUREMENT REPORT message.
- 4) SS shall count number of MEASUREMENT REPORT messages transmitted by UE. After 1000 MEASUREMENT REPORT messages have been received from UE, the RF parameters are set up according to table 8.7.4.1B.4.1.1 for Test 2. While RF parameters are being set up, MEASUREMENT REPORT messages from UE are ignored. SS shall wait for additional 1s and ignore the MEASUREMENT REPORT messages during this period. Then, step 2) and 3) above are repeated. After further 1000 MEASUREMENT REPORT messages have been received from UE, the RF parameters are set up according to table 8.7.4.1B.4.1.1 for Test 3. While RF parameters are being set up, MEASUREMENT REPORT messages from UE are ignored. SS shall wait for additional 1s and ignore the MEASUREMENT REPORT messages during this period. Then, steps 2) and 3) above are repeated.
- 5) After further 1000 MEASUREMENT REPORT messages have been received from UE, the SS shall transmit RRC CONNECTION RELEASE message.
- 6) UE shall transmit RRC CONNECTION RELEASE COMPLETE message.

#### Specific Message Contents

All messages indicated above shall use the same content as described in the default message content in clause 9 of 34.108 [3] and in Annex I, with the following exceptions:

MEASUREMENT CONTROL message for inter frequency measurement (Step 1):

Information Element/Group name	Value/Remark
Message Type (10.2.17)	
<b>UE information elements</b>	
-RRC transaction identifier	0
-Integrity check info	Not Present
<b>Measurement Information elements</b>	
-Measurement Identity	2
-Measurement Command (10.3.7.46)	Setup
-Measurement Reporting Mode (10.3.7.49)	AM RLC
-Periodical Reporting / Event Trigger Reporting Mode	Periodical reporting
-Additional measurements list (10.3.7.1)	Not Present
-CHOICE <i>Measurement type</i>	Inter-frequency measurement
-Inter-frequency measurement (10.3.7.16)	
-Inter-frequency measurement objects list (10.3.7.13)	
-CHOICE <i>inter-frequency cell removal</i>	Not present
-New inter-frequency cells	Cell 2 information is included
-Cell for measurement	Not Present
-Inter-frequency measurement quantity (10.3.7.18)	
-CHOICE <i>reporting criteria</i>	Inter-frequency reporting criteria
-Filter coefficient (10.3.7.9)	0
-CHOICE <i>mode</i>	TDD
-Measurement quantity for frequency quality estimate	Primary CCPCH RSCP
-Inter-frequency reporting quantity (10.3.7.21)	
-UTRA carrier RSSI	TRUE
-Frequency quality estimate	TRUE
-Non frequency related cell reporting quantities (10.3.7.5)	
-SFN-SFN observed time difference reporting indicator	No report
-Cell synchronisation information reporting indicator	FALSE
-Cell identity reporting indicator	FALSE
-CHOICE <i>mode</i>	TDD
-Timeslot ISCP reporting indicator	FALSE
-Proposed TGSN Reporting required	FALSE
-Primary CCPCH RSCP reporting indicator	TRUE
-Pathloss reporting indicator	FALSE
-Reporting cell status (10.3.7.61)	
-CHOICE <i>reported cell</i>	Report all active set cells + cells within monitored set on used frequency
-Maximum number of reported cells	Virtual/active set cells + 2
-Measurement validity (10.3.7.51)	Not present
-Inter-frequency set update	Not present
-CHOICE <i>report criteria</i> (10.3.7.	
-Periodical reporting criteria (10.3.7.53)	
-Amount of reporting	Infinity
-Reporting interval	500 ms
<b>Physical channel information elements</b>	
-DPCH compressed mode status info (10.3.6.34)	Not Present

#### 8.7.4.1B.5 Test requirements

The UTRA carrier RSSI absolute measurement accuracy shall meet the requirements in clause 8.7.4.1B.2. The effect of assumed thermal noise and noise generated in the receiver ( $-99$  dBm) shall be added into the required accuracy defined in subclause 8.7.4.1B.2 as shown in table 8.7.4.1B.3.

Table 8.7.4.1B.5.1: UTRA carrier RSSI absolute accuracy

Parameter	Unit	Accuracy [dB]		Conditions I <sub>o</sub> [dBm/7.68 MHz]
		Normal condition	Extreme condition	
UTRA Carrier RSSI	dBm	-4...5.2	-7...8.2	-94...-87
	dBm	± 4	± 7	-87...-70
	dBm	± 6	± 9	-70...-50

The normative reference for this requirement is TS 25.123 [2] clause A.9.3.4.

NOTE: If the above Test Requirement differs from the Minimum Requirement then the Test Tolerance applied for this test is non-zero. The Test Tolerance for this test is defined in clause F.2 and the explanation of how the Minimum Requirement has been relaxed by the Test Tolerance is given in clause F.4.

## 8.7.4.2 Relative measurement accuracy for 3,84 Mcps TDD Option

### 8.7.4.2.1 Definition and applicability

The relative accuracy requirement is defined as the UTRA carrier RSSI measured from one frequency compared to the UTRA Carrier RSSI measured from another frequency.

The requirements and this test apply to all types of UTRA TDD UE.

### 8.7.4.2.2 Minimum Requirements

The accuracy requirements in table 8.7.4.2.1 are valid under the following condition:

$$| \text{Channel 1}_{\text{Io}}|_{\text{dBm}/3,84 \text{ MHz}} - \text{Channel 2}_{\text{Io}}|_{\text{dBm}/3,84 \text{ MHz}} | < 20 \text{ dB.}$$

Table 8.7.4.2.1: UTRA carrier RSSI inter frequency relative accuracy

Parameter	Unit	Accuracy [dB]		Conditions
		Normal condition	Extreme condition	Io [dBm/3,84 MHz]
UTRA carrier RSSI	dBm	$\pm 7$	$\pm 11$	-94...-50

The normative reference for this requirement is TS 25.123 [2] clause 9.1.1.4.

### 8.7.4.2.3 Test Purpose

The purpose of this test is to verify that the UTRA carrier RSSI measurement accuracy is within the specified limits.

### 8.7.4.2.4 Method of test

#### 8.7.4.2.4.1 Initial conditions

Test environment: normal, TL/VL, TL/VH, TH/VL, TH/VH; see clauses G.2.1 and G.2.2.

Frequencies to be tested: mid range; see clause G.2.4.

In this case both cells are on different frequencies. Cell 1 and cell 2 shall be synchronised, i.e. share the same frame and timeslot timing. The DL DPCH shall be transmitted in timeslot 4 and the UL DPCH shall be transmitted in timeslot 12. The second Beacon timeslot shall be provided in timeslot 8 for cell 1 and in timeslot 10 for cell 2. UTRA carrier RSSI absolute accuracy requirements are tested by using test parameters in table 8.7.4.1.2.

- 1) A call is set up according to the test procedure specified in TS 34.108 [3] clause 7.3.2.3. The RF parameters for Test 1 are set up according to table 8.7.4.1.2.

#### 8.7.4.2.4.2 Procedure

- 1) SS shall transmit the MEASUREMENT CONTROL message for Inter-frequency measurements.
- 2) UE shall transmit periodically the MEASUREMENT REPORT messages.
- 3) SS shall check UTRA carrier RSSI value of Channel 2 in MEASUREMENT REPORT messages. UTRA carrier RSSI power of Channel 2 reported by UE is compared to actual UTRA carrier RSSI value of Channel 2 for each MEASUREMENT REPORT message.
- 4) SS shall count number of MEASUREMENT REPORT messages transmitted by UE. After 1000 MEASUREMENT REPORT messages have been received from UE, the RF parameters are set up according to table 8.7.4.1.2 for Test 2. While RF parameters are being set up, MEASUREMENT REPORT messages from UE are ignored. SS shall wait for additional 1s and ignore the MEASUREMENT REPORT messages during this period. Then, step 3) above is repeated. After further 1000 MEASUREMENT REPORT messages have been

received from UE, the RF parameters are set up according to table 8.7.4.1.2 for Test 3. While RF parameters are being set up, MEASUREMENT REPORT messages from UE are ignored. SS shall wait for additional 1s and ignore the MEASUREMENT REPORT messages during this period. Then, step 3) above is repeated.

- 5) After further 1000 MEASUREMENT REPORT messages have been received from UE, the SS shall transmit RRC CONNECTION RELEASE message.
- 6) UE shall transmit RRC CONNECTION RELEASE COMPLETE message.

### Specific Message Contents

All messages indicated above shall use the same content as described in the default message content in clause 9 of 34.108 [3] and in Annex I, with the following exceptions:

MEASUREMENT CONTROL message for inter frequency measurements in clause 8.7.4.1.4.2 is used.

### 8.7.4.2.5 Test requirements

The UTRA carrier RSSI absolute measurement accuracy shall meet the requirements in clause 8.7.4.2.2. The effect of assumed thermal noise and noise generated in the receiver (-99 dBm) shall be added into the required accuracy defined in subclause 8.7.4.2.2 as shown in table 8.7.4.2.2.

**Table 8.7.4.2.2: UTRA carrier RSSI relative accuracy**

Parameter	Unit	Accuracy [dB]		Conditions
		Normal condition	Extreme condition	I <sub>o</sub> [dBm/3,84 MHz]
UTRA carrier RSSI	dBm	-4...5.2	-7...8.2	-94...-87
	dBm	± 4	± 7	-87...-70
	dBm	± 6	± 9	-70...-50

The normative reference for this requirement is TS 25.123 [2] clause A.9.1.4.

NOTE: If the above Test Requirement differs from the Minimum Requirement then the Test Tolerance applied for this test is non-zero. The Test Tolerance for this test is defined in clause F.2 and the explanation of how the Minimum Requirement has been relaxed by the Test Tolerance is given in clause F.4.

### 8.7.4.2A Relative measurement accuracy for 1,28 Mcps TDD Option

#### 8.7.4.2A.1 Definition and applicability

The relative accuracy requirement is defined as the UTRA carrier RSSI measured from one frequency compared to the UTRA Carrier RSSI measured from another frequency.

The requirements and this test apply to all types of UTRA TDD UE.

#### 8.7.4.2A.2 Minimum Requirements

The accuracy requirements in table 8.7.4.2A.1 are valid under the following condition:

$$|\text{Channel 1\_I}_o|_{\text{dBm}/1,28 \text{ MHz}} - \text{Channel 2\_I}_o|_{\text{dBm}/1,28 \text{ MHz}}| < 20 \text{ dB}.$$

**Table 8.7.4.2A.1: UTRA carrier RSSI inter frequency relative accuracy**

Parameter	Unit	Accuracy [dB]		Conditions
		Normal condition	Extreme condition	I <sub>o</sub> [dBm/1,28 MHz]
UTRA carrier RSSI	dBm	± 7	± 11	-94...-50

The normative reference for this requirement is TS 25.123 [2] clause 9.1.1.4.

#### 8.7.4.2A.3 Test Purpose

The purpose of this test is to verify that the UTRA carrier RSSI measurement accuracy is within the specified limits.

## 8.7.4.2A.4 Method of test

## 8.7.4.2A.4.1 Initial conditions

Test environment: normal, TL/VL, TL/VH, TH/VL, TH/VH; see clauses G.2.1 and G.2.2.

Frequencies to be tested: mid range; see clause G.2.4.

In this case both cells are on different frequencies. Cell 1 and cell 2 shall be synchronised, i.e. share the same frame and timeslot timing.. UTRA carrier RSSI absolute accuracy requirements are tested by using test parameters in table 8.7.4.1A.2.

- 1) A call is set up according to the test procedure specified in TS 34.108 [3] clause 7.3.2.3. The RF parameters for Test 1 are set up according to table 8.7.4.2A.2.

**Table 8.7.4.2A.2: 1,28Mcps UTRA carrier RSSI inter frequency test parameters**

		Test 1			
Parameter	Unit	Cell 1		Cell 2	
Timeslot Number		0	DwPTS	0	DwPTS
UTRA RF Channel Number		Channel 1		Channel 2	
PCCPCH_Ec/lor	dB	-3		-3	
DwPCH_Ec/lor	dB		0		0
OCNS_Ec/lor	dB	-3		-3	
$\hat{I}_{or}/I_{oc}$	dB	5		5	
$I_{oc}$	dBm/1.28 MHz	-75.2		-75.2	
Io, Note 1	dBm/1.28 MHz	-69			
Propagation condition		AWGN			
		Test 2			
Parameter	Unit	Cell 1		Cell 2	
Timeslot Number		0	DwPTS	0	DwPTS
UTRA RF Channel Number		Channel 1		Channel 2	
PCCPCH_Ec/lor	dB	-3		-3	
DwPCH_Ec/lor	dB		0		0
OCNS_Ec/lor	dB	-3		-3	
$\hat{I}_{or}/I_{oc}$	dB	7		2	
$I_{oc}$	dBm/1.28 MHz	-57.8		-54.1	
Io, Note 1	dBm/1.28 MHz	-50			
Propagation condition		AWGN			
		Test 3			
Parameter	Unit	Cell 1		Cell 2	
Timeslot Number		0	DwPTS	0	DwPTS
UTRA RF Channel Number		Channel 1		Channel 2	
PCCPCH_Ec/lor	dB	-3		-3	
DwPCH_Ec/lor	dB		0		0
OCNS_Ec/lor	dB	-3		-3	
$\hat{I}_{or}/I_{oc}$	dB	3		0	
$I_{oc}$	dBm/1.28 MHz	-98.7		-97	
Io, Note 1	dBm/1.28 MHz	-94			
Propagation condition		AWGN			
NOTE 1: Io levels have been calculated from other parameters for information purposes. They are not settable parameters themselves.					

#### 8.7.4.2A.4.2 Procedure

- 1) SS shall transmit the MEASUREMENT CONTROL message for Inter-frequency measurements.
- 2) UE shall transmit periodically the MEASUREMENT REPORT messages.
- 3) SS shall check UTRA carrier RSSI value of Channel 2 in MEASUREMENT REPORT messages. UTRA carrier RSSI power of Channel 2 reported by UE is compared to actual UTRA carrier RSSI value of Channel 2 for each MEASUREMENT REPORT message.
- 4) SS shall count number of MEASUREMENT REPORT messages transmitted by UE.
- 5) After 1000 MEASUREMENT REPORT messages have been received from UE, the RF parameters are set up according to table 8.7.4.1.2 for Test 2. While RF parameters are being set up, MEASUREMENT REPORT messages from UE are ignored. SS shall wait for additional 1s and ignore the MEASUREMENT REPORT messages during this period. Then, step 3) above is repeated.
- 6) After further 1000 MEASUREMENT REPORT messages have been received from UE, the RF parameters are set up according to table 8.7.4.1.2 for Test 3. While RF parameters are being set up, MEASUREMENT REPORT messages from UE are ignored. SS shall wait for additional 1s and ignore the MEASUREMENT REPORT messages during this period. Then, step 3) above is repeated.
- 5) After further 1000 MEASUREMENT REPORT messages have been received from UE, the SS shall transmit RRC CONNECTION RELEASE message.
- 6) UE shall transmit RRC CONNECTION RELEASE COMPLETE message.

#### Specific Message Contents

All messages indicated above shall use the same content as described in the default message content in clause 9 of 34.108 [3] and in Annex I, with the following exceptions:

The same MEASUREMENT CONTROL message for absolute inter frequency measurements in clause 8.7.4.1A.4.2 is used.

#### 8.7.4.2A.5 Test requirements

The UTRA carrier RSSI absolute measurement accuracy shall meet the requirements in clause 8.7.4.2A.2 for at least 900 of the reported RSSI levels at each input level. The effect of assumed thermal noise and noise generated in the receiver (-99 dBm) shall be added into the required accuracy defined in subclause 8.7.4.2A.2 as shown in table 8.7.4.2A.3. (only relevant for the lowest power test 3)

**Table 8.7.4.2A.3: UTRA carrier RSSI relative accuracy (corrected for RX noise)**

Parameter	Unit	Accuracy [dB]		Conditions
		Normal condition	Extreme condition	Io [dBm/1,28 MHz]
UTRA carrier RSSI	dBm	-4...5.2	-7...8.2	-94...-87
	dBm	± 4	± 7	-87...-70
	dBm	± 6	± 9	-70...-50

The normative reference for this requirement is TS 25.123 [2] clause A.9.1.4.

NOTE: If the above Test Requirement differs from the Minimum Requirement then the Test Tolerance applied for this test is non-zero. The Test Tolerance for this test is defined in clause F.2 and the explanation of how the Minimum Requirement has been relaxed by the Test Tolerance is given in clause F.4.

#### 8.7.4.2B Relative measurement accuracy for 7,68 Mcps TDD Option

##### 8.7.4.2B.1 Definition and applicability

The relative accuracy requirement is defined as the UTRA carrier RSSI measured from one frequency compared to the UTRA Carrier RSSI measured from another frequency.

The requirements and this test apply to all types of UTRA TDD UE.

### 8.7.4.2B.2 Minimum Requirements

The accuracy requirements in table 8.7.4.2B.2.1 are valid under the following condition:

$$| \text{Channel 1\_Io}_{\text{dBm}/3,84 \text{ MHz}} - \text{Channel 2\_Io}_{\text{dBm}/3,84 \text{ MHz}} | < 20 \text{ dB.}$$

**Table 8.7.4.2B.2.1: UTRA carrier RSSI inter frequency relative accuracy**

Parameter	Unit	Accuracy [dB]		Conditions
		Normal condition	Extreme condition	Io [dBm/7.68 MHz]
UTRA Carrier RSSI	dBm	± 7	± 11	-94...-50

The normative reference for this requirement is TS 25.123 [2] clause 9.1.1.4.2 and A9.3.4

### 8.7.4.2B.3 Test Purpose

The purpose of this test is to verify that the UTRA carrier RSSI measurement accuracy is within the specified limits.

### 8.7.4.2B.4 Method of test

#### 8.7.4.2B.4.1 Initial conditions

Test environment: normal, TL/VL, TL/VH, TH/VL, TH/VH; see clauses G.2.1 and G.2.2.

Frequencies to be tested: mid range; see clause G.2.4.

In this case both cells are on different frequencies. Cell 1 and cell 2 shall be synchronised, i.e. share the same frame and timeslot timing. The DL DPCH shall be transmitted in timeslot 4 and the UL DPCH shall be transmitted in timeslot 12. The second Beacon timeslot shall be provided in timeslot 8 for cell 1 and in timeslot 10 for cell 2. UTRA carrier RSSI absolute accuracy requirements are tested by using test parameters in table 8.7.4.1B.4.1.1.

- 1) A call is set up according to the test procedure specified in TS 34.108 [3] clause 7.3.2.3. The RF parameters for Test 1 are set up according to table 8.7.4.1B.4.1.1.

#### 8.7.4.2B.4.2 Procedure

- 1) SS shall transmit the MEASUREMENT CONTROL message for Inter-frequency measurements.
- 2) UE shall transmit periodically the MEASUREMENT REPORT messages.
- 3) SS shall check UTRA carrier RSSI value of Channel 2 in MEASUREMENT REPORT messages. UTRA carrier RSSI power of Channel 2 reported by UE is compared to actual UTRA carrier RSSI value of Channel 2 for each MEASUREMENT REPORT message.
- 4) SS shall count number of MEASUREMENT REPORT messages transmitted by UE. After 1000 MEASUREMENT REPORT messages have been received from UE, the RF parameters are set up according to table 8.7.4.1B.4.1.1 for Test 2. While RF parameters are being set up, MEASUREMENT REPORT messages from UE are ignored. SS shall wait for additional 1s and ignore the MEASUREMENT REPORT messages during this period. Then, step 3) above is repeated. After further 1000 MEASUREMENT REPORT messages have been received from UE, the RF parameters are set up according to table 8.7.4.1B.4.1.1 for Test 3. While RF parameters are being set up, MEASUREMENT REPORT messages from UE are ignored. SS shall wait for additional 1s and ignore the MEASUREMENT REPORT messages during this period. Then, step 3) above is repeated.
- 5) After further 1000 MEASUREMENT REPORT messages have been received from UE, the SS shall transmit RRC CONNECTION RELEASE message.
- 6) UE shall transmit RRC CONNECTION RELEASE COMPLETE message.

### Specific Message Contents

All messages indicated above shall use the same content as described in the default message content in clause 9 of 34.108 [3] and in Annex I, with the following exceptions:



MEASUREMENT CONTROL message for inter frequency measurements in clause 8.7.4.1B.4.2 is used.

### 8.7.4.2B.5 Test requirements

The UTRA carrier RSSI absolute measurement accuracy shall meet the requirements in clause 8.7.4.2B.2. The effect of assumed thermal noise and noise generated in the receiver (-99 dBm) shall be added into the required accuracy defined in subclause 8.7.4.2B.2 as shown in table 8.7.4.2B.5.1.

**Table 8.7.4.2B.5.1: UTRA carrier RSSI relative accuracy**

Parameter	Unit	Accuracy [dB]		Conditions
		Normal condition	Extreme condition	Io [dBm/3,84 MHz]
UTRA carrier RSSI	dBm	-4...5.2	-7...8.2	-94...-87
	dBm	± 4	± 7	-87...-70
	dBm	± 6	± 9	-70...-50

The normative reference for this requirement is TS 25.123 [2] clause A.9.3.4.

NOTE: If the above Test Requirement differs from the Minimum Requirement then the Test Tolerance applied for this test is non-zero. The Test Tolerance for this test is defined in clause F.2 and the explanation of how the Minimum Requirement has been relaxed by the Test Tolerance is given in clause F.4.

## 8.7.5 GSM carrier RSSI

### 8.7.5.1.1 RSSI (RX\_LEV) 3,84 Mcps TDD Option

Void

### 8.7.5.1A.1 RSSI (RX\_LEV) 1,28 Mcps TDD Option

#### 8.7.5.1A.1.1 Definition and applicability

The absolute accuracy of GSM RSSI is defined as the RX\_LEV measured in a GSM cell on one frequency compared to the actual power of that cell.

The requirements and this test apply only to UE supporting both 1,28Mcps UTRA TDD and GSM.

#### 8.7.5.1A.1.2 Minimum Requirements

**Table 8.7.5.1A.1.1: GSM RX\_LEV absolute accuracy**

Parameter	Unit	Accuracy [dB]		Conditions
		Normal condition	Extreme condition	Input level dBm
RX_LEV	dBm	± 4	± 6	-110...-70
	dBm	± 6	± 6	-70...-48
	dBm	± 9	± 9	-48...-38

RXLEV 0	=	less than	-110 dBm.
RXLEV 1	=	-110 dBm	to -109 dBm
RXLEV 2	=	-109 dBm	to -108 dBm
		:	
		:	
RXLEV 62	=	-49 dBm	to -48 dBm
RXLEV 63	=	greater than	-48 dBm

The normative reference for this requirement is TS 45.008 [20] clause 8.1.2

#### 8.7.5.1A.1.3 Test purpose

The purpose of this test is to verify that the GSM RSSI absolute measurement accuracy is within the specified limits.

This test will verify the requirements in section 9.1.1.5 and A.9.1.5 of TS25.123.

## 8.7.5.1A.1.4 Method of test

## 8.7.5.1A.1.4.1 Initial conditions

Test environment: normal, TL/VL, TL/VH, TH/VL, TH/VH; see clauses G.2.1 and G.2.2.

Frequencies to be tested: mid range; see clause G.2.4.

Cell 1 is a UTRA 1,28Mcps TDD cell and cell 2 is a GSM cell

A call is set up according to the test procedure specified in TS 34.108 [3] clause 7.3.2.3. The RF parameters for Test are set up according to table 8.7.5.1A.1.2.

**Table 8.7.5.1A.1.2. General GSM RSSI test parameters**

Parameter	Unit	Value	Comment
DCH parameters		DL reference measurement channel 12.2 kbps	As specified in TS 25.102 section A.2.2
Power Control		On	
Target quality value on DTCH	BLER	0.01	
Inter-RAT measurement quantity		GSM carrier RSSI	
BSIC verification required		No	
Monitored cell list size		6 GSM neighbours including ARFCN 1	

**Table 8.7.5.1A.1.3 Cell 1 (TDD Cell) specific test parameters**

Parameter	Unit	Cell 1	
DL timeslot number		0	DwPTS
UTRA RF Channel number		Channel 1	
PCCPCH_Ec/Ior	dB	-3	
DwPCH_Ec/Ior	dB		0
OCNS_Ec/Ior	dB	-3	
Ior/Ioc	dB	3	
Ioc	dBm / 1.28MHz	-70	
Propagation condition		AWGN	

**Table 8.7.5.1A.1.4 Cell 2 specific GSM Cell test parameters**

Parameter	Unit	TEST1	TEST2	TEST3
UTRA RF Channel number		2		
Cell Level	dBm/200KHz	-100	-75	-50
Propagation condition		AWGN	AWGN	AWGN

## 8.7.5.1A.1.4.2 Procedure

- 1) SS shall transmit the MEASUREMENT CONTROL message for inter RAT measurement. In the measurement control information periodic reporting of the GSM carrier RSSI is requested to the UE.
- 2) UE shall transmit periodically MEASUREMENT REPORT messages.
- 3) SS shall check RX\_LEV value of Cell 2 in the MEASUREMENT REPORT messages. Levels of Cell 2 reported by the UE are compared to the actual level of Cell 2 for each MEASUREMENT REPORT message.
- 4) SS shall count number of MEASUREMENT REPORT messages transmitted by UE. After 1000 MEASUREMENT REPORT messages have been received from UE, the GSM cell RF parameters are set up according to table 8.7.5.1A.1.4 for Test 2. While RF parameters are being set up, MEASUREMENT REPORT messages from UE are ignored. SS shall wait for additional 1s and ignore the MEASUREMENT REPORT messages during this period. Then, steps 2) and 3) above are repeated.

- 6) After further 1000 MEASUREMENT REPORT messages have been received from UE, the GSM cell RF parameters are set up according to table 8.7.5.1A.1.4 for Test 2. While RF parameters are being set up, MEASUREMENT REPORT messages from UE are ignored. SS shall wait for additional 1s and ignore the MEASUREMENT REPORT messages during this period. Then, steps 2) and 3) above are repeated.
- 7) After further 1000 MEASUREMENT REPORT messages have been received from UE, the SS shall transmit RRC CONNECTION RELEASE message.
- 8) UE shall transmit RRC CONNECTION RELEASE COMPLETE message.

### Specific Message Contents

All messages indicated above shall use the same content as described in the default message content in clause 9 of 34.108 [3], with the following exceptions:

Note: Numbers in brackets after an item e.g “Message Type (10.2.17)” in the IE description are references to clause numbers in TS 25.331 [9] describing that item in more detail.

MEASUREMENT CONTROL message for GSM RSSI measurement (Step 1):

Information Element	Value/Remark
Message Type (10.2.17)	
UE information elements	
-RRC transaction identifier	0
-Integrity check info	Not Present
Measurement Information elements	
-Measurement Identity	2
-Measurement Command	Setup
-Measurement Reporting Mode	
- Measurement Report Transfer Mode	Acknowledged mode RLC
- Periodical Reporting / Event Trigger Reporting Mode	Periodical reporting
-Additional measurement list	Not Present
-CHOICE Measurement Type	Inter-RAT measurement
-Inter-frequency measurement object list	
-CHOICE Inter-frequency cell removal	Not Present
-New inter-frequency cells	Cell 2 information is included
-Cell for measurement	Not Present
-Inter-frequency measurement quantity	
-CHOICE reporting criteria	Inter-frequency reporting criteria
-Filter coefficient	0
-CHOICE mode	GSM
-Measurement quantity	RX_LEV
-Inter-frequency reporting quantity	
-UTRA Carrier RSSI	
-Frequency quality estimate	FALSE
-Non frequency related cell reporting quantities	FALSE
-SFN-SFN observed time difference reporting indicator	No report
-Cell synchronisation information reporting indicator	
-Maximum number of reported cells	Report all active set cells + cells within monitored set on used frequency
-Measurement validity	Virtual/active set cells + 2
-Inter-frequency set update	Not Present
-CHOICE report criteria	Not Present
-Amount of reporting	Not Present
-Reporting interval	Periodical reporting criteria Infinity 500 ms
Physical channel information elements	
-DPCH compressed mode status info	Not Present

#### 8.7.2.1.1.5 Test requirements

The RX\_LEV measurement accuracy shall meet the requirements in clause 8.7.5.1A.1.1 for at least 900 of the reported levels at each input level.

NOTE: If the above Test Requirement differs from the Minimum Requirement then the Test Tolerance applied for this test is non-zero. The Test Tolerance for this test is defined in clause F.2 and the explanation of how the Minimum Requirement has been relaxed by the Test Tolerance is given in clause F.4.

### 8.7.5.1B.1 RSSI (RX\_LEV) 7,68 Mcps TDD Option

#### 8.7.5.1B.1.1 Definition and applicability

Cell 1 is a UTRA TDD cell and cell 2 is a GSM cell. In the measurement control information it is indicated to the UE that periodic reporting of the GSM carrier RSSI measurement is used.

The requirements and this test apply only to UE supporting both 7,68Mcps UTRA TDD and GSM.

#### 8.7.5.1B.1.2 Minimum Requirements

**Table 8.7.5.1B.1.2.1: GSM RX\_LEV absolute accuracy**

Parameter	Unit	Accuracy [dB]		Conditions
		Normal condition	Extreme condition	Input level dBm
RX_LEV	dBm	± 4	± 6	-110...-70
	dBm	± 6	± 6	-70...-48
	dBm	± 9	± 9	-48...-38

RXLEV 0	=	less than	-110 dBm.
RXLEV 1	=	-110 dBm	to -109 dBm
RXLEV 2	=	-109 dBm	to -108 dBm
		:	
		:	
RXLEV 62	=	-49 dBm	to -48 dBm
RXLEV 63	=	greater than	-48 dBm

The normative reference for this requirement is TS 45.008 [20] clause 8.1.2

#### 8.7.5.1B.1.3 Test purpose

The purpose of this test is to verify that the GSM RSSI absolute measurement accuracy is within the specified limits.

This test will verify the requirements in section 9.1.1.5 and A.9.3.5 of TS25.123.

#### 8.7.5.1B.1.4 Method of test

##### 8.7.5.1B.1.4.1 Initial conditions

Test environment: normal, TL/VL, TL/VH, TH/VL, TH/VH; see clauses G.2.1 and G.2.2.

Frequencies to be tested: mid range; see clause G.2.4.

Cell 1 is a UTRA 1,28Mcps TDD cell and cell 2 is a GSM cell

A call is set up according to the test procedure specified in TS 34.108 [3] clause 7.3.2.3. The RF parameters for Test are set up according to table 8.7.5.1B.1.4.1.1, 8.7.5.1B.1.4.1.2 and 8.7.5.1B.1.4.1.3.

**Table 8.7.5.1B.1.4.1.1 General GSM RSSI test parameters**

Parameter	Unit	Value	Comment
DCH parameters		DL reference measurement channel 12.2 kbps	As specified in TS 25.102 section A.2.2
Power Control		On	
Target quality value on DTCH	BLER	0.01	
Inter-RAT measurement quantity		GSM carrier RSSI	
BSIC verification required		No	
Monitored cell list size		6 GSM neighbours including ARFCN 1	

**Table 8.7.5.1B.1.4.1.2 Cell 1 (TDD Cell) specific test parameters**

Parameter	Unit	Cell 1	
		0	1
DL timeslot number		0	1
UTRA RF Channel number		Channel 1	
PCCPCH_Ec/Ior	dB	-3	n.a.
SCH_Ec/Ior	dB	-9	n.a.
SCH <sub>t</sub> offset		0	n.a.
OCNS_Ec/Ior	dB	-3,12	Note 2
DPCH_Ec/Ior	dB	n.a.	Note 1
Ior/Ioc	dB	6	6
Io, Note 1	dBm / 7.68 MHz	-70	
Propagation condition		AWGN	
Note 1: The DPCH level is controlled by the power control loop			
Note 2: The power of the OCNS channel that is added shall make the total power from the cell to be equal to Ior.			

**Table 8.7.5.1B.1.4.1.3 Cell 2 specific GSM Cell test parameters**

Parameter	Unit	TEST1	TEST2	TEST3
UTRA RF Channel number		2		
Cell Level	dBm/200KHz	-100	-75	-50
Propagation condition		AWGN	AWGN	AWGN

**8.7.5.1B.1.4.2 Procedure**

- 1) SS shall transmit the MEASUREMENT CONTROL message for inter RAT measurement. In the measurement control information periodic reporting of the GSM carrier RSSI is requested to the UE.
- 2) UE shall transmit periodically MEASUREMENT REPORT messages.
- 3) SS shall check RX\_LEV value of Cell 2 in the MEASUREMENT REPORT messages. Levels of Cell 2 reported by the UE are compared to the actual level of Cell 2 for each MEASUREMENT REPORT message.
- 4) SS shall count number of MEASUREMENT REPORT messages transmitted by UE. After 1000 MEASUREMENT REPORT messages have been received from UE, the GSM cell RF parameters are set up according to table 8.7.5.1B.1.4.1.3 for Test 2. While RF parameters are being set up, MEASUREMENT REPORT messages from UE are ignored. SS shall wait for additional 1s and ignore the MEASUREMENT REPORT messages during this period. Then, steps 2) and 3) above are repeated.
- 6) After further 1000 MEASUREMENT REPORT messages have been received from UE, the GSM cell RF parameters are set up according to table 8.7.5.1B.1.4.1.3 for Test 3. While RF parameters are being set up, MEASUREMENT REPORT messages from UE are ignored. SS shall wait for additional 1s and ignore the MEASUREMENT REPORT messages during this period. Then, steps 2) and 3) above are repeated.
- 7) After further 1000 MEASUREMENT REPORT messages have been received from UE, the SS shall transmit RRC CONNECTION RELEASE message.
- 8) UE shall transmit RRC CONNECTION RELEASE COMPLETE message.

**Specific Message Contents**

All messages indicated above shall use the same content as described in the default message content in clause 9 of 34.108 [3], with the following exceptions:

Note: Numbers in brackets after an item e.g “Message Type (10.2.17)” in the IE description are references to clause numbers in TS 25.331 [9] describing that item in more detail.

MEASUREMENT CONTROL message for GSM RSSI measurement (Step 1):

Information Element	Value/Remark
Message Type (10.2.17)	
UE information elements	
-RRC transaction identifier	0
-Integrity check info	Not Present
Measurement Information elements	
-Measurement Identity	2
-Measurement Command	Setup
-Measurement Reporting Mode	
- Measurement Report Transfer Mode	Acknowledged mode RLC
- Periodical Reporting / Event Trigger Reporting Mode	Periodical reporting
-Additional measurement list	Not Present
-CHOICE Measurement Type	Inter-RAT measurement
-Inter-frequency measurement object list	
-CHOICE Inter-frequency cell removal	Not Present
-New inter-frequency cells	Cell 2 information is included
-Cell for measurement	Not Present
-Inter-frequency measurement quantity	
-CHOICE reporting criteria	Inter-frequency reporting criteria
-Filter coefficient	0
-CHOICE mode	GSM
-Measurement quantity	RX_LEV
-Inter-frequency reporting quantity	
-UTRA Carrier RSSI	
-Frequency quality estimate	FALSE
-Non frequency related cell reporting quantities	FALSE
-SFN-SFN observed time difference reporting indicator	No report
-Cell synchronisation information reporting indicator	
-Maximum number of reported cells	Report all active set cells + cells within monitored set on used frequency
-Measurement validity	Virtual/active set cells + 2
-Inter-frequency set update	Not Present
-CHOICE report criteria	Not Present
-Amount of reporting	Not Present
-Reporting interval	Periodical reporting criteria Infinity 500 ms
Physical channel information elements	
-DPCH compressed mode status info	Not Present

#### 8.7.5.1B.1.5 Test requirements

The RX\_LEV measurement accuracy shall meet the requirements in clause 8.7.5.1B.1.2 for at least 900 of the reported levels at each input level.

NOTE: If the above Test Requirement differs from the Minimum Requirement then the Test Tolerance applied for this test is non-zero. The Test Tolerance for this test is defined in clause F.2 and the explanation of how the Minimum Requirement has been relaxed by the Test Tolerance is given in clause F.4.

#### 8.7.6 SIR

Void

#### 8.7.7 Transport Channel BLER

Void

## 8.7.8 SFN-SFN observed time difference

### 8.7.8.1 SFN-SFN observed time difference type 1

#### 8.7.8.1.1 Measurement accuracy for 3,84 Mcps TDD Option

##### 8.7.8.1.1.1 Definition and applicability

This measurement is specified in clause 5.1.10 of TS 25.225 [22]. The reference point for the SFN-SFN observed time difference type 1 shall be the antenna connector of the UE.

The requirements and this test apply to all types of UTRA TDD UE.

##### 8.7.8.1.1.2 Minimum requirements

The accuracy requirement in table 8.7.8.1.1.1 is valid under the following conditions:

P-CCPCH\_RSCP1,2 ≥ -102 dBm..

$$\left| P\text{-CCPCH RSCP1} \Big|_{in\ dBm} - P\text{-CCPCH RSCP2} \Big|_{in\ dBm} \right| \leq 20dB$$

$$\left( \frac{P\text{-CCPCH} - E_c}{I_o} \right) \Big|_{in\ dB} \geq -8dB$$

$$\left( \frac{SCH - E_c}{I_o} \right) \Big|_{in\ dB} \geq -13dB$$

where the received P-CCPCH  $E_c/I_o$  is defined as,

$$\left( \frac{P\text{-CCPCH} - E_c}{I_o} \right) \Big|_{in\ dB} = \left( \frac{P\text{-CCPCH} - E_c}{I_{or}} \right) \Big|_{in\ dB} - \left( \frac{I_o}{\hat{I}_{or}} \right) \Big|_{in\ dB}$$

and the received SCH  $E_c/I_o$  is defined as,

$$\left( \frac{SCH - E_c}{I_o} \right) \Big|_{in\ dB} = \left( \frac{SCH - E_c}{I_{or}} \right) \Big|_{in\ dB} - \left( \frac{I_o}{\hat{I}_{or}} \right) \Big|_{in\ dB}$$

and  $SCH\_E_c/I_{or}$  is equally divided between primary synchronisation code and the sum of all secondary synchronisation codes, where the secondary synchronisation codes are also equally divided.

**Table 8.7.8.1.1.1: SFN-SFN observed time difference type 1 accuracy**

Parameter	Unit	Accuracy [chip]	Conditions
			$I_o$ [dBm/3,84 MHz]
SFN-SFN observed time difference type 1	chip	+/-0,5	-94...-50

The normative reference for this requirement is TS 25.123 [2] clause 9.1.1.8 and A.9.1.8.

##### 8.7.8.1.1.3 Test purpose

The purpose of this test is to verify that the measurement accuracy of SFN-SFN observed time difference type 1 is within the limit specified in clause 8.7.8.1.1.2.

## 8.7.8.1.1.4 Method of test

## 8.7.8.1.1.4.1 Initial conditions

Test environment: normal; see clauses G.2.1 and G.2.2.

Frequencies to be tested: mid range; see clause G.2.4.

In this case all cells are on the same frequency. Cell 1 and cell 2 shall be synchronised, i.e. share the same frame and timeslot timing. The DL DPCH shall be transmitted in timeslot 4 and the UL DPCH shall be transmitted in timeslot 12. The second Beacon timeslot shall be provided in timeslot 8 for cell 1 and in timeslot 10 for cell 2. During the test, the timing difference between cell 1 and cell 2 can be set to any value from 0...9830400 chip. The SFN-SFN observed time difference type 1 accuracy requirements in the intra-frequency case are tested by using test parameters in Table 8.7.8.1.1.2.

**Table 8.7.8.1.1.2: SFN-SFN observed time difference type 1 intra frequency test parameters**

Parameter	Unit	Test 1		Test 2		Test 3	
		Cell 1	Cell 2	Cell 1	Cell 2	Cell 1	Cell 2
DL timeslot number		0	2	0	2	0	2
UTRA RF Channel number		Channel 1		Channel 1		Channel 1	
PCCPCH_Ec/Ior	dB	-3		-3		-3	
SCH_Ec/Ior	dB	-9		-9		-9	
SCH <sub>t_offset</sub>		0	5	0	5	0	5
OCNS_Ec/Ior	dB	-3,12		-3,12		-3,12	
Ioc	dBm / 3,84 MHz	-75.2	-75.2	-57.8	-54.7	-98.7	-98.7
Ior/Ioc	dB	5	5	7	3	3	3
Io, Note 1	dBm / 3,84 MHz	-69		-50		-94	
Propagation condition		AWGN		AWGN		AWGN	
NOTE 1: I <sub>o</sub> levels have been calculated from other parameters for information purposes. They are not settable parameters themselves.							

- 1) A call is set up according to the test procedure specified in TS 34.108 [3] subclause 7.3.2.3. The RF parameters for Test 1 are set up according to table 8.7.8.1.1.2.

## 8.7.8.1.1.4.2 Procedure

- 1) SS shall transmit the MEASUREMENT CONTROL message.
- 2) UE shall transmit periodically MEASUREMENT REPORT messages.
- 3) SS shall check "SFN-SFN observed time difference type 1" value in MEASUREMENT REPORT message. The reported value shall be compared to the actually set SFN-SFN observed time difference type 1 value for each MEASUREMENT REPORT message.
- 4) SS shall count the number of MEASUREMENT REPORT messages transmitted by UE. After 1000 MEASUREMENT REPORT messages have been received from UE, the RF parameters are set up according to table 8.7.8.1.1.2 for Test 2. While RF parameters are being set up, MEASUREMENT REPORT messages from UE are ignored. SS shall wait for additional 1s and ignore the MEASUREMENT REPORT messages during this period. Then, steps 2) and 3) above are repeated. After further 1000 MEASUREMENT REPORT messages have been received from UE, the RF parameters are set up according to table 8.7.8.1.1.2 for Test 3. While RF parameters are being set up, MEASUREMENT REPORT messages from UE are ignored. SS shall wait for additional 1s and ignore the MEASUREMENT REPORT messages during this period. Then, steps 2) and 3) above are repeated.
- 5) After further 1000 MEASUREMENT REPORT messages have been received from UE, the SS shall transmit RRC CONNECTION RELEASE message.
- 6) UE shall transmit RRC CONNECTION RELEASE COMPLETE message.



## Specific Message Contents

All messages indicated above shall use the same content as described in the default message content in clause 9 of 34.108 [3] and in Annex I, with the following exceptions:

## MEASUREMENT CONTROL message (Step 1):

Information Element/Group name	Value/Remark
Message Type (10.2.17)	
UE information elements	
-RRC transaction identifier	0
-Integrity check info	Not Present
Measurement Information elements	
-Measurement Identity	1
-Measurement Command (10.3.7.46)	Modify
-Measurement Reporting Mode (10.3.7.49)	AM RLC
-Measurement Report Transfer Mode	Periodical reporting
-Periodical Reporting / Event Trigger Reporting Mode	Not Present
-Additional measurements list (10.3.7.1)	
-CHOICE <i>Measurement type</i>	Intra-frequency measurement
-Intra-frequency measurement (10.3.7.36)	
-Intra-frequency measurement objects list (10.3.7.33)	Not Present
-Intra-frequency measurement quantity (10.3.7.38)	
-Filter coefficient (10.3.7.9)	0
-CHOICE <i>mode</i>	TDD
-Measurement quantity list	1
-Measurement quantity	Primary CCPCH RSCP
-Intra-frequency reporting quantity (10.3.7.41)	
-Reporting quantities for active set cells (10.3.7.5)	
-SFN-SFN observed time difference reporting indicator	Type 1
-Cell synchronisation information reporting indicator	FALSE
-Cell Identity reporting indicator	FALSE
-CHOICE <i>mode</i>	TDD
-Timeslot ISCP reporting indicator	FALSE
-Primary CCPCH RSCP reporting indicator	TRUE
-Pathloss reporting indicator	TRUE
-Reporting quantities for monitored set cells (10.3.7.5)	
-SFN-SFN observed time difference reporting indicator	Type 1
-Cell synchronisation information reporting indicator	FALSE
-Cell Identity reporting indicator	FALSE
-CHOICE <i>mode</i>	TDD
-Timeslot ISCP reporting indicator	FALSE
-Proposed TGSN reporting required	FALSE
-Primary CCPCH RSCP reporting indicator	TRUE
-Pathloss reporting indicator	TRUE
-Reporting quantities for detected set cells (10.3.7.5)	Not Present
-Reporting cell status (10.3.7.61)	
-CHOICE <i>reported cell</i>	Report all active set cells + cells within monitored set on used frequency
-Maximum number of reported cells	Virtual/active set cells + 2
-Measurement validity (10.3.7.51)	Not Present
-CHOICE <i>report criteria</i> (10.3.7.	
-Periodical reporting criteria (10.3.7.53)	
-Amount of reporting	Infinity
-Reporting interval	250 ms
Physical channel information elements	
-DPCH compressed mode status info (10.3.6.34)	Not Present

## 8.7.8.1.1.5 Test requirements

The SFN-SFN observed time difference type 1 accuracy shall meet the requirements in clause 8.7.8.1.1.2.

NOTE: If the above Test Requirement differs from the Minimum Requirement then the Test Tolerance applied for this test is non-zero. The Test Tolerance for this test is defined in clause F.2 and the explanation of how the Minimum Requirement has been relaxed by the Test Tolerance is given in clause F.4.

## 8.7.8.1.1A Measurement accuracy for 1,28 Mcps TDD Option

Void

## 8.7.8.1.1B Measurement accuracy for 7,68 Mcps TDD Option

## 8.7.8.1.1B.1 Definition and applicability

This measurement is specified in clause 5.1.10 of TS 25.225 [22]. The reference point for the SFN-SFN observed time difference type 1 shall be the antenna connector of the UE.

The requirements and this test apply to all types of UTRA TDD UE.

## 8.7.8.1.1B.2 Minimum requirements

The accuracy requirement in table 8.7.8.1.1B.2.1 is valid under the following conditions:

$$P\text{-CCPCH\_RSCP1,2} \geq -102 \text{ dBm.}$$

$$\left| P\text{-CCPCH RSCP1} \Big|_{in \text{ dBm}} - P\text{-CCPCH RSCP2} \Big|_{in \text{ dBm}} \right| \leq 20 \text{ dB}$$

$$\left( \frac{P\text{-CCPCH} - E_c}{I_o} \right) \Big|_{in \text{ dB}} \geq -11 \text{ dB}$$

$$\left( \frac{SCH - E_c}{I_o} \right) \Big|_{in \text{ dB}} \geq -13 \text{ dB}$$

where the received P-CCPCH  $E_c/I_o$  is defined as,

$$\left( \frac{P\text{-CCPCH} - E_c}{I_o} \right) \Big|_{in \text{ dB}} = \left( \frac{P\text{-CCPCH} - E_c}{I_{or}} \right) \Big|_{in \text{ dB}} - \left( \frac{I_o}{\hat{I}_{or}} \right) \Big|_{in \text{ dB}}$$

and the received SCH  $E_c/I_o$  is defined as,

$$\left( \frac{SCH - E_c}{I_o} \right) \Big|_{in \text{ dB}} = \left( \frac{SCH - E_c}{I_{or}} \right) \Big|_{in \text{ dB}} - \left( \frac{I_o}{\hat{I}_{or}} \right) \Big|_{in \text{ dB}}$$

and  $SCH\_E_c/I_{or}$  is equally divided between primary synchronisation code and the sum of all secondary synchronisation codes, where the secondary synchronisation codes are also equally divided.

**Table 8.7.8.1.1B.2.1: SFN-SFN observed time difference type 1 accuracy**

Parameter	Unit	Accuracy [chip]	Conditions
			$I_o$ [dBm/7.68 MHz]
SFN-SFN observed time difference	chip	+/-1 for both type 1 and 2	-94...-50

The normative reference for this requirement is TS 25.123 [2] clause 9.1.1.8.1.3 and A.9.3.8.

## 8.7.8.1.1B.3 Test purpose

The purpose of this test is to verify that the measurement accuracy of SFN-SFN observed time difference type 1 is within the limit specified in clause 8.7.8.1.1B.2.

## 8.7.8.1.1B.4 Method of test

## 8.7.8.1.1B.4.1 Initial conditions

Test environment: normal; see clauses G.2.1 and G.2.2.

Frequencies to be tested: mid range; see clause G.2.4.

In this case all cells are on the same frequency. Cell 1 and cell 2 shall be synchronised, i.e. share the same frame and timeslot timing. The DL DPCH shall be transmitted in timeslot 4 and the UL DPCH shall be transmitted in timeslot 12. The second Beacon timeslot shall be provided in timeslot 8 for cell 1 and in timeslot 10 for cell 2. During the test, the timing difference between cell 1 and cell 2 can be set to any value from 0...19660800 chip. The SFN-SFN observed time difference type 1 accuracy requirements in the intra-frequency case are tested by using test parameters in Table 8.7.8.1.1B.4.1.1.

**Table 8.7.8.1.1B.4.1.1: SFN-SFN observed time difference type 1 intra frequency test parameters**

Parameter	Unit	Test 1		Test 2		Test 3	
		Cell 1	Cell 2	Cell 1	Cell 2	Cell 1	Cell 2
DL timeslot number		0	2	0	2	0	2
UTRA RF Channel number		Channel 1		Channel 1		Channel 1	
PCCPCH_Ec/lor	dB	-3		-3		-3	
SCH_Ec/lor	dB	-9		-9		-9	
SCH <sub>t_offset</sub>		0	5	0	5	0	5
OCNS_Ec/lor	dB	-3,12		-3,12		-3,12	
loc	dBm / 7.68 MHz	-75.2	-75.2	-57.8	-54.7	-98.7	-98.7
lor/loc	dB	5	5	7	3	3	3
lo, Note 1	dBm / 7.68 MHz	-69		-50		-94	
Propagation condition		AWGN		AWGN		AWGN	
NOTE 1: lo levels have been calculated from other parameters for information purposes. They are not settable parameters themselves.							

- 1) A call is set up according to the test procedure specified in TS 34.108 [3] subclause 7.3.2.3. The RF parameters for Test 1 are set up according to table 8.7.8.1.1B.4.1.1.

## 8.7.8.1.1B.4.2 Procedure

- 1) SS shall transmit the MEASUREMENT CONTROL message.
- 2) UE shall transmit periodically MEASUREMENT REPORT messages.
- 3) SS shall check "SFN-SFN observed time difference type 1" value in MEASUREMENT REPORT message. The reported value shall be compared to the actually set SFN-SFN observed time difference type 1 value for each MEASUREMENT REPORT message.
- 4) SS shall count the number of MEASUREMENT REPORT messages transmitted by UE. After 1000 MEASUREMENT REPORT messages have been received from UE, the RF parameters are set up according to table 8.7.8.1.1B.4.1.1 for Test 2. While RF parameters are being set up, MEASUREMENT REPORT messages from UE are ignored. SS shall wait for additional 1s and ignore the MEASUREMENT REPORT messages during this period. Then, steps 2) and 3) above are repeated. After further 1000 MEASUREMENT REPORT messages have been received from UE, the RF parameters are set up according to table 8.7.8.1.1B.4.1.1 for Test 3. While RF parameters are being set up, MEASUREMENT REPORT messages from UE are ignored. SS shall wait for additional 1s and ignore the MEASUREMENT REPORT messages during this period. Then, steps 2) and 3) above are repeated.
- 5) After further 1000 MEASUREMENT REPORT messages have been received from UE, the SS shall transmit RRC CONNECTION RELEASE message.
- 6) UE shall transmit RRC CONNECTION RELEASE COMPLETE message.

## Specific Message Contents

All messages indicated above shall use the same content as described in the default message content in clause 9 of 34.108 [3] and in Annex I, with the following exceptions:

## MEASUREMENT CONTROL message (Step 1):

Information Element/Group name	Value/Remark
Message Type (10.2.17)	
UE information elements	
-RRC transaction identifier	0
-Integrity check info	Not Present
Measurement Information elements	
-Measurement Identity	1
-Measurement Command (10.3.7.46)	Modify
-Measurement Reporting Mode (10.3.7.49)	AM RLC
-Measurement Report Transfer Mode	Periodical reporting
-Periodical Reporting / Event Trigger Reporting Mode	Not Present
-Additional measurements list (10.3.7.1)	
-CHOICE <i>Measurement type</i>	Intra-frequency measurement
-Intra-frequency measurement (10.3.7.36)	
-Intra-frequency measurement objects list (10.3.7.33)	Not Present
-Intra-frequency measurement quantity (10.3.7.38)	
-Filter coefficient (10.3.7.9)	0
-CHOICE <i>mode</i>	TDD
-Measurement quantity list	1
-Measurement quantity	Primary CCPCH RSCP
-Intra-frequency reporting quantity (10.3.7.41)	
-Reporting quantities for active set cells (10.3.7.5)	
-SFN-SFN observed time difference reporting indicator	Type 1
-Cell synchronisation information reporting indicator	FALSE
-Cell Identity reporting indicator	FALSE
-CHOICE <i>mode</i>	TDD
-Timeslot ISCP reporting indicator	FALSE
-Primary CCPCH RSCP reporting indicator	TRUE
-Pathloss reporting indicator	TRUE
-Reporting quantities for monitored set cells (10.3.7.5)	
-SFN-SFN observed time difference reporting indicator	Type 1
-Cell synchronisation information reporting indicator	FALSE
-Cell Identity reporting indicator	FALSE
-CHOICE <i>mode</i>	TDD
-Timeslot ISCP reporting indicator	FALSE
-Proposed TGSN reporting required	FALSE
-Primary CCPCH RSCP reporting indicator	TRUE
-Pathloss reporting indicator	TRUE
-Reporting quantities for detected set cells (10.3.7.5)	Not Present
-Reporting cell status (10.3.7.61)	
-CHOICE <i>reported cell</i>	Report all active set cells + cells within monitored set on used frequency
-Maximum number of reported cells	Virtual/active set cells + 2
-Measurement validity (10.3.7.51)	Not Present
-CHOICE <i>report criteria</i> (10.3.7.	
-Periodical reporting criteria (10.3.7.53)	
-Amount of reporting	Infinity
-Reporting interval	250 ms
Physical channel information elements	
-DPCH compressed mode status info (10.3.6.34)	Not Present

## 8.7.8.1.1B.5 Test requirements

The SFN-SFN observed time difference type 1 accuracy shall meet the requirements in clause 8.7.8.1.1B.2.

NOTE: If the above Test Requirement differs from the Minimum Requirement then the Test Tolerance applied for this test is non-zero. The Test Tolerance for this test is defined in clause F.2 and the explanation of how the Minimum Requirement has been relaxed by the Test Tolerance is given in clause F.4.

### 8.7.8.2 SFN-SFN observed time difference type 2

Void

### 8.7.9 Observed time difference to GSM cell

Void

### 8.7.10 UE GPS Timing of Cell Frames for UP

Void

### 8.7.11 SFN-CFN observed time difference

#### 8.7.11.1 Intra frequency measurement requirement for 3,84 Mcps option

##### 8.7.11.1.1 Definition and applicability

The intra frequency SFN-CFN observed time difference is defined as the SFN-CFN observed time difference from the active cell to a neighbour cell that is in the same frequency. This measurement is specified in clause 5.1.11 of TS 25.225 [22]. The reference point for the SFN-CFN observed time difference shall be the antenna connector of the UE.

The requirements and this test apply to all types of UTRA TDD UE.

##### 8.7.11.1.2 Minimum requirements

The accuracy requirement in table 8.7.11.1.1 is valid under the following conditions:

$P\text{-CCPCH\_RSCP}_{1,2} \geq -102 \text{ dBm}$ .

$$\left| P\text{-CCPCH\_RSCP1}_{in \text{ dBm}} - P\text{-CCPCH\_RSCP2}_{in \text{ dBm}} \right| \leq 20 \text{ dB}$$

$$\left( \frac{P\text{-CCPCH\_}E_c}{I_o} \right)_{in \text{ dB}} \geq -8 \text{ dB}$$

$$\left( \frac{SCH\_}E_c}{I_o} \right)_{in \text{ dB}} \geq -13 \text{ dB}$$

where the received P-CCPCH  $E_c/I_o$  is defined as,

$$\left( \frac{P\text{-CCPCH\_}E_c}{I_o} \right)_{in \text{ dB}} = \left( \frac{P\text{-CCPCH\_}E_c}{I_{or}} \right)_{in \text{ dB}} - \left( \frac{I_o}{\hat{I}_{or}} \right)_{in \text{ dB}}$$

and the received SCH  $E_c/I_o$  is defined as,

$$\left( \frac{SCH\_}E_c}{I_o} \right)_{in \text{ dB}} = \left( \frac{SCH\_}E_c}{I_{or}} \right)_{in \text{ dB}} - \left( \frac{I_o}{\hat{I}_{or}} \right)_{in \text{ dB}}$$

and  $SCH\_E_c/I_{or}$  is equally divided between primary synchronisation code and the sum of all secondary synchronisation codes, where the secondary synchronisation codes are also equally divided.

**Table 8.7.11.1.1: SFN-CFN observed time difference accuracy for an intra frequency UTRA TDD neighbour cell**

Parameter	Unit	Accuracy [chip]	Conditions
			Io [dBm/3,84 MHz]
SFN-CFN observed time difference	chip	+/-0,5	-94...-50

The normative reference for this requirement is TS 25.123 [2] clause 9.1.1.11 and A.9.1.10.

### 8.7.11.1.3 Test Purpose

The purpose of this test is to verify that the measurement accuracy of SFN-CFN observed time difference is within the limit specified in clause 8.7.11.1.2.

### 8.7.11.1.4 Method of test

#### 8.7.11.1.4.1 Initial conditions

Test environment: normal; see clauses G.2.1 and G.2.2.

Frequencies to be tested: mid range; see clause G.2.4.

In this case all cells are on the same frequency. Cell 1 and cell 2 shall be synchronised, i.e. share the same frame and timeslot timing. The DL DPCH shall be transmitted in timeslot 4 and the UL DPCH shall be transmitted in timeslot 12. The second Beacon timeslot shall be provided in timeslot 8 for cell 1 and in timeslot 10 for cell 2. During the test, the timing difference between cell 1 and cell 2 can be set to any value from 0...255 frames. The SFN-CFN observed time difference accuracy requirements in the intra-frequency case are tested by using test parameters in Table 8.7.11.1.2.

**Table 8.7.11.1.2: SFN-CFN observed time difference intra frequency test parameters**

Parameter	Unit	Test 1		Test 2		Test 3	
		Cell 1	Cell 2	Cell 1	Cell 2	Cell 1	Cell 2
DL timeslot number		0	2	0	2	0	2
UTRA RF Channel number		Channel 1		Channel 1		Channel 1	
PCCPCH_Ec/Ior	dB	-3		-3		-3	
SCH_Ec/Ior	dB	-9		-9		-9	
SCH <sub>t</sub> offset		0	5	0	5	0	5
OCNS_Ec/Ior	dB	-3,12		-3,12		-3,12	
Ioc	dBm / 3,84 MHz	-75.2	-75.2	-57.8	-54.7	-98.7	-98.7
Ior/Ioc	dB	5	5	7	3	3	3
Io, Note 1	dBm / 3,84 MHz	-69		-50		-94	
Propagation condition		AWGN		AWGN		AWGN	
NOTE 1: Io levels have been calculated from other parameters for information purposes. They are not settable parameters themselves.							

- 1) A call is set up according to the test procedure specified in TS 34.108 [3] subclause 7.3.2.3. The RF parameters for Test 1 are set up according to table 8.7.11.1.2.

#### 8.7.11.1.4.2 Procedure

- 1) SS shall transmit the MEASUREMENT CONTROL message.
- 2) UE shall transmit periodically MEASUREMENT REPORT messages.
- 3) SS shall check "OFF" and "Tm" values in MEASUREMENT REPORT message and calculate SFN-CFN observed time difference value according to the definition in clause 5.1.11 of TS 25.225 [22]. This value shall be compared to the actually set SFN-CFN observed time difference value for each MEASUREMENT REPORT message.
- 4) SS shall count the number of MEASUREMENT REPORT messages transmitted by UE. After 1000 MEASUREMENT REPORT messages have been received from UE, the RF parameters are set up according to

table 8.7.11.1.2 for Test 2. While RF parameters are being set up, MEASUREMENT REPORT messages from UE are ignored. SS shall wait for additional 1s and ignore the MEASUREMENT REPORT messages during this period. Then, steps 2) and 3) above are repeated. After further 1000 MEASUREMENT REPORT messages have been received from UE, the RF parameters are set up according to table 8.7.11.1.2 for Test 3. While RF parameters are being set up, MEASUREMENT REPORT messages from UE are ignored. SS shall wait for additional 1s and ignore the MEASUREMENT REPORT messages during this period. Then, steps 2) and 3) above are repeated.

- 5) After further 1000 MEASUREMENT REPORT messages have been received from UE, the SS shall transmit RRC CONNECTION RELEASE message.
- 6) UE shall transmit RRC CONNECTION RELEASE COMPLETE message.

#### Specific Message Contents

All messages indicated above shall use the same content as described in the default message content in clause 9 of 34.108 [3] and in Annex I, with the following exceptions:

MEASUREMENT CONTROL message (Step 1):

Information Element/Group name	Value/Remark
Message Type (10.2.17)	
UE information elements	
-RRC transaction identifier	0
-Integrity check info	Not Present
Measurement Information elements	
-Measurement Identity	1
-Measurement Command (10.3.7.46)	Modify
-Measurement Reporting Mode (10.3.7.49)	AM RLC
-Periodical Reporting / Event Trigger Reporting Mode	Periodical reporting
-Additional measurements list (10.3.7.1)	Not Present
-CHOICE <i>Measurement type</i>	Intra-frequency measurement
-Intra-frequency measurement (10.3.7.36)	
-Intra-frequency measurement objects list (10.3.7.33)	Not Present
-Intra-frequency measurement quantity (10.3.7.38)	
-Filter coefficient (10.3.7.9)	0
-CHOICE <i>mode</i>	TDD
-Measurement quantity list	1
-Measurement quantity	Primary CCPCH RSCP
-Intra-frequency reporting quantity (10.3.7.41)	
-Reporting quantities for active set cells (10.3.7.5)	No report
-SFN-SFN observed time difference reporting indicator	TRUE
-Cell synchronisation information reporting indicator	TRUE
-Cell Identity reporting indicator	TRUE
-CHOICE <i>mode</i>	TDD
-Timeslot ISCP reporting indicator	FALSE
-Primary CCPCH RSCP reporting indicator	TRUE
-Pathloss reporting indicator	TRUE
-Reporting quantities for monitored set cells (10.3.7.5)	No report
-SFN-SFN observed time difference reporting indicator	TRUE
-Cell synchronisation information reporting indicator	TRUE
-Cell Identity reporting indicator	TRUE
-CHOICE <i>mode</i>	TDD
-Timeslot ISCP reporting indicator	FALSE
-Proposed TGSN reporting required	FALSE
-Primary CCPCH RSCP reporting indicator	TRUE
-Pathloss reporting indicator	TRUE
-Reporting quantities for detected set cells (10.3.7.5)	Not Present
-Reporting cell status (10.3.7.61)	
-CHOICE <i>reported cell</i>	Report all active set cells + cells within monitored set on used frequency
-Maximum number of reported cells	Virtual/active set cells + 2
-Measurement validity (10.3.7.51)	Not Present
-CHOICE <i>report criteria</i> (10.3.7.	
-Periodical reporting criteria (10.3.7.53)	
-Amount of reporting	Infinity
-Reporting interval	250 ms
Physical channel information elements	
-DPCH compressed mode status info (10.3.6.34)	Not Present

#### 8.7.11.1.5 Test requirements

The SFN-CFN observed time difference accuracy shall meet the requirements in clause 8.7.11.1.2.

NOTE: If the above Test Requirement differs from the Minimum Requirement then the Test Tolerance applied for this test is non-zero. The Test Tolerance for this test is defined in clause F.2 and the explanation of how the Minimum Requirement has been relaxed by the Test Tolerance is given in clause F.4.

#### 8.7.11.1A Intra frequency measurement requirement for 1,28 Mcps option

Void



## 8.7.11.1B Intra frequency measurement requirement for 7,68 Mcps option

### 8.7.11.1B.1 Definition and applicability

The intra frequency SFN-CFN observed time difference is defined as the SFN-CFN observed time difference from the active cell to a neighbour cell that is in the same frequency. This measurement is specified in clause 5.1.11 of TS 25.225 [22]. The reference point for the SFN-CFN observed time difference shall be the antenna connector of the UE.

The requirements and this test apply to all types of UTRA TDD UE.

### 8.7.11.1B.2 Minimum requirements

The accuracy requirement in table 8.7.11.1B.2.1 is valid under the following conditions:

$P\text{-CCPCH\_RSCP}_{1,2} \geq -102 \text{ dBm}$ .

$$\left| P\text{-CCPCH\_RSCP}_1 \Big|_{in \text{ dBm}} - P\text{-CCPCH\_RSCP}_2 \Big|_{in \text{ dBm}} \right| \leq 20 \text{ dB}$$

$$\left( \frac{P\text{-CCPCH} - E_c}{I_o} \right) \Big|_{in \text{ dB}} \geq -11 \text{ dB}$$

$$\left( \frac{SCH - E_c}{I_o} \right) \Big|_{in \text{ dB}} \geq -13 \text{ dB}$$

where the received P-CCPCH  $E_c/I_o$  is defined as,

$$\left( \frac{P\text{-CCPCH} - E_c}{I_o} \right) \Big|_{in \text{ dB}} = \left( \frac{P\text{-CCPCH} - E_c}{I_{or}} \right) \Big|_{in \text{ dB}} - \left( \frac{I_o}{\hat{I}_{or}} \right) \Big|_{in \text{ dB}}$$

and the received SCH  $E_c/I_o$  is defined as,

$$\left( \frac{SCH - E_c}{I_o} \right) \Big|_{in \text{ dB}} = \left( \frac{SCH - E_c}{I_{or}} \right) \Big|_{in \text{ dB}} - \left( \frac{I_o}{\hat{I}_{or}} \right) \Big|_{in \text{ dB}}$$

and  $SCH\_E_c/I_{or}$  is equally divided between primary synchronisation code and the sum of all secondary synchronisation codes, where the secondary synchronisation codes are also equally divided.

**Table 8.7.11.1B.2.1: SFN-CFN observed time difference accuracy for an intra frequency UTRA TDD neighbour cell**

Parameter	Unit	Accuracy [chip]	Conditions
			$I_o$ [dBm/7.68 MHz]
SFN-CFN observed time difference	chip	+/-1	-94...-50

The normative reference for this requirement is TS 25.123 [2] clause 9.1.1.11.1 and A.9.3.10.

### 8.7.11.1B.3 Test Purpose

The purpose of this test is to verify that the measurement accuracy of SFN-CFN observed time difference is within the limit specified in clause 8.7.11.1B.2.

### 8.7.11.1B.4 Method of test

#### 8.7.11.1B.4.1 Initial conditions

Test environment: normal; see clauses G.2.1 and G.2.2.

Frequencies to be tested: mid range; see clause G.2.4.

In this case all cells are on the same frequency. Cell 1 and cell 2 shall be synchronised, i.e. share the same frame and timeslot timing. The DL DPCH shall be transmitted in timeslot 4 and the UL DPCH shall be transmitted in timeslot 12. The second Beacon timeslot shall be provided in timeslot 8 for cell 1 and in timeslot 10 for cell 2. During the test, the timing difference between cell 1 and cell 2 can be set to any value from 0...255 frames. The SFN-CFN observed time difference accuracy requirements in the intra-frequency case are tested by using test parameters in Table 8.7.11.1B.4.1.1.

**Table 8.7.11.1B.4.1.1: SFN-CFN observed time difference intra frequency test parameters**

Parameter	Unit	Test 1		Test 2		Test 3	
		Cell 1	Cell 2	Cell 1	Cell 2	Cell 1	Cell 2
DL timeslot number		0	2	0	2	0	2
UTRA RF Channel number		Channel 1		Channel 1		Channel 1	
PCCPCH_Ec/lor	dB	-3		-3		-3	
SCH_Ec/lor	dB	-9		-9		-9	
SCH_t <sub>offset</sub>		0	5	0	5	0	5
OCNS_Ec/lor	dB	-3,12		-3,12		-3,12	
loc	dBm / 7.68 MHz	-75.2	-75.2	-57.8	-54.7	-98.7	-98.7
lor/loc	dB	5	5	7	3	3	3
lo, Note 1	dBm / 7.68 MHz	-69		-50		-94	
Propagation condition		AWGN		AWGN		AWGN	
NOTE 1: lo levels have been calculated from other parameters for information purposes. They are not settable parameters themselves.							

- 1) A call is set up according to the test procedure specified in TS 34.108 [3] subclause 7.3.2.3. The RF parameters for Test 1 are set up according to table 8.7.11.1B.4.1.1.

#### 8.7.11.1B.4.2 Procedure

- 1) SS shall transmit the MEASUREMENT CONTROL message.
- 2) UE shall transmit periodically MEASUREMENT REPORT messages.
- 3) SS shall check "OFF" and "Tm" values in MEASUREMENT REPORT message and calculate SFN-CFN observed time difference value according to the definition in clause 5.1.11 of TS 25.225 [22]. This value shall be compared to the actually set SFN-CFN observed time difference value for each MEASUREMENT REPORT message.
- 4) SS shall count the number of MEASUREMENT REPORT messages transmitted by UE. After 1000 MEASUREMENT REPORT messages have been received from UE, the RF parameters are set up according to table 8.7.11.1B.4.1.1 for Test 2. While RF parameters are being set up, MEASUREMENT REPORT messages from UE are ignored. SS shall wait for additional 1s and ignore the MEASUREMENT REPORT messages during this period. Then, steps 2) and 3) above are repeated. After further 1000 MEASUREMENT REPORT messages have been received from UE, the RF parameters are set up according to table 8.7.11.1B.4.1.1 for Test 3. While RF parameters are being set up, MEASUREMENT REPORT messages from UE are ignored. SS shall wait for additional 1s and ignore the MEASUREMENT REPORT messages during this period. Then, steps 2) and 3) above are repeated.
- 5) After further 1000 MEASUREMENT REPORT messages have been received from UE, the SS shall transmit RRC CONNECTION RELEASE message.
- 6) UE shall transmit RRC CONNECTION RELEASE COMPLETE message.

#### Specific Message Contents

All messages indicated above shall use the same content as described in the default message content in clause 9 of 34.108 [3] and in Annex I, with the following exceptions:

MEASUREMENT CONTROL message (Step 1):

Information Element/Group name	Value/Remark
Message Type (10.2.17)	
UE information elements	
-RRC transaction identifier	0
-Integrity check info	Not Present
Measurement Information elements	
-Measurement Identity	1
-Measurement Command (10.3.7.46)	Modify
-Measurement Reporting Mode (10.3.7.49)	
-Measurement Report Transfer Mode	AM RLC
-Periodical Reporting / Event Trigger Reporting Mode	Periodical reporting
-Additional measurements list (10.3.7.1)	Not Present
-CHOICE <i>Measurement type</i>	Intra-frequency measurement
-Intra-frequency measurement (10.3.7.36)	
-Intra-frequency measurement objects list (10.3.7.33)	Not Present
-Intra-frequency measurement quantity (10.3.7.38)	
-Filter coefficient (10.3.7.9)	0
-CHOICE <i>mode</i>	TDD
-Measurement quantity list	1
-Measurement quantity	Primary CCPCH RSCP
-Intra-frequency reporting quantity (10.3.7.41)	
-Reporting quantities for active set cells (10.3.7.5)	
-SFN-SFN observed time difference reporting indicator	No report
-Cell synchronisation information reporting indicator	TRUE
-Cell Identity reporting indicator	TRUE
-CHOICE <i>mode</i>	TDD
-Timeslot ISCP reporting indicator	FALSE
-Primary CCPCH RSCP reporting indicator	TRUE
-Pathloss reporting indicator	TRUE
-Reporting quantities for monitored set cells (10.3.7.5)	
-SFN-SFN observed time difference reporting indicator	No report
-Cell synchronisation information reporting indicator	TRUE
-Cell Identity reporting indicator	TRUE
-CHOICE <i>mode</i>	TDD
-Timeslot ISCP reporting indicator	FALSE
-Proposed TGSN reporting required	FALSE
-Primary CCPCH RSCP reporting indicator	TRUE
-Pathloss reporting indicator	TRUE
-Reporting quantities for detected set cells (10.3.7.5)	Not Present
-Reporting cell status (10.3.7.61)	
-CHOICE <i>reported cell</i>	Report all active set cells + cells within monitored set on used frequency
-Maximum number of reported cells	Virtual/active set cells + 2
-Measurement validity (10.3.7.51)	Not Present
-CHOICE <i>report criteria</i> (10.3.7.	
-Periodical reporting criteria (10.3.7.53)	
-Amount of reporting	Infinity
-Reporting interval	250 ms
Physical channel information elements	
-DPCH compressed mode status info (10.3.6.34)	Not Present

### 8.7.11.1B.5 Test requirements

The SFN-CFN observed time difference accuracy shall meet the requirements in clause 8.7.11.1B.2.

NOTE: If the above Test Requirement differs from the Minimum Requirement then the Test Tolerance applied for this test is non-zero. The Test Tolerance for this test is defined in clause F.2 and the explanation of how the Minimum Requirement has been relaxed by the Test Tolerance is given in clause F.4.

## 8.7.11.2 Inter frequency measurement requirement for 3,84 Mcps option

### 8.7.11.2.1 Definition and applicability

The inter frequency SFN-CFN observed time difference is defined as the SFN-CFN time difference from the active cell to a UTRA TDD neighbour cell that is in a different frequency. This measurement is specified in clause 5.1.11 of TS 25.225 [22]. The reference point for the SFN-CFN observed time difference shall be the antenna connector of the UE.

The requirements and this test apply to all types of UTRA TDD UE.

### 8.7.11.2.2 Minimum requirements

The accuracy requirement in table 8.7.11.2.1 is valid under the following conditions:

$P\text{-CCPCH\_RSCP}_{1,2} \geq -102 \text{ dBm}$ .

$$\left| P\text{-CCPCH\_RSCP}_1 \Big|_{in \text{ dBm}} - P\text{-CCPCH\_RSCP}_2 \Big|_{in \text{ dBm}} \right| \leq 20 \text{ dB}$$

$$\left( \frac{P\text{-CCPCH\_}E_c}{I_o} \right) \Big|_{in \text{ dB}} \geq -8 \text{ dB}$$

$$\left( \frac{SCH\_}E_c}{I_o} \right) \Big|_{in \text{ dB}} \geq -13 \text{ dB}$$

where the received P-CCPCH  $E_c/I_o$  is defined as,

$$\left( \frac{P\text{-CCPCH\_}E_c}{I_o} \right) \Big|_{in \text{ dB}} = \left( \frac{P\text{-CCPCH\_}E_c}{I_{or}} \right) \Big|_{in \text{ dB}} - \left( \frac{I_o}{\hat{I}_{or}} \right) \Big|_{in \text{ dB}}$$

and the received SCH  $E_c/I_o$  is defined as,

$$\left( \frac{SCH\_}E_c}{I_o} \right) \Big|_{in \text{ dB}} = \left( \frac{SCH\_}E_c}{I_{or}} \right) \Big|_{in \text{ dB}} - \left( \frac{I_o}{\hat{I}_{or}} \right) \Big|_{in \text{ dB}}$$

and  $SCH\_E_c/I_{or}$  is equally divided between primary synchronisation code and the sum of all secondary synchronisation codes, where the secondary synchronisation codes are also equally divided.

**Table 8.7.11.2.1: SFN-CFN observed time difference accuracy for an inter frequency UTRA TDD neighbour cell**

Parameter	Unit	Accuracy [chip]	Conditions
			$I_o$ [dBm/3,84 MHz]
SFN-CFN observed time difference	chip	+/-0,5	-94...-50

The normative reference for this requirement is TS 25.123 [2] clause 9.1.1.11 and A.9.1.10.

### 8.7.11.2.3 Test purpose

The purpose of this test is to verify that the measurement accuracy of SFN-CFN observed time difference is within the limit specified in clause 8.7.11.2.2.

### 8.7.11.2.4 Method of test

#### 8.7.11.2.4.1 Initial conditions

Test environment: normal; see clauses G.2.1 and G.2.2.

Frequencies to be tested: mid range; see clause G.2.4.

In this case, UTRA TDD cell 1 and UTRA TDD cell 2 are on different frequencies. Cell 1 and cell 2 shall be synchronised, i.e. share the same frame and timeslot timing. The DL DPCH shall be transmitted in timeslot 4 and the UL DPCH shall be transmitted in timeslot 12. The second Beacon timeslot shall be provided in timeslot 8 for cell 1 and in timeslot 10 for cell 2. During the test, the timing difference between cell 1 and cell 2 can be set to any value from 0...256 frames. The SFN-CFN observed time difference accuracy requirements in the intra-frequency case are tested by using test parameters in Table 8.7.11.2.2.

**Table 8.7.11.2.2: SFN-CFN observed time difference inter frequency test parameters**

Parameter	Unit	Test 1		Test 2		Test 3	
		Cell 1	Cell 2	Cell 1	Cell 2	Cell 1	Cell 2
DL timeslot number		0	2	0	2	0	2
UTRA RF Channel number		Channel 1	Channel 2	Channel 1	Channel 2	Channel 1	Channel 2
PCCPCH_Ec/Ior	dB	-3		-3		-3	
SCH_Ec/Ior	dB	-9		-9		-9	
SCH_t_offset		0	5	0	5	0	5
OCNS_Ec/Ior	dB	-3,12		-3,12		-3,12	
Io	dBm / 3,84 MHz	-75.2	-75.2	-57.8	-54.7	-98.7	-98.7
Ior/Ioc	dB	5	5	7	3	3	3
Io, Note 1	dBm / 3,84 MHz	-69		-50		-94	
Propagation condition		AWGN		AWGN		AWGN	
NOTE 1: Io levels have been calculated from other parameters for information purposes. They are not settable parameters themselves.							

- 1) A call is set up according to the test procedure specified in TS 34.108 [3] subclause 7.3.2.3. The RF parameters for Test 1 are set up according to table 8.7.11.2.2.

#### 8.7.11.2.4.2 Procedure

- 1) SS shall transmit the MEASUREMENT CONTROL message.
- 2) UE shall transmit periodically MEASUREMENT REPORT messages.
- 3) SS shall check "OFF" and "Tm" values in MEASUREMENT REPORT message and calculate SFN-CFN observed time difference value according to the definition in clause 5.1.11 of TS 25.225 [22]. This value shall be compared to the actually set SFN-CFN observed time difference value for each MEASUREMENT REPORT message.
- 4) SS shall count the number of MEASUREMENT REPORT messages transmitted by UE. After 1000 MEASUREMENT REPORT messages have been received from UE, the RF parameters are set up according to table 8.7.11.2.2 for Test 2. While RF parameters are being set up, MEASUREMENT REPORT messages from UE are ignored. SS shall wait for additional 1s and ignore the MEASUREMENT REPORT messages during this period. Then, steps 2) and 3) above are repeated. After further 1000 MEASUREMENT REPORT messages have been received from UE, the RF parameters are set up according to table 8.7.11.2.2 for Test 3. While RF parameters are being set up, MEASUREMENT REPORT messages from UE are ignored. SS shall wait for additional 1s and ignore the MEASUREMENT REPORT messages during this period. Then, steps 2) and 3) above are repeated.
- 5) After further 1000 MEASUREMENT REPORT messages have been received from UE, the SS shall transmit RRC CONNECTION RELEASE message.
- 6) UE shall transmit RRC CONNECTION RELEASE COMPLETE message.

#### Specific Message Contents

All messages indicated above shall use the same content as described in the default message content in clause 9 of 34.108 [3] and in Annex I, with the following exceptions:

MEASUREMENT CONTROL message for inter frequency measurements (Step 1):

Information Element/Group name	Value/Remark
Message Type (10.2.17)	
<b>UE information elements</b>	
-RRC transaction identifier	0
-Integrity check info	Not Present
<b>Measurement Information elements</b>	
-Measurement Identity	2
-Measurement Command (10.3.7.46)	Setup
-Measurement Reporting Mode (10.3.7.49)	
-Measurement Report Transfer Mode	AM RLC
-Periodical Reporting / Event Trigger Reporting Mode	Periodical reporting
-Additional measurements list (10.3.7.1)	Not Present
-CHOICE <i>Measurement type</i>	Inter-frequency measurement
-Inter-frequency measurement (10.3.7.16)	
-Inter-frequency measurement objects list (10.3.7.13)	
-CHOICE <i>inter-frequency cell removal</i>	Not present
-New inter-frequency cells	Cell 2 information is included
-Cell for measurement	Not Present
-Inter-frequency measurement quantity (10.3.7.18)	
-CHOICE <i>reporting criteria</i>	Inter-frequency reporting criteria
-Filter coefficient (10.3.7.9)	0
-CHOICE <i>mode</i>	TDD
-Measurement quantity for frequency quality estimate	Primary CCPCH RSCP
-Inter-frequency reporting quantity (10.3.7.21)	
-UTRA carrier RSSI	FALSE
-Frequency quality estimate	TRUE
-Non frequency related cell reporting quantities (10.3.7.5)	
-SFN-SFN observed time difference reporting indicator	No report
-Cell synchronisation information reporting indicator	TRUE
-Cell identity reporting indicator	TRUE
-CHOICE <i>mode</i>	TDD
-Timeslot ISCP reporting indicator	FALSE
-Proposed TGSN Reporting required	FALSE
-Primary CCPCH RSCP reporting indicator	TRUE
-Pathloss reporting indicator	FALSE
-Reporting cell status (10.3.7.61)	
-CHOICE <i>reported cell</i>	Report all active set cells + cells within monitored set on used frequency
-Maximum number of reported cells	Virtual/active set cells + 2
-Measurement validity (10.3.7.51)	Not present
-Inter-frequency set update	Not present
-CHOICE <i>report criteria</i> (10.3.7.	
-Periodical reporting criteria (10.3.7.53)	
-Amount of reporting	Infinity
-Reporting interval	500 ms
<b>Physical channel information elements</b>	
-DPCH compressed mode status info (10.3.6.34)	Not Present

### 8.7.11.2.5 Test requirements

The SFN-CFN observed time difference accuracy shall meet the requirements in clause 8.7.11.2.2.

NOTE: If the above Test Requirement differs from the Minimum Requirement then the Test Tolerance applied for this test is non-zero. The Test Tolerance for this test is defined in clause F.2 and the explanation of how the Minimum Requirement has been relaxed by the Test Tolerance is given in clause F.4.

### 8.7.11.2A Inter frequency measurement requirement for 1,28 Mcps option

Void

## 8.7.11.2B Inter frequency measurement requirement for 7,68 Mcps option

### 8.7.11.2B.1 Definition and applicability

The inter frequency SFN-CFN observed time difference is defined as the SFN-CFN time difference from the active cell to a UTRA TDD neighbour cell that is in a different frequency. This measurement is specified in clause 5.1.11 of TS 25.225 [22]. The reference point for the SFN-CFN observed time difference shall be the antenna connector of the UE.

The requirements and this test apply to 7.68Mcps TDD UE.

### 8.7.11.2B.2 Minimum requirements

The accuracy requirement in table 8.7.11.2B.2.1 is valid under the following conditions:

$P\text{-CCPCH\_RSCP}_{1,2} \geq -102 \text{ dBm}$ .

$$\left| P\text{-CCPCH RSCP1} \Big|_{in \text{ dBm}} - P\text{-CCPCH RSCP2} \Big|_{in \text{ dBm}} \right| \leq 20 \text{ dB}$$

$$\left( \frac{P\text{-CCPCH} - E_c}{I_o} \right) \Big|_{in \text{ dB}} \geq -11 \text{ dB}$$

$$\left( \frac{SCH - E_c}{I_o} \right) \Big|_{in \text{ dB}} \geq -13 \text{ dB}$$

where the received P-CCPCH  $E_c/I_o$  is defined as,

$$\left( \frac{P\text{-CCPCH} - E_c}{I_o} \right) \Big|_{in \text{ dB}} = \left( \frac{P\text{-CCPCH} - E_c}{I_{or}} \right) \Big|_{in \text{ dB}} - \left( \frac{I_o}{\hat{I}_{or}} \right) \Big|_{in \text{ dB}}$$

and the received SCH  $E_c/I_o$  is defined as,

$$\left( \frac{SCH - E_c}{I_o} \right) \Big|_{in \text{ dB}} = \left( \frac{SCH - E_c}{I_{or}} \right) \Big|_{in \text{ dB}} - \left( \frac{I_o}{\hat{I}_{or}} \right) \Big|_{in \text{ dB}}$$

and  $SCH\_E_c/I_{or}$  is equally divided between primary synchronisation code and the sum of all secondary synchronisation codes, where the secondary synchronisation codes are also equally divided.

**Table 8.7.11.2B.2.1: SFN-CFN observed time difference accuracy for an inter frequency UTRA TDD neighbour cell**

Parameter	Unit	Accuracy [chip]	Conditions
			$I_o$ [dBm/7.68 MHz]
SFN-CFN observed time difference	chip	+/-1	-94...-50

The normative reference for this requirement is TS 25.123 [2] clause 9.1.1.11.1 and A.9.3.10.

### 8.7.11.2B.3 Test purpose

The purpose of this test is to verify that the measurement accuracy of SFN-CFN observed time difference is within the limit specified in clause 8.7.11.2B.2.

### 8.7.11.2B.4 Method of test

#### 8.7.11.2B.4.1 Initial conditions

Test environment: normal; see clauses G.2.1 and G.2.2.

Frequencies to be tested: mid range; see clause G.2.4.

In this case, UTRA TDD cell 1 and UTRA TDD cell 2 are on different frequencies. Cell 1 and cell 2 shall be synchronised, i.e. share the same frame and timeslot timing. The DL DPCH shall be transmitted in timeslot 4 and the UL DPCH shall be transmitted in timeslot 12. The second Beacon timeslot shall be provided in timeslot 8 for cell 1 and in timeslot 10 for cell 2. During the test, the timing difference between cell 1 and cell 2 can be set to any value from 0...256 frames. The SFN-CFN observed time difference accuracy requirements in the intra-frequency case are tested by using test parameters in Table 8.7.11.2B.4.1.1.

**Table 8.7.11.2B.4.1.1: SFN-CFN observed time difference inter frequency test parameters**

Parameter	Unit	Test 1		Test 2		Test 3	
		Cell 1	Cell 2	Cell 1	Cell 2	Cell 1	Cell 2
DL timeslot number		0	2	0	2	0	2
UTRA RF Channel number		Channel 1	Channel 2	Channel 1	Channel 2	Channel 1	Channel 2
PCCPCH_Ec/Ior	dB	-3		-3		-3	
SCH_Ec/Ior	dB	-9		-9		-9	
SCH_t_offset		0	5	0	5	0	5
OCNS_Ec/Ior	dB	-3,12		-3,12		-3,12	
loc	dBm / 7.68 MHz	-75.2	-75.2	-57.8	-54.7	-98.7	-98.7
Ior/loc	dB	5	5	7	3	3	3
Io, Note 1	dBm / 7.68 MHz	-69		-50		-94	
Propagation condition		AWGN		AWGN		AWGN	
NOTE 1: Io levels have been calculated from other parameters for information purposes. They are not settable parameters themselves.							

- 1) A call is set up according to the test procedure specified in TS 34.108 [3] subclause 7.3.2.3. The RF parameters for Test 1 are set up according to table 8.7.11.2B.4.1.1.

#### 8.7.11.2.4B.2 Procedure

- 1) SS shall transmit the MEASUREMENT CONTROL message.
- 2) UE shall transmit periodically MEASUREMENT REPORT messages.
- 3) SS shall check "OFF" and "Tm" values in MEASUREMENT REPORT message and calculate SFN-CFN observed time difference value according to the definition in clause 5.1.11 of TS 25.225 [22]. This value shall be compared to the actually set SFN-CFN observed time difference value for each MEASUREMENT REPORT message.
- 4) SS shall count the number of MEASUREMENT REPORT messages transmitted by UE. After 1000 MEASUREMENT REPORT messages have been received from UE, the RF parameters are set up according to table 8.7.11.2B.4.1.1 for Test 2. While RF parameters are being set up, MEASUREMENT REPORT messages from UE are ignored. SS shall wait for additional 1s and ignore the MEASUREMENT REPORT messages during this period. Then, steps 2) and 3) above are repeated. After further 1000 MEASUREMENT REPORT messages have been received from UE, the RF parameters are set up according to table 8.7.11.2B.4.1.1 for Test 3. While RF parameters are being set up, MEASUREMENT REPORT messages from UE are ignored. SS shall wait for additional 1s and ignore the MEASUREMENT REPORT messages during this period. Then, steps 2) and 3) above are repeated.
- 5) After further 1000 MEASUREMENT REPORT messages have been received from UE, the SS shall transmit RRC CONNECTION RELEASE message.
- 6) UE shall transmit RRC CONNECTION RELEASE COMPLETE message.

#### Specific Message Contents

All messages indicated above shall use the same content as described in the default message content in clause 9 of 34.108 [3] and in Annex I, with the following exceptions:



MEASUREMENT CONTROL message for inter frequency measurements (Step 1):

Information Element/Group name	Value/Remark
Message Type (10.2.17)	
<b>UE information elements</b>	
-RRC transaction identifier	0
-Integrity check info	Not Present
<b>Measurement Information elements</b>	
-Measurement Identity	2
-Measurement Command (10.3.7.46)	Setup
-Measurement Reporting Mode (10.3.7.49)	AM RLC
-Periodical Reporting / Event Trigger Reporting Mode	Periodical reporting
-Additional measurements list (10.3.7.1)	Not Present
-CHOICE <i>Measurement type</i>	Inter-frequency measurement
-Inter-frequency measurement (10.3.7.16)	
-Inter-frequency measurement objects list (10.3.7.13)	
-CHOICE <i>inter-frequency cell removal</i>	Not present
-New inter-frequency cells	Cell 2 information is included
-Cell for measurement	Not Present
-Inter-frequency measurement quantity (10.3.7.18)	
-CHOICE <i>reporting criteria</i>	Inter-frequency reporting criteria
-Filter coefficient (10.3.7.9)	0
-CHOICE <i>mode</i>	TDD
-Measurement quantity for frequency quality estimate	Primary CCPCH RSCP
-Inter-frequency reporting quantity (10.3.7.21)	
-UTRA carrier RSSI	FALSE
-Frequency quality estimate	TRUE
-Non frequency related cell reporting quantities (10.3.7.5)	
-SFN-SFN observed time difference reporting indicator	No report
-Cell synchronisation information reporting indicator	TRUE
-Cell identity reporting indicator	TRUE
-CHOICE <i>mode</i>	TDD
-Timeslot ISCP reporting indicator	FALSE
-Proposed TGSN Reporting required	FALSE
-Primary CCPCH RSCP reporting indicator	TRUE
-Pathloss reporting indicator	FALSE
-Reporting cell status (10.3.7.61)	
-CHOICE reported cell	Report all active set cells + cells within monitored set on used frequency
-Maximum number of reported cells	Virtual/active set cells + 2
-Measurement validity (10.3.7.51)	Not present
-Inter-frequency set update	Not present
-CHOICE <i>report criteria</i> (10.3.7.	
-Periodical reporting criteria (10.3.7.53)	
-Amount of reporting	Infinity
-Reporting interval	500 ms
<b>Physical channel information elements</b>	
-DPCH compressed mode status info (10.3.6.34)	Not Present

### 8.7.11.2B.5 Test requirements

The SFN-CFN observed time difference accuracy shall meet the requirements in clause 8.7.11.2B.2.

NOTE: If the above Test Requirement differs from the Minimum Requirement then the Test Tolerance applied for this test is non-zero. The Test Tolerance for this test is defined in clause F.2 and the explanation of how the Minimum Requirement has been relaxed by the Test Tolerance is given in clause F.4.

## 8.7.12 UE transmitted power

### 8.7.12.1 UE transmitted power for 3.84 Mcps TDD Option

Void

## 8.7.12.1A UE transmitted power for 1.28 Mcps TDD Option

### 8.7.12.1A.1 Definition and applicability

The UE transmitted power absolute accuracy is defined as difference between the UE reported value and the UE transmitted power measured by test system. The reference point for the UE transmitted power shall be the antenna connector of the UE.

The requirements and this test apply to all types of 1.28 Mcps TDD UE.

### 8.7.12.1A.2 Minimum requirements

The measurement period in CELL\_DCH state and CELL\_FACH state is 1 slot.

**Table 8.7.12.1A.2.1 UE transmitted power absolute accuracy**

Parameter	Unit	Accuracy [dB]	
		PUEMAX 24dBm	PUEMAX 21dBm
UE transmitted power $\geq$ PUEMAX	dBm	+1/-3	$\pm 2$
PUEMAX > UE transmitted power $\geq$ PUEMAX-1	dBm	+1,5/-3,5	$\pm 2,5$
PUEMAX-1 > UE transmitted power $\geq$ PUEMAX-2	dBm	+2/-4	$\pm 3$
PUEMAX-2 > UE transmitted power $\geq$ PUEMAX-3	dBm	+2,5/-4,5	$\pm 3,5$
PUEMAX-3 > UE transmitted power $\geq$ PUEMAX-10	dBm	+3/-5	$\pm 4$

NOTE 1: User equipment maximum output power, PUEMAX, is the maximum output power level without tolerance defined for the power class of the UE in 3GPP TS 25.102 "UTRA (UE) TDD; Radio Transmission and Reception".

NOTE 2: UE transmitted power is the reported value.

The normative reference for this requirement is TS 25.123 clause 9.1.2.1.

### 8.7.12.1A.3 Test purpose

The purpose of this test is to verify that for any reported value of UE Transmitted Power in the range PUEMAX to PUEMAX-10 that the actual UE mean power lies within the range specified in clause 8.7.12.1A.2.

### 8.7.12.1A.4 Method of test

#### 8.7.12.1A.4.1 Initial conditions

Test environment: normal, TL/VL, TL/VH, TH/VL, TH/VH; see clauses G.2.1 and G.2.2.

Frequencies to be tested: mid range; see clause G.2.4.

- 1) Connect SS to the UE antenna connector as shown in figure A.1.

The test parameters are given in Table 8.7.12.1A.4.1 and 8.7.12.1A.4.2 below. In the measurement control information it shall be indicated to the UE that periodic reporting of the UE transmitted power measurement shall be used.

**Table 8.7.12.1A.4.1: General test parameters for UE transmitted power**

Parameter	Unit	Value	Comment
DCH parameters		DL Reference Measurement Channel 12.2 kbps	As specified in clause C.3.1.2
DL-Power Control		Off	

**Table 8.7.12.1A.4.2: Cell Specific parameters for UE transmitted power**

Parameter	Unit	Cell 1	
Timeslot Number		0	DwPTS
UTRA RF Channel Number (NOTE 2)		Channel 1	
PCCPCH_Ec/Ior	dB	-3	
DwPCH_Ec/Ior	dB		0
OCNS_Ec/Ior	dB	-3	
$\hat{I}_{or}/I_{oc}$	dB	3	
$I_{oc}$	dBm/1.28 MHz	-70	
PCCPCH_RSCP (NOTE 1)	dBm	-70	
Propagation Condition		AWGN	
NOTE 1: PCCPCH RSCP level has been calculated from other parameters for information purposes. They are not settable parameters themselves.			
NOTE2: In the case of multi-frequency network, the UTRA RF Channel Number can be set for the primary frequency in this test.			

**8.7.12.1A.4.2 Procedure**

- 1) A call is set up according to the test procedure specified in TS 34.108 [3] subclause 7.3.2. The RF parameters are set up according to table 8.7.12.1A.4.1 and 8.7.12.1A.4.2. Set the UE power and Maximum allowed UL TX power to the maximum power for the UE power class.
- 2) SS shall send continuously during the entire test Up power control commands to the UE.
- 3) SS shall transmit the MEASUREMENT CONTROL message as defined in the specific message contents below.
- 4) Decode the UE Transmitted power reported by the UE in the next available MEASUREMENT REPORT message.
- 5) Measure the mean power of the UE over a period of one timeslot.
- 6) Steps 4 and 5 shall be repeated until statistical significance according to Annex F.6.2.8 is achieved.
- 7) Decrease the Maximum allowed UL TX power by 1 dB. The SS shall transmit the PHYSICAL CHANNEL RECONFIGURATION message, as defined in the specific message contents below.
- 8) SS shall wait for the PHYSICAL CHANNEL RECONFIGURATION COMPLETE message from the UE.
- 9) Repeat from step 4) until the Maximum allowed UL TX Power reaches PUEMAX-10.

**Specific Message Contents**

All messages indicated above shall use the same content as described in default message content in clause 9 of 34.108 [3], with the following exceptions:

MEASUREMENT CONTROL message:

Information Element	Value/Remark
Message Type	
UE information elements -RRC transaction identifier -Integrity check info -message authentication code  -RRC message sequence number	0  SS calculates the value of MAC-I for this message and writes to this IE. The first/leftmost bit of the bit string contains the most significant bit of the MAC-I. SS provides the value of this IE, from its internal counter.
Measurement Information elements -Measurement Identity -Measurement Command -CHOICE Measurement type -UE Internal measurement quantity -Measurement quantity -Filter coefficient -UE Internal reporting quantity -UE Transmitted power -CHOICE mode -CHOICE TDD option -1.28Mcps TDD -T <sub>adv</sub> info -CHOICE report criteria -Amount of reporting -Reporting interval -Measurement Reporting Mode -Measurement Report Transfer Mode -Periodical Reporting / Event Trigger Reporting Mode -AdditionalMeasurementList	5 SETUP UE Internal measurement  UE Transmitted power 0  TRUE TDD  False Periodical reporting criteria Infinity 250  AM RLC Periodical reporting Not Present

MEASUREMENT REPORT message:

Information Element	Value/remark
Message Type	
Integrity check info	The presence of this IE is dependent on PIXIT statements in TS 34.123-2. If integrity protection is indicated to be active, this IE shall be present with the values of the sub IEs as stated below. Else, this IE and the sub-IEs shall be absent.
- Message authentication code	This IE is checked to see if it is present. The value is compared against the XMAC-I value computed by SS.
- RRC Message sequence number	This IE is checked to see if it is present. The value is used by SS to compute the XMAC-I value.
Measurement identity	5
Measured Results	UE Internal measured results
- CHOICE Measurement	TDD
- Choice mode	Checked that this IE is present
- UE Transmitted power list	Checked that this IE is present
-UE Transmitted power	
- CHOICE TDD option	
-1.28Mcps TDD	
-T <sub>adv</sub>	Checked that this IE is absent
Measured results on RACH	Checked that this IE is absent
Additional measured results	Checked that this IE is absent
Event results	Checked that this IE is absent

PHYSICAL CHANNEL RECONFIGURATION message:

Information Element	Value/Remark	Version
Message Type		
UE Information Elements		
-RRC transaction identifier	0	
-Integrity check info		
-message authentication code	SS calculates the value of MAC-I for this message and writes to this IE. The first/leftmost bit of the bit string contains the most significant bit of the MAC-I.	
-RRC message sequence number	SS provides the value of this IE, from its internal counter.	
-Integrity protection mode info	Not Present	
-Ciphering mode info	Not Present	
-Activation time	Not Present	
-New U-RNTI	Not Present	
-New C-RNTI	Not Present	
-RRC State Indicator	CELL_DCH	
-UTRAN DRX cycle length coefficient	Not Present	
CN Information Elements		
-CN Information info	Not Present	
UTRAN mobility information elements		
-URA identity	Not Present	
RB information elements		
-Downlink counter synchronisation info	Not Present	
PhyCH information elements		
-Frequency info	Not Present	
Uplink radio resources		
-Maximum allowed UL TX power	At the first time this value is set to PUEMAX-1. After the second time this value is decreased with 1 dB from previous value.	

#### 8.7.12.1A.5 Test requirements

Compare each of the UE transmitted power reports against the following mean power measurement. At least 90% of the mean power measurements for any one value of reported UE transmitted power shall be within the range specified in table 8.7.12.1A.5.

Table 8.7.12.1A.5 UE transmitted power test requirements

UE reported value	SS measured mean power (X) range [dBm]	
	PUEMAX 24dBm	PUEMAX 21dBm
UE_TX_POWER_104	$33-3.7 \leq X < 34+1.7$	$33-2.7 \leq X < 34+2.7$
UE_TX_POWER_103	$32-3.7 \leq X < 33+1.7$	$32-2.7 \leq X < 33+2.7$
•	•	•
•	•	•
•	•	•
UE_TX_POWER_097	$26-3.7 \leq X < 27+1.7$	•
UE_TX_POWER_096	$25-3.7 \leq X < 26+1.7$	•
UE_TX_POWER_095	$24-3.7 \leq X < 25+1.7$	•
UE_TX_POWER_094	$23-4.2 \leq X < 24+2.2$	$23-2.7 \leq X < 24+2.7$
UE_TX_POWER_093	$22-4.7 \leq X < 23+2.7$	$22-2.7 \leq X < 23+2.7$
UE_TX_POWER_092	$21-5.2 \leq X < 22+3.2$	$21-2.7 \leq X < 22+2.7$
UE_TX_POWER_091	$20-5.7 \leq X < 21+3.7$	$20-3.2 \leq X < 21+3.2$
UE_TX_POWER_090	$19-5.7 \leq X < 20+3.7$	$19-3.7 \leq X < 20+3.7$
UE_TX_POWER_089	$18-5.7 \leq X < 19+3.7$	$18-4.2 \leq X < 19+4.2$
UE_TX_POWER_088	•	$17-4.7 \leq X < 18+4.7$
UE_TX_POWER_087	•	$16-4.7 \leq X < 17+4.7$
UE_TX_POWER_086	•	$15-4.7 \leq X < 15+4.7$
•	•	•
•	•	•
•	•	•
UE_TX_POWER_022	$-49-5.7 \leq X < -48+3.7$	$-49-4.7 \leq X < -48+4.7$
UE_TX_POWER_021	$-50-5.7 \leq X < -49+3.7$	$-50-4.7 \leq X < -49+4.7$

NOTE 1: Although test requirements are given for all UE reported values, a good UE will likely report values between PUEMAX and PUEMAX - 10 dB. However, even a good UE may report also wider range of values due to errors in TPC command reception and allowed range specified for UE transmit power setting accuracy when Maximum Allowed UL TX Power has been signaled. On the other hand, a faulty UE may report any power value but then it does not fulfill the Table 8.7.12.1A.5 requirements for mean power or then it will not pass some other tests e.g. TC 5.2 of this specification.

NOTE 2: If the above Test Requirement differs from the Minimum Requirement then the Test Tolerance applied for this test is non-zero. The Test Tolerance for this test is defined in clause F.2 and the explanation of how the Minimum Requirement has been relaxed by the Test Tolerance is given in clause F.4.

## 8.7.13 UE Transmission Power Headroom

### 8.7.13.1 UPH for 3.84Mcps TDD Option

Void

### 8.7.13.1A UPH for 1.28Mcps TDD Option

#### 8.7.13.1A.1 Definition and applicability

The accuracy requirements for the UE transmission power headroom depends on the total power transmitted by the UE as defined in the functionality in section 9.2.6.3 of TS 25.321[14], section 9.1.2.3.2 of TS 25.123 [2] and section 5.1.16 of TS 25.225 [22]. The requirements and this test apply to Release 7 and later releases for all types of UTRA for the 1.28Mcps TDD UE that supports E-DCH and HSDPA.

#### 8.7.13.1A.2 Minimum Requirements

The UE transmission power headroom (UPH) is defined in section 5.1.16 of TS 25.225 [22] as the ratio of the maximum UE transmission power and the product of P e-base power and serving cell path loss, and shall be calculated as following:

$$UPH = \frac{P_{\max,tx}}{P_{e-base} \cdot L_{Path\_loss}}$$

Where:

$P_{\max,tx}$  = min {Maximum allowed UL TX Power,  $P_{\max}$ } is the UE maximum transmission power;

Maximum allowed UL TX Power is set by UTRAN and defined in [9];

$P_{\max}$  is the UE nominal maximum output power according to the UE power class and specified in [1] table 6.1;

$P_{e-base}$  is a closed-loop quantity defined in [9] and  $L_{Path\_loss}$  is the serving cell path loss.

The reference point for the UE transmission power headroom shall be the antenna connector of the UE.

The accuracy requirements for UE transmission power headroom depends on the total power transmitted by the UE. Table 8.7.13.1A defines the accuracy of the measured quantity as defined in section 9.1.2.3.2 of TS 25.123 [2].

**Table 8.7.13.1A.1: UPH reporting accuracy**

Total UE output power value (dBm)	UPH reporting Accuracy [dB]*	
	PUEMAX 24dBm	PUEMAX 21dBm
Total output power $\geq$ PUEMAX	+1/-3	$\pm 2$
PUEMAX-1 $\leq$ Total output power < PUEMAX	+1,5/-3,5	$\pm 2,5$
PUEMAX-2 $\leq$ Total output power < PUEMAX-1	+2/-4	$\pm 3$
PUEMAX-3 $\leq$ Total output power < PUEMAX-2	+2,5/-4,5	$\pm 3,5$
PUEMAX-10 $\leq$ Total output power < PUEMAX-3	+3/-5	$\pm 4$
*Note: UPH reporting accuracy is the difference between the UPH reported by the UE and the actual uplink power headroom		
**Note: PUEMAX, is the maximum output power level without tolerance defined for the power class of the UE in 3GPP TS 25.102		

### 8.7.13.1A.3 Test purpose

The purpose of this test case is to verify that the UE transmission power headroom measurement report accuracy is within the specified limits defined in section 9.1.2.3.2 of 25.123 [2] shown in table 8.7.13.1A.1.

### 8.7.13.1A.4 Method of test

#### 8.7.13.1A.4.1 Initial conditions

Test environment: normal, TL/VL, TL/VH, TH/VL, TH/VH; see clauses G.2.1 and G.2.2.

Frequencies to be tested: mid range; see clause G.2.4.

- 1) Connect the SS (node B emulator) to the UE antenna connector as shown in figure A.1.
- 2) HSDPA and E-DCH configurations are set as in table 8.7.13.1A.2.

**Table 8.7.13.1A.2: General test parameters for UE transmission power headroom**

Parameter	Unit	Value	Comment
DL DCH configuration		DL Reference Measurement Channel 12.2 kbps	As specified in Annex C.3.1.2 of the present document
DL configuration		DL Fixed Reference Channel (FRC 1)	As specified in Annex C.4.2.1 of the present document
E-DCH configuration		5 ms TTI E-DCH Transport Block Size Table 0 according to TS 25.321 [13] annex BC.1	
DL Power Control		Off	
Active cell		Cell 1	
Reference E-TFCI index		0 as per Table 0 according to TS 25.321 [13] annex BC.1.	

3) The power levels and cell specific parameters are set as in table 8.7.13.1A.3.

**Table 8.7.13.1A.3: Cell Specific parameters for UE transmission power headroom**

Parameter	Unit	Cell 1	
Timeslot Number		0	DwPTS
UTRA RF Channel Number (NOTE 2)		Channel 1	
PCCPCH_Ec/lor	dB	- 3	
DwPCH_Ec/lor	dB		0
OCNS_Ec/lor	dB	- 3	
$\hat{I}_{or}/I_{oc}$	dB	3	
$I_{oc}$	dBm/ 1.28 MHz	-70	
PCCPCH RSCP, Note 1	dB m	-70	
Propagation Condition		AWGN	
NOTE 1: PCCPCH RSCP level has been calculated from other parameters for information purposes. They are not settable parameters themselves.			
NOTE2: In the case of multi-frequency network, the UTRA RF Channel Number can be set for the primary frequency in this test.			

4) The UE is switched on.

5) An E-DCH call is set up according to TS 34.108 [3] 7.3.9 with the following exceptions in the RADIO BEARER SETUP message. These exceptions are derived from Table 8.7.13.2, and in addition allow the beta values to be set and each UL physical channel to be at constant power during the measurement.



Table 8.7.13.1A.4: Contents of RADIO BEARER SETUP message: AM or UM (E-DCH and HSDPA)

Information Element/Group name	Value/Remark
E-PUCH Info(TDD only)	
>E-TFCS information	
>>Reference Beta Information QPSK list	
>>>Reference Code Rate	0.2
>>>Reference Beta	-14
>>Reference Beta Information QPSK list	
>>>Reference Code Rate	0.3
>>>Reference Beta	-13
>>Reference Beta Information QPSK list	
>>>Reference Code Rate	0.4
>>>Reference Beta	-12
>>Reference Beta Information QPSK list	
>>>Reference Code Rate	0.5
>>>Reference Beta	-10
>>Reference Beta Information QPSK list	
>>>Reference Code Rate	0.6
>>>Reference Beta	-9
>>Reference Beta Information QPSK list	
>>>Reference Code Rate	0.7
>>>Reference Beta	-8
>>Reference Beta Information QPSK list	
>>>Reference Code Rate	0.8
>>>Reference Beta	-7
>>Reference Beta Information QPSK list	
>>>Reference Code Rate	0.9
>>>Reference Beta	-6
>>Reference Beta Information 16QAM list	
>>>Reference Code Rate	0.2
>>>Reference Beta	-9
>>Reference Beta Information 16QAM list	
>>>Reference Code Rate	0.3
>>>Reference Beta	-8
>>Reference Beta Information 16QAM list	
>>>Reference Code Rate	0.4
>>>Reference Beta	-6
>>Reference Beta Information 16QAM list	
>>>Reference Code Rate	0.5
>>>Reference Beta	-5
>>Reference Beta Information 16QAM list	
>>>Reference Code Rate	0.6
>>>Reference Beta	-4
>>Reference Beta Information 16QAM list	
>>>Reference Code Rate	0.7
>>>Reference Beta	-2
>>Reference Beta Information 16QAM list	
>>>Reference Code Rate	0.8
>>>Reference Beta	-1
>>Reference Beta Information 16QAM	

list	
>>>Reference Code Rate	0.9
>>>Reference Beta	0
>CHOICE TDD mode	
>>1.28 Mcps TDD	
>>>PRXdes_base	-85
>>>Beacon PL Est.	
>>>TPC step size	1
>>>E-PUCH TS configuration list	
>>>>TS number	1
>>>E-PUCH TS configuration list	
>>>>TS number	2
>>>Minimum allowed code rate	3(0.1)
>>>Maximum allowed code rate	50(0.8)

#### 8.7.13.1A.4.2 Test procedure

- 1) The Scheduling Information configuration for the E-DCH indicates to the UE that it shall periodically report Scheduling Information, which contains UPH measurement every E-DCH TTI. During the test the system simulator shall not send any scheduling grant to the UE, and therefore the UE will not send any payload data on the E-DCH.
- 2) The SS shall set the CPRI value in E-AGCH to be 3 dB for a power class 3 UE, or 0 dB for a power class 4 UE by using uplink power control. CRRI and TRRI value in E-AGCH respectively is "00100" and "11000".
- 3) The SS measures both the power transmitted by the UE on E-PUCH and the total output power of the UE in time slot which assigned E-PUCH transmitted by SS. The SS shall analyse the E-TFCI transmitted on the E-UCCH for each E-DCH TTI and estimates the  $\beta_e$ . The SS averages both the E-PUCH output power  $\square \beta_e$  and total output power of the UE over 100 times. Then, the SS calculates the difference between average E-PUCH power measured and  $\beta_e$ .
- 4) The SS estimates the UE transmission power headroom as the difference between the maximum allowed uplink transmits power (P max) and the difference calculated in step 3.
- 5) The SS notes the UE transmission power headroom value reported in the Scheduling Information.
- 6) The SS calculates the difference between the UE transmission power headroom value estimated in step 4 and the reported UE transmission power headroom noted in step 5. The SS notes this as the UE transmission power headroom accuracy, and compares it to the applicable limit according to the total output power measured in step 3.
- 7) If the UE transmission power headroom accuracy exceeds the value in Table 8.7.13.1A.5 count a bad result, otherwise a good result with respect to the actually set TX power.
- 8) Repeat steps 3 to 7 in order to collect more good or bad results for the currently set power level. Continue the repetition, until statistical significance according to Annex F.6.2.8 is achieved.
- 9) The SS sends 5 up TPC commands at the nesting E-AGCH to bring the TX power of the UE up by a nominal 1 dB step, and then alternate UP/DOWN to maintain constant TX power.
- 10) Repeat steps 3 through 9 and note the UE transmission power headroom accuracy for each UE total power value until the UE stops reporting UPH or does not give lower UPH values for 8 consecutive repetitions of steps 3 through 9.

#### 8.7.13.1A.5 Test requirements

The UE transmission power headroom measurement report accuracy recorded in steps 6, 9 and 10 above shall meet the requirements in table 8.7.13.1A.5. The rate of correct measurements observed during repeated tests shall be at least 90%. To pass the test, the UE transmission power headroom accuracy for each power level in the reporting range must pass. Once a power level is passed, no more results need be collected on this power level.

**Table 8.7.13.1A.5: Test requirement for UPH reporting accuracy**

Total UE output power value (dBm)	UPH reporting Accuracy [dB]*	
	PUEMAX 24dBm	PUEMAX 21dBm
Total output power $\geq$ PUEMAX	+1.7/-3.7	$\pm$ 2.7
PUEMAX-1 $\leq$ Total output power < PUEMAX	+2.2/-4.2	$\pm$ 3.2
PUEMAX-2 $\leq$ Total output power < PUEMAX-1	+2.7/-4.7	$\pm$ 3.7
PUEMAX-3 $\leq$ Total output power < PUEMAX-2	+3.2/-5.2	$\pm$ 4.2
PUEMAX-10 $\leq$ Total output power < PUEMAX-3	+3.7/-5.7	$\pm$ 4.7
*Note: UPH reporting accuracy is the difference between the UPH reported by the UE and the actual uplink power headroom **Note: PUEMAX, is the maximum output power level without tolerance defined for the power class of the UE in 3GPP TS 25.102		

NOTE1: If the above Test Requirement differs from the Minimum Requirement then the Test Tolerance applied for this test is non-zero. The Test Tolerance for this test is defined in clause F.2 and the explanation of how the Minimum Requirement has been relaxed by the Test Tolerance is given in clause F.4.

### 8.7.13.1B UPH for 7.68Mcps TDD Option

Void

## 8.7.14 E-UTRAN FDD RSRP

### 8.7.14.1 Definition and applicability

The absolute accuracy of RSRP is defined as the RSRP measured from a cell that has different carrier frequency from the serving cell.

The E-UTRAN FDD RSRP absolute accuracy measurement is used for handover between UTRAN TDD and E-UTRAN FDD for Rel.9 and later.

The requirements and this test apply to the combined UTRAN TDD and E-UTRAN FDD UE.

### 8.7.14.2 Minimum Requirements

In Cell DCH state, whether or not UE requires idle intervals to perform E-UTRAN measurements, the requirements for accuracy of E-UTRA RSRP measurements in CELL\_DCH state shall be the same as the inter-frequency RSRP Accuracy Requirements in 3GPP TS 36.133, as follows:

Cell specific reference signals are transmitted either from one, two or four antenna ports.

Conditions defined in 36.101 Section 7.3 for reference sensitivity are fulfilled.

RSRP[dBm]  $\geq$  -127 dBm for Bands 1, 4, 6, 10, 18, 19, 33, 34, 35, 36, 37, 38, 39, 40,

RSRP[dBm]  $\geq$  -126 dBm for Bands 9,

RSRP[dBm]  $\geq$  -125 dBm for Bands 2, 5, 7, 11, 17,

RSRP[dBm]  $\geq$  -124 dBm for Bands 3, 8, 12, 13, 14

Table 8.7.14.2-1: RSRP Inter frequency absolute accuracy

Parameter	Unit	Accuracy [dB]		Conditions <sup>1</sup>			
		Normal condition	Extreme condition	Bands 1, 4, 6, 10, 18, 19, 33, 34, 35, 36, 37, 38, 39, 40	Bands 2, 5, 7, 11, 17	Bands 3, 8, 12, 13, 14	Band 9
				$l_o$	$l_o$	$l_o$	$l_o$
RSRP for $\hat{E}_s/l_o \geq -6$ dB	dBm	$\pm 6$	$\pm 9$	- 121dBm/15kHz ... -70dBm/ $BW_{Channel}$	- 119dBm/15kHz ... -70dBm/ $BW_{Channel}$	- 118dBm/15kHz ... -70dBm/ $BW_{Channel}$	- 120dBm/15kHz ... -70dBm/ $BW_{Channel}$
RSRP for $\hat{E}_s/l_o \geq -6$ dB	dBm	$\pm 8$	$\pm 11$	-70dBm/ $BW_{Channel}$ ... - 50dBm/ $BW_{Channel}$	-70dBm/ $BW_{Channel}$ ... - 50dBm/ $BW_{Channel}$	-70dBm/ $BW_{Channel}$ ... - 50dBm/ $BW_{Channel}$	-70dBm/ $BW_{Channel}$ ... - 50dBm/ $BW_{Channel}$

Note 1:  $l_o$  is assumed to have constant EPRE across the bandwidth.

### 8.7.14.3 Test purpose

The purpose of this test is to verify that the E-UTRA FDD RSRP measurement absolute accuracy is within the specified limits. This test will verify the requirements in 8.7.14.2 and applies to UE supporting this capability.

### 8.7.14.4 Method of test

#### 8.7.14.4.1 Initial conditions

Test environment: normal, TL/VL, TL/VH, TH/VL, TH/VH; see clauses G.2.1 and G.2.2.

Frequencies to be tested: mid range; see clause G.2.4. In the test in Cell\_DCH state, "E-UTRAN FDD RSRP Measurement" is applied to measure on E-UTRAN FDD.

Tables 8.7.14.4.1-1 and 8.7.14.4.1-2 define the limits of signal strengths and code powers on the UTRA TDD cell. In the measurement control information periodic reporting of E-UTRAN FDD RSRP is indicated to the UE. The E-UTRAN FDD test parameters are given in Table 8.7.14.4.1-3.

Table 8.7.14.4.1-1: General parameters of E-UTRA FDD RSRP measurement tests

Parameter	Unit	Value	Comment
DCH parameters		DL Reference Measurement Channel 12.2 kbps	As specified in TS 25.102 section A.2.2
Power Control		On	
Target quality value on DTCH	BLER	0.01	
Active cell		Cell 1	1.28Mcps TDD cell
Neighbour cell		Cell 2	E-UTRA FDD cell
CP length of cell 2		normal	
Idle intervals period	ms	80	As specified in TS 25.331
Filter coefficient		0	L3 filtering is not used
Inter-RAT(E-UTRA FDD) measurement quantity		E-UTRA FDD RSRP	

Table 8.7.14.4.1-2: E-UTRA FDD RSRP measurement tests parameters (cell 1)

Parameter	Unit	Test 1, Test 2	
DL timeslot number		0	DwPTS
UTRA RF Channel number (NOTE)		Channel 1	
PCCPCH_Ec/Ior	dB	-3	
DwPCH_Ec/Ior	dB		0
OCNS_Ec/Ior	dB	-3	
$\hat{I}_{or}/I_{oc}$	dB	3	
I <sub>oc</sub>	dBm / 1.28MHz	-75	
Propagation condition		AWGN	
NOTE:	In the case of multi-frequency, the UTRA RF Channel Number can be set for the primary frequency in this test.		

Table 8.7.14.4.1-3: E-UTRA FDD RSRP measurement tests parameters (cell 2)

Parameter	Unit	Test 1	Test 2
E-UTRA RF Channel Number		1	1
BW <sub>channel</sub>	MHz	10	10
Measurement bandwidth	$n_{PRB}$	22—27	22—27
PDCCH/PCFICH/PHICH Reference measurement channel defined in A.3.1.2.1		R.6 FDD	R.6 FDD
OCNG Patterns defined in A.3.2.1.2 (OP.2 FDD)		OP.2 FDD	OP.2 FDD
PBCH_RA	dB	0	0
PBCH_RB			
PSS_RA			
SSS_RA			
PCFICH_RB			
PHICH_RA			
PHICH_RB			
PDCCH_RA			
PDCCH_RB			
PDSCH_RA			
PDSCH_RB			
OCNG_RA <sup>Note1</sup>			
OCNG_RB <sup>Note1</sup>			
$N_{oc}$ <sup>Note2</sup>			
	Bands 2, 5, 7 and 11, 17	-114	
	Bands 3, 8, 12, 13, 14	-113	
	Band 9	-115	
$\hat{E}_s / I_{ot}$	dB	10	-5
RSRP <sup>Note3</sup>	Bands 1, 4, 6, 10, 18 and 19	-78.65	-121
	Bands 2, 5, 7 and 11, 17		-119
	Bands 3, 8, 12, 13, 14		-118
	Band 9		-120
$I_o$ <sup>Note3</sup>	Bands 1, 4, 6, 10, 18 and 19	-49.5	-87.03
	Bands 2, 5, 7 and 11, 17		-85.03
	Bands 3, 8, 12, 13, 14		-84.03
	Band 9		-86.03
$\hat{E}_s / N_{oc}$	dB	10	-5
Propagation condition	-	AWGN	AWGN
<p>Note 1: OCNG shall be used such that both cells are fully allocated and a constant total transmitted power spectral density is achieved for all OFDM symbols.</p> <p>Note 2: Interference from other cells and noise sources not specified in the test is assumed to be constant over subcarriers and time and shall be modelled as AWGN of appropriate power for <math>N_{oc}</math> to be fulfilled.</p> <p>Note 3: RSRP and <math>I_o</math> levels have been derived from other parameters for information purposes. They are not settable parameters themselves.</p> <p>Note 4: RSRP minimum requirements are specified assuming independent interference and noise at each receiver antenna port.</p>			

## 8.7.14.4.2 Test Procedure

- 1) SS shall transmit the MEASUREMENT CONTROL message for inter RAT measurement. In the measurement control information periodic reporting of the EUTRAN FDD RSRP is requested to the UE.

- 2) UE shall transmit periodically MEASUREMENT REPORT messages.
- 3) SS shall check RSRP value of Cell 2 in the MEASUREMENT REPORT messages. Levels of Cell 2 reported by the UE are compared to the actual level of Cell 2 for each MEASUREMENT REPORT message.
- 4) SS shall count number of MEASUREMENT REPORT messages transmitted by UE. After 1000 MEASUREMENT REPORT messages have been received from UE, the EUTRAN FDD cell RF parameters are set up according to table 8.7.14.4.1-3 for Test 2. While RF parameters are being set up, MEASUREMENT REPORT messages from UE are ignored. SS shall wait for additional 1s and ignore the MEASUREMENT REPORT messages during this period. Then, steps 2) and 3) above are repeated.
- 6) After further 1000 MEASUREMENT REPORT messages have been received from UE, the EUTRAN FDD cell RF parameters are set up according to table 8.7.14.4.1-3 for Test 2. While RF parameters are being set up, MEASUREMENT REPORT messages from UE are ignored. SS shall wait for additional 1s and ignore the MEASUREMENT REPORT messages during this period. Then, steps 2) and 3) above are repeated.
- 7) After further 1000 MEASUREMENT REPORT messages have been received from UE, the SS shall transmit RRC CONNECTION RELEASE message.
- 8) UE shall transmit RRC CONNECTION RELEASE COMPLETE message.

### Specific Message Contents

All messages indicated above shall use the same content as described in the default message content in clause 9 of 34.108 [3], with the following exceptions:

NOTE: Numbers in brackets after an item e.g “Message Type (10.2.17)” in the IE description are references to clause numbers in TS 25.331 [9] describing that item in more detail.

MEASUREMENT CONTROL message for EUTRAN FDD measurement (Step 1):

Information Element	Value/Remark
Message Type (10.2.17)	
UE information elements	
-RRC transaction identifier	0
-Integrity check info	Not Present
Measurement Information elements	
-Measurement Identity	2
-Measurement Command	Setup
-Measurement Reporting Mode	
- Measurement Report Transfer Mode	Acknowledged mode RLC
- Periodical Reporting / Event Trigger Reporting Mode	Periodical reporting
-Additional measurement list	Not Present
-CHOICE Measurement Type	Inter-RAT measurement
-Inter-frequency measurement object list	
-CHOICE Inter-frequency cell removal	Not Present
-New inter-frequency cells	Cell 2 information is included
-Cell for measurement	Not Present
-Inter-frequency measurement quantity	
-CHOICE reporting criteria	Inter-frequency reporting criteria
-Filter coefficient	0
-CHOICE mode	EUTRAN FDD
-Measurement quantity	RSRP
-Inter-frequency reporting quantity	
-UTRA Carrier RSSI	
-Frequency quality estimate	FALSE
-Non frequency related cell reporting quantities	FALSE
-SFN-SFN observed time difference reporting indicator	No report
-Cell synchronisation information reporting indicator	
-Maximum number of reported cells	Report all active set cells + cells within monitored set on used frequency
-Measurement validity	Virtual/active set cells + 1
-Inter-frequency set update	Not Present
-CHOICE report criteria	Not Present
-Amount of reporting	Not Present
-Reporting interval	Periodical reporting criteria Infinity 500 ms
Physical channel information elements	
-DPCH compressed mode status info	Not Present

### 8.7.14.5 Test requirements

Table 8.7.14.5-2 and table 8.7.14.5-3 defines the primary level settings including test tolerances for all tests.

Each E-UTRAN FDD RSRP absolute accuracy test shall meet the accuracy test requirements in table 8.7.14.5-1 and the reported values test requirements in table 8.7.14.5-4.



**Table 8.7.14.5-1: E-UTRAN FDD RSRP absolute accuracy**

Parameter	Unit	Accuracy [dB]		Conditions <sup>1</sup>			
		Normal condition	Extreme condition	Bands 1, 4, 6, 10, 18, 19, 33, 34, 35, 36, 37, 38, 39, 40	Bands 2, 5, 7, 11, 17	Bands 3, 8, 12, 13, 14	Band 9
				lo	lo	lo	lo
RSRP for $\hat{E}_s/\text{lot} \geq -6$ dB	dBm	$\pm 6+TT$	$\pm 9+TT$	- 121dBm/15kHz ... -70dBm/ BW <sub>Channel</sub>	- 119dBm/15kHz ... -70dBm/ BW <sub>Channel</sub>	- 118dBm/15kHz ... -70dBm/ BW <sub>Channel</sub>	- 120dBm/15kHz ... -70dBm/ BW <sub>Channel</sub>
RSRP for $\hat{E}_s/\text{lot} \geq -6$ dB	dBm	$\pm 8+TT$	$\pm 11+TT$	-70dBm/ BW <sub>Channel</sub> ... - 50dBm/ BW <sub>Channel</sub>	-70dBm/ BW <sub>Channel</sub> ... - 50dBm/ BW <sub>Channel</sub>	-70dBm/ BW <sub>Channel</sub> ... - 50dBm/ BW <sub>Channel</sub>	-70dBm/ BW <sub>Channel</sub> ... - 50dBm/ BW <sub>Channel</sub>

Note 1. lo is assumed to have constant EPRE across the bandwidth.

**Table 8.7.14.5-2: UTRAN TDD cell specific test parameters for E-UTRAN FDD RSRP absolute accuracy tests**

Parameter	Unit	Test 1, Test 2	
DL timeslot number		0	DwPTS
UTRA RF Channel number (NOTE)		Channel 1	
PCCPCH_Ec/Ior	dB	-3	
DwPCH_Ec/Ior	dB		0
OCNS_Ec/Ior	dB	-3	
$\hat{I}_o/I_{oc}$	dB	3+TT	
I <sub>oc</sub>	dBm / 1.28MHz	-75+TT	
Propagation condition		AWGN	
NOTE: In the case of multi-frequency, the UTRA RF Channel Number can be set for the primary frequency in this test.			

**Table 8.7.14.5-3: E-UTRAN TDD cell specific test parameters for E-UTRAN TDD RSRP absolute accuracy tests**

Parameter		Unit	Test 1	Test 2
E-UTRA RF Channel Number			1	1
$BW_{\text{channel}}$		MHz	10	10
Measurement bandwidth		$n_{PRB}$	22—27	22—27
PDCCH/PCFICH/PHICH Reference measurement channel defined in A.3.1.2.1			R.6 FDD	R.6 FDD
OCNG Patterns defined in A.3.2.1.2 (OP.2 FDD)			OP.2 FDD	OP.2 FDD
PBCH_RA		dB	0	0
PBCH_RB				
PSS_RA				
SSS_RA				
PCFICH_RB				
PHICH_RA				
PHICH_RB				
PDCCH_RA				
PDCCH_RB				
PDSCH_RA				
PDSCH_RB				
OCNG_RA <sup>Note1</sup>				
OCNG_RB <sup>Note1</sup>				
$N_{oc}$ <sup>Note2</sup>	Bands 1, 4, 6, 10, 18 and 19			
	Bands 2, 5, 7 and 11, 17	-114+TT		
	Bands 3, 8, 12, 13, 14	-113+TT		
	Band 9	-115+TT		
$\hat{E}_s / I_{ot}$		dB	10+TT	-5+TT
RSRP <sup>Note3</sup>	Bands 1, 4, 6, 10, 18 and 19	dBm/15 kHz	-78.65+TT	-121+TT
	Bands 2, 5, 7 and 11, 17			-119+TT
	Bands 3, 8, 12, 13, 14			-118+TT
	Band 9			-120+TT
$I_o$ <sup>Note3</sup>	Bands 1, 4, 6, 10, 18 and 19	dBm/9 MHz	-49.5+TT	-87.03+TT
	Bands 2, 5, 7 and 11, 17			-85.03+TT
	Bands 3, 8, 12, 13, 14			-84.03+TT
	Band 9			-86.03+TT
$\hat{E}_s / N_{oc}$		dB	10+TT	-5+TT
Propagation condition		-	AWGN	AWGN
<p>Note 1: OCNG shall be used such that both cells are fully allocated and a constant total transmitted power spectral density is achieved for all OFDM symbols.</p> <p>Note 2: Interference from other cells and noise sources not specified in the test is assumed to be constant over subcarriers and time and shall be modelled as AWGN of appropriate power for <math>N_{oc}</math> to be fulfilled.</p> <p>Note 3: RSRP and <math>I_o</math> levels have been derived from other parameters for information purposes. They are not settable parameters themselves.</p> <p>Note 4: RSRP minimum requirements are specified assuming independent interference and noise at each receiver antenna port.</p>				

**Table 8.7.14.5-4: E-UTRAN FDD RSRP absolute accuracy requirements for the reported values**

	Test 1	Test 2
Normal Conditions		
Lowest reported value (Cell 2)	E-UTRAN FDD RSRP_FFS	E-UTRAN FDD RSRP_FFS
Highest reported value (Cell 2)	E-UTRAN FDD RSRP_FFS	E-UTRAN FDD RSRP_FFS
Extreme Conditions		
Lowest reported value (Cell 2)	E-UTRAN FDD RSRP_FFS	E-UTRAN FDD RSRP_FFS
Highest reported value (Cell 2)	E-UTRAN FDD RSRP_FFS	E-UTRAN FDD RSRP_FFS

NOTE: If the above Test Requirement differs from the Minimum Requirement then the Test Tolerance applied for this test is non-zero. The Test Tolerance for this test is defined in clause F.2 and the explanation of how the Minimum Requirement has been relaxed by the Test Tolerance is given in clause F.4.

## 8.7.15 E-UTRAN TDD RSRP

### 8.7.15.1 Definition and applicability

The absolute accuracy of RSRP is defined as the RSRP measured from a cell that has different carrier frequency from the serving cell.

The E-UTRAN TDD RSRP absolute accuracy measurement is used for handover between UTRAN TDD and E-UTRAN TDD.

The requirements and this test apply to the combined UTRAN TDD and E-UTRAN TDD UE.

### 8.7.15.2 Minimum Requirements

In Cell DCH state, whether or not UE requires idle intervals to perform E-UTRAN measurements, the requirements for accuracy of E-UTRA RSRP measurements in CELL\_DCH state shall be the same as the inter-frequency RSRP Accuracy Requirements in 3GPP TS 36.133, as follows:

Cell specific reference signals are transmitted either from one, two or four antenna ports.

Conditions defined in 36.101 Section 7.3 for reference sensitivity are fulfilled.

RSRP[dBm]  $\geq$  -127 dBm for Bands 1, 4, 6, 10, 18, 19, 33, 34, 35, 36, 37, 38, 39, 40,

RSRP[dBm]  $\geq$  -126 dBm for Bands 9,

RSRP[dBm]  $\geq$  -125 dBm for Bands 2, 5, 7, 11, 17,

RSRP[dBm]  $\geq$  -124 dBm for Bands 3, 8, 12, 13, 14

Table 8.7.15.2-1: RSRP Inter frequency absolute accuracy

Parameter	Unit	Accuracy [dB]		Conditions <sup>1</sup>			
		Normal condition	Extreme condition	Bands 1, 4, 6, 10, 18, 19, 33, 34, 35, 36, 37, 38, 39, 40	Bands 2, 5, 7, 11, 17	Bands 3, 8, 12, 13, 14	Band 9
				lo	lo	lo	lo
RSRP for $\hat{E}_s/\text{lot} \geq -6$ dB	dBm	$\pm 6$	$\pm 9$	- 121dBm/15kHz ... -70dBm/ BW <sub>Channel</sub>	- 119dBm/15kHz ... -70dBm/ BW <sub>Channel</sub>	- 118dBm/15kHz ... -70dBm/ BW <sub>Channel</sub>	- 120dBm/15kHz ... -70dBm/ BW <sub>Channel</sub>
RSRP for $\hat{E}_s/\text{lot} \geq -6$ dB	dBm	$\pm 8$	$\pm 11$	-70dBm/ BW <sub>Channel</sub> ... - 50dBm/ BW <sub>Channel</sub>	-70dBm/ BW <sub>Channel</sub> ... - 50dBm/ BW <sub>Channel</sub>	-70dBm/ BW <sub>Channel</sub> ... - 50dBm/ BW <sub>Channel</sub>	-70dBm/ BW <sub>Channel</sub> ... - 50dBm/ BW <sub>Channel</sub>

Note 1: lo is assumed to have constant EPRE across the bandwidth.

### 8.7.15.3 Test purpose

The purpose of this test is to verify that the E-UTRA TDD RSRP measurement absolute accuracy is within the specified limits. This test will verify the requirements in 8.7.15.2 and applies to UE supporting this capability.

### 8.7.15.4 Method of test

#### 8.7.15.4.1 Initial conditions

Test environment: normal, TL/VL, TL/VH, TH/VL, TH/VH; see clauses G.2.1 and G.2.2.

Frequencies to be tested: mid range; see clause G.2.4. In the test in Cell\_DCH state, "E-UTRAN TDD RSRP Measurement" is applied to measure on E-UTRAN TDD.

Tables 8.7.15.4.1-1 and 8.7.15.4.1-2 define the limits of signal strengths and code powers on the UTRA TDD cell. In the measurement control information periodic reporting of E-UTRAN TDD RSRP is indicated to the UE. The E-UTRAN TDD test parameters are given in Table 8.7.15.4.1-3.

Table 8.7.15.4.1-1: General parameters of E-UTRA TDD RSRP measurement tests

Parameter	Unit	Value	Comment
DCH parameters		DL Reference Measurement Channel 12.2 kbps	As specified in TS 25.102 section A.2.2
Power Control		On	
Target quality value on DTCH	BLER	0.01	
Active cell		Cell 1	1.28Mcps UTRA TDD cell
Neighbour cell		Cell 2	E-UTRA TDD cell
CP length of cell 2		Normal	
Uplink-downlink configuration of cell 2		1	As specified in table 4.2.2 in TS 36.211
Special subframe configuration of cell 2		6	As specified in table 4.2.1 in TS 36.211
Idle intervals period	ms	80	As specified in TS 25.331
Filter coefficient		0	L3 filtering is not used
Inter-RAT(E-UTRA TDD) measurement quantity		E-UTRA TDD RSRP	

Table 8.7.15.4.1-2: E-UTRA TDD RSRP measurement tests parameters (cell 1)

Parameter	Unit	Test 1, Test 2	
		Test 1	Test 2
DL timeslot number		0	DwPTS
UTRA RF Channel number <sup>Note2</sup>		Channel 1	
PCCPCH_Ec/Ior	dB	-3	
DwPCH_Ec/Ior	dB		0
OCNS_Ec/Ior	dB	-3	
Ior	dBm/1.28MHz	-75	
Ior/Ior	dB	3	
PCCPCH RSCP <sup>Note1</sup>	dBm	-75	
Io <sup>Note1</sup>	dBm/1.28MHz	-70.24	
Propagation condition		AWGN	
NOTE 1: PCCPCH RSCP and Io levels have been calculated from other parameters for information purposes. They are not settable parameters themselves.			
NOTE 2: In the case of multi-frequency network of 1.28 Mcps TDD, the UTRA RF Channel Number can be set for the primary frequency in this test.			

Table 8.7.15.4.1-3: E-UTRA TDD RSRP measurement tests parameters (cell 2)

Parameter		Unit	Test 1	Test 2
E-UTRA RF Channel Number			2	2
BWchannel		MHz	10	10
OCNG Patterns defined in A.3.2.2.2 (OP.2 TDD) in [24]			OP.2 TDD	OP.2 TDD
PBCH_RA		dB	0	0
PBCH_RB				
PSS_RA				
SSS_RA				
PCFICH_RB				
PHICH_RA				
PHICH_RB				
PDCCH_RA				
PDCCH_RB				
PDSCH_RA				
PDSCH_RB				
OCNG_RA <sup>Note1</sup>				
OCNG_RB <sup>Note1</sup>				
$N_{oc}$ <sup>Note2</sup>	Bands 33 ~ 40			
$\hat{E}_s / I_{ot}$		dB	10	-5
RSRP <sup>Note3</sup>	Bands 33 ~ 40	dBm/15 kHz	-78.65	-121
Io <sup>Note3</sup>	Bands 33 ~ 40	dBm/9 MHz	-49.5	-87.03
$\hat{E}_s / N_{oc}$		dB	10	-5
Propagation condition		-	AWGN	AWGN
Note 1: OCNG shall be used such that both cells are fully allocated and a constant total transmitted power spectral density is achieved for all OFDM symbols.				
Note 2: Interference from other cells and noise sources not specified in the test is assumed to be constant over subcarriers and time and shall be modelled as AWGN of appropriate power for $N_{oc}$ to be fulfilled.				
Note 3: RSRP and Io levels have been derived from other parameters for information purposes. They are not settable parameters themselves.				
Note 4: RSRP minimum requirements are specified assuming independent interference and noise at each receiver antenna port.				

## 8.7.15.4.2 Test Procedure

- 1) SS shall transmit the MEASUREMENT CONTROL message for inter RAT measurement. In the measurement control information periodic reporting of the EUTRAN TDD RSRP is requested to the UE.
- 2) UE shall transmit periodically MEASUREMENT REPORT messages.

- 3) SS shall check E-UTRAN TDD RSRP value of Cell 2 in MEASUREMENT REPORT messages. E-UTRAN TDD RSRP power of Cell 2 reported by UE is compared to actual E-UTRAN TDD RSRP value of Cell 2 for each MEASUREMENT REPORT message.
- 4) SS shall check MEASUREMENT REPORT messages transmitted by UE until statistical significance according to Annex F.6.2.8 is achieved.
- 5) The RF parameters are set up according to table 8.7.15.4.1-3 for Test 2. While RF parameters are being set up, MEASUREMENT REPORT messages from UE are ignored. SS shall wait for additional [1s] and ignore the MEASUREMENT REPORT messages during this period. Then, step 6) and 7) above are repeated.
- 6) The SS shall transmit RRC CONNECTION RELEASE message.
- 7) UE shall transmit RRC CONNECTION RELEASE COMPLETE message.

### Specific Message Contents

All messages indicated above shall use the same content as described in default message content in clause 9 of 34.108 [3], with the following exceptions:

NOTE: Numbers in brackets after an item e.g “Message Type (10.2.17)” in the IE description are references to clause numbers in TS 25.331 [9] describing that item in more detail.

### MEASUREMENT CONTROL message for EUTRAN TDD measurement (Step 1):

Information Element	Value/Remark
Message Type (10.2.17)	
UE information elements	
-RRC transaction identifier	0
-Integrity check info	Not Present
Measurement Information elements	
-Measurement Identity	2
-Measurement Command	Setup
-Measurement Reporting Mode	
- Measurement Report Transfer Mode	Acknowledged mode RLC
- Periodical Reporting / Event Trigger Reporting Mode	Periodical reporting
-Additional measurement list	Not Present
-CHOICE Measurement Type	Inter-RAT measurement
-Inter-frequency measurement object list	
-CHOICE Inter-frequency cell removal	Not Present
-New inter-frequency cells	Cell 2 information is included
-Cell for measurement	Not Present
-Inter-frequency measurement quantity	
-CHOICE reporting criteria	Inter-frequency reporting criteria
-Filter coefficient	0
-CHOICE mode	EUTRAN TDD
-Measurement quantity	RSRP
-Inter-frequency reporting quantity	
-UTRA Carrier RSSI	
-Frequency quality estimate	FALSE
-Non frequency related cell reporting quantities	FALSE
-SFN-SFN observed time difference reporting indicator	No report
-Cell synchronisation information reporting indicator	
-Maximum number of reported cells	Report all active set cells + cells within monitored set on used frequency
-Measurement validity	Virtual/active set cells + 1
-Inter-frequency set update	Not Present
-CHOICE report criteria	Not Present
-Amount of reporting	Not Present
-Reporting interval	Periodical reporting criteria Infinity 500 ms
Physical channel information elements	
-DPCH compressed mode status info	Not Present

8.7.15.5 Test requirements

Table 8.7.15.5-2 and table 8.7.15.5-3 defines the primary level settings including test tolerances for all tests.

Each E-UTRAN TDD RSRP absolute accuracy test shall meet the accuracy test requirements in table 8.7.15.5-1 and the reported values test requirements in table 8.7.15.5-4.

**Table 8.7.15.5-1: E-UTRAN TDD RSRP absolute accuracy**

Parameter	Unit	Accuracy [dB]		Conditions <sup>1</sup>			
		Normal condition	Extreme condition	Bands 1, 4, 6, 10, 18, 19, 33, 34, 35, 36, 37, 38, 39, 40	Bands 2, 5, 7, 11, 17	Bands 3, 8, 12, 13, 14	Band 9
				Io	Io	Io	Io
RSRP for $\bar{E}_s/lot \geq -6$ dB	dBm	$\pm 6+TT$	$\pm 9+TT$	- 121dBm/15kHz ... -70dBm/ BW <sub>Channel</sub>	- 119dBm/15kHz ... -70dBm/ BW <sub>Channel</sub>	- 118dBm/15kHz ... -70dBm/ BW <sub>Channel</sub>	- 120dBm/15kHz ... -70dBm/ BW <sub>Channel</sub>
RSRP for $\bar{E}_s/lot \geq -6$ dB	dBm	$\pm 8+TT$	$\pm 11+TT$	-70dBm/ BW <sub>Channel</sub> ... - 50dBm/ BW <sub>Channel</sub>	-70dBm/ BW <sub>Channel</sub> ... - 50dBm/ BW <sub>Channel</sub>	-70dBm/ BW <sub>Channel</sub> ... - 50dBm/ BW <sub>Channel</sub>	-70dBm/ BW <sub>Channel</sub> ... - 50dBm/ BW <sub>Channel</sub>

Note 1: Io is assumed to have constant EPRE across the bandwidth.

**Table 8.7.15.5-2: UTRAN TDD cell specific test parameters for E-UTRAN TDD RSRP absolute accuracy tests**

Parameter	Unit	Test 1, Test 2	
DL timeslot number		0	DwPTS
UTRA RF Channel number <sup>Note2</sup>		Channel 1	
PCCPCH_Ec/Ior	dB	-3	
DwPCH_Ec/Ior	dB		0
OCNS_Ec/Ior	dB	-3	
Io	dBm/1.28MHz	-75+TT	
Ior/Ioc	dB	3+TT	
PCCPCH RSCP <sup>Note1</sup>	dBm	-75+TT	
Io <sup>Note 1</sup>	dBm/1.28MHz	-70.24+TT	
Propagation condition		AWGN	
Note 1: PCCPCH RSCP and Io levels have been calculated from other parameters for information purposes. They are not settable parameters themselves. Note 2: In the case of multi-frequency network of 1.28 Mcps TDD, the UTRA RF Channel Number can be set for the primary frequency in this test.			

**Table 8.7.15.5-3: E-UTRAN TDD cell specific test parameters for E-UTRAN TDD RSRP absolute accuracy tests**

Parameter		Unit	Test 1	Test 2
E-UTRA RF Channel Number			2	2
BWchannel		MHz	10	10
OCNG Patterns defined in A.3.2.2.2 (OP.2 TDD) in [24]			OP.2 TDD	OP.2 TDD
PBCH_RA		dB	0	0
PBCH_RB				
PSS_RA				
SSS_RA				
PCFICH_RB				
PHICH_RA				
PHICH_RB				
PDCCH_RA				
PDCCH_RB				
PDSCH_RA				
PDSCH_RB				
OCNG_RA <sup>Note1</sup>				
OCNG_RB <sup>Note1</sup>				
$N_{oc}$ <sup>Note2</sup>	Bands 33 ~ 40			
$\hat{E}_s / I_{ot}$		dB	10+TT	-5+TT
RSRP <sup>Note3</sup>	Bands 33 ~ 40	dBm/15 kHz	-78.65+TT	-121+TT
$I_o$ <sup>Note3</sup>	Bands 33 ~ 40	dBm/9 MHz	-49.5+TT	-87.03+TT
$\hat{E}_s / N_{oc}$		dB	10+TT	-5+TT
Propagation condition		-	AWGN	AWGN
Note 1: OCNG shall be used such that both cells are fully allocated and a constant total transmitted power spectral density is achieved for all OFDM symbols. Note 2: Interference from other cells and noise sources not specified in the test is assumed to be constant over subcarriers and time and shall be modelled as AWGN of appropriate power for $N_{oc}$ to be fulfilled. Note 3: RSRP and $I_o$ levels have been derived from other parameters for information purposes. They are not settable parameters themselves. Note 4: RSRP minimum requirements are specified assuming independent interference and noise at each receiver antenna port.				

**Table 8.7.15.5-4: E-UTRAN TDD RSRP absolute accuracy requirements for the reported values**

	Test 1	Test 2
Normal Conditions		
Lowest reported value (Cell 2)	E-UTRAN TDD RSRP_FFS	E-UTRAN TDD RSRP_FFS
Highest reported value (Cell 2)	E-UTRAN TDD RSRP_FFS	E-UTRAN TDD RSRP_FFS
Extreme Conditions		
Lowest reported value (Cell 2)	E-UTRAN TDD RSRP_FFS	E-UTRAN TDD RSRP_FFS
Highest reported value (Cell 2)	E-UTRAN TDD RSRP_FFS	E-UTRAN TDD RSRP_FFS

NOTE: If the above Test Requirement differs from the Minimum Requirement then the Test Tolerance applied for this test is non-zero. The Test Tolerance for this test is defined in clause F.2 and the explanation of how the Minimum Requirement has been relaxed by the Test Tolerance is given in clause F.4.

## 8.7.16 E-UTRAN FDD RSRQ

### 8.7.16.1 Definition and applicability

The absolute accuracy of RSRQ is defined as the RSRQ measured from a cell that has different carrier frequency from the serving cell.



The E-UTRAN FDD RSRQ absolute accuracy measurement is used for handover between UTRAN TDD and E-UTRAN FDD for Rel.9 and later.

The requirements and this test apply to the combined UTRAN TDD and E-UTRAN FDD UE.

### 8.7.16.2 Minimum Requirements

In Cell DCH state, whether or not UE requires idle intervals to perform E-UTRAN measurements, the requirements for accuracy of E-UTRA RSRQ measurements in CELL\_DCH state shall be the same as the inter-frequency RSRQ Accuracy Requirements in 3GPP TS 36.133, as follows:

Cell specific reference signals are transmitted either from one, two or four antenna ports.

Conditions defined in 36.101 Section 7.3 for reference sensitivity are fulfilled.

RSRP[dBm]  $\geq$  -127 dBm for Bands 1, 4, 6, 10, 18, 19, 33, 34, 35, 36, 37, 38, 39, 40,

RSRP[dBm]  $\geq$  -126 dBm for Bands 9,

RSRP[dBm]  $\geq$  -125 dBm for Bands 2, 5, 7, 11, 17,

RSRP[dBm]  $\geq$  -124 dBm for Bands 3, 8, 12, 13, 14

**Table 8.7.16.2-1: RSRQ Inter frequency absolute accuracy**

Parameter	Unit	Accuracy [dB]		Conditions <sup>1</sup>			
		Normal condition	Extreme condition	Bands 1, 4, 6, 10, 18, 19, 33, 34, 35, 36, 37, 38, 39, 40	Bands 2, 5, 7, 11, 17	Bands 3, 8, 12, 13, 14	Bands 9
				lo	lo	lo	lo
RSRQ when RSRP $\hat{E}_s/\text{lot} > -3$ dB	dBm	$\pm 2.5$	$\pm 4$	- 121dBm/15kHz ... -50dBm/ BW <sub>Channel</sub>	- 119dBm/15kHz ... -50dBm/ BW <sub>Channel</sub>	- 118dBm/15kHz ... -50dBm/ BW <sub>Channel</sub>	- 120dBm/15kHz ... -50dBm/ BW <sub>Channel</sub>
RSRQ when RSRP $\hat{E}_s/\text{lot} \geq -6$ dB	dBm	$\pm 3.5$	$\pm 4$	- 121dBm/15kHz ... -50dBm/ BW <sub>Channel</sub>	- 119dBm/15kHz ... -50dBm/ BW <sub>Channel</sub>	- 118dBm/15kHz ... -50dBm/ BW <sub>Channel</sub>	- 120dBm/15kHz ... -50dBm/ BW <sub>Channel</sub>

### 8.7.16.3 Test purpose

The purpose of this test is to verify that the E-UTRA FDD RSRQ measurement absolute accuracy is within the specified limits. This test will verify the requirements in 8.7.16.2 and applies to UE supporting this capability.

### 8.7.16.4 Method of test

#### 8.7.16.4.1 Initial conditions

Test environment: normal, TL/VL, TL/VH, TH/VL, TH/VH; see clauses G.2.1 and G.2.2.

Frequencies to be tested: mid range; see clause G.2.4. In the test in Cell\_DCH state, "E-UTRAN FDD RSRQ Measurement" is applied to measure on E-UTRAN FDD.

Tables 8.7.16.4.1-1 and 8.7.16.4.1-2 define the limits of signal strengths and code powers on the UTRA TDD cell. In the measurement control information periodic reporting of E-UTRAN FDD RSRQ is indicated to the UE. The E-UTRAN FDD test parameters are given in Table 8.7.16.4.1-3.

**Table 8.7.16.4.1-1: General parameters of E-UTRA FDD RSRQ measurement tests**

Parameter	Unit	Value	Comment
DCH parameters		DL Reference Measurement Channel 12.2 kbps	As specified in TS 25.102 section A.2.2
Power Control		On	
Target quality value on DTCH	BLER	0.01	
Active cell		Cell 1	1.28Mcps TDD cell
Neighbour cell		Cell 2	E-UTRA FDD cell
CP length of cell 2		normal	
Idle intervals period	ms	80	As specified in TS 25.331
Filter coefficient		0	L3 filtering is not used
Inter-RAT(E-UTRA FDD) measurement quantity		E-UTRA FDD RSRQ	

**Table 8.7.16.4.1-2: E-UTRA FDD RSRQ measurement tests parameters (cell 1)**

Parameter	Unit	Cell 1	
DL timeslot number		0	DwPTS
UTRA RF Channel number (NOTE)		Channel 1	
PCCPCH_Ec/Ior	dB	-3	
DwPCH_Ec/Ior	dB		0
OCNS_Ec/Ior	dB	-3	
$\hat{I}$ or/Ioc	dB	3	
Ioc	dBm / 1.28MHz	-75	
Propagation condition		AWGN	
Note:	In the case of multi-frequency, the UTRA RF Channel Number can be set for the primary frequency in this test.		

**Table 8.7.16.4.1-3: E-UTRA FDD RSRQ measurement tests parameters (cell 2)**

Parameter		Unit	Test 1	Test 2	Test 3
E-UTRA RF Channel Number			1	1	1
Bwchannel		MHz	10	10	10
Measurement bandwidth		$n_{PRB}$	22—27	22—27	22—27
PDCCH/PCFICH/PHICH Reference measurement channel defined in A.3.1.2.1			R.6 FDD	R.6 FDD	R.6 FDD
OCNG Patterns defined in A.3.2.1.1 (OP.1 FDD) and A.3.2.1.2 (OP.2 FDD)			OP.2 FDD	OP.2 FDD	OP.2 FDD
PBCH_RA		dB	0	0	0
PBCH_RB					
PSS_RA					
SSS_RA					
PCFICH_RB					
PHICH_RA					
PHICH_RB					
PDCCH_RA					
PDCCH_RB					
PDSCH_RA					
PDSCH_RB					
OCNG_RA <sup>Note1</sup>					
OCNG_RB <sup>Note1</sup>					
$N_{oc}$ <sup>Note2</sup>	Bands 1, 4, 6, 10, 18 and 19				
	Bands 2, 5, 7 and 11, 17	-117			
	Bands 3, 8, 12, 13, 14	-116			
	Band 9	-118			
$\hat{E}_s / I_{ot}$		dB	-1.75	-4.7	-4.5
RSRP <sup>Note3</sup>	Bands 1, 4, 6, 10, 18 and 19	dBm/15 kHz	-81.75	-108.70	-123.50
	Bands 2, 5, 7 and 11, 17				-121.50
	Bands 3, 8, 12, 13, 14				-120.50
	Band 9				-122.50
RSRQ <sup>Note3</sup>	Bands 1, 4, 6, 10, 18 and 19	dB	-14.76	-16.76	-16.61
	Bands 2, 5, 7 and 11, 17				
	Bands 3, 8, 12, 13, 14				
	Band 9				
$I_o$ <sup>Note3</sup>	Bands 1, 4, 6, 10, 18 and 19	dBm/9 MHz	-50	-74.95	-89.90
	Bands 2, 5, 7 and 11, 17				-87.90
	Bands 3, 8, 12, 13, 14				-86.90
	Band 9				-88.90
$\hat{E}_s / N_{oc}$		dB	-1.75	-4.7	-4.5
Propagation condition		-	AWGN	AWGN	AWGN

Note 1: OCNG shall be used such that both cells are fully allocated and a constant total transmitted power spectral density is achieved for all OFDM symbols.

Note 2: Interference from other cells and noise sources not specified in the test is assumed to be constant over subcarriers and time and shall be modelled as AWGN of appropriate power for  $N_{oc}$  to be fulfilled.

Note 3: RSRQ, RSRP and  $I_0$  levels have been derived from other parameters for information purposes. They are not settable parameters themselves.

Note 4: RSRP and RSRQ minimum requirements are specified assuming independent interference and noise at each receiver antenna port.

#### 8.7.16.4.2 Test Procedure

- 1) SS shall transmit the MEASUREMENT CONTROL message for inter RAT measurement. In the measurement control information periodic reporting of the EUTRAN FDD RSRQ is requested to the UE.
- 2) UE shall transmit periodically MEASUREMENT REPORT messages.
- 3) SS shall check RSRQ value of Cell 2 in the MEASUREMENT REPORT messages. Levels of Cell 2 reported by the UE are compared to the actual level of Cell 2 for each MEASUREMENT REPORT message.
- 4) SS shall count number of MEASUREMENT REPORT messages transmitted by UE. After 1000 MEASUREMENT REPORT messages have been received from UE, the EUTRAN FDD cell RF parameters are set up according to table 8.7.16.4.1-3 for Test 2. While RF parameters are being set up, MEASUREMENT REPORT messages from UE are ignored. SS shall wait for additional 1s and ignore the MEASUREMENT REPORT messages during this period. Then, steps 2) and 3) above are repeated.
- 6) After further 1000 MEASUREMENT REPORT messages have been received from UE, the EUTRAN FDD cell RF parameters are set up according to table 8.7.16.4.1-3 for Test 2. While RF parameters are being set up, MEASUREMENT REPORT messages from UE are ignored. SS shall wait for additional 1s and ignore the MEASUREMENT REPORT messages during this period. Then, steps 2) and 3) above are repeated.
- 7) After 1000 MEASUREMENT REPORT messages have been received from UE, the EUTRAN FDD cell RF parameters are set up according to table 8.7.16.4.1-3 for Test 3. While RF parameters are being set up, MEASUREMENT REPORT messages from UE are ignored. SS shall wait for additional 1s and ignore the MEASUREMENT REPORT messages during this period. Then, steps 2) and 3) above are repeated.
- 8) After further 1000 MEASUREMENT REPORT messages have been received from UE, the EUTRAN FDD cell RF parameters are set up according to table 8.7.16.4.1-3 for Test 3. While RF parameters are being set up, MEASUREMENT REPORT messages from UE are ignored. SS shall wait for additional 1s and ignore the MEASUREMENT REPORT messages during this period. Then, steps 2) and 3) above are repeated.
- 9) After further 1000 MEASUREMENT REPORT messages have been received from UE, the SS shall transmit RRC CONNECTION RELEASE message.
- 10) UE shall transmit RRC CONNECTION RELEASE COMPLETE message.

#### Specific Message Contents

All messages indicated above shall use the same content as described in the default message content in clause 9 of 34.108 [3], with the following exceptions:

Note: Numbers in brackets after an item e.g “Message Type (10.2.17)” in the IE description are references to clause numbers in TS 25.331 [9] describing that item in more detail.

MEASUREMENT CONTROL message for EUTRAN FDD measurement (Step 1):

Information Element	Value/Remark
Message Type (10.2.17)	
UE information elements	
-RRC transaction identifier	0
-Integrity check info	Not Present
Measurement Information elements	
-Measurement Identity	2
-Measurement Command	Setup
-Measurement Reporting Mode	
- Measurement Report Transfer Mode	Acknowledged mode RLC
- Periodical Reporting / Event Trigger Reporting Mode	Periodical reporting
-Additional measurement list	Not Present
-CHOICE Measurement Type	Inter-RAT measurement
-Inter-frequency measurement object list	
-CHOICE Inter-frequency cell removal	Not Present
-New inter-frequency cells	Cell 2 information is included
-Cell for measurement	Not Present
-Inter-frequency measurement quantity	
-CHOICE reporting criteria	Inter-frequency reporting criteria
-Filter coefficient	0
-CHOICE mode	EUTRAN FDD
-Measurement quantity	RSRQ
-Inter-frequency reporting quantity	
-UTRA Carrier RSSI	
-Frequency quality estimate	FALSE
-Non frequency related cell reporting quantities	FALSE
-SFN-SFN observed time difference reporting indicator	No report
-Cell synchronisation information reporting indicator	
-Maximum number of reported cells	Report all active set cells + cells within monitored set on used frequency
-Measurement validity	Virtual/active set cells + 1
-Inter-frequency set update	Not Present
-CHOICE report criteria	Not Present
-Amount of reporting	Not Present
-Reporting interval	Periodical reporting criteria Infinity 500 ms
Physical channel information elements	
-DPCH compressed mode status info	Not Present

### 8.7.16.5 Test requirements

Table 8.7.16.5-2 and table 8.7.16.5-3 defines the primary level settings including test tolerances for all tests.

Each E-UTRAN FDD RSRQ absolute accuracy test shall meet the accuracy test requirements in table 8.7.16.5-1 and the reported values test requirements in table 8.7.16.5-4.

**Table 8.7.16.5-1: E-UTRAN FDD RSRQ absolute accuracy**

Parameter	Unit	Accuracy [dB]		Conditions <sup>1</sup>			
		Normal condition	Extreme condition	Bands 1, 4, 6, 10, 18, 19, 33, 34, 35, 36, 37, 38, 39, 40	Bands 2, 5, 7, 11, 17	Bands 3, 8, 12, 13, 14	Bands 9
				lo	lo	lo	lo
RSRQ when RSRP $\hat{E}_s/\text{lot} > -3$ dB	dBm	$\pm 2.5+TT$	$\pm 4+TT$	- 121dBm/15kHz ... -50dBm/ BW <sub>Channel</sub>	- 119dBm/15kHz ... -50dBm/ BW <sub>Channel</sub>	- 118dBm/15kHz ... -50dBm/ BW <sub>Channel</sub>	- 120dBm/15kHz ... -50dBm/ BW <sub>Channel</sub>
RSRQ when RSRP $\hat{E}_s/\text{lot} \geq -6$ dB	dBm	$\pm 3.5+TT$	$\pm 4+TT$	- 121dBm/15kHz ... -50dBm/ BW <sub>Channel</sub>	- 119dBm/15kHz ... -50dBm/ BW <sub>Channel</sub>	- 118dBm/15kHz ... -50dBm/ BW <sub>Channel</sub>	- 120dBm/15kHz ... -50dBm/ BW <sub>Channel</sub>

**Table 8.7.16.5-2: UTRAN TDD cell specific test parameters for E-UTRAN FDD RSRQ absolute accuracy tests**

Parameter	Unit	Cell 1	
DL timeslot number		0	DwPTS
UTRA RF Channel number (NOTE)		Channel 1	
PCCPCH_Ec/lor	dB	-3	
DwPCH_Ec/lor	dB		0
OCNS_Ec/lor	dB	-3	
$\hat{I}_{or}/\text{loc}$	dB	3+TT	
loc	dBm / 1.28MHz	-75+TT	
Propagation condition		AWGN	
NOTE:	In the case of multi-frequency, the UTRA RF Channel Number can be set for the primary frequency in this test.		

**Table 8.7.16.5-3: E-UTRAN TDD cell specific test parameters for E-UTRAN TDD RSRQ absolute accuracy tests**

Parameter		Unit	Test 1	Test 2	Test 3
E-UTRA RF Channel Number			1	1	1
Bwchannel		MHz	10	10	10
Measurement bandwidth		$n_{PRB}$	22—27	22—27	22—27
PDCCH/PCFICH/PHICH Reference measurement channel defined in A.3.1.2.1			R.6 FDD	R.6 FDD	R.6 FDD
OCNG Patterns defined in A.3.2.1.1 (OP.1 FDD) and A.3.2.1.2 (OP.2 FDD)			OP.2 FDD	OP.2 FDD	OP.2 FDD
PBCH_RA		dB	0	0	0
PBCH_RB					
PSS_RA					
SSS_RA					
PCFICH_RB					
PHICH_RA					
PHICH_RB					
PDCCH_RA					
PDCCH_RB					
PDSCH_RA					
PDSCH_RB					
OCNG_RA <sup>Note1</sup>					
OCNG_RB <sup>Note1</sup>					
$N_{oc}$ <sup>Note2</sup>	Bands 1, 4, 6, 10, 18 and 19				
	Bands 2, 5, 7 and 11, 17	-117+TT			
	Bands 3, 8, 12, 13, 14	-116+TT			
	Band 9	-118+TT			
$\hat{E}_s / I_{ot}$		dB	-1.75+TT	-4.7+TT	-4.5+TT
RSRP <sup>Note3</sup>	Bands 1, 4, 6, 10, 18 and 19	dBm/15 kHz	-81.75+TT	-108.70+TT	-123.50+TT
	Bands 2, 5, 7 and 11, 17				-121.50+TT
	Bands 3, 8, 12, 13, 14				-120.50+TT
	Band 9				-122.50+TT
RSRQ <sup>Note3</sup>	Bands 1, 4, 6, 10, 18 and 19	dB	-14.76+TT	-16.76+TT	-16.61+TT
	Bands 2, 5, 7 and 11, 17				
	Bands 3, 8, 12, 13, 14				
	Band 9				
$I_o$ <sup>Note3</sup>	Bands 1, 4, 6, 10, 18 and 19	dBm/9 MHz	-50+TT	-74.95+TT	-89.90+TT
	Bands 2, 5, 7 and 11, 17				-87.90+TT
	Bands 3, 8, 12, 13, 14				-86.90+TT
	Band 9				-88.90+TT
$\hat{E}_s / N_{oc}$		dB	-1.75+TT	-4.7+TT	-4.5+TT
Propagation condition		-	AWGN	AWGN	AWGN

Note 1: OCNG shall be used such that both cells are fully allocated and a constant total transmitted power spectral density is achieved for all OFDM symbols.
Note 2: Interference from other cells and noise sources not specified in the test is assumed to be constant over subcarriers and time and shall be modelled as AWGN of appropriate power for $N_{oc}$ to be fulfilled.
Note 3: RSRQ, RSRP and $I_o$ levels have been derived from other parameters for information purposes. They are not settable parameters themselves.
Note 4: RSRP and RSRQ minimum requirements are specified assuming independent interference and noise at each receiver antenna port.

**Table 8.7.16.5-4: E-UTRAN FDD RSRQ absolute accuracy requirements for the reported values**

	Test 1	Test 2
Normal Conditions		
Lowest reported value (Cell 2)	E-UTRAN FDD RSRQ_FFS	E-UTRAN FDD RSRQ_FFS
Highest reported value (Cell 2)	E-UTRAN FDD RSRQ_FFS	E-UTRAN FDD RSRQ_FFS
Extreme Conditions		
Lowest reported value (Cell 2)	E-UTRAN FDD RSRQ_FFS	E-UTRAN FDD RSRQ_FFS
Highest reported value (Cell 2)	E-UTRAN FDD RSRQ_FFS	E-UTRAN FDD RSRQ_FFS

NOTE: If the above Test Requirement differs from the Minimum Requirement then the Test Tolerance applied for this test is non-zero. The Test Tolerance for this test is defined in clause F.2 and the explanation of how the Minimum Requirement has been relaxed by the Test Tolerance is given in clause F.4.

## 8.7.17 E-UTRAN TDD RSRQ

### 8.7.17.1 Definition and applicability

The absolute accuracy of RSRQ is defined as the RSRQ measured from a cell that has different carrier frequency from the serving cell.

The E-UTRAN TDD RSRQ absolute accuracy measurement is used for handover between UTRAN TDD and E-UTRAN TDD.

The requirements and this test apply to the combined UTRAN TDD and E-UTRAN TDD UE.

### 8.7.17.2 Minimum Requirements

In CELL DCH state, whether or not UE requires idle intervals to perform E-UTRAN measurements, the requirements for accuracy of E-UTRA RSRQ measurements in CELL\_DCH state shall be the same as the inter-frequency RSRQ Accuracy Requirements in 3GPP TS 36.133, as follows:

Cell specific reference signals are transmitted either from one, two or four antenna ports.

Conditions defined in 36.101 Section 7.3 for reference sensitivity are fulfilled.

$RSRP|_{dBm} \geq -127$  dBm for Bands 1, 4, 6, 10, 18, 19, 33, 34, 35, 36, 37, 38, 39, 40,

$RSRP|_{dBm} \geq -126$  dBm for Bands 9,

$RSRP|_{dBm} \geq -125$  dBm for Bands 2, 5, 7, 11, 17,

$RSRP|_{dBm} \geq -124$  dBm for Bands 3, 8, 12, 13, 14.



Table 8.7.17.2-1: RSRQ Inter frequency absolute accuracy

Parameter	Unit	Accuracy [dB]		Conditions <sup>1</sup>			
		Normal condition	Extreme condition	Bands 1, 4, 6, 10, 18, 19, 33, 34, 35, 36, 37, 38, 39, 40	Bands 2, 5, 7, 11, 17	Bands 3, 8, 12, 13, 14	Bands 9
				Io	Io	Io	Io
RSRQ when RSRP $\hat{E}s/lot > -3$ dB	dBm	$\pm 2.5$	$\pm 4$	- 121dBm/15kHz ... -50dBm/ BW <sub>Channel</sub>	- 119dBm/15kHz ... -50dBm/ BW <sub>Channel</sub>	- 118dBm/15kHz ... -50dBm/ BW <sub>Channel</sub>	- 120dBm/15kHz ... -50dBm/ BW <sub>Channel</sub>
RSRQ when RSRP $\hat{E}s/lot \geq -6$ dB	dBm	$\pm 3.5$	$\pm 4$	- 121dBm/15kHz ... -50dBm/ BW <sub>Channel</sub>	- 119dBm/15kHz ... -50dBm/ BW <sub>Channel</sub>	- 118dBm/15kHz ... -50dBm/ BW <sub>Channel</sub>	- 120dBm/15kHz ... -50dBm/ BW <sub>Channel</sub>

Note 1: Io is assumed to have constant EPRE across the bandwidth.

### 8.7.17.3 Test purpose

The purpose of this test is to verify that the E-UTRA TDD RSRQ absolute measurement accuracy is within the specified limits. This test will verify the requirements in section 8.7.17.2 and applies to UE supporting this capability.

### 8.7.17.4 Method of test

#### 8.7.17.4.1 Initial conditions

Test environment: normal, TL/VL, TL/VH, TH/VL, TH/VH; see clauses G.2.1 and G.2.2.

Frequencies to be tested: mid range; see clause G.2.4. In the test in Cell\_DCH state, "E-UTRAN TDD RSRQ Measurement" is applied to measure on E-UTRAN TDD.

Tables 8.7.17.4.1-1 and 8.7.17.4.1-2 define the limits of signal strengths and code powers on the UTRA TDD cell. In the measurement control information periodic reporting of E-UTRAN TDD RSRQ is indicated to the UE. The E-UTRAN TDD test parameters are given in Table 8.7.17.4.1-3.

Table 8.7.17.4.1-1: General parameters of E-UTRA TDD RSRQ measurement tests

Parameter	Unit	Value	Comment
DCH parameters		DL Reference Measurement Channel 12.2 kbps	As specified in TS 25.102 section A.2.2
Power Control		On	
Target quality value on DTCH	BLER	0.01	
Active cell		Cell 1	1.28Mcps UTRA TDD cell
Neighbour cell		Cell 2	E-UTRA TDD cell
CP length of cell 2		Normal	
Uplink-downlink configuration of cell 2		1	As specified in table 4.2.2 in TS 36.211
Special subframe configuration of cell 2		6	As specified in table 4.2.1 in TS 36.211
Idle intervals period	ms	80	As specified in TS 25.331
Filter coefficient		0	L3 filtering is not used
Inter-RAT(E-UTRA TDD) measurement quantity		E-UTRA TDD RSRQ	

Table 8.7.17.4.1-2: E-UTRA TDD RSRQ measurement tests parameters (cell 1)

Parameter	Unit	Test 1, Test 2, and Test 3	
DL timeslot number		0	DwPTS
UTRA RF Channel number <sup>Note2</sup>		Channel 1	
PCCPCH_Ec/lor	dB	-3	
DwPCH_Ec/lor	dB		0
OCNS_Ec/lor	dB	-3	
lor	dBm/1.28MHz	-75	
lor/lor	dB	3	
PCCPCH RSCP <sup>Note1</sup>	dBm	-75	
Io <sup>Note1</sup>	dBm/1.28MHz	-70.24	
Propagation condition		AWGN	
Note 1: PCCPCH RSCP and Io levels have been calculated from other parameters for information purposes. They are not settable parameters themselves.			
Note 2: In the case of multi-frequency network of 1.28 Mcps TDD, the UTRA RF Channel Number can be set for the primary frequency in this test.			

Table 8.7.17.4.1-3: E-UTRA TDD RSRQ measurement tests parameters (cell 2)

Parameter	Unit	Test 1	Test 2	Test 3	
E-UTRA RF Channel Number		2	2	2	
BWchannel	MHz	10	10	10	
OCNG Patterns defined in A.3.2.2.2 (OP.2 TDD) in [24]		OP.2 TDD	OP.2 TDD	OP.2 TDD	
PBCH_RA	dB	0	0	0	
PBCH_RB					
PSS_RA					
SSS_RA					
PCFICH_RB					
PHICH_RA					
PHICH_RB					
PDCCH_RA					
PDCCH_RB					
PDSCH_RA					
PDSCH_RB					
OCNG_RA <sup>Note1</sup>					
OCNG_RB <sup>Note1</sup>					
$N_{oc}$ <sup>Note2</sup>					Bands 33 – 40
$\hat{E}_s / I_{ot}$		dB	-1.75	-4.7	-4.5
RSRP <sup>Note3</sup>	Bands 33 – 40	dBm/15 kHz	-81.75	-108.70	-123.50
RSRQ <sup>Note3</sup>	Bands 33 – 40	dB	-14.76	-16.76	-16.61
Io <sup>Note3</sup>	Bands 33 – 40	dBm/9 MHz	-50	-74.95	-89.90
$\hat{E}_s / N_{oc}$		dB	-1.75	-4.7	-4.5
Propagation condition	-	AWGN	AWGN	AWGN	
Note 1: OCNG shall be used such that both cells are fully allocated and a constant total transmitted power spectral density is achieved for all OFDM symbols.					
Note 2: Interference from other cells and noise sources not specified in the test is assumed to be constant over subcarriers and time and shall be modelled as AWGN of appropriate power for $N_{oc}$ to be fulfilled.					
Note 3: RSRP, RSRQ and Io levels have been derived from other parameters for information purposes. They are not settable parameters themselves.					
Note 4: RSRP and RSRQ minimum requirements are specified assuming independent interference and noise at each receiver antenna port.					

## 8.7.17.4.2 Test Procedure

- 1) SS shall transmit the MEASUREMENT CONTROL message for inter RAT measurement. In the measurement control information periodic reporting of the EUTRAN TDD RSRQ is requested to the UE.
- 2) UE shall transmit periodically MEASUREMENT REPORT messages.

- 3) SS shall check E-UTRAN TDD RSRQ value of Cell 2 in MEASUREMENT REPORT messages. E-UTRAN TDD RSRQ power of Cell 2 reported by UE is compared to actual E-UTRAN TDD RSRQ value of Cell 2 for each MEASUREMENT REPORT message.
- 4) SS shall check MEASUREMENT REPORT messages transmitted by UE until statistical significance according to Annex F.6.2.8 is achieved.
- 5) The RF parameters are set up according to table 8.7.17.4.1-3 for Test 2. While RF parameters are being set up, MEASUREMENT REPORT messages from UE are ignored. SS shall wait for additional [1s] and ignore the MEASUREMENT REPORT messages during this period. Then, step 6) and 7) above are repeated.
- 6) The RF parameters are set up according to table 8.7.17.4.1-3 for Test 3. While RF parameters are being set up, MEASUREMENT REPORT messages from UE are ignored. SS shall wait for additional [1s] and ignore the MEASUREMENT REPORT messages during this period. Then, step 6) and 7) above are repeated.
- 7) The SS shall transmit RRC CONNECTION RELEASE message.
- 8) UE shall transmit RRC CONNECTION RELEASE COMPLETE message.

### Specific Message Contents

All messages indicated above shall use the same content as described in default message content in clause 9 of 34.108 [3], with the following exceptions:

Note: Numbers in brackets after an item e.g “Message Type (10.2.17)” in the IE description are references to clause numbers in TS 25.331 [9] describing that item in more detail.

MEASUREMENT CONTROL message for EUTRAN TDD measurement (Step 1):

Information Element	Value/Remark
Message Type (10.2.17)	
UE information elements	
-RRC transaction identifier	0
-Integrity check info	Not Present
Measurement Information elements	
-Measurement Identity	2
-Measurement Command	Setup
-Measurement Reporting Mode	
- Measurement Report Transfer Mode	Acknowledged mode RLC
- Periodical Reporting / Event Trigger Reporting Mode	Periodical reporting
-Additional measurement list	Not Present
-CHOICE Measurement Type	Inter-RAT measurement
-Inter-frequency measurement object list	
-CHOICE Inter-frequency cell removal	Not Present
-New inter-frequency cells	Cell 2 information is included
-Cell for measurement	Not Present
-Inter-frequency measurement quantity	
-CHOICE reporting criteria	Inter-frequency reporting criteria
-Filter coefficient	0
-CHOICE mode	EUTRAN TDD
-Measurement quantity	RSRQ
-Inter-frequency reporting quantity	
-UTRA Carrier RSSI	
-Frequency quality estimate	FALSE
-Non frequency related cell reporting quantities	FALSE
-SFN-SFN observed time difference reporting indicator	No report
-Cell synchronisation information reporting indicator	
-Maximum number of reported cells	Report all active set cells + cells within monitored set on used frequency
-Measurement validity	Virtual/active set cells + 1
-Inter-frequency set update	Not Present
-CHOICE report criteria	Not Present
-Amount of reporting	Not Present
-Reporting interval	Periodical reporting criteria Infinity 500 ms
Physical channel information elements	
-DPCH compressed mode status info	Not Present

### 8.7.17.5 Test requirements

Table 8.7.17.5-2 and table 8.7.17.5-3 defines the primary level settings including test tolerances for all tests.

Each E-UTRAN TDD RSRQ absolute accuracy test shall meet the accuracy test requirements in table 8.7.17.5-1 and the reported values test requirements in table 8.7.17.5-4.

**Table 8.7.17.5-1: E-UTRAN TDD RSRQ absolute accuracy**

Parameter	Unit	Accuracy [dB]		Conditions <sup>1</sup>			
		Normal condition	Extreme condition	Bands 1, 4, 6, 10, 18, 19, 33, 34, 35, 36, 37, 38, 39, 40	Bands 2, 5, 7, 11, 17	Bands 3, 8, 12, 13, 14	Bands 9
				Io	Io	Io	Io
RSRQ when RSRP $\hat{E}_s/\text{lot} > -3$ dB	dBm	$\pm 2.5+TT$	$\pm 4+TT$	- 121dBm/15kHz ... -50dBm/ BW <sub>Channel</sub>	- 119dBm/15kHz ... -50dBm/ BW <sub>Channel</sub>	- 118dBm/15kHz ... -50dBm/ BW <sub>Channel</sub>	- 120dBm/15kHz ... -50dBm/ BW <sub>Channel</sub>
RSRQ when RSRP $\hat{E}_s/\text{lot} \geq -6$ dB	dBm	$\pm 3.5+TT$	$\pm 4+TT$	- 121dBm/15kHz ... -50dBm/ BW <sub>Channel</sub>	- 119dBm/15kHz ... -50dBm/ BW <sub>Channel</sub>	- 118dBm/15kHz ... -50dBm/ BW <sub>Channel</sub>	- 120dBm/15kHz ... -50dBm/ BW <sub>Channel</sub>

Note 1: Io is assumed to have constant EPRE across the bandwidth.

**Table 8.7.17.5-2: UTRAN TDD cell specific test parameters for E-UTRAN TDD RSRQ absolute accuracy tests**

Parameter	Unit	Test 1, Test 2, and Test 3
DL timeslot number		0 DwPTS
UTRA RF Channel number <sup>Note2</sup>		Channel 1
PCCPCH Ec/Ior	dB	-3
DwPCH Ec/Ior	dB	0
OCNS Ec/Ior	dB	-3
Ioc	dBm/1.28MHz	-75+TT
Ior/Ioc	dB	3+TT
PCCPCH RSCP <sup>Note1</sup>	dBm	-75+TT
Io <sup>Note 1</sup>	dBm/1.28MHz	-70.24+TT
Propagation condition		AWGN
Note 1: PCCPCH RSCP and Io levels have been calculated from other parameters for information purposes. They are not settable parameters themselves. Note 2: In the case of multi-frequency network of 1.28 Mcps TDD, the UTRA RF Channel Number can be set for the primary frequency in this test.		

**Table 8.7.17.5-3: E-UTRAN TDD cell specific test parameters for E-UTRAN TDD RSRQ absolute accuracy tests**

Parameter		Unit	Test 1	Test 2	Test 3
E-UTRA RF Channel Number			2	2	2
BWchannel		MHz	10	10	10
OCNG Patterns defined in A.3.2.2.2 (OP.2 TDD) in [24]			OP.2 TDD	OP.2 TDD	OP.2 TDD
PBCH_RA		dB	0	0	0
PBCH_RB					
PSS_RA					
SSS_RA					
PCFICH_RB					
PHICH_RA					
PHICH_RB					
PDCCH_RA					
PDCCH_RB					
PDSCH_RA					
PDSCH_RB					
OCNG_RA <sup>Note1</sup>					
OCNG_RB <sup>Note1</sup>					
$N_{oc}$ <sup>Note2</sup>	Bands 33 – 40	dBm/15 kHz	-80+TT	-104+TT	-119+TT
$\hat{E}_s / I_{ot}$		dB	-1.75+TT	-4.7+TT	-4.5+TT
RSRP <sup>Note3</sup>	Bands 33 – 40	dBm/15 kHz	-81.75+TT	-108.70+TT	-123.50+TT
RSRQ <sup>Note3</sup>	Bands 33 – 40	dB	-14.76+TT	-16.76+TT	-16.61+TT
$I_o$ <sup>Note3</sup>	Bands 33 – 40	dBm/9 MHz	-50+TT	-74.95+TT	-89.90+TT
$\hat{E}_s / N_{oc}$		dB	-1.75+TT	-4.7+TT	-4.5+TT
Propagation condition		-	AWGN	AWGN+TT	AWGN+TT
<p>Note 1: OCNG shall be used such that both cells are fully allocated and a constant total transmitted power spectral density is achieved for all OFDM symbols.</p> <p>Note 2: Interference from other cells and noise sources not specified in the test is assumed to be constant over subcarriers and time and shall be modelled as AWGN of appropriate power for <math>N_{oc}</math> to be fulfilled.</p> <p>Note 3: RSRP, RSRQ and <math>I_o</math> levels have been derived from other parameters for information purposes. They are not settable parameters themselves.</p> <p>Note 4: RSRP and RSRQ minimum requirements are specified assuming independent interference and noise at each receiver antenna port.</p>					

**Table 8.7.17.5-4: E-UTRAN TDD RSRQ absolute accuracy requirements for the reported values**

	Test 1	Test 2
Normal Conditions		
Lowest reported value (Cell 2)	E-UTRAN TDD RSRQ_FFS	E-UTRAN TDD RSRQ_FFS
Highest reported value (Cell 2)	E-UTRAN TDD RSRQ_FFS	E-UTRAN TDD RSRQ_FFS
Extreme Conditions		
Lowest reported value (Cell 2)	E-UTRAN TDD RSRQ_FFS	E-UTRAN TDD RSRQ_FFS
Highest reported value (Cell 2)	E-UTRAN TDD RSRQ_FFS	E-UTRAN TDD RSRQ_FFS

NOTE: If the above Test Requirement differs from the Minimum Requirement then the Test Tolerance applied for this test is non-zero. The Test Tolerance for this test is defined in clause F.2 and the explanation of how the Minimum Requirement has been relaxed by the Test Tolerance is given in clause F.4.

## 9 Performance requirements for HSDPA

### 9.1 General

Receiving performance test of the UE is implemented during communicating with the SS via air interface. The procedure uses normal call protocol until the UE is communicating on traffic channel basically. (Refer to TS 34.108 [3] Common Test Environments for User Equipment (UE) Conformance Testing.) On the traffic channel, the UE provides special function for testing that is described in Logical Test Interface and the UE is tested using this function. (Refer to TS 34.109 [4] Logical Test Interface (FDD/TDD) Special conformance testing functions.)

Unless otherwise stated the receiver characteristics are specified at the antenna connector of the UE. For UE(s) with an integral antenna only, a reference antenna with a gain of 0 dBi is assumed. UE with an integral antenna may be taken into account by converting these power levels into field strength requirements, assuming a 0 dBi gain antenna. Receiver characteristics for UE(s) with multiple antennas/antenna connectors are for further study.

The UE antenna performance has a significant impact on system performance, and minimum requirements on the antenna efficiency are therefore intended to be included in future versions of the present document. It is recognized that different requirements and test methods are likely to be required for the different types of UE.

All Bit Error ratio (BER) measurements shall be performed according to the general rules for statistical testing in Annex F.6.

### 9.2 Performance requirement for 3.84 Mcps TDD option

During the Fixed Reference Channel tests the behaviour of the Node-B emulator in response to the ACK/NACK signalling field of the HS-DPCCH is specified in Table 9.2.1:

**Table 9.2.1: Node-B Emulator Behaviour in response to ACK/NACK/DTX**

0HS-DPCCH ACK/NACK Field State	0Node-B Emulator Behaviour
1ACK	1ACK: new transmission using 1 <sup>st</sup> redundancy and constellation version (RV)
2NACK	2NACK: retransmission using the next RV (up to the maximum permitted number of RV's)
3DTX	3DTX: retransmission using the RV previously transmitted to the same H-ARQ process

#### 9.2.1 HS-DSCH throughput for Fixed Reference Channels

##### 9.2.1.1 Definition and applicability

The HS-DSCH data throughput for fixed reference channels is defined by the capabilities of the UE as defined in [24], and the throughput is measured by counting the amount of data successfully received at the UE by monitoring the ACK/NACK signalling field of the HS-SICH received at the SS, while random data is streamed from the SS to the UE.

The normative reference for this test is 25.102 [2], section 9.

The requirements and this test apply to 3.84 Mcps TDD UE from release 5 and later that support HSDPA.

##### 9.2.1.2 Minimum requirements

The requirements are specified in terms of minimum information bit throughput R for the DL reference channels specified in Annex C.4.1 with the addition of the relevant parameters in Tables 9.2.1.1 and 9.2.1.3.

Using this configuration the throughput shall meet or exceed the minimum requirements specified in tables 9.2.1.2 and 9.2.1.4.

**Table 9.2.1.1: Test parameters for fixed reference measurement channel requirements for 7,3 Mbps – Category 8 - UE (3,84 Mcps TDD Option) QPSK**

Parameters	Unit	Test 1	Test 2	Test 3	Test 4
HS-PDSCH Modulation	-	QPSK			
Scrambling code and basic midamble code number*	-	0, 1			
Number of TS	-	8			
HS-PDSCH Channelization Codes*	C(k,Q)	C(i,16) i=1..16			C(i,16) i=1..14
Number of Hybrid ARQ processes	-	4			
Maximum number of Hybrid ARQ transmissions	-	4			
Redundancy and constellation version coding sequence**	-	{0,0,0,0} s=1, R=0, b=0			
$\frac{HS - PDSCH - E_c}{I_{or}}$	dB	-12,04			-11.46
$\frac{\sum HS - PDSCH - E_c}{I_{or}}$	dB	0			
$I_{oc}$	dBm/3,84 MHz	-60			
Note *: Refer to TS 25.223 for definition of channelization codes, scrambling code and basic midamble code.					
Note **: This sequence implies Chase combining					

**Table 9.2.1.2: Performance requirements for fixed reference measurement channel requirement in multipath channels for 7,3 Mbps – Category 8 - UE (3,84 Mcps TDD Option) QPSK**

Test Number	Propagation conditions	$\frac{\hat{I}_{or}}{I_{oc}}$ [dB]	R (Throughput) [kbps]
1	PA3	8,5	1300
2	PB3	9,0	1300
3	VA30	9,75	1300
4	VA120	11,5	1400



**Table 9.2.1.3: Test parameters for fixed reference measurement channel requirements for 7,3 Mbps – Category 8 - UE (3,84 Mcps TDD Option) 16QAM**

Parameters	Unit	Test 1	Test 2	Test 3	Test 4
HS-PDSCH Modulation	-	16QAM			
Scrambling code and basic midamble code number*	-	0, 1			
Number of TS	-	8			
HS-PDSCH Channelization Codes*	C(k,Q)	C(i,16) i=1..16			C(i,16) i=1..14
Number of Hybrid ARQ processes	-	4			
Maximum number of Hybrid ARQ transmissions	-	4			
Redundancy and constellation version coding sequence**	-	{0,0,0,0} s=1, r=0			
$\frac{HS - PDSCH - E_c}{I_{or}}$	dB	-12,04			-11,46
$\frac{\sum HS - PDSCH - E_c}{I_{or}}$	dB	0			
$I_{oc}$	dBm/3,84 MHz	-60			
Note *:	Refer to TS 25.223 for definition of channelization codes, scrambling code and basic midamble code.				
Note **:	This sequence implies Chase combining				

**Table 9.2.1.4: Performance requirements for fixed reference measurement channel requirement in multipath channels for 7,3 Mbps – Category 8 - UE (3,84 Mcps TDD Option) 16QAM**

Test Number	Propagation conditions	$\frac{\hat{I}_{or}}{I_{oc}}$ [dB]	R (Throughput) [kbps]
1	PA3	16,0	2600
2	PB3	17,5	2600
3	VA30	18,5	2600
4	VA120	14,5	1600

The reference for this requirement is TS 25.102 [1] clauses 9.1.1.1 and 9.1.1.2.

### 9.2.1.3 Test purpose

To verify the ability of the receiver to receive a predefined test signal, representing a multi-path fading channel with information bit throughput R not falling below a specified value.

### 9.2.1.4 Method of test

#### 9.2.1.4.1 Initial conditions

Test environment: normal; see clauses G.2.1 and G.2.2.

Frequencies to be tested: mid range; see clause G.2.4.

- 1) Connect the SS (node B emulator) and fader and AWGN noise source to the UE antenna connector as shown in figure A.10.
- 2) Set up an HSDPA call according to TS 34.108 [3] clause 7.3.6.3 with levels according to Annex E.3.
- 3) Set the node B emulator ACK/NACK/DTX behaviour according to table 9.2.1. Set the test parameters and levels for tests 1-4 according to tables 9.2.1.1. The reference channel configuration is defined in section C.4.1. The configuration of the TX power for downlink physical channels is annex in E.3.

- 4) The information bit data shall be pseudo random and not repeated before 10 different information bit payload blocks are processed. (e.g. Fixed reference Channel Definition (16 QAM, test 1,2,3): The information bit payload block is 52996 bits long. Hence the PRBSequence must be at least  $52996 * 10$  bits long. ) Use a PRBS from ITU-T O.153 Ref [25].
- 5) Setup the fading simulator with fading conditions as described in table D.2.2.1A.

#### 9.2.1.4.2 Procedure

- a. Once the HSDPA connection is setup, start transmitting HSDPA data.
- b. For all relevant propagation conditions, for all relevant  $I_{oc}$  levels, for all relevant  $E_c/I_{or}$ , for all relevant  $\hat{I}_{or}/I_{oc}$  defined in Tables 9.2 and 9.4 count the number of NACK, ACK and statDTX on the UL HS-SICH during the test interval and decide pass or fail according to Annex F.6.3 tables F.6.3.5.3 and F.6.3.5.4.

#### 9.2.1.5 Test Requirements

Tables 9.2.1.1 to 9.2.1.4 define the primary level settings including test tolerance for all relevant throughput tests. The pass / fail decision for throughput is done according to Annex F.6.3.

### 9.2.2 HS-DSCH throughput for Variable Reference Channels

#### 9.2.2.1 Definition and applicability

The HS-DSCH data throughput for variable reference channels is defined by the capabilities of the UE as defined in [24], and the throughput is measured by counting the amount of data successfully received at the UE by monitoring the ACK/NACK signalling field of the HS-SICH received at the SS, while random data is streamed from the SS to the UE.

The normative reference for this test is 25.102 [2], section 9.

The requirements and this test apply to 3.84 Mcps TDD UE from release 5 and later that support HSDPA.

#### 9.2.2.2 Minimum requirements

For the parameters specified in Table 9.2.2.1 the measured throughput R shall exceed the throughput specified in Table 9.2.2.2 for each radio condition. The variable Reference Channel is specified in Annex C.4.3.

**Table 9.2.2.1: Test parameters for variable reference measurement channel requirements for 7,3 Mbps – Category 8 - UE (3,84 Mcps TDD Option)**

Parameters	Unit	Test 1	Test 2	Test 3	Test 4
Scrambling code and basic midamble code number*	-	0, 1			
Number of TS	-	8			
HS-PDSCH Channelization Codes*	C(k,Q)	C(i,16) i=1..16			
Number of Hybrid ARQ processes**	-	4			
Maximum number of Hybrid ARQ transmissions	-	1			
Redundancy and constellation version coding sequence	(Xrv, s, r, b)	(0, 1, 0, 0)			
HS-PDSCH <sub>i</sub> Ec/Ior	dB	-12,04			
$\frac{\sum_{i=1}^i HS - PDSCH - Ec_i}{I_{or}}$	dB	0			
$I_{oc}$	dBm/3,84MHz	-60			
Note *: Refer to TS 25.223 for definition of channelization codes, scrambling code and basic midamble code.					
Note **: For timing requirements, HARQ is not active					

**Table 9.2.2.2: Performance requirements for variable reference measurement channel requirement in multipath channels for 7,3 Mbps – Category 8 - UE (3,84 Mcps TDD Option)**

Test Number	Propagation conditions	$\frac{\hat{I}_{or}}{I_{oc}}$ [dB]	R (Throughput) [kbps]
1	PA3	8,8	1240
		14,8	2500
		18,8	3600
		24,8	5000
2	PB3	8,8	1220
		14,8	2430
		20,8	4030
		24,8	5080
3	VA30	10,1	1190
		16,1	2290
		20,1	3220
		24,1	4260
4	VA120	7,1	590
		11,1	1180
		15,1	1840
		19,1	2390

### 9.2.2.3 Test purpose

To verify that the UE receiver is capable meeting the minimum requirements for support of HSDPA in the conditions defined below, with the selection of QPSK and 16QAM modulation, and appropriate blocksize being determined by the SS based on the CQI reported by the UE..

### 9.2.2.4 Method of test

#### 9.2.2.4.1 Initial conditions

Test environment: normal; see clauses G.2.1 and G.2.2.

Frequencies to be tested: mid range; see clause G.2.4.

- 1) Connect the SS (node B emulator) and fader and AWGN noise source to the UE antenna connector as shown in figure A.10.
- 2) Set up an HSDPA call according to TS 34.108 [3] clause 7.3.6.3 with levels according to Annex E.3.
- 3) Set the node B emulator ACK/NACK/DTX behaviour according to table 9.2.1. Set the test parameters and levels for tests 1-4 according to tables 9.2.2.1. The reference channel configuration is defined in section C.4.3. The configuration of the TX power for downlink physical channels is annex in E.3.
- 4) The information bit data shall be pseudo random and not repeated before 10 different information bit payload blocks are processed. Use a PRBS from ITU-T O.153 Ref [25]
- 5) Setup the fading simulator with fading conditions as described in table D.2.2.1A.

#### 9.2.2.4.2 Procedure

- 1) Once the HSDPA connection is setup, start transmitting HSDPA Data.
- 2) The SS shall transmit a HSDPA block to UE selecting any TBS value, then SS will decode the CQI report and transmit a new block on the HS-DSCH with the transport block size and modulation scheme recommended by the UE.
- 3) For any HSDPA block transmitted by the SS, record transmitted block size and relevant received ACK, NACK and statDTX reported by UE. If UE reports ACK, the transmitted block is correctly received by UE. Continue transmission of the HS-PDSCH data and record transmitted block size until [2000] records have been reached.
- 4) For all relevant propagation conditions, calculate the throughput, which is the ratio of the sum of correctly received transport bits over the testing time. [2000] multiplied by transmission time interval is the testing time.

### 9.2.2.5 Test Requirements

Table 9.2.2.1 define the primary level settings including test tolerance for all relevant throughput tests. the measured throughput shall be equal to or better than the the specified value in table 9.2.2.2.

## 9.2.3 Reporting of HS-DSCH Channel Quality Indicator

### 9.2.3.1 Definition and applicability

The reporting accuracy of channel quality indicator (CQI) under AWGN environments is determined by the reporting variance and the BLER performance using the transport format indicated by the reported CQI median. The CQI is measured while random data is streamed from the SS to the UE.

The normative reference for this test is 25.102 [2], section 9.

The requirements and this test apply to 3.84 Mcps TDD UE from release 5 and later that support HSDPA.

### 9.2.3.2 Minimum requirements

For the parameters specified in Table 9.2.3.1, the reported CQI value shall be in the range of +/-10 of the reported median more than 90% of the time. The BLER for the reported median CQI shall be less than 10%.

**Table 9.2.3.1: Test parameters for variable reference measurement channel requirements for 7,3 Mbps – Category 8 - UE (3,84 Mcps TDD Option)**

Parameters	Unit	Test 1	Test 2
Scrambling code and basic midamble code number*	-	0, 1	
Number of TS	-	8	
HS-PDSCH Channelization Codes*	C(k,Q)	C(i,16) i=1..16	
Number of Hybrid ARQ processes**	-	4	
Maximum number of Hybrid ARQ transmissions	-	1	
Redundancy and constellation version coding sequence	(Xrv, s, r, b)	(0, 1, 0, 0)	
HS-PDSCH <sub>i</sub> _Ec/Ior	dB	-12,04	
$\frac{\sum_{i=1}^j HS - PDSCH - Ec_i}{I_{or}}$	dB	0	
$\hat{I}_{or} / I_{oc}$	dB	5	10
I <sub>oc</sub>	dBm/3,84MHz	-60	
Note*: Refer to TS 25.223 for definition of channelization codes, scrambling code and basic midamble code.			
Note**: For timing requirements, HARQ is not active			

**Table 9.3.3.2 Performance requirements for CQI reporting measurement channel requirements for 7.3 Mbps – Category 9- UE (3.84 Mcps TDD Option)**

Test	Permitted CQI range from median (x)	% of time that CQI must be within +/- x of median (Y)	Maximum BLER for median reported CQI
Test 1	+/- 10	90	10%
Test 2			

### 9.2.3.3 Test purpose

To verify that the variance of the CQI reports in an AWGN channel is within the limits defined and that a BLER of better than 10% is obtained for the median reported CQI.

### 9.2.3.4 Method of test

#### 9.2.3.4.1 Initial conditions

Test environment: normal; see clauses G.2.1 and G.2.2.

Frequencies to be tested: mid range; see clause G.2.4.

- 1) Connect SS and an AWGN source to the UE antenna connector as shown in figure A.9.
- 2) Set up an HSDPA call according to TS 34.108 [3] clause 7.3.6.3 with levels according to Annex E.3.
- 3) Set the node B emulator ACK/NACK/DTX behaviour according to table 9.2.1. Set the test parameters and levels for tests 1-2 according to tables 9.2.3.1. The reference channel configuration is defined in section C.4.1. The configuration of the TX power for downlink physical channels is annex in E.3.
- 4) The information bit data shall be pseudo random and not repeated before 10 different information bit payload blocks are processed. (e.g. Fixed reference Channel Definition (16 QAM, test 1,2,3): The information bit payload block is 52996 bits long. Hence the PRBSequence must be at least  $52996 * 10$  bits long. ) Use a PRBS from ITU-T O.153 Ref [25].

#### 9.2.3.4.2 Procedure

Note: the following part of the procedure will test, if the UE reports a limited range of CQI indicator under the predefined channel conditions.

- 1) The SS shall transmit a HSDPA block to UE selecting any TBS value excluding 0, then SS will decode the CQI report and transmits a new block on the HS-DSCH with the transport block size and modulation scheme recommended by the UE. For any HSDPA block transmitted by the SS, record the received RTBS value of CQI indicator and the ACK, NACK and statDTX. Continue transmission of the HS-PDSCH data and collect RTBS value of CQI until [2000] reports have been gathered.
- 2) Set up a relative frequency distribution for the RTBS value of CQI indicator reported. Calculate the median value (Median RTBS is the RTBS that is at or crosses 50% distribution from the lower RTBS side). This RTBS value of CQI indicator is declared as Median CQI value,
- 3) If [1800] or more of the RTBS value of CQI indicator are in the range  $(\text{Median CQI} - 10) \leq \text{Median CQI} \leq (\text{Median CQI} + 10)$  then continue with next step, otherwise fail the UE.
- 4) Calculate the ratio  $(\text{NACK} + \text{statDTX}) / (\text{ACK} + \text{NACK} + \text{statDTX})$  when the SS transmit the TBS according to the median-CQI value. If the ratio  $< 0.1$ , then pass the UE, otherwise fail the UE.
- 5) Repeat the same procedure (steps 2 to 5) with test conditions according to the table 9.3.3.1 for Test 2, Test 3 and Test 4

### 9.2.3.5 Test Requirements

The pass fail decision as specified in the test procedure in 9.3.1.4.2.

No test tolerance is applied to the test parameters.

## 9.2.4 HS-SCCH Detection Performance

void

### 9.2.4A HS-SCCH Detection Performance

#### 9.2.4.1 Definition and applicability

The detection performance of the HS-SCCH is determined by the probability of event  $E_m$ , which is declared when the UE is signaled on HS-SCCH, but DTX is observed in the corresponding HS-SICH ACK/NACK field. The probability of event  $E_m$  is denoted  $P(E_m)$ .

The normative reference for this test is 25.102 [2], section 9.

The requirements and this test apply to 3.84 Mcps TDD UE from release 5 and later that support HSDPA.

### 9.2.4.2 Minimum requirements

For the test parameters in Table 9.2.4.1, for each value of HS-SCCH-1  $E_c/I_{or}$  specified in Table 9.2.4.2, the measured  $P(E_m)$  shall be less than or equal to the corresponding specified value of  $P(E_m)$ .

**Table 9.2.4.1: Test parameters for HS-SCCH detection (3.84 Mcps TDD option)**

Parameter	Unit	Test 1	Test 2	Test 3
Number of TS under test	-	1		
Number of HS-SCCH codes per timeslot	-	4		
HS-SCCH UE Identity ( $x_{ue,1}, x_{ue,2}, \dots, x_{ue,16}$ )	-	UE1 = 0000000000000000 (UE1 under test) UE2 = 0101010101010101 UE3 = 1010101010101010 UE4 = 1111111111111111		
HS-SCCH Channelization Codes*	C(k,Q)	HS-SCCH-1 = C(1, 16), for UE1 (UE under test) HS-SCCH-2 = C(2, 16) for UE2 HS-SCCH-3 = C(3, 16) for UE3 HS-SCCH-4 = C(4, 16) for UE4		
HS-SCCH $E_c/I_{or}$	dB	HS-SCCH-2 $E_c/I_{or}$ = HS-SCCH-3 $E_c/I_{or}$ = HS-SCCH-4 $E_c/I_{or}$ , Where, $\sum$ HS-SCCH-X $E_c/I_{or}$ = 1, where X = 1, 2, 3, 4		

**Table 9.2.4.2: Minimum requirement for HS-SCCH detection (3.84 Mcps TDD option)**

Test Number	Propagation Conditions	Reference value		
		HS-SCCH-1 $E_c/I_{or}$ (dB)	$\hat{I}_{or}/I_{oc}$ (dB)	$P(E_m)$
1	PA3	-1.6	0	0.05
2	PA3	-3.0	5	0.01
3	VA30	-2.5	0	0.01

The reference for this requirement is TS 25.102 [2] clause 9.1.4.

### 9.2.4.3 Test purpose

To verify that  $P(E_m)$  does not exceed the limit in table 9.2.4.2.

### 9.2.4.4 Method of test

#### 9.2.4.4.1 Initial conditions

Test environment: normal; see clauses G.2.1 and G.2.2.

Frequencies to be tested: mid range; see clause G.2.4.

1. Connect SS, multipath fading simulator and an AWGN noise source to the UE antenna connector as shown in figure A.10.
2. Setup fading simulators as fading condition, which are described in table D.2.2.1A.
3. Set the node B emulator ACK/NACK/DTX behaviour according to table 9.2.1. Set the test parameters and levels for tests 1-3 according to tables 9.2.4.1 and 9.2.4.2. The reference channel configuration is defined in section C.4.1. The configuration of the TX power for downlink physical channels is annex in E.3.

#### 9.2.4.4.2 Procedure

1. The UE is switched on.
2. Set up an HSDPA call according to TS 34.108 [3] clause 7.3.6.3.

3. Count the number of NACK, ACK and statDTX on the UL HS-DPCCH during the test interval and decide pass or fail according to Annex F.6.1 and table F.6.1.8. NACK and ACK are counted as a pass and statDTX is counted as a failure.

#### 9.2.4.5 Test Requirements

The probability of event  $E_m$  denoted as  $P(E_m)$  (test procedure step 3) shall not exceed the specified value in table 9.2.4.2.

No test tolerance is applied to the test parameters.

### 9.3 Performance requirements for 1.28 Mcps TDD option

#### 9.3.1 HS-DSCH throughput for Fixed Reference Channels

The overall performance metric for HS-DSCH requirements is the throughput “R” measured on HS-DSCH.

During the Fixed Reference Channel tests the behaviour of the Node-B emulator in response to the ACK/NACK signalling field of the HS-SICH is specified in Table 9.3.1.1:

**Table 9.3.1.1: Node-B Emulator Behaviour in response to ACK/NACK/DTX (Fixed reference channel)**

HS-DPCCH ACK/NACK Field State	Node-B Emulator Behaviour
ACK	ACK: new transmission using 1 <sup>st</sup> redundancy version (RV)
NACK	NACK: retransmission using the next RV (up to the maximum permitted number or RV's)
DTX	DTX: retransmission using the RV previously transmitted to the same H-ARQ process

#### 9.3.1A HS-DSCH throughput for Fixed Reference Channels 0.5 Mbps UE class QPSK

##### 9.3.1A.1 Definition and applicability

The HS-DSCH data throughput for fixed reference channels is defined by the capabilities of the UE as defined in [24], and the throughput is measured by counting the amount of data successfully received at the UE by monitoring the ACK/NACK signalling field of the HS-SICH received at the SS, while random data is streamed from the SS to the UE.

The normative reference for this test is 25.102 [1], section 9.

The requirements and this test apply to 1,28 Mcps TDD UE from release 5 and later that support HSDPA which is 0.5 Mbps UE class.

##### 9.3.1A.2 Minimum requirements

For the parameters specified in below tables the measured throughput shall be equal to or better than the the specified value in belows table specified the performance requirement. The reference for this requirement is TS 25.102 [1] section 9.

**Table 9.3.1A.1: Test parameters for fixed reference measurement channel requirements for 0.5 Mbps UE class QPSK**

Parameters	Unit	Test 1	Test 2	Test 3	Test 4
HS-PDSCH Modulation	-	QPSK			
Scrambling code and basic midamble code number*	-	1			
Midamble		Common midamble			
Number of TS**		2			
HS-PDSCH Channelization Codes*	C(k,Q)	C(i,16) i=1..10			
Number of Hybrid ARQ processes	-	4			
Maximum number of Hybrid ARQ transmissions	-	4			
Redundancy and constellation version coding sequence	-	{0,0,0,0}			
$\frac{HS - PDSCH - E_c}{I_{or}}$	dB	-10			
$I_{oc}$	dBm/1.28 MHz	-60			
*Note:	Refer to TS 25.223 for definition of channelization codes, scrambling code and basic midamble code.				
**Note:	The timeslot just after the second switch point should be included.				

**Table 9.3.1A.2: Minimum performance requirements for fixed reference measurement channel requirement in multipath channels for 0.5Mbps UE class QPSK**

Test Number	Propagation conditions	$\frac{\hat{I}_{or}}{I_{oc}}$ [dB]	R (Throughput) [kbps]
1	PA3	10	160
2	PB3	10	170
3	VA30	10	161
4	VA120	10	153

### 9.3.1A.3 Test purpose

To verify that the UE receiver is capable meeting the minimum requirements for support of HSDPA in the conditions defined above for QPSK modulation.

### 9.3.1A.4 Method of test

#### 9.3.1A.4.1 Initial conditions

Test environment: normal; see clauses G.2.1 and G.2.2.

Frequencies to be tested: mid range; see clause G.2.4.

- 1) Connect SS, multipath fading simulator and an AWGN source to the UE antenna connector as shown in figure A.10.
- 2) Set Ack/Nack/ DTX handling at the SS as table 9.3.1.1, Setup fading simulators as fading conditions, which are described in table D.2.2.1.A.
- 3) Set up a HSDPA connection according to the Generic HSDPA setup procedure. See TS 34.108 [3] and TS 34.109 [4] for details regarding generic HSDPA setup procedure.
- 4) Set the test parameters according to above tables of test parameters. The configuration of the downlink channels is defined in table C.4.2.



### 9.3.1A.4.2 Procedure

- 1) Once the HSDPA connection is setup, start transmitting HSDPA Data.
- 2) The information bit data shall be pseudo random and not repeated not before 10 different information bit payload blocks are processed. (e.g. Fixed reference Channel Definition (16 QAM): The information bit payload block is 3650 bits long. Hence the PRBSequence must be at least 3650 \* 10 bits long. ) Use a PRBS from ITU-R O.153 Ref [26].
- 3) For all relevant propagation conditions, count the number of NACK, ACK and statDTX on the UL HS-SICH during the test interval and decide pass or fail according to Annex F.6.3, table F.6.3.5.1..

### 9.3.1A.5 Test Requirements

Tables of test parameters define the primary level settings including test tolerance for all relevant throughput tests. the measured throughput shall be equal to or better than the the specified value in table 9.3.1A.3 of test requirement.

**Table 9.3.1A.3: Test requirements for fixed reference measurement channel requirement in multipath channels for 0.5Mbps UE class QPSK**

Test Number	Propagation conditions	$\frac{\hat{I}_{or}}{I_{oc}}$ [dB]	R (Throughput) [kbps]
1	PA3	10.6	160
2	PB3	10.6	170
3	VA30	10.6	161
4	VA120	10.6	153

The pass / fail decision for throughput is done according to Annex F.6.3.9.3.1BHS-DSCH throughput for Fixed Reference Channels 1.1 Mbps UE class 16QAM

### 9.3.1B.1 Definition and applicability

The HS-DSCH data throughput for fixed reference channels is defined by the capabilities of the UE as defined in [24] , and the throughput is measured by counting the amount of data successfully received at the UE by monitoring the ACK/NACK signalling field of the HS-SICH received at the SS, while random data is streamed from the SS to the UE.

The normative reference for this test is 25.102 [2], section 9.

The requirements and this test apply to 1,28 Mcps TDD UE from release 5 and later that support HSDPA which is 1.1 Mbps UE class..

### 9.3.1B.2 Minimum requirements

For the parameters specified in below tables the measured throughput shall be equal to or better than the the specified value in belows table specified the performance requirement. The reference for this requirement is TS 25.102 [1] section 9.

**Table 9.3.1B.1: Test parameters for fixed reference measurement channel requirements for 1.1 Mbps UE class, 16QAM**

Parameters	Unit	Test 1	Test 2	Test 3	Test 4
HS-PDSCH Modulation	-	16QAM			
Scrambling code and basic midamble code number*	-	1			
Midamble	-	Common midamble			
Number of TS**	-	2			
HS-PDSCH Channelization Codes*	C(k,Q)	C(i,16) i=1..12			
Number of Hybrid ARQ processes	-	4			
Maximum number of Hybrid ARQ transmissions	-	4			
Redundancy and constellation version coding sequence	-	{6,2,1,5}			
$\frac{HS - PDSCH - E_c}{I_{or}}$	dB	-10.8			
$I_{oc}$	dBm/1.28 MHz	-60			
*Note:	Refer to TS 25.223 for definition of channelization codes, scrambling code and basic midamble code.				
**Note:	The timeslot just after the second switch point should be included.				

**Table 9.3.1B.2: Minimum performance requirements for fixed reference measurement channel requirement in multipath channels for 1.1Mbps UE class, 16QAM**

Test Number	Propagation conditions	$\frac{\hat{I}_{or}}{I_{oc}}$ [dB]	R (Throughput) [kbps]
1	PA3	15	388
2	PB3	15	347
3	VA30	15	316
4	VA120	15	274

### 9.3.1B.3 Test purpose

To verify that the UE receiver is capable meeting the minimum requirements for support of HSDPA in the conditions defined above for 16QAM modulation.

### 9.3.1B.4 Method of test

#### 9.3.1B.4.1 Initial conditions

Test environment: normal; see clauses G.2.1 and G.2.2.

Frequencies to be tested: mid range; see clause G.2.4.

- 1) Connect SS, multipath fading simulator and an AWGN source to the UE antenna connector as shown in figure A.10.
- 2) Set Ack/Nack/ DTX handling at the SS as table 9.3.1.1, Setup fading simulators as fading conditions, which are described in table D.2.2.1.A.
- 3) Set up a HSDPA connection according to the Generic HSDPA setup procedure. See TS 34.108 [3] and TS 34.109 [4] for details regarding generic HSDPA setup procedure.
- 4) Set the test parameters according to above tables of test parameters. The configuration of the downlink channels is defined in table C.4.2.

### 9.3.1B.4.2 Procedure

- 1) Once the HSDPA connection is setup, start transmitting HSDPA Data.
- 2) The information bit data shall be pseudo random and not repeated not before 10 different information bit payload blocks are processed. (e.g. Fixed reference Channel Definition (16 QAM): The information bit payload block is 3650 bits long. Hence the PRBSequence must be at least 3650 \* 10 bits long. ) Use a PRBS from ITU-R O.153 Ref [26].
- 3) For all relevant propagation conditions, count the number of NACK, ACK and statDTX on the UL HS-SICH during the test interval and decide pass or fail according to Annex F.6.3, table F.6.3.5.2.

### 9.3.1B.5 Test Requirements

Tables of test parameters define the primary level settings including test tolerance for all relevant throughput tests. the measured throughput shall be equal to or better than the the specified value in table 9.3.1B.3 of test requirement.

**Table 9.3.1B.3: Test requirements for fixed reference measurement channel requirement in multipath channels for 1.1Mbps UE class, 16QAM**

Test Number	Propagation conditions	$\frac{\hat{I}_{or}}{I_{oc}}$ [dB]	R (Throughput) [kbps]
1	PA3	15.6	388
2	PB3	15.6	347
3	VA30	15.6	316
4	VA120	15.6	274

The pass / fail decision for throughput is done according to Annex F.6.3.

## 9.3.1C HS-DSCH throughput for Fixed Reference Channels 1.6 Mbps UE class QPSK/16QAM

### 9.3.1C.1 Definition and applicability

The HS-DSCH data throughput for fixed reference channels is defined by the capabilities of the UE as defined in [24] , and the throughput is measured by counting the amount of data succesfully received at the UE by monitoring the ACK/NACK signalling field of the HS-SICH received at the SS, while random data is streamed from the SS to the UE.

The normative reference for this test is 25.102 [2], section 9.

The requirements and this test apply to 1,28 Mcps TDD UE from release 5 and later that support HSDPA which is 1.6 Mbps UE class..

### 9.3.1C.2 Minimum requirements

For the parameters specified in below tables the measured throughput shall be equal to or better than the the specified value in belows table specified the performance requirement. The reference for this requirement is TS 25.102 [1] section 9.

**Table 9.3.1C.1: Test parameters for fixed reference measurement channel requirements for 1.6 Mbps UE class**

Parameters	Unit	Test 1	Test 2	Test 3	Test 4	Test 5	Test 6	Test 7	Test 8
HS-PDSCH Modulation	-	QPSK				16QAM			
Scrambling code and basic midamble code number*	-	1							
Midamble		Common midamble							
Number of TS**	-	3							
Number of Hybrid ARQ processes	-	4							
Maximum number of Hybrid ARQ transmissions	-	4							
HS-PDSCH Channelization Codes*	C(k,Q)	C(i,16) i=1..10				C(i,16) i=1..12			
Redundancy and constellation version coding sequence	-	{0,0,0,0}				{6,2,1,5}			
$\frac{HS - PDSCH - E_c}{I_{or}}$	dB	-10				-10.8			
$I_{oc}$	dBm/ 1.28MHz	-60							
*Note: Refer to TS 25.223 for definition of channelization codes, scrambling code and basic midamble code.									
**Note: The timeslot just after the second switch point should be included.									

**Table 9.3.1C.2: Minimum performance requirements for fixed reference measurement channel requirement in multipath channels for 1.6Mbps UE class**

Test Number	Propagation conditions	$\frac{\hat{I}_{or}}{I_{oc}}$ [dB]	R (Throughput) [kbps]
1	PA3	10	270
2	PB3	10	278
3	VA30	10	259
4	VA120	10	242
5	PA3	15	488
6	PB3	15	471
7	VA30	15	431
8	VA120	15	377

### 9.3.1C.3 Test purpose

To verify that the UE receiver is capable meeting the minimum requirements for support of HSDPA in the conditions defined above for QPSK and 16QAM modulation.

### 9.3.1C.4 Method of test

#### 9.3.1C.4.1 Initial conditions

Test environment: normal; see clauses G.2.1 and G.2.2.

Frequencies to be tested: mid range; see clause G.2.4.

- 1) Connect SS, multipath fading simulator and an AWGN source to the UE antenna connector as shown in figure A.10.
- 2) Set Ack/Nack/ DTX handling at the SS as table 9.3.1.1, Setup fading simulators as fading conditions, which are described in table D.2.2.1.A.
- 3) Set up a HSDPA connection according to the Generic HSDPA setup procedure. See TS 34.108 [3] and TS 34.109 [4] for details regarding generic HSDPA setup procedure.

- 4) Set the test parameters according to above tables of test parameters. The configuration of the downlink channels is defined in table C.4.2.

### 9.3.1C.4.2 Procedure

- 1) Once the HSDPA connection is setup, start transmitting HSDPA Data.
- 2) The information bit data shall be pseudo random and not repeated not before 10 different information bit payload blocks are processed. (e.g. Fixed reference Channel Definition (16 QAM): The information bit payload block is 3650 bits long. Hence the PRBSequence must be at least 3650 \* 10 bits long. ) Use a PRBS from ITU-R O.153 Ref [26].
- 3) For all relevant propagation conditions, count the number of NACK, ACK and statDTX on the UL HS-SICH during the test interval and decide pass or fail according to Annex F.6.3, tables F.6.3.5.3 and F.6.3.5.4.

### 9.3.1C.5 Test Requirements

Tables of test parameters define the primary level settings including test tolerance for all relevant throughput tests. the measured throughput shall be equal to or better than the the specified value in table 9.3.1C.3 of test requirement.

**Table 9.3.1C.3: Test requirements for fixed reference measurement channel requirement in multipath channels for 1.6Mbps UE class**

Test Number	Propagation conditions	$\frac{\hat{I}_{or}}{I_{oc}}$ [dB]	R (Throughput) [kbps]
1	PA3	10.6	270
2	PB3	10.6	278
3	VA30	10.6	259
4	VA120	10.6	242
5	PA3	15.6	488
6	PB3	15.6	471
7	VA30	15.6	431
8	VA120	15.6	377

The pass / fail decision for throughput is done according to Annex F.6.3.

## 9.3.1D HS-DSCH throughput for Fixed Reference Channels 2.2 Mbps UE class QPSK/16QAM

### 9.3.1D.1 Definition and applicability

The HS-DSCH data throughput for fixed reference channels is defined by the capabilities of the UE as defined in [24] , and the throughput is measured by counting the amount of data successfully received at the UE by monitoring the ACK/NACK signalling field of the HS-SICH received at the SS, while random data is streamed from the SS to the UE.

The normative reference for this test is 25.102 [2], section 9.

The requirements and this test apply to 1,28 Mcps TDD UE from release 5 and later that support HSDPA which is 2.2 Mbps UE class..

### 9.3.1D.2 Minimum requirements

For the parameters specified in below tables the measured throughput shall be equal to or better than the the specified value in belows table specified the performance requirement. The reference for this requirement is TS 25.102 [1] section 9.

**Table 9.3.1D.1: Test parameters for fixed reference measurement channel requirements for 2.2 Mbps UE class**

Parameters	Unit	Test 1	Test 2	Test 3	Test 4	Test 5	Test 6	Test 7	Test 8
HS-PDSCH Modulation	-	QPSK				16QAM			
Scrambling code and basic midamble code number*	-	1							
Minimum		Common midamble							
Number of TS**	-	4							
Number of Hybrid ARQ processes	-	4							
Maximum number of Hybrid ARQ transmissions	-	4							
HS-PDSCH Channelization Codes*	C(k,Q)	C(i,16) i=1..10				C(i,16) i=1..12			
Redundancy and constellation version coding sequence	-	{0,0,0,0}				{6,2,1,5}			
$\frac{HS - PDSCH - E_c}{I_{or}}$	dB	-10				-10.8			
$I_{oc}$	dBm/ 1.28MHz	-60							
*Note: Refer to TS 25.223 for definition of channelization codes, scrambling code and basic midamble code.									
**Note: The timeslot just after the second switch point should be included.									

**Table 9.3.1D.2: Minimum performance requirements for fixed reference measurement channel requirement in multipath channels for 2.2Mbps UE class**

Test Number	Propagation conditions	$\frac{\hat{I}_{or}}{I_{oc}}$ [dB]	R (Throughput) [kbps]
1	PA3	10	360
2	PB3	10	343
3	VA30	10	320
4	VA120	10	275
5	PA3	15	615
6	PB3	15	606
7	VA30	15	554
8	VA120	15	493

### 9.3.1D.3 Test purpose

To verify that the UE receiver is capable meeting the minimum requirements for support of HSDPA in the conditions defined above for QPSK and 16QAM modulation.

### 9.3.1D.4 Method of test

#### 9.3.1D.4.1 Initial conditions

Test environment: normal; see clauses G.2.1 and G.2.2.

Frequencies to be tested: mid range; see clause G.2.4.

- 1) Connect SS, multipath fading simulator and an AWGN source to the UE antenna connector as shown in figure A.10.
- 2) Set Ack/Nack/ DTX handling at the SS as table 9.3.1.1, Setup fading simulators as fading conditions, which are described in table D.2.2.1.A.
- 3) Set up a HSDPA connection according to the Generic HSDPA setup procedure. See TS 34.108 [3] and TS 34.109 [4] for details regarding generic HSDPA setup procedure.

- 4) Set the test parameters according to above tables of test parameters. The configuration of the downlink channels is defined in table C.4.2.

#### 9.3.1D.4.2 Procedure

- 1) Once the HSDPA connection is setup, start transmitting HSDPA Data.
- 2) The information bit data shall be pseudo random and not repeated not before 10 different information bit payload blocks are processed. (e.g. Fixed reference Channel Definition (16 QAM): The information bit payload block is 3650 bits long. Hence the PRBSequence must be at least 3650 \* 10 bits long. ) Use a PRBS from ITU-R O.153 Ref [26].
- 3) For all relevant propagation conditions, count the number of NACK, ACK and statDTX on the UL HS-SICH during the test interval and decide pass or fail according to Annex F.6.3, tables F.6.3.5.5 and F.6.3.5.6.

#### 9.3.1D.5 Test Requirements

Tables of test parameters define the primary level settings including test tolerance for all relevant throughput tests. the measured throughput shall be equal to or better than the the specified value in table 9.3.1D.3 of test requirement.

**Table 9.3.1D.3: Test requirements for fixed reference measurement channel requirement in multipath channels for 2.2Mbps UE class**

Test Number	Propagation conditions	$\frac{\hat{I}_{or}}{I_{oc}}$ [dB]	R (Throughput) [kbps]
1	PA3	10.6	360
2	PB3	10.6	343
3	VA30	10.6	320
4	VA120	10.6	275
5	PA3	15.6	615
6	PB3	15.6	606
7	VA30	15.6	554
8	VA120	15.6	493

The pass / fail decision for throughput is done according to Annex F.6.3.

### 9.3.1E HS-DSCH throughput for Fixed Reference Channels 2.8 Mbps UE class QPSK/16QAM

#### 9.3.1E.1 Definition and applicability

The HS-DSCH data throughput for fixed reference channels is defined by the capabilities of the UE as defined in [24], and the throughput is measured by counting the amount of data successfully received at the UE by monitoring the ACK/NACK signalling field of the HS-SICH received at the SS, while random data is streamed from the SS to the UE.

The normative reference for this test is 25.102 [2], section 9.

The requirements and this test apply to 1,28 Mcps TDD UE from release 5 and later that support HSDPA which is 2.8 Mbps UE class..

#### 9.3.1E.2 Minimum requirements

For the parameters specified in below tables the measured throughput shall be equal to or better than the the specified value in belows table specified the performance requirement. The reference for this requirement is TS 25.102 [1] section 9.

**Table 9.3.1E.1: Test parameters for fixed reference measurement channel requirements for 2.8 Mbps UE class**

Parameters	Unit	Test 1	Test 2	Test 3	Test 4	Test 5	Test 6	Test 7	Test 8
HS-PDSCH Modulation	-	QPSK				16QAM			
Scrambling code and basic midamble code number*	-	1							
Midamble		Common midamble							
Number of TS	-	5							
Number of Hybrid ARQ processes	-	4							
Maximum number of Hybrid ARQ transmissions	-	4							
HS-PDSCH Channelization Codes*	C(k,Q)	C(i,16) i=1..10				C(i,16) i=1..12			
Redundancy and constellation version coding sequence	-	{0,0,0,0}				{6,2,1,5}			
$\frac{HS - PDSCH - E_c}{I_{or}}$	dB	-10				-10.8			
$I_{oc}$	dBm/ 1.28MHz	-60							

\*Note: Refer to TS 25.223 for definition of channelization codes, scrambling code and basic midamble code.

**Table 9.3.1E.2: Minimum performance requirements for fixed reference measurement channel requirement in multipath channels for 2.8Mbps UE class**

Test Number	Propagation conditions	$\frac{\hat{I}_{or}}{I_{oc}}$ [dB]	R (Throughput) [kbps]
1	PA3	10	461
2	PB3	10	470
3	VA30	10	438
4	VA120	10	409
5	PA3	15	890
6	PB3	15	810
7	VA30	15	730
8	VA120	15	630

### 9.3.1E.3 Test purpose

To verify that the UE receiver is capable meeting the minimum requirements for support of HSDPA in the conditions defined above for QPSK and 16QAM modulation.

### 9.3.1E.4 Method of test

#### 9.3.1E.4.1 Initial conditions

Test environment: normal; see clauses G.2.1 and G.2.2.

Frequencies to be tested: mid range; see clause G.2.4.

- 1) Connect SS, multipath fading simulator and an AWGN source to the UE antenna connector as shown in figure A.10.
- 2) Set Ack/Nack/ DTX handling at the SS as table 9.3.1.1, Setup fading simulators as fading conditions, which are described in table D.2.2.1.A.
- 3) Set up a HSDPA connection according to the Generic HSDPA setup procedure. See TS 34.108 [3] and TS 34.109 [4] for details regarding generic HSDPA setup procedure.



- 4) Set the test parameters according to above tables of test parameters. The configuration of the downlink channels is defined in table C.4.2.

#### 9.3.1E.4.2 Procedure

- 1) Once the HSDPA connection is setup, start transmitting HSDPA Data.
- 2) The information bit data shall be pseudo random and not repeated not before 10 different information bit payload blocks are processed. (e.g. Fixed reference Channel Definition (16 QAM): The information bit payload block is 3650 bits long. Hence the PRBSequence must be at least 3650 \* 10 bits long. ) Use a PRBS from ITU-R O.153 Ref [26].
- 3) For all relevant propagation conditions, count the number of NACK, ACK and statDTX on the UL HS-SICH during the test interval and decide pass or fail according to Annex F.6.3, tables F.6.3.5.7 and F.6.3.5.8.

#### 9.3.1E.5 Test Requirements

Tables of test parameters define the primary level settings including test tolerance for all relevant throughput tests. the measured throughput shall be equal to or better than the the specified value in table 9.3.1E.3 of test requirement.

**Table 9.3.1E.3: Test requirements for fixed reference measurement channel requirement in multipath channels for 2.8Mbps UE class**

Test Number	Propagation conditions	$\frac{\hat{I}_{or}}{I_{oc}}$ [dB]	R (Throughput) [kbps]
1	PA3	10.6	461
2	PB3	10.6	470
3	VA30	10.6	438
4	VA120	10.6	409
5	PA3	15.6	890
6	PB3	15.6	810
7	VA30	15.6	730
8	VA120	15.6	630

The pass / fail decision for throughput is done according to Annex F.6.3.

### 9.3.1F HS-DSCH throughput for Fixed Reference Channels Categories 16-18- 64QAM

The overall performance metric for HS-DSCH requirements is the throughput “R” measured on HS-DSCH.

#### 9.3.1F.1 Definition and applicability

The HS-DSCH data throughput for fixed reference channels is defined by the capabilities of the UE as defined in [24], and the throughput is measured by counting the amount of data successfully received at the UE by monitoring the ACK/NACK signalling field of the HS-SICH received at the SS, while random data is streamed from the SS to the UE.

The normative reference for this test is 25.102 [1], section 9.

The requirements and this test apply to 1,28 Mcps TDD UE from release 8 and later that support HSDPA UE capability categories 16 - 24.

#### 9.3.1F.2 Minimum requirements

For the parameters specified in below tables the measured throughput shall be equal to or better than the the specified value in belows table specified the performance requirement. The reference for this requirement is TS 25.102 [1] section 9.

**Table 9.3.1F.1: Test parameters for fixed reference measurement channel requirements for category 16-18 UE**

Parameters	Unit	Test 1 (Category 16-18)
HS-PDSCH Modulation	-	64QAM
Scrambling code and basic midamble code number*	-	1
Number of TS	-	3
Number of Hybrid ARQ processes	-	4
Maximum number of Hybrid ARQ transmissions	-	4
HS-PDSCH Channelization Codes*	C(k,Q)	C(i,16) i=1..14
Redundancy and constellation version coding sequence	-	{6,5,4,0}
$\frac{HS - PDSCH - E_c}{I_{or}}$	dB	-11.46
$I_{oc}$	dBm/ 1.28MHz	-60

\*Note: Refer to TS 25.223 for definition of channelization codes, scrambling code and basic midamble code.

**Table 9.3.1F.2: Minimum performance requirements for fixed reference measurement channel requirement in multipath channels for category 16-18 UE**

Test Number	Propagation conditions	$\frac{\hat{I}_{or}}{I_{oc}}$ [dB]	R (Throughput) [kbps]
1	PA3	18	660

### 9.3.1F.3 Test purpose

To verify that the UE receiver is capable meeting the minimum requirements for support of HSDPA in the conditions defined above for 64QAM modulation.

### 9.3.1F.4 Method of test

#### 9.3.1F.4.1 Initial conditions

Test environment: normal; see clauses G.2.1 and G.2.2.

Frequencies to be tested: mid range; see clause G.2.4.

- 1) Connect SS, multipath fading simulator and an AWGN source to the UE antenna connector as shown in figure A.10.
- 2) Set Ack/Nack/ DTX handling at the SS as table 9.3.1.1, Setup fading simulators as fading conditions, which are described in table D.2.2.1.A.
- 3) Set up a HSDPA connection according to the Generic HSDPA setup procedure. See TS 34.108 [3] and TS 34.109 [4] for details regarding generic HSDPA setup procedure.
- 4) Set the test parameters according to above tables of test parameters. The configuration of the downlink channels is defined in table C.4.2.6.

#### 9.3.1F.4.2 Procedure

- 1) Once the HSDPA connection is setup, start transmitting HSDPA Data.

- 2) The information bit data shall be pseudo random and not repeated not before 10 different information bit payload blocks are processed. Use a PRBS from ITU-R O.153 Ref [25].
- 3) For all relevant propagation conditions, count the number of NACK, ACK and statDTX on the UL HS-SICH during the test interval and decide pass or fail according to Annex F.6.3 tables F.6.3.5.1 and F.6.3.5.2.

### 9.3.1F.5 Test Requirements

Tables of test parameters define the primary level settings including test tolerance for all relevant throughput tests. the measured throughput shall be equal to or better than the the specified value in table 9.3.1F.3 of test requirement.

**Table 9.3.1F.3: Test requirements for fixed reference measurement channel requirement in multipath channels for category 16-18 UE**

Test Number	Propagation conditions	$\frac{\hat{I}_{or}}{I_{oc}}$ [dB]	R (Throughput) [kbps]
1	PA3	18.6	660

The pass / fail decision for throughput is done according to Annex F.6.3.

## 9.3.1G HS-DSCH throughput for Fixed Reference Channels – Categories 19-21 64QAM

### 9.3.1G.1 Definition and applicability

The HS-DSCH data throughput for fixed reference channels is defined by the capabilities of the UE as defined in [24], and the throughput is measured by counting the amount of data successfully received at the UE by monitoring the ACK/NACK signalling field of the HS-SICH received at the SS, while random data is streamed from the SS to the UE.

The normative reference for this test is 25.102 [1], section 9.

The requirements and this test apply to 1,28 Mcps TDD UE from release 8 and later that support HSDPA UE capability categories 19 - 21.

### 9.3.1G.2 Minimum requirements

For the parameters specified in below tables the measured throughput shall be equal to or better than the the specified value in belows table specified the performance requirement. The reference for this requirement is TS 25.102 [1] section 9.

**Table 9.3.1G.1: Test parameters for fixed reference measurement channel requirements for category 19-21 UE**

Parameters	Unit	Test 1 (Category 19-21)
HS-PDSCH Modulation	-	64QAM
Scrambling code and basic midamble code number*	-	1
Number of TS	-	4
Number of Hybrid ARQ processes	-	4
Maximum number of Hybrid ARQ transmissions	-	4
HS-PDSCH Channelization Codes*	C(k,Q)	C(i,16) i=1..14
Redundancy and constellation version coding sequence	-	{6,5,4,0}
$\frac{HS - PDSCH - E_c}{I_{or}}$	dB	-11.46
$I_{oc}$	dBm/ 1.28MHz	-60

\*Note: Refer to TS 25.223 for definition of channelization codes, scrambling code and basic midamble code.

**Table 9.3.1G.2: Minimum performance requirements for fixed reference measurement channel requirement in multipath channels for category 19-21 UE**

Test Number	Propagation conditions	$\frac{\hat{I}_{or}}{I_{oc}}$ [dB]	R (Throughput) [kbps]
1	PA3	18	875

### 9.3.1G.3 Test purpose

To verify that the UE receiver is capable meeting the minimum requirements for support of HSDPA in the conditions defined above for 64QAM modulation.

### 9.3.1G.4 Method of test

#### 9.3.1G.4.1 Initial conditions

Test environment: normal; see clauses G.2.1 and G.2.2.

Frequencies to be tested: mid range; see clause G.2.4.

- 1) Connect SS, multipath fading simulator and an AWGN source to the UE antenna connector as shown in figure A.10.
- 2) Set Ack/Nack/ DTX handling at the SS as table 9.3.1.1, Setup fading simulators as fading conditions, which are described in table D.2.2.1.A.
- 3) Set up a HSDPA connection according to the Generic HSDPA setup procedure. See TS 34.108 [3] and TS 34.109 [4] for details regarding generic HSDPA setup procedure.
- 4) Set the test parameters according to above tables of test parameters. The configuration of the downlink channels is defined in table C.4.2.6.

#### 9.3.1G.4.2 Procedure

- 1) Once the HSDPA connection is setup, start transmitting HSDPA Data.

- 2) The information bit data shall be pseudo random and not repeated not before 10 different information bit payload blocks are processed. Use a PRBS from ITU-R O.153 Ref [25].
- 3) For all relevant propagation conditions, count the number of NACK, ACK and statDTX on the UL HS-SICH during the test interval and decide pass or fail according to Annex F.6.3 tables F.6.3.5.1 and F.6.3.5.2.

### 9.3.1G.5 Test Requirements

Tables of test parameters define the primary level settings including test tolerance for all relevant throughput tests. the measured throughput shall be equal to or better than the the specified value in table 9.3.1G.3 of test requirement.

**Table 9.3.1G.3: Test requirements for fixed reference measurement channel requirement in multipath channels for category 19-21 UE**

Test Number	Propagation conditions	$\frac{\hat{I}_{or}}{I_{oc}}$ [dB]	R (Throughput) [kbps]
1	PA3	18.6	875

The pass / fail decision for throughput is done according to Annex F.6.3.

### 9.3.1H HS-DSCH throughput for Fixed Reference Channels – Categories 22-24 64QAM

#### 9.3.1H.1 Definition and applicability

The HS-DSCH data throughput for fixed reference channels is defined by the capabilities of the UE as defined in [24], and the throughput is measured by counting the amount of data successfully received at the UE by monitoring the ACK/NACK signalling field of the HS-SICH received at the SS, while random data is streamed from the SS to the UE.

The normative reference for this test is 25.102 [1], section 9.

The requirements and this test apply to 1,28 Mcps TDD UE from release 8 and later that support HSDPA UE capability categories 16 - 18.

#### 9.3.1H.2 Minimum requirements

For the parameters specified in below tables the measured throughput shall be equal to or better than the the specified value in belows table specified the performance requirement. The reference for this requirement is TS 25.102 [1] section 9.

**Table 9.3.1H.1: Test parameters for fixed reference measurement channel requirements for category 22-24 UE**

Parameters	Unit	Test 1 (Category 22-24)
HS-PDSCH Modulation	-	64QAM
Scrambling code and basic midamble code number*	-	1
Number of TS	-	5
Number of Hybrid ARQ processes	-	4
Maximum number of Hybrid ARQ transmissions	-	4
HS-PDSCH Channelization Codes*	C(k,Q)	C(i,16) i=1..14
Redundancy and constellation version coding sequence	-	{6,5,4,0}
$\frac{HS - PDSCH - E_c}{I_{or}}$	dB	-11.46
$I_{oc}$	dBm/ 1.28MHz	-60

\*Note: Refer to TS 25.223 for definition of channelization codes, scrambling code and basic midamble code.

**Table 9.3.1H.2: Minimum performance requirements for fixed reference measurement channel requirement in multipath channels for category 22-24 UE**

Test Number	Propagation conditions	$\frac{\hat{I}_{or}}{I_{oc}}$ [dB]	R (Throughput) [kbps]
1	PA3	18	1090

### 9.3.1H.3 Test purpose

To verify that the UE receiver is capable meeting the minimum requirements for support of HSDPA in the conditions defined above for 64QAM modulation.

### 9.3.1H.4 Method of test

#### 9.3.1H.4.1 Initial conditions

Test environment: normal; see clauses G.2.1 and G.2.2.

Frequencies to be tested: mid range; see clause G.2.4.

- 1) Connect SS, multipath fading simulator and an AWGN source to the UE antenna connector as shown in figure A.10.
- 2) Set Ack/Nack/ DTX handling at the SS as table 9.3.1A.1, Setup fading simulators as fading conditions, which are described in table D.2.2.1.A.
- 3) Set up a HSDPA connection according to the Generic HSDPA setup procedure. See TS 34.108 [3] and TS 34.109 [4] for details regarding generic HSDPA setup procedure.
- 4) Set the test parameters according to above tables of test parameters. The configuration of the downlink channels is defined in table C.4.2.6.

#### 9.3.1H.4.2 Procedure

- 1) Once the HSDPA connection is setup, start transmitting HSDPA Data.

- 2) The information bit data shall be pseudo random and not repeated not before 10 different information bit payload blocks are processed. Use a PRBS from ITU-R O.153 Ref [25].
- 3) For all relevant propagation conditions, count the number of NACK, ACK and statDTX on the UL HS-SICH during the test interval and decide pass or fail according to Annex F.6.3 tables F.6.3.5.1 and F.6.3.5.2.

### 9.3.1H.5 Test Requirements

Tables of test parameters define the primary level settings including test tolerance for all relevant throughput tests. the measured throughput shall be equal to or better than the the specified value in table 9.3.1H.3 of test requirement.

The pass / fail decision for throughput is done according to Annex F.6.3.

**Table 9.3.1H.3: Test requirements for fixed reference measurement channel requirement in multipath channels for category 22-24 UE**

Test Number	Propagation conditions	$\frac{\hat{I}_{or}}{I_{oc}}$ [dB]	R (Throughput) [kbps]
1	PA3	18.6	1090

## 9.3.11 HS-DSCH throughput for Fixed Reference Channels –MIMO UE Category 25

### 9.3.11.1 Definition and applicability

The HS-DSCH data throughput for fixed reference channels is defined by the capabilities of the UE as defined in [24], and the throughput is measured by counting the amount of data successfully received at the UE by monitoring the ACK/NACK signalling field of the HS-SICH received at the SS, while random data is streamed from the SS to the UE.

The normative reference for this test is 25.102 [1], section 9.

The requirements and tests for category 25 apply to 1,28 Mcps TDD UEs from release 8 and later that MIMO is configured.

If MIMO is not configured, a category 25 UE should have the capability of category 18.

### 9.3.11.2 Minimum requirements

For the parameters specified in below tables the measured throughput shall be equal to or better than the the specified value in belows tables specified the performance requirement. The reference for this requirement is TS 25.102 [1] section 9.

**Table 9.3.11.1: Test parameters for fixed reference measurement channels for Category 25 UE class**

Parameters	Unit	Test 1	Test 2	Test 3	Test 4
HS-PDSCH Modulation	-	QPSK		16QAM	
Scrambling code and basic midamble code number*	-	0			
Number of TS	-	3			
Number of Hybrid ARQ processes per stream	-	4			
Maximum number of Hybrid ARQ transmissions	-	4			
HS-PDSCH Channelization Codes*	C(k,Q)	C(i,16) i=1..16		C(i,16) i=1..16	
Redundancy and constellation version coding sequence	-	{0,0,0,0}		{6,2,1,5}	
$\frac{HS - PDSCH - E_c}{I_{or}}$	dB	-12.04		-12.04	
Stream Number Configuration	-	Fixed Dual Stream	Fixed Single Stream (2 <sup>nd</sup> Stream is not used)	Fixed Dual Stream	Fixed Single Stream (2 <sup>nd</sup> Stream is not used)
loc	dBm/ 1.28MH Z	-60			
*Note: Refer to TS 25.223 for definition of channelization codes, scrambling code and basic midamble code.					

**Table 9.3.11.2: Performance requirements for fixed reference channels for Category 25 UE class**

Test Number	Propagation conditions	$\frac{\hat{I}_{or}}{I_{oc}}$ [dB]	R (Throughput) [kbps]
1	PA3	10	390
2	PA3	6	160
3	PA3	16	860
4	PA3	12	370

### 9.3.11.3 Test purpose

To verify that the MIMO configured UE receiver is capable meeting the minimum requirements for support of HSDPA in the conditions defined below, for QPSK and 16QAM modulation.

### 9.3.11.4 Method of test

#### 9.3.11.4.1 Initial conditions

Test environment: normal; see clauses G.2.1 and G.2.2.

Frequencies to be tested: mid range; see clause G.2.4.

- 1) Connect SS, multipath fading simulator and an AWGN source to the UE antenna connector as shown in figure A..11010a8
- 2) Set Ack/Nack/ DTX handling at the SS as table 9.3.1.1, Setup fading simulators as fading conditions, which are described in table D.2.2.1.A.
- 3) Set up a HSDPA connection according to the Generic HSDPA setup procedure. See TS 34.108 [3] and TS 34.109 [4] for details regarding generic HSDPA setup procedure.



- 4) Set the test parameters according to above tables of test parameters. The configuration of the downlink channels is defined in table C.4.2.

#### 9.3.11.4.2 Procedure

- 1) Once the HSDPA connection is setup, start transmitting HSDPA Data.
- 2) The information bit data shall be pseudo random and not repeated not before 10 different information bit payload blocks are processed. (e.g. Fixed reference Channel Definition (16 QAM): The information bit payload block is 3650 bits long. Hence the PRBSequence must be at least 3650 \* 10 bits long. ) Use a PRBS from ITU-R O.153 Ref [26].
- 3) For all relevant propagation conditions, count the number of NACK, ACK and statDTX on the UL HS-SICH during the test interval and decide pass or fail according to Annex F.6.3 tables F.6.3.5.1 and F.6.3.5.2.

#### 9.3.11.5 Test Requirements

Tables of test parameters define the primary level settings including test tolerance for all relevant throughput tests. the measured throughput shall be equal to or better than the the specified value in tables above of test requirement.

**Table 9.3.11.3: Test requirements for fixed reference channels for Category 25 UE class**

Test Number	Propagation conditions	$\frac{\hat{I}_{or}}{I_{oc}}$ [dB]	R (Throughput) [kbps]
1	PA3	10.6	390
2	PA3	6.6	160
3	PA3	16.6	860
4	PA3	12.6	370

The pass / fail decision for throughput is done according to Annex F.6.3.

### 9.3.1J HS-DSCH throughput for Fixed Reference Channels –MIMO UE Category 26

#### 9.3.1J.1 Definition and applicability

The HS-DSCH data throughput for fixed reference channels is defined by the capabilities of the UE as defined in [24] , and the throughput is measured by counting the amount of data successfully received at the UE by monitoring the ACK/NACK signalling field of the HS-SICH received at the SS, while random data is streamed from the SS to the UE.

The normative reference for this test is 25.102 [1], section 9.

The requirements and tests for category 26 apply to 1,28 Mcps TDD UEs from release 8 and later that MIMO is configured.

If MIMO is not configured, a category 26 UE should have the capability of category 21

#### 9.3.1J.2 Minimum requirements

For the parameters specified in below tables the measured throughput shall be equal to or better than the the specified value in belows tables specified the performance requirement. The reference for this requirement is TS 25.102 [1] section 9.

**Table 9.3.1J.1: Test parameters for fixed reference measurement channels for Category 26 UE class**

Parameters	Unit	Test 1	Test 2	Test 3	Test 4
HS-PDSCH Modulation	-	QPSK		16QAM	
Scrambling code and basic midamble code number*	-	0			
Number of TS	-	4			
Number of Hybrid ARQ processes per stream	-	4			
Maximum number of Hybrid ARQ transmissions	-	4			
HS-PDSCH Channelization Codes*	C(k,Q)	C(i,16) i=1..16		C(i,16) i=1..16	
Redundancy and constellation version coding sequence	-	{0,0,0,0}		{6,2,1,5}	
$\frac{HS - PDSCH - E_c}{I_{or}}$	dB	-12.04		-12.04	
Stream Number Configuration	-	Fixed Dual Stream	Fixed Single Stream (2 <sup>nd</sup> Stream is not used)	Fixed Dual Stream	Fixed Single Stream (2 <sup>nd</sup> Stream is not used)
loc	dBm/ 1.28MH Z	-60			
*Note: Refer to TS 25.223 for definition of channelization codes, scrambling code and basic midamble code.					

**Table 9.3.1J.2: Performance requirements for fixed reference channels for Category 26 UE class**

Test Number	Propagation conditions	$\frac{\hat{I}_{or}}{I_{oc}}$ [dB]	R (Throughput) [kbps]
1	PA3	10	650
2	PA3	6	220
3	PA3	16	950
4	PA3	12	380

### 9.3.1J.3 Test purpose

To verify that the MIMO configured UE receiver is capable meeting the minimum requirements for support of HSDPA in the conditions defined below, for QPSK and 16QAM modulation.

### 9.3.1J.4 Method of test

#### 9.3.1J.4.1 Initial conditions

Test environment: normal; see clauses G.2.1 and G.2.2.

Frequencies to be tested: mid range; see clause G.2.4.

- 1) Connect SS, multipath fading simulator and an AWGN source to the UE antenna connector as shown in figure A.10aA.18

- 2) Set Ack/Nack/ DTX handling at the SS as table 9.3.1.1, Setup fading simulators as fading conditions, which are described in table D.2.2.1.A.
- 3) Set up a HSDPA connection according to the Generic HSDPA setup procedure. See TS 34.108 [3] and TS 34.109 [4] for details regarding generic HSDPA setup procedure.
- 4) Set the test parameters according to above tables of test parameters. The configuration of the downlink channels is defined in table C.4.2.

#### 9.3.1J.4.2 Procedure

- 1) Once the HSDPA connection is setup, start transmitting HSDPA Data.
- 2) The information bit data shall be pseudo random and not repeated not before 10 different information bit payload blocks are processed. Use a PRBS from ITU-R O.153 Ref [26].
- 3) For all relevant propagation conditions, count the number of NACK, ACK and statDTX on the UL HS-SICH during the test interval and decide pass or fail according to Annex F.6.3 tables F.6.3.5.1 and F.6.3.5.2.

#### 9.3.1J.5 Test Requirements

Tables of test parameters define the primary level settings including test tolerance for all relevant throughput tests. the measured throughput shall be equal to or better than the the specified value in tables above of test requirement.

**Table 9.3.1J.3: Test requirements for fixed reference channels for Category 26 UE class**

Test Number	Propagation conditions	$\frac{\hat{I}_{or}}{I_{oc}}$ [dB]	R (Throughput) [kbps]
1	PA3	10.6	650
2	PA3	6.6	220
3	PA3	16.6	950
4	PA3	12.6	380

The pass / fail decision for throughput is done according to Annex F.6.3.

### 9.3.1K HS-DSCH throughput for Fixed Reference Channels –MIMO UE Category 27

#### 9.3.1K.1 Definition and applicability

The HS-DSCH data throughput for fixed reference channels is defined by the capabilities of the UE as defined in [24], and the throughput is measured by counting the amount of data successfully received at the UE by monitoring the ACK/NACK signalling field of the HS-SICH received at the SS, while random data is streamed from the SS to the UE.

The normative reference for this test is 25.102 [1], section 9.

The requirements and tests for category 27 apply to 1,28 Mcps TDD UEs from release 8 and later that MIMO is configured.

If MIMO is not configured, a category 27 UE should have the capability of category 24

#### 9.3.1K.2 Minimum requirements

For the parameters specified in below tables the measured throughput shall be equal to or better than the the specified value in belows tables specified the performance requirement. The reference for this requirement is TS 25.102 [1] section 9.

**Table 9.3.1K.1: Test parameters for fixed reference measurement channels for Category 27 UE class**

Parameters	Unit	Test 1	Test 2	Test 3	Test 4
HS-PDSCH Modulation	-	QPSK		16QAM	
Scrambling code and basic midamble code number*	-	0			
Number of TS	-	5			
Number of Hybrid ARQ processes per stream	-	4			
Maximum number of Hybrid ARQ transmissions	-	4			
HS-PDSCH Channelization Codes*	C(k,Q)	C(i,16) i=1..16		C(i,16) i=1..16	
Redundancy and constellation version coding sequence	-	{0,0,0,0}		{6,2,1,5}	
$\frac{HS - PDSCH - E_c}{I_{or}}$	dB	-12.04		-12.04	
Stream Number Configuration	-	Fixed Dual Stream	Fixed Single Stream (2 <sup>nd</sup> Stream is not used)	Fixed Dual Stream	Fixed Single Stream (2 <sup>nd</sup> Stream is not used)
loc	dBm/ 1.28MH Z	-60			
*Note: Refer to TS 25.223 for definition of channelization codes, scrambling code and basic midamble code.					

**Table 9.3.1K.2: Performance requirements for fixed reference channels for Category 27 UE class**

Test Number	Propagation conditions	$\frac{\hat{I}_{or}}{I_{oc}}$ [dB]	R (Throughput) [kbps]
1	PA3	10	850
2	PA3	6	280
3	PA3	16	1200
4	PA3	12	500

### 9.3.1K.3 Test purpose

To verify that the MIMO configured UE receiver is capable meeting the minimum requirements for support of HSDPA in the conditions defined below, for QPSK and 16QAM modulation.

### 9.3.1K.4 Method of test

#### 9.3.1K.4.1 Initial conditions

Test environment: normal; see clauses G.2.1 and G.2.2.

Frequencies to be tested: mid range; see clause G.2.4.

- 1) Connect SS, multipath fading simulator and an AWGN source to the UE antenna connector as shown in figure A.10aA.18

- 2) Set Ack/Nack/ DTX handling at the SS as table 9.3.1.1, Setup fading simulators as fading conditions, which are described in table D.2.2.1.A.
- 3) Set up a HSDPA connection according to the Generic HSDPA setup procedure. See TS 34.108 [3] and TS 34.109 [4] for details regarding generic HSDPA setup procedure.
- 4) Set the test parameters according to above tables of test parameters. The configuration of the downlink channels is defined in table C.4.2.

#### 9.3.1K.4.2 Procedure

- 1) Once the HSDPA connection is setup, start transmitting HSDPA Data.
- 2) The information bit data shall be pseudo random and not repeated not before 10 different information bit payload blocks are processed. Use a PRBS from ITU-R O.153 Ref [26].
- 3) For all relevant propagation conditions, count the number of NACK, ACK and statDTX on the UL HS-SICH during the test interval and decide pass or fail according to Annex F.6.3 tables F.6.3.5.1 and F.6.3.5.2.

#### 9.3.1K.5 Test Requirements

Tables of test parameters define the primary level settings including test tolerance for all relevant throughput tests. the measured throughput shall be equal to or better than the the specified value in tables above of test requirement.

**Table 9.3.1K.3: Test requirements for fixed reference channels for Category 27 UE class**

Test Number	Propagation conditions	$\frac{\hat{I}_{or}}{I_{oc}}$ [dB]	R (Throughput) [kbps]
1	PA3	10.6	850
2	PA3	6.6	280
3	PA3	16.6	1200
4	PA3	12.6	500

The pass / fail decision for throughput is done according to Annex F.6.3.

### 9.3.1L HS-DSCH throughput for Fixed Reference Channels –MIMO UE Category 28

#### 9.3.1L.1 Definition and applicability

The HS-DSCH data throughput for fixed reference channels is defined by the capabilities of the UE as defined in [24], and the throughput is measured by counting the amount of data successfully received at the UE by monitoring the ACK/NACK signalling field of the HS-SICH received at the SS, while random data is streamed from the SS to the UE.

The normative reference for this test is 25.102 [1], section 9.

The requirements and tests for category 28 apply to 1,28 Mcps TDD UEs from release 8 and later that MIMO is configured.

#### 9.3.1L.2 Minimum requirements

For the parameters specified in below tables the measured throughput shall be equal to or better than the the specified value in belows tables specified the performance requirement. The reference for this requirement is TS 25.102 [1] section 9.

**Table 9.3.1L.1: Test parameters for fixed reference measurement channels for Category 28 UE class**

Parameters	Unit	Test 1	Test 2
HS-PDSCH Modulation	-	64QAM	
Scrambling code and basic midamble code number*	-	0	
Number of TS	-	3	
Number of Hybrid ARQ processes per stream	-	4	
Maximum number of Hybrid ARQ transmissions	-	4	
HS-PDSCH Channelization Codes*	C(k,Q)	C(i,16) i=1..16	
Redundancy and constellation version coding sequence	-	{6,5,4,0}	
$\frac{HS - PDSCH - E_c}{I_{or}}$	dB	-12.04	
Stream Number Configuration	-	Fixed Dual Stream	Fixed Single Stream (2 <sup>nd</sup> Stream is not used)
loc	dBm/ 1.28MH z	-60	
*Note: Refer to TS 25.223 for definition of channelization codes, scrambling code and basic midamble code.			

**Table 9.3.1L.2: Performance requirements for fixed reference channels for Category 28 UE class**

Test Number	Propagation conditions	$\frac{\hat{I}_{or}}{I_{oc}}$ [dB]	R (Throughput) [kbps]
1	PA3	20	800
2	PA3	18	540

### 9.3.1L.3 Test purpose

To verify that the MIMO configured UE receiver is capable meeting the minimum requirements for support of HSDPA in the conditions defined below, for 64QAM modulation.

### 9.3.1L.4 Method of test

#### 9.3.1L.4.1 Initial conditions

Test environment: normal; see clauses G.2.1 and G.2.2.

Frequencies to be tested: mid range; see clause G.2.4.

- 1) Connect SS, multipath fading simulator and an AWGN source to the UE antenna connector as shown in figure A.10aA.18
- 2) Set Ack/Nack/ DTX handling at the SS as table 9.3.1.1, Setup fading simulators as fading conditions, which are described in table D.2.2.1.A.
- 3) Set up a HSDPA connection according to the Generic HSDPA setup procedure. See TS 34.108 [3] and TS 34.109 [4] for details regarding generic HSDPA setup procedure.

- 4) Set the test parameters according to above tables of test parameters. The configuration of the downlink channels is defined in table C.4.2.

#### 9.3.1L.4.2 Procedure

- 1) Once the HSDPA connection is setup, start transmitting HSDPA Data.
- 2) The information bit data shall be pseudo random and not repeated not before 10 different information bit payload blocks are processed. Use a PRBS from ITU-R O.153 Ref [26].
- 3) For all relevant propagation conditions, count the number of NACK, ACK and statDTX on the UL HS-SICH during the test interval and decide pass or fail according to Annex F.6.3 tables F.6.3.5.1 and F.6.3.5.2.

#### 9.3.1L.5 Test Requirements

Tables of test parameters define the primary level settings including test tolerance for all relevant throughput tests. the measured throughput shall be equal to or better than the the specified value in tables above of test requirement.

**Table 9.3.1L.3: Performance requirements for fixed reference channels for Category 28 UE class**

Test Number	Propagation conditions	$\frac{\hat{I}_{or}}{I_{oc}}$ [dB]	R (Throughput) [kbps]
1	PA3	20.6	800
2	PA3	18.6	540

The pass / fail decision for throughput is done according to Annex F.6.3.

### 9.3.1M HS-DSCH throughput for Fixed Reference Channels –MIMO UE CategoriesCategory 29

#### 9.3.1M.1 Definition and applicability

The HS-DSCH data throughput for fixed reference channels is defined by the capabilities of the UE as defined in [24], and the throughput is measured by counting the amount of data successfully received at the UE by monitoring the ACK/NACK signalling field of the HS-SICH received at the SS, while random data is streamed from the SS to the UE.

The normative reference for this test is 25.102 [1], section 9.

The requirements and tests for category 29 apply to 1,28 Mcps TDD UEs from release 8 and later that MIMO is configured.

#### 9.3.1M.2 Minimum requirements

For the parameters specified in below tables the measured throughput shall be equal to or better than the the specified value in belows tables specified the performance requirement. The reference for this requirement is TS 25.102 [1] section 9.

**Table 9.3.1M.1: Test parameters for fixed reference measurement channels for Category 29 UE class**

Parameters	Unit	Test 1	Test 2
HS-PDSCH Modulation	-	64QAM	
Scrambling code and basic midamble code number*	-	0	
Number of TS	-	4	
Number of Hybrid ARQ processes per stream	-	4	
Maximum number of Hybrid ARQ transmissions	-	4	
HS-PDSCH Channelization Codes*	C(k,Q)	C(i,16) i=1..16	
Redundancy and constellation version coding sequence	-	{6,5,4,0}	
$\frac{HS - PDSCH - E_c}{I_{or}}$	dB	-12.04	
Stream Number Configuration	-	Fixed Dual Stream	Fixed Single Stream (2 <sup>nd</sup> Stream is not used)
loc	dBm/ 1.28MH z	-60	
*Note: Refer to TS 25.223 for definition of channelization codes, scrambling code and basic midamble code.			

**Table 9.3.1M.2: Performance requirements for fixed reference channels for Category 29 UE class**

Test Number	Propagation conditions	$\frac{\hat{I}_{or}}{I_{oc}}$ [dB]	R (Throughput) [kbps]
1	PA3	20	1200
2	PA3	18	780

### 9.3.1M.3 Test purpose

To verify that the MIMO configured UE receiver is capable meeting the minimum requirements for support of HSDPA in the conditions defined below, for 64QAM modulation.

### 9.3.1M.4 Method of test

#### 9.3.1M.4.1 Initial conditions

Test environment: normal; see clauses G.2.1 and G.2.2.

Frequencies to be tested: mid range; see clause G.2.4.

- 1) Connect SS, multipath fading simulator and an AWGN source to the UE antenna connector as shown in figure A.18
- 2) Set Ack/Nack/ DTX handling at the SS as table 9.3.1.1, Setup fading simulators as fading conditions, which are described in table D.2.2.1.A.
- 3) Set up a HSDPA connection according to the Generic HSDPA setup procedure. See TS 34.108 [3] and TS 34.109 [4] for details regarding generic HSDPA setup procedure.
- 4) Set the test parameters according to above tables of test parameters. The configuration of the downlink channels is defined in table C.4.2.



### 9.3.1M.4.2 Procedure

- 1) Once the HSDPA connection is setup, start transmitting HSDPA Data.
- 2) The information bit data shall be pseudo random and not repeated not before 10 different information bit payload blocks are processed. Use a PRBS from ITU-R O.153 Ref [26].
- 3) For all relevant propagation conditions, count the number of NACK, ACK and statDTX on the UL HS-SICH during the test interval and decide pass or fail according to Annex F.6.3 tables F.6.3.5.1 and F.6.3.5.2.

### 9.3.1M.5 Test Requirements

Tables of test parameters define the primary level settings including test tolerance for all relevant throughput tests. the measured throughput shall be equal to or better than the the specified value in tables above of test requirement.

**Table 9.3.1M.3: Performance requirements for fixed reference channels for Category 28 UE class**

Test Number	Propagation conditions	$\frac{\hat{I}_{or}}{I_{oc}}$ [dB]	R (Throughput) [kbps]
1	PA3	20.6	1200
2	PA3	18.6	780

The pass / fail decision for throughput is done according to Annex F.6.3.

## 9.3.1N HS-DSCH throughput for Fixed Reference Channels –MIMO UE Categories Category 30

### 9.3.1N.1 Definition and applicability

The HS-DSCH data throughput for fixed reference channels is defined by the capabilities of the UE as defined in [24], and the throughput is measured by counting the amount of data successfully received at the UE by monitoring the ACK/NACK signalling field of the HS-SICH received at the SS, while random data is streamed from the SS to the UE.

The normative reference for this test is 25.102 [1], section 9.

The requirements and tests for category 30 apply to 1,28 Mcps TDD UEs from release 8 and later that MIMO is configured.

### 9.3.1N.2 Minimum requirements

For the parameters specified in below tables the measured throughput shall be equal to or better than the the specified value in belows tables specified the performance requirement. The reference for this requirement is TS 25.102 [1] section 9.

**Table 9.3.1N.1: Test parameters for fixed reference measurement channels for Category 30 UE class**

Parameters	Unit	Test 1	Test 2
HS-PDSCH Modulation	-	64QAM	
Scrambling code and basic midamble code number*	-	0	
Number of TS	-	5	
Number of Hybrid ARQ processes per stream	-	4	
Maximum number of Hybrid ARQ transmissions	-	4	
HS-PDSCH Channelization Codes*	C(k,Q)	C(i,16) i=1..16	
Redundancy and constellation version coding sequence	-	{6,5,4,0}	
$\frac{HS - PDSCH - E_c}{I_{or}}$	dB	-12.04	
Stream Number Configuration	-	Fixed Dual Stream	Fixed Single Stream (2 <sup>nd</sup> Stream is not used)
loc	dBm/ 1.28MH z	-60	
*Note: Refer to TS 25.223 for definition of channelization codes, scrambling code and basic midamble code.			

**Table 9.3.1N.2: Performance requirements for fixed reference channels for Category 30 UE class**

Test Number	Propagation conditions	$\frac{\hat{I}_{or}}{I_{oc}}$ [dB]	R (Throughput) [kbps]
1	PA3	20	1570
2	PA3	18	1000

### 9.3.1N.3 Test purpose

To verify that the MIMO configured UE receiver is capable meeting the minimum requirements for support of HSDPA in the conditions defined below, for 64QAM modulation.

### 9.3.1N.4 Method of test

#### 9.3.1N.4.1 Initial conditions

Test environment: normal; see clauses G.2.1 and G.2.2.

Frequencies to be tested: mid range; see clause G.2.4.

- 1) Connect SS, multipath fading simulator and an AWGN source to the UE antenna connector as shown in figure A.18
- 2) Set Ack/Nack/ DTX handling at the SS as table 9.3.1.1, Setup fading simulators as fading conditions, which are described in table D.2.2.1.A.
- 3) Set up a HSDPA connection according to the Generic HSDPA setup procedure. See TS 34.108 [3] and TS 34.109 [4] for details regarding generic HSDPA setup procedure.

- 4) Set the test parameters according to above tables of test parameters. The configuration of the downlink channels is defined in table C.4.2.

#### 9.3.1N.4.2 Procedure

- 1) Once the HSDPA connection is setup, start transmitting HSDPA Data.
- 2) The information bit data shall be pseudo random and not repeated not before 10 different information bit payload blocks are processed. Use a PRBS from ITU-R O.153 Ref [26].
- 3) For all relevant propagation conditions, count the number of NACK, ACK and statDTX on the UL HS-SICH during the test interval and decide pass or fail according to Annex F.6.3 tables F.6.3.5.1 and F.6.3.5.2.

#### 9.3.1N.5 Test Requirements

Tables of test parameters define the primary level settings including test tolerance for all relevant throughput tests. the measured throughput shall be equal to or better than the the specified value in tables above of test requirement.

**Table 9.3.1N.3: Performance requirements for fixed reference channels for Category 28 UE class**

Test Number	Propagation conditions	$\frac{\hat{I}_{or}}{I_{oc}}$ [dB]	R (Throughput) [kbps]
1	PA3	20.6	1570
2	PA3	18.6	1000

The pass / fail decision for throughput is done according to Annex F.6.3.

### 9.3.2 HS-DSCH throughput for Variable Reference Channels

The overall performance metric for HS-DSCH requirements is the throughput “R” measured on HS-DSCH.

#### 9.3.2A HS-DSCH throughput for Variable Reference Channels 0.5 Mbps UE class

##### 9.3.2A.1 Definition and applicability

The HS-DSCH data throughput for variable reference channels is defined by the capabilities of the UE as defined in [24], and the throughput is measured by counting the amount of data successfully received at the UE by monitoring the ACK/NACK signalling field of the HS-SICH received at the SS, while random data is streamed from the SS to the UE.

The normative reference for this test is 25.102 [2], section 9.

The requirements and this test apply to 1,28 Mcps TDD UE from release 5 and later that support HSDPA which is 0.5Mbps UE class.

##### 9.3.2A.2 Minimum requirements

For the parameters specified in tables 9.3.2A.1 the measured throughput shall be equal to or better than the the specified value in table 9.3.2A.2. The reference for this requirement is TS 25.102 [1] section 9.

**Table 9.3.2A.1: Test parameters for variable reference measurement channel requirements for 0.5 Mbps UE class**

Parameter	Unit	Test 1	Test 2	Test 3
HS-PDSCH Modulation and TBS	-		*	
Scrambling code and basic midamble code Number **	-		1	
Midamble			Common midamble	
Number of TS****	-		2	
Number of DPCH <sub>o</sub>	-		0	
Number of HARQ Process	-		4	
Number of transmission	-		1	
Redundancy and constellation version coding sequence	Xrv		0	
HS-PDSCH Channelization Codes**	C(k,Q)		C(i,16) 1≤i≤10	
HS-PDSCH <sub>i</sub> Ec/Ior	dB		-10	
loc	dBm		-60	
* Note 1	As requested by the last received CQI report			
**Note 2	Refer to TS 25.223 for definition of channelization codes, scrambling code and basic midamble code.			
***Note 3	If the indicated CQI is 0, the Node-B emulator shall format the next HS-PDSCH transmission with the transport block size and the modulation scheme that were previously used.			
****Note:	The timeslot just after the second switch point should be included.			

**Table 9.3.2A.2: Minimum performance requirements for variable reference measurement channel requirement in multipath channels for 0.5 Mbps UE class**

Test Number	Propagation conditions	$\frac{\hat{I}_{or}}{I_{oc}}$ [dB]	R (Throughput) [kbps]
1	PA3	15	242
2	PB3	15	244
3	VA30	15	211

### 9.3.2A.3 Test purpose

To verify that the UE receiver is capable meeting the minimum requirements for support of HSDPA in the conditions defined in table 9.3.2A.1, with the selection of QPSK and 16QAM modulation, and appropriate blocksize being determined by the SS based on the CQI reported by the UE.

### 9.3.2A.4 Method of test

#### 9.3.2A.4.1 Initial conditions

Test environment: normal; see clauses G.2.1 and G.2.2.

Frequencies to be tested: mid range; see clause G.2.4.

- 1) Connect SS, multipath fading simulator and an AWGN source to the UE antenna connector as shown in figure A.10.
- 2) Set Ack/Nack/DTX handling at the SS such that regardless of the response from the UE (Ack, Nack or DTX) new data is sent each time, this is because HARQ transmissions are set to one, i.e. no re-transmission of failed blocks.
- 3) Setup fading simulators as fading conditions, which are described in table D.2.2.1.A.

- 4) Set up a HSDPA connection according to the Generic HSDPA setup procedure, See TS 34.108 [3] and TS 34.109 [4] for details regarding generic HSDPA setup procedure.
- 5) Set the test parameters for tests according to above tables of test parameters
- 6) The information bit data shall be pseudo random and not repeated not before 10 different information bit payload blocks are processed. Use a PRBS from ITU-R O.153 Ref [26].

#### 9.3.2A.4.2 Procedure

- 1) Once the HSDPA connection is setup, start transmitting HSDPA Data.

The SS shall transmit a HSDPA block to UE selecting any TBS value excluding 0 or 63 (the first HSDPA block size isn't recorded), then SS will decode the CQI report and transmit a new block on the HS-DSCH with the transport block size and modulation scheme recommended by the UE.

- 2) For any HSDPA block transmitted by the SS, record transmitted block size and relevant received ACK, NACK and statDTX reported by UE. If UE reports ACK, the transmitted block is correctly received by UE. Continue transmission of the HS-PDSCH data and record transmitted block size until [2000] records have been reached.
- 3) For all relevant propagation conditions, calculate the throughput, which is the ratio of the sum of correctly received transport bits over the testing time. [2000] multiplied by transmission time interval is the testing time.

#### 9.3.2A.5 Test Requirements

Tables of test parameters define the primary level settings including test tolerance for all relevant throughput tests. The measured throughput shall be equal to or better than the specified value in table 9.3.2A.3 of test requirement.

**Table 9.3.2A.3: Test requirements for variable reference measurement channel requirement in multipath channels for 0.5 Mbps UE class**

Test Number	Propagation conditions	$\frac{\hat{I}_{or}}{I_{oc}}$ [dB]	R (Throughput) [kbps]
1	PA3	15.6	242
2	PB3	15.6	244
3	VA30	15.6	211

### 9.3.2B HS-DSCH throughput for Variable Reference Channels 1.1 Mbps UE class

#### 9.3.2B.1 Definition and applicability

The HS-DSCH data throughput for variable reference channels is defined by the capabilities of the UE as defined in [24], and the throughput is measured by counting the amount of data successfully received at the UE by monitoring the ACK/NACK signalling field of the HS-SICH received at the SS, while random data is streamed from the SS to the UE.

The normative reference for this test is 25.102 [2], section 9.

The requirements and this test apply to 1,28 Mcps TDD UE from release 5 and later that support HSDPA which is 1.1Mbps UE class.

#### 9.3.2B.2 Minimum requirements

For the parameters specified in tables 9.3.2B.1 the measured throughput shall be equal to or better than the specified value in table 9.3.2B.2. The reference for this requirement is TS 25.102 [1] section 9.

**Table 9.3.2B.1: Test parameters for variable reference measurement channel requirements for 1.1 Mbps UE class**

Parameter	Unit	Test 1	Test 2	Test 3
HS-PDSCH Modulation and TBS	-		*	
Scrambling code and basic midamble code Number **	-		1	
Midamble			Common midamble	
Number of TS****	-		2	
Number of DPCH <sub>0</sub>	-		0	
Number of HARQ Process	-		4	
Number of transmission	-		1	
Redundancy and constellation version coding sequence	Xrv		0	
HS-PDSCH Channelization Codes**	C(k,Q)		C(i,16) 1≤i≤10	
HS-PDSCH <sub>i</sub> Ec/I <sub>0</sub>	dB		-10	
loc	dBm		-60	
* Note 1	As requested by the last received CQI report			
**Note 2	Refer to TS 25.223 for definition of channelization codes, scrambling code and basic midamble code.			
***Note 3	If the indicated CQI is 0, the Node-B emulator shall format the next HS-PDSCH transmission with the transport block size and the modulation scheme that were previously used.			
****Note:	The timeslot just after the second switch point should be included.			

**Table 9.3.2B.2: Minimum performance requirements for variable reference measurement channel requirement in multipath channels for 1.1 Mbps UE class**

Test Number	Propagation conditions	$\frac{\hat{I}_{or}}{I_{oc}}$ [dB]	R (Throughput) [kbps]
1	PA3	15	318
2	PB3	15	323
3	VA30	15	213

### 9.3.2B.3 Test purpose

To verify that the UE receiver is capable meeting the minimum requirements for support of HSDPA in the conditions defined in table 9.3.2B.1, with the selection of QPSK and 16QAM modulation, and appropriate blocksize being determined by the SS based on the CQI reported by the UE.

### 9.3.2B.4 Method of test

#### 9.3.2B.4.1 Initial conditions

Test environment: normal; see clauses G.2.1 and G.2.2.

Frequencies to be tested: mid range; see clause G.2.4.

- 1) Connect SS, multipath fading simulator and an AWGN source to the UE antenna connector as shown in figure A.10.
- 2) Set Ack/Nack/DTX handling at the SS such that regardless of the response from the UE (Ack, Nack or DTX) new data is sent each time, this is because HARQ transmissions are set to one, i.e. no re-transmission of failed blocks.
- 3) Setup fading simulators as fading conditions, which are described in table D.2.2.1.A.

- 4) Set up a HSDPA connection according to the Generic HSDPA setup procedure, See TS 34.108 [3] and TS 34.109 [4] for details regarding generic HSDPA setup procedure.
- 5) Set the test parameters for tests according to above tables of test parameters
- 6) The information bit data shall be pseudo random and not repeated not before 10 different information bit payload blocks are processed. Use a PRBS from ITU-R O.153 Ref [26].

#### 9.3.2B.4.2 Procedure

- 1) Once the HSDPA connection is setup, start transmitting HSDPA Data.

The SS shall transmit a HSDPA block to UE selecting any TBS value excluding 0 or 63 (the first HSDPA block size isn't recorded), then SS will decode the CQI report and transmit a new block on the HS-DSCH with the transport block size and modulation scheme recommended by the UE.

- 2) For any HSDPA block transmitted by the SS, record transmitted block size and relevant received ACK, NACK and statDTX reported by UE. If UE reports ACK, the transmitted block is correctly received by UE. Continue transmission of the HS-PDSCH data and record transmitted block size until [2000] records have been reached.
- 3) For all relevant propagation conditions, calculate the throughput, which is the ratio of the sum of correctly received transport bits over the testing time. [2000] multiplied by transmission time interval is the testing time.

#### 9.3.2B.5 Test Requirements

Tables of test parameters define the primary level settings including test tolerance for all relevant throughput tests. the measured throughput shall be equal to or better than the the specified value in table 9.3.2B.3 of test requirement.

**Table 9.3.2B.3: Test requirements for variable reference measurement channel requirement in multipath channels for 1.1 Mbps UE class**

Test Number	Propagation conditions	$\frac{\hat{I}_{or}}{I_{oc}}$ [dB]	R (Throughput) [kbps]
1	PA3	15.6	318
2	PB3	15.6	323
3	VA30	15.6	213

### 9.3.2C HS-DSCH throughput for Variable Reference Channels 1.6 Mbps UE class

#### 9.3.2C.1 Definition and applicability

The HS-DSCH data throughput for variable reference channels is defined by the capabilities of the UE as defined in [24], and the throughput is measured by counting the amount of data successfully received at the UE by monitoring the ACK/NACK signalling field of the HS-SICH received at the SS, while random data is streamed from the SS to the UE.

The normative reference for this test is 25.102 [2], section 9.

The requirements and this test apply to 1,28 Mcps TDD UE from release 5 and later that support HSDPA which is 1.6Mbps UE class.

#### 9.3.2C.2 Minimum requirements

For the parameters specified in tables 9.3.2C.1 the measured throughput shall be equal to or better than the the specified value in table 9.3.2C.2. The reference for this requirement is TS 25.102 [1] section 9.

**Table 9.3.2C.1: Test parameters for variable reference measurement channel requirements for 1.6 Mbps UE class**

Parameter	Unit	Test 1	Test 2	Test 3
HS-PDSCH Modulation and TBS	-		*	
Scrambling code and basic midamble code Number **	-		1	
Midamble			Common midamble	
Number of TS****	-		3	
Number of DPCH <sub>0</sub>	-		0	
Number of HARQ Process	-		4	
Number of transmission	-		1	
Redundancy and constellation version coding sequence	Xrv		0	
HS-PDSCH Channelization Codes**	C(k,Q)		C(i,16) 1≤i≤10	
HS-PDSCH <sub>i</sub> Ec/Ior	dB		-10	
loc	dBm		-60	
* Note 1	As requested by the last received CQI report			
**Note 2	Refer to TS 25.223 for definition of channelization codes, scrambling code and basic midamble code.			
***Note 3	If the indicated CQI is 0, the Node-B emulator shall format the next HS-PDSCH transmission with the transport block size and the modulation scheme that were previously used.			
****Note:	The timeslot just after the second switch point should be included.			

**Table 9.3.2C.2: Minimum performance requirements for variable reference measurement channel requirement in multipath channels for 1.6 Mbps UE class**

Test Number	Propagation conditions	$\frac{\hat{I}_{or}}{I_{oc}}$ [dB]	R (Throughput) [kbps]
1	PA3	15	480
2	PB3	15	483
3	VA30	15	323

### 9.3.2C.3 Test purpose

To verify that the UE receiver is capable meeting the minimum requirements for support of HSDPA in the conditions defined in table 9.3.2C.1, with the selection of QPSK and 16QAM modulation, and appropriate blocksize being determined by the SS based on the CQI reported by the UE.

### 9.3.2C.4 Method of test

#### 9.3.2C.4.1 Initial conditions

Test environment: normal; see clauses G.2.1 and G.2.2.

Frequencies to be tested: mid range; see clause G.2.4.

- 1) Connect SS, multipath fading simulator and an AWGN source to the UE antenna connector as shown in figure A.10.
- 2) Set Ack/Nack/DTX handling at the SS such that regardless of the response from the UE (Ack, Nack or DTX) new data is sent each time, this is because HARQ transmissions are set to one, i.e. no re-transmission of failed blocks.
- 3) Setup fading simulators as fading conditions, which are described in table D.2.2.1.A.



- 4) Set up a HSDPA connection according to the Generic HSDPA setup procedure, See TS 34.108 [3] and TS 34.109 [4] for details regarding generic HSDPA setup procedure.
- 5) Set the test parameters for tests according to above tables of test parameters
- 6) The information bit data shall be pseudo random and not repeated not before 10 different information bit payload blocks are processed. Use a PRBS from ITU-R O.153 Ref [26].

#### 9.3.2C.4.2 Procedure

- 1) Once the HSDPA connection is setup, start transmitting HSDPA Data.

The SS shall transmit a HSDPA block to UE selecting any TBS value excluding 0 or 63 (the first HSDPA block size isn't recorded), then SS will decode the CQI report and transmit a new block on the HS-DSCH with the transport block size and modulation scheme recommended by the UE.

- 2) For any HSDPA block transmitted by the SS, record transmitted block size and relevant received ACK, NACK and statDTX reported by UE. If UE reports ACK, the transmitted block is correctly received by UE. Continue transmission of the HS-PDSCH data and record transmitted block size until [2000] records have been reached.
- 3) For all relevant propagation conditions, calculate the throughput, which is the ratio of the sum of correctly received transport bits over the testing time. [2000] multiplied by transmission time interval is the testing time.

#### 9.3.2C.5 Test Requirements

Tables of test parameters define the primary level settings including test tolerance for all relevant throughput tests. the measured throughput shall be equal to or better than the the specified value in table 9.3.2C.3 of test requirement.

**Table 9.3.2C.3: Test requirements for variable reference measurement channel requirement in multipath channels for 1.6 Mbps UE class**

Test Number	Propagation conditions	$\frac{\hat{I}_{or}}{I_{oc}}$ [dB]	R (Throughput) [kbps]
1	PA3	15.6	480
2	PB3	15.6	483
3	VA30	15.6	323

### 9.3.2D HS-DSCH throughput for Variable Reference Channels 2.2 Mbps UE class

#### 9.3.2D.1 Definition and applicability

The HS-DSCH data throughput for variable reference channels is defined by the capabilities of the UE as defined in [24], and the throughput is measured by counting the amount of data successfully received at the UE by monitoring the ACK/NACK signalling field of the HS-SICH received at the SS, while random data is streamed from the SS to the UE.

The normative reference for this test is 25.102 [2], section 9.

The requirements and this test apply to 1,28 Mcps TDD UE from release 5 and later that support HSDPA which is 2.2Mbps UE class.

#### 9.3.2D.2 Minimum requirements

For the parameters specified in tables 9.3.2D.1 the measured throughput shall be equal to or better than the the specified value in table 9.3.2D.2. The reference for this requirement is TS 25.102 [1] section 9.

**Table 9.3.2D.1: Test parameters for variable reference measurement channel requirements for 2.2 Mbps UE class**

Parameter	Unit	Test 1	Test 2	Test 3
HS-PDSCH Modulation and TBS	-		*	
Scrambling code and basic midamble code Number **	-		1	
Midamble			Common midamble	
Number of TS****	-		4	
Number of DPCH <sub>0</sub>	-		0	
Number of HARQ Process	-		4	
Number of transmission	-		1	
Redundancy and constellation version coding sequence	Xrv		0	
HS-PDSCH Channelization Codes**	C(k,Q)		C(i,16) 1≤i≤10	
HS-PDSCH <sub>i</sub> Ec/Ior	dB		-10	
loc	dBm		-60	
* Note 1	As requested by the last received CQI report			
**Note 2	Refer to TS 25.223 for definition of channelization codes, scrambling code and basic midamble code.			
***Note 3	If the indicated CQI is 0, the Node-B emulator shall format the next HS-PDSCH transmission with the transport block size and the modulation scheme that were previously used.			
****Note:	The timeslot just after the second switch point should be included.			

**Table 9.3.2D.2: Minimum performance requirements for variable reference measurement channel requirement in multipath channels for 2.2 Mbps UE class**

Test Number	Propagation conditions	$\frac{\hat{I}_{or}}{I_{oc}}$ [dB]	R (Throughput) [kbps]
1	PA3	15	625
2	PB3	15	631
3	VA30	15	418

### 9.3.2D.3 Test purpose

To verify that the UE receiver is capable meeting the minimum requirements for support of HSDPA in the conditions defined in table 9.3.2D.1, with the selection of QPSK and 16QAM modulation, and appropriate blocksize being determined by the SS based on the CQI reported by the UE.

### 9.3.2D.4 Method of test

#### 9.3.2D.4.1 Initial conditions

Test environment: normal; see clauses G.2.1 and G.2.2.

Frequencies to be tested: mid range; see clause G.2.4.

- 1) Connect SS, multipath fading simulator and an AWGN source to the UE antenna connector as shown in figure A.10.
- 2) Set Ack/Nack/DTX handling at the SS such that regardless of the response from the UE (Ack, Nack or DTX) new data is sent each time, this is because HARQ transmissions are set to one, i.e. no re-transmission of failed blocks.
- 3) Setup fading simulators as fading conditions, which are described in table D.2.2.1.A.

- 4) Set up a HSDPA connection according to the Generic HSDPA setup procedure, See TS 34.108 [3] and TS 34.109 [4] for details regarding generic HSDPA setup procedure.
- 5) Set the test parameters for tests according to above tables of test parameters
- 6) The information bit data shall be pseudo random and not repeated not before 10 different information bit payload blocks are processed. Use a PRBS from ITU-R O.153 Ref [26].

#### 9.3.2D.4.2 Procedure

- 1) Once the HSDPA connection is setup, start transmitting HSDPA Data.

The SS shall transmit a HSDPA block to UE selecting any TBS value excluding 0 or 63 (the first HSDPA block size isn't recorded), then SS will decode the CQI report and transmit a new block on the HS-DSCH with the transport block size and modulation scheme recommended by the UE.

- 2) For any HSDPA block transmitted by the SS, record transmitted block size and relevant received ACK, NACK and statDTX reported by UE. If UE reports ACK, the transmitted block is correctly received by UE. Continue transmission of the HS-PDSCH data and record transmitted block size until [2000] records have been reached.
- 3) For all relevant propagation conditions, calculate the throughput, which is the ratio of the sum of correctly received transport bits over the testing time. [2000] multiplied by transmission time interval is the testing time.

#### 9.3.2D.5 Test Requirements

Tables of test parameters define the primary level settings including test tolerance for all relevant throughput tests. the measured throughput shall be equal to or better than the the specified value in table 9.3.2D.3 of test requirement.

**Table 9.3.2D.3: Test requirements for variable reference measurement channel requirement in multipath channels for 2.2 Mbps UE class**

Test Number	Propagation conditions	$\frac{\hat{I}_{or}}{I_{oc}}$ [dB]	R (Throughput) [kbps]
1	PA3	15.6	625
2	PB3	15.6	631
3	VA30	15.6	418

### 9.3.2E HS-DSCH throughput for Variable Reference Channels 2.8 Mbps UE class

#### 9.3.2E.1 Definition and applicability

The HS-DSCH data throughput for variable reference channels is defined by the capabilities of the UE as defined in [24], and the throughput is measured by counting the amount of data successfully received at the UE by monitoring the ACK/NACK signalling field of the HS-SICH received at the SS, while random data is streamed from the SS to the UE.

The normative reference for this test is 25.102 [2], section 9.

The requirements and this test apply to 1,28 Mcps TDD UE from release 5 and later that support HSDPA which is 2.2Mbps UE class.

#### 9.3.2E.2 Minimum requirements

For the parameters specified in tables 9.3.2E.1 the measured throughput shall be equal to or better than the the specified value in table 9.3.2E.2. The reference for this requirement is TS 25.102 [1] section 9.

**Table 9.3.2E.1: Test parameters for variable reference measurement channel requirements for 2.8 Mbps UE class**

Parameter	Unit	Test 1	Test 2	Test 3
HS-PDSCH Modulation and TBS	-		*	
Scrambling code and basic midamble code Number **	-		1	
Midamble			Common midamble	
Number of TS	-		5	
Number of DPCH <sub>o</sub>	-		0	
Number of HARQ Process	-		4	
Number of transmission	-		1	
Redundancy and constellation version coding sequence	Xrv		0	
HS-PDSCH Channelization Codes**	C(k,Q)		C(i,16) 1≤i≤10	
HS-PDSCH <sub>i</sub> Ec/Ior	dB		-10	
loc	dBm		-60	
* Note 1	As requested by the last received CQI report			
**Note 2	Refer to TS 25.223 for definition of channelization codes, scrambling code and basic midamble code.			
***Note 3	If the indicated CQI is 0, the Node-B emulator shall format the next HS-PDSCH transmission with the transport block size and the modulation scheme that were previously used.			

**Table 9.3.2E.2: Minimum performance requirements for variable reference measurement channel requirement in multipath channels for 2.8 Mbps UE class**

Test Number	Propagation conditions	$\frac{\hat{I}_{or}}{I_{oc}}$ [dB]	R (Throughput) [kbps]
1	PA3	15	783
2	PB3	15	792
3	VA30	15	544

### 9.3.2E.3 Test purpose

To verify that the UE receiver is capable meeting the minimum requirements for support of HSDPA in the conditions defined in table 9.3.2E.2, with the selection of QPSK and 16QAM modulation, and appropriate blocksize being determined by the SS based on the CQI reported by the UE.

### 9.3.2E.4 Method of test

#### 9.3.2E.4.1 Initial conditions

Test environment: normal; see clauses G.2.1 and G.2.2.

Frequencies to be tested: mid range; see clause G.2.4.

- 1) Connect SS, multipath fading simulator and an AWGN source to the UE antenna connector as shown in figure A.10.
- 2) Set Ack/Nack/DTX handling at the SS such that regardless of the response from the UE (Ack, Nack or DTX) new data is sent each time, this is because HARQ transmissions are set to one, i.e. no re-transmission of failed blocks.
- 3) Setup fading simulators as fading conditions, which are described in table D.2.2.1.A.
- 4) Set up a HSDPA connection according to the Generic HSDPA setup procedure, See TS 34.108 [3] and TS 34.109 [4] for details regarding generic HSDPA setup procedure.

- 5) Set the test parameters for tests according to above tables of test parameters
- 6) The information bit data shall be pseudo random and not repeated not before 10 different information bit payload blocks are processed. Use a PRBS from ITU-R O.153 Ref [26].

### 9.3.2E.4.2 Procedure

- 1) Once the HSDPA connection is setup, start transmitting HSDPA Data.

The SS shall transmit a HSDPA block to UE selecting any TBS value excluding 0 or 63 (the first HSDPA block size isn't recorded), then SS will decode the CQI report and transmit a new block on the HS-DSCH with the transport block size and modulation scheme recommended by the UE.

- 2) For any HSDPA block transmitted by the SS, record transmitted block size and relevant received ACK, NACK and statDTX reported by UE. If UE reports ACK, the transmitted block is correctly received by UE. Continue transmission of the HS-PDSCH data and record transmitted block size until [2000] records have been reached.
- 3) For all relevant propagation conditions, calculate the throughput, which is the ratio of the sum of correctly received transport bits over the testing time. [2000] multiplied by transmission time interval is the testing time.

### 9.3.2E.5 Test Requirements

Tables of test parameters define the primary level settings including test tolerance for all relevant throughput tests. The measured throughput shall be equal to or better than the specified value in table 9.3.2E.3 of test requirement.

**Table 9.3.2E.3: Test requirements for variable reference measurement channel requirement in multipath channels for 2.8 Mbps UE class**

Test Number	Propagation conditions	$\frac{\hat{I}_{or}}{I_{oc}}$ [dB]	R (Throughput) [kbps]
1	PA3	15.6	783
2	PB3	15.6	792
3	VA30	15.6	544

## 9.3.3 Reporting of HS-DSCH Channel Quality Indicator

### 9.3.3A Reporting of HS-DSCH Channel Quality Indicator-0.5Mbps UE class

#### 9.3.3A.1 Definition and applicability

The reporting accuracy of channel quality indicator (CQI) under AWGN environments is determined by the reporting variance and the BLER performance using the transport format indicated by the reported CQI median. The CQI is measured while random data is streamed from the SS to the UE.

The normative reference for this test is 25.102 [1], section 9.

The requirements and this test apply to 1,28 Mcps TDD UE from release 5 and later that support HSDPA which is 0.5 Mbps UE class.

#### 9.3.3A.2 Minimum requirements

For the parameters specified in tables 9.3.3.1 the UE shall report a CQI value within the limits of table 9.3.3A.2.

**Table 9.3.3A.1: Test parameters for CQI reporting measurement channel requirements for 0.5Mbps UE class**

Parameter	Unit	0.5Mbps UE
		Test 1
Number of TS	-	2
Number of HS-PDSCH codes per TS	-	10
HS-PDSCH <sub>i</sub> Ec/Ior	dB	-10
HS-PDSCH Channelization Codes*	C(k,Q)	C(i,16) 1≤i≤10
Number of DPCH <sub>o</sub>	-	0
Number of HARQ Process	-	4
Number of transmission	-	1
$\hat{I}_{or} / I_{oc}$	dB	1

**Table 9.3.3A.2 Performance requirements for CQI reporting measurement channel requirements for 0.5Mbps UE class**

Test	Permitted CQI range from median (x)	% of time that CQI must be within +/- x of median (Y)	Maximum BLER for median reported CQI
Test 1	+/- 3	90	10%

### 9.3.3A.3 Test purpose

To verify that the UE receiver is capable meeting the minimum requirements for support of HSDPA in the conditions defined below, such that CQI reported by the UE falls within the acceptable range.

### 9.3.3A.4 Method of test

#### 9.3.3A.4.1 Initial conditions

Test environment: normal; see clauses G.2.1 and G.2.2.

Frequencies to be tested: mid range; see clause G.2.4.

- 1) Connect SS, multipath fading simulator and an AWGN source to the UE antenna connector as shown in figure A.10.
- 2) Set Ack/Nack/DTX handling at the SS such that regardless of the response from the UE (Ack, Nack or DTX) new data is sent each time, this is because HARQ transmissions are set to one, i.e. no re-transmission of failed blocks.
- 3) Set up a call according to the Generic call setup procedure.

See TS 34.108 [3] and TS 34.109 [4] for details regarding generic call setup procedure.

Note: The following value of x is derived from Table 9.3.3A.2

#### 9.3.3A.4.2 Procedure

- 1) Set test conditions according to test 1 according table 9.3.3A.1.

Note: the following part of the procedure will test, if the UE reports a limited range of CQI indicator under the predefined channel conditions.

- 2) The SS shall transmit a HSDPA block to UE selecting any TBS value excluding 0 or 63, then SS will decode the CQI report and transmits a new block on the HS-DSCH with the transport block size and modulation scheme recommended by the UE. For any HSDPA block transmitted by the SS, record the received RTBS value of CQI indicator and the ACK, NACK and statDTX. Continue transmission of the HS-PDSCH data and collect RTBS value of CQI until [2000] reports have been gathered.

- 3) Set up a relative frequency distribution for the RTBS value of CQI indicator reported. Calculate the median value (Median RTBS is the RTBS that is at or crosses 50% distribution from the lower RTBS side). This RTBS value of CQI indicator is declared as Median CQI value,
- 4) If [1800] or more of the RTBS value of CQI indicator are in the range  $(\text{Median CQI} - x) \leq \text{Median CQI} \leq (\text{Median CQI} + x)$  then continue with next step , otherwise fail the UE.
- 5) Calculate the the ratio  $(\text{NACK} + \text{statDTX} / \text{ACK} + \text{NACK} + \text{statDTX})$  when the SS transmit the TBS according to the median-CQI value.If the ratio $< 0.1$  ,then pass the UE,otherwise fail the UE.

### 9.3.3A.5 Test Requirements

The pass fail decision as specified in the test procedure in 9.3.3A.4.2.

No test tolerance is applied to the test parameters.

## 9.3.3B Reporting of HS-DSCH Channel Quality Indicator-1.1Mbps UE class

### 9.3.3B.1 Definition and applicability

The reporting accuracy of channel quality indicator (CQI) under AWGN environments is determined by the reporting variance and the BLER performance using the transport format indicated by the reported CQI median. The CQI is measured while random data is streamed from the SS to the UE.

The normative reference for this test is 25.102 [1], section 9.

The requirements and this test apply to 1,28 Mcps TDD UE from release 5 and later that support HSDPA which is 1.1 Mbps UE class..

### 9.3.3B.2 Minimum requirements

For the parameters specified in tables 9.3.3B.1 the UE shall report a CQI value within the limits of table 9.3.3B.2.

**Table 9.3.3B.1: Test parameters for CQI reporting measurement channel requirements for 1.1Mbps UE class**

Parameter	Unit	1.1Mbps UE	
		Test 1	Test 2
Number of TS	-	2	
Number of HS-PDSCH codes per TS	-	10	
HS-PDSCH <sub>i</sub> _Ec/lor	dB	-10	
HS-PDSCH Channelization Codes*	C(k,Q)	C(i,16) 1≤i≤10	
Number of DPCH <sub>o</sub>	-	0	
Number of HARQ Process	-	4	
Number of transmission	-	1	
$\hat{I}_{or} / I_{oc}$	dB	1	8

**Table 9.3.3B.2 Performance requirements for CQI reporting measurement channel requirements for 1.1Mbps U E class**

Test	Permitted CQI range from median (x)	% of time that CQI must be within +/- x of median (Y)	Maximum BLER for median reported CQI
Test 1	+/- 3	90	10%
Test 2	+/- 2	90	

### 9.3.3B.3 Test purpose

To verify that the UE receiver is capable meeting the minimum requirements for support of HSDPA in the conditions defined below, such that CQI reported by the UE falls within the acceptable range.

### 9.3.3B.4 Method of test

#### 9.3.3B.4.1 Initial conditions

Test environment: normal; see clauses G.2.1 and G.2.2.

Frequencies to be tested: mid range; see clause G.2.4.

- 1) Connect SS, multipath fading simulator and an AWGN source to the UE antenna connector as shown in figure A.10.
- 2) Set Ack/Nack/DTX handling at the SS such that regardless of the response from the UE (Ack, Nack or DTX) new data is sent each time, this is because HARQ transmissions are set to one, i.e. no re-transmission of failed blocks.
- 3) Set up a call according to the Generic call setup procedure.

See TS 34.108 [3] and TS 34.109 [4] for details regarding generic call setup procedure.

Note: The following value of  $x$  is derived from Table 9.3.3B.2

#### 9.3.3B.4.2 Procedure

- 1) Set test conditions according to test 1 according table 9.3.3B.1.

Note: the following part of the procedure will test, if the UE reports a limited range of CQI indicator under the predefined channel conditions.

- 2) The SS shall transmit a HSDPA block to UE selecting any TBS value excluding 0 or 63, then SS will decode the CQI report and transmits a new block on the HS-DSCH with the transport block size and modulation scheme recommended by the UE. For any HSDPA block transmitted by the SS, record the received RTBS value of CQI indicator and the ACK, NACK and statDTX. Continue transmission of the HS-PDSCH data and collect RTBS value of CQI until [2000] reports have been gathered.
- 3) Set up a relative frequency distribution for the RTBS value of CQI indicator reported. Calculate the median value (Median RTBS is the RTBS that is at or crosses 50% distribution from the lower RTBS side). This RTBS value of CQI indicator is declared as Median CQI value,
- 4) If [1800] or more of the RTBS value of CQI indicator are in the range  $(\text{Median CQI} - x) \leq \text{Median CQI} \leq (\text{Median CQI} + x)$  then continue with next step, otherwise fail the UE.
- 5) Calculate the ratio  $(\text{NACK} + \text{statDTX} / \text{ACK} + \text{NACK} + \text{statDTX})$  when the SS transmit the TBS according to the median-CQI value. If the ratio  $< 0.1$ , then pass the UE, otherwise fail the UE.
- 6) Repeat the same procedure (steps 2 to 5) with test conditions according to the table 9.3.3B.1.

### 9.3.3B.5 Test Requirements

The pass fail decision as specified in the test procedure in 9.3.3B.4.2.

No test tolerance is applied to the test parameters.

## 9.3.3C Reporting of HS-DSCH Channel Quality Indicator-1.6Mbps UE class

### 9.3.3C.1 Definition and applicability

The reporting accuracy of channel quality indicator (CQI) under AWGN environments is determined by the reporting variance and the BLER performance using the transport format indicated by the reported CQI median. The CQI is measured while random data is streamed from the SS to the UE.

The normative reference for this test is 25.102 [1], section 9.

The requirements and this test apply to 1,28 Mcps TDD UE from release 5 and later that support HSDPA which is 1.6 Mbps UE class..



### 9.3.3C.2 Minimum requirements

For the parameters specified in tables 9.3.3C.1 the UE shall report a CQI value within the limits of table 9.3.3C.2.

**Table 9.3.3C.1: Test parameters for CQI reporting measurement channel requirements for 1.6Mbps UE class**

Parameter	Unit	1.6Mbps UE	
		Test 1	Test 2
Number of TS	-	3	
Number of HS-PDSCH codes per TS	-	10	
HS-PDSCH <sub>i</sub> Ec/Ior	dB	-10	
HS-PDSCH Channelization Codes*	C(k,Q)	C(i,16) 1 ≤ i ≤ 10	
Number of DPCH <sub>o</sub>	-	0	
Number of HARQ Process	-	4	
Number of transmission	-	1	
$\hat{I}_{or} / I_{oc}$	dB	1	8

**Table 9.3.3C.2 Performance requirements for CQI reporting measurement channel requirements for 1.6Mbps U E class**

Test	Permitted CQI range from median (x)	% of time that CQI must be within +/- x of median (Y)	Maximum BLER for median reported CQI
Test 1	+/- 2	90	10%
Test 2	+/- 2	90	

### 9.3.3C.3 Test purpose

To verify that the UE receiver is capable meeting the minimum requirements for support of HSDPA in the conditions defined below, such that CQI reported by the UE falls within the acceptable range.

### 9.3.3C.4 Method of test

#### 9.3.3C.4.1 Initial conditions

Test environment: normal; see clauses G.2.1 and G.2.2.

Frequencies to be tested: mid range; see clause G.2.4.

- 1) Connect SS, multipath fading simulator and an AWGN source to the UE antenna connector as shown in figure A.10.
- 2) Set Ack/Nack/DTX handling at the SS such that regardless of the response from the UE (Ack, Nack or DTX) new data is sent each time, this is because HARQ transmissions are set to one, i.e. no re-transmission of failed blocks.
- 3) Set up a call according to the Generic call setup procedure.

See TS 34.108 [3] and TS 34.109 [4] for details regarding generic call setup procedure.

Note: The following value of x is derived from Table 9.3.3C.2

#### 9.3.3C.4.2 Procedure

- 1) Set test conditions according to test 1 according table 9.3.3C.1.

Note: the following part of the procedure will test, if the UE reports a limited range of CQI indicator under the predefined channel conditions.

- 2) The SS shall transmit a HSDPA block to UE selecting any TBS value excluding 0 or 63, then SS will decode the CQI report and transmits a new block on the HS-DSCH with the transport block size and modulation scheme

recommended by the UE. For any HSDPA block transmitted by the SS, record the received RTBS value of CQI indicator and the ACK, NACK and statDTX. Continue transmission of the HS-PDSCH data and collect RTBS value of CQI until [2000] reports have been gathered.

- 3) Set up a relative frequency distribution for the RTBS value of CQI indicator reported. Calculate the median value (Median RTBS is the RTBS that is at or crosses 50% distribution from the lower RTBS side). This RTBS value of CQI indicator is declared as Median CQI value,
- 4) If [1800] or more of the RTBS value of CQI indicator are in the range  $(\text{Median CQI} - x) \leq \text{Median CQI} \leq (\text{Median CQI} + x)$  then continue with next step, otherwise fail the UE.
- 5) Calculate the ratio  $(\text{NACK} + \text{statDTX}) / (\text{ACK} + \text{NACK} + \text{statDTX})$  when the SS transmit the TBS according to the median-CQI value. If the ratio  $< 0.1$ , then pass the UE, otherwise fail the UE.
- 6) Repeat the same procedure (steps 2 to 5) with test conditions according to the table 9.3.3C.1.

### 9.3.3C.5 Test Requirements

The pass fail decision as specified in the test procedure in 9.3.3C.4.2.

No test tolerance is applied to the test parameters.

## 9.3.3D Reporting of HS-DSCH Channel Quality Indicator-2.2Mbps UE class

### 9.3.3D.1 Definition and applicability

The reporting accuracy of channel quality indicator (CQI) under AWGN environments is determined by the reporting variance and the BLER performance using the transport format indicated by the reported CQI median. The CQI is measured while random data is streamed from the SS to the UE.

The normative reference for this test is 25.102 [1], section 9.

The requirements and this test apply to 1,28 Mcps TDD UE from release 5 and later that support HSDPA which is 2.2 Mbps UE class..

### 9.3.3D.2 Minimum requirements

For the parameters specified in tables 9.3.3D.1 the UE shall report a CQI value within the limits of table 9.3.3D.2.

**Table 9.3.3D.1: Test parameters for CQI reporting measurement channel requirements for 2.2Mbps UE class**

Parameter	Unit	1.6Mbps UE	
		Test 1	Test 2
Number of TS	-	4	
Number of HS-PDSCH codes per TS	-	10	
HS-PDSCH <sub>i</sub> _Ec/Ior	dB	-10	
HS-PDSCH Channelization Codes*	C(k,Q)	C(i,16) 1 ≤ i ≤ 10	
Number of DPCH <sub>o</sub>	-	0	
Number of HARQ Process	-	4	
Number of transmission	-	1	
$\hat{I}_{or} / I_{oc}$	dB	1	8

**Table 9.3.3D.2 Performance requirements for CQI reporting measurement channel requirements for 2.2Mbps U E class**

Test	Permitted CQI range from median (x)	% of time that CQI must be within +/- x of median (Y)	Maximum BLER for median reported CQI
Test 1	+/- 2	90	10%
Test 2	+/- 2	90	

### 9.3.3D.3 Test purpose

To verify that the UE receiver is capable meeting the minimum requirements for support of HSDPA in the conditions defined below, such that CQI reported by the UE falls within the acceptable range.

### 9.3.3D.4 Method of test

#### 9.3.3D.4.1 Initial conditions

Test environment: normal; see clauses G.2.1 and G.2.2.

Frequencies to be tested: mid range; see clause G.2.4.

- 1) Connect SS, multipath fading simulator and an AWGN source to the UE antenna connector as shown in figure A.10.
- 2) Set Ack/Nack/DTX handling at the SS such that regardless of the response from the UE (Ack, Nack or DTX) new data is sent each time, this is because HARQ transmissions are set to one, i.e. no re-transmission of failed blocks.
- 3) Set up a call according to the Generic call setup procedure.

See TS 34.108 [3] and TS 34.109 [4] for details regarding generic call setup procedure.

Note: The following value of x is derived from Table 9.3.3D.2

#### 9.3.3D.4.2 Procedure

- 1) Set test conditions according to test 1 according table 9.3.3D.1.

Note: the following part of the procedure will test, if the UE reports a limited range of CQI indicator under the predefined channel conditions.

- 2) The SS shall transmit a HSDPA block to UE selecting any TBS value excluding 0 or 63, then SS will decode the CQI report and transmits a new block on the HS-DSCH with the transport block size and modulation scheme recommended by the UE. For any HSDPA block transmitted by the SS, record the received RTBS value of CQI indicator and the ACK, NACK and statDTX. Continue transmission of the HS-PDSCH data and collect RTBS value of CQI until [2000] reports have been gathered.
- 3) Set up a relative frequency distribution for the RTBS value of CQI indicator reported. Calculate the median value (Median RTBS is the RTBS that is at or crosses 50% distribution from the lower RTBS side). This RTBS value of CQI indicator is declared as Median CQI value,
- 4) If [1800] or more of the RTBS value of CQI indicator are in the range  $(\text{Median CQI} - x) \leq \text{Median CQI} \leq (\text{Median CQI} + x)$  then continue with next step, otherwise fail the UE.
- 5) Calculate the ratio  $(\text{NACK} + \text{statDTX} / \text{ACK} + \text{NACK} + \text{statDTX})$  when the SS transmit the TBS according to the median-CQI value. If the ratio  $< 0.1$ , then pass the UE, otherwise fail the UE.
- 6) Repeat the same procedure (steps 2 to 5) with test conditions according to the table 9.3.3D.1.

### 9.3.3D.5 Test Requirements

The pass fail decision as specified in the test procedure in 9.3.3D.4.2.

No test tolerance is applied to the test parameters.

### 9.3.3E Reporting of HS-DSCH Channel Quality Indicator-2.8Mbps UE class

#### 9.3.3E.1 Definition and applicability

The reporting accuracy of channel quality indicator (CQI) under AWGN environments is determined by the reporting variance and the BLER performance using the transport format indicated by the reported CQI median. The CQI is measured while random data is streamed from the SS to the UE.

The normative reference for this test is 25.102 [1], section 9.

The requirements and this test apply to 1,28 Mcps TDD UE from release 5 and later that support HSDPA which is 2.8 Mbps UE class..

#### 9.3.3E.2 Minimum requirements

For the parameters specified in tables 9.3.3E.1 the UE shall report a CQI value within the limits of table 9.3.3E.2.

**Table 9.3.3E.1: Test parameters for CQI reporting measurement channel requirements for 2.8Mbps UE class**

Parameter	Unit	2.8Mbps UE	
		Test 1	Test 2
Number of TS	-	5	
Number of HS-PDSCH codes per TS	-	10	
HS-PDSCH <sub>i</sub> _Ec/lor	dB	-10	
HS-PDSCH Channelization Codes*	C(k,Q)	C(i,16) 1≤i≤10	
Number of DPCH <sub>o</sub>	-	0	
Number of HARQ Process	-	4	
Number of transmission	-	1	
$\hat{I}_{or} / I_{oc}$	dB	1	8

**Table 9.3.3E.2 Performance requirements for CQI reporting measurement channel requirements for 2.8Mbps UE class**

Test	Permitted CQI range from median (x)	% of time that CQI must be within +/- x of median (Y)	Maximum BLER for median reported CQI
Test 1	+/- 2	90	10%
Test 2	+/- 2	90	

#### 9.3.3E.3 Test purpose

To verify that the UE receiver is capable meeting the minimum requirements for support of HSDPA in the conditions defined below, such that CQI reported by the UE falls within the acceptable range.

#### 9.3.3E.4 Method of test

##### 9.3.3E.4.1 Initial conditions

Test environment: normal; see clauses G.2.1 and G.2.2.

Frequencies to be tested: mid range; see clause G.2.4.

- 1) Connect SS, multipath fading simulator and an AWGN source to the UE antenna connector as shown in figure A.10.
- 2) Set Ack/Nack/DTX handling at the SS such that regardless of the response from the UE (Ack, Nack or DTX) new data is sent each time, this is because HARQ transmissions are set to one, i.e. no re-transmission of failed blocks.

- 3) Set up a call according to the Generic call setup procedure.

See TS 34.108 [3] and TS 34.109 [4] for details regarding generic call setup procedure.

Note: The following value of  $x$  is derived from Table 9.3.3E.2

#### 9.3.3E.4.2 Procedure

- 1) Set test conditions according to test 1 according table 9.3.3E.1.

Note: the following part of the procedure will test, if the UE reports a limited range of CQI indicator under the predefined channel conditions.

- 2) The SS shall transmit a HSDPA block to UE selecting any TBS value excluding 0 or 63, then SS will decode the CQI report and transmits a new block on the HS-DSCH with the transport block size and modulation scheme recommended by the UE. For any HSDPA block transmitted by the SS, record the received RTBS value of CQI indicator and the ACK, NACK and statDTX. Continue transmission of the HS-PDSCH data and collect RTBS value of CQI until [2000] reports have been gathered.
- 3) Set up a relative frequency distribution for the RTBS value of CQI indicator reported. Calculate the median value (Median RTBS is the RTBS that is at or crosses 50% distribution from the lower RTBS side). This RTBS value of CQI indicator is declared as Median CQI value,
- 4) If [1800] or more of the RTBS value of CQI indicator are in the range  $(\text{Median CQI} - x) \leq \text{Median CQI} \leq (\text{Median CQI} + x)$  then continue with next step, otherwise fail the UE.
- 5) Calculate the ratio  $(\text{NACK} + \text{statDTX} / \text{ACK} + \text{NACK} + \text{statDTX})$  when the SS transmit the TBS according to the median-CQI value. If the ratio  $< 0.1$ , then pass the UE, otherwise fail the UE.
- 6) Repeat the same procedure (steps 2 to 5) with test conditions according to the table 9.3.3E.1.

#### 9.3.3E.5 Test Requirements

The pass fail decision as specified in the test procedure in 9.3.3E.4.2.

No test tolerance is applied to the test parameters.

### 9.3.3F Reporting of HS-DSCH Channel Quality Indicator – 64QAM UE capability categories 16 - 18

#### 9.3.3F.1 Definition and applicability

The reporting accuracy of channel quality indicator (CQI) under AWGN environments is determined by the reporting variance and the BLER performance using the transport format indicated by the reported CQI median. The CQI is measured while random data is streamed from the SS to the UE.

The normative reference for this test is 25.102 [1], section 9.

The requirements and this test apply to 1,28 Mcps TDD UE from release 8 and later that support HSDPA UE capability categories 16 - 18.

#### 9.3.3F.2 Minimum requirements

For the parameters specified in tables 9.3.3A.1 the UE shall report a CQI value within the limits of table 9.3.3F.2.

**Table 9.3.3F.1: Test parameters for CQI reporting measurement channel requirements for UE capability categories 16 - 18**

		<b>Category 16-18</b>
<b>Parameter</b>	<b>Unit</b>	<b>Test 1</b>
Number of TS	-	3
Number of HS-PDSCH codes per TS	-	14
HS-PDSCH <sub>i</sub> Ec/Ior	dB	-11.46
HS-PDSCH Channelization Codes*	C(k,Q)	C(i,16) 1≤i≤14
Number of DPCH <sub>o</sub>	-	0
Number of HARQ Process	-	4
Number of transmission	-	1
I <sub>oc</sub> **	dBm/1.28MHz	-60
$\hat{I}_{or} / I_{oc}$	dB	18
Propagatio Channel	-	AWGN
*Note 1: Refer to TS 25.223 for definition of channelization codes, scrambling code and basic midamble code.		
**Note 2: For multi-carrier reception, it refers to $\frac{\hat{I}_{or}}{I_{oc}}$ on each carrier.		

**Table 9.3.3F.2: Performance requirements for CQI reporting measurement channel requirements for UE capability categories 16 - 18**

<b>Test</b>	<b>Permitted CQI range from median (x)</b>	<b>% of time that CQI must be within +/- x of median (Y)</b>	<b>Maximum BLER for median reported CQI</b>
Test 1	+/- 2	90	10%

### 9.3.3F.3 Test purpose

To verify that the UE receiver is capable meeting the minimum requirements for support of HSDPA in the conditions defined below, such that CQI reported by the UE falls within the acceptable range.

### 9.3.3F.4 Method of test

#### 9.3.3F.4.1 Initial conditions

Test environment: normal; see clauses G.2.1 and G.2.2.

Frequencies to be tested: mid range; see clause G.2.4.

- 1) Connect SS, multipath fading simulator and an AWGN source to the UE antenna connector as shown in figure A.10.
- 2) Set Ack/Nack/DTX handling at the SS such that regardless of the response from the UE (Ack, Nack or DTX) new data is sent each time, this is because HARQ transmissions are set to one, i.e. no re-transmission of failed blocks.
- 3) Set up a call according to the Generic call setup procedure.

See TS 34.108 [3] and TS 34.109 [4] for details regarding generic call setup procedure.

NOTE: The following value of x is derived from Table 9.3.3F.2

#### 9.3.3F.4.2 Procedure

- 1) Set test conditions according to test 1 according table 9.3.3F.1.

NOTE: the following part of the procedure will test, if the UE reports a limited range of CQI indicator under the predefined channel conditions.

- 2) The SS shall transmit a HSDPA block to UE selecting any TBS value excluding 0 or 63, then SS will decode the CQI report and transmits a new block on the HS-DSCH with the transport block size and modulation scheme recommended by the UE. For any HSDPA block transmitted by the SS, record the received RTBS value of CQI indicator and the ACK, NACK and statDTX. Continue transmission of the HS-PDSCH data and collect RTBS value of CQI until [2000] reports have been gathered.
- 3) Set up a relative frequency distribution for the RTBS value of CQI indicator reported. Calculate the median value (Median RTBS is the RTBS that is at or crosses 50% distribution from the lower RTBS side). This RTBS value of CQI indicator is declared as Median CQI value,
- 4) If [1800] or more of the RTBS value of CQI indicator are in the range  $(\text{Median CQI} - x) \leq \text{Median CQI} \leq (\text{Median CQI} + x)$  then continue with next step, otherwise fail the UE.
- 5) Calculate the ratio  $(\text{NACK} + \text{statDTX}) / (\text{ACK} + \text{NACK} + \text{statDTX})$  when the SS transmit the TBS according to the median-CQI value. If the ratio  $< 0.1$ , then pass the UE, otherwise fail the UE.

### 9.3.3F.5 Test Requirements

The pass fail decision as specified in the test procedure in 9.3.3F.4.2.

No test tolerance is applied to the test parameters.

## 9.3.3G Reporting of HS-DSCH Channel Quality Indicator – 64QAM UE capability categories 19 - 21

### 9.3.3G.1 Definition and applicability

The reporting accuracy of channel quality indicator (CQI) under AWGN environments is determined by the reporting variance and the BLER performance using the transport format indicated by the reported CQI median. The CQI is measured while random data is streamed from the SS to the UE.

The normative reference for this test is 25.102 [1], section 9.

The requirements and this test apply to 1,28 Mcps TDD UE from release 8 and later that support HSDPA UE capability categories 19 - 21.

### 9.3.3G.2 Minimum requirements

For the parameters specified in tables 9.3.3G.1 the UE shall report a CQI value within the limits of table 9.3.3G.2.

**Table 9.3.3G.1: Test parameters for CQI reporting measurement channel requirements for UE capability categories 19 - 21**

		Category 19-21
Parameter	Unit	Test 1
Number of TS	-	4
Number of HS-PDSCH codes per TS	-	14
HS-PDSCH <sub>i</sub> Ec/Ior	dB	-11.46
HS-PDSCH Channelization Codes*	C(k,Q)	C(i,16) 1 ≤ i ≤ 14
Number of DPCH <sub>o</sub>	-	0
Number of HARQ Process	-	4
Number of transmission	-	1
I <sub>oc</sub> **	dBm/1.28MHz	-60
$\hat{I}_{or} / I_{oc}$	dB	18
Propagatio Channel	-	AWGN
*Note 1: Refer to TS 25.223 for definition of channelization codes, scrambling code and basic midamble code.		
**Note 2: For multi-carrier reception, it refers to $\frac{\hat{I}_{or}}{I_{oc}}$ on each carrier.		

**Table 9.3.3G.2: Performance requirements for CQI reporting measurement channel requirements for UE capability categories 19 - 21**

Test	Permitted CQI range from median (x)	% of time that CQI must be within +/- x of median (Y)	Maximum BLER for median reported CQI
Test 1	+/- 2	90	10%

### 9.3.3G.3 Test purpose

To verify that the UE receiver is capable meeting the minimum requirements for support of HSDPA in the conditions defined below, such that CQI reported by the UE falls within the acceptable range.

### 9.3.3G.4 Method of test

#### 9.3.3G.4.1 Initial conditions

Test environment: normal; see clauses G.2.1 and G.2.2.

Frequencies to be tested: mid range; see clause G.2.4.

- 1) Connect SS, multipath fading simulator and an AWGN source to the UE antenna connector as shown in figure A.10.
- 2) Set Ack/Nack/DTX handling at the SS such that regardless of the response from the UE (Ack, Nack or DTX) new data is sent each time, this is because HARQ transmissions are set to one, i.e. no re-transmission of failed blocks.
- 3) Set up a call according to the Generic call setup procedure.

See TS 34.108 [3] and TS 34.109 [4] for details regarding generic call setup procedure.

NOTE: The following value of x is derived from Table 9.3.3G.2

#### 9.3.3G.4.2 Procedure

- 1) Set test conditions according to test 1 according table 9.3.3G.1.

NOTE: the following part of the procedure will test, if the UE reports a limited range of CQI indicator under the predefined channel conditions.

- 2) The SS shall transmit a HSDPA block to UE selecting any TBS value excluding 0 or 63, then SS will decode the CQI report and transmits a new block on the HS-DSCH with the transport block size and modulation scheme recommended by the UE. For any HSDPA block transmitted by the SS, record the received RTBS value of CQI indicator and the ACK, NACK and statDTX. Continue transmission of the HS-PDSCH data and collect RTBS value of CQI until [2000] reports have been gathered.
- 3) Set up a relative frequency distribution for the RTBS value of CQI indicator reported. Calculate the median value (Median RTBS is the RTBS that is at or crosses 50% distribution from the lower RTBS side). This RTBS value of CQI indicator is declared as Median CQI value.
- 4) If [1800] or more of the RTBS value of CQI indicator are in the range  $(\text{Median CQI} - x) \leq \text{Median CQI} \leq (\text{Median CQI} + x)$  then continue with next step, otherwise fail the UE.
- 5) Calculate the ratio  $(\text{NACK} + \text{statDTX} / \text{ACK} + \text{NACK} + \text{statDTX})$  when the SS transmit the TBS according to the median-CQI value. If the ratio  $< 0.1$ , then pass the UE, otherwise fail the UE.

### 9.3.3G.5 Test Requirements

The pass fail decision as specified in the test procedure in 9.3.3G.4.2.

No test tolerance is applied to the test parameters.



### 9.3.3H Reporting of HS-DSCH Channel Quality Indicator – 64QAM UE capability categories 22 - 24

#### 9.3.3H.1 Definition and applicability

The reporting accuracy of channel quality indicator (CQI) under AWGN environments is determined by the reporting variance and the BLER performance using the transport format indicated by the reported CQI median. The CQI is measured while random data is streamed from the SS to the UE.

The normative reference for this test is 25.102 [1], section 9.

The requirements and this test apply to 1,28 Mcps TDD UE from release 8 and later that support HSDPA UE capability categories 22 - 24.

#### 9.3.3H.2 Minimum requirements

For the parameters specified in tables 9.3.3H.1 the UE shall report a CQI value within the limits of table 9.3.3H.2.

**Table 9.3.3H.1: Test parameters for CQI reporting measurement channel requirements for UE capability categories 22 - 24**

Parameter	Unit	Category 22-24 Test 1
Number of TS	-	5
Number of HS-PDSCH codes per TS	-	14
HS-PDSCH <sub>i</sub> Ec/Ior	dB	-11.46
HS-PDSCH Channelization Codes*	C(k,Q)	C(i,16) 1≤i≤14
Number of DPCH <sub>o</sub>	-	0
Number of HARQ Process	-	4
Number of transmission	-	1
I <sub>oc</sub> **	dBm/1.28MHz	-60
$\hat{I}_{or} / I_{oc}$	dB	18
Propagatio Channel	-	AWGN
*Note 1: Refer to TS 25.223 for definition of channelization codes, scrambling code and basic midamble code.		
**Note 2: For multi-carrier reception, it refers to $\frac{\hat{I}_{or}}{I_{oc}}$ on each carrier.		

**Table 9.3.3H.2: Performance requirements for CQI reporting measurement channel requirements for UE capability categories 22 - 24**

Test	Permitted CQI range from median (x)	% of time that CQI must be within +/- x of median (Y)	Maximum BLER for median reported CQI
Test 1	+/- 2	90	10%

#### 9.3.3H.3 Test purpose

To verify that the UE receiver is capable meeting the minimum requirements for support of HSDPA in the conditions defined below, such that CQI reported by the UE falls within the acceptable range.

#### 9.3.3H.4 Method of test

##### 9.3.3H.4.1 Initial conditions

Test environment: normal; see clauses G.2.1 and G.2.2.

Frequencies to be tested: mid range; see clause G.2.4.

- 1) Connect SS, multipath fading simulator and an AWGN source to the UE antenna connector as shown in figure A.10.
- 2) Set Ack/Nack/DTX handling at the SS such that regardless of the response from the UE (Ack, Nack or DTX) new data is sent each time, this is because HARQ transmissions are set to one, i.e. no re-transmission of failed blocks.
- 3) Set up a call according to the Generic call setup procedure.

See TS 34.108 [3] and TS 34.109 [4] for details regarding generic call setup procedure.

NOTE: The following value of x is derived from Table 9.3.3H.2

#### 9.3.3H.4.2 Procedure

- 1) Set test conditions according to test 1 according table 9.3.3H.1.

NOTE: the following part of the procedure will test, if the UE reports a limited range of CQI indicator under the predefined channel conditions.

- 2) The SS shall transmit a HSDPA block to UE selecting any TBS value excluding 0 or 63, then SS will decode the CQI report and transmits a new block on the HS-DSCH with the transport block size and modulation scheme recommended by the UE. For any HSDPA block transmitted by the SS, record the received RTBS value of CQI indicator and the ACK, NACK and statDTX. Continue transmission of the HS-PDSCH data and collect RTBS value of CQI until [2000] reports have been gathered.
- 3) Set up a relative frequency distribution for the RTBS value of CQI indicator reported. Calculate the median value (Median RTBS is the RTBS that is at or crosses 50% distribution from the lower RTBS side). This RTBS value of CQI indicator is declared as Median CQI value.
- 4) If [1800] or more of the RTBS value of CQI indicator are in the range  $(\text{Median CQI} - x) \leq \text{Median CQI} \leq (\text{Median CQI} + x)$  then continue with next step, otherwise fail the UE.
- 5) Calculate the ratio  $(\text{NACK} + \text{statDTX}) / (\text{ACK} + \text{NACK} + \text{statDTX})$  when the SS transmit the TBS according to the median-CQI value. If the ratio  $< 0.1$ , then pass the UE, otherwise fail the UE.

#### 9.3.3H.5 Test Requirements

The pass fail decision as specified in the test procedure in 9.3.3H.4.2.

No test tolerance is applied to the test parameters.

### 9.3.3I Reporting of HS-DSCH Channel Quality Indicator – category 25 MIMO

#### 9.3.3I.1 Definition and applicability

The reporting accuracy of channel quality indicator (CQI) under AWGN and static orthogonal environments is determined by the reporting variance and the BLER performance using the transport format indicated by the reported CQI median. The CQI is measured while random data is streamed from the SS to the UE.

The normative reference for this test is 25.102 [21], section 9.

The requirements and this test apply to 1,28 Mcps TDD MIMO capable UEs category 25 from release 8 and later.

#### 9.3.3I.2 Minimum requirements

For the parameters specified in tables 9.3.3I.1 the UE categories 25 shall report a CQI value within the limits of table 9.3.3I.2.

The MIMO dual stream static orthogonal propagation conditions are defined in Annex D.2.5.1. For UE supporting Spreading Factor 1 only in dual stream transmission, the number of HS-PDSCH codes per TS should be configured to 1 in dual stream transmission, and the HS-PDSCH<sub>i</sub>\_Ec/Ior should be 0dB.

**Table 9.3.3I.1: Test parameters for CQI reporting measurement channel requirements (1.28 Mcps TDD Option)**

Parameter	Unit	Category 25	
		Test 1	Test 2
Number of TS	-	3	
Number of HS-PDSCH codes per TS	-	16	
Number of HS-PDSCH codes per TS	-	16	
HS-PDSCH <sub>i</sub> _Ec/Ior	dB	-12.04	
HS-PDSCH Channelization Codes	C(k,Q)	C(i,16) 1 ≤ i ≤ 16	
Number of DPCH <sub>o</sub>	-	0	
Number of HARQ Process perstream	-	4	
Number of transmission loc	-	1	
loc	dBm	-60	
$\hat{I}_{or} / I_{oc}$	dB	8	10
Stream Number configuration	-	Single Stream	Dual Stream
Propagation Channel	-	AWGN	Static Orthogonal

**Table 9.3.3I.2: Performance requirements for CQI reporting measurement channel requirements (1.28 Mcps TDD Option)**

Test	Permitted CQI range from median (x)	% of time that CQI must be within +/- x of median (Y)	Maximum BLER for median reported CQI
Test 1	+/- 2	90	10%
Test 2	+/- 2	90	

### 9.3.3I.3 Test purpose

To verify that the UE receiver is capable meeting the minimum requirements for support of HSDPA in the conditions defined above, such that CQI reported by the UE falls within the acceptable range.

### 9.3.3I.4 Method of test

#### 9.3.3I.4.1 Initial conditions

Test environment: normal; see clauses G.2.1 and G.2.2.

Frequencies to be tested: mid range; see clause G.2.4.

- 1) Connect SS, multipath fading simulator and an AWGN source to the UE antenna connector as shown in figure A.18
- 2) Set Ack/Nack/DTX handling at the SS such that regardless of the response from the UE (Ack, Nack or DTX) new data is sent each time, this is because HARQ transmissions are set to one, i.e. no re-transmission of failed blocks.
- 3) Set up a call according to the Generic call setup procedure.

See TS 34.108 [3] and TS 34.109 [4] for details regarding generic call setup procedure.

#### 9.3.3I.4.2 Procedure

For test 1, the test procedure is as followed:

- 1) Set test conditions according to test 1 according table 9.3.3I.1.

- 2) The SS shall transmit a HSDPA block on one antenna to UE, selecting any TBS value excluding 0 or 63, then SS will decode CQI report and transmits a new block on HS-DSCH with the transport block size and modulation scheme recommended by the UE on the other antenna. For any HSDPA block transmitted by the SS, record the received RTBS value of CQI indicator and the ACK, NACK and statDTX. Continue transmission of the HS-PDSCH data and collect RTBS value of CQI until [2000] reports have been gathered.
- 3) Set up a relative frequency distribution for the RTBS value of CQI indicator reported. Calculate the median value (Median RTBS is the RTBS that is at or crosses 50% distribution from the lower RTBS side). This RTBS value of CQI indicator is declared as Median CQI value,
- 4) If [1800] or more of the RTBS value of CQI indicator are in the range  $(\text{Median CQI} - x) \leq \text{Median CQI} \leq (\text{Median CQI} + x)$  then continue with next step, otherwise fail the UE.
- 5) Calculate the ratio  $(\text{NACK} + \text{statDTX} / \text{ACK} + \text{NACK} + \text{statDTX})$  when the SS transmit the TBS according to the median-CQI value. If the ratio  $< 0.1$ , then pass the UE, otherwise fail the UE.

For test 2, the test procedure is as followed:

- 1) Set test conditions according to test 1 according table 9.3.3I.1.
- 2) The SS shall transmit two streams on each antenna to UE, each with a sequence of HSDPA blocks. For each stream, SS firstly transmit a HSDPA block, selecting any TBS value excluding 0 or 63, then SS will decode CQI report and transmits a new block on HS-DSCH with the transport block size and modulation scheme recommended by the UE. For any HSDPA block transmission, the SS shall record the received RTBS value of CQI indicator and the ACK, NACK and statDTX. Continue transmission of each streams of HS-PDSCH data and collect RTBS value of CQI until [2000] reports for this stream have been gathered.
- 3) For each stream, the SS set up a relative frequency distribution for the RTBS value of CQI indicator reported, then calculate the median value (Median RTBS is the RTBS that is at or crosses 50% distribution from the lower RTBS side) for this stream. This RTBS value of CQI indicator is declared as Median CQI-stream value,
- 4) For each stream, if [1800] or more of the RTBS value of CQI indicator are in the range  $(\text{Median CQI-stream} - x) \leq \text{Median CQI-stream} \leq (\text{Median CQI-stream} + x)$  then continue with next step, otherwise fail the UE.
- 5) For each stream, Calculate the ratio  $(\text{NACK} + \text{statDTX} / \text{ACK} + \text{NACK} + \text{statDTX})$  when the SS transmit the TBS according to the median-CQI-stream value. If the ratio  $< 0.1$ , then pass the UE, otherwise fail the UE.

### 9.3.3I.5 Test Requirements

The pass fail decision as specified in the test procedure in 9.3.3I.4.2.

No test tolerance is applied to the test parameters.

## 9.3.3J Reporting of HS-DSCH Channel Quality Indicator – category 26 MIMO

### 9.3.3J.1 Definition and applicability

The reporting accuracy of channel quality indicator (CQI) under AWGN and static orthogonal environments is determined by the reporting variance and the BLER performance using the transport format indicated by the reported CQI median. The CQI is measured while random data is streamed from the SS to the UE.

The normative reference for this test is 25.102 [21], section 9.

The requirements and this test apply to 1,28 Mcps TDD MIMO capable UEs category 26 from release 8 and later.

### 9.3.3J.2 Minimum requirements

For the parameters specified in tables 9.3.3J.1 the UE categories 26 shall report a CQI value within the limits of table 9.3.3J.2.

The MIMO dual stream static orthogonal propagation conditions are defined in Annex D.2.5.1. For UE supporting Spreading Factor 1 only in dual stream transmission, the number of HS-PDSCH codes per TS should be configured to 1 in dual stream transmission, and the HS-PDSCH<sub>i</sub>\_Ec/Tor should be 0dB.

**Table 9.3.3J.1: Test parameters for CQI reporting measurement channel requirements (1.28 Mcps TDD Option)**

Parameter	Unit	Category 26	
		Test 1	Test 2
Number of TS	-	4	
Number of HS-PDSCH codes per TS	-	16	
Number of HS-PDSCH codes per TS	-	16	
HS-PDSCH <sub>i</sub> Ec/Ior	dB	-12.04	
HS-PDSCH Channelization Codes	C(k,Q)	C(i,16) 1≤i≤16	
Number of DPCH <sub>o</sub>	-	0	
Number of HARQ Process perstream	-	4	
Number of transmission loc	-	1	
loc	dBm	-60	
$\hat{I}_{or}/I_{oc}$	dB	8	10
Stream Number configuration	-	Single Stream	Dual Stream
Propagation Channel	-	AWGN	Static Orthogonal

**Table 9.3.3J.2: Performance requirements for CQI reporting measurement channel requirements (1.28 Mcps TDD Option)**

Test	Permitted CQI range from median (x)	% of time that CQI must be within +/- x of median (Y)	Maximum BLER for median reported CQI
Test 1	+/- 2	90	10%
Test 2	+/- 2	90	

### 9.3.3J.3 Test purpose

To verify that the UE receiver is capable meeting the minimum requirements for support of HSDPA in the conditions defined above, such that CQI reported by the UE falls within the acceptable range.

### 9.3.3J.4 Method of test

#### 9.3.3J.4.1 Initial conditions

<FFS> According to 9.3.3I

#### 9.3.3J.4.2 Procedure

<FFS> According to 9.3.3I

### 9.3.3J.5 Test Requirements

The pass fail decision as specified in the test procedure in 9.3.3J.4.2.

No test tolerance is applied to the test parameters.

## 9.3.3K Reporting of HS-DSCH Channel Quality Indicator – category 27 MIMO

### 9.3.3K.1 Definition and applicability

The reporting accuracy of channel quality indicator (CQI) under AWGN and static orthogonal environments is determined by the reporting variance and the BLER performance using the transport format indicated by the reported CQI median. The CQI is measured while random data is streamed from the SS to the UE.

The normative reference for this test is 25.102 [21], section 9.

The requirements and this test apply to 1,28 Mcps TDD MIMO capable UEs category 27 from release 8 and later.

### 9.3.3K.2 Minimum requirements

For the parameters specified in tables 9.3.3K.1 the UE categories 27 shall report a CQI value within the limits of table 9.3.3K.2.

The MIMO dual stream static orthogonal propagation conditions are defined in Annex D.2.5.1. For UE supporting Spreading Factor 1 only in dual stream transmission, the number of HS-PDSCH codes per TS should be configured to 1 in dual stream transmission, and the HS-PDSCH<sub>i</sub>\_Ec/Ior should be 0dB.

**Table 9.3.3K.1: Test parameters for CQI reporting measurement channel requirements (1.28 Mcps TDD Option)**

Parameter	Unit	Category 27	
		Test 1	Test 2
Number of TS	-	5	
Number of HS-PDSCH codes per TS	-	16	
Number of HS-PDSCH codes per TS	-	16	
HS-PDSCH <sub>i</sub> _Ec/Ior	dB	-12.04	
HS-PDSCH Channelization Codes	C(k,Q)	C(i,16) 1 ≤ i ≤ 16	
Number of DPCH <sub>o</sub>	-	0	
Number of HARQ Process per stream	-	4	
Number of transmission	-	1	
loc	dBm	-60	
$\hat{I}_{oc} / I_{oc}$	dB	8	10
Stream Number configuration	-	Single Stream	Dual Stream
Propagation Channel	-	AWGN	Static Orthogonal

**Table 9.3.3K.2: Performance requirements for CQI reporting measurement channel requirements (1.28 Mcps TDD Option)**

Test	Permitted CQI range from median (x)	% of time that CQI must be within +/- x of median (Y)	Maximum BLER for median reported CQI
Test 1	+/-2	90	10%
Test 2	+/-2	90	

### 9.3.3K.3 Test purpose

To verify that the UE receiver is capable meeting the minimum requirements for support of HSDPA in the conditions defined above, such that CQI reported by the UE falls within the acceptable range.

### 9.3.3K.4 Method of test

#### 9.3.3K.4.1 Initial conditions

<FFS> According to 9.3.3I

#### 9.3.3K.4.2 Procedure

<FFS> According to 9.3.3I

### 9.3.3K.5 Test Requirements

The pass fail decision as specified in the test procedure in 9.3.3K.4.2.

No test tolerance is applied to the test parameters.

## 9.3.3L Reporting of HS-DSCH Channel Quality Indicator – category 28 MIMO

### 9.3.3L.1 Definition and applicability

The reporting accuracy of channel quality indicator (CQI) under AWGN and static orthogonal environments is determined by the reporting variance and the BLER performance using the transport format indicated by the reported CQI median. The CQI is measured while random data is streamed from the SS to the UE.

The normative reference for this test is 25.102 [21], section 9.

The requirements and this test apply to 1,28 Mcps TDD MIMO capable UEs category 28 from release 8 and later.

### 9.3.3L.2 Minimum requirements

For the parameters specified in tables 9.3.3L.1 the UE categories 28 shall report a CQI value within the limits of table 9.3.3L.2.

The MIMO dual stream static orthogonal propagation conditions are defined in Annex D.2.5.1. For UE supporting Spreading Factor 1 only in dual stream transmission, the number of HS-PDSCH codes per TS should be configured to 1 in dual stream transmission, and the HS-PDSCH<sub>i</sub>\_Ec/Ior should be 0dB.

**Table 9.3.3L.1: Test parameters for CQI reporting measurement channel requirements (1.28 Mcps TDD Option)**

Parameter	Unit	Category 28	
		Test 1	Test 2
Number of TS	-	3	
Number of HS-PDSCH codes per TS	-	16	
Number of HS-PDSCH codes per TS	-	16	
HS-PDSCH <sub>i</sub> _Ec/Ior	dB	-12.04	
HS-PDSCH Channelization Codes	C(k,Q)	C(i,16) 1 ≤ i ≤ 16	
Number of DPCH <sub>o</sub>	-	0	
Number of HARQ Process perstream	-	4	
Number of transmission	-	1	
loc	dBm	-60	
$\hat{I}_{or} / I_{oc}$	dB	16	18
Stream Number	-	Single Stream	Dual Stream
Propagation Channel	-	AWGN	Static Orthogonal

**Table 9.3.3L.2: Performance requirements for CQI reporting measurement channel requirements (1.28 Mcps TDD Option)**

Test	Permitted CQI range from median (x)	% of time that CQI must be within +/- x of median (Y)	Maximum BLER for median reported CQI
Test 1	+/- 2	90	10%
Test 2	+/- 2	90	

### 9.3.3L.3 Test purpose

To verify that the UE receiver is capable meeting the minimum requirements for support of HSDPA in the conditions defined above, such that CQI reported by the UE falls within the acceptable range.

### 9.3.3L.4 Method of test

#### 9.3.3L.4.1 Initial conditions

<FFS> According to 9.3.3I

#### 9.3.3L.4.2 Procedure

<FFS> According to 9.3.3I

### 9.3.3L.5 Test Requirements

The pass fail decision as specified in the test procedure in 9.3.3L.4.2.

No test tolerance is applied to the test parameters.

## 9.3.3M Reporting of HS-DSCH Channel Quality Indicator – category 29 MIMO

### 9.3.3M.1 Definition and applicability

The reporting accuracy of channel quality indicator (CQI) under AWGN and static orthogonal environments is determined by the reporting variance and the BLER performance using the transport format indicated by the reported CQI median. The CQI is measured while random data is streamed from the SS to the UE.

The normative reference for this test is 25.102 [21], section 9.

The requirements and this test apply to 1,28 Mcps TDD MIMO capable UEs category 29 from release 8 and later.

### 9.3.3M.2 Minimum requirements

For the parameters specified in tables 9.3.3M.1 the UE categories 29 shall report a CQI value within the limits of table 9.3.3M.2.

The MIMO dual stream static orthogonal propagation conditions are defined in Annex D.2.5.1. For UE supporting Spreading Factor 1 only in dual stream transmission, the number of HS-PDSCH codes per TS should be configured to 1 in dual stream transmission, and the HS-PDSCH<sub>i</sub>\_Ec/Ior should be 0dB.



**Table 9.3.3M.1: Test parameters for CQI reporting measurement channel requirements (1.28 Mcps TDD Option)**

Parameter	Unit	Category 29	
		Test 1	Test 2
Number of TS	-	4	
Number of HS-PDSCH codes per TS	-	16	
Number of HS-PDSCH codes per TS	-	16	
HS-PDSCH <sub>i</sub> Ec/Ior	dB	-12.04	
HS-PDSCH Channelization Codes	C(k,Q)	C(i,16) 1≤i≤16	
Number of DPCH <sub>o</sub>	-	0	
Number of HARQ Process perstream	-	4	
Number of transmission loc	-	1	
loc	dBm	-60	
$\hat{I}_{or} / I_{oc}$	dB	16	18
Stream Number	-	Single Stream	Dual Stream
Propagation Channel	-	AWGN	Static Orthogonal

**Table 9.3.3M.2: Performance requirements for CQI reporting measurement channel requirements (1.28 Mcps TDD Option)**

Test	Permitted CQI range from median (x)	% of time that CQI must be within +/- x of median (Y)	Maximum BLER for median reported CQI
Test 1	+/- 2	90	10%
Test 2	+/- 2	90	

### 9.3.3M.3 Test purpose

To verify that the UE receiver is capable meeting the minimum requirements for support of HSDPA in the conditions defined above, such that CQI reported by the UE falls within the acceptable range.

### 9.3.3M.4 Method of test

#### 9.3.3M.4.1 Initial conditions

<FFS> According to 9.3.3I

#### 9.3.3M.4.2 Procedure

<FFS> According to 9.3.3I

### 9.3.3M.5 Test Requirements

The pass fail decision as specified in the test procedure in 9.3.3M.4.2.

No test tolerance is applied to the test parameters.

## 9.3.3N Reporting of HS-DSCH Channel Quality Indicator – category 30 MIMO

### 9.3.3N.1 Definition and applicability

The reporting accuracy of channel quality indicator (CQI) under AWGN and static orthogonal environments is determined by the reporting variance and the BLER performance using the transport format indicated by the reported CQI median. The CQI is measured while random data is streamed from the SS to the UE.

The normative reference for this test is 25.102 [21], section 9.

The requirements and this test apply to 1,28 Mcps TDD MIMO capable UEs category 30 from release 8 and later.

### 9.3.3N.2 Minimum requirements

For the parameters specified in tables 9.3.3L.1 the UE categories 30 shall report a CQI value within the limits of table 9.3.3L.2.

The MIMO dual stream static orthogonal propagation conditions are defined in Annex D.2.5.1. For UE supporting Spreading Factor 1 only in dual stream transmission, the number of HS-PDSCH codes per TS should be configured to 1 in dual stream transmission, and the HS-PDSCH<sub>i</sub>\_Ec/Ior should be 0dB.

**Table 9.3.3N.1: Test parameters for CQI reporting measurement channel requirements (1.28 Mcps TDD Option)**

Parameter	Unit	Category 30	
		Test 1	Test 2
Number of TS	-	5	
Number of HS-PDSCH codes per TS	-	16	
Number of HS-PDSCH codes per TS	-	16	
HS-PDSCH <sub>i</sub> _Ec/Ior	dB	-12.04	
HS-PDSCH Channelization Codes	C(k,Q)	C(i,16) 1≤i≤16	
Number of DPCH <sub>o</sub>	-	0	
Number of HARQ Process perstream	-	4	
Number of transmission	-	1	
loc	dBm	-60	
$\hat{I}_{or} / I_{oc}$	dB	16	18
Stream Number	-	Single Stream	Dual Stream
Propagation Channel	-	AWGN	Static Orthogonal

**Table 9.3.3N.2: Performance requirements for CQI reporting measurement channel requirements (1.28 Mcps TDD Option)**

Test	Permitted CQI range from median (x)	% of time that CQI must be within +/- x of median (Y)	Maximum BLER for median reported CQI
Test 1	+/- 2	90	10%
Test 2	+/- 2	90	

### 9.3.3N.3 Test purpose

To verify that the UE receiver is capable meeting the minimum requirements for support of HSDPA in the conditions defined above, such that CQI reported by the UE falls within the acceptable range.

### 9.3.3N.4 Method of test

#### 9.3.3N.4.1 Initial conditions

<FFS> According to 9.3.3I

#### 9.3.3N.4.2 Procedure

<FFS> According to 9.3.3I

### 9.3.3N.5 Test Requirements

The pass fail decision as specified in the test procedure in 9.3.3N.4.2.

No test tolerance is applied to the test parameters.

## 9.3.4 HS-SCCH Detection Performance

### 9.3.4.1 Definition and applicability

The detection performance of the HS-SCCH is determined by the probability of event  $E_m$ , which is declared when the UE is signaled on HS-SCCH, but DTX is observed in the corresponding HS-SICH ACK/NACK field. The probability of event  $E_m$  is denoted  $P(E_m)$ .

This corresponds to case when the SS indicates to the UE via the HS-SCCH that HSDPA data is to be sent, but the UE fails to decode this correctly.

The normative reference for this test is 25.102 [2], section 9.

The requirements and this test apply to 1,28 Mcps TDD UE from release 5 and later that support HSDPA.

### 9.3.4.2 Minimum requirements

For the parameters specified in tables 9.3.4.1, for each value of HS-SCCH  $\hat{I}_{or}/I_{oc}$  specified in Table 9.3.4.3 the measured  $P(E_m)$  shall be less than or equal to the corresponding specified value of  $P(E_m)$ . The reference for this requirement is TS 25.102 [1] section 9.

### 9.3.4.3 Test purpose

To verify that the UE receiver is capable meeting the minimum requirements for support of HSDPA in the conditions defined below, and does not report a DTX when valid data was sent, more often than the performance limits allow.

**Table 9.3.4.1: Test parameters for HS-SCCH detection (1.28Mcps TDD option)**

Parameter	Unit	Test 1	Test2
Number of TS under test	-	1	
Number of HS-SCCH codes per timeslot	-	8 (4 x2)	
Scrambling code and basic midamble code number*	-	0	
Midamble		Common midamble	
Number of DPCH <sub>0</sub>	-	2	
Number of H-ARQ process	-	4	
HS-SCCH UE Identity ( $x_{ue,1}, x_{ue,2}, \dots, x_{ue,16}$ )	-	UE1 = 0000000000000000 (UE1 under test) UE2 = 0101010101010101 UE3 = 1010101010101010 UE4 = 1111111111111111	
HS-SCCH Channelization Codes*	C(k,Q)	C(i,16) 1 ≤ i ≤ 8	
HS-SCCH Channelization Codes for UE under test	C(k,Q)	C(i,16) 1 ≤ i ≤ 2	
DPCH <sub>0</sub> Channelization Codes	C(k,Q)	C(i,16) 9 ≤ i ≤ 10	
$\frac{HS-SCCH_i - E_c}{I_{or}}$	dB	-10	
$I_{oc}$	dBm/1.28MHz	-60	
Note *:	Refer to TS 25.223 for definition of channelization codes, scrambling code and basic midamble code.		

**Table 9.3.4.2: Test parameters for HS-PDSCH (1.28Mcps TDD option)**

Parameter	Unit	Test 1	Test2
Number of TS under test	-	2	
Number of HS-PDSCH codes per timeslot	-	10	
Scrambling code and basic midamble code number*	-	0	
HS-PDSCH Channelization Codes for UE under test	C(k,Q)	C(i,16) 1≤i≤10	
$\frac{HS - PDSCH_i - E_c}{I_{or}}$	dB	-10	
$I_{oc}$	dBm/1.28MHz	-60	
$\frac{\hat{I}_{or}}{I_{oc}}$	dB	**	
Note *: Refer to TS 25.223 for definition of channelization codes, scrambling code and basic midamble code.			
Note **: Allocate a sufficient power to $\frac{\hat{I}_{or}}{I_{oc}}$ so that probability of missing HS-DPSCH is very low.			

**Table 9.3.4.3: Minimum requirement for HS-SCCH detection (1.28Mcps TDD option)**

Test Number	Propagation Conditions	$\frac{\hat{I}_{or}}{I_{oc}}$ (dB)	$P(E_m)$
1	PA3	16	0.01
2	VA30	12	0.01

The propagation conditions are described in Annex D.

#### 9.3.4.4 Method of test

##### 9.3.4.4.1 Initial conditions

Test environment: normal; see clauses G.2.1 and G.2.2.

Frequencies to be tested: mid range; see clause G.2.4.

- 1) Connect SS, multipath fading simulator and an AWGN source to the UE antenna connector as shown in figure A.10.
- 2) Set Ack/Nack handling at the SS as table 9.3.1.1 (Fixed channel test)
- 3) Set up test parameter according to table 9.3.4.1 and able 9.3.4.2.

##### 9.3.4.4.2 Procedure

1. The UE is switched on.
2. An RRC connection is set-up according to the generic HSDPA set-up procedure specified in TS 34.108 [3].
3. Count the number of NACK, ACK and statDTX on the UL HS-SICH during the test interval and decide pass or fail according to Annex F.6.1 and table F.6.1.8. NACK and ACK are counted as a pass and statDTX is counted as a failure.

#### 9.3.4.5 Test Requirements

The probability of event  $E_m$  denoted as  $P(E_m)$  (test procedure step 3) shall not exceed the specified value in table 9.3.4.4.

**Table 9.3.4.4: Test requirement for HS-SCCH detection (1.28Mcps TDD option)**

Test Number	Propagation Conditions	$\frac{\hat{I}_{or}}{I_{oc}}$ (dB)	$P(E_m)$
1	PA3	16.6	0.01
2	VA30	12.6	0.01

## 9.4 Performance requirement for 7.68 Mcps TDD option

During the Fixed Reference Channel tests the behaviour of the Node-B emulator in response to the ACK/NACK signalling field of the HS-DPCCH is specified in Table 9.4.1:

**Table 9.4.1: Node-B Emulator Behaviour in response to ACK/NACK/DTX**

HS-DPCCH ACK/NACK Field State	Node-B Emulator Behaviour
ACK	ACK: new transmission using 1 <sup>st</sup> redundancy and constellation version (RV)
NACK	NACK: retransmission using the next RV (up to the maximum permitted number or RV's)
DTX	DTX: retransmission using the RV previously transmitted to the same H-ARQ process

### 9.4.1 HS-DSCH throughput for Fixed Reference Channels

#### 9.4.1.1 Definition and applicability

The HS-DSCH data throughput for fixed reference channels is defined by the capabilities of the UE as defined in [24], and the throughput is measured by counting the amount of data successfully received at the UE by monitoring the ACK/NACK signalling field of the HS-SICH received at the SS, while random data is streamed from the SS to the UE.

The normative reference for this test is 25.102 [2], section 9.3.

The requirements and this test apply to 7.68 Mcps TDD UE from release 7 and later that support HSDPA.

#### 9.4.1.2 Minimum requirements

The requirements are specified in terms of minimum information bit throughput R for the DL reference channels specified in Annex C.4.2A with the addition of the relevant parameters in Tables 9.4.1.1 and 9.4.1.3.

Using this configuration the throughput shall meet or exceed the minimum requirements specified in tables 9.4.1.2 and 9.4.1.4.

**Table 9.4.1.1: Test parameters for fixed reference measurement channel requirements for 5,3 Mbps – Category 8 - UE (7,68 Mcps TDD Option) QPSK**

Parameters	Unit	Test 1	Test 2	Test 3	Test 4
HS-PDSCH Modulation	-	QPSK			
Scrambling code and basic midamble code number*	-	0, 1			
Number of TS	-	4			
HS-PDSCH Channelization Codes*	C(k,Q)	C(i,32) i=1..32			
Number of Hybrid ARQ processes	-	3			
Maximum number of Hybrid ARQ transmissions	-	4			
Redundancy and constellation version coding sequence**	-	{0,0,0,0} s=1, R=0, b=0			
$\frac{HS - PDSCH - E_c}{I_{or}}$	dB	-15,05			
$\frac{\sum HS - PDSCH - E_c}{I_{or}}$	dB	0			
$I_{oc}$	dBm/7,68 MHz	-60			
Note *: Refer to TS 25.223 for definition of channelization codes, scrambling code and basic midamble code.					
Note **: This sequence implies Chase combining					

**Table 9.4.1.2: Performance requirements for fixed reference measurement channel requirement in multipath channels for 5,3 Mbps – Category 8 - UE (7,68 Mcps TDD Option) QPSK**

Test Number	Propagation conditions	$\frac{\hat{I}_{or}}{I_{oc}}$ [dB]	R (Throughput) [kbps]
1	PA3	5,2	880
2	PB3	5,5	880
3	VA30	6,2	880
4	VA120	6,2	880

**Table 9.4.1.3: Test parameters for fixed reference measurement channel requirements for 5,3 Mbps – Category 8 - UE (7,68 Mcps TDD Option) 16QAM**

Parameters	Unit	Test 1	Test 2	Test 3	Test 4
HS-PDSCH Modulation	-	16QAM			
Scrambling code and basic midamble code number*	-	0, 1			
Number of TS	-	4			
HS-PDSCH Channelization Codes*	C(k,Q)	C(i,32) i=1..32			
Number of Hybrid ARQ processes	-	3			
Maximum number of Hybrid ARQ transmissions	-	4			
Redundancy and constellation version coding sequence**	-	{0,0,0,0} s=1, R=0, b=0			
$\frac{HS - PDSCH - E_c}{I_{or}}$	dB	-15,05			
$\frac{\sum HS - PDSCH - E_c}{I_{or}}$	dB	0			
$I_{oc}$	dBm/7,68 MHz	-60			
Note *: Refer to TS 25.223 for definition of channelization codes, scrambling code and basic midamble code.					
Note **: This sequence implies Chase combining					

**Table 9.4.1.4: Performance requirements for fixed reference measurement channel requirement in multipath channels for 5,3 Mbps – Category 8 - UE (7,68 Mcps TDD Option) 16QAM**

Test Number	Propagation conditions	$\frac{\hat{I}_{or}}{I_{oc}}$ [dB]	R (Throughput) [kbps]
1	PA3	11,1	1765
2	PB3	13,2	1765
3	VA30	13,7	1765
4	VA120	13,6	1765

The reference for this requirement is TS 25.102 [1] clauses 9.3.1.1 and 9.3.1.2.

### 9.4.1.3 Test purpose

To verify the ability of the receiver to receive a predefined test signal, representing a multi-path fading channel with information bit throughput R not falling below a specified value.

### 9.4.1.4 Method of test

#### 9.4.1.4.1 Initial conditions

Test environment: normal; see clauses G.2.1 and G.2.2.

Frequencies to be tested: mid range; see clause G.2.4.

- 1) Connect the SS (node B emulator) and fader and AWGN noise source to the UE antenna connector as shown in figure A.10.
- 2) Set up an HSDPA call according to TS 34.108 [3] clause 7.3.6.3 with levels according to Annex E.3.
- 3) Set the node B emulator ACK/NACK/DTX behaviour according to table 9.4.1. Set the test parameters and levels for tests 1-4 according to tables 9.4.1.1. The reference channel configuration is defined in section C.4.2A. The configuration of the TX power for downlink physical channels is annex in E.3.

- 4) The information bit data shall be pseudo random and not repeated before 10 different information bit payload blocks are processed. (e.g. Fixed reference Channel Definition (16 QAM, test 1,2,3): The information bit payload block is 52996 bits long. Hence the PRBSequence must be at least  $52996 * 10$  bits long. ) Use a PRBS from ITU-T O.153 Ref [25].
- 5) Setup the fading simulator with fading conditions as described in table D.2.2.3.2 or D.2.2.3.4 depending on the frequency band.

#### 9.4.1.4.2 Procedure

- a. Once the HSDPA connection is setup, start transmitting HSDPA data.
- b. For all relevant propagation conditions, for all relevant  $I_{oc}$  levels, for all relevant  $E_c/I_{or}$ , for all relevant  $\hat{I}_{or}/I_{oc}$  defined in Tables 9.4.1.2 and 9.4.1.4 count the number of NACK, ACK and statDTX on the UL HS-SICH during the test interval and decide pass or fail according to Annex F.6.3 tables F.6.3.5.5 and F.6.3.5.6.

#### 9.4.1.5 Test Requirements

Tables 9.4.1.1 to 9.4.1.4 define the primary level settings including test tolerance for all relevant throughput tests. The pass / fail decision for throughput is done according to Annex F.6.3.

### 9.4.2 HS-DSCH throughput for Variable Reference Channels

FFS

### 9.4.3 Reporting of HS-DSCH Channel Quality Indicator

FFS

### 9.4.4 HS-SCCH Detection Performance

#### 9.4.4.1 Definition and applicability

The detection performance of the HS-SCCH is determined by the probability of event  $E_m$ , which is declared when the UE is signaled on HS-SCCH, but DTX is observed in the corresponding HS-SICH ACK/NACK field. The probability of event  $E_m$  is denoted  $P(E_m)$ .

The normative reference for this test is 25.102 [2], section 9.3.4.

The requirements and this test apply to 7.68 Mcps TDD UE from release 7 and later that support HSDPA.

#### 9.4.4.2 Minimum requirements

For the test parameters in Table 9.4.4.1, for each value of HS-SCCH-1  $E_c/I_{or}$  specified in Table 9.4.4.2, the measured  $P(E_m)$  shall be less than or equal to the corresponding specified value of  $P(E_m)$ .



**Table 9.4.4.1: Test parameters for HS-SCCH detection (7.68 Mcps TDD option)**

Parameter	Unit	Test 1	Test 2	Test 3
Number of TS under test	-	1		
Number of HS-SCCH codes per timeslot	-	4		
HS-SCCH UE Identity ( $x_{ue,1}, x_{ue,2}, \dots, x_{ue,16}$ )	-	UE1 = 0000000000000000 (UE1 under test) UE2 = 0101010101010101 UE3 = 1010101010101010 UE4 = 1111111111111111		
HS-SCCH Channelization Codes*	C(k,Q)	HS-SCCH-1 = C(1, 32), for UE1 (UE under test) HS-SCCH-2 = C(2, 32) for UE2 HS-SCCH-3 = C(3, 32) for UE3 HS-SCCH-4 = C(4, 32) for UE4		
HS-SCCH $E_c/I_{or}$	dB	HS-SCCH-2_ $E_c/I_{or}$ = HS-SCCH-3_ $E_c/I_{or}$ = HS-SCCH-4_ $E_c/I_{or}$ , Where, $\sum$ HS-SCCH-X_ $E_c/I_{or}$ = 1, where X = 1, 2, 3, 4		

**Table 9.4.4.2: Minimum requirement for HS-SCCH detection (7.68 Mcps TDD option)**

Test Number	Propagation Conditions	Reference value		
		HS-SCCH-1 $E_c/I_{or}$ (dB)	$\hat{I}_{or}/I_{oc}$ (dB)	$P(E_m)$
1	PA3	-6.0	0	0.05
2	PA3	-7.5	5	0.01
3	VA30	-6.0	0	0.01

The reference for this requirement is TS 25.102 [2] clause 9.3.4.

### 9.4.4.3 Test purpose

To verify that  $P(E_m)$  does not exceed the limit in table 9.4.4.2.

### 9.4.4.4 Method of test

#### 9.4.4.4.1 Initial conditions

Test environment: normal; see clauses G.2.1 and G.2.2.

Frequencies to be tested: mid range; see clause G.2.4.

1. Connect SS, multipath fading simulator and an AWGN noise source to the UE antenna connector as shown in figure A.10.
2. Setup fading simulators as fading condition, which are described in table D.2.2.3.1.
3. Set the node B emulator ACK/NACK/DTX behaviour according to table 9.2.1. Set the test parameters and levels for tests 1-3 according to tables 9.4.4.1 and 9.4.4.2. The reference channel configuration is defined in section C.4.2A. The configuration of the TX power for downlink physical channels is annex in E.3.

#### 9.4.4.4.2 Procedure

1. The UE is switched on.
2. Set up an HSDPA call according to TS 34.108 [3] clause 7.3.6.3.
3. Count the number of NACK, ACK and statDTX on the UL HS-DPCCH during the test interval and decide pass or fail according to Annex F.6.1 and table F.6.1.8. NACK and ACK are counted as a pass and statDTX is counted as a failure.

### 9.4.4.5 Test Requirements

The probability of event  $E_m$  denoted as  $P(E_m)$  (test procedure step 3) shall not exceed the specified value in table 9.4.4.2.

No test tolerance is applied to the test parameters.

## 10 Performance requirements (MBMS)

### 10.1 Demodulation of MCCH

#### 10.1.1 Definition and applicability

##### 10.1.1.1 3.84 Mcps TDD Option

The receive characteristic of the MCCH is determined by the RLC SDU error rate (RLC\_SDU\_ER). The requirement is valid for all RRC states for which the UE has capabilities.

The requirements and this test apply to the 3,84 Mcps TDD UE.

##### 10.1.1.2 7.68 Mcps TDD Option

The receive characteristic of the MCCH is determined by the RLC SDU error rate (RLC\_SDU\_ER). The requirement is valid for all RRC states for which the UE has capabilities.

The requirements and this test apply to the 7,68 Mcps TDD UE.

#### 10.1.2 Minimum requirement

##### 10.1.2.1 3.84 Mcps TDD Option

For the parameters specified in Table 10.1.1, the measured average downlink S-CCPCH\_Ec/I<sub>or</sub> power ratio shall be below the specified value for the RLC\_SDU\_ER shown in Table 10.1.2.

**Table 10.1.1: Test parameters for MCCH detection**

Parameters	Unit	Test 1
$I_{oc}$	dBm/3.84 MHz	-60
$\frac{\hat{I}_{or}}{I_{oc}}$	dB	-3
Number of Interfering codes/timeslot	-	7 × SF16
MCCH Data Rate	kbps	7.2
Propagation condition	-	VA3

**Table 10.1.2: Test requirements for MCCH detection**

Test Number	S-CCPCH_Ec/I <sub>or</sub> (dB)	RLC_SDU_ER
1	-1.25	0.01

##### 10.1.2.2 7.68 Mcps TDD Option

For the parameters specified in Table 10.1.3, the measured average downlink S-CCPCH\_Ec/I<sub>or</sub> power ratio shall be below the specified value for the RLC\_SDU\_ER shown in Table 10.1.4.

**Table 10.1.3: Test parameters for MCCH detection**

Parameters	Unit	Test 1
$I_{oc}$	dBm/7.68 MHz	-60
$\frac{\hat{I}_{or}}{I_{oc}}$	dB	-3
Number of Interfering codes/timeslot	-	15 x SF32
MCCH Data Rate	kbps	7.2
Propagation condition	-	VA3

**Table 10.1.4: Test requirements for MCCH detection**

Test Number	S-CCPCH_Ec/Ior (dB)	RLC_SDU_ER
1	-4.7	0.01

### 10.1.3 Test Purpose

The aim of the test is to verify that the RLC SDU error rate (RLC SDU ER) for the MCCH channel does not exceed 0.01.

### 10.1.4 Method of test

#### 10.1.4.1 Initial conditions

- 1) Connect the SS and AWGN noise source and fading simulator to the UE antenna connector as shown in Figure A.10.
- 2) The MCCH Reference Measurement Channel parameters are defined in Annex C.5.1.
- 3) The configuration for the downlink channel for each radio link is defined in Annex.E.
- 4) The UE is switched on.
- 5) Set up a call according to the generic call setup procedure in TS34.108 [3] clause 7.3.10.
- 6) Setup the test parameter for MCCH detection test as specified in Table 10.1.1 and 10.1.2 for 3.84 Mcps TDD and Table 10.1.3. and 10.1.4 for 7.68 Mcps TDD. Set up fading simulator as per the fading condition VA3, which is described in table D.2.2.
- 7) Enter the UE into loopback test mode 3. See TS 34.108 and TS 34.109 for details regarding loopback test mode 3 for MBMS.
- 8) Switch on the fading simulator.

#### 10.1.4.2 Procedure

- 1) SS shall start the test by sending data on the MCCH radio bearer and maintain the count of transmitted RLC SDU blocks on the MCCH.
- 2) SS shall send a "UE TEST LOOP MODE 3 RLC SDU COUNTER REQUEST" message and wait for the UE to response with a "UE TEST LOOP MODE 3 RLC SDU COUNTER RESPONSE" reporting the received RLC SDU counter value.
- 3) SS shall compute the RLC SDU error rate based on the transmitted RLC SDUs count and received RLC SDU count reported by the UE.
- 4) The test shall be run until the statistical significance according to Annex to F.6.1.8 is achieved.

## 10.1.5 Test Requirements

The RLC SDU error rate (RLC SDU ER) for all the MTCH demodulation tests shall not exceed 0.1 for the specified

$$\frac{\hat{I}_{or}}{I_{oc}}$$

The RLC SDU error rate = the ratio of (transmitted RLC SDU count – received RLC SDU count) / (transmitted RLC SDU count) < 0.1

## 10.2 Demodulation of MTCH

### 10.2.1 Definition and applicability

#### 10.2.1.1 3.84 Mcps TDD Option

The receive characteristic of the MTCH is determined by RLC SDU error rate (RLC SDU ER). RLC SDU ER is specified for each individual data rate of the MTCH. The requirement is valid for all RRC states for which the UE has capabilities for MBMS.

The requirements and this test apply to the 3,84 Mcps TDD UE.

#### 10.2.1.2 1.28 Mcps TDD Option

The receive characteristic of the MTCH is determined by RLC SDU error rate (RLC SDU ER). RLC SDU ER is specified for each individual data rate of the MTCH. The requirement is valid for all RRC states for which the UE has capabilities for MBMS.

The requirements and this test apply to Release 6 and later releases for all types of UTRA for the 1.28Mcps TDD UE that support MBMS.

#### 10.2.1.3 7.68 Mcps TDD Option

The receive characteristic of the MTCH is determined by RLC SDU error rate (RLC SDU ER). RLC SDU ER is specified for each individual data rate of the MTCH. The requirement is valid for all RRC states for which the UE has capabilities for MBMS.

The requirements and this test apply to the 7,68 Mcps TDD UE.

### 10.2.2 Minimum requirement

#### 10.2.2.1 3.84 Mcps TDD Option

For the parameters specified in Table 10.2.1 the average downlink  $\frac{\hat{I}_{or}}{I_{oc}}$  power ratio shall be below the specified value for the RLC SDU ER shown in Table 10.2.2.

**Table 10.2.1: Parameters for MTCH detection for 3.84Mcps TDD**

Parameters	Unit	Test 1	Test 2	Test 3	Test 4
$I_{oc}$	dBm/3.84 MHz	-60			
$\Sigma(S\text{-CCPCH\_}E_c)/I_{or}$ per active timeslot	dB	0	0	0	0
MTCH Data Rate	Kbps	128	256	256	256
Propagation condition	-	VA3		Extended Delay Spread (see Table B.1D)	
Number of Radio Links	-	2	3	1	1
S-CCPCH Modulation	-	QPSK	QPKS	16QAM	16QAM
Number of UE Rx Branches	-	1	1	1	2

**Table 10.2.2: Test requirements for MTCH detection for 3.84Mcps TDD**

Test Number	$\frac{\hat{I}_{or}}{I_{oc}}$ (dB)	RLC SDU ER
1	5.7	0.1
2	5.5	0.1
3	14.5	0.1
4	8.3	0.1

### 10.2.2.2 1.28 Mcps TDD Option

For the parameters specified in Table 10.2.3 the average downlink  $\frac{\hat{I}_{or}}{I_{oc}}$  power ratio shall be below the specified value for the RLC SDU ER shown in Table 10.2.4.

**Table 10.2.3: Parameters for MTCH detection**

Parameters	Unit	Test 1	Test 2
$I_{oc}$	dBm/1.28 MHz	-60	
$\Sigma(S\text{-CCPCH\_}E_c)/I_{or}$ per active timeslot	dB	0	
MTCH Data Rate	kbps	64	128
Number of codes per timeslot	-	8xSF16	14xSF16
Number of interfering codes per timeslot	-	0	0
Propagation condition	-	VA3	
Number of Radio Links	-	3	3

**Table 10.2.4: Test requirements for MTCH detection**

Test Number	$\frac{\hat{I}_{or}}{I_{oc}}$ (dB)	RLC SDU ER
1	4.8	0.1
2	6.0	0.1

### 10.2.2.3 7.68 Mcps TDD Option

For the parameters specified in Table 10.2.5 the average downlink  $\frac{\hat{I}_{or}}{I_{oc}}$  power ratio shall be below the specified value for the RLC SDU ER shown in Table 10.2.6.

**Table 10.2.5.: Parameters for MTCH detection for 7.68 Mcps TDD**

Parameters	Unit	Test 1	Test 2	Test 3	Test 4
$I_{oc}$	dBm/7.68 MHz	-60			
$\Sigma(S\text{-CCPCH\_}E_c)/I_{or}$ per active timeslot	dB	-3	-3	-3	-3
MTCH Data Rate	Kbps	128	256	256	256
Number of interfering codes/timeslot	-	16 x SF32	16 x SF32	16 x SF32	16 x SF32
Propagation condition	-	VA3		Extended Delay Spread (see Table B.8)	
Number of Radio Links	-	2	3	1	1
S-CCPCH Modulation	-	QPSK	QPSK	16QAM	16QAM
Number of UE Rx Branches	-	1	1	1	2

**Table 10.2.6: Test requirements for MTCH detection for 7.68 Mcps TDD**

Test Number	$\frac{\hat{I}_{or}}{I_{oc}}$ (dB)	RLC SDU ER
1	6.1	0.1
2	5.0	0.1
3	14.7	0.1
4	8.2	0.1

### 10.2.3 Test Purpose

The aim of the test is to verify that the RLC SDU error rate (RLC SDU ER) for each individual data rate of the MTCH channel does not exceed 0.1. The test shall be performed in CELL\_PCH state only.

### 10.2.4 Method of test

#### 10.2.4.1 Initial conditions

- 1) Connect the SS and AWGN noise source and fading simulator to the UE antenna connector as shown in Figure A.16.
- 2) The DL Reference Measurement Channel parameters are defined in Annex C.5.2.
- 3) The same MTCH data shall be sent in all radio links during the test.
- 4) The UE is switched on.
- 5) Set up a call according to the generic call setup procedure in TS34.108 [3] clause 7.3.10 with transition to the CELL\_PCH state.
- 6) Setup the test parameter for MTCH detection test as specified in Table 10.2.1 and 10.2.2 for 3.84 Mcps TDD , Table 10.2.3 and 10.2.4 for 1.28Mcps TDD and Table 10.2.5. and 10.2.6 for 7.68 Mcps TDD. Set up fading simulator as per the fading conditionVA3, which is described in table D.2.2.
- 7) Enter the UE into loopback test mode 3. See TS 34.108 and TS 34.109 for details regarding loopback test mode 3 for MBMS.
- 8) Switch on the fading simulator.

#### 10.2.4.2 Procedure

- 1) SS shall start the test by sending data on the MTCH radio bearer and maintain the count of transmitted RLC SDU blocks on the MTCH.
- 2) SS shall send a "UE TEST LOOP MODE 3 RLC SDU COUNTER REQUEST" message and wait for the UE to response with a "UE TEST LOOP MODE 3 RLC SDU COUNTER RESPONSE" reporting the received RLC SDU counter value.
- 3) SS shall compute the RLC SDU error rate based on the transmitted RLC SDUs count and received RLC SDU count reported by the UE.
- 4) The test shall be run until the statistical significance according to Annex to F.6.1.8 is achieved.

### 10.2.5 Test Requirements

The RLC SDU error rate (RLC SDU ER) for all the MTCH demodulation tests does not exceed 0.1.

The RLC SDU error rate = the ratio of (transmitted RLC SDU count – received RLC SDU count) / (transmitted RLC SDU count) < 0.1

## 10.2A Demodulation of MTCH-for MBSFN capable UE

### 10.2A.1 Definition and applicability

10.2A.1.1 Void

10.2A.1.2 1.28 Mcps TDD Option

The receive characteristic of the MTCH is determined by RLC SDU error rate (RLC SDU ER). RLC SDU ER is specified for each individual data rate of the MTCH. The requirement is valid for all RRC states for which the UE has capabilities for MBMS.

The requirements and this test apply to Release 7 and later releases for all types of UTRA for the 1.28Mcps TDD UE that support MBSFN.

10.2A.1.3 Void

### 10.2A.2 Minimum requirement

10.2A.2.1 Void

10.2A.2.2 1.28 Mcps TDD Option

For the parameters specified in Table 10.2A.3A the average downlink  $\frac{\hat{I}_{or}}{I_{oc}}$  power ratio shall be below the specified value for the RLC SDU ER shown in Table 10.2A.4A.

**Table 10.2A.3A: Parameters for MTCH detection**

Parameters	Unit	Test 1 <sup>1</sup>	Test 2 <sup>1</sup>	Test 3 <sup>2</sup>	Test 4 <sup>2</sup>
MTCH Data rate	Kbps	192	384	192	384
Rx antenna	-	1	2	1	2
Modulation	-	QPSK	16QAM	QPSK	16QAM
$I_{oc}$	dBm/1.28 MHz	-60	-60	-60	-60
$\Sigma(S\text{-CCPCH\_}E_c)/I_{or}$	dB	0	0	0	0
Propagation condition	-	MBSFN channel model 1 (Annex D)	MBSFN channel model 1 (Annex D)	MBSFN channel model 2 (Annex D)	MBSFN channel model 2 (Annex D)
Slot Format #	-	0 <sup>4</sup>	2 <sup>4</sup>	4 <sup>4</sup>	7 <sup>4</sup>

NOTE1: Test 1 and Test 2 are specified for the UE supporting normal delay spread.

NOTE2: Test 3 and Test 4 are specified for the UE supporting extended delay spread.

NOTE3: In the case of Rx diversity, the fading of the signals and the AWGN signals applied to each receiver antenna connector shall be uncorrelated.

NOTE4: See Table 8Ha in TS25.221.

**Table 10.2A.4A: Test requirements for MTCH detection**

Test Number	$\frac{\hat{I}_{or}}{I_{oc}}$ (dB)	RLC SDU ER
1	13.3	0.1
2	14.7	0.1
3	13.3	0.1
4	15.1	0.1

### 10.2A.2.3 Void

## 10.2A.3 Test Purpose

The aim of the test is to verify that the RLC SDU error rate (RLC SDU ER) for each individual data rate of the MTCH channel does not exceed 0.1. The test shall be performed in CELL\_PCH state only.

## 10.2A.4 Method of test

### 10.2A.4.1 Initial conditions

- 1) Connect the SS and AWGN noise source and fading simulator to the UE antenna connector as shown in Figure A.16.
- 2) The DL Reference Measurement Channel parameters are defined in Annex C.5.2.
- 3) The same MTCH data shall be sent in all radio links during the test.
- 4) The UE is switched on.
- 5) Set up a call according to the generic call setup procedure in TS34.108 [3] clause 7.3.10 with transition to the CELL\_PCH state.
- 6) Setup the test parameter for MTCH detection test as specified in Table 10.2A.3A and 10.2A.4A for 1.28Mcps TDD. Set up fading simulator as per the fading condition, which is described in table D.2.2.2.3.
- 7) Enter the UE into loopback test mode 3. See TS 34.108 and TS 34.109 for details regarding loopback test mode 3 for MBMS.
- 8) Switch on the fading simulator.

### 10.2A.4.2 Procedure

- 1) SS shall start the test by sending data on the MTCH radio bearer and maintain the count of transmitted RLC SDU blocks on the MTCH.
- 2) SS shall send a "UE TEST LOOP MODE 3 RLC SDU COUNTER REQUEST" message and wait for the UE to response with a "UE TEST LOOP MODE 3 RLC SDU COUNTER RESPONSE" reporting the received RLC SDU counter value.
- 3) SS shall compute the RLC SDU error rate based on the transmitted RLC SDUs count and received RLC SDU count reported by the UE.
- 4) The test shall be run until the statistical significance according to Annex to F.6.1.8 is achieved.

## 10.2A.5 Test Requirements

The RLC SDU error rate (RLC SDU ER) for all the MTCH demodulation tests does not exceed 0.1.

The RLC SDU error rate = the ratio of (transmitted RLC SDU count – received RLC SDU count) / (transmitted RLC SDU count) < 0.1

## 10.3 Demodulation of MTCH and cell identification

### 10.3.1 1.28Mcps TDD option

#### 10.3.1.1 Definition and applicability

MBMS combining is not controlled by a network but instead it is autonomously handled by a terminal. UE has to be able to receive MTCH and identify intra-frequency neighbour cells according to the requirements. The receive characteristic of the MTCH combined with cell identification is determined by RLC SDU error rate (RLC SDU ER).

The requirements and this test apply to Release 6 and later releases for 1.28Mcps TDD UE that supports MBMS.



### 10.3.1.2 Minimum requirements

For the parameters specified in Table 10.3.1.1 the average downlink S-CCPCH  $\frac{\hat{I}_{or}}{I_{oc}}$  power ratio shall be below the specified value for the RLC SDU error rate shown in Table 10.3.1.2. The cell reselection parameters are given in clause in Table 10.3.1.3. The different cells are assumed to be time aligned.

**Table 10.3.1.1: Parameters for MTCH demodulation requirements with cell identification**

Parameter	Unit	Test 1		
		Stage 1	Stage 2	Stage 3
Time in each stage	s	2s	800ms	2s
$I_{oc}$	dBm/1.28MHz	-60		
Propagation condition		VA 3		
MTCH Data Rate	kbps	64kbps		
Number of Radio Links		Cell 1, Cell 2	Cell 1, Cell2, Cell3	Cell 1, Cell 3

**Table 10.3.1.2: Requirements for MTCH detection**

Test Number	$\frac{\hat{I}_{or}}{I_{oc}}$	RLC SDU ER
1	6.1	0.05

Parameters for combined MTCH demodulation and cell identification requirements are defined in Table 10.3.1.3.

**Table 10.3.1.3: Cell reselection parameters**

Parameter	Unit	Value
Serving cell in the initial condition		Cell1
Neighbour cells		32 intra-frequency neighbour cells are indicated including Cell2 and Cell3
Cell_selection_and_reselection_quality_measure		PCCPCH RSCP
Qrxlevmin	dBm	-103
UE_TXPWR_MAX_RACH	dB	21
Treselection	Seconds	4
Sintrasearch	dB	not sent
IE "FACH Measurement occasion info"		not sent

The reference for this requirement is TS 25.102 [1] clause 10.3.1 and TS 25.102 [1] annex A.4.2.2.

### 10.3.1.3 Test purpose

To verify that the RLC SDU error rate does not exceed the value at the S-CCPCH  $\frac{\hat{I}_{or}}{I_{oc}}$  r specified in table 10.3.1.2.

### 10.3.1.4 Method of test

#### 10.3.1.4.1 Initial conditions

Test environment: normal; see clauses G.2.1 and G.2.2.

Frequencies to be tested: mid range; see clause G.2.4.

- 1) Connect the SS and AWGN noise source and fading simulators to the UE antenna connector as shown in Figure A.16.
- 2) The DL Reference Measurement Channel parameters are defined in Annex C.5.1.2
- 3) The same MTCH data shall be sent in all active cells during the test.
- 4) The UE is switched on.
- 5) The UE selects the broadcast service provided by the SS (included in the MBMS\_ACTIVATED\_SERVICES variable).
- 6) Set up a call according to the generic call setup procedure specified in TS 34.108 [3] clause 7.3.10 to configure and activate an MBMS session with transition to CELL\_PCH state. The SS broadcast the cell reselection parameters according to table 10.3.1.3.

#### 10.3.1.4.2 Procedures

- 1) The SS configures and activates cell 1 to 3 with RF parameters according to Stage 1 conditions in Table 10.3.1.1.
- 2) The SS transmits valid MAC headers and RLC SDUs on the MTCH radio bearer for 2 seconds. The SS counts the number of transmitted RLC SDUs on the MTCH with valid MAC headers ( $N_{SS\_Stage1}$ ).
- 3) The SS transmits invalid MAC headers sets the test parameters for Cell 1, Cell 2 and Cell 3 as specified in table 10.3.1.1 and Stage 2.
- 4) The SS transmits valid MAC headers and RLC SDUs on the MTCH radio bearer for 0.8 seconds. The SS counts the number of transmitted RLC SDUs on the MTCH with valid MAC headers ( $N_{SS\_Stage2}$ ).
- 5) The SS transmits invalid MAC headers sets the test parameters for Cell 1, Cell 2 and Cell 3 as specified in table 10.3.1.1 and Stage 3.
- 6) The SS transmits valid MAC headers and RLC SDUs on the MTCH radio bearer for 2 seconds. The SS counts the number of transmitted RLC SDUs on the MTCH with valid MAC headers ( $N_{SS\_Stage3}$ ).
- 7) Repeat step 9) to 14) until the confidence level for RLC SDU's according to annex F.6.1.8.
- 8) The SS transmits a PAGING TYPE 1 message to the UE on the PCH and the UE moves to CELL\_FACH state, sending a CELL UPDATE message. The SS replies with a CELL UPDATE CONFIRM message.
- 9) The UE confirms the received C-RNTI to be used in CELL FACH state by transmitting a UTRAN MOBILITY INFORMATION CONFIRM message on the uplink DCCH.
- 10) The SS sends a "UE TEST LOOP MODE 3 RLC SDU COUNTER REQUEST" message.
- 11) The SS waits for the UE to respond by a "UE TEST LOOP MODE 3 RLC SDU COUNTER RESPONSE" message reporting the number of received RLC SDUs on MTCH ( $N_{UEOK}$ ).
- 12) The SS in Cell 1 calculates the SDU error rate as:  $(\text{Number of SS transmitted RLC SDUs} - \text{UE received RLC SDUs}) / \text{Number of SS transmitted RLC SDUs}$ ; where  $\text{Number of SS transmitted RLC SDUs} = N_{SS\_Stage1} + N_{SS\_Stage2} + N_{SS\_Stage3}$ ; and  $\text{UE received RLC SDUs} = N_{UEOK}$ .
- 13) End the RRC connection according to the generic call setup procedure specified in TS 34.108 [3] clause 7.3.10.

#### Specific Message Contents

All messages indicated above shall use the same content as described in the default message content in clause 9 of 34.108 [3].

#### 10.3.1.5 Test requirements

The test parameters are specified in table 10.3.1.4.

**Table 10.3.1.4: Parameters for MTCH demodulation requirements with cell identification**

Parameter	Unit	Test 1		
		Stage 1	Stage 2	Stage 3
Time in each stage	s	2s	800ms	2s
$I_{oc}$	dBm/1.28MHz	-60		
Propagation condition		VA 3		
MTCH Data Rate	kbps	64kbps		
Number of Radio Links		Cell 1, Cell 2	Cell 1, Cell2, Cell3	Cell 1, Cell 3

The RLC SDU ER shall not exceed the value specified in table 10.3.1.5 for the specified  $\frac{\hat{I}_{or}}{I_{oc}}$

**Table 10.3.1.5: Requirements for MTCH detection**

Test Number	$\frac{\hat{I}_{or}}{I_{oc}}$	RLC SDU ER
1	6.1	0.05

NOTE: If the above Test Requirement differs from the Minimum Requirement then the Test Tolerance applied for this test is non-zero. The Test Tolerance for this test is defined in clause F.2 and the explanation of how the Minimum Requirement has been relaxed by the Test Tolerance is given in clause F.4.

## 10.4 Demodulation of MCCH for a MBSFN capable UE

### 10.4.1 Definition and applicability

#### 10.4.1.1 3.84 Mcps TDD Option

The test is only applicable for UEs with at least two receiver antenna connectors where the fading of the signals and the AWGN signals applied to each receiver antenna connector shall be uncorrelated.

The receive characteristic of the MCCH is determined by the RLC SDU error rate (RLC\_SDU\_ER). The requirement is valid for all RRC states for which the UE has capabilities.

The requirements and this test apply to the 3,84 Mcps TDD UE.

#### 10.4.1.2 7.68 Mcps TDD Option

The test is only applicable for UEs with at least two receiver antenna connectors where the fading of the signals and the AWGN signals applied to each receiver antenna connector shall be uncorrelated.

The receive characteristic of the MCCH is determined by the RLC SDU error rate (RLC\_SDU\_ER). The requirement is valid for all RRC states for which the UE has capabilities.

The requirements and this test apply to the 7,68 Mcps TDD UE.

### 10.1.2 Minimum requirement

#### 10.1.4.1 3.84 Mcps TDD Option

For the parameters specified in table 10.4.1, the measured average downlink S-CCPCH $E_c/I_{or}$  power ratio shall be below the specified value for the RLC\_SDU\_ER shown in table 10.4.2.

**Table 10.4.1: Test parameters for MCCH detection for MBSFN enabled UE**

Parameters	Unit	Test 1
$I_{oc}$	dBm/3.84 MHz	-60
$\frac{\hat{I}_{or}}{I_{oc}}$	dB	12
Number of Interfering codes/timeslot	-	7 × SF16
MCCH Data Rate	kbps	7.2
Propagation condition	-	Extended delay spread (see Appendix B)
Slot Format #i	-	20

**Table 10.4.2: Test requirements for MCCH detection (at least two receiver antennas) for MBSFN enabled UE**

Test Number	S-CCPCH_Ec/I <sub>or</sub> (dB)	RLC_SDU_ER
1	-19.29	0.01

#### 10.4.2.2 7.68 Mcps TDD Option

For the parameters specified in table 10.4.3, the measured average downlink S-CCPCH\_Ec/I<sub>or</sub> power ratio shall be below the specified value for the RLC\_SDU\_ER shown in table 10.4.4.

**Table 10.4.3: Test parameters for MCCH detection for MBSFN enabled UE**

Parameters	Unit	Test 1
$I_{oc}$	dBm/7.68 MHz	-60
$\frac{\hat{I}_{or}}{I_{oc}}$	dB	12
Number of Interfering codes/timeslot	-	15 × SF32
MCCH Data Rate	kbps	7.2
Propagation condition	-	Extended delay spread (see Appendix B)
Slot Format #i	-	20

**Table 10.4.4: Test requirements for MCCH detection (at least two receiver antennas) for MBSFN enabled UE**

Test Number	S-CCPCH_Ec/I <sub>or</sub> (dB)	RLC_SDU_ER
1	-22.71	0.01

### 10.4.3 Test Purpose

The aim of the test is to verify that the RLC SDU error rate (RLC SDU ER) for the MCCH channel does not exceed 0.01.

### 10.4.4 Method of test

#### 10.4.4.1 Initial conditions

- 1) Connect the SS and AWGN noise source and fading simulator to the UE antenna connector as shown in Figure A.17.
- 2) The MCCH Reference Measurement Channel parameters are defined in Annex C.5.1.
- 3) The configuration for the downlink channel for each radio link is defined in Annex.E.

- 4) The UE is switched on.
- 5) Set up a call according to the generic call setup procedure in TS34.108 [3] clause 7.3.10.
- 6) Setup the test parameter for MCCH detection test as specified in Table 10.4.1 and 10.4.2 for 3.84 Mcps TDD and Table 10.4.3. and 10.4.4 for 7.68 Mcps TDD. Set up fading simulator as per the fading condition EDS, which is described in table D.2.2.1B for 3.84Mcps and table D.2.2.3.5 for 3.84Mcps.
- 7) Enter the UE into loopback test mode 3. See TS 34.108 and TS 34.109 for details regarding loopback test mode 3 for MBMS.
- 8) Switch on the fading simulator.

#### 10.4.4.2 Procedure

- 1) SS shall start the test by sending data on the MCCH radio bearer and maintain the count of transmitted RLC SDU blocks on the MCCH.
- 2) SS shall send a "UE TEST LOOP MODE 3 RLC SDU COUNTER REQUEST" message and wait for the UE to response with a "UE TEST LOOP MODE 3 RLC SDU COUNTER RESPONSE" reporting the received RLC SDU counter value.
- 3) SS shall compute the RLC SDU error rate based on the transmitted RLC SDUs count and received RLC SDU count reported by the UE.
- 4) The test shall be run until the statistical significance according to Annex to F.6.1.8 is achieved.

#### 10.4.5 Test Requirements

The RLC SDU error rate (RLC SDU ER) for all the MTCH demodulation tests shall not exceed 0.1 for the specified S-CCPCH\_ $E_c/I_{or}$  power ratio.

The RLC SDU error rate = the ratio of (transmitted RLC SDU count – received RLC SDU count) / (transmitted RLC SDU count) < 0.1

### 10.5 Demodulation of MTCH for a MBSFN capable UE

#### 10.5.1 Definition and applicability

##### 10.5.1.1 3.84 Mcps TDD Option

The test is only applicable for UEs with at least two receiver antenna connectors where the fading of the signals and the AWGN signals applied to each receiver antenna connector shall be uncorrelated.

The receive characteristic of the MTCH is determined by RLC SDU error rate (RLC SDU ER). RLC SDU ER is specified for each individual data rate of the MTCH. The requirement is valid for all RRC states for which the UE has capabilities for MBMS.

The requirements and this test apply to the 3,84 Mcps TDD UE.

##### 10.2.1.2 7.68 Mcps TDD Option

The test is only applicable for UEs with at least two receiver antenna connectors where the fading of the signals and the AWGN signals applied to each receiver antenna connector shall be uncorrelated.

The receive characteristic of the MTCH is determined by RLC SDU error rate (RLC SDU ER). RLC SDU ER is specified for each individual data rate of the MTCH. The requirement is valid for all RRC states for which the UE has capabilities for MBMS.

The requirements and this test apply to the 7,68 Mcps TDD UE.

## 10.5.2 Minimum requirement

### 10.5.2.1 3.84 Mcps TDD Option

For the parameters specified in Table 10.5.1 the average downlink  $\frac{\hat{I}_{or}}{I_{oc}}$  power ratio shall be below the specified value for the RLC SDU ER shown in Table 10.5.2.

**Table 10.5.1: Parameters for MTCH detection for 3.84Mcps TDD for MBSFN capable UE**

Parameters	Unit	Test 1
$I_{oc}$	dBm/3.84 MHz	-60
$\Sigma(S\text{-CCPCH\_}E_c)/I_{or}$ per active timeslot	dB	0
MTCH Data Rate	kbps	512
Propagation condition	-	Extended delay spread (see Appendix B)
Number of Radio Links	-	1
S-CCPCH Modulation	-	16QAM

**Table 10.5.2: Test requirements for MTCH detection for 3.84Mcps TDD for MBSFN capable UE (at least two receiver antennas)**

Test Number	$\frac{\hat{I}_{or}}{I_{oc}}$ (dB)	RLC SDU ER
1	14.58	0.1

### 10.5.2.2 7.68 Mcps TDD Option

For the parameters specified in Table 10.5.3 the average downlink  $\frac{\hat{I}_{or}}{I_{oc}}$  power ratio shall be below the specified value for the RLC SDU ER shown in Table 10.5.4.

**Table 10.5.3.: Parameters for MTCH detection for 7.68 Mcps TDD**

Parameters	Unit	Test 1
$I_{oc}$	dBm/7.68 MHz	-60
$\Sigma(S\text{-CCPCH\_}E_c)/I_{or}$ per active timeslot	dB	-3
MTCH Data Rate	kbps	512
Number of interfering codes/timeslot	-	16 × SF32
Propagation condition	-	Extended delay spread (see Appendix B)
Number of Radio Links	-	1
S-CCPCH Modulation	-	16QAM

**Table 10.5.4: Test requirements for MTCH detection for 7.68 Mcps TDD**

Test Number	$\frac{\hat{I}_{or}}{I_{oc}}$ (dB)	RLC SDU ER
1	14.21	0.1

## 10.5.3 Test Purpose

The aim of the test is to verify that the RLC SDU error rate (RLC SDU ER) for each individual data rate of the MTCH channel does not exceed 0.1. The test shall be performed in CELL\_PCH state only.

## 10.5.4 Method of test

### 10.5.4.1 Initial conditions

- 1) Connect the SS and AWGN noise source and fading simulator to the UE antenna connector as shown in Figure A.17.
- 2) The DL Reference Measurement Channel parameters are defined in Annex C.5.2.
- 3) The configuration for the downlink channel for each radio link is defined in Annex.E..
- 4) The UE is switched on.
- 5) Set up a call according to the generic call setup procedure in TS34.108 [3] clause 7.3.10 with transition to the CELL\_PCH state.
- 6) Setup the test parameter for MTCH detection test as specified in Table 10.5.1 and 10.5.2 for 3.84 Mcps TDD , and Table 10.5.5. and 10.5.6 for 7.68 Mcps TDD. Set up fading simulator as per the fading condition EDS, which is described in table D.2.2.1B for 3.84Mcps and table D.2.2.3.5 for 3.84Mcps.
- 7) Enter the UE into loopback test mode 3. See TS 34.108 and TS 34.109 for details regarding loopback test mode 3 for MBMS.
- 8) Switch on the fading simulator.

### 10.2.4.2 Procedure

- 1) SS shall start the test by sending data on the MTCH radio bearer and maintain the count of transmitted RLC SDU blocks on the MTCH.
- 2) SS shall send a "UE TEST LOOP MODE 3 RLC SDU COUNTER REQUEST" message and wait for the UE to response with a "UE TEST LOOP MODE 3 RLC SDU COUNTER RESPONSE" reporting the received RLC SDU counter value.
- 3) SS shall compute the RLC SDU error rate based on the transmitted RLC SDUs count and received RLC SDU count reported by the UE.
- 4) The test shall be run until the statistical significance according to Annex to F.6.1.8 is achieved.

## 10.5.5 Test Requirements

The RLC SDU error rate (RLC SDU ER) for all the MTCH demodulation tests does not exceed 0.1.

The RLC SDU error rate = the ratio of (transmitted RLC SDU count – received RLC SDU count) / (transmitted RLC SDU count) < 0.1

## 10.5A Demodulation of MTCH for a IMB capable UE

### 10.5A.1 Definition and applicability

The test is only applicable for UEs with at least two receiver antenna connectors where the fading of the signals and the AWGN signals applied to each receiver antenna connector shall be uncorrelated.

The receive characteristic of the MTCH is determined by RLC SDU error rate (RLC SDU ER). RLC SDU ER is specified for each individual data rate of the MTCH. The requirement is valid for all RRC states for which the UE has capabilities for MBMS.

### 10.5A.2 Minimum requirement

For the parameters specified in Table 10.5A.1a the measured average downlink S-CCPCH<sub>E<sub>c</sub></sub>/I<sub>or</sub> power ratio shall be below the specified value for the RLC SDU ER shown in Table 10.5A.2a.

**Table 10.5A.1a: Parameters for MTCH detection**

Parameters	Unit	Test 1
$I_{oc}$	dBm/3.84MHz	-60
$\frac{\hat{I}_{or}}{I_{oc}}$	dB	12
MTCH Data Rate	kbps	512 (see Annex C)
Propagation condition	-	Extended Delay Spread (see Annex D)

**Table 10.5A.2a: Test requirements for MTCH detection (at least two receiver antennas)**

Test Number	S-CCPCH $E_c/I_{or}$ (dB)	RLC SDU ER
1	-3.5	0.1

### 10.5A.3 Test Purpose

The aim of the test is to verify that the RLC SDU error rate (RLC SDU ER) for each individual data rate of the MTCH channel does not exceed 0.1.

### 10.5A.4 Method of test

#### 10.5A.4.1 Initial conditions

- 1) Connect the SS and AWGN noise source and fading simulator to the UE antenna connector as shown in Figure A.17.
- 2) The DL Reference Measurement Channel parameters are defined in Annex C.5.2.
- 3) The configuration for the downlink channel for each radio link is defined in Annex.E..
- 4) The UE is switched on.
- 5) Set up a call according to the generic call setup procedure in TS34.108 [3] clause 7.3.10 with transition to the CELL\_PCH state.
- 6) Setup the test parameter for MTCH detection test as specified in Table 10.5A.1a and 10.5A.2a for 3.84 Mcps TDD IMB. Set up fading simulator as per the fading condition EDS, which is described in table D.2.2.1B for 3.84Mcps.
- 7) Enter the UE into loopback test mode 3. See TS 34.108 and TS 34.109 for details regarding loopback test mode 3 for MBMS.
- 8) Switch on the fading simulator.

#### 10.5A.4.2 Procedure

- 1) SS shall start the test by sending data on the MTCH radio bearer and maintain the count of transmitted RLC SDU blocks on the MTCH.
- 2) SS shall send a "UE TEST LOOP MODE 3 RLC SDU COUNTER REQUEST" message and wait for the UE to response with a "UE TEST LOOP MODE 3 RLC SDU COUNTER RESPONSE" reporting the received RLC SDU counter value.
- 3) SS shall compute the RLC SDU error rate based on the transmitted RLC SDUs count and received RLC SDU count reported by the UE.
- 4) The test shall be run until the statistical significance according to Annex to F.6.1.8 is achieved.



## 10.5A.5 Test Requirements

The RLC SDU error rate (RLC SDU ER) for all the MTCH demodulation tests does not exceed 0.1.

The RLC SDU error rate = the ratio of (transmitted RLC SDU count – received RLC SDU count) / (transmitted RLC SDU count) < 0.1

## 10.6 MBSFN TDD and FDD same platform sharing

### 10.6.1 Definition and applicability

#### 10.6.1.1 3.84 Mcps TDD Option

This test case is to ensure that a simultaneous demodulation of MTCH and FDD transmission is possible for a MBSFN TDD UE sharing the same platform with a FDD UE. The test is only applicable for TDD UEs with at least two receiver antenna connectors where the fading of the signals and the AWGN signals applied to each receiver antenna connector shall be uncorrelated.

The receive characteristic of the MTCH is determined by RLC SDU error rate (RLC SDU ER). RLC SDU ER is specified for each individual data rate of the MTCH. The requirement is valid for all RRC states for which the UE has capabilities for MBMS.

The requirements and this test apply to the 3,84 Mcps TDD (non-IMB) UE.

#### 10.6.1.2 7.68 Mcps TDD Option

This test case is to ensure that a simultaneous demodulation of MTCH and FDD transmission is possible for a MBSFN TDD UE sharing the same platform with a FDD UE. The test is only applicable for TDD UEs with at least two receiver antenna connectors where the fading of the signals and the AWGN signals applied to each receiver antenna connector shall be uncorrelated.

The receive characteristic of the MTCH is determined by RLC SDU error rate (RLC SDU ER). RLC SDU ER is specified for each individual data rate of the MTCH. The requirement is valid for all RRC states for which the UE has capabilities for MBMS.

The requirements and this test apply to the 7,68 Mcps TDD UE.

### 10.6.2 Minimum requirement

#### 10.6.2.1 3.84 Mcps TDD Option

For the parameters specified in Table 10.6.1 the average downlink  $\hat{I}_{or}$  power shall be below the specified value for the RLC SDU ER shown in Table 10.6.2.

**Table 10.6.1: Parameters for MTCH detection sharing same platform with FDD for 3.84Mcps TDD**

Parameters	Unit	Test 1	Test 2
FDD UE Tx Pwr	dBm/ 3.84 MHz	Nominal Maximum Output Power	Nominal Maximum Output Power
$I_{oc}$	dBm/ 3.84 MHz	-infinity	-infinity
$\Sigma(S\text{-CCPCH\_}E_c)/I_{or}$ per active timeslot	dB	0	0
MTCH Data Rate	kbps	512	512
Number of interfering codes/timeslot	-	0	0
Propagation condition	-	Extended Delay Spread (see Appendix B)	Extended Delay Spread (see Appendix B)
Number of Radio Links	-	1	1
S-CCPCH Modulation	-	16QAM	16QAM
TDD operating frequencies	MHz	1900-1920	2570-2620
FDD operating band	-	Band I	Band VII
TDD/FDD carrier frequencies	-	Applicable for all combinations of TDD and FDD carrier frequencies except for combinations where the carrier frequency separation is less than 15 MHz	Applicable for all combinations of TDD and FDD carrier frequencies except for combinations where the carrier frequency separation is less than 15 MHz

**Table 10.6.2: Test requirements for MTCH detection sharing same platform with FDD for 3.84Mcps TDD UE (at least two receiver antennas)**

Test Number	$\hat{I}_{or}$ (dBm)	RLC SDU ER
1	-83.42	0.1
2	-83.42	0.1

### 10.6.2.3 7.68 Mcps TDD Option

For the parameters specified in Table 10.6.3 the average downlink  $\hat{I}_{or}$  power shall be below the specified value for the RLC SDU ER shown in Table 10.6.4.

**Table 10.6.3: Parameters for MTCH detection sharing same platform with FDD for 7.68Mcps TDD**

Parameters	Unit	Test 1	Test 2
FDD UE Tx Pwr	dBm/ 3.84 MHz	Nominal Maximum Output Power	Nominal Maximum Output Power
$I_{oc}$	dBm/ 7.68 MHz	-infinity	-infinity
$\Sigma(S\text{-CCPCH\_}E_c)/I_{or}$ per active timeslot	dB	-3	-3
MTCH Data Rate	kbps	512	512
Number of interfering codes/timeslot	-	16 x SF32	16 x SF32
Propagation condition	-	Extended Delay Spread (see Appendix B)	Extended Delay Spread (see Appendix B)
Number of Radio Links	-	1	1
S-CCPCH Modulation	-	16QAM	16QAM
TDD operating frequencies	MHz	1900-1920	2570-2620
FDD operating band	-	Band I	Band VII
TDD/FDD carrier frequencies	-	Applicable for all combinations of TDD and FDD carrier frequencies except for combinations where the carrier frequency separation is less than 17.5 MHz	Applicable for all combinations of TDD and FDD carrier frequencies except for combinations where the carrier frequency separation is less than 17.5 MHz

**Table 10.6.4: Test requirements for MTCH detection sharing same platform with FDD for 3.84Mcps TDD UE (at least two receiver antennas)**

Test Number	$I_{or}$ (dBm)	RLC SDU ER
1	-80.79	0.1
2	-80.79	0.1

### 10.6.3 Test Purpose

The aim of the test is to verify that the RLC SDU error rate (RLC SDU ER) for each individual data rate of the MTCH channel does not exceed 0.1. The test shall be performed in CELL\_PCH state only.

### 10.6.4 Method of test

#### 10.6.4.1 Initial conditions

- 1) Connect the SS and AWGN noise source and fading simulator to the UE antenna connector as shown in Figure A.17.
- 2) The DL Reference Measurement Channel parameters are defined in Annex C.5.2.
- 3) The configuration for the downlink channel for each radio link is defined in Annex.E..
- 4) The UE is switched on.
- 5) Set up a call according to the generic call setup procedure in TS34.108 [3] clause 7.3.10 with transition to the CELL\_PCH state.
- 6) Setup the test parameter for MTCH detection test as specified in Table 10.5.1 and 10.5.2 for 3.84 Mcps TDD , and Table 10.5.5. and 10.5.6 for 7.68 Mcps TDD. Set up fading simulator as per the fading condition EDS, which is described in table D.2.2.1B for 3.84Mcps and table D.2.2.3.5 for 3.84Mcps.
- 7) Enter the UE into loopback test mode 3. See TS 34.108 and TS 34.109 for details regarding loopback test mode 3 for MBMS.
- 8) Use the SS to ensure that the UE is transmitting an FDD signal as defined in table 10.6.1 for 3.84Mcps TDD and table 10.6.3 for 7.68Mcps TDD.
- 9) Switch on the fading simulator.

#### 10.6.4.2 Procedure

- 1) SS shall start the test by sending data on the MTCH radio bearer and maintain the count of transmitted RLC SDU blocks on the MTCH.
- 2) SS shall send a "UE TEST LOOP MODE 3 RLC SDU COUNTER REQUEST" message and wait for the UE to response with a "UE TEST LOOP MODE 3 RLC SDU COUNTER RESPONSE" reporting the received RLC SDU counter value.
- 3) SS shall compute the RLC SDU error rate based on the transmitted RLC SDUs count and received RLC SDU count reported by the UE.
- 4) The test shall be run until the statistical significance according to Annex to F.6.1.8 is achieved.

### 10.6.5 Test Requirements

The RLC SDU error rate (RLC SDU ER) for all the MTCH demodulation tests does not exceed 0.1.

The RLC SDU error rate = the ratio of (transmitted RLC SDU count – received RLC SDU count) / (transmitted RLC SDU count) < 0.1

## 11 Performance requirement (E-DCH)

### 11.1 Detection of E-DCH HARQ ACK Indicator Channel (E-HICH)

#### 11.1.1 Definition and applicability

##### 11.1.1.1 3.84 Mcps TDD Option

The performance of the E-HICH detection is determined by the false ACK probability (probability of detecting an ACK given that a NACK was sent) and the false NACK probability (probability of detecting a NACK given that an ACK was sent).

The requirements and this test apply to Release 7 and later releases for all types of UTRA for the 3.84 Mcps TDD UE that support HSDPA and E-DCH.

##### 11.1.1.2 1.28 Mcps TDD Option

The performance of the E-HICH detection is determined by the false ACK probability (probability of detecting an ACK given that a NACK was sent) and the false NACK probability (probability of detecting a NACK given that an ACK was sent).

The requirements and this test apply to Release 7 and later releases for all types of UTRA for the 1.28 Mcps TDD UE that support HSDPA and E-DCH.

##### 11.1.1.3 7.68 Mcps TDD Option

The performance of the E-HICH detection is determined by the false ACK probability (probability of detecting an ACK given that a NACK was sent) and the false NACK probability (probability of detecting a NACK given that an ACK was sent).

The requirements and this test apply to Release 7 and later releases for all types of UTRA for the 7.68 Mcps TDD UE that support HSDPA and E-DCH.

### 11.1.2 Minimum requirement

#### 11.1.2.1 3.84 Mcps TDD Option

For the parameters specified in Table 11.1.1 the average downlink E-HICH  $E_c/I_{or}$  power ratio shall be below the specified value for the false ACK and false NACK probabilities shown in Table 11.1.2.

**Table 11.1.1: Test parameters for E-HICH detection (3.84 Mcps TDD option)**

Parameters	Unit	Test 1	Test 2
$I_{oc}$	dBm/3.84 MHz	-60	
$\frac{\hat{I}_{or}}{I_{oc}}$	dB	0	
Number of Interfering codes/timeslot	-	7 × SF16 (all codes have equal powers)	
E-HICH signalling pattern	-	100% NACK	100% ACK
Propagation condition	-	VA30	

**Table 11.1.2: Test requirements for E-HICH detection (3.84 Mcps TDD option)**

Test Number	E-HICH $E_c/I_{or}$ (dB)	Parameter	Probability
1	-18.5	False ACK	2E-3
2	-18.5	False NACK	2E-2

### 11.1.2.2 1.28 Mcps TDD Option

For the parameters specified in Table 11.1.3 the average downlink E-HICH  $E_c/I_{or}$  power ratio shall be below the specified value for the false ACK and false NACK probabilities shown in Table 11.1.4.

**Table 11.1.3: Test parameters for E-HICH detection (1.28 Mcps TDD option)**

Parameters	Unit	Test 1	Test 2
$I_{oc}$	dBm/1.28 MHz	-60	
$\frac{\hat{I}_{or}}{I_{oc}}$	dB	0	
Number of Interfering codes/timeslot	-	7 × SF16 (all codes have equal powers)	
E-HICH signalling pattern	-	100% NACK	100% ACK
Propagation condition	-	VA30	

**Table 11.1.4: Test requirements for E-HICH detection (1.28 Mcps TDD option)**

Test Number	E-HICH $E_c/I_{or}$ (dB)	Parameter	Probability
1	-7.5	False ACK	2E-3
2	-7.5	False NACK	2E-2

### 11.1.2.3 7.68 Mcps TDD Option

For the parameters specified in Table 11.3 the average downlink E-HICH  $E_c/I_{or}$  power ratio shall be below the specified value for the false ACK and false NACK probabilities shown in Table 11.4.

**Table 11.1.5: Test parameters for E-HICH detection (7.68 Mcps TDD option)**

Parameters	Unit	Test 1	Test 2
$I_{oc}$	dBm/7.68 MHz	-60	
$\frac{\hat{I}_{or}}{I_{oc}}$	dB	0	
Number of Interfering codes/timeslot	-	15 × SF32 (all codes have equal powers)	
E-HICH signalling pattern	-	100% NACK	100% ACK
Propagation condition	-	VA30	

**Table 11.1.6: Test requirements for E-HICH detection (7.68 Mcps TDD option)**

Test Number	E-HICH $E_c/I_{or}$ (dB)	Parameter	Probability
1	-21.7	False ACK	2E-3
2	-21.7	False NACK	2E-2

## 11.1.3 Test Purpose

The test verifies that the false ACK probability and false NACK probability of E-HICH meet the requirement.

## 11.1.4 Method of test

### 11.1.4.1 Initial conditions

#### 11.1.4.1.1 3.84Mcps TDD Option

Test environment: normal; see clauses G.2.1 and G.2.2.

Frequencies to be tested: mid range; see clause G.2.4.

- 1) Connect the SS and AWGN noise source and fading simulator to the UE antenna connector as shown in figure Figure A.10.
- 2) Set the test parameters for the false ACK test and the false NACK test as specified in table 11.1.1.
- 3) The UL Reference Measurement Channel parameters are defined in Annex C.6.1.1 and DL Reference Measurement Channel parameters are defined in Annex C4.1.1.1
- 4) The value of TRRI shall be set to '111111' and CRRI on E-AGCH shall be set to 15. Note that the radio bearer reconfiguration message used to configure the UE will define 6 E-PUCH TS and therefore the length of the TRRI will be 6 bits.
- 5) The value of PRRI is set to 31. This ensures that the UL datarate remains constant.
- 6) The UE is switched on.
- 7) Enter the UE into loopback mode 1, looping back both the 12.2kbps RMC and HSDPA to E-DCH, and start the loopback test. See TS 34.108 [3] clause 7.3.9 and TS 34.109 [4] clauses 5.3.2.3 and 5.3.2.6. To fill the RLC transmit buffer, run the loopback for [3]s before starting the procedure.
- 8) Switch on the fading simulator.

#### 11.1.4.1.2 1.28Mcps TDD Option

Test environment: normal; see clauses G.2.1 and G.2.2.

Frequencies to be tested: mid range; see clause G.2.4.

- 1) Connect the SS and AWGN noise source and fading simulator to the UE antenna connector as shown in figure Figure A.10.
- 2) Set the test parameters for the false ACK test and the false NACK test as specified in 11.1.3 for 1.28Mcps TDD option.
- 3) The UL Reference Measurement Channel parameters are defined in Annex C.6.1.2 and DL Reference Measurement Channel parameters are defined in Annex C4.2.1.1
- 4) The value of TRRI shall be set to '11000' and CRRI on E-AGCH shall be set to 3.
- 5) The value of PRRI is same. This ensures that the UL datarate remains constant.
- 6) The UE is switched on.
- 7) Enter the UE into loopback mode 1, looping back both the 12.2kbps RMC and HSDPA to E-DCH, and start the loopback test. See TS 34.108 [3] clause 7.3.9 and TS 34.109 [4] clauses 5.3.2.3 and 5.3.2.6. To fill the RLC transmit buffer, run the loopback for [3]s before starting the procedure.
- 8) Switch on the fading simulator.

#### 11.1.4.1.3 7.68Mcps TDD Option

Test environment: normal; see clauses G.2.1 and G.2.2.

Frequencies to be tested: mid range; see clause G.2.4.

- 1) Connect the SS and AWGN noise source and fading simulator to the UE antenna connector as shown in figure Figure A.10.
- 2) Set the test parameters for the false ACK test and the false NACK test as specified in table 11.1.1.
- 3) The UL Reference Measurement Channel parameters are defined in Annex C.6.1.3 and DL Reference Measurement Channel parameters are defined in Annex C4.2A.1.1
- 4) The value of TRRI shall be set to '111111' and CRRI on E-AGCH shall be set to 31. Note that the radio bearer reconfiguration message used to configure the UE will define 6 E-PUCH TS and therefore the length of the TRRI will be 6 bits.

- 5) The value of PRRI is set to 31. This ensures that the UL datarate remains constant.
- 6) The UE is switched on.
- 7) Enter the UE into loopback mode 1, looping back both the 12.2kbps RMC and HSDPA to E-DCH, and start the loopback test. See TS 34.108 [3] clause 7.3.9 and TS 34.109 [4] clauses 5.3.2.3 and 5.3.2.6. To fill the RLC transmit buffer, run the loopback for [3]s before starting the procedure.
- 8) Switch on the fading simulator.

#### 11.1.4.2 3.84Mcps TDD Option

The measurement principle for the false ACK test (step 2 to 5) and for the false NACK test (step 6 to 9) is as follows. Upon the UE transmission on E-UCCH and E-PUCH, the SS reacts with E-HICH = ACK or NACK. The UE transmits new data or retransmissions on the corresponding E-UCCH and E-PUCH. The SS shall discriminate between:

- (1) new data is a sign for ACK, received by the UE
- (2) retransmission is a sign for NACK, received by the UE . The later is interpreted as NACK by higher layer and causes retransmission.

1. The Nominal Avg. Information Bit Rate in the DL is set to 2649.6kbps according to Annex C4.1.1.1. The expected throughput under this level and fading conditions is 1300 kbps. The UL datarate was configured by signalling TRRI=111111 and CRRI=15 on the E-AGCH. The expected UL datarate is 34.7 kbps corresponding to E-TFC Index 46.
2. In the test false ACK the SS responds with 100% ACK.
3. If the UE indicates on the E-UCCH a retransmission, the ACK from the SS was received as NACK by the UE. This is counted as false(ACK).  
If the UE indicates on the E-UCCH new data, the ACK from the SS was received as ACK by the UE. This is counted as correct ACK.
4. Continue until statistical significance according to Annex F.6.4 is achieved.
5. If the number of retransmissions reaches the maximum number of retransmissions due to several false ACK detections in series, the first new data on the E-PUCH with E-UCCH are not the consequence of ACK. This case is not counted as sample.
6. In the test false NACK the SS responds with 100% NACK.
7. If the UE indicates on the E-UCCH new data, the NACK from the SS was received as ACK by the UE. This is counted as false(NACK) . If the UE indicates on E-UCCH retransmission, the NACK from the SS was received as NACK by the UE. This is counted as correct reception.
8. Continue until statistical significance according to Annex F.6.4 is achieved.
9. The number of retransmissions will reach the maximum number of transmissions due to several retransmissions in series. The first new data on the E-PUCH with E-UCCH are not the consequence of ACK received by the UE. This case is not counted as sample.

#### 11.1.4.2.2 1.28Mcps TDD Option

The measurement principle for the false ACK test (step 2 to 5) and for the false NACK test (step 6 to 9) is as follows. Upon the UE transmission on E-UCCH and E-PUCH, the SS reacts with E-HICH = ACK or NACK. The UE transmits new data or retransmissions on the corresponding E-UCCH and E-PUCH. The SS shall discriminate between:

- (1) new data is a sign for ACK, received by the UE
- (2) retransmission is a sign for NACK, received by the UE . The later is interpreted as NACK by higher layer and causes retransmission.

1. The Nominal Avg. Information Bit Rate in the DL is set to 199.2 kbps according to FRC1 in Annex C4.2.1.1. The expected throughput under this level and fading conditions is 161 kbps. The UL datarate was configured by signalling TRRI=11000 and CRRI=3 on the E-AGCH. The expected UL datarate is 57.4 kbps corresponding to E-TFC Index 56.
2. In the test false ACK the SS responds with 100% ACK.
3. If the UE indicates on the E-UCCH a retransmission, the ACK from the SS was received as NACK by the UE. This is counted as false(ACK).  
  
If the UE indicates on the E-UCCH new data, the ACK from the SS was received as ACK by the UE. This is counted as correct ACK.
4. Continue until statistical significance according to Annex F.6.4 is achieved.
5. If the number of retransmissions reaches the maximum number of retransmissions due to several false ACK detections in series, the first new data on the E-PUCH with E-UCCH are not the consequence of ACK. This case is not counted as sample.
6. In the test false NACK the SS responds with 100% NACK.
7. If the UE indicates on the E-UCCH new data, the NACK from the SS was received as ACK by the UE. This is counted as false(NACK). If the UE indicates on E-UCCH retransmission, the NACK from the SS was received as NACK by the UE. This is counted as correct reception.
8. Continue until statistical significance according to Annex F.6.4 is achieved.
9. The number of retransmissions will reach the maximum number of transmissions due to several retransmissions in series. The first new data on the E-PUCH with E-UCCH are not the consequence of ACK received by the UE. This case is not counted as sample.

#### 11.1.4.2.3 7.68Mcps TDD Option

The measurement principle for the false ACK test (step 2 to 5) and for the false NACK test (step 6 to 9) is as follows. Upon the UE transmission on E-UCCH and E-PUCH, the SS reacts with E-HICH = ACK or NACK. The UE transmits new data or retransmissions on the corresponding E-UCCH and E-PUCH. The SS shall discriminate between:

- (1) new data is a sign for ACK, received by the UE
- (2) retransmission is a sign for NACK, received by the UE. The later is interpreted as NACK by higher layer and causes retransmission.

1. The Nominal Avg. Information Bit Rate in the DL is set to 1761.2 kbps according to Annex C4.2A.1.1. The expected throughput under this level and fading conditions is 880 kbps. The UL datarate was configured by signalling TRRI=111111 and CRRI=15 on the E-AGCH. The expected UL datarate is 35.9 kbps corresponding to E-TFC Index 41.
2. In the test false ACK the SS responds with 100% ACK.
3. If the UE indicates on the E-UCCH a retransmission, the ACK from the SS was received as NACK by the UE. This is counted as false(ACK).  
  
If the UE indicates on the E-UCCH new data, the ACK from the SS was received as ACK by the UE. This is counted as correct ACK.
4. Continue until statistical significance according to Annex F.6.4 is achieved.
5. If the number of retransmissions reaches the maximum number of retransmissions due to several false ACK detections in series, the first new data on the E-PUCH with E-UCCH are not the consequence of ACK. This case is not counted as sample.
6. In the test false NACK the SS responds with 100% NACK.



7. If the UE indicates on the E-UCCH new data, the NACK from the SS was received as ACK by the UE. This is counted as false(NACK). If the UE indicates on E-UCCH retransmission, the NACK from the SS was received as NACK by the UE. This is counted as correct reception.
8. Continue until statistical significance according to Annex F.6.4 is achieved.
9. The number of retransmissions will reach the maximum number of transmissions due to several retransmissions in series. The first new data on the E-PUCH with E-UCCH are not the consequence of ACK received by the UE. This case is not counted as sample.

## 11.1.5 Test Requirements

The false ACK and false NACK detection probability shall not exceed to the values specified in Table 11.1.2 for 3.84 Mcps TDD option, 11.1.4 for 1.28Mcps TDD option and Table 11.1.6 for 7.68 Mcps TDD option.

## 11.2 Demodulation of E-DCH Absolute Grant Channel (E-AGCH)

### 11.2.1 Definition and applicability

#### 11.2.2.1 3.84 Mcps TDD Option

The performance of the E-AGCH detection is determined by the missed detection probability.

The requirements and this test apply to Release 7 and later releases for all types of UTRA for the 3.84 Mcps TDD UE that support HSDPA and E-DCH.

#### 11.2.2.2 1.28 Mcps TDD Option

The performance of the E-AGCH detection is determined by the missed detection probability.

The requirements and this test apply to Release 7 and later releases for all types of UTRA for the 1.28 Mcps TDD UE that support HSDPA and E-DCH.

#### 11.2.2.3 7.68 Mcps TDD Option

The performance of the E-AGCH detection is determined by the missed detection probability.

The requirements and this test apply to Release 7 and later releases for all types of UTRA for the 7.68 Mcps TDD UE that support HSDPA and E-DCH.

### 11.2.2 Minimum requirement

#### 11.2.2.1 3.84 Mcps TDD Option

For the parameters specified in Table 11.2.1 the average downlink E-AGCH  $\hat{I}_{or}/I_{oc}$  power ratio shall be below the specified value for the missed detection probability shown in Table 11.2.2.

**Table 11.2.1: Test parameters for E-AGCH detection (3.84 Mcps TDD option)**

Parameters	Unit	Test 1
$I_{oc}$	dBm/3.84 MHz	-60
$\frac{E_c}{I_{or}}$	dB	-6.02
Number of Interfering codes/timeslot	-	3 × SF16
Total bits in Timeslot Resource Related Information (TRRI)	bits	6
Total bits in Resource Duration Indicator (RDI)	bits	3
Total bits in E-AGCH	bits	38
Propagation condition	-	VA30

**Table 11.2.2: Test requirements for E-AGCH detection (3.84 Mcps TDD option)**

Test Number	E-AGCH $\hat{I}_{or}/I_{oc}$ (dB)	Missed Detection Probability
1	1.6	0.01

### 11.2.2.2 1.28Mcps TDD Option

For the parameters specified in Table 11.2.3 the average downlink  $\hat{I}_{or}/I_{oc}$  power ratio shall be below the specified value for the missed detection probability shown in Table 11.2.4.

**Table 11.2.3: Test parameters for E-AGCH detection (1.28 Mcps TDD option)**

Parameters	Unit	Test 1
$I_{oc}$	dBm/1.28 MHz	-60
$\frac{E - AGCH\_E_c}{I_{or}}$	dB	-3
Number of Interfering codes/timeslot	-	2 × SF16
Total bits in Timeslot Resource Related Information (TRRI)	bits	5
Total bits in Resource Duration Indicator (RDI)	bits	3
Total bits in E-AGCH	bits	26
Propagation condition	-	VA30

**Table 11.2.4: Test requirements for E-AGCH detection (1.28 Mcps TDD option)**

Test Number	$\hat{I}_{or}/I_{oc}$ (dB)	Missed Detection Probability
1	8	0.01

### 11.2.2.3 7.68 Mcps TDD Option

For the parameters specified in Table 11.2.5 the average downlink E-AGCH  $\hat{I}_{or}/I_{oc}$  power ratio shall be below the specified value for the missed detection probability shown in Table 11.2.6.

**Table 11.2.5: Test parameters for E-AGCH detection (7.68 Mcps TDD option)**

Parameters	Unit	Test 1
$I_{oc}$	dBm/7.68 MHz	-60
$\frac{E_c}{I_{or}}$	dB	-9.03
Number of Interfering codes/timeslot	-	7 × SF32
Total bits in Timeslot Resource Related Information (TRRI)	bits	6
Total bits in Resource Duration Indicator (RDI)	bits	3
Total bits in E-AGCH	bits	39
Propagation condition	-	VA30

**Table 11.2.6: Test requirements for E-AGCH detection (7.68 Mcps TDD option)**

Test Number	E-AGCH $\hat{I}_{or}/I_{oc}$ (dB)	Missed Detection Probability
1	1.2	0.01

## 11.2.3 Test Purpose

The aim of the test is to verify that the missed detection probability of the E-AGCH channel does not exceed 0.01.

## 11.2.4 Method of test

### 11.2.4.1 Initial conditions

#### 11.2.4.1.1 3.84Mcps TDD Option

Test environment: normal; see clauses G.2.1 and G.2.2.

Frequencies to be tested: mid range; see clause G.2.4.

- 1) Connect the SS and AWGN noise source and fading simulator to the UE antenna connector as shown in figure Figure A.10.
- 2) Set the test parameters for the miss detection E-AGCH test as specified in table 11.2.1.
- 3) The UL Reference Measurement Channel parameters are defined in Annex C.6.1.1 and DL Reference Measurement Channel parameters are defined in Annex C4.1.1.1
- 4) The value of TRRI shall be set to '111111' and CRRI on E-AGCH shall be set to 15.
- 5) The UE is switched on.
- 6) Enter the UE into loopback mode 1, looping back both the 12.2kbps RMC and HSDPA to E-DCH, and start the loopback test. See TS 34.108 [3] clause 7.3.9 and TS 34.109 [4] clauses 5.3.2.3 and 5.3.2.6. To fill the RLC transmit buffer, run the loopback for [3]s before starting the procedure.
- 7) Switch on the fading simulator.

#### 11.2.4.1.2 1.28Mcps TDD Option

Test environment: normal; see clauses G.2.1 and G.2.2.

Frequencies to be tested: mid range; see clause G.2.4.

- 1) Connect the SS and AWGN noise source and fading simulator to the UE antenna connector as shown in figure Figure A.10.
- 2) Set the test parameters for the miss detection E-AGCH test as specified in 11.2.3 for 1.28Mcps TDD option.
- 3) The UL Reference Measurement Channel parameters are defined in Annex C.6.1.2 and DL Reference Measurement Channel parameters are defined in Annex C4.2.1.1
- 4) The value of TRRI shall be set to '11000' and CRRI on E-AGCH shall be set to 3.
- 5) The UE is switched on.
- 6) Enter the UE into loopback mode 1, looping back both the 12.2kbps RMC and HSDPA to E-DCH, and start the loopback test. See TS 34.108 [3] clause 7.3.9 and TS 34.109 [4] clauses 5.3.2.3 and 5.3.2.6. To fill the RLC transmit buffer, run the loopback for [3]s before starting the procedure.
- 7) Switch on the fading simulator.

#### 11.2.4.1.3 7.68Mcps TDD Option

Test environment: normal; see clauses G.2.1 and G.2.2.

Frequencies to be tested: mid range; see clause G.2.4.

- 1) Connect the SS and AWGN noise source and fading simulator to the UE antenna connector as shown in figure Figure A.10.
- 2) Set the test parameters for the miss detection E-AGCH test as specified in table 11.2.1.
- 3) The UL Reference Measurement Channel parameters are defined in Annex C.6.1.3 and DL Reference Measurement Channel parameters are defined in Annex C4.2A.1.1
- 4) The value of TRRI shall be set to '111111' and CRRI on E-AGCH shall be set to 31.

- 5) The UE is switched on.
- 6) Enter the UE into loopback mode 1, looping back both the 12.2kbps RMC and HSDPA to E-DCH, and start the loopback test. See TS 34.108 [3] clause 7.3.9 and TS 34.109 [4] clauses 5.3.2.3 and 5.3.2.6. To fill the RLC transmit buffer, run the loopback for [3]s before starting the procedure.
- 7) Switch on the fading simulator.

#### 11.2.4.2 Procedure

##### 11.2.4.2.1 3.84Mcps TDD Option

- 1) The SS shall signal 100% ACK on the E-HICH for all processes.
- 2) The SS shall signal the PRRI according to the E-AGCH information sequence as defined in Table 11.2.4.6A.
- 3) The SS shall analyse the E-TFCI transmitted on the E-UCCH for each E-DCH TTI to determine if a missed detection event has occurred by correlating the detected E-TFCIs with the expected E-TFCIs corresponding to the PRRI sent on E-AGCH when the TRRI and CRRI is constant. If the expected E-TFC is not detected by the SS, record a missed detection event.
- 4) The test shall be run such that statistical significance according to Annex F.6.4 is achieved.

##### 11.2.4.2.2 1.28Mcps TDD Option

- 1) The SS shall signal 100% ACK on the E-HICH for all processes.
- 2) The SS shall signal the PRRI according to the E-AGCH information sequence as defined in Table 11.2.4.7.
- 3) The SS shall analyse the E-TFCI transmitted on the E-UCCH for each E-DCH TTI to determine if a missed detection event has occurred by correlating the detected E-TFCIs with the expected E-TFCIs corresponding to the PRRI sent on E-AGCH when the TRRI and CRRI is constant. If the expected E-TFC is not detected by the SS, record a missed detection event.
- 4) The test shall be run such that statistical significance according to Annex F.6.4 is achieved

##### 11.2.4.2.3 7.68Mcps TDD Option

- 1) The SS shall signal 100% ACK on the E-HICH for all processes.
- 2) The SS shall signal the PRRI according to the E-AGCH information sequence as defined in Table 11.2.4.9.
- 3) The SS shall analyse the E-TFCI transmitted on the E-UCCH for each E-DCH TTI to determine if a missed detection event has occurred by correlating the detected E-TFCIs with the expected E-TFCIs corresponding to the PRRI sent on E-AGCH when the TRRI and CRRI is constant. If the expected E-TFC is not detected by the SS, record a missed detection event.
- 4) The test shall be run such that statistical significance according to Annex F.6.4 is achieved

### 11.2.5 Test Requirements

#### 11.2.5.1 3.84Mcps TDD Option

The missed detection probability shall not exceed to the values specified in Table 11. 2.4.6B for 3.84 Mcps TDD.

The missed detection probability = the ratio of (missed detection event)/ (all detected E-TFCI event)  $\leq$  0.01.

Tables 11.2.4.6A and 11.2.4.6B define the primary level settings including test tolerance and test parameters for the test.

**Table 11.2.4.6A: Test parameters for E-AGCH detection**

Parameter	Unit	Missed detection
PRRI		TBD

**Table 11.2.4.6B : Test requirements for E-AGCH detection ( 3.84 Mcps TDD option)**

Test Number	E-AGCH $I_{or}/I_{oc}$ (dB)	Missed Detection Probability
1	2.2	0.01

## 11.2.5.2 1.28Mcps TDD Option

The missed detection probability shall not exceed to the values specified in Table 11.2.4.8.

The missed detection probability = the ratio of (missed detection event)/ (all detected E-TFCI event)  $\leq 0.01$ .

Tables 11.2.4.7 and 11.2.4.8 define the primary level settings including test tolerance and test parameters for the test.

**Table 11.2.4.7: Test parameters for E-AGCH detection**

Parameter	Unit	Missed detection
PRRI		TBD

**Table 11.2.4.8 : Test requirements for E-AGCH detection ( 1.28 Mcps TDD option)**

Test Number	E-AGCH $I_{or}/I_{oc}$ (dB)	Missed Detection Probability
1	8.6	0.01

## 11.2.5.3 7.68Mcps TDD Option

The missed detection probability shall not exceed to the values specified in Table 11. 2.4.9 for 7.68 Mcps TDD option.

The missed detection probability = the ratio of (missed detection event)/ (all detected E-TFCI event)  $\leq 0.01$ .

Tables 11.2.4.9 and 11.2.4.10 define the primary level settings including test tolerance and test parameters for the test.

**Table 11.2.4.9: Test parameters for E-AGCH detection**

Parameter	Unit	Missed detection
PRRI		TBD

**Table 11.2.4.10: Test requirements for E-AGCH detection ( 7.68 Mcps TDD option)**

Test Number	E-AGCH $I_{or}/I_{oc}$ (dB)	Missed Detection Probability
1	1.8	0.01

# Annex A (informative): Connection Diagrams

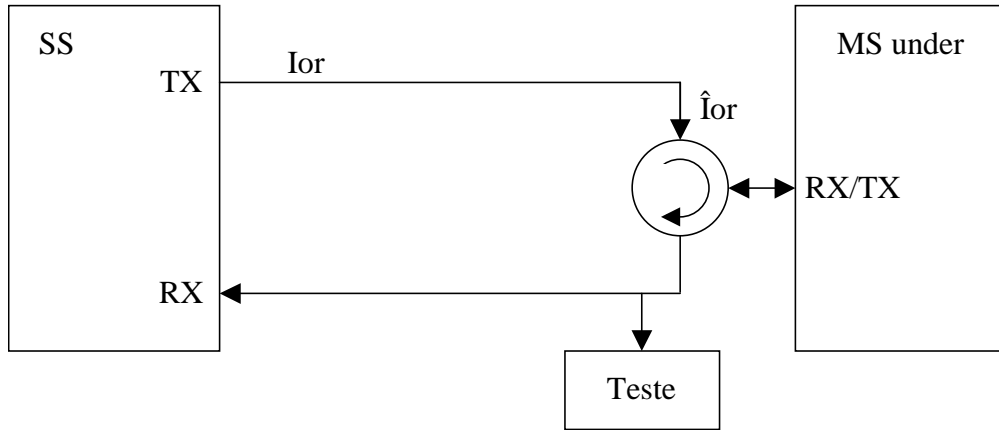

Figure A.1: Connection for Basic TX Test

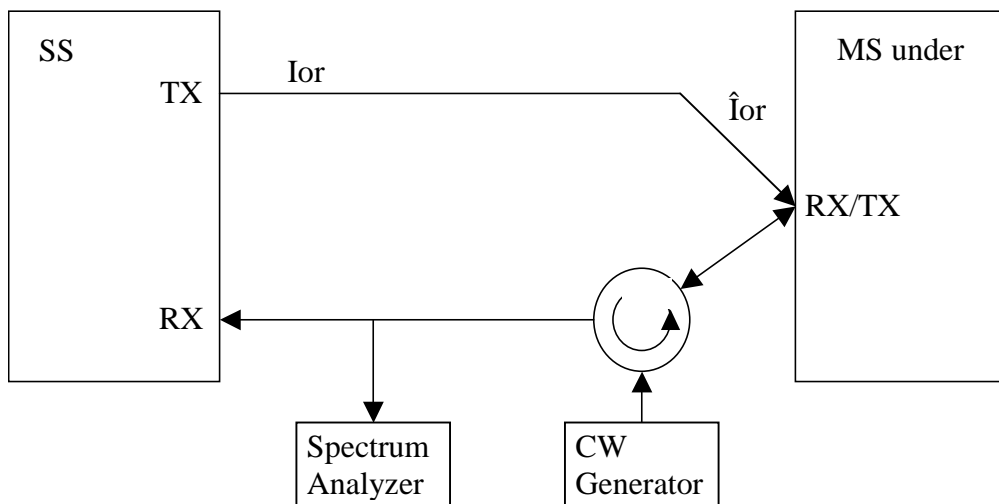

Figure A.2: Connection for TX Intermodulation Test

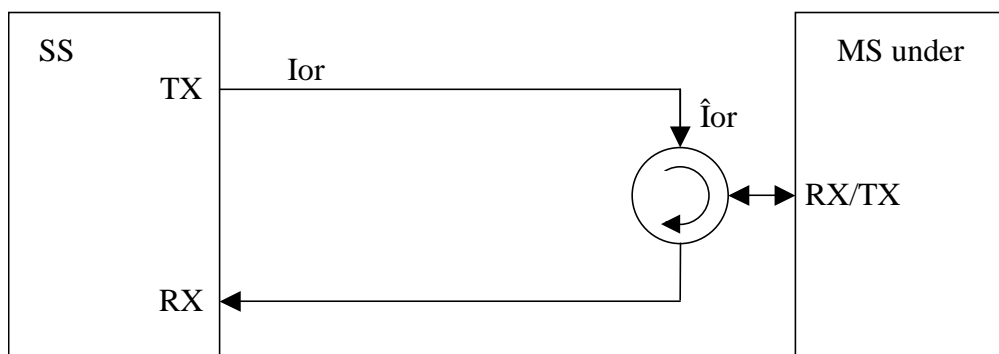

Figure A.3: Connection for Basic RX Test

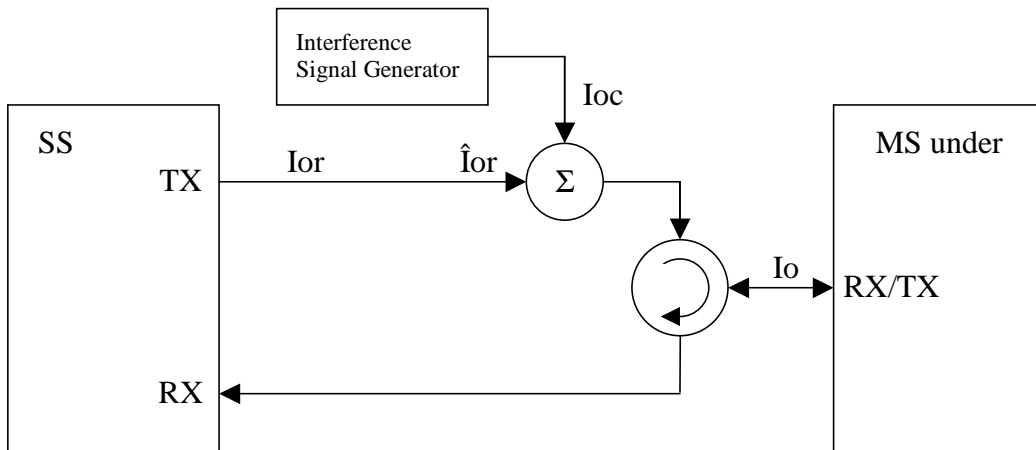

Figure A.4: Connection for RX Test with Interference

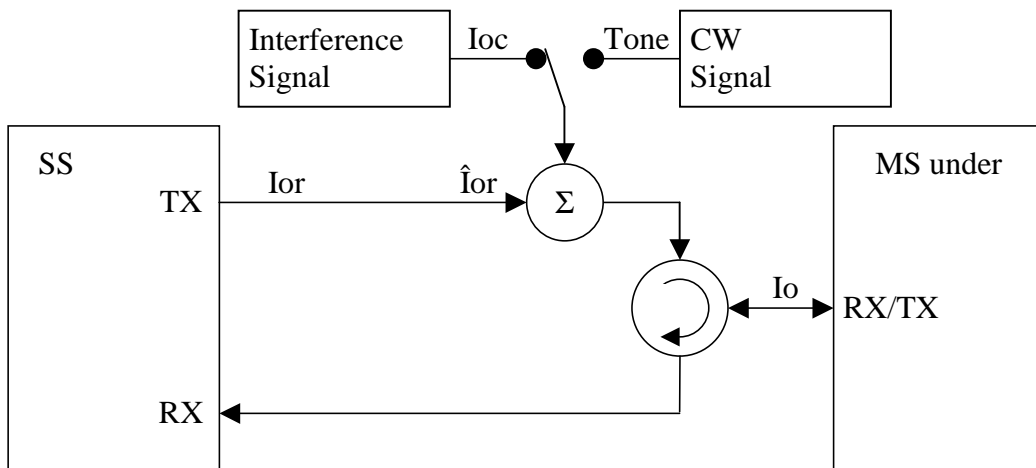

Figure A.5: Connection for RX Test with Interference or additional CW

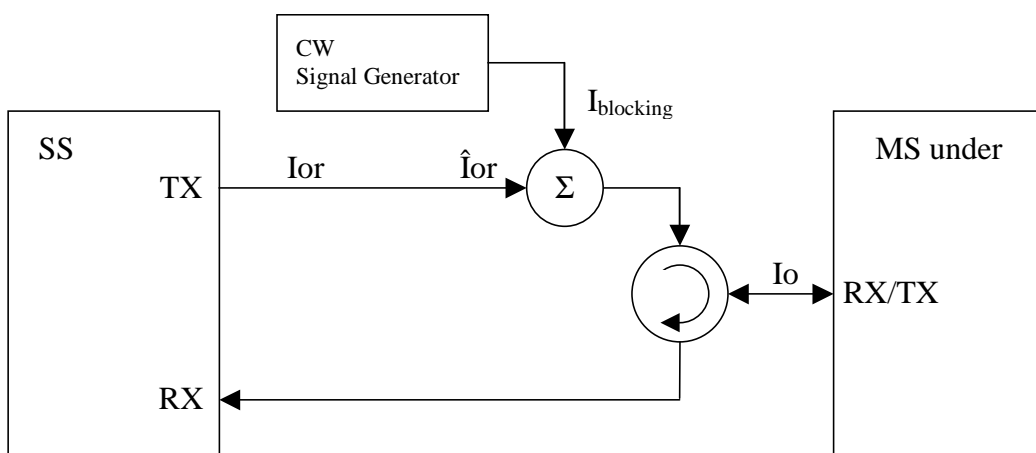

Figure A.6: Connection for RX Test with additional CW

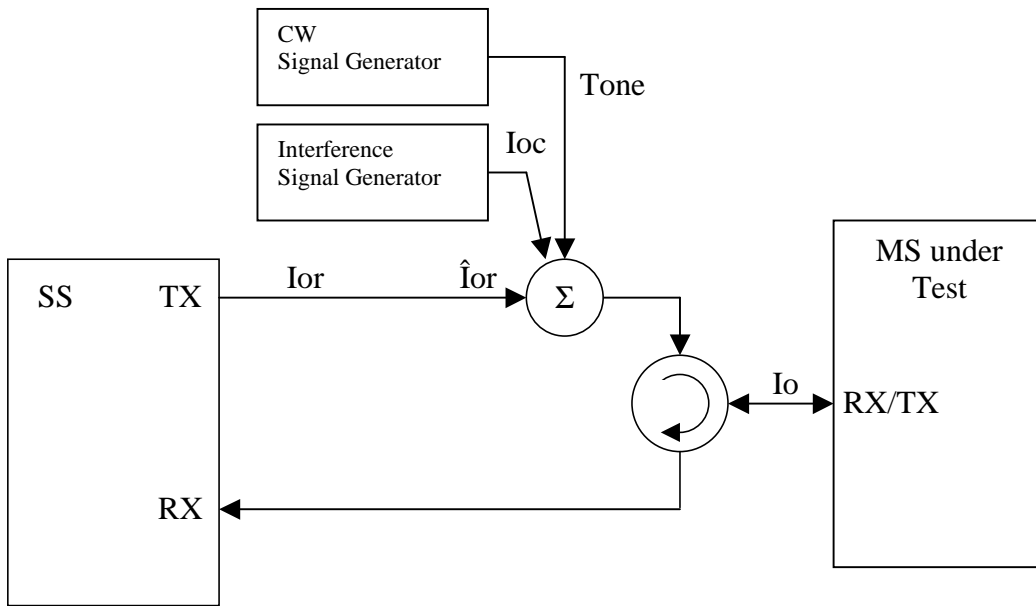

Figure A.7: Connection for RX Test with both Interference and additional CW



Figure A.8: Connection for Spurious Emission Test

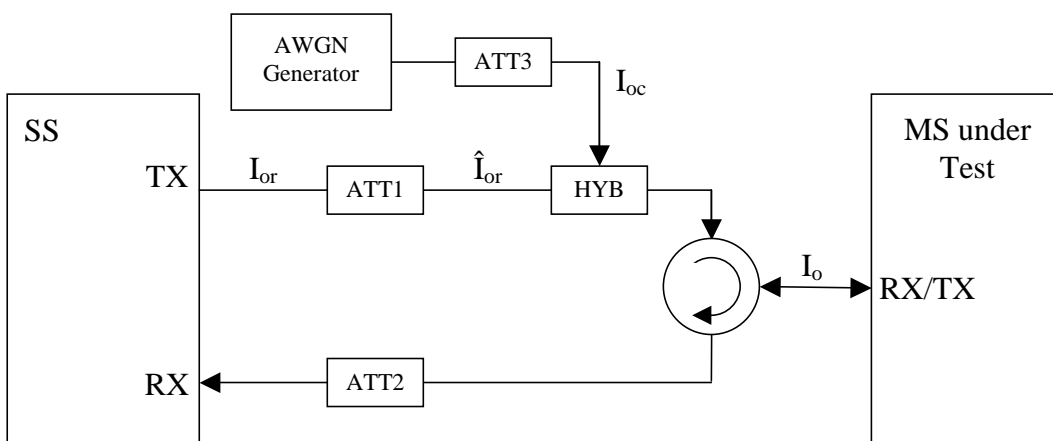

Figure A.9: Connection for Static Channel Test



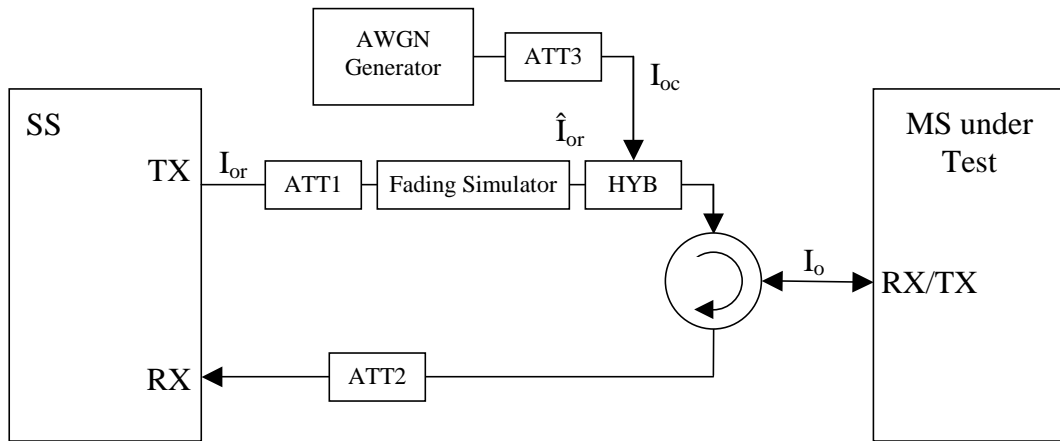

Figure A.10: Connection for Multiple Fading Channel Test

Figure A.11: Void

Figure A.12: Void

Figure A.13: Void

Figure A.14: Void

Figure A.15: Void

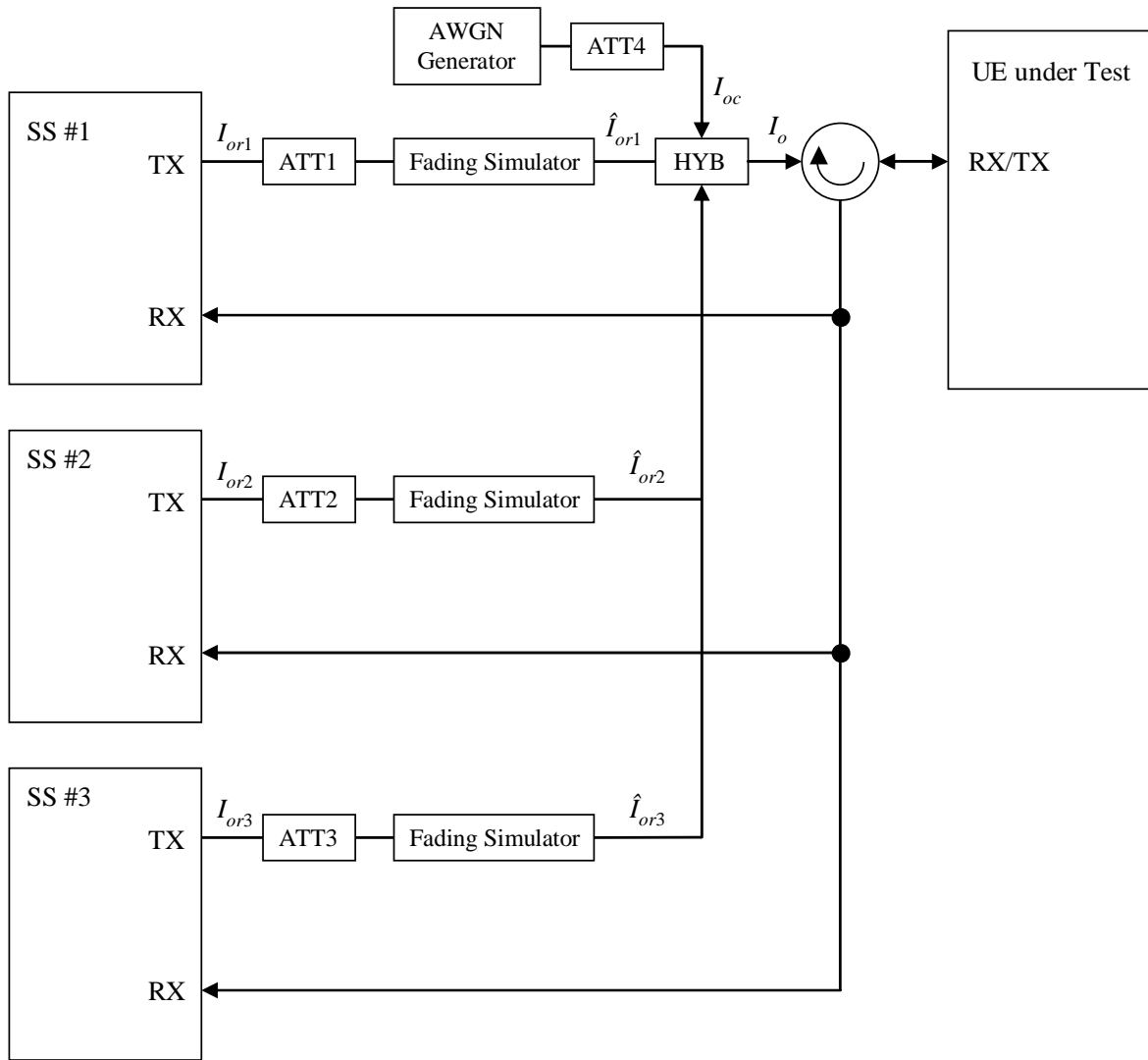

Figure A.16: Connection for three cell tests with Multi-path Fading propagation

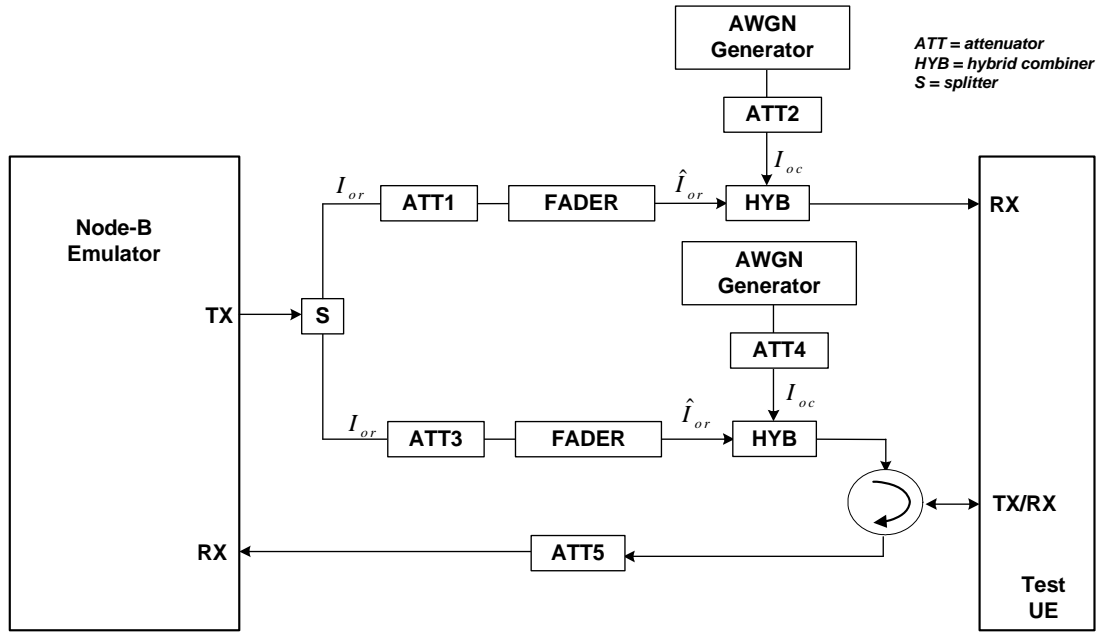

Figure A.17: Connection for single cell tests with Multi-path Fading propagation and UE receive diversity

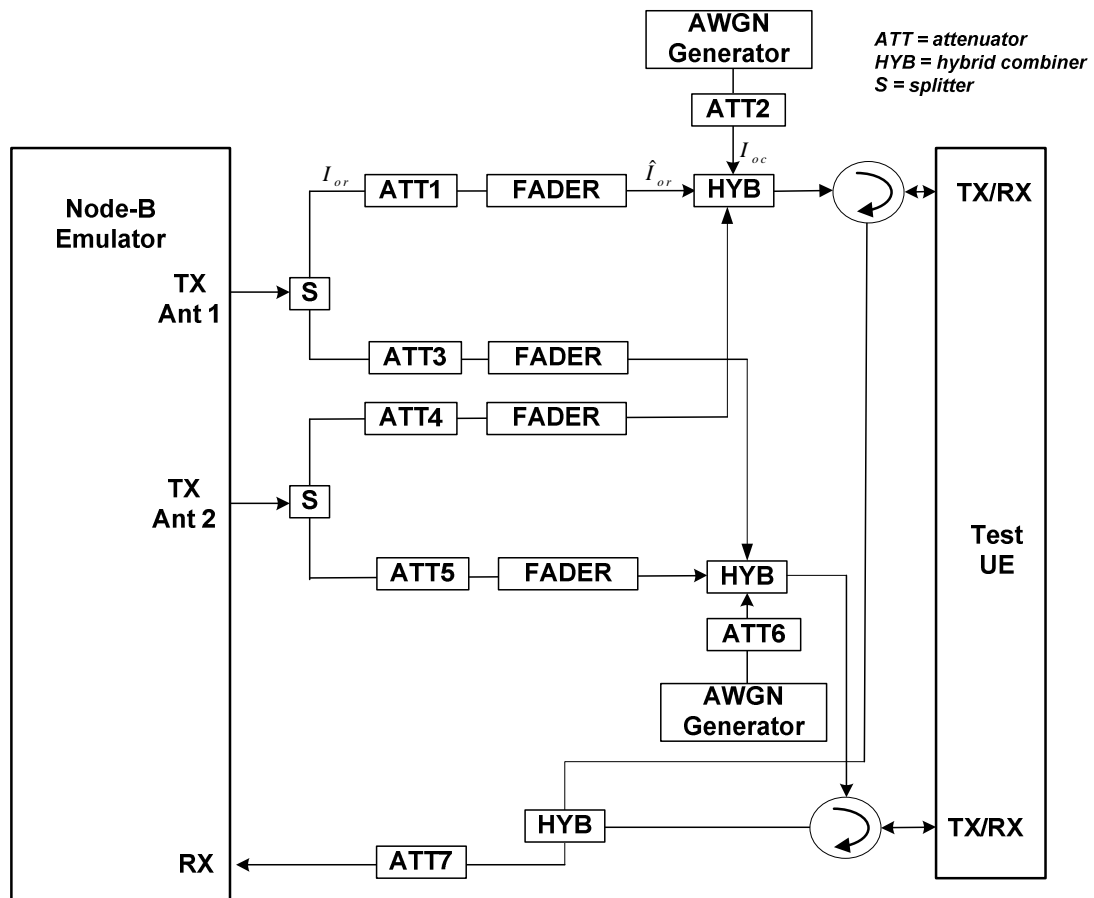

Figure A.18: Connection for MIMO performance Test for MIMO capable UE with Multiple Fading Channel

---

## Annex B (normative): Global In-Channel TX-Test

### B.1 General

The global in-channel Tx test enables the measurement of all relevant parameters that describe the in-channel quality of the output signal of the Tx under test in a single measurement process.

The parameters describing the in-channel quality of a transmitter, however, are not necessarily independent. The algorithm chosen for description inside this annex places particular emphasis on the exclusion of all interdependencies among the parameters. Any other algorithm (e.g. having better computational efficiency) may be applied, as long as the results are the same within the accuracy limits.

All notes referred in the various clauses of B.2 are put together in B.3.

---

### B.2 Definition of the process

#### B.2.1 Basic principle

The process is based on the comparison of the actual **output signal of the TX under test**, received by an ideal receiver, with a **reference signal**, that is generated by the measuring equipment and represents an ideal error free received signal. The reference signal shall be composed of the same number of codes at the correct spreading factors as contained in the test signal. Note, for simplification, the notation below assumes only codes of one spreading factor although the algorithm is valid for signals containing multiple spreading factors.

All signals are represented as equivalent (generally complex) baseband signals.

#### B.2.2 Output signal of the TX under test

The output signal of the TX under test is acquired by the measuring equipment, filtered by a matched filter (RRC 0.22, correct in shape and in position on the frequency axis) and stored for further processing.

The following form represents the physical signal in the entire measurement interval:

one vector **Z**, containing  $N = n_s \times sf + m_a$  complex samples;

with

ns: number of symbols in the measurement interval;

sf: number of chips per symbol. (sf: spreading factor) (see Note: Symbol length)

ma: number of midamble chips

#### B.2.3 Reference signal

The reference signal is constructed by the measuring equipment according to the relevant TX specifications.

It is filtered by the same matched filter, mentioned in B.2.2., and stored at the Inter-Symbol-Interference free instants. The following form represents the reference signal in the entire measurement interval:

one vector **R**, containing  $N = n_s \times sf + m_a$  complex samples;

ns, sf, ma: see B.2.2

## B.2.4 void

## B.2.5 Classification of measurement results

The measurement results achieved by the global in-channel TX test can be classified into two types:

Results of type "deviation", where the error-free parameter has a non-zero magnitude. (These are the parameters that quantify the integral physical characteristic of the signal). These parameters are:

- RF Frequency
- Power (in case of single code)
- Code Domain Power (in case of multi code)
- Timing

(Additional parameters: see Note: Deviation)

Results of type "residual", where the error-free parameter has value zero. (These are the parameters that quantify the error values of the measured signal, whose ideal magnitude is zero). These parameters are:

- Error Vector Magnitude (EVM);
- Peak Code Domain Error (PCDE).

(Additional parameters: see Note residual).

## B.2.6 Process definition to achieve results of type "deviation"

The reference signal (**R**; see clause B.2.3) and the signal under Test (**Z**; see subclause B.2.2) are varied with respect to the parameters mentioned in clause B.2.5 under "results of type deviation" in order to achieve best fit. Best fit is achieved when the RMS difference value between the varied signal under test and the varied reference signal is an absolute minimum.

Overview:

$$FCT [ Z(\tilde{f}, \tilde{t}, \tilde{\varphi}, g_1, g_2, \dots, g_{synch}) - R(f, t, \varphi, \tilde{g}_1, \tilde{g}_2, \dots, \tilde{g}_{synch}) ] = Minimum \quad !$$

Z : Signal under test.

R: Reference signal,

with frequency f, the timing t, the phase  $\varphi$ , gain of code1 ( $g_1$ ), gain of code2 ( $g_2$ ) etc, and the gain of the synch channel  $g_{synch}$

The parameters marked with a tilde in Z and R are varied in order to achieve a best fit.

Detailed formula: see Note: Formula for the minimum process

The varied reference signal, after the best fit process, will be called **R'**.

The varied signal under test, after the best fit process, will be called **Z'**.

The varying parameters, leading to **R'** and **Z'** represent directly the wanted results of type "deviation". These measurement parameters are expressed as deviation from the reference value with units same as the reference value.

In case of multi code, the type-"deviation"-parameters (frequency, timing and (RF-phase)) are varied commonly for all codes such that the process returns one frequency-deviation, one timing deviation, (one RF-phase –deviation).

(These parameters are not varied on the individual codes signals such that the process would return kr frequency errors... . (kr: number of codes in the reference signal)).

The only type-"deviation"-parameters varied individually are the code domain gain factors ( $g_1, g_2, \dots$ ).

### E.2.5.1 Decision Point Power

The mean-square value of the signal-under-test, sampled at the best estimate of the of Intersymbol-Interference-free points using the process defined in subclause 2.5, is referred to the *Decision Point Power* (DPP):

### E.2.5.2 Code-Domain Power

The samples,  $Z'$ , are separated into symbol intervals to create  $ns$  time-sequential vectors  $\mathbf{z}$  with  $sf$  complex samples comprising one symbol interval. The *Code Domain Power* is calculated according to the following steps:

- 1) Take the vectors  $\mathbf{z}$  defined above.
- 2) To achieve meaningful results it is necessary to descramble  $\mathbf{z}$ , leading to  $\mathbf{z}'$
- 3) Take the orthogonal vectors of the channelization code set  $\mathbf{C}$  (all codes belonging to one spreading factor) as defined in TS 25.213 and TS 25.223 (range +1, -1), and normalize by the norm of the vectors to produce  $\mathbf{C}_{norm} = \mathbf{C} / \sqrt{sf}$ . (see Note: Symbol length)
- 4) Calculate the inner product of  $\mathbf{z}'$  with  $\mathbf{C}_{norm}$ . Do this for all symbols of the measurement interval and for all codes in the code space.  
This gives an array of format  $k \times ns$ , each value representing a specific symbol and a specific code, which can be exploited in a variety of ways.

$k$ : total number of codes in the code space

$ns$ : number of symbols in the measurement interval

- 5) Calculate  $k$  mean-square values, each mean-square value unifying  $ns$  symbols within one code. (These values can be called "*Absolute CodeDomainPower* (CDP)" [Volt<sup>2</sup>].) The sum of the  $k$  values of CDP is equal to DPP.
- 6) Normalize by the decision point power to obtain

$$\text{Relative CodeDomain Power} = \frac{\text{Absolute CodeDomainPower}}{\text{DecisionPointPower}}$$

## B.2.7 Process definition to achieve results of type "residual"

The difference between the varied reference signal ( $\mathbf{R}'$ ; see clause B.2.6.) and the varied TX signal under test ( $\mathbf{Z}'$ ; see clause B.2.6) is the error vector  $\mathbf{E}$  versus time:

$$\mathbf{E} = \mathbf{Z}' - \mathbf{R}'.$$

Depending on the parameter to be evaluated, it is appropriate to represent  $\mathbf{E}$  in one of the following two different forms:

Form EVM (representing the physical error signal in the entire measurement interval)

One vector  $\mathbf{E}$ , containing  $N = ns \times sf + ma$  complex samples;

$ns$ ,  $sf$ ,  $ma$ : see B.2.2

Form PCDE (derived from Form EVM by separating the samples into symbol intervals)

$ns$  time-sequential vectors  $\mathbf{e}$  with  $sf$  complex samples comprising one symbol interval.

$\mathbf{E}$  gives results of type "residual" applying the two algorithms defined in clauses B 2.7.1 and B 2.7.2.

### B.2.7.1 Error Vector Magnitude (EVM)

The Error Vector Magnitude EVM is calculated according to the following steps:

- 1) Take the error vector  $\mathbf{E}$  defined in clause B.2.7 (Form EVM) and calculate the RMS value of  $\mathbf{E}$ ; the result will be called  $\text{RMS}(\mathbf{E})$ .
- 2) Take the varied reference vector  $\mathbf{R}'$  defined in clause B.2.6 and calculate the RMS value of  $\mathbf{R}'$ ; the result will be called  $\text{RMS}(\mathbf{R}')$ .

3) Calculate EVM according to:

$$\text{EVM} = \frac{\text{RMS}(E)}{\text{RMS}(R')} \times 100\% \quad (\text{here, EVM is relative and expressed in \%})$$

(see note TDD)

(see note: Formula for EVM)

### B.2.7.2 Peak Code Domain Error (PCDE)

The Peak Code Domain Error is calculated according to the following steps:

- 1) Take the error vectors  $\mathbf{e}$  defined in clause B.2.7 (Form PCDE).
- 2) Take the orthogonal vectors of the channelisation - code set  $\mathbf{C}$  (all codes belonging to one spreading factor) as defined in TS 25.213 and TS 25.223 (range +1, -1). (see Note: Symbol length) and normalize by the norm of the vectors to produce  $\mathbf{C}_{\text{norm}} = \mathbf{C}/\text{sqrt}(\text{sf})$ . (see Note: Symbol length).
- 3) To achieve meaningful results it is necessary to descramble  $\mathbf{e}$ , leading to  $\mathbf{e}'$ .
- 4) Calculate the inner product of  $\mathbf{e}'$  with  $\mathbf{C}_{\text{norm}}$ . Do this for all symbols of the measurement interval and for all codes in the code space.  
This gives an array of format  $k \times n_s$ , each value representing an error-vector representing a specific symbol and a specific code, which can be exploited in a variety of ways.  
k: total number of codes in the code space  
n<sub>s</sub>: number of symbols in the measurement interval
- 5) Calculate k RMS values, each RMS value unifying n<sub>s</sub> symbols within one code.  
(These values can be called "*Absolute CodeEVMs*" [Volt].)
- 6) Find the peak value among the k "*Absolute CodeEVMs*".  
(This value can be called "*Absolute PeakCodeEVM*" [Volt].)
- 7) Calculate PCDE according to:

$$10 \cdot \lg \frac{(\text{"Absolute PeakCodeEVM"})^2}{(\text{RMS}(\mathbf{R}'))^2} \quad \text{dB} \quad (\text{a relative value in dB}).$$

(see Note: Scrambling code)

(see Note TDD)

---

## B.3 Notes

### Note: Symbol length

A general code multiplexed signal is multicode and multirate. In order to avoid unnecessary complexity, the measurement applications use a unique symbol-length, corresponding to a spreading factor, regardless of the really intended spreading factor. Nevertheless the complexity with a multicode / multirate signal can be mastered by introducing appropriate definitions.

### Note: Deviation

It is conceivable to regard more parameters as type „deviation" e.g. Chip frequency and RF-phase.

As chip-frequency and RF-frequency are linked together by a statement in the core specifications [1] it is sufficient to process RF frequency only.

A parameter RF-phase must be varied within the best fit process (B 2.6.). Although necessary, this parameter-variation doesn't describe any error, as the modulation schemes used in the system don't depend on an absolute RF-phase.

**Note: Residual)**

It is conceivable to regard more parameters as type „residual" e.g. IQ origin offset. As it is not the intention of the test to separate for different error sources, but to quantify the quality of the signal, all such parameters are not extracted by the best fit process, instead remain part of EVM and PCDE.

**Note Scrambling Code)**

To interpret the measurement results in practice it should be kept in mind that erroneous code power on unused codes is generally de-scrambled differently under test conditions and under real life conditions, whereas erroneous code power on used codes is generally de-scrambled equally under test conditions and under real life conditions. It might be indicated if a used or unused code hits PCDE.

**Note TDD)**

EVM covers the midamble part as well as the data part; however PCDE disregards the midamble part.

NOTE: Formula for the minimum process

$$L(\Delta\tilde{f}, \Delta\tilde{t}, \Delta\tilde{\varphi}, \Delta\tilde{g}_c, \dots, \Delta\tilde{g}_{mid}) = \sum_{v=0}^{N-1} |Z(v) - R(v)|^2$$

Legend:

L: the function to be minimised

The parameters to be varied in order to minimize are:

$\Delta\tilde{f}$  : the RF frequency offset

$\Delta\tilde{t}$  : the timing offset

$\Delta\tilde{\varphi}$  : the phase offset

$\Delta\tilde{g}_c \dots$  code power offsets (one offset for each code)

$\Delta\tilde{g}_{mid}$  : the power offset of the midamble

Z(v): Samples of the signal under Test

R(v): Samples of the reference signal

$\sum_{v=0}^{N-1}$  : counting index  $v$  starting at the beginning of the measurement interval and ending at its end.

N = No of chips during the measurement interval.

Z(v): Samples of the signal under Test. It is modelled as a sequence of complex baseband samples  $Z(\gamma)$  with a time-shift  $\Delta t$ , a frequency offset  $\Delta f$ , a phase offset  $\Delta\varphi$ , the latter three with respect to the reference signal.

$$Z(v) = Z(v - \Delta\tilde{t}) * e^{-j2\pi\Delta\tilde{f}v} * e^{-j\Delta\tilde{\varphi}}$$

R(v): Samples of the reference signal:



$$R(v) = \sum_{c=1}^{\text{No. of codes}} (g_c + \Delta\tilde{g}_c) * \text{Chip}_c(v) + (g_{mid} + \Delta\tilde{g}_{mid}) * \text{Chip}_{mid}(v)$$

$g$  : nominal gain of the code channel or midamble

$\Delta\tilde{g}$  : The gain offset to be varied in the minimum process

$\text{Chip}(v)$  is the chipsequence of the code channel or midamble

Indices at  $g$ ,  $\Delta g$  and  $\text{Chip}$ :

The index indicates the code channel:  $c = 1, 2, \dots$  No of code channels

Range for  $\text{Chip}_c$  : +1, -1

NOTE: Formula for EVM

$$EVM = \sqrt{\frac{\sum_{v=0}^{N-1} |Z'(\gamma) - R'(\gamma)|^2}{\sum_{v=0}^{N-1} |R'(\gamma)|^2}} * 100 \%$$

$Z(\gamma)$ ,  $R(\gamma)$  are the varied measured and reference signals.

## Annex C (normative): Measurement channels

### C.1 General

Void.

### C.2 UL Reference measurement channels

#### C.2.1 UL reference measurement channel (12,2 kbps)

##### C.2.1.1 3,84 TDD Option

**Table C.2.1.1: UL reference measurement channel physical parameters (12,2 kbps)**

Parameter	
Information data rate	12,2 kbps
RU's allocated	2 RU
Midamble	512 chips
Interleaving	20 ms
Power control	2 Bit/user
TFCI	16 Bit/user
Inband signalling DCCH	2 kbps
Puncturing level at Code rate 1/3 : DCH of the DTCH / DCH of the DCCH	10% / 0%

**Table C.2.1.2: UL reference measurement channel using RLC-TM for DTCH, transport channel parameters (12.2 kbps)**

Higher Layer	RAB/Signalling RB	RAB	SRB	
RLC	Logical channel type	DTCH	DCCH	
	RLC mode	TM	UM/AM	
	Payload sizes, bit	244	88/80	
	Max data rate, bps	12200	2200/2000	
	PDU header, bit	N/A	8/16	
	TrD PDU header, bit	0	N/A	
MAC	MAC header, bit	0	4	
	MAC multiplexing	N/A	Yes	
Layer 1	TrCH type	DCH	DCH	
	Transport Channel Identity	1	5	
	TB sizes, bit	244	100	
	TFS	TF0, bits	0*244	0*100
		TF1, bits	1*244	1*100
	TTI, ms	20	40	
	Coding type	Convolution Coding	Convolution Coding	
	Coding Rate	1/3	1/3	
	CRC, bit	16	12	
	Max number of bits/TTI after channel coding	804	360	
	Uplink: Max number of bits/radio frame before rate matching	402	90	
	RM attribute	220	242	

**Table C.2.1.3: UL reference measurement channel, TFCS (12.2 kbps)**

TFCS size	4
TFCS	(DTCH, DCCH)= (TF0, TF0), (TF1, TF0), (TF0, TF1), (TF1, TF1)

**Table C.2.1.4: UL reference measurement channel, puncturing limit (12.2 kbps)**

DPCH Downlink	Puncturing limit	0.88
---------------	------------------	------

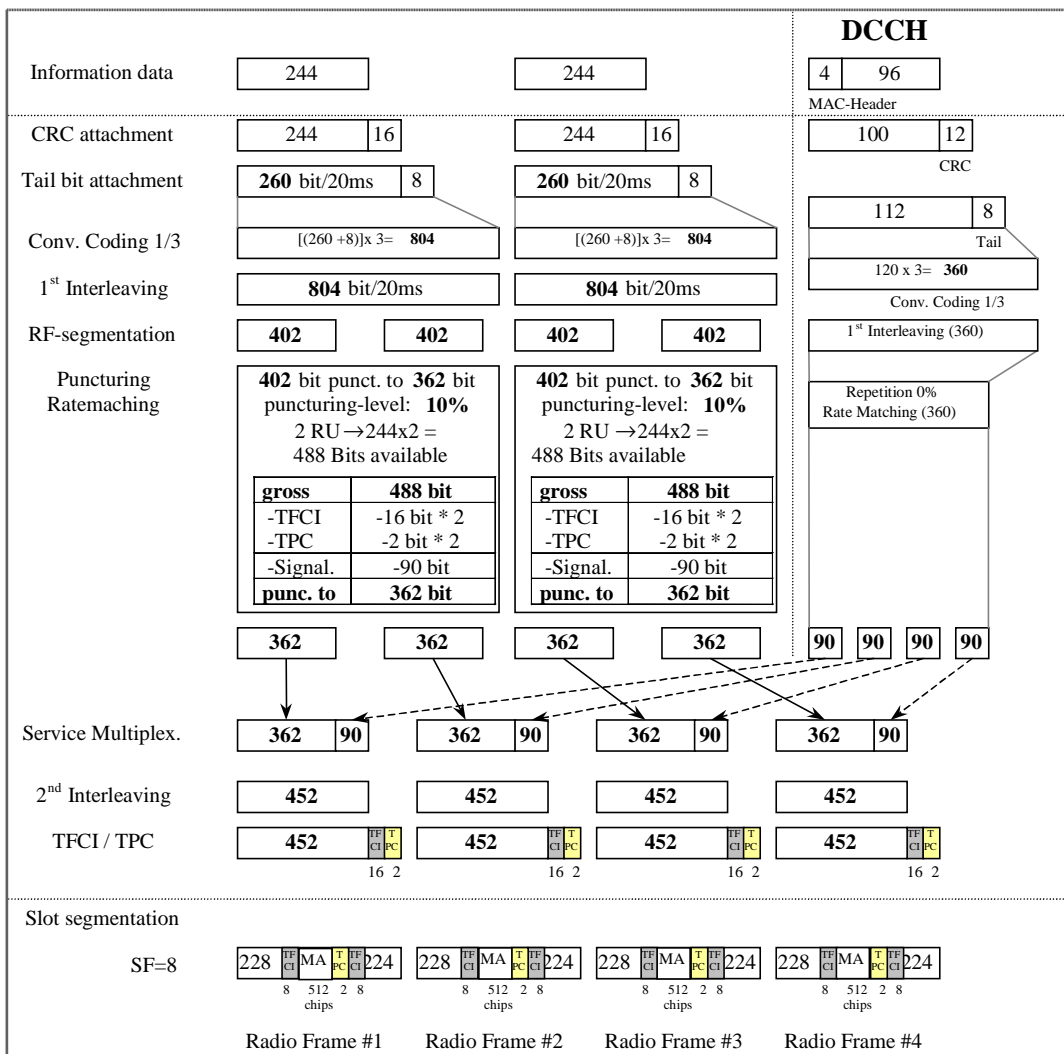

### C.2.1.2 UL reference measurement channel (12,2 kbps) for 1,28 Mcps TDD Option

Parameter	
Information data rate	12,2 kbps
RU's allocated	1TS (1*SF8) = 2RU/5ms
Midamble	144
Interleaving	20 ms
Power control (TPC)	4 Bit/user/10ms
TFCI	16 Bit/user/10ms
Synchronisation Shift (SS)	4 Bit/user/10ms
Inband signalling DCCH	2 kbps
Puncturing level at Code rate 1/3: DCH of the DTCH / DCH of the DCCH	33% / 33%

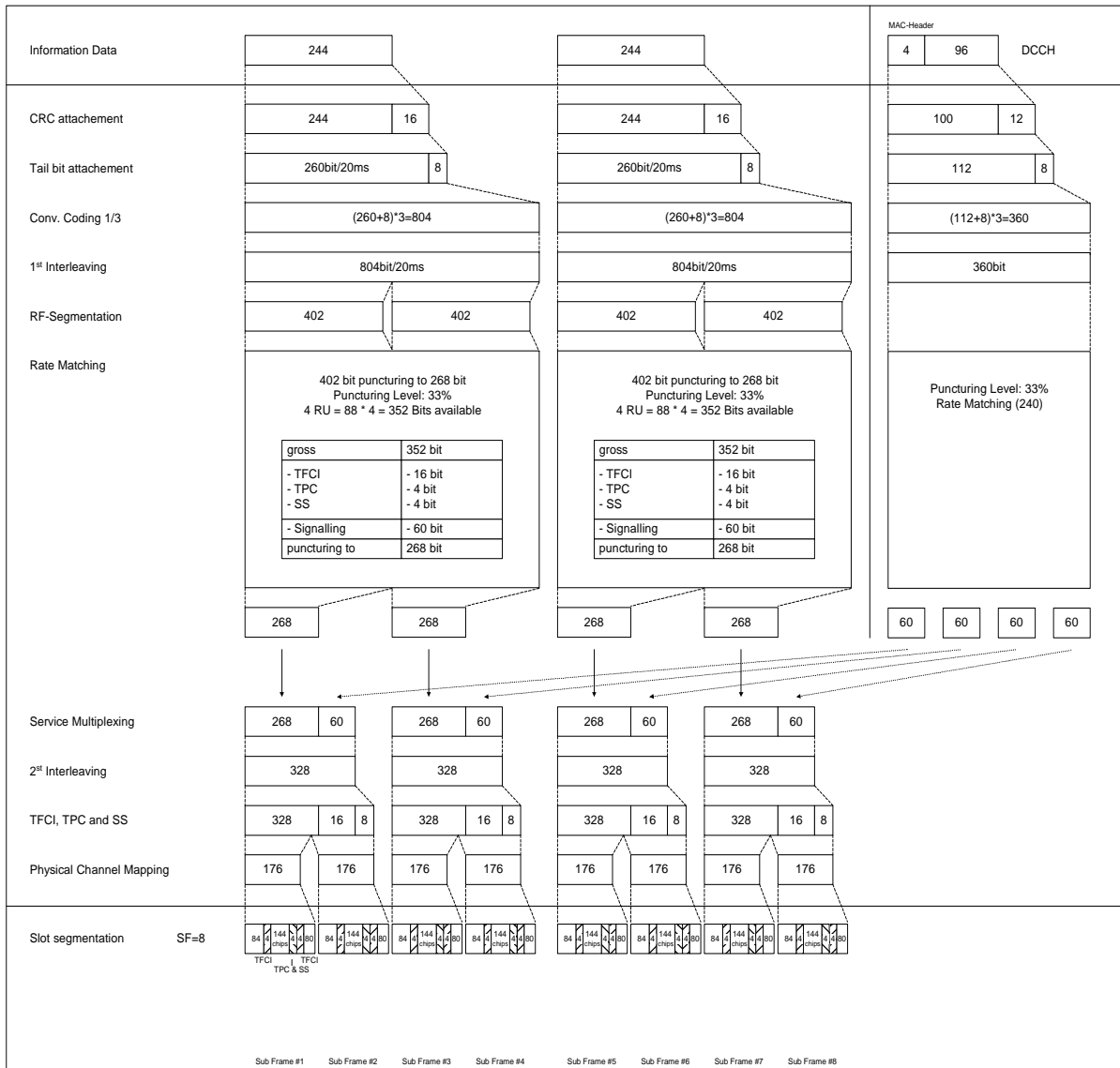

## C.2.1.3 7,68 TDD Option

Parameter	Value
Information data rate	12.2 kbps
RU's allocated	2 RU
Midamble	1024 chips
Interleaving	20 ms
Power control	2 Bit/user
TFCI	16 Bit/user
Inband signalling DCCH	2 kbps
Puncturing level at Code rate 1/3 : DCH of the DTCH / DCH of the DCCH	10% / 0%

**Table C.2.1.2: UL reference measurement channel using RLC-TM for DTCH, transport channel parameters (12.2 kbps)**

Higher Layer	RAB/Signalling RB	RAB	SRB	
RLC	Logical channel type	DTCH	DCCH	
	RLC mode	TM	UM/AM	
	Payload sizes, bit	244	88/80	
	Max data rate, bps	12200	2200/2000	
	PDU header, bit	N/A	8/16	
	TrD PDU header, bit	0	N/A	
MAC	MAC header, bit	0	4	
	MAC multiplexing	N/A	Yes	
Layer 1	TrCH type	DCH	DCH	
	Transport Channel Identity	1	5	
	TB sizes, bit	244	100	
	TFS	TF0, bits	0*244	0*100
		TF1, bits	1*244	1*100
	TTI, ms	20	40	
	Coding type	Convolution Coding	Convolution Coding	
	Coding Rate	1/3	1/3	
	CRC, bit	16	12	
	Max number of bits/TTI after channel coding	804	360	
	Uplink: Max number of bits/radio frame before rate matching	402	90	
	RM attribute	220	242	

**Table C.2.1.3: UL reference measurement channel, TFCS (12.2 kbps)**

TFCS size	4
TFCS	(DTCH, DCCH)= (TF0, TF0), (TF1, TF0), (TF0, TF1), (TF1, TF1)

**Table C.2.1.4: UL reference measurement channel, puncturing limit (12.2 kbps)**

DPCH Downlink	Puncturing limit	0.88
---------------	------------------	------

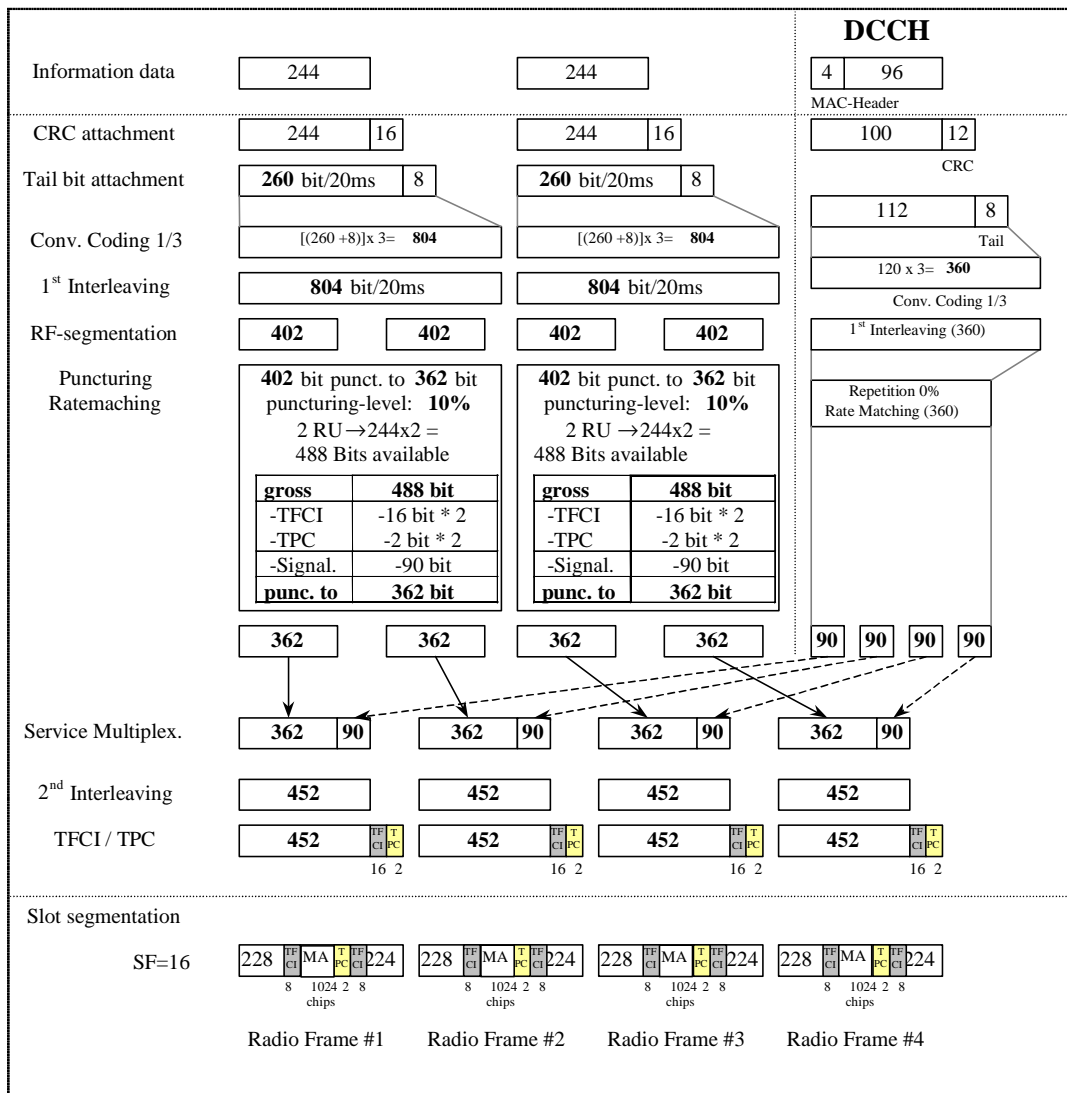

## C.2.2 UL multi code reference measurement channel (12,2 kbps)

### C.2.2.1 3,84 Mcps TDD Option

Table C.2.2.1: UL reference measurement channel physical parameters (12,2 kbps, multi code)

Parameter	
Information data rate	12,2 kbps
RU's allocated	2 RU
Midamble	512 chips
Interleaving	20 ms
Power control	2 Bit/user
TFCI	16 Bit/user
Inband signalling DCCH	2 kbps
Puncturing level at Code rate 1/3 : DCH of the DTCH / DCH of the DCCH	5% / 0 %

**Table C.2.2.2: UL reference measurement channel using RLC-TM for DTCH, transport channel parameters (12.2 kbps, multicode)**

Higher Layer	RAB/Signalling RB	RAB	SRB	
RLC	Logical channel type	DTCH	DCCH	
	RLC mode	TM	UM/AM	
	Payload sizes, bit	244	88/80	
	Max data rate, bps	12200	2200/2000	
	PDU header, bit	N/A	8/16	
	TrD PDU header, bit	0	N/A	
MAC	MAC header, bit	0	4	
	MAC multiplexing	N/A	Yes	
Layer 1	TrCH type	DCH	DCH	
	Transport Channel Identity	1	5	
	TB sizes, bit	244	100	
	TFS	TF0, bits	0*244	0*100
		TF1, bits	1*244	1*100
	TTI, ms	20	40	
	Coding type	Convolution Coding	Convolution Coding	
	Coding Rate	1/3	1/3	
	CRC, bit	16	12	
	Max number of bits/TTI after channel coding	804	360	
	Uplink: Max number of bits/radio frame before rate matching	402	90	
RM attribute	220	232		

**Table C.2.2.3: UL reference measurement channel, TFCS (12.2 kbps, multicode)**

TFCS size	4
TFCS	(DTCH, DCCH)= (TF0, TF0), (TF1, TF0), (TF0, TF1), (TF1, TF1)

**Table C.2.2.4: UL reference measurement channel, puncturing limit (12.2 kbps, multicode)**

DPCH Downlink	Puncturing limit	0.92
---------------	------------------	------

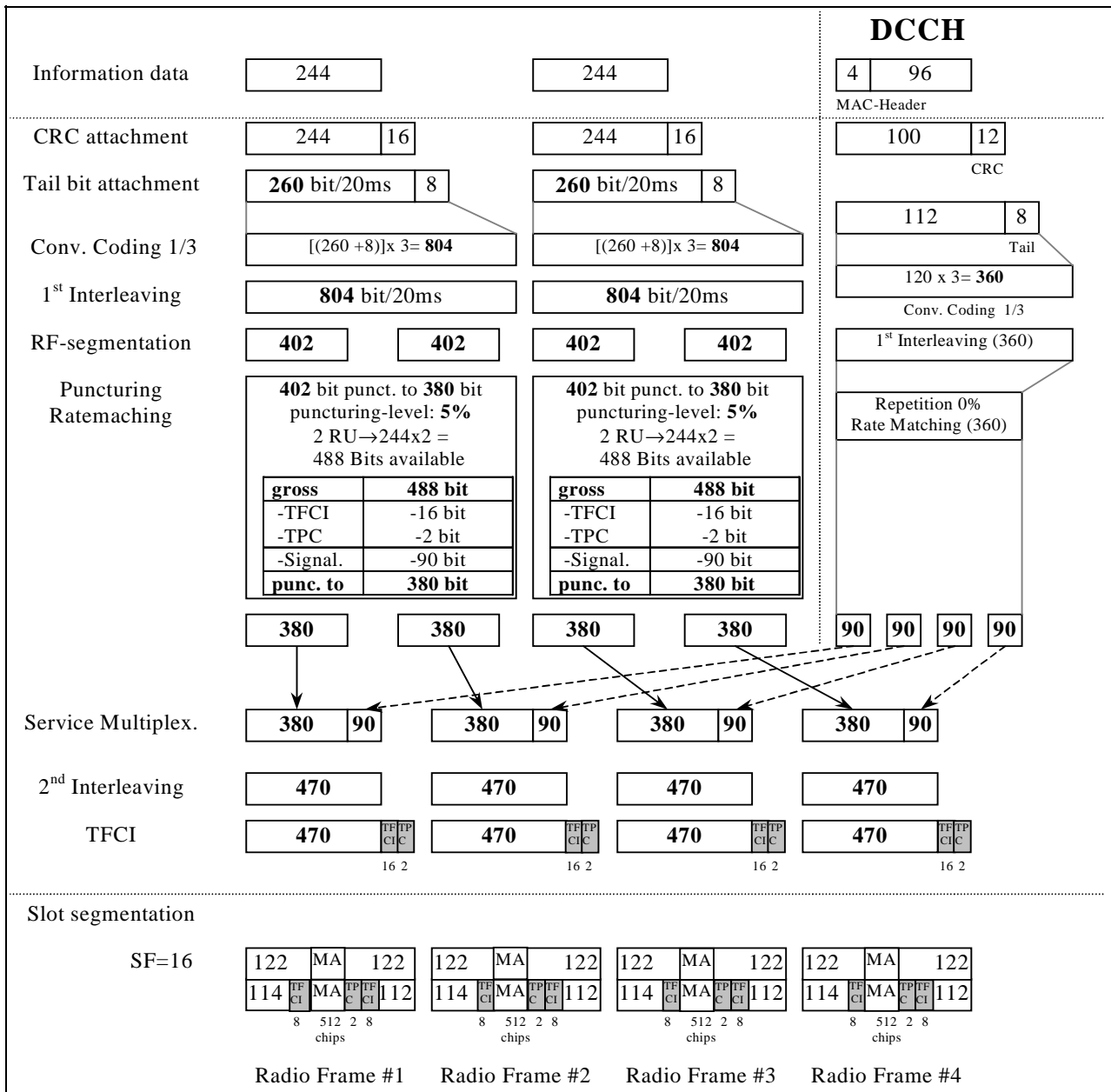

C.2.2.2 UL multi code reference measurement channel (12,2 kbps) for 1,28 Mcps TDD Option

Table C.2.2.2

Parameter	Value
Information data rate	12,2 kbps
RU's allocated	1TS (2*SF16) = 2RU/5ms
Midamble	144
Interleaving	20 ms
Power control (TPC)	4 Bit/user/10ms
TFCI	16 Bit/user/10ms
4 Bit reserved for future use (place of SS)	4 Bit/user/10ms
Inband signalling DCCH	2.4 kbps
Puncturing level at Code rate 1/3: DCH of the DTCH / DCH of the DCCH	33% / 33%



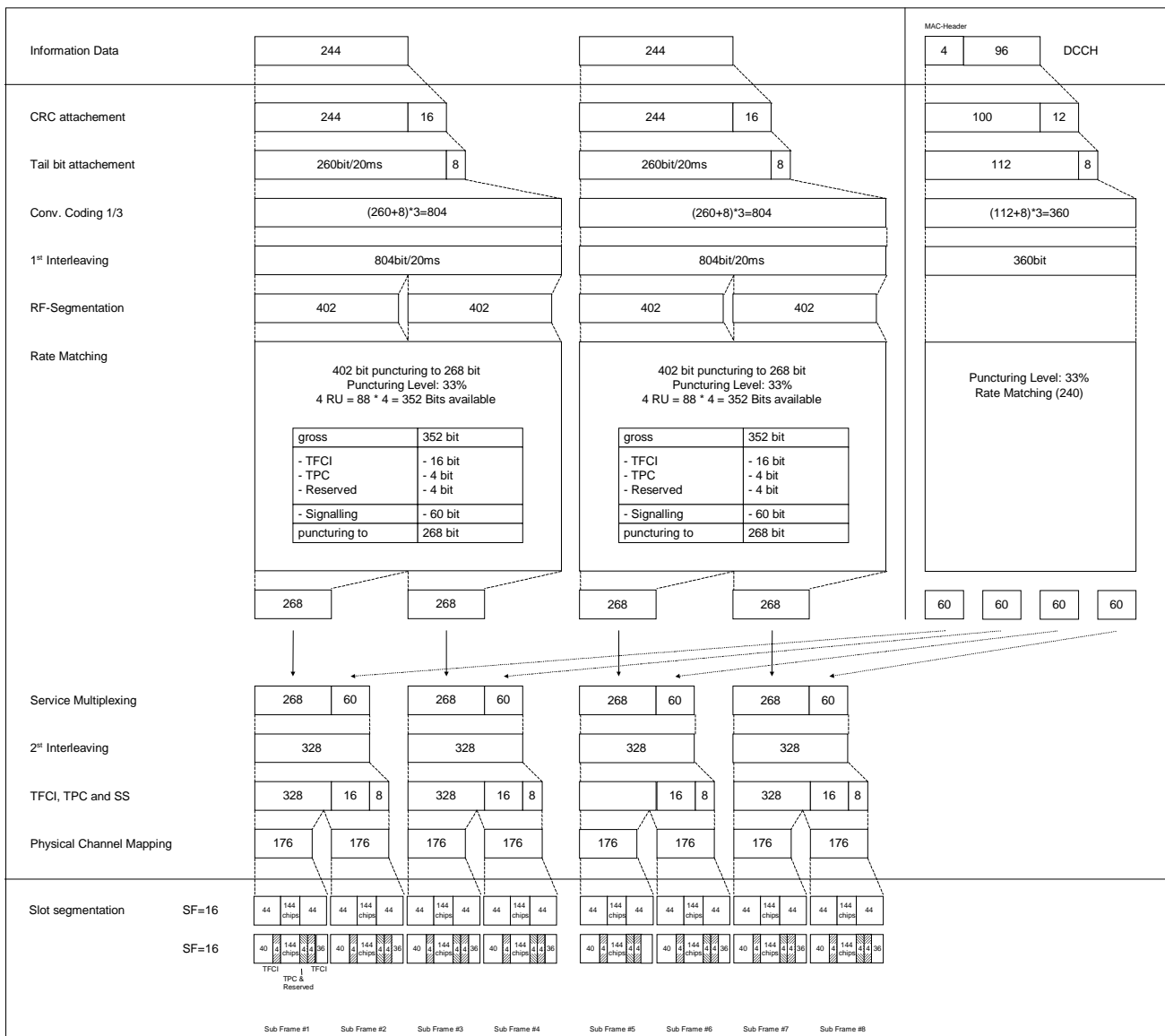

### C.2.2.2a UL multi code( HS-SICH and DPCH) reference measurement channel for 1,28 Mcps TDD Option

Table C.2.2.2a: HS-SICH reference measurement channel

Parameter	Value
Information data rate	1.6kbps
RU's allocated	1TS (1*SF16) = 1RU/5ms
Midamble	144
Midamble Allocation	default
Scrambling code	0
Power control (TPC)	2 Bits/user/5ms
TFCI	0 Bits/user/5ms
Synchronisation Shift (SS)	2 Bits/user/5ms

**Table C.2.2.2b: DPCH reference measurement channel**

<b>Parameter</b>	<b>Value</b>
Information data rate	2.4kbps
RU's allocated	1TS (SF2) =8RU/5ms
Midamble	144
Midamble Allocation	default
Scrambling code	0
Power control (TPC)	2Bits/user/5ms
TFCI	8 Bits/user/5ms
Synchronisation Shift (SS)	2Bits/user/5ms

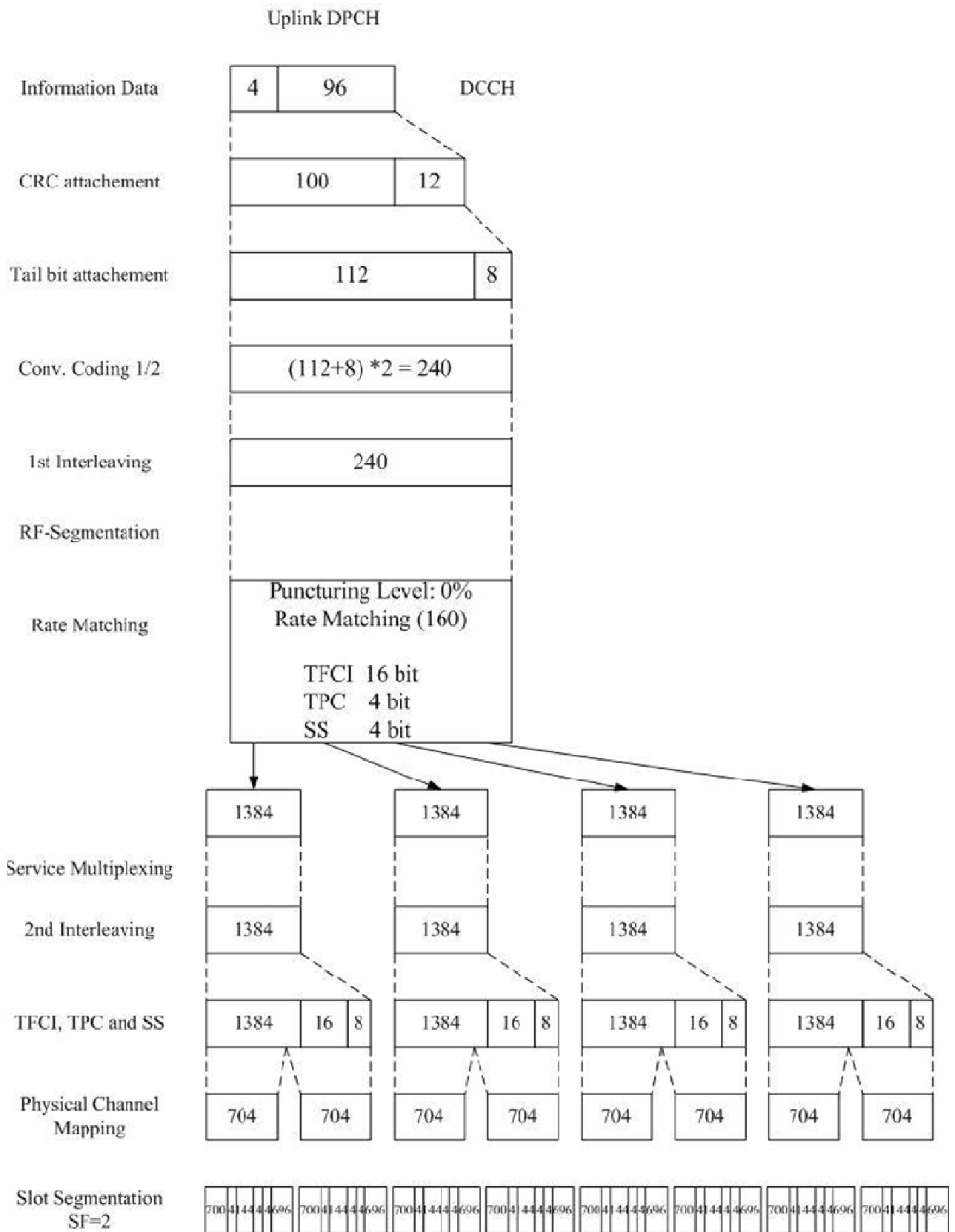

## C.2.2.3 7,68 Mcps TDD Option

Parameter	Value
Information data rate	12.2 kbps
RU's allocated	2 RU
Midamble	1024 chips
Interleaving	20 ms
Power control	2 Bit/user
TFCI	16 Bit/user
Inband signalling DCCH	2 kbps
Puncturing level at Code rate 1/3 : DCH of the DTCH / DCH of the DCCH	5% / 0 %

**Table C.2.2.5: UL reference measurement channel using RLC-TM for DTCH, transport channel parameters (12.2 kbps, multicode)**

Higher Layer	RAB/Signalling RB	RAB	SRB	
RLC	Logical channel type	DTCH	DCCH	
	RLC mode	TM	UM/AM	
	Payload sizes, bit	244	88/80	
	Max data rate, bps	12200	2200/2000	
	PDU header, bit	N/A	8/16	
	TrD PDU header, bit	0	N/A	
MAC	MAC header, bit	0	4	
	MAC multiplexing	N/A	Yes	
Layer 1	TrCH type	DCH	DCH	
	Transport Channel Identity	1	5	
	TB sizes, bit	244	100	
	TFS	TF0, bits	0*244	0*100
		TF1, bits	1*244	1*100
	TTI, ms	20	40	
	Coding type	Convolution Coding	Convolution Coding	
	Coding Rate	1/3	1/3	
	CRC, bit	16	12	
	Max number of bits/TTI after channel coding	804	360	
	Uplink: Max number of bits/radio frame before rate matching	402	90	
RM attribute	220	232		

**Table C.2.2.6: UL reference measurement channel, TFCS (12.2 kbps, multicode)**

TFCS size	4
TFCS	(DTCH, DCCH)= (TF0, TF0), (TF1, TF0), (TF0, TF1), (TF1, TF1)

**Table C.2.2.7: UL reference measurement channel, puncturing limit (12.2 kbps, multicode)**

DPCH Downlink	Puncturing limit	0.92
---------------	------------------	------

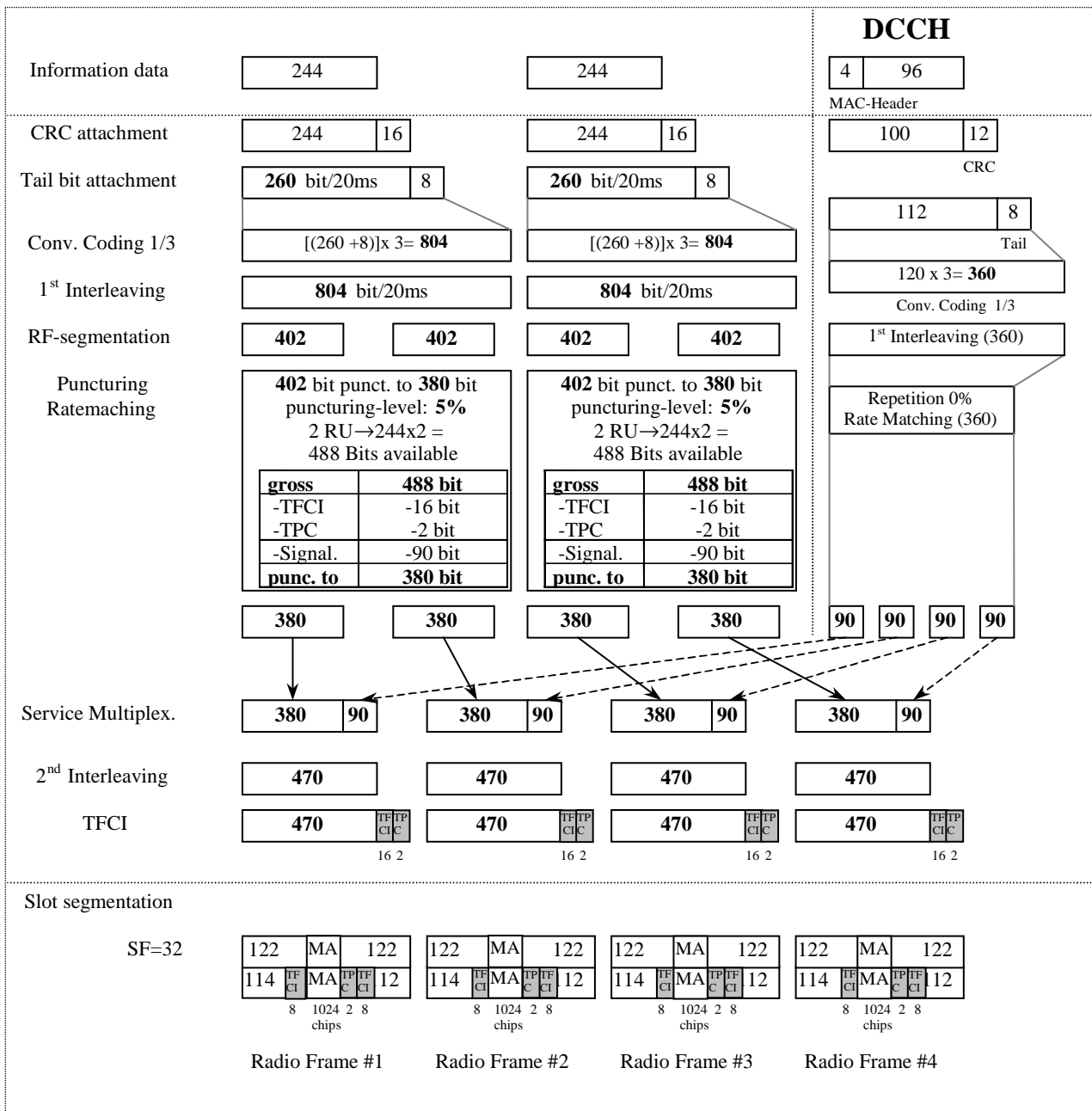

## C.2.3 UL reference measurement channel (64 kbps)

### C.2.3.1 3.84 Mcps TDD Option

**Table C.2.3.1: UL reference measurement channel physical parameters (64kbps)**

Parameter	Value
Information data rate	64 kbps
RU's allocated	1 SF4 + 1 SF16 = 5RU
Midamble	512 chips
Interleaving	20 ms
Power control	2 Bit/user
TFCI	16 Bit/user
Inband signalling DCCH	2 kbps
Puncturing level at Code rate : 1/3 DCH of the DTCH / 1/2 DCH of the DCCH	43.8% / 13.3%

**Table C.2.3.2: UL reference measurement channel using RLC-TM for DTCH, transport channel parameters (64 kbps)**

Higher Layer	RAB/Signalling RB	RAB	SRB	
RLC	Logical channel type	DTCH	DCCH	
	RLC mode	TM	UM/AM	
	Payload sizes, bit	1280	88/80	
	Max data rate, bps	64000	2200/2000	
	PDU header, bit	N/A	8/16	
	TrD PDU header, bit	0	N/A	
MAC	MAC header, bit	0	4	
	MAC multiplexing	N/A	Yes	
Layer 1	TrCH type	DCH	DCH	
	Transport Channel Identity	1	5	
	TB sizes, bit	1280	100	
	TFS	TF0, bits	0*1280	0*100
		TF1, bits	1*1280	1*100
	TTI, ms	20	40	
	Coding type	Turbo Coding	Convolution Coding	
	Coding Rate	N/A	1/2	
	CRC, bit	16	12	
	Max number of bits/TTI after channel coding	3900	240	
	Uplink: Max number of bits/radio frame before rate matching	1950	60	
RM attribute	158	240		

**Table C.2.3.3: UL reference measurement channel, TFCS (64 kbps)**

TFCS size	4
TFCS	(DTCH, DCCH)= (TF0, TF0), (TF1, TF0), (TF0, TF1), (TF1, TF1)

**Table C.2.3.4: UL reference measurement channel, puncturing limit (64 kbps)**

DPCH Downlink	Puncturing limit	0.56
---------------	------------------	------

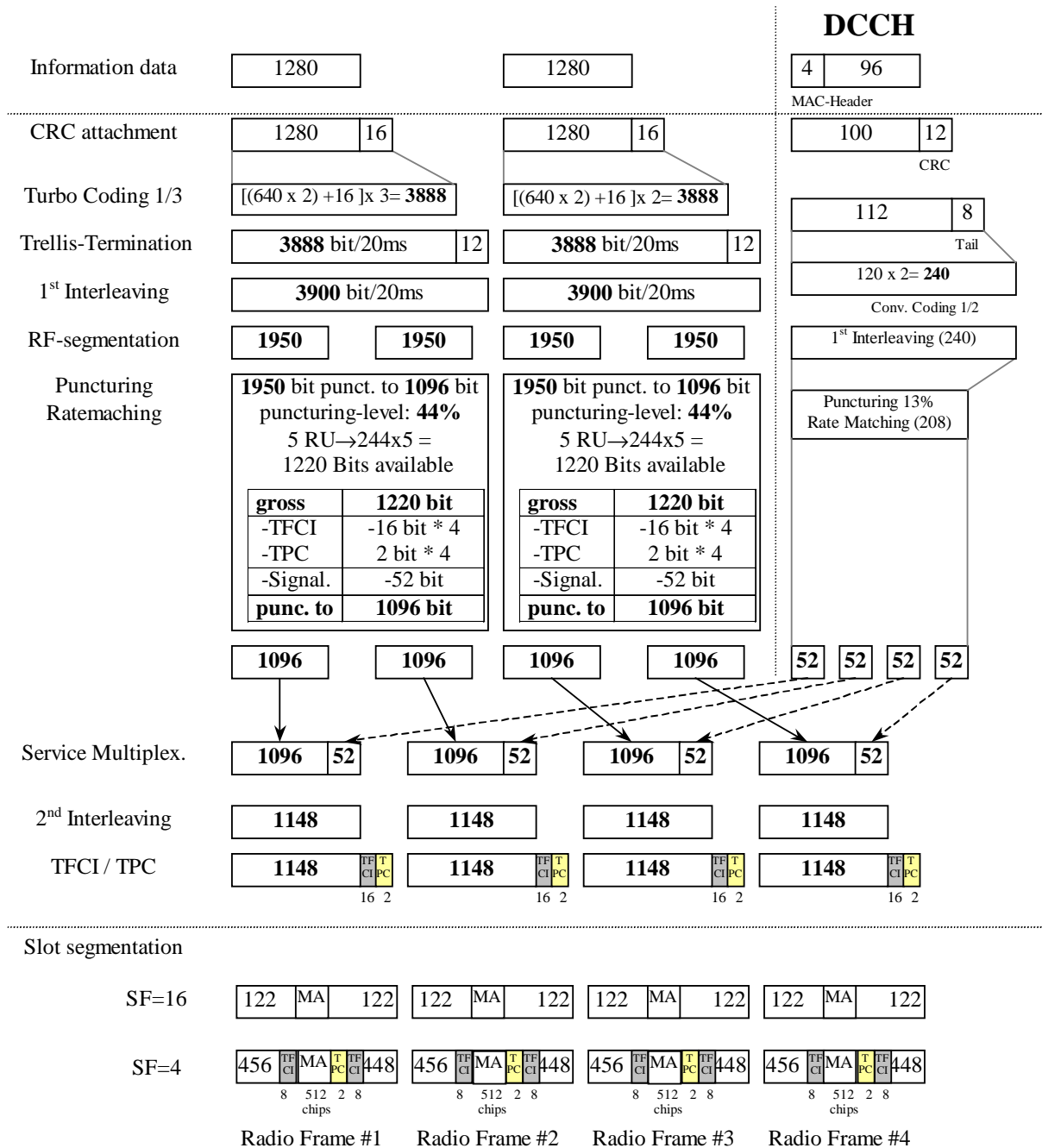

C.2.3.2 1.28 Mcps TDD Option

Table C.2.3.2

Parameter	Value
Information data rate	64 kbps
RU's allocated	1TS (1*SF2) = 8RU/5ms
Midamble	144
Interleaving	20 ms
Power control (TPC)	4 Bit/user/10ms
TFCI	16 Bit/user/10ms
Synchronisation Shift (SS)	4 Bit/user/10ms
Inband signalling DCCH	2.4 kbps
Puncturing level at Code rate: 1/3 DCH of the DTCH / 1/2 DCH of the DCCH	32% / 0

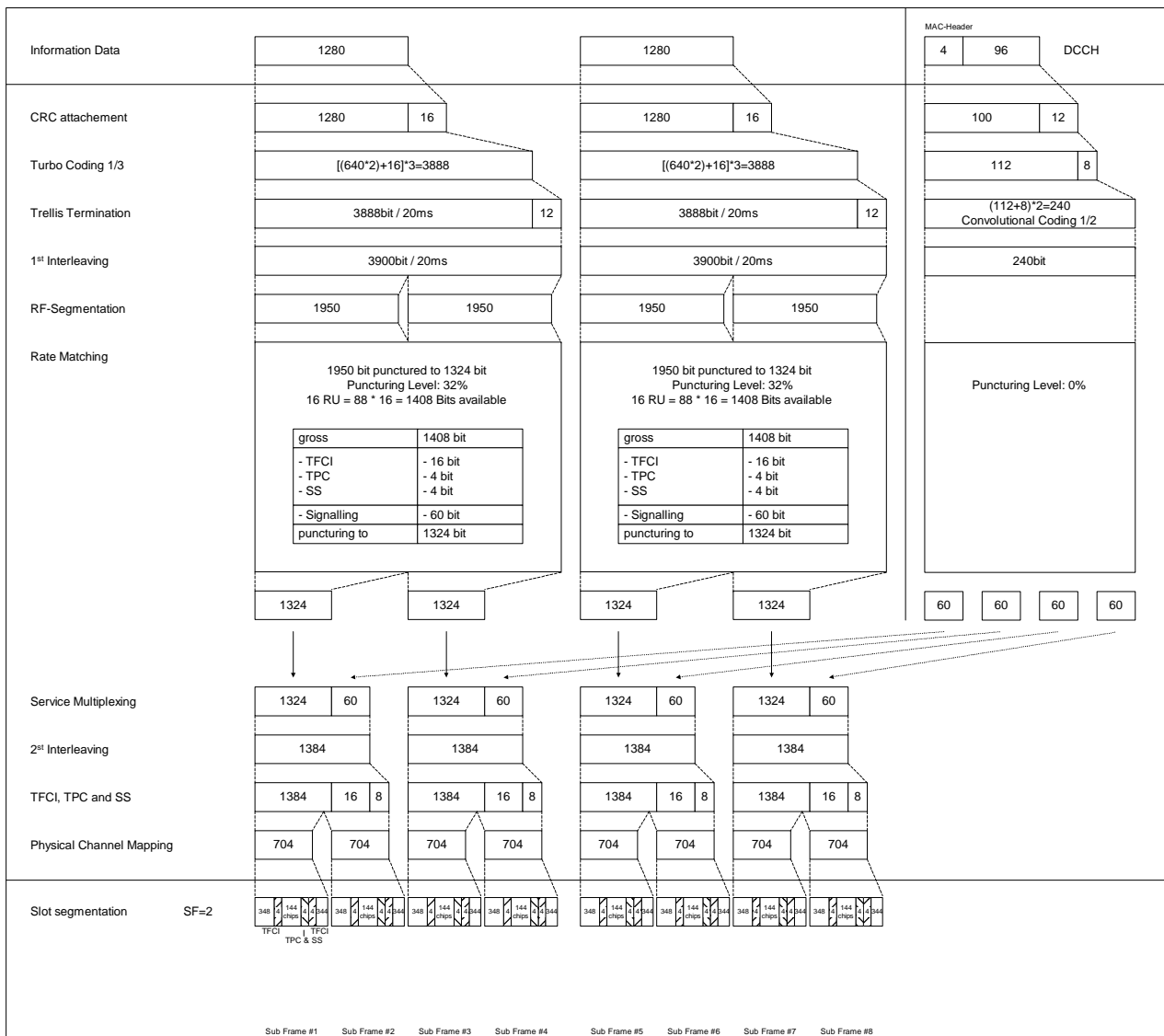

### C.2.3.3 7.68 Mcps TDD Option

Table C.2.3.5: UL reference measurement channel physical parameters (64kbps)

Parameter	Value
Information data rate	64 kbps
RU's allocated	1 SF8 + 1 SF32 = 5RU
Midamble	1024 chips
Interleaving	20 ms
Power control	2 Bit/user
TFCI	16 Bit/user
Inband signalling DCCH	2 kbps
Puncturing level at Code rate : 1/3 DCH of the DTCH / 1/2 DCH of the DCCH	43.8% / 13.3%



**Table C.2.3.6: UL reference measurement channel using RLC-TM for DTCH, transport channel parameters (64 kbps)**

Higher Layer	RAB/Signalling RB	RAB	SRB	
RLC	Logical channel type	DTCH	DCCH	
	RLC mode	TM	UM/AM	
	Payload sizes, bit	1280	88/80	
	Max data rate, bps	64000	2200/2000	
	PDU header, bit	N/A	8/16	
	TrD PDU header, bit	0	N/A	
MAC	MAC header, bit	0	4	
	MAC multiplexing	N/A	Yes	
Layer 1	TrCH type	DCH	DCH	
	Transport Channel Identity	1	5	
	TB sizes, bit	1280	100	
	TFS	TF0, bits	0*1280	0*100
		TF1, bits	1*1280	1*100
	TTI, ms	20	40	
	Coding type	Turbo Coding	Convolution Coding	
	Coding Rate	N/A	1/2	
	CRC, bit	16	12	
	Max number of bits/TTI after channel coding	3900	240	
	Uplink: Max number of bits/radio frame before rate matching	1950	60	
RM attribute	158	240		

**Table C.2.3.7: UL reference measurement channel, TFCS (64 kbps)**

TFCS size	4
TFCS	(DTCH, DCCH)= (TF0, TF0), (TF1, TF0), (TF0, TF1), (TF1, TF1)

**Table C.2.3.8: UL reference measurement channel, puncturing limit (64 kbps)**

DPCH Downlink	Puncturing limit	0.56
---------------	------------------	------

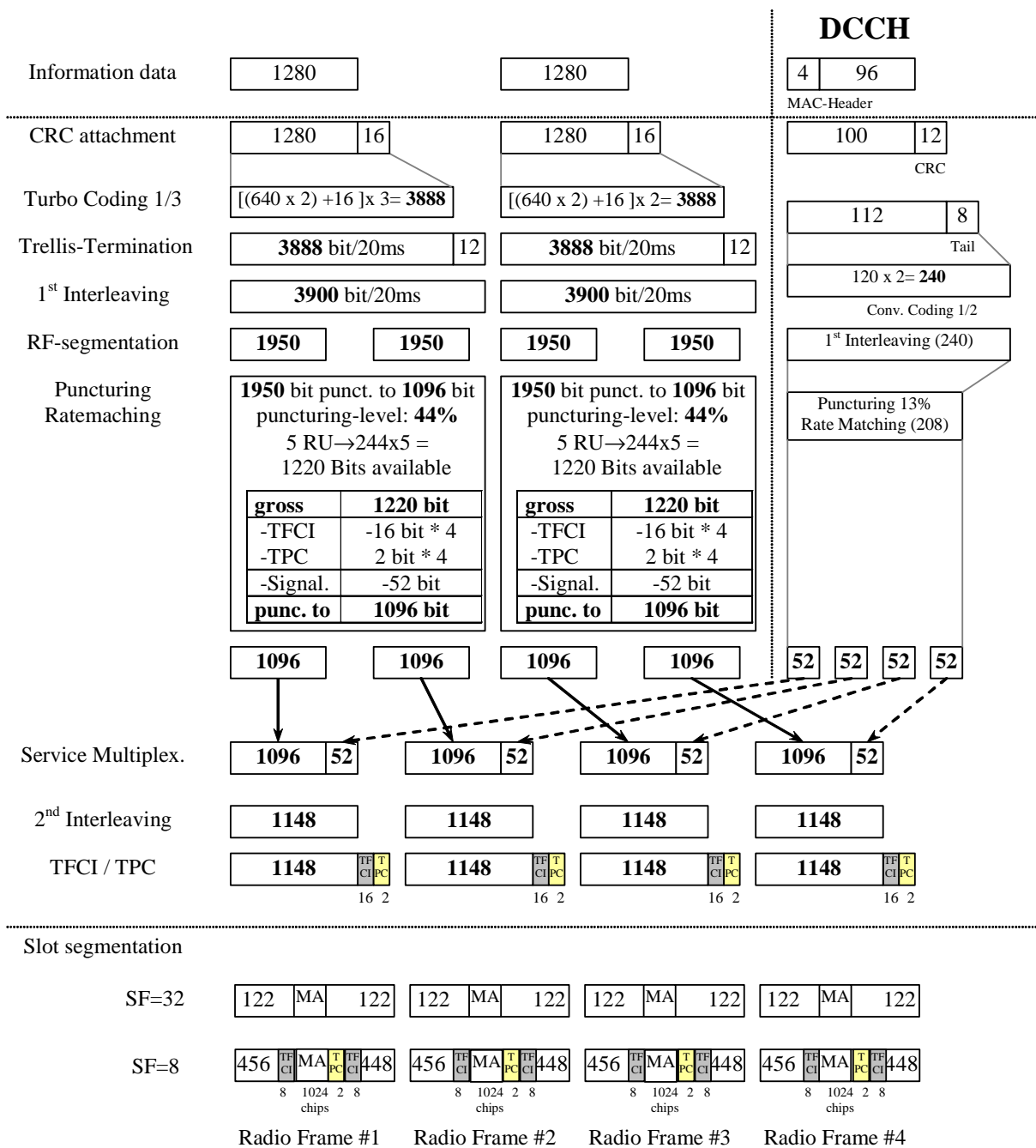

Figure A.2B

## C.2.4 UL reference measurement channel (144 kbps)

### C.2.4.1 3.84 Mcps TDD Option

**Table C.2.4.1: UL reference measurement channel physical parameters (144kbps)**

Parameter	Value
Information data rate	144 kbps
RU's allocated	1 SF2 + 1 SF16 = 9RU
Midamble	256 chips
Interleaving	20 ms
Power control	2 Bit/user
TFCI	16 Bit/user
Inband signalling DCCH	2 kbps
Puncturing level at Code rate : 1/3 DCH of the DTCH / ½ DCH of the DCCH	47.3% / 20%

**Table C.2.4.2: UL reference measurement channel using RLC-TM for DTCH, transport channel parameters (144 kbps)**

Higher Layer	RAB/Signalling RB	RAB	SRB	
RLC	Logical channel type	DTCH	DCCH	
	RLC mode	TM	UM/AM	
	Payload sizes, bit	2880	88/80	
	Max data rate, bps	144000	2200/2000	
	PDU header, bit	N/A	8/16	
	TrD PDU header, bit	0	N/A	
MAC	MAC header, bit	0	4	
	MAC multiplexing	N/A	Yes	
Layer 1	TrCH type	DCH	DCH	
	Transport Channel Identity	1	5	
	TB sizes, bit	2880	100	
	TFS	TF0, bits	0*2880	0*100
		TF1, bits	1*2880	1*100
	TTI, ms	20	40	
	Coding type	Turbo Coding	Convolution Coding	
	Coding Rate	N/A	1/2	
	CRC, bit	16	12	
	Max number of bits/TTI after channel coding	8700	240	
	Uplink: Max number of bits/radio frame before rate matching	4350	60	
	RM attribute	160	240	

**Table C.2.4.3: UL reference measurement channel, TFCS (144 kbps)**

TFCS size	4
TFCS	(DTCH, DCCH)= (TF0, TF0), (TF1, TF0), (TF0, TF1), (TF1, TF1)

**Table C.2.4.4: UL reference measurement channel, puncturing limit (144 kbps)**

DPCH Downlink	Puncturing limit	0.52
---------------	------------------	------

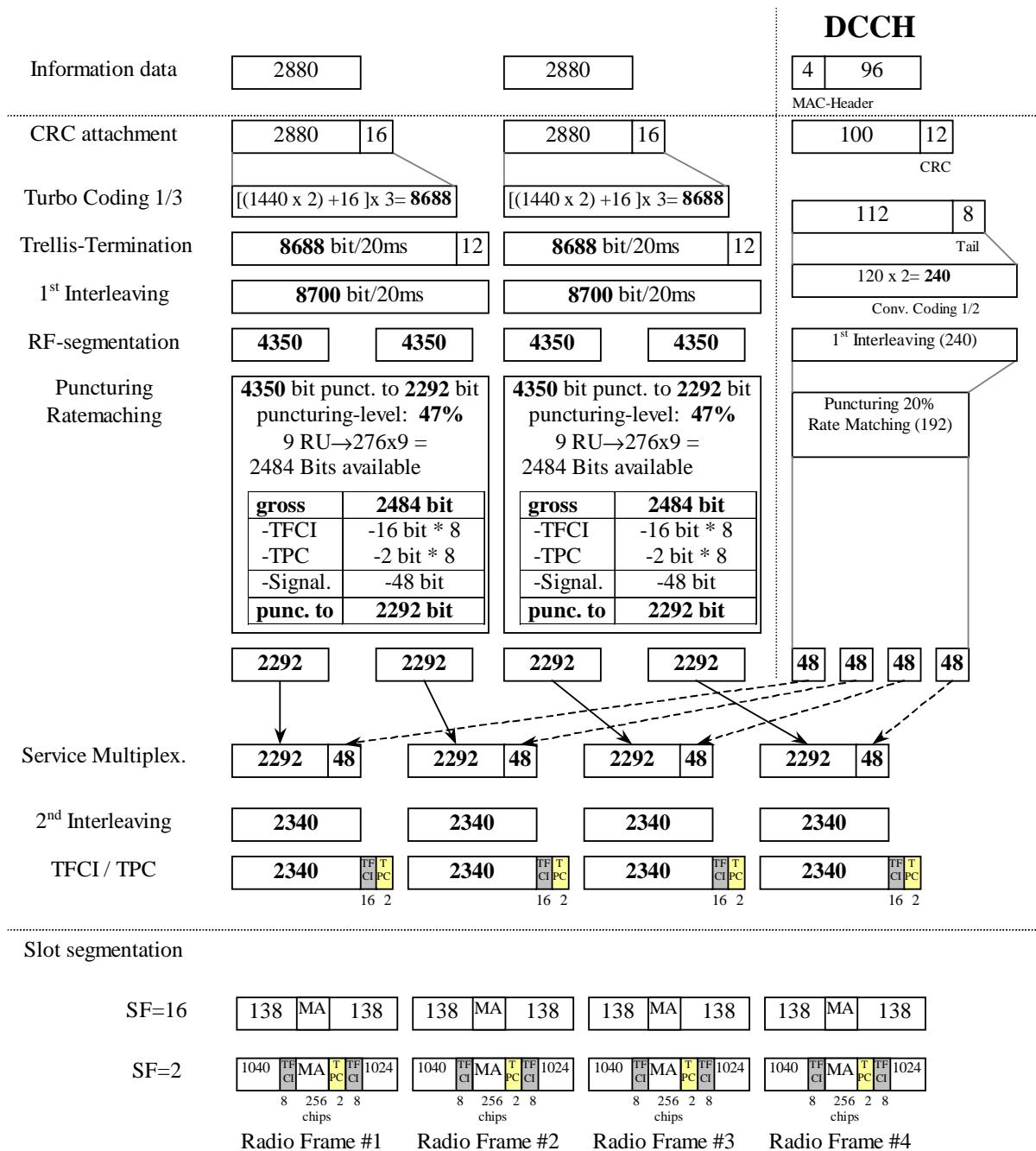

C.2.4.2 1.28 Mcps TDD Option

Table C.2.4.2

Parameter	Value
Information data rate	144 kbps
RU's allocated	2TS (1*SF2) = 16RU/5ms
Midamble	144
Interleaving	20 ms
Power control (TPC)	8 Bit/user/10ms
TFCI	32 Bit/user/10ms
Synchronisation Shift (SS)	8 Bit/user/10ms
Inband signalling DCCH	2.4 kbps
Puncturing level at Code rate: 1/3 DCH of the DTCH / 1/2 DCH of the DCCH	38% / 7%

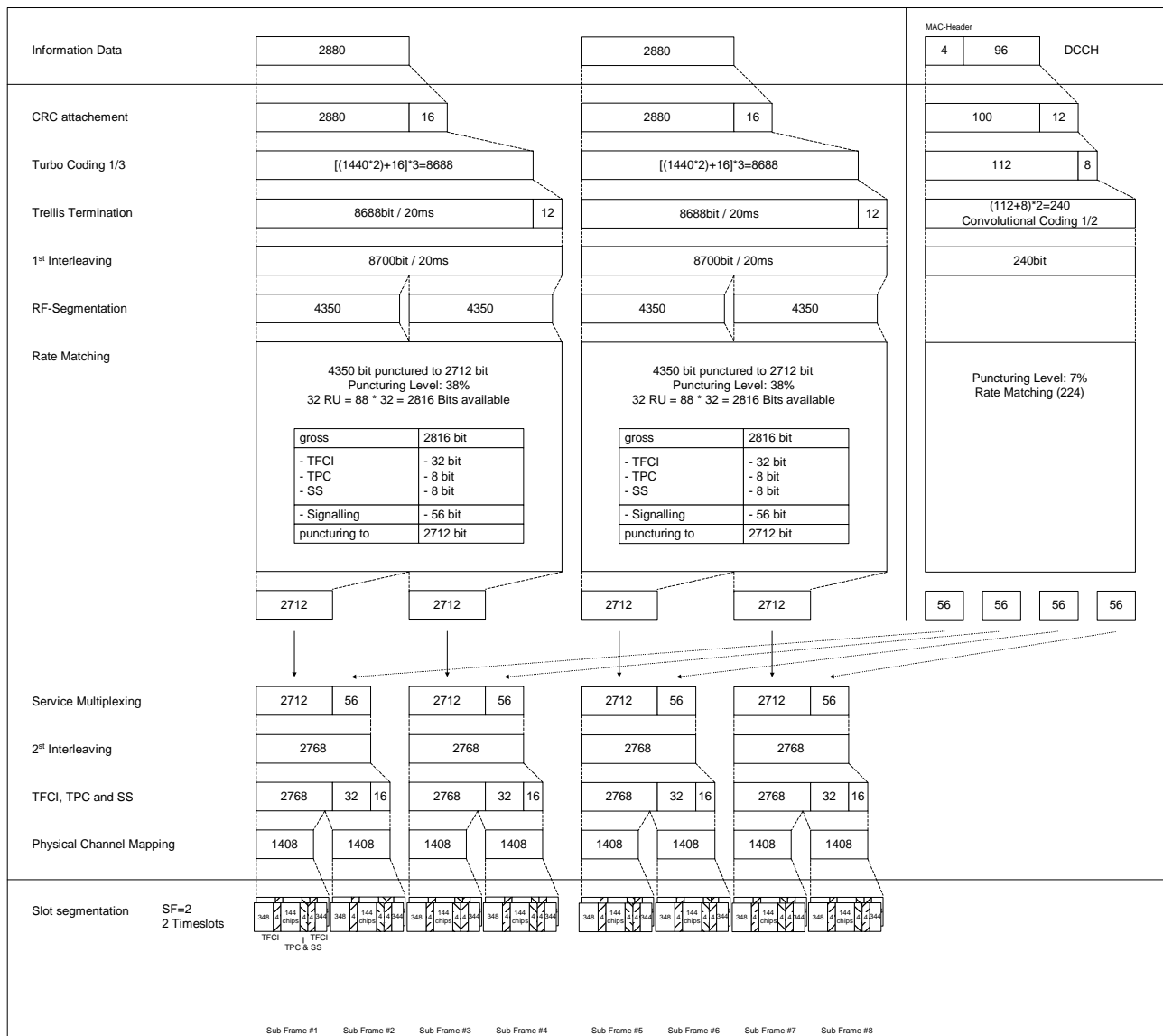

### C.2.4.3 7.68 Mcps TDD Option

Table C.2.4.5: UL reference measurement channel physical parameters (144kbps)

Parameter	Value
Information data rate	144 kbps
RU's allocated	1 SF4 + 1 SF32 = 9RU
Midamble	512 chips
Interleaving	20 ms
Power control	2 Bit/user
TFCI	16 Bit/user
Inband signalling DCCH	2 kbps
Puncturing level at Code rate : 1/3 DCH of the DTCH / 1/2 DCH of the DCCH	47.3% / 20%

**Table C.2.4.6: UL reference measurement channel using RLC-TM for DTCH, transport channel parameters (144 kbps)**

Higher Layer	RAB/Signalling RB	RAB	SRB	
RLC	Logical channel type	DTCH	DCCH	
	RLC mode	TM	UM/AM	
	Payload sizes, bit	2880	88/80	
	Max data rate, bps	144000	2200/2000	
	PDU header, bit	N/A	8/16	
	TrD PDU header, bit	0	N/A	
MAC	MAC header, bit	0	4	
	MAC multiplexing	N/A	Yes	
Layer 1	TrCH type	DCH	DCH	
	Transport Channel Identity	1	5	
	TB sizes, bit	2880	100	
	TFS	TF0, bits	0*2880	0*100
		TF1, bits	1*2880	1*100
	TTI, ms	20	40	
	Coding type	Turbo Coding	Convolution Coding	
	Coding Rate	N/A	1/2	
	CRC, bit	16	12	
	Max number of bits/TTI after channel coding	8700	240	
	Uplink: Max number of bits/radio frame before rate matching	4350	60	
RM attribute	160	240		

**Table C.2.4.7: UL reference measurement channel, TFCS (144 kbps)**

TFCS size	4
TFCS	(DTCH, DCCH)= (TF0, TF0), (TF1, TF0), (TF0, TF1), (TF1, TF1)

**Table C.2.4.8: UL reference measurement channel, puncturing limit (144 kbps)**

DPCH Downlink	Puncturing limit	0.52
---------------	------------------	------

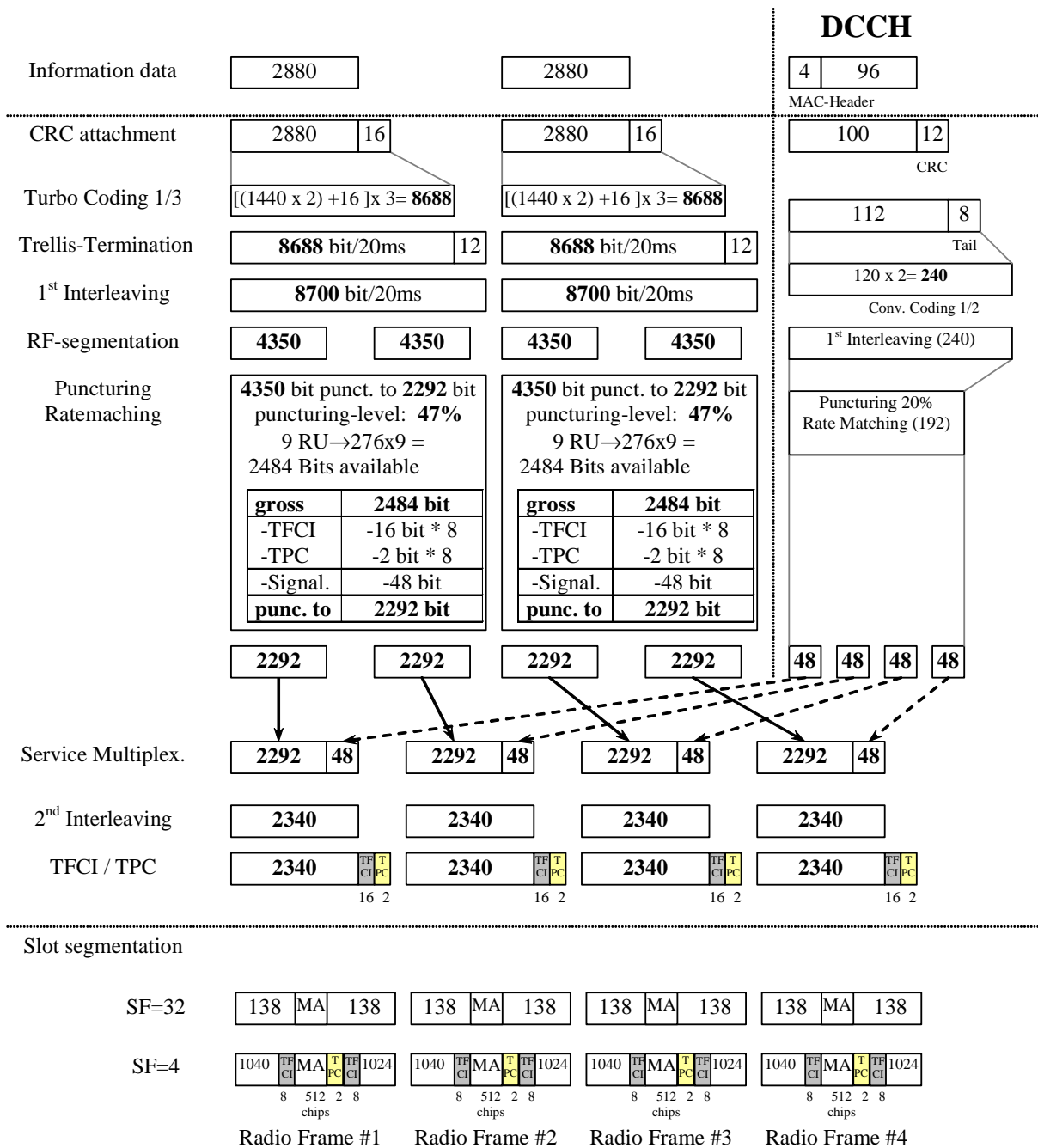

## C.2.5 UL reference measurement channel (384 kbps)

### C.2.5.1 3.84 Mcps TDD Option

**Table C.2.5.1: UL reference measurement channel physical parameters (384kbps)**

Parameter	
Information data rate	384 kbps
RU's allocated	8*3TS = 24RU
Midamble	256 chips
Interleaving	20 ms
Power control	2 Bit/user
TFCI	16 Bit/user
Inband signalling DCCH	2 kbps
Puncturing level at Code rate : 1/3 DCH of the DTCH / 1/2 DCH of the DCCH	43.4% / 15.3%

**Table C.2.5.2: UL reference measurement channel using RLC-TM for DTCH, transport channel parameters (384 kbps)**

Higher Layer	RAB/Signalling RB	RAB	SRB	
RLC	Logical channel type	DTCH	DCCH	
	RLC mode	TM	UM/AM	
	Payload sizes, bit	3840	88/80	
	Max data rate, bps	384000	2200/2000	
	PDU header, bit	N/A	8/16	
	TrD PDU header, bit	0	N/A	
MAC	MAC header, bit	0	4	
	MAC multiplexing	N/A	Yes	
Layer 1	TrCH type	DCH	DCH	
	Transport Channel Identity	1	5	
	TB sizes, bit	2880	100	
	TFS	TF0, bits	0*3840	0*100
		TF1, bits	2*3840	1*100
	TTI, ms	20	40	
	Coding type	Turbo Coding	Convolution Coding	
	Coding Rate	N/A	1/2	
	CRC, bit	16	12	
	Max number of bits/TTI after channel coding	23160	240	
	Uplink: Max number of bits/radio frame before rate matching	11580	60	
RM attribute	158	240		

**Table C.2.5.3: UL reference measurement channel, TFCS (384 kbps)**

TFCS size	4
TFCS	(DTCH, DCCH)= (TF0, TF0), (TF1, TF0), (TF0, TF1), (TF1, TF1)

**Table C.2.5.4: UL reference measurement channel, puncturing limit (384 kbps)**

DPCH Downlink	Puncturing limit	0.52
---------------	------------------	------



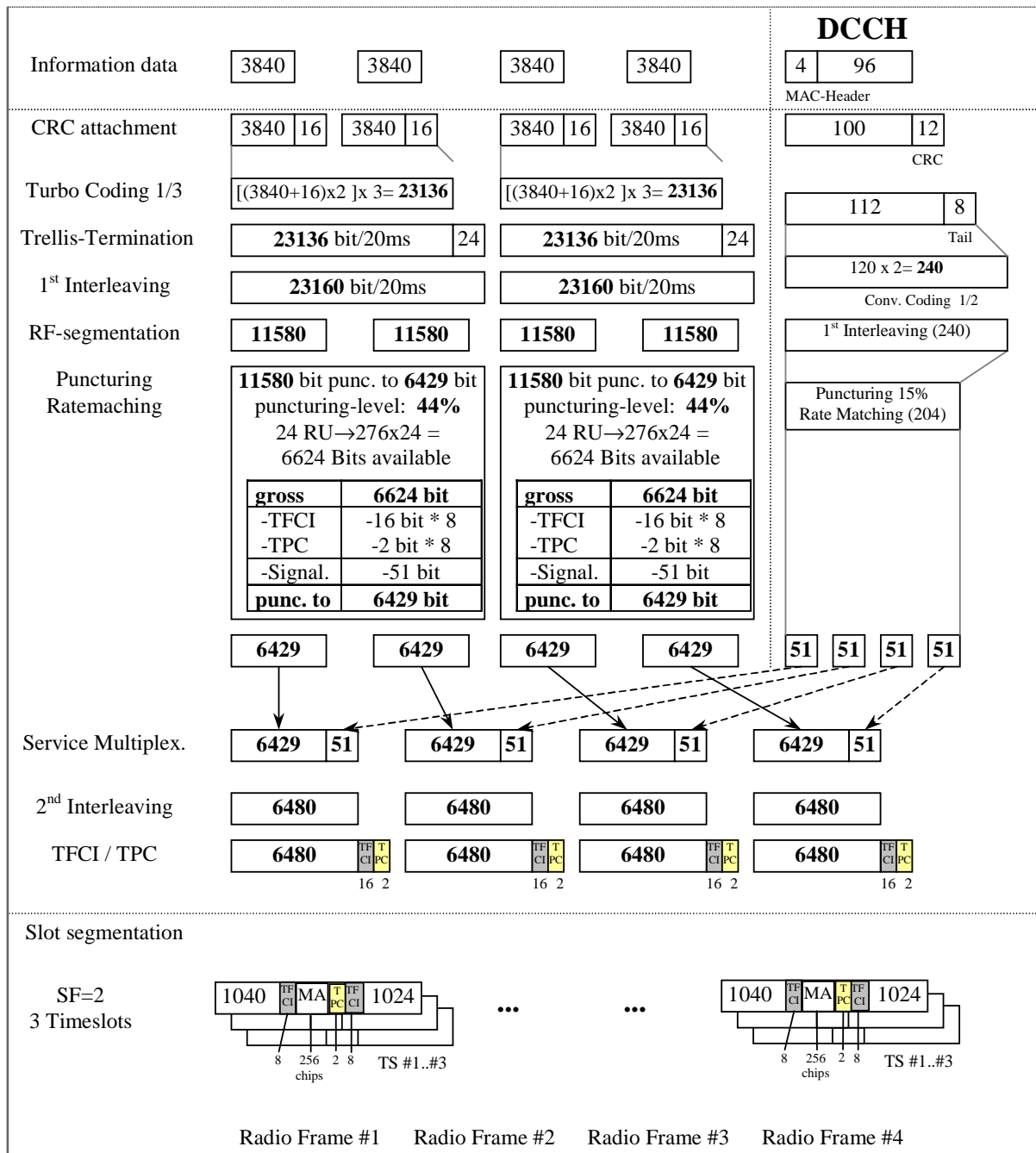

### C.2.5.2 1.28 Mcps TDD Option

Table C.2.5.2

Parameter	Value
Information data rate	384 kbps
RU's allocated	4TS (1*SF2 + 1*SF16) = 36RU/5ms
Midamble	144
Interleaving	20 ms
Power control (TPC)	16 Bit/user/10ms
TFCI	64 Bit/user/10ms
Synchronisation Shift (SS)	16 Bit/user/10ms
Inband signalling DCCH	2.4 kbps
Puncturing level at Code rate: 1/3 DCH of the DTCH / 1/2 DCH of the DCCH	47% / 12%

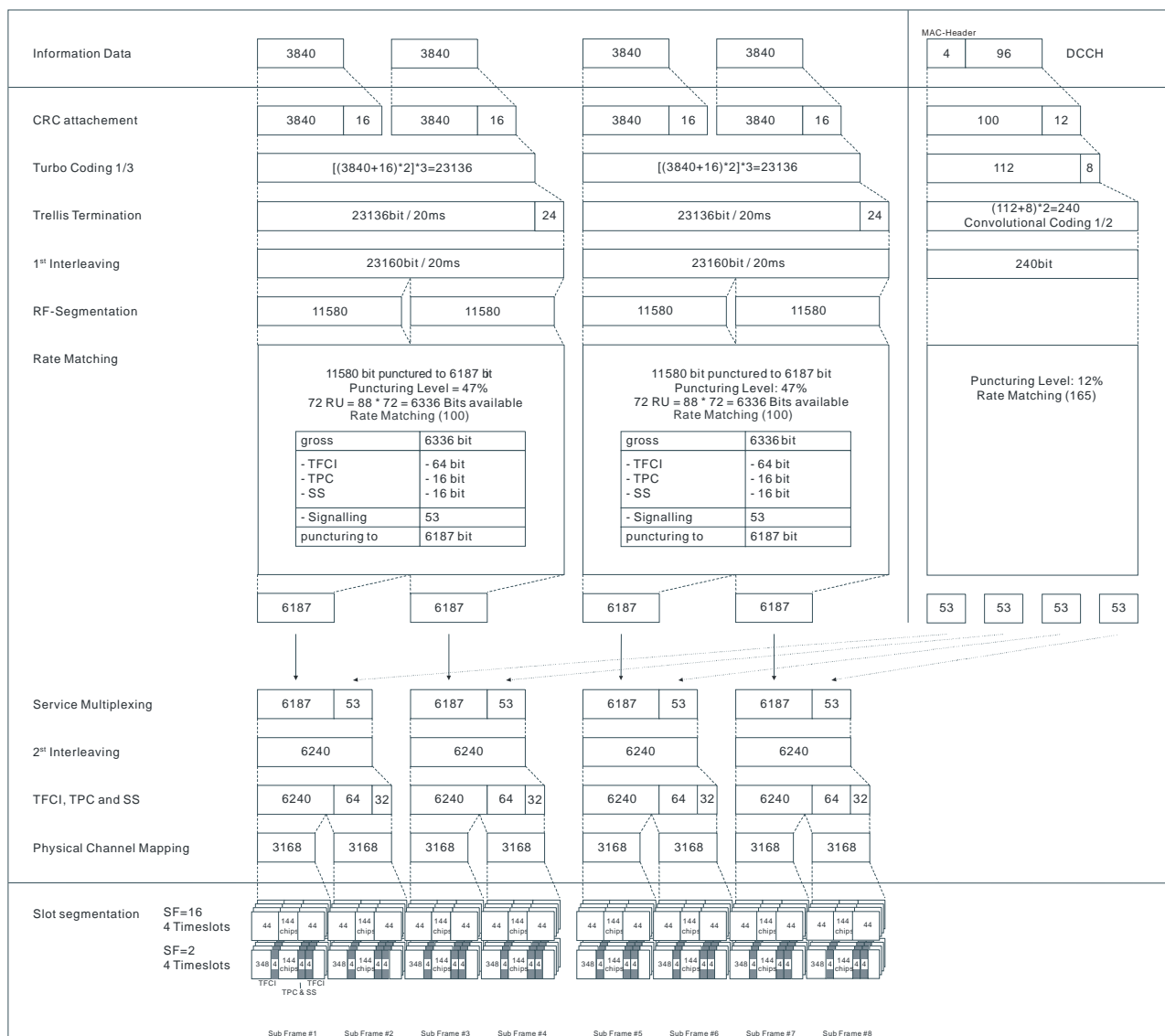

## C.2.5.3 7.68 Mcps TDD Option

Table C.2.5.3: UL reference measurement channel physical parameters (384kbps)

Parameter	Value
Information data rate	384 kbps
RU's allocated	8*3TS = 24RU
Midamble	512 chips
Interleaving	20 ms
Power control	2 Bit/user
TFCI	16 Bit/user
Inband signalling DCCH	2 kbps
Puncturing level at Code rate : 1/3 DCH of the DTCH / 1/2 DCH of the DCCH	43.4% / 15.3%

Table C.2.5.4: UL reference measurement channel using RLC-TM for DTCH, transport channel parameters (384 kbps)

Higher Layer	RAB/Signalling RB	RAB	SRB	
RLC	Logical channel type	DTCH	DCCH	
	RLC mode	TM	UM/AM	
	Payload sizes, bit	3840	88/80	
	Max data rate, bps	384000	2200/2000	
	PDU header, bit	N/A	8/16	
	TrD PDU header, bit	0	N/A	
MAC	MAC header, bit	0	4	
	MAC multiplexing	N/A	Yes	
Layer 1	TrCH type	DCH	DCH	
	Transport Channel Identity	1	5	
	TB sizes, bit	2880	100	
	TFS	TF0, bits	0*3840	0*100
		TF1, bits	2*3840	1*100
	TTI, ms	20	40	
	Coding type	Turbo Coding	Convolution Coding	
	Coding Rate	N/A	1/2	
	CRC, bit	16	12	
	Max number of bits/TTI after channel coding	23160	240	
	Uplink: Max number of bits/radio frame before rate matching	11580	60	
	RM attribute	158	240	

Table C.2.5.5: UL reference measurement channel, TFCS (384 kbps)

TFCS size	4
TFCS	(DTCH, DCCH)= (TF0, TF0), (TF1, TF0), (TF0, TF1), (TF1, TF1)

Table C.2.5.6: UL reference measurement channel, puncturing limit (384 kbps)

DPCH Downlink	Puncturing limit	0.52
---------------	------------------	------

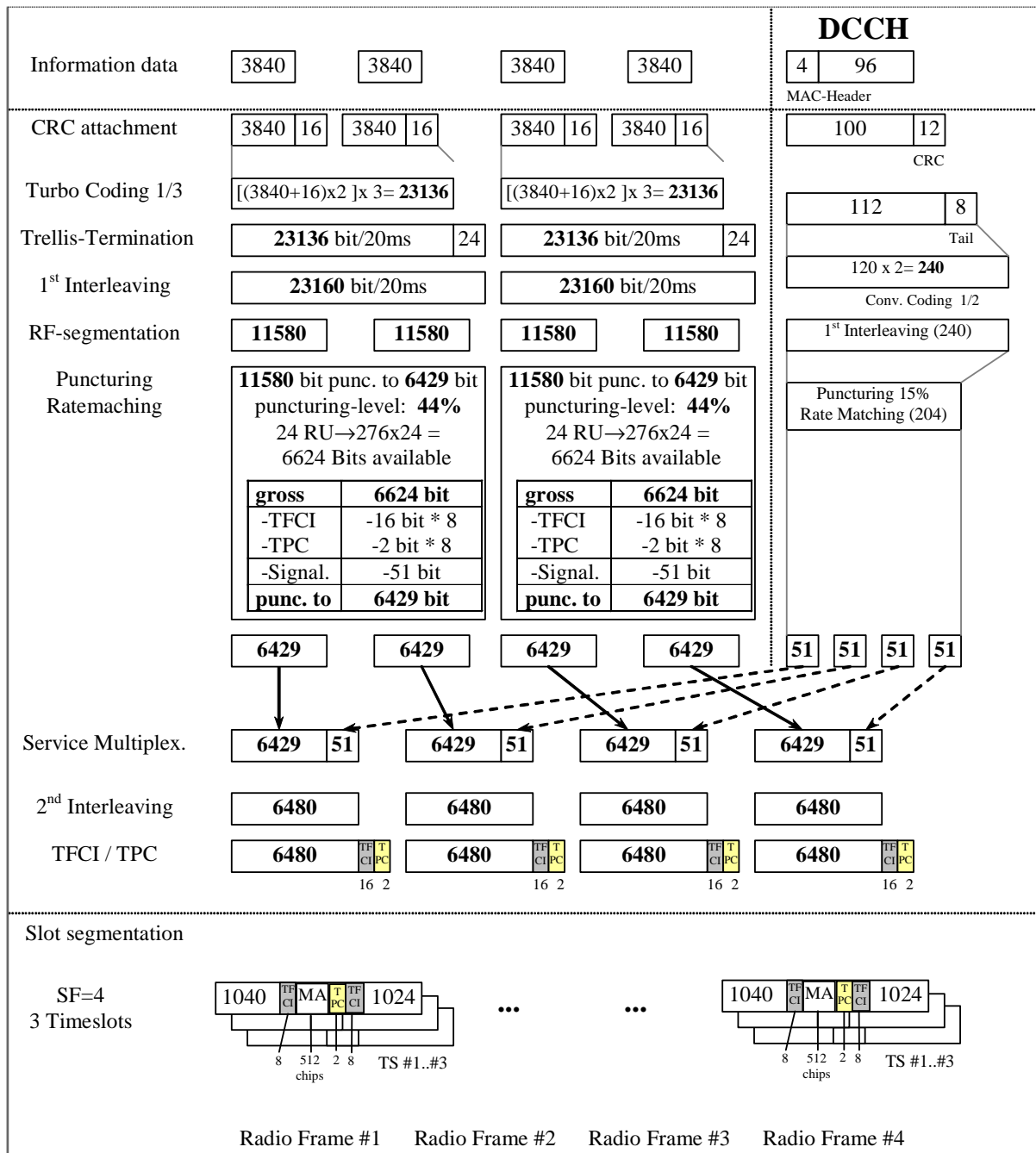

## C.3 DL Reference measurement channels

### C.3.1 DL reference measurement channel (12,2 kbps)

#### C.3.1.1 3,84 Mcps TDD Option

**Table C.3.1.1: DL reference measurement channel physical parameters (12.2kbps)**

Parameter	
Information data rate	12,2 kbps
RU's allocated	2 RU
Midamble	512 chips
Interleaving	20 ms
Power control	0 Bit/user
TFCI	16 Bit/user
Inband signalling DCCH	2 kbps
Puncturing level at Code rate 1/3 : DCH of the DTCH / DCH of the DCCH	5% / 0 %

**Table C.3.1.2: DL reference measurement channel using RLC-TM for DTCH, transport channel parameters (12.2 kbps)**

Higher Layer	RAB/Signalling RB	RAB	SRB	
RLC	Logical channel type	DTCH	DCCH	
	RLC mode	TM	UM/AM	
	Payload sizes, bit	244	88/80	
	Max data rate, bps	12200	2200/2000	
	PDU header, bit	N/A	8/16	
	TrD PDU header, bit	0	N/A	
MAC	MAC header, bit	0	4	
	MAC multiplexing	N/A	Yes	
Layer 1	TrCH type	DCH	DCH	
	Transport Channel Identity	6	10	
	TB sizes, bit	244	100	
	TFS	TF0, bits	0*244	0*100
		TF1, bits	1*244	1*100
	TTI, ms	20	40	
	Coding type	Convolution Coding	Convolution Coding	
	Coding Rate	1/3	1/3	
	CRC, bit	16	12	
	Max number of bits/TTI after channel coding	804	360	
	Downlink: Max number of bits/radio frame before rate matching	402	90	
	RM attribute	228	240	

**Table C.3.1.3: DL reference measurement channel, TFCS (12.2 kbps)**

TFCS size	4
TFCS	(DTCH, DCCH)= (TF0, TF0), (TF1, TF0), (TF0, TF1), (TF1, TF1)

**Table C.3.1.4: DL reference measurement channel, puncturing limit (12.2 kbps)**

DPCH Downlink	Puncturing limit	0.92
---------------	------------------	------

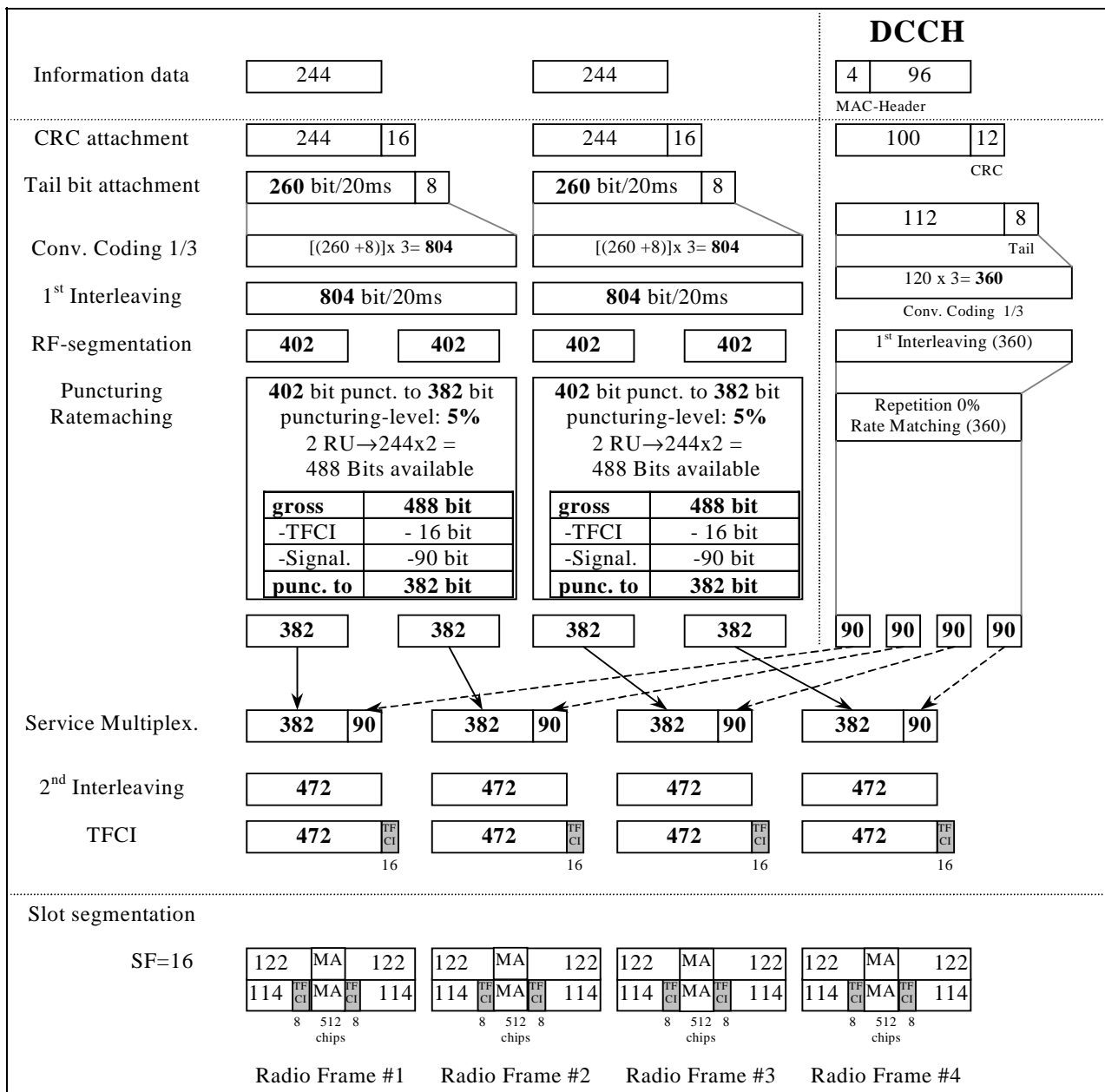

C.3.1.2 DL reference measurement channel (12,2 kbps) for 1,28 Mcps TDD Option

Table C.3.1.2

Parameter	Value
Information data rate	12,2 kbps
RU's allocated	1TS (2*SF16) = 2RU/5ms
Midamble	144
Interleaving	20 ms
Power control (TPC)	4 Bit/user/10ms
TFCI	16 Bit/user/10ms
Synchronisation Shift (SS)	4 Bit/user/10ms
Inband signalling DCCH	2.4 kbps
Puncturing level at Code rate 1/3 : DCH of the DTCH / DCH of the DCCH	33% / 33%

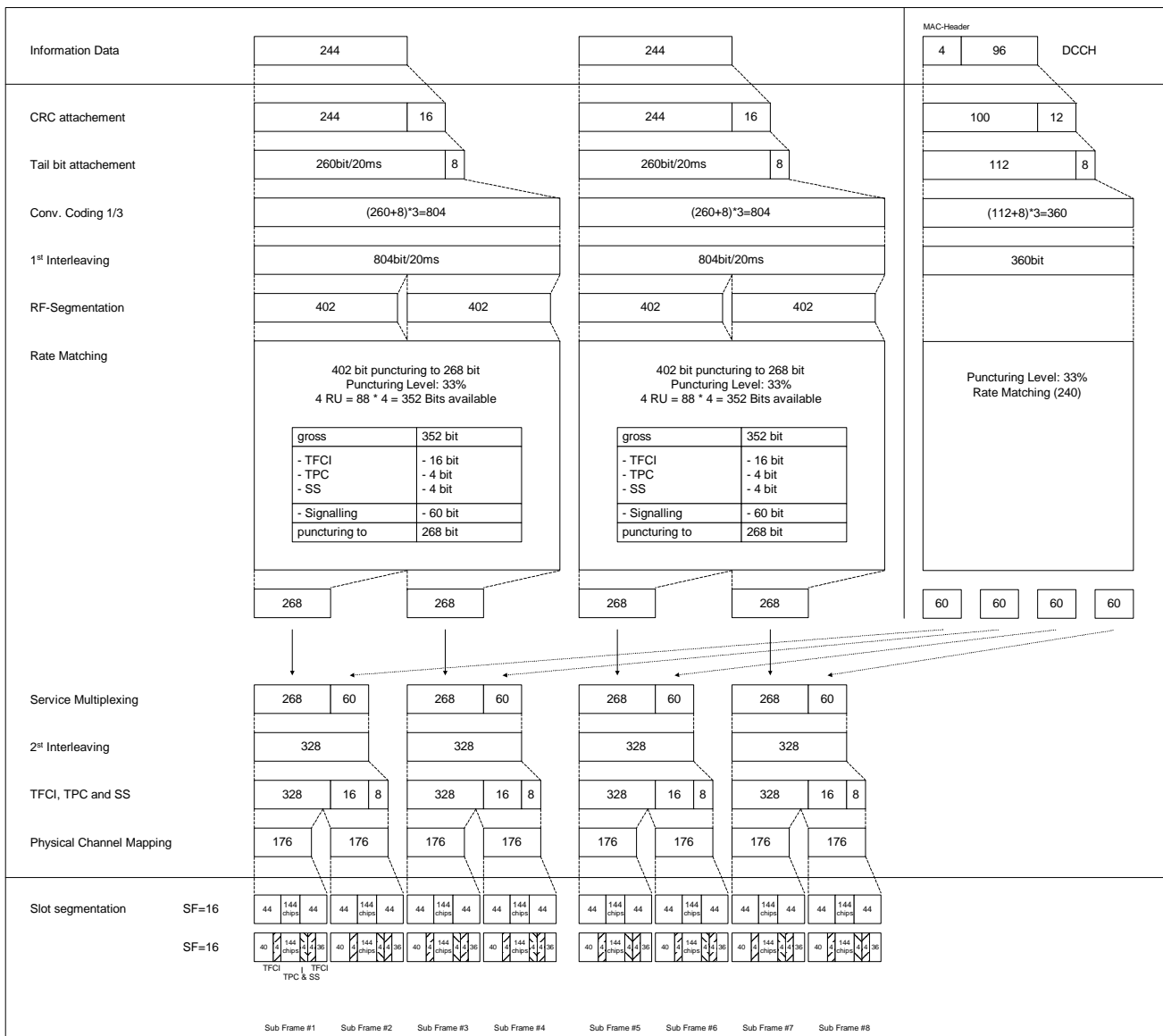

### C.3.1.3 7,68 Mcps TDD Option

Table C.3.1.5: DL reference measurement channel physical parameters (12.2kbps)

Parameter	Value
Information data rate	12.2 kbps
RU's allocated	2 RU
Midamble	1024 chips
Interleaving	20 ms
Power control	0 Bit/user
TFCI	16 Bit/user
Inband signalling DCCH	2 kbps
Puncturing level at Code rate 1/3 : DCH of the DTCH / DCH of the DCCH	5% / 0 %

**Table C.3.1.6: DL reference measurement channel using RLC-TM for DTCH, transport channel parameters (12.2 kbps)**

Higher Layer	RAB/Signalling RB	RAB	SRB	
RLC	Logical channel type	DTCH	DCCH	
	RLC mode	TM	UM/AM	
	Payload sizes, bit	244	88/80	
	Max data rate, bps	12200	2200/2000	
	PDU header, bit	N/A	8/16	
	TrD PDU header, bit	0	N/A	
MAC	MAC header, bit	0	4	
	MAC multiplexing	N/A	Yes	
Layer 1	TrCH type	DCH	DCH	
	Transport Channel Identity	6	10	
	TB sizes, bit	244	100	
	TFS	TF0, bits	0*244	0*100
		TF1, bits	1*244	1*100
	TTI, ms	20	40	
	Coding type	Convolution Coding	Convolution Coding	
	Coding Rate	1/3	1/3	
	CRC, bit	16	12	
	Max number of bits/TTI after channel coding	804	360	
	Downlink: Max number of bits/radio frame before rate matching	402	90	
	RM attribute	228	240	

**Table C.3.1.7: DL reference measurement channel, TFCS (12.2 kbps)**

TFCS size	4
TFCS	(DTCH, DCCH)= (TF0, TF0), (TF1, TF0), (TF0, TF1), (TF1, TF1)

**Table C.3.1.8: DL reference measurement channel, puncturing limit (12.2 kbps)**

DPCH Downlink	Puncturing limit	0.92
---------------	------------------	------



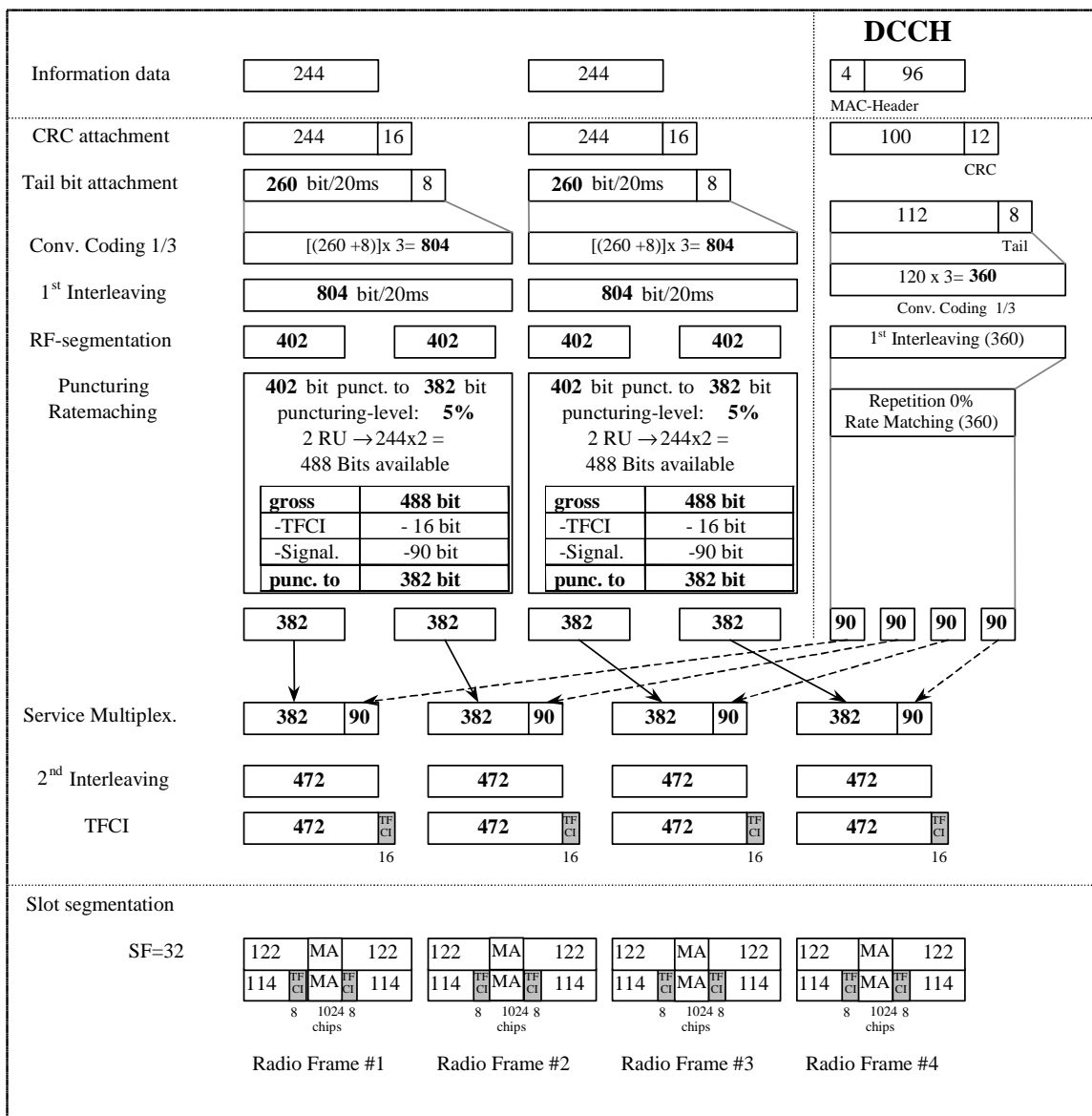

Figure A.2B

### C.3.2 DL reference measurement channel (64 kbps)

#### C.3.2.1 3,84 Mcps TDD Option

Table C.3.2.1: DL reference measurement channel physical parameters (64kbps)

Parameter	
Information data rate	64 kbps
RU's allocated	5 codes SF16 = 5RU
Midamble	512 chips
Interleaving	20 ms
Power control	0 Bit/user
TFCI	16 Bit/user
Inband signalling DCCH	2 kbps
Puncturing level at Code rate : 1/3 DCH of the DTCH / 1/2 DCH of the DCCH	41.1% / 10%

**Table C.3.2.2: DL reference measurement channel using RLC-TM for DTCH, transport channel parameters (64 kbps)**

Higher Layer	RAB/Signalling RB	RAB	SRB
RLC	Logical channel type	DTCH	DCCH
	RLC mode	TM	UM/AM
	Payload sizes, bit	1280	88/80
	Max data rate, bps	64000	2200/2000
	PDU header, bit	N/A	8/16
	TrD PDU header, bit	0	N/A
MAC	MAC header, bit	0	4
	MAC multiplexing	N/A	Yes
Layer 1	TrCH type	DCH	DCH
	Transport Channel Identity	6	10
	TB sizes, bit	1280	100
	TFS	TF0, bits	0*1280
		TF1, bits	1*1280
	TTI, ms	20	40
	Coding type	Turbo Coding	Convolution Coding
	Coding Rate	1/3	1/2
	CRC, bit	16	12
	Max number of bits/TTI after channel coding	3900	240
	Downlink: Max number of bits/radio frame before rate matching	1950	60
	RM attribute	160	240

**Table C.3.2.3: DL reference measurement channel, TFCS (64 kbps)**

TFCS size	4
TFCS	(DTCH, DCCH)= (TF0, TF0), (TF1, TF0), (TF0, TF1), (TF1, TF1)

**Table C.3.2.4: DL reference measurement channel, puncturing limit (64 kbps)**

DPCH Downlink	Puncturing limit	0.56
---------------	------------------	------

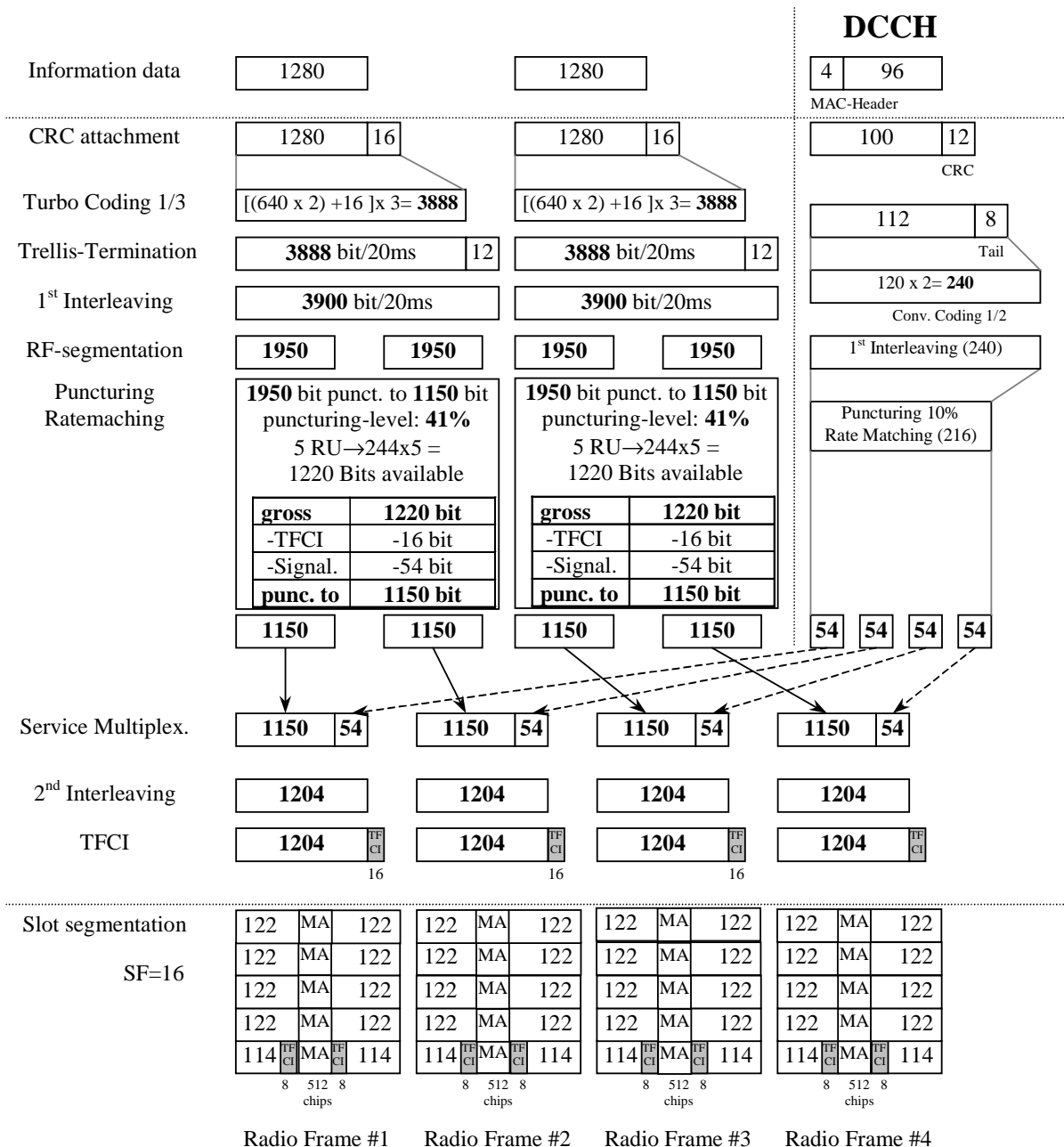

C.3.2.2 DL reference measurement channel (64 kbps) for 1,28 Mcps TDD Option

Table C.3.2.2

Parameter	Value
Information data rate	64 kbps
RU's allocated	1TS (8*SF16) = 8RU/5ms
Midamble	144
Interleaving	20 ms
Power control (TPC)	4 Bit/user/10ms
TFCI	16 Bit/user/10ms
Synchronisation Shift (SS)	4 Bit/user/10ms
Inband signalling DCCH	2.4 kbps
Puncturing level at Code rate: 1/3 DCH of the DTCH/ 1/2 DCH of the DCCH	32% / 0

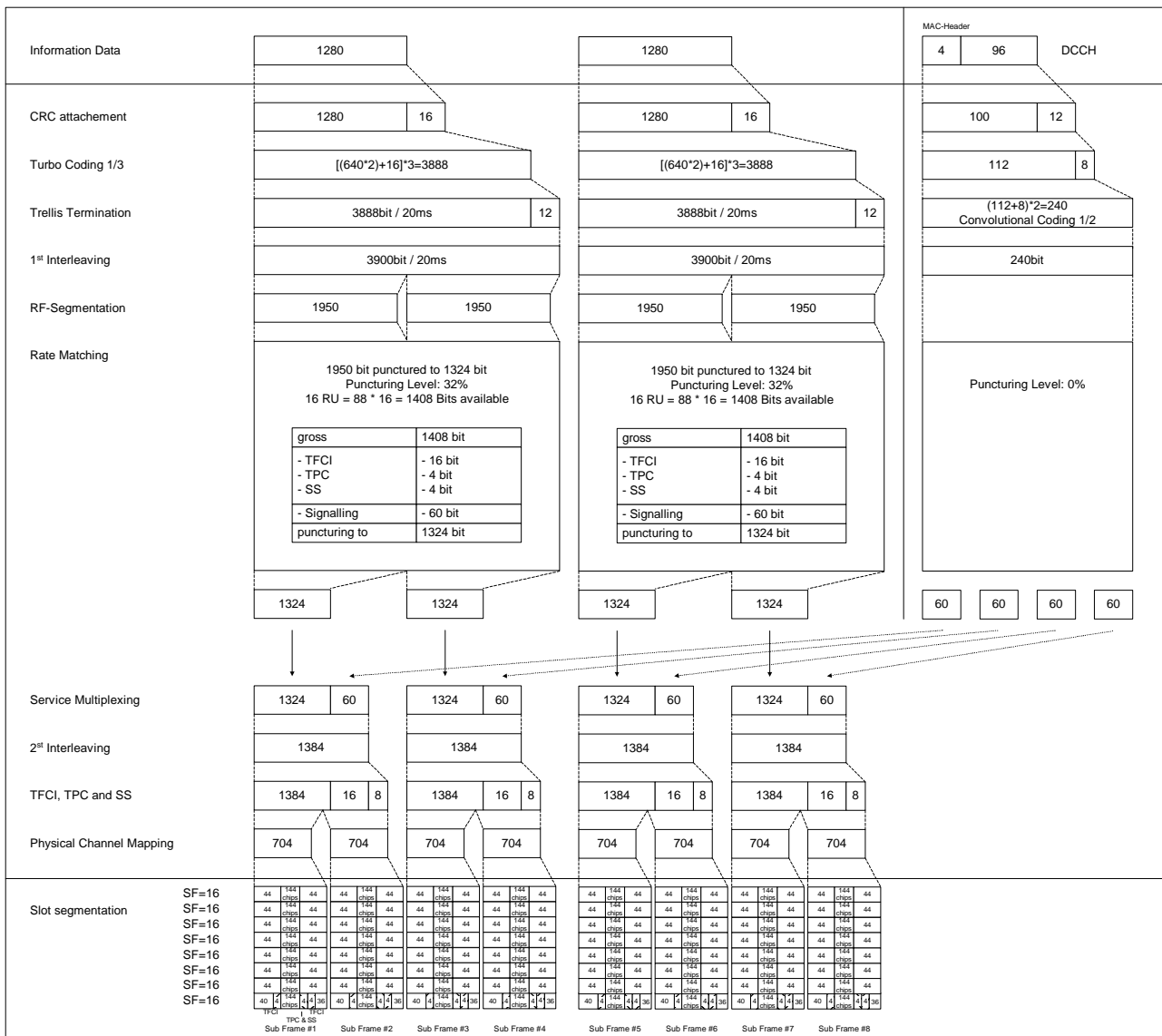

### C.3.2.3 7,68 Mcps TDD Option

Table C.3.2.5: DL reference measurement channel physical parameters (64kbps)

Parameter	Value
Information data rate	64 kbps
RU's allocated	5 codes SF32 = 5RU
Midamble	1024 chips
Interleaving	20 ms
Power control	0 Bit/user
TFCI	16 Bit/user
Inband signalling DCCH	2 kbps
Puncturing level at Code rate : 1/3 DCH of the DTCH / 1/2 DCH of the DCCH	41.1% / 10%

**Table C.3.2.6: DL reference measurement channel using RLC-TM for DTCH, transport channel parameters (64 kbps)**

Higher Layer	RAB/Signalling RB	RAB	SRB
RLC	Logical channel type	DTCH	DCCH
	RLC mode	TM	UM/AM
	Payload sizes, bit	1280	88/80
	Max data rate, bps	64000	2200/2000
	PDU header, bit	N/A	8/16
	TrD PDU header, bit	0	N/A
MAC	MAC header, bit	0	4
	MAC multiplexing	N/A	Yes
Layer 1	TrCH type	DCH	DCH
	Transport Channel Identity	6	10
	TB sizes, bit	1280	100
	TFS	TF0, bits	0*1280
		TF1, bits	1*1280
	TTI, ms	20	40
	Coding type	Turbo Coding	Convolution Coding
	Coding Rate	1/3	1/2
	CRC, bit	16	12
	Max number of bits/TTI after channel coding	3900	240
	Downlink: Max number of bits/radio frame before rate matching	1950	60
	RM attribute	160	240

**Table C.3.2.7: DL reference measurement channel, TFCS (64 kbps)**

TFCS size	4
TFCS	(DTCH, DCCH)= (TF0, TF0), (TF1, TF0), (TF0, TF1), (TF1, TF1)

**Table C.3.2.8: DL reference measurement channel, puncturing limit (64 kbps)**

DPCH Downlink	Puncturing limit	0.56
---------------	------------------	------

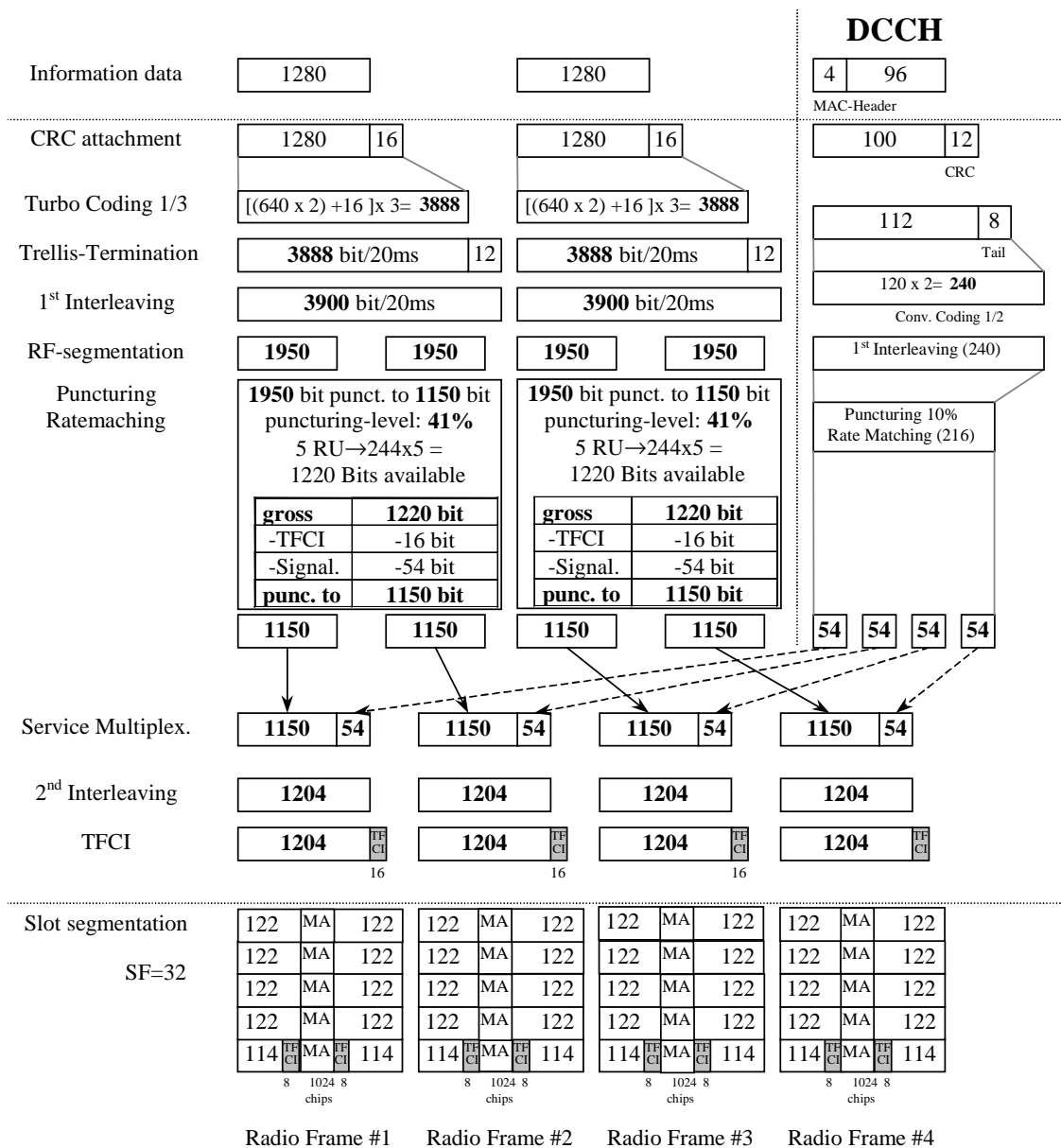

### C.3.3 DL reference measurement channel (144 kbps)

#### C.3.3.1 3,84 Mcps TDD Option

Table C.3.1: DL reference measurement channel physical parameters (144kbps)

Parameter	
Information data rate	144 kbps
RU's allocated	9 codes SF16 = 9RU
Midamble	256 chips
Interleaving	20 ms
Power control	0 Bit/user
TFCI	16 Bit/user
Inband signalling DCCH	2 kbps
Puncturing level at Code rate: 1/3 DCH of the DTCH / 1/2 DCH of the DCCH	44.5% / 16.6%

**Table C.3.3.2: DL reference measurement channel using RLC-TM for DTCH, transport channel parameters (144 kbps)**

Higher Layer	RAB/Signalling RB	RAB	SRB
RLC	Logical channel type	DTCH	DCCH
	RLC mode	TM	UM/AM
	Payload sizes, bit	2880	88/80
	Max data rate, bps	144000	2200/2000
	PDU header, bit	N/A	8/16
	TrD PDU header, bit	0	N/A
MAC	MAC header, bit	0	4
	MAC multiplexing	N/A	Yes
Layer 1	TrCH type	DCH	DCH
	Transport Channel Identity	6	10
	TB sizes, bit	2880	100
	TFS	TF0, bits	0*2880
		TF1, bits	1*2880
	TTI, ms	20	40
	Coding type	Turbo Coding	Convolution Coding
	Coding Rate	1/3	1/2
	CRC, bit	16	12
	Max number of bits/TTI after channel coding	8700	240
	Downlink: Max number of bits/radio frame before rate matching	4350	60
	RM attribute	162	240

**Table C.3.3.3: DL reference measurement channel, TFCS (144 kbps)**

TFCS size	4
TFCS	(DTCH, DCCH)= (TF0, TF0), (TF1, TF0), (TF0, TF1), (TF1, TF1)

**Table C.3.3.4: DL reference measurement channel, puncturing limit (144 kbps)**

DPCH Downlink	Puncturing limit	0.52
---------------	------------------	------

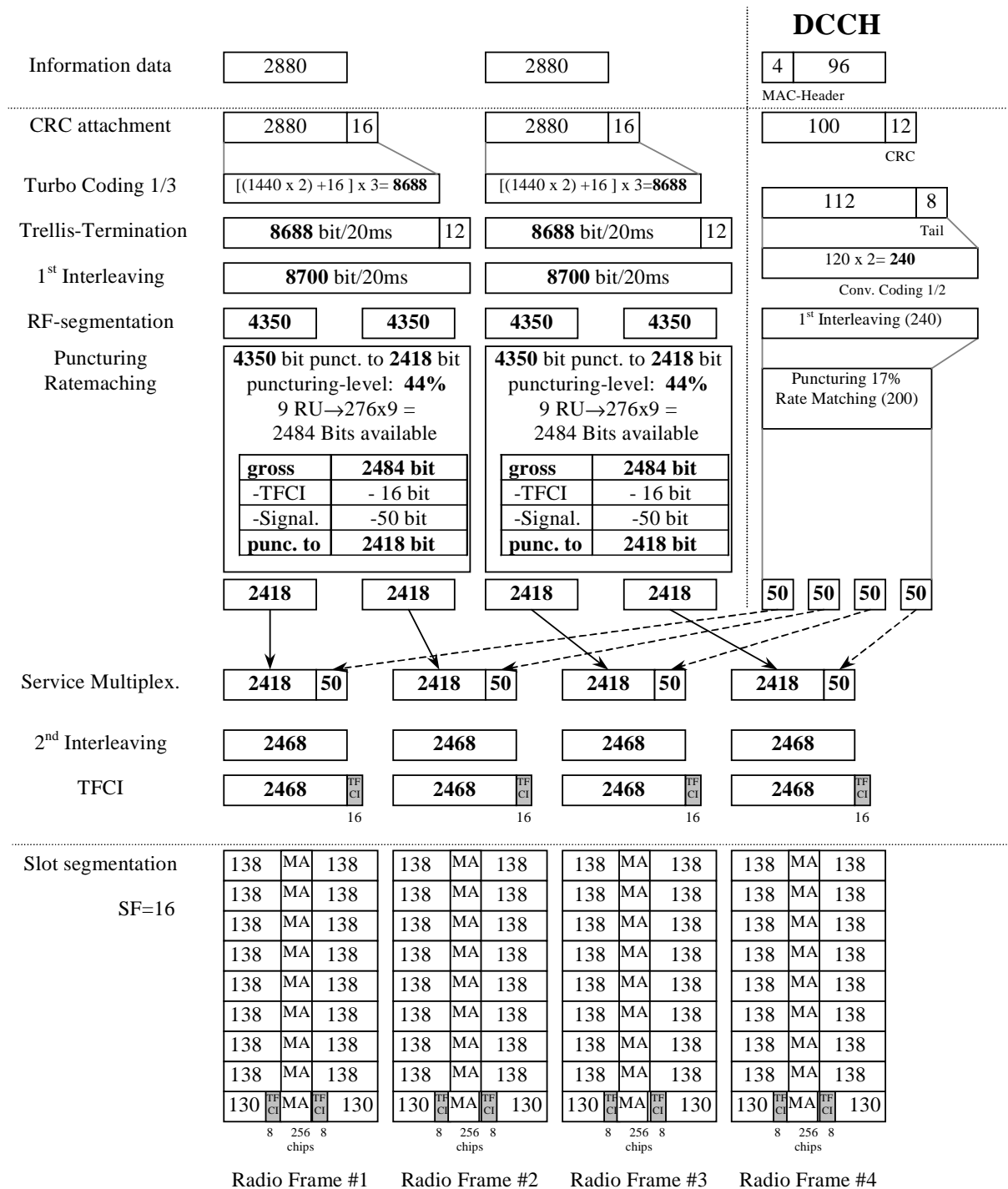



### C.3.3.2 DL reference measurement channel (144 kbps) for 1,28 Mcps TDD Option

Table C.3.3.2

Parameter	Value
Information data rate	144 kbps
RU's allocated	2TS (8*SF16) = 16RU/5ms
Midamble	144
Interleaving	20 ms
Power control (TPC)	8 Bit/user/10ms
TFCI	32 Bit/user/10ms
Synchronisation Shift (SS)	8 Bit/user/10ms
Inband signalling DCCH	2.4 kbps
Puncturing level at Code rate: 1/3 DCH of the DTCH/ 1/2 DCH of the DCCH	38% / 7%

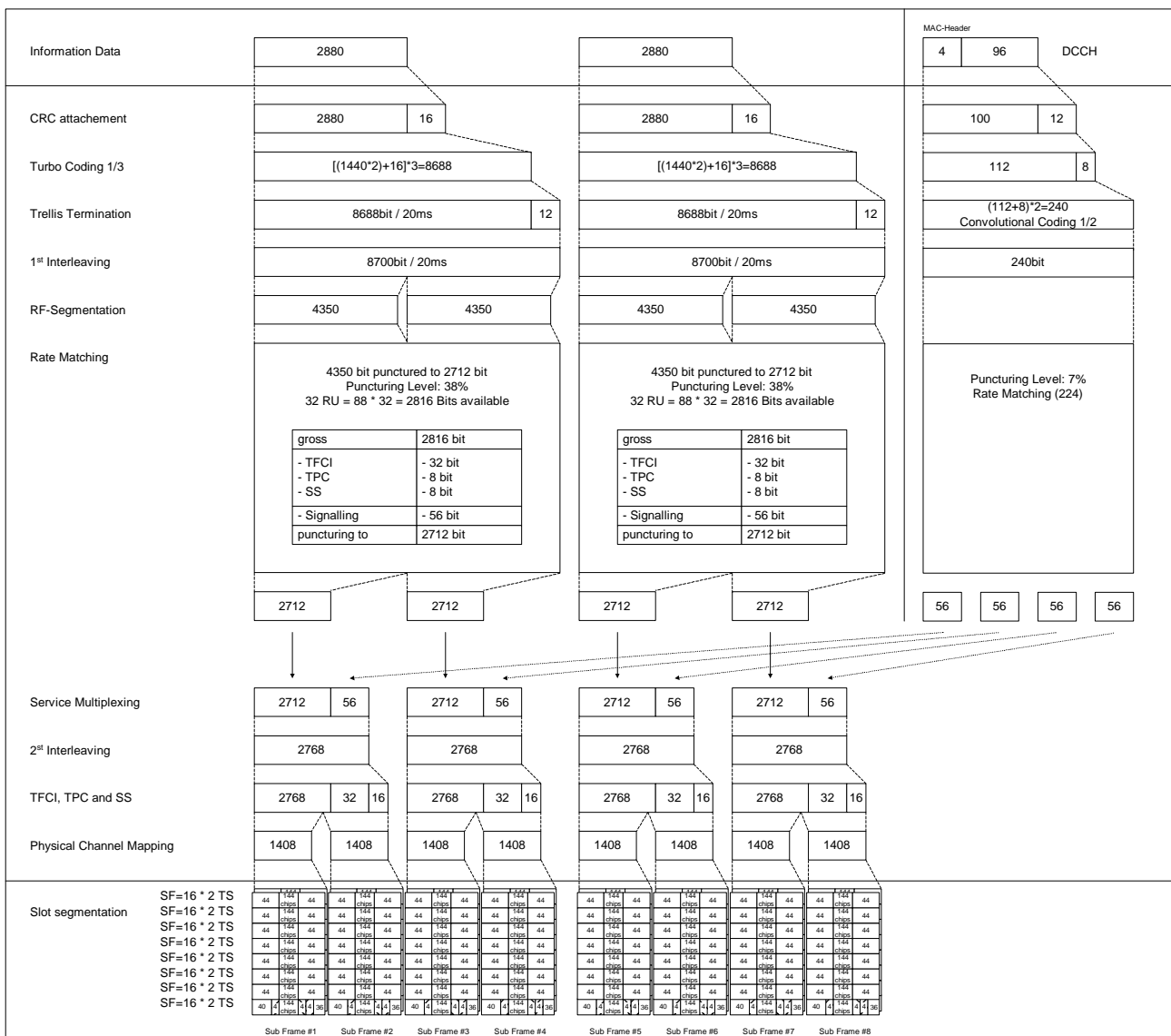

## C.3.3.3 7,68 Mcps TDD Option

Table C.3.3.5: DL reference measurement channel physical parameters (144kbps)

Parameter	Value
Information data rate	144 kbps
RU's allocated	9 codes SF32 = 9RU
Midamble	512 chips
Interleaving	20 ms
Power control	0 Bit/user
TFCI	16 Bit/user
Inband signalling DCCH	2 kbps
Puncturing level at Code rate: 1/3 DCH of the DTCH / ½ DCH of the DCCH	44.5% / 16.6%

Table C.3.3.6: DL reference measurement channel using RLC-TM for DTCH, transport channel parameters (144 kbps)

Higher Layer	RAB/Signalling RB	RAB	SRB	
RLC	Logical channel type	DTCH	DCCH	
	RLC mode	TM	UM/AM	
	Payload sizes, bit	2880	88/80	
	Max data rate, bps	144000	2200/2000	
	PDU header, bit	N/A	8/16	
	TrD PDU header, bit	0	N/A	
MAC	MAC header, bit	0	4	
	MAC multiplexing	N/A	Yes	
Layer 1	TrCH type	DCH	DCH	
	Transport Channel Identity	6	10	
	TB sizes, bit	2880	100	
	TFS	TF0, bits	0*2880	0*100
		TF1, bits	1*2880	1*100
	TTI, ms	20	40	
	Coding type	Turbo Coding	Convolution Coding	
	Coding Rate	1/3	1/2	
	CRC, bit	16	12	
	Max number of bits/TTI after channel coding	8700	240	
Downlink: Max number of bits/radio frame before rate matching	4350	60		
RM attribute	162	240		

Table C.3.3.7: DL reference measurement channel, TFCS (144 kbps)

TFCS size	4
TFCS	(DTCH, DCCH)= (TF0, TF0), (TF1, TF0), (TF0, TF1), (TF1, TF1)

Table C.3.3.8: DL reference measurement channel, puncturing limit (144 kbps)

DPCH Downlink	Puncturing limit	0.52
---------------	------------------	------

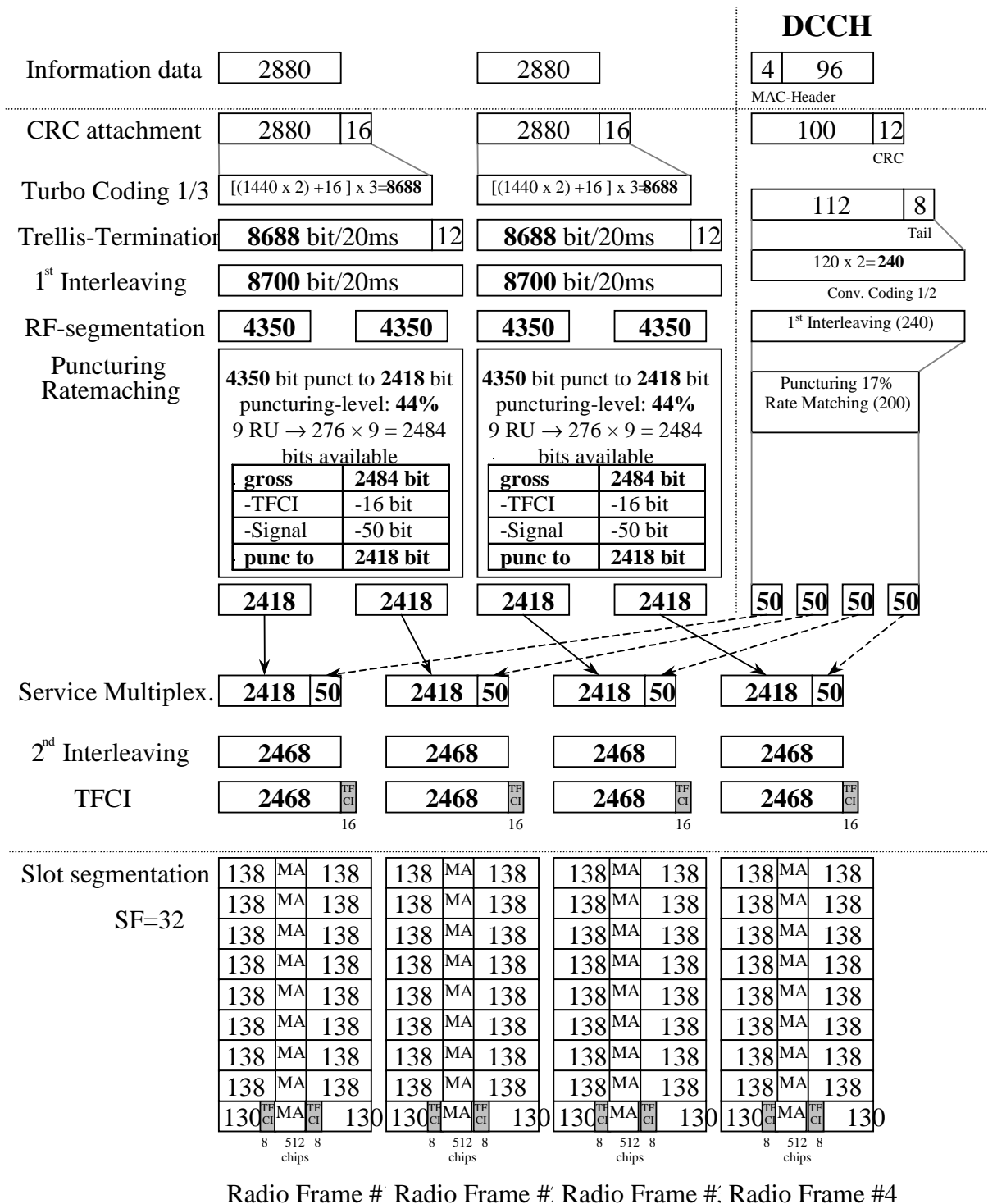

## C.3.4 DL reference measurement channel (384 kbps)

### C.3.4.1 3,84 Mcps TDD Option

**Table C.3.4.1: DL reference measurement channel physical parameters (384kbps)**

Parameter	
Information data rate	384 kbps
RU's allocated	8*3TS = 24RU
Midamble	256 chips
Interleaving	20 ms
Power control	0 Bit/user
TFCI	16 Bit/user
Inband signalling DCCH	2 kbps
Puncturing level at Code rate : 1/3 DCH of the DTCH / 1/2 DCH of the DCCH	43.4% / 15.3%

**Table C.3.4.2: DL reference measurement channel using RLC-TM for DTCH, transport channel parameters (384 kbps)**

Higher Layer	RAB/Signalling RB	RAB	SRB	
RLC	Logical channel type	DTCH	DCCH	
	RLC mode	TM	UM/AM	
	Payload sizes, bit	3840	88/80	
	Max data rate, bps	384000	2200/2000	
	PDU header, bit	N/A	8/16	
	TrD PDU header, bit	0	N/A	
MAC	MAC header, bit	0	4	
	MAC multiplexing	N/A	Yes	
Layer 1	TrCH type	DCH	DCH	
	Transport Channel Identity	1	5	
	TB sizes, bit	3840	100	
	TFS	TF0, bits	0*3840	0*100
		TF1, bits	2*3840	1*100
	TTI, ms	20	40	
	Coding type	Turbo Coding	Convolution Coding	
	Coding Rate	N/A	1/2	
	CRC, bit	16	12	
	Max number of bits/TTI after channel coding	23160	240	
	Uplink: Max number of bits/radio frame before rate matching	11580	60	
	RM attribute	162	240	

**Table C.3.4.3: DL reference measurement channel, TFCS (384 kbps)**

TFCS size	4
TFCS	(DTCH, DCCH)= (TF0, TF0), (TF1, TF0), (TF0, TF1), (TF1, TF1)

**Table C.3.4.4: DL reference measurement channel, puncturing limit (384 kbps)**

DPCH Downlink	Puncturing limit	0.56
---------------	------------------	------

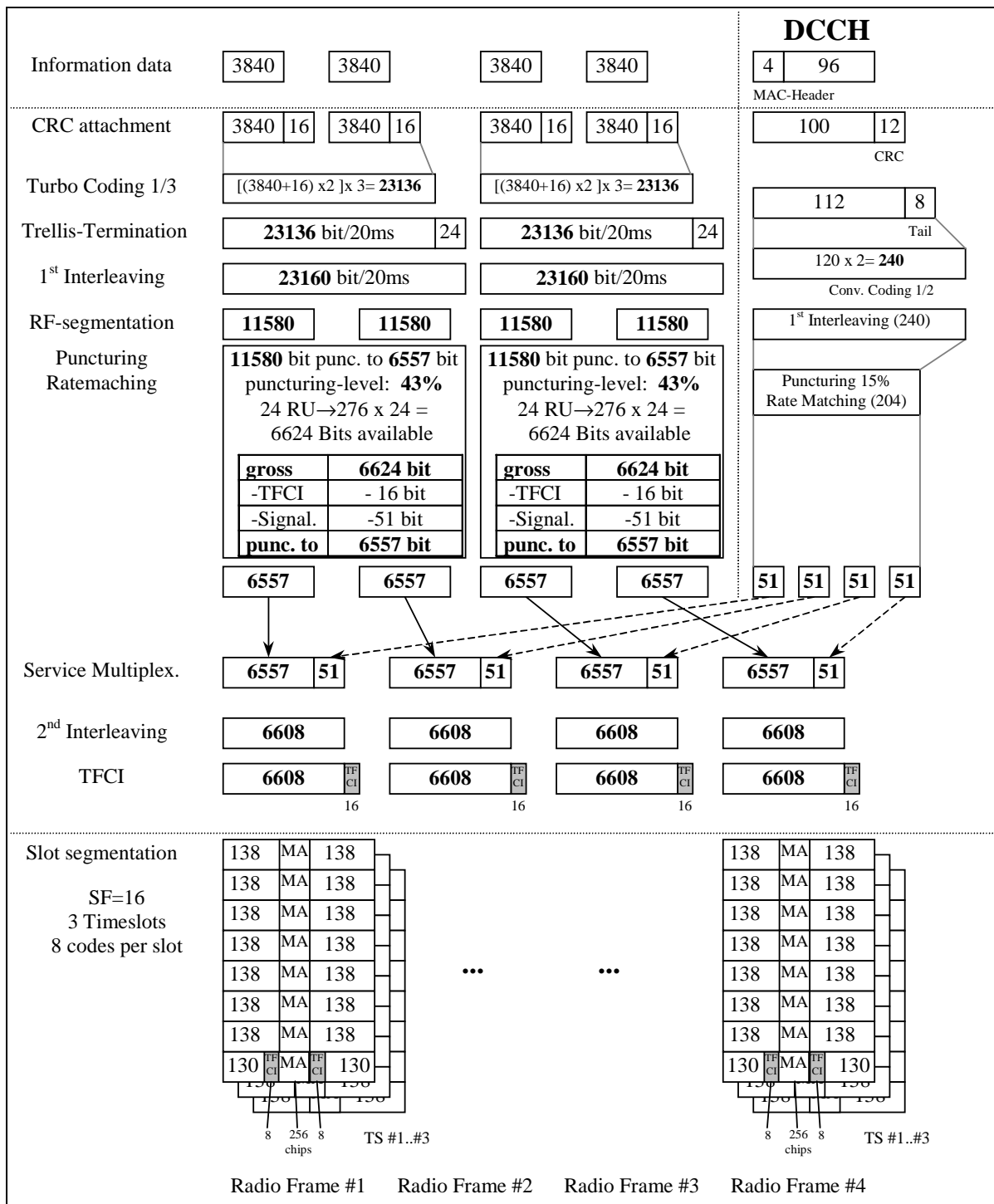

### C.3.4.2 DL reference measurement channel (384 kbps) for 1,28 Mcps TDD Option

Table C.3.4.2

Parameter	Value
Information data rate	384 kbps
RU's allocated	4TS (9*SF16) = 36RU/5ms
Midamble	144
Interleaving	20 ms
Power control (TPC)	16 Bit/user/10ms
TFCI	64 Bit/user/10ms
Synchronisation Shift (SS)	16 Bit/user/10ms
Inband signalling DCCH	2.4 kbps
Puncturing level at Code rate: 1/3 DCH of the DTCH/ 1/2 DCH of the DCCH	47% / 12%

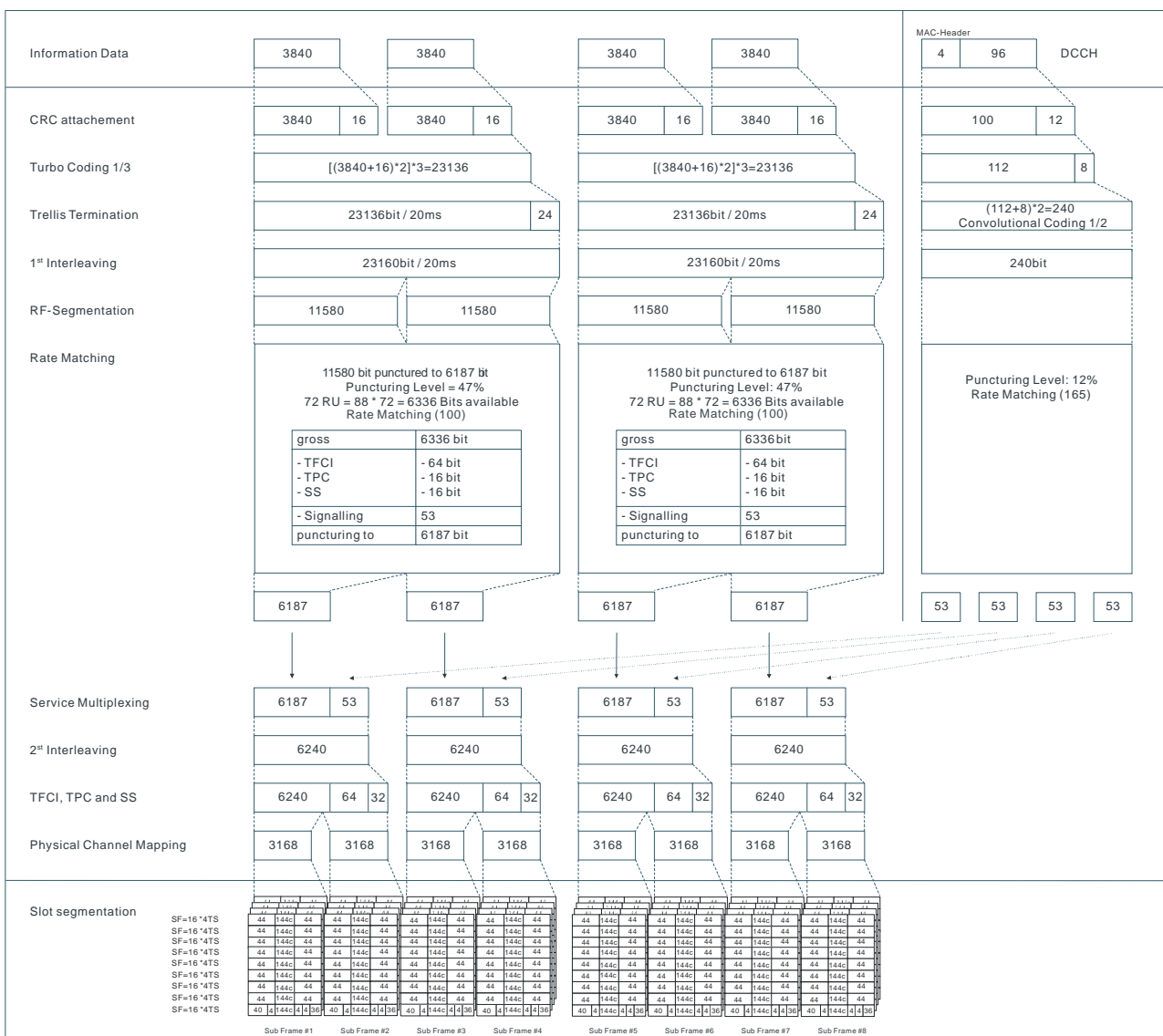

## C.3.4.3 7,68 Mcps TDD Option

Table C.3.4.5: DL reference measurement channel physical parameters (384kbps)

Parameter	Value
Information data rate	384 kbps
RU's allocated	8*3TS = 24RU
Midamble	512 chips
Interleaving	20 ms
Power control	0 Bit/user
TFCI	16 Bit/user
Inband signalling DCCH	2 kbps
Puncturing level at Code rate : 1/3 DCH of the DTCH / 1/2 DCH of the DCCH	43.4% / 15.3%

Table C.3.4.6: DL reference measurement channel using RLC-TM for DTCH, transport channel parameters (384 kbps)

Higher Layer	RAB/Signalling RB	RAB	SRB	
RLC	Logical channel type	DTCH	DCCH	
	RLC mode	TM	UM/AM	
	Payload sizes, bit	3840	88/80	
	Max data rate, bps	384000	2200/2000	
	PDU header, bit	N/A	8/16	
	TrD PDU header, bit	0	N/A	
MAC	MAC header, bit	0	4	
	MAC multiplexing	N/A	Yes	
Layer 1	TrCH type	DCH	DCH	
	Transport Channel Identity	1	5	
	TB sizes, bit	3840	100	
	TFS	TF0, bits	0*3840	0*100
		TF1, bits	2*3840	1*100
	TTI, ms	20	40	
	Coding type	Turbo Coding	Convolution Coding	
	Coding Rate	N/A	1/2	
	CRC, bit	16	12	
	Max number of bits/TTI after channel coding	23160	240	
	Uplink: Max number of bits/radio frame before rate matching	11580	60	
	RM attribute	162	240	

Table C.3.4.7: DL reference measurement channel, TFCS (384 kbps)

TFCS size	4
TFCS	(DTCH, DCCH)= (TF0, TF0), (TF1, TF0), (TF0, TF1), (TF1, TF1)

Table C.3.4.8: DL reference measurement channel, puncturing limit (384 kbps)

DPCH Downlink	Puncturing limit	0.56
---------------	------------------	------

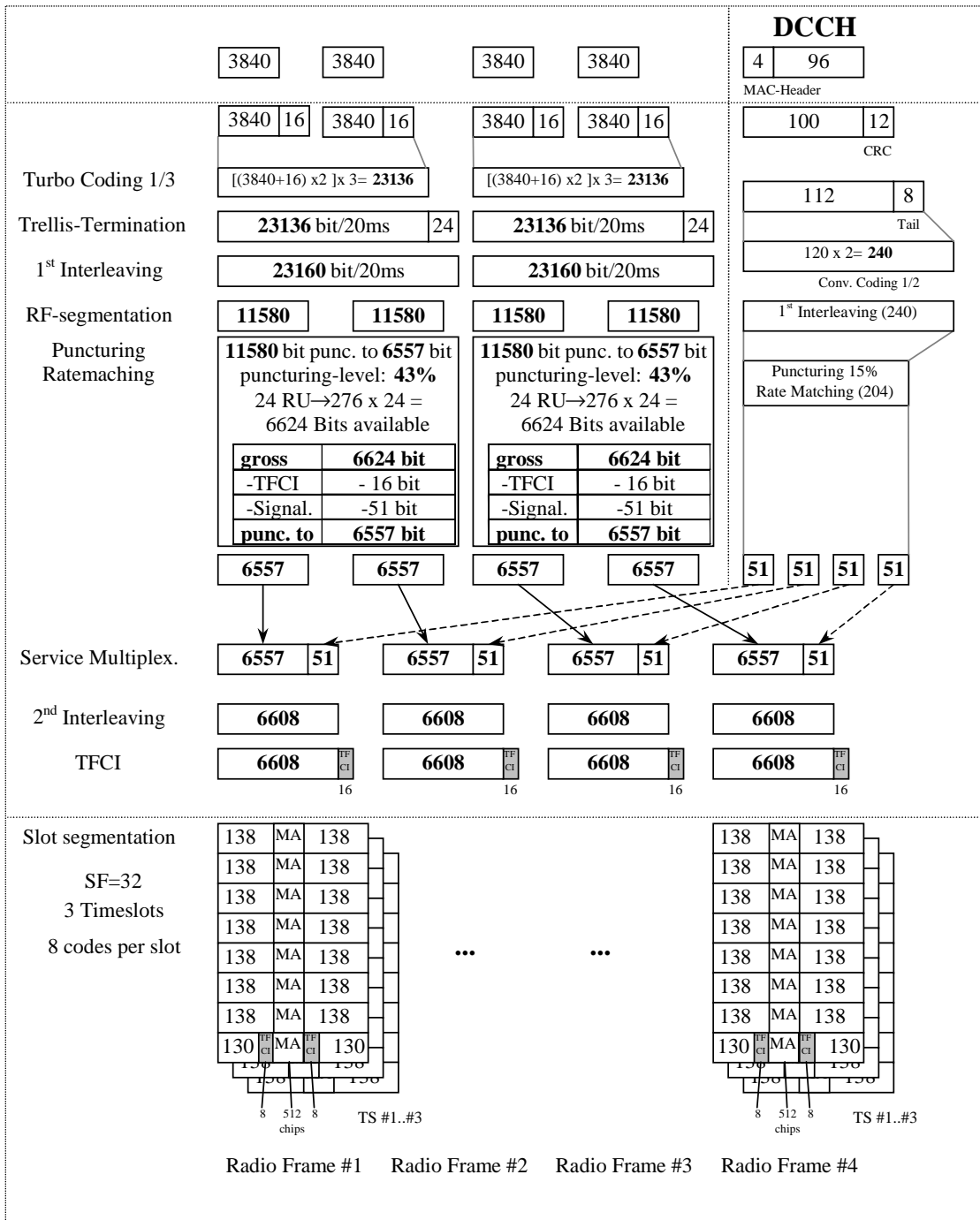



### C.3.5 BCH reference measurement channel

#### C.3.5.1 3,84 Mcps TDD Option

[mapped to 1 code SF16]

Parameter	
Information data rate:	12.3 kbps
RU's allocated	1 RU
Midamble	<b>512</b> chips
Interleaving	20 ms
Power control	0 bit
TFCI	0 bit
Puncturing level	10%

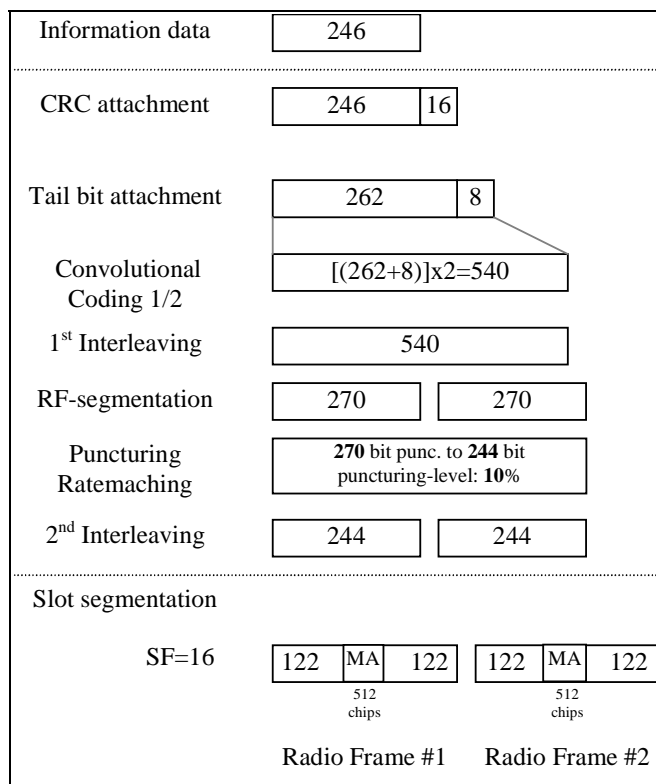

#### C.3.5.2 BCH reference measurement channel (12.3 kbps) for 1,28 Mcps TDD Option

Table C.3.5.2

Parameter	Value
Information data rate:	12.3 kbps
RU's allocated	2 RU
Midamble	144 chips
Interleaving	20 ms
Power control	0 bit
TFCI	0 bit
Puncturing level	13%

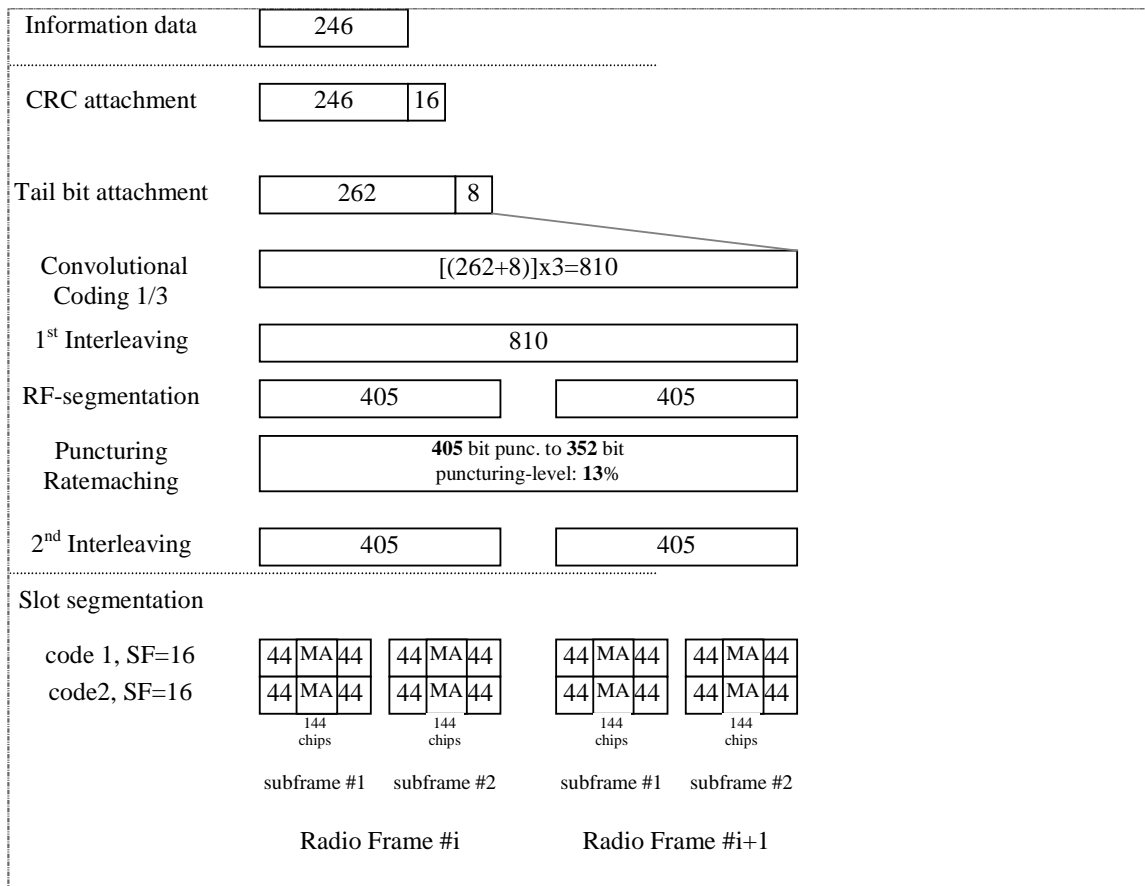

### C.3.5.3 7,68 Mcps TDD Option

Table C.3.5.3

Parameter	Value
Information data rate:	12.3 kbps
RU's allocated	1 RU
Midamble	1024 chips
Interleaving	20 ms
Power control	0 bit
TFCI	0 bit
Puncturing level	10%

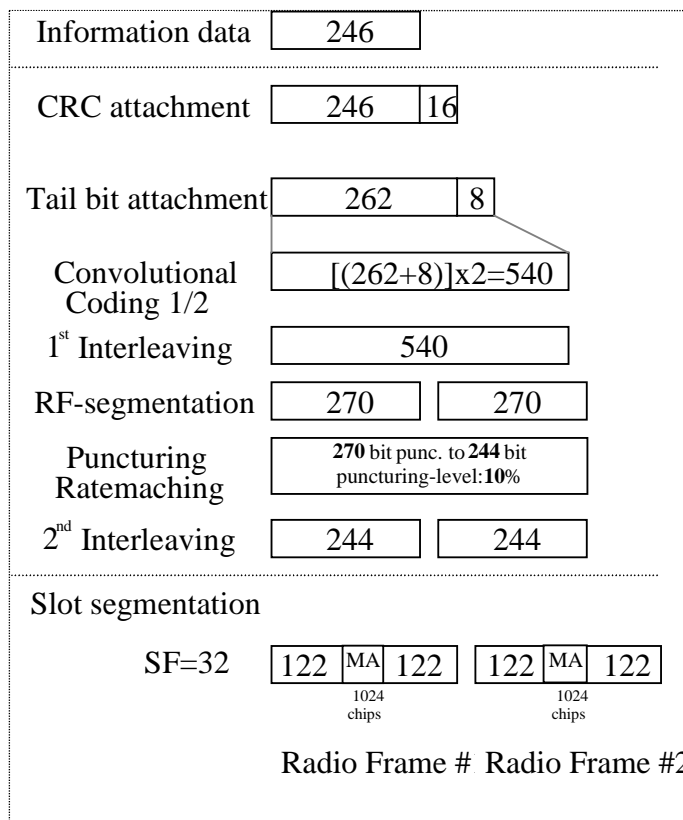

### C.3.6 DL reference measurement channel (2 Mbps) for 3,84 Mcps TDD Option

Table C.3.6.1: DL reference measurement channel physical parameters (2 Mbps)

Parameter	Value
Information data rate	2048 kbps
RU's allocated	16*12TS = 192RU
Midamble	256 chips
Interleaving	10 ms
Power control	0 Bit/user
TFCI	16 Bit/user
Inband signalling DCCH	2 kbps
Puncturing level at Code rate 1/3 : DCH of the DTCH/ DCH of the DCCH	13.9% / 0%

**Table C.3.6.2: DL reference measurement channel using RLC-TM for DTCH, transport channel parameters (2 Mbps)**

Higher Layer	RAB/Signalling RB	RAB	SRB	
RLC	Logical channel type	DTCH	DCCH	
	RLC mode	TM	UM/AM	
	Payload sizes, bit	4076	88/80	
	Max data rate, bps	2038000	2200/2000	
	PDU header, bit	N/A	8/16	
	TrD PDU header, bit	0	N/A	
MAC	MAC header, bit	0	4	
	MAC multiplexing	N/A	Yes	
Layer 1	TrCH type	DCH	DCH	
	Transport Channel Identity	1	5	
	TB sizes, bit	4076	100	
	TFS	TF0, bits	0*4076	0*100
		TF1, bits	5*4076	1*100
	TTI, ms	10	40	
	Coding type	Turbo Coding	Convolution Coding	
	Coding Rate	N/A	1/3	
	CRC, bit	16	12	
	Max number of bits/TTI after channel coding	61440	360	
	Uplink: Max number of bits/radio frame before rate matching	61440	90	
RM attribute	207	240		

**Table C.3.6.3: DL reference measurement channel, TFCS (2 Mbps)**

TFCS size	4
TFCS	(DTCH, DCCH)= (TF0, TF0), (TF1, TF0), (TF0, TF1), (TF1, TF1)

**Table C.3.6.4: DL reference measurement channel, puncturing limit (2 Mbps)**

DPCH Downlink	Puncturing limit	0.84
---------------	------------------	------

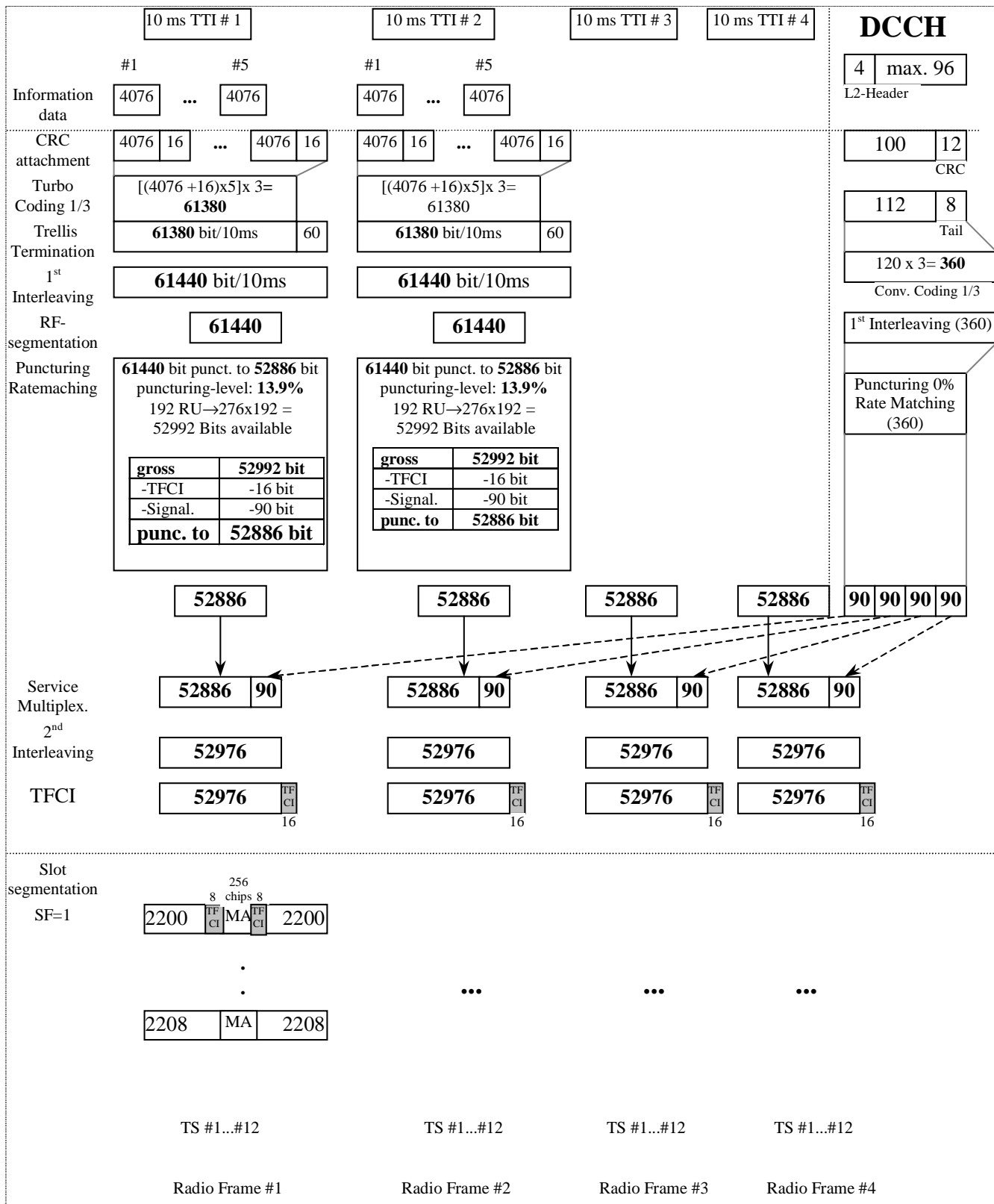

## C.3.7 DL reference measurement channel (2 Mbps) for 7,68 Mcps TDD Option

**Table C.3.7.1: DL reference measurement channel physical parameters (2 Mbps)**

Parameter	Value
Information data rate	2048 kbps
RU's allocated	16*12TS = 192RU
Midamble	512 chips
Interleaving	10 ms
Power control	0 Bit/user
TFCI	16 Bit/user
Inband signalling DCCH	2 kbps
Puncturing level at Code rate 1/3 : DCH of the DTCH / DCH of the DCCH	13.9% / 0%

**Table C.3.7.2: DL reference measurement channel using RLC-TM for DTCH, transport channel parameters (2 Mbps)**

Higher Layer	RAB/Signalling RB	RAB	SRB	
RLC	Logical channel type	DTCH	DCCH	
	RLC mode	TM	UM/AM	
	Payload sizes, bit	4076	88/80	
	Max data rate, bps	2038000	2200/2000	
	PDU header, bit	N/A	8/16	
	TrD PDU header, bit	0	N/A	
MAC	MAC header, bit	0	4	
	MAC multiplexing	N/A	Yes	
Layer 1	TrCH type	DCH	DCH	
	Transport Channel Identity	1	5	
	TB sizes, bit	4076	100	
	TFS	TF0, bits	0*4076	0*100
		TF1, bits	5*4076	1*100
	TTI, ms	10	40	
	Coding type	Turbo Coding	Convolution Coding	
	Coding Rate	N/A	1/3	
	CRC, bit	16	12	
	Max number of bits/TTI after channel coding	61440	360	
	Uplink: Max number of bits/radio frame before rate matching	61440	90	
	RM attribute	207	240	

**Table C.3.7.3: DL reference measurement channel, TFCS (2 Mbps)**

TFCS size	4
TFCS	(DTCH, DCCH)= (TF0, TF0), (TF1, TF0), (TF0, TF1), (TF1, TF1)

**Table C.3.7.4: DL reference measurement channel, puncturing limit (2 Mbps)**

DPCH Downlink	Puncturing limit	0.84
---------------	------------------	------

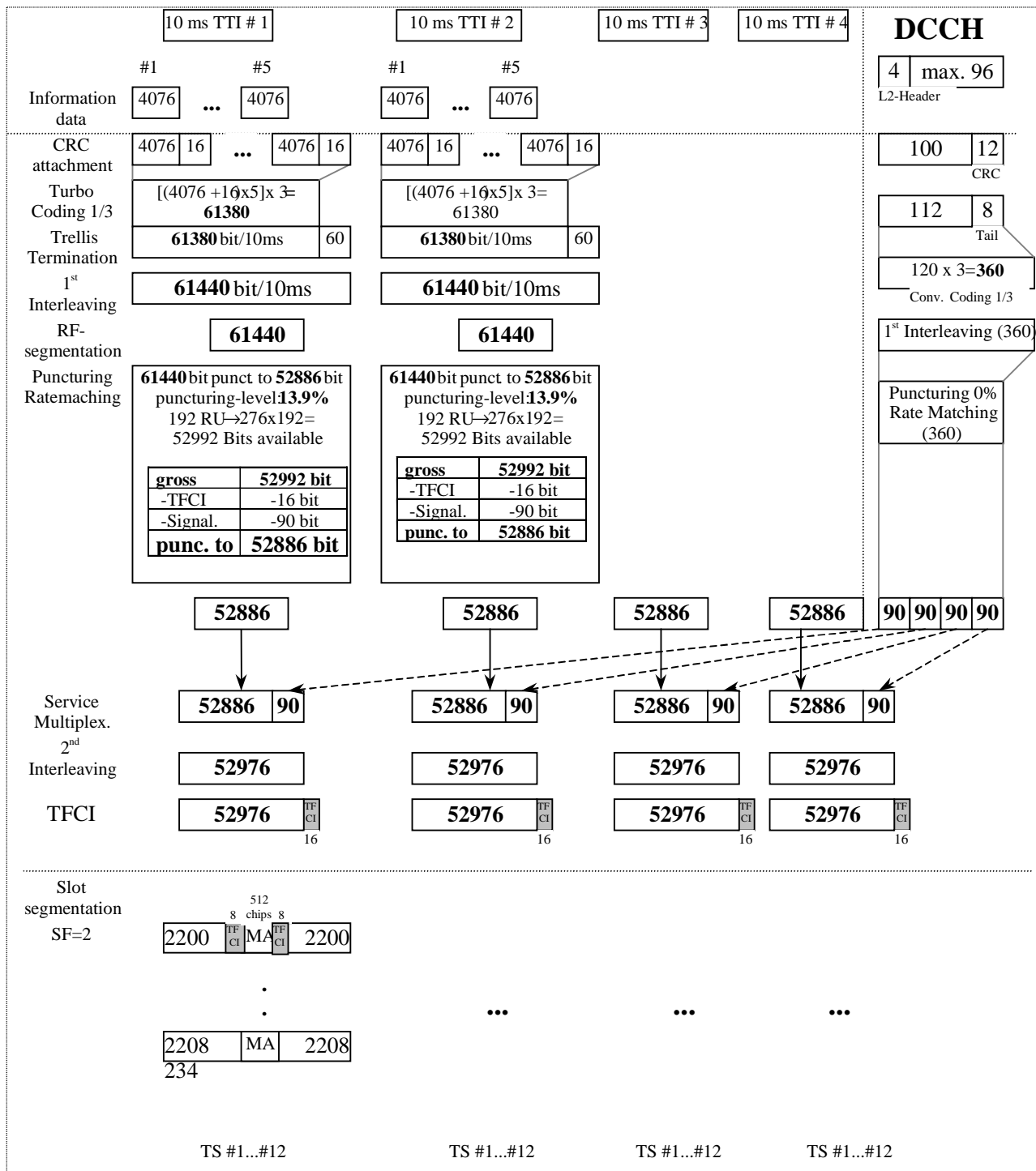

## C.3.8 DL reference measurement channel for MBSFN only UEs (28kbps)

### C.3.8.1 3,84 Mcps TDD IMB Option

**Table C.3.8.1: DL reference measurement channel, physical parameters (28kbps)**

Parameter	Value
Information data rate	28 kbps
DTX position	Flexible
Spreading factor	16
Number of codes	2
Number of data bits/slot	560
Number of data bits/frame	1680
Modulation	QPSK
Slot format #	Format 2 and 3
TFCI	On

**Table C.3.8.2: DL reference measurement channel, transport parameters (28kbps)**

Higher layer	RAB/signalling RB		RAB
	User of Radio Bearer		MBMS
RLC	Logical channel type		MTCH
	RLC mode		UM
	Payload sizes, bit		544
	Max data rate, bps		27200
	UMD PDU header, bit		8
MAC	MAC header, bit		8
	MAC multiplexing		N/A
Layer 1	TrCH type		FACH
	TB sizes, bit		560
	TFS	TF0, bits	0x560
		TF1, bits	1x560
	TTI, ms		20
	Coding type		TC
	CRC, bit		16
	Max number of bits/TTI after channel coding		1740
	Max number of bits/radio frame before rate matching		870
RM attribute		256	

**Table C.3.8.3: DL reference measurement channel, TFCS (28 kbps)**

TFCS size	2
TFCS	TF0, TF1



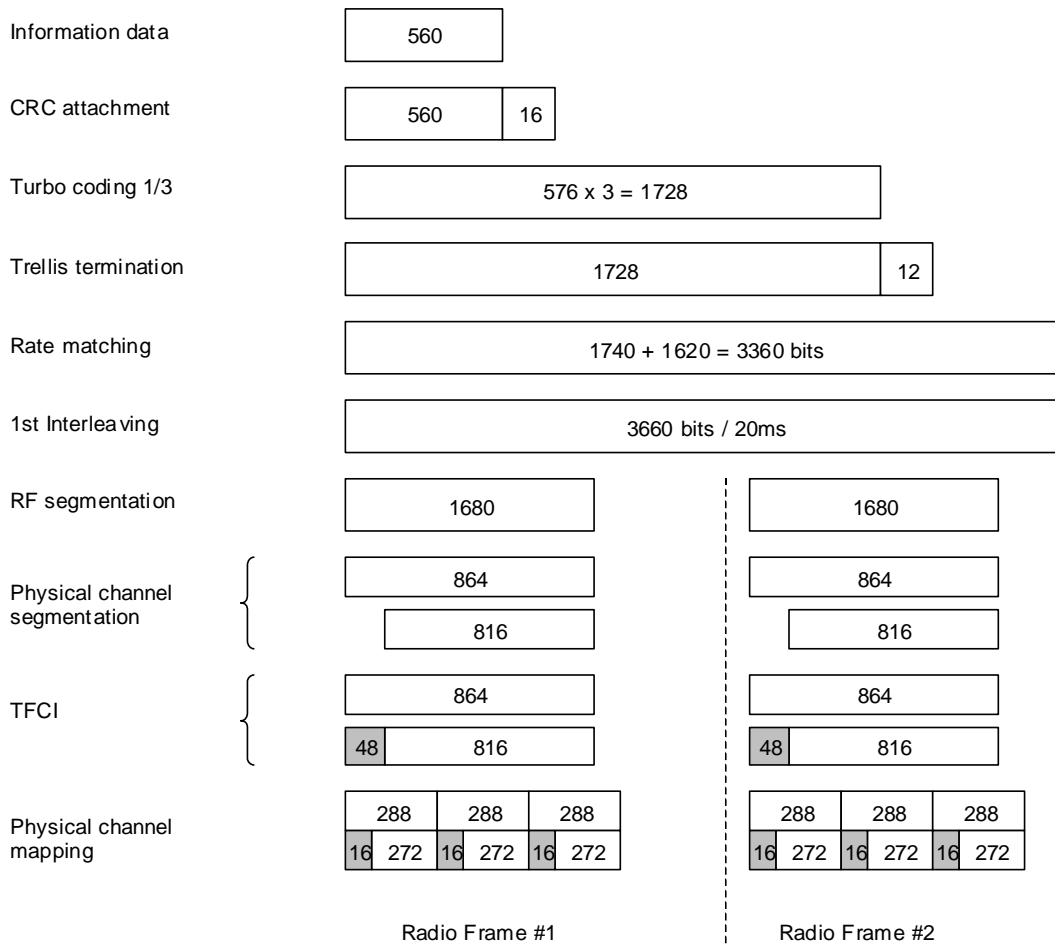

Table C.3.8.4 defines the physical channels that are transmitted simultaneously with the IMB DL reference measurement channel. Table C.3.8.4 is applicable for all measurements on the receiver characteristics (clause 6). OCNS physical channels are applicable only in the case of subclause 6.3.

**Table C.3.8.4: Additional downlink physical channels transmitted simultaneously with the IMB DL reference measurement channel**

Physical Channel	Ec / Ior	Notes
P-CPICH	-10 dB	
T-CPICH	-0.457 dB	
P-CCPCH	-12 dB	
SCH	-12 dB	
OCNS <sup>1</sup>	Necessary power so that total transmit power spectral density of Node B (Ior) adds to one	OCNS consists of 8 physical channels each using SF16 and QPSK modulation. Each OCNS code has equal power.
NOTE <sup>1</sup> : Applicable only in the case of sub-clause 6.3		

## C.4 HSDPA reference measurement channels

### C.4.1 HSDPA reference measurement channels for 3,84 Mcps TDD option

#### C.4.1.1 Reference measurement channels for 7,3 Mbps – Category 8 - UE

##### C.4.1.1.1 QPSK modulation scheme for test 1, 2, 3

**Table C.4.1.1: HS-PDSCH fixed reference channel for the PA3, PB3, and VA30 Channel models - Category 8**

Parameter	Unit	Value
Maximum information bit throughput	Mbps	2,6496
Number of HARQ Processes	Processes	4
Information Bit Payload ( $N_{INF}$ )	Bits	26496
Number Code Blocks	Blocks	6
Total Available of Soft Channel bits in UE	Bits	353280
Number of Soft Channel bit per HARQ Proc.	Bits	88320
Number of coded bits per TTI	Bits	35328
Coding Rate		3/4
Number of HS-PDSCH Timeslots	Slots	8
Number of HS-PDSCH codes per TS	Codes	16
Spreading factor	SF	16

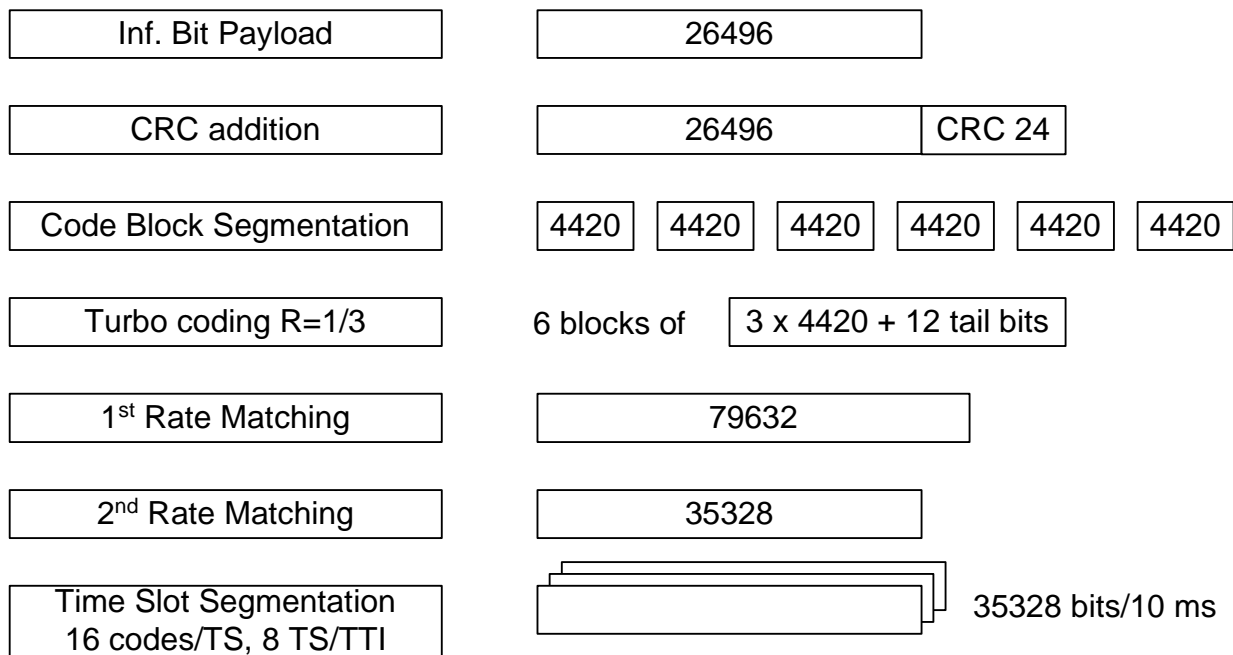

**Figure C.4.1.1: Coding for HS-PDSCH fixed reference channel with QPSK modulation for the PA3, PB3, and VA30 Channels – Category 8**

C.4.1.1.2 QPSK modulation scheme for test 4

Table C.4.1.2: HS-PDSCH fixed reference channel for the VA120 Channel model - Category 8

Parameter	Unit	Value
Maximum information bit throughput	Mbps	2,3176
Number of HARQ Processes	Processes	4
Information Bit Payload ( $N_{INF}$ )	Bits	23176
Number Code Blocks	Blocks	5
Total Available of Soft Channel bits in UE	Bits	353280
Number of Soft Channel bit per HARQ Proc.	Bits	88320
Number of coded bits per TTI	Bits	30912
Coding Rate		3/4
Number of HS-PDSCH Timeslots	Slots	8
Number of HS-PDSCH codes per TS	Codes	14
Spreading factor	SF	16

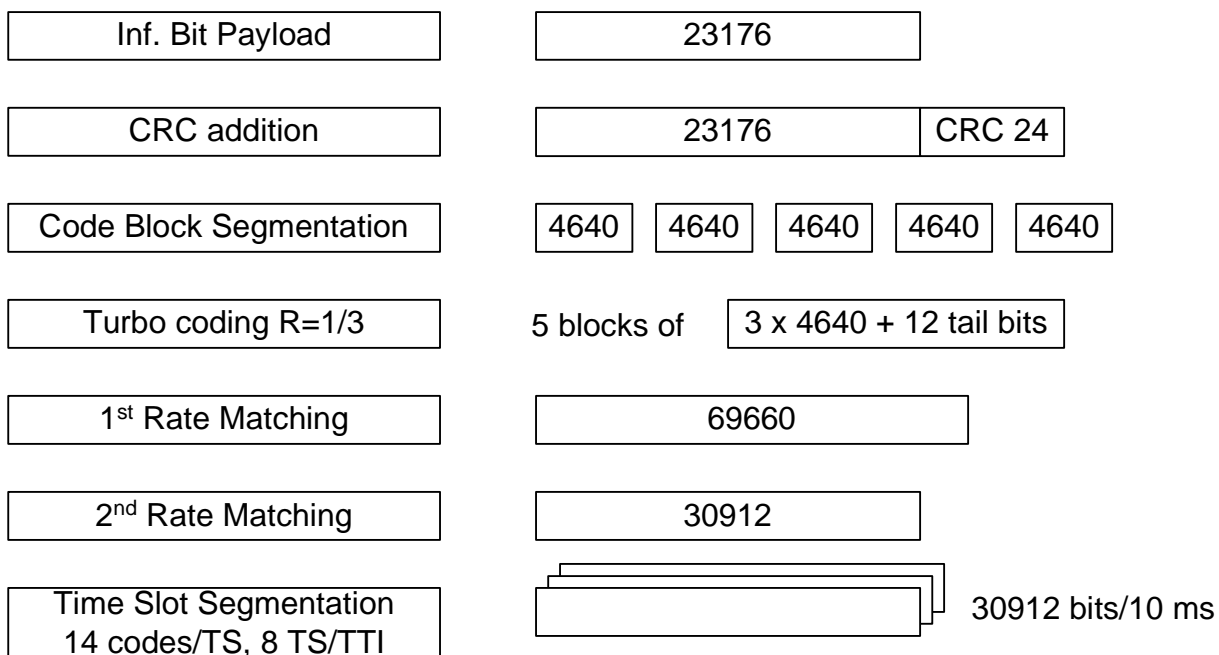
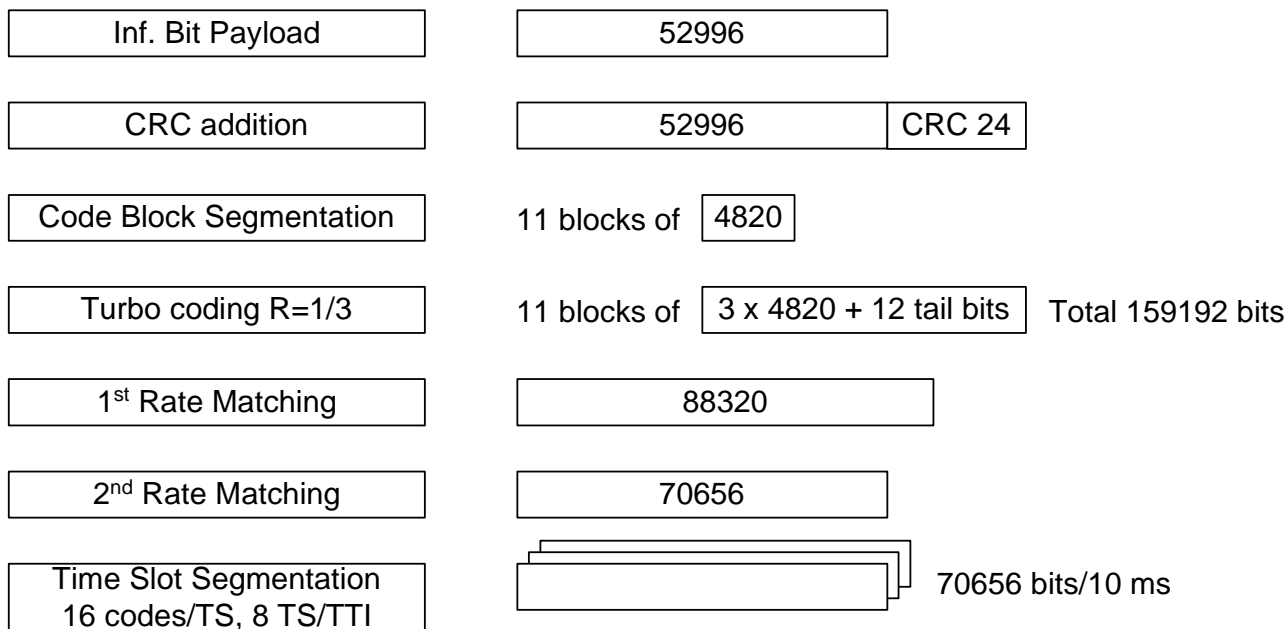

Figure C.4.1.2: Coding for HS-PDSCH fixed reference channel with QPSK modulation for the VA120 Channel – Category 8

C.4.1.1.3 16QAM modulation scheme for test 1, 2, 3

**Table C.4.1.3: HS-PDSCH fixed reference channel for the PA3, PB3, and VA30 Channel models - Category 8**

Parameter	Unit	Value
Modulation		<b>16-QAM</b>
Maximum information bit throughput	Mbps	5,2996
Number of HARQ Processes	Processes	4
Information Bit Payload ( $N_{INF}$ )	Bits	52996
Number Code Blocks	Blocks	11
Total Available of Soft Channel bits in UE	Bits	353280
Number of Soft Channel bit per HARQ Proc.	Bits	88320
Number of coded bits per TTI	Bits	70656
Coding Rate		3/4
Number of HS-PDSCH Timeslots	Slots	8
Number of HS-PDSCH codes per TS	Codes	16
Spreading factor	SF	16

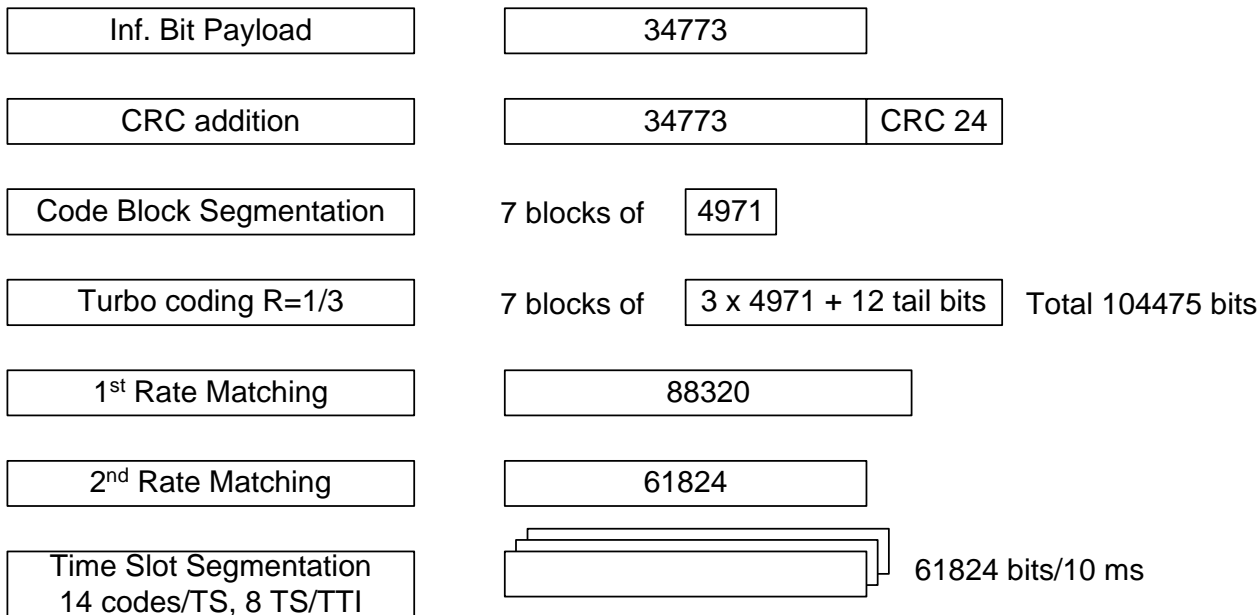

**Figure C.4.1.3: Coding for HS-PDSCH fixed reference channel with 16-QAM modulation for the PA3 PB3, and VA30 Channels – Category 8**

C.4.1.1.4 16QAM modulation scheme for test 4

**Table C.4.1.4: HS-PDSCH fixed reference channel for the PA3, PB3, and VA30 Channel models - Category 8**

Parameter	Unit	Value
Modulation		<b>16-QAM</b>
Maximum information bit throughput	Mbps	3,4773
Number of HARQ Processes	Processes	4
Information Bit Payload ( $N_{INF}$ )	Bits	34773
Number Code Blocks	Blocks	7
Total Available of Soft Channel bits in UE	Bits	353280
Number of Soft Channel bit per HARQ Proc.	Bits	88320
Number of coded bits per TTI	Bits	61824
Coding Rate		9/16
Number of HS-PDSCH Timeslots	Slots	8
Number of HS-PDSCH codes per TS	Codes	14
Spreading factor	SF	16



**Figure C.4.1.4: Coding for HS-PDSCH fixed reference channel with 16-QAM modulation for the VA120 Channel – Category 8**

## C.4.2 HSDPA reference measurement channels for 1.28 Mcps TDD option

### C.4.2.1 Reference measurement channels for 0.5Mbps UE class

#### C.4.2.1.1 QPSK modulation scheme

Parameter	Unit	Value
Modulation	-	QPSK
Maximum information bit throughput	Kbps	199.2
Number of HARQ Processes	Processes	4
Information Bit Payload ( $N_{INF}$ )	Bits	996
Number Code Blocks	Blocks	1
Total Available of Soft Channel bits in UE	Bits	11264
Number of Soft Channel bit per HARQ Proc.	Bits	2816
Number of coded bits per TTI	Bits	1760
Coding Rate	-	0.5795
Number of HS-DSCH Timeslots	Slots	2
Number of HS-PDSCH codes per TS	Codes	10
Spreading factor	SF	16

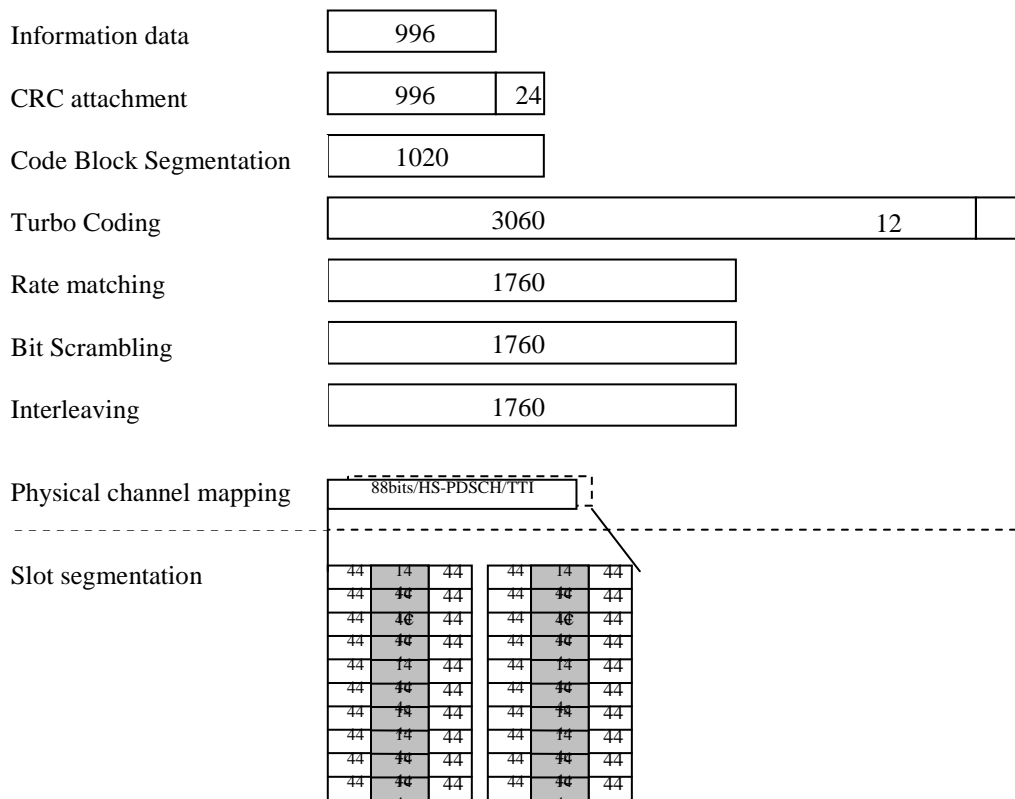

### C.4.2.2 Reference measurement channels for 1.1Mbps UE class

#### C.4.2.2.1 QPSK modulation scheme

Reference channel in C.4.2.1.1 applies.

C.4.2.2.2 16QAM modulation scheme

Parameter	Unit	Value
Modulation	-	16QAM
Maximum information bit throughput	Kbps	578.6
Number of HARQ Processes	Processes	4
Information Bit Payload ( $N_{INF}$ )	Bits	2893
Number Code Blocks	Blocks	1
Total Available of Soft Channel bits in UE	Bits	22528
Number of Soft Channel bit per HARQ Proc.	Bits	5632
Number of coded bits per TTI	Bits	4224
Coding Rate	-	0.69
Number of HS-DSCH Timeslots	Slots	2
Number of HS-PDSCH codes per TS	Codes	12
Spreading factor	SF	16

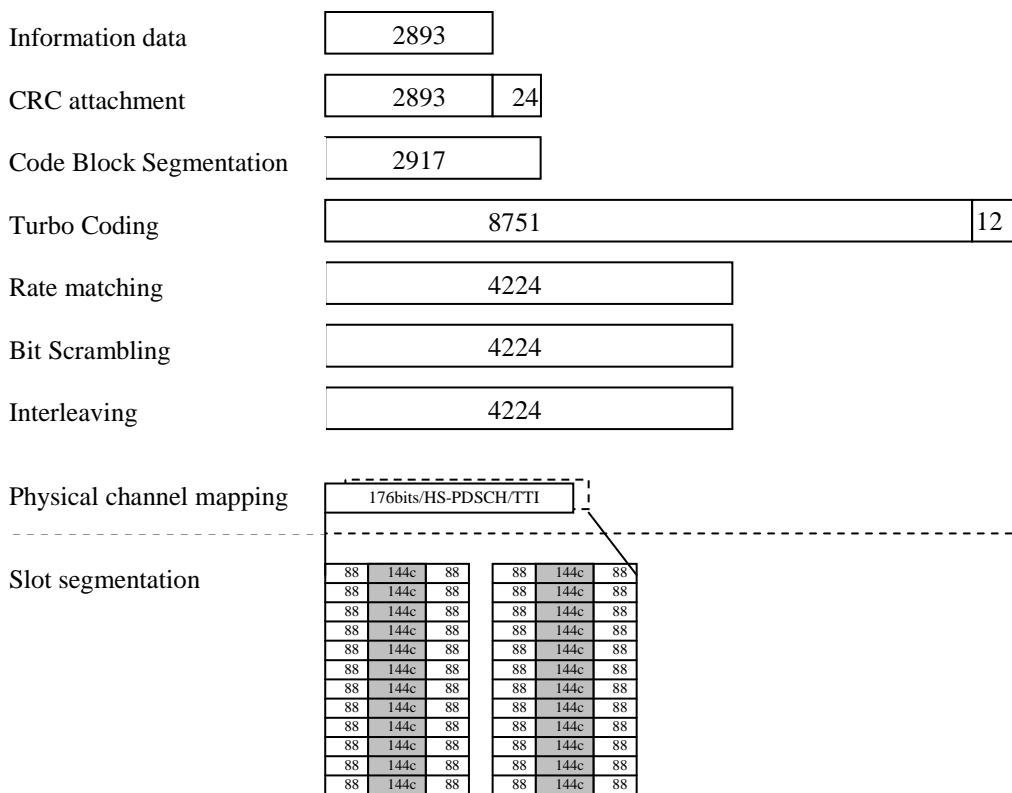

### C.4.2.3 Reference measurement channels for 1.6Mbps UE class

#### C.4.2.3.1 QPSK modulation scheme

Parameter	Unit	Value
Modulation	-	QPSK
Maximum information bit throughput	Kbps	357.4
Number of HARQ Processes	Processes	4
Information Bit Payload ( $N_{INF}$ )	Bits	1787
Number Code Blocks	Blocks	1
Total Available of Soft Channel bits in UE	Bits	33792
Number of Soft Channel bit per HARQ Proc.	Bits	8448
Number of coded bits per TTI	Bits	2640
Coding Rate	-	0.686
Number of HS-DSCH Timeslots	Slots	3
Number of HS-PDSCH codes per TS	Codes	10
Spreading factor	SF	16

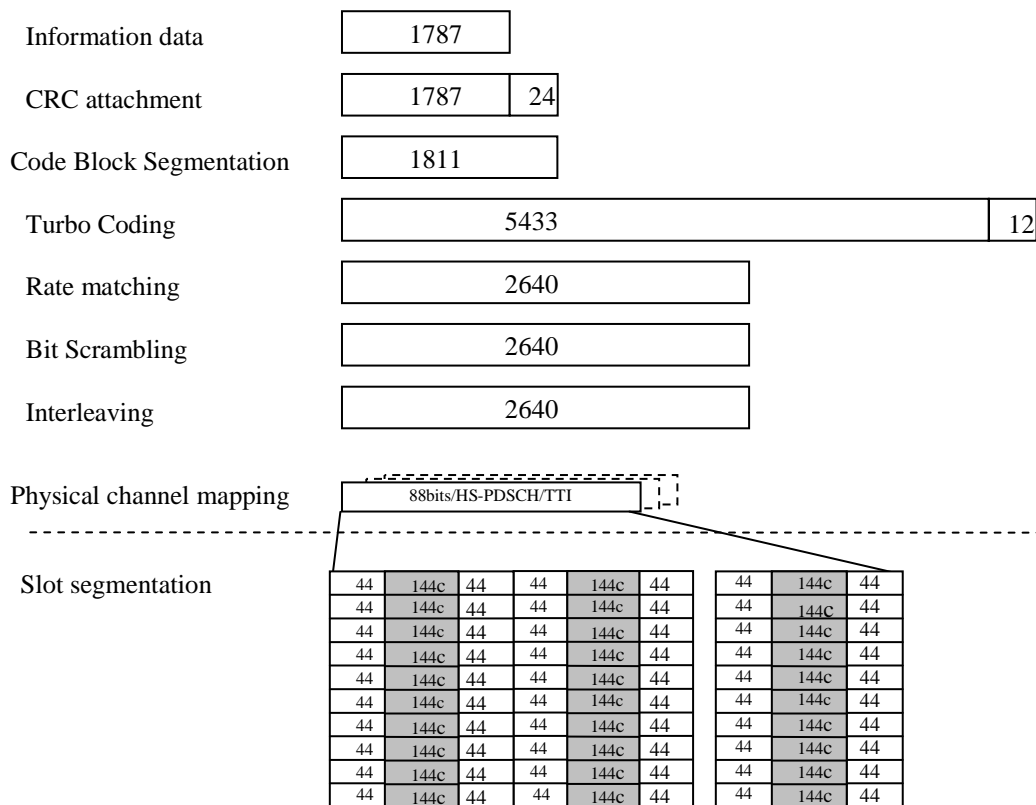



C.4.2.3.2 16QAM modulation scheme

Parameter	Unit	Value
Modulation	-	16QAM
Maximum information bit throughput	Kbps	634.6
Number of HARQ Processes	Processes	4
Information Bit Payload ( $N_{INF}$ )	Bits	3173
Number Code Blocks	Blocks	1
Total Available of Soft Channel bits in UE	Bits	33792
Number of Soft Channel bit per HARQ Proc.	Bits	8448
Number of coded bits per TTI	Bits	6336
Coding Rate	-	0.505
Number of HS-DSCH Timeslots	Slots	3
Number of HS-PDSCH codes per TS	Codes	12
Spreading factor	SF	16

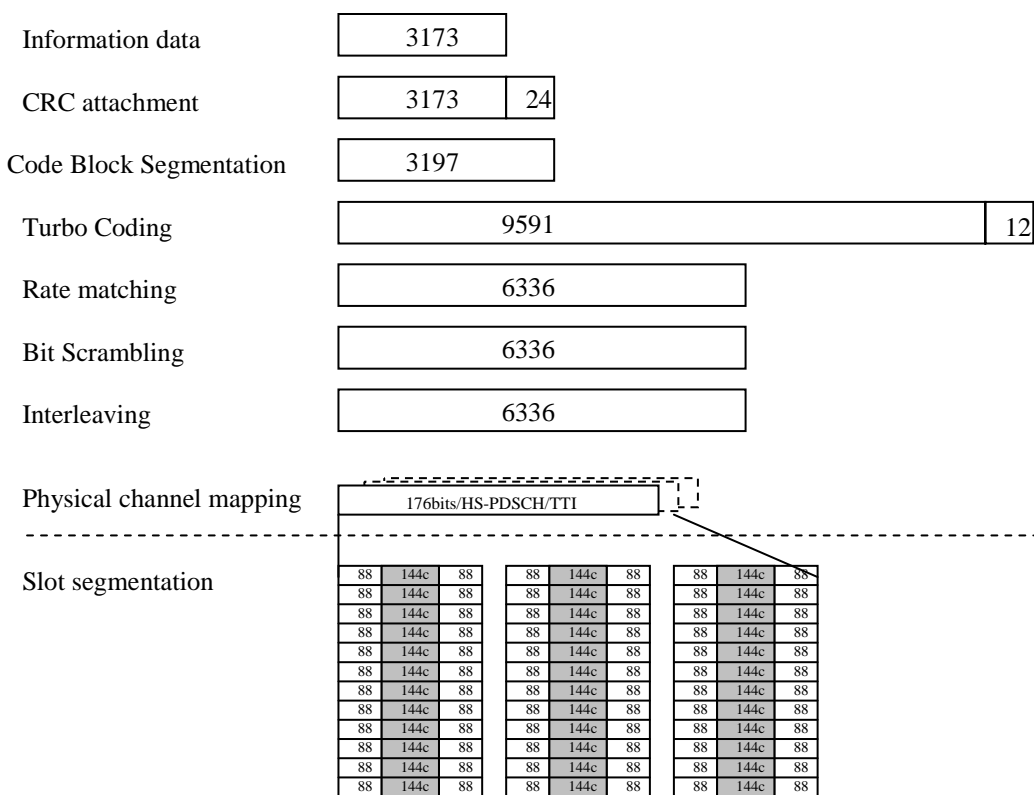

C.4.2.4 Reference measurement channels for 2.2Mbps UE class

C.4.2.4.1 QPSK modulation scheme

Parameter	Unit	Value
Modulation	-	QPSK
Maximum information bit throughput	Kbps	539
Number of HARQ Processes	Processes	4
Information Bit Payload ( $N_{INF}$ )	Bits	2695
Number Code Blocks	Blocks	1
Total Available of Soft Channel bits in UE	Bits	45056

Number of Soft Channel bit per HARQ Proc.	Bits	11264
Number of coded bits per TTI	Bits	3520
Coding Rate	-	0.772
Number of HS-DSCH Timeslots	Slots	4
Number of HS-PDSCH codes per TS	Codes	10
Spreading factor	SF	16

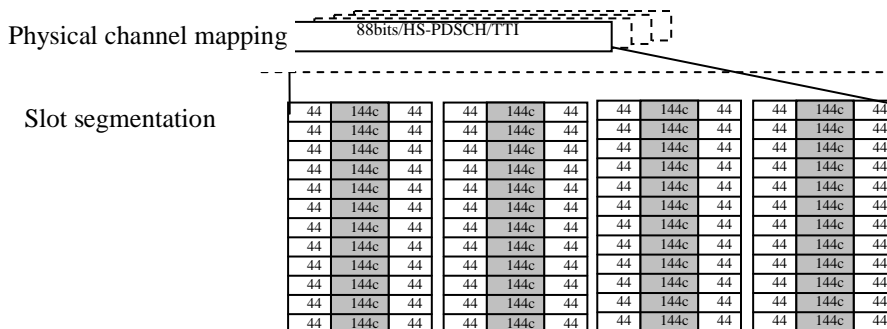
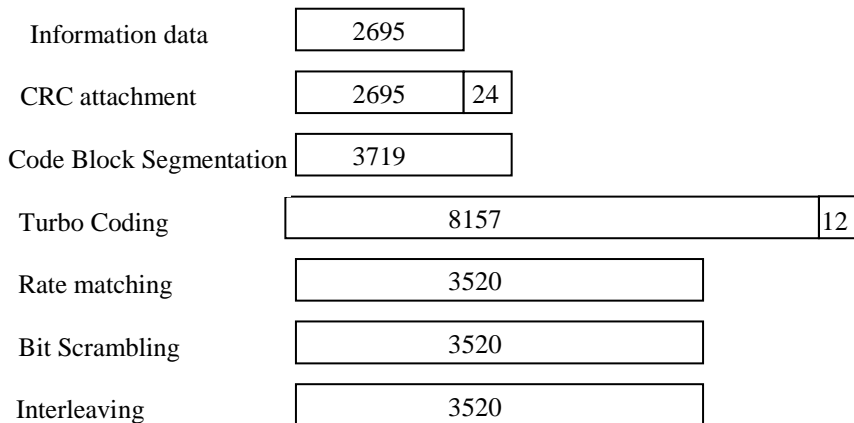

C.4.2.4.2 16QAM modulation scheme

Parameter	Unit	Value
Modulation	-	16QAM
Maximum information bit throughput	Kbps	782.2
Number of HARQ Processes	Processes	4
Information Bit Payload ( $N_{INF}$ )	Bits	3911
Number Code Blocks	Blocks	1
Total Available of Soft Channel bits in UE	Bits	45056
Number of Soft Channel bit per HARQ Proc.	Bits	11264
Number of coded bits per TTI	Bits	8448
Coding Rate	-	0.4658
Number of HS-DSCH Timeslots	Slots	4
Number of HS-PDSCH codes per TS	Codes	12
Spreading factor	SF	16

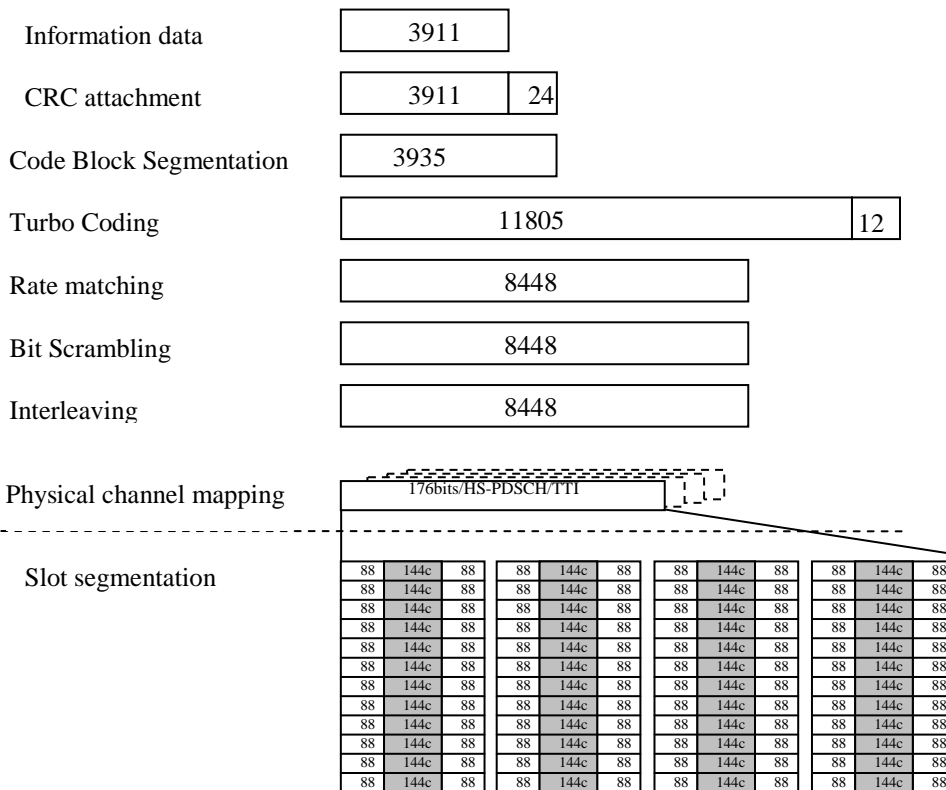

### C.4.2.5 Reference measurement channels for 2.8Mbps UE class

#### C.4.2.5.1 QPSK modulation scheme

Parameter	Unit	Value
Modulation	-	QPSK
Maximum information bit throughput	Kbps	621
Number of HARQ Processes	Processes	4
Information Bit Payload ( $N_{INF}$ )	Bits	3105
Number Code Blocks	Blocks	1
Total Available of Soft Channel bits in UE	Bits	56320
Number of Soft Channel bit per HARQ Proc.	Bits	14080
Number of coded bits per TTI	Bits	4400
Coding Rate	-	0.711
Number of HS-DSCH Timeslots	Slots	5
Number of HS-PDSCH codes per TS	Codes	10
Spreading factor	SF	16

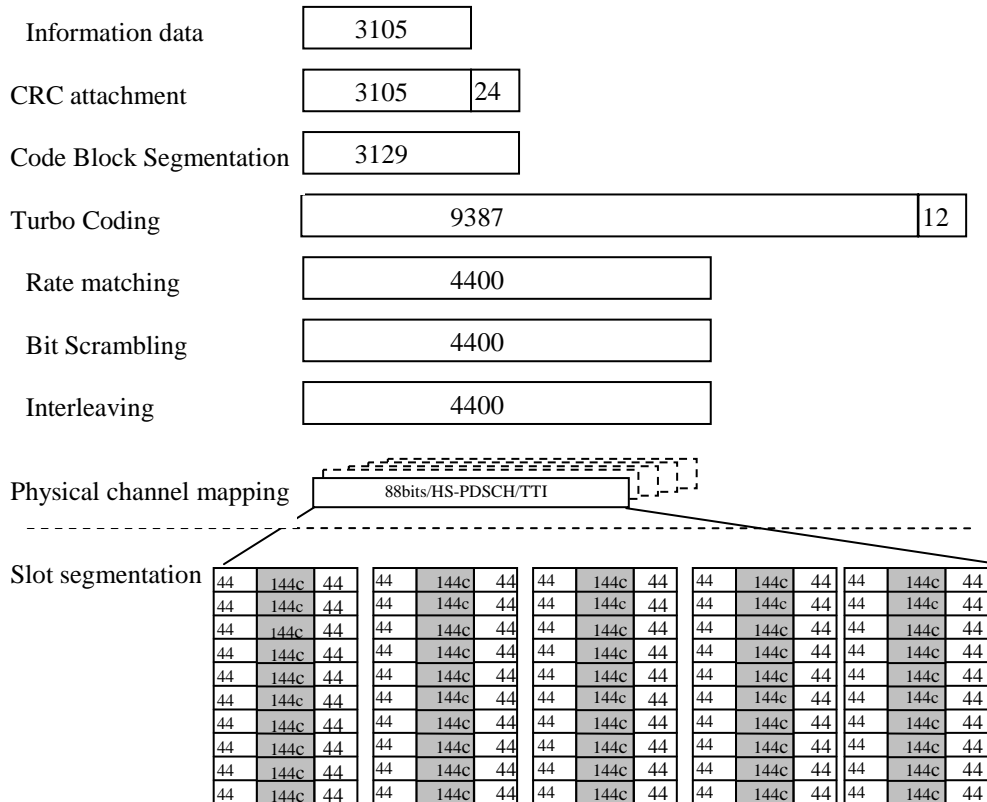

C.4.2.5.2 16QAM modulation scheme

Parameter	Unit	Value
Modulation	-	16QAM
Maximum information bit throughput	Kbps	1278.6
Number of HARQ Processes	Processes	4
Information Bit Payload ( $N_{INF}$ )	Bits	6393
Number Code Blocks	Blocks	1
Total Available of Soft Channel bits in UE	Bits	56320
Number of Soft Channel bit per HARQ Proc.	Bits	14080
Number of coded bits per TTI	Bits	10560
Coding Rate	-	0.6077
Number of HS-DSCH Timeslots	Slots	5
Number of HS-PDSCH codes per TS	Codes	12
Spreading factor	SF	16

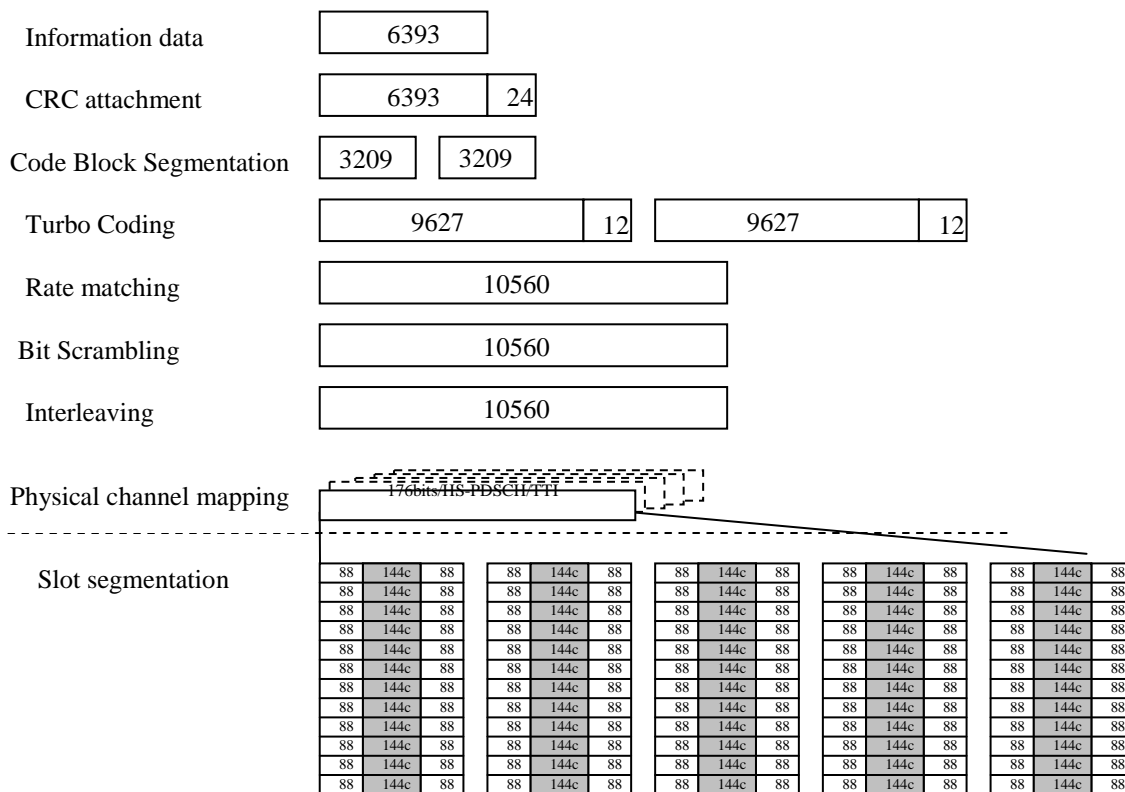

### C.4.2.6 Reference measurement channels for Category 16-24 UE

#### C.4.2.6.1 Reference measurement channel for category 16-18 UE

Parameter	Unit	Value
Modulation	-	64QAM
Maximum information bit throughput	Mbps	1.2496
Number of HARQ Processes	Processes	4
Information Bit Payload ( $N_{INF}$ )	Bits	6248
Number Code Blocks	Blocks	2
Total Available of Soft Channel bits in UE	Bits	50688
Number of Soft Channel bit per HARQ Proc.	Bits	12672
Number of coded bits per TTI	Bits	11088
Coding Rate	-	0.5635
Number of HS-DSCH Timeslots	Slots	3
Number of HS-PDSCH codes per TS	Codes	14
Spreading factor	SF	16

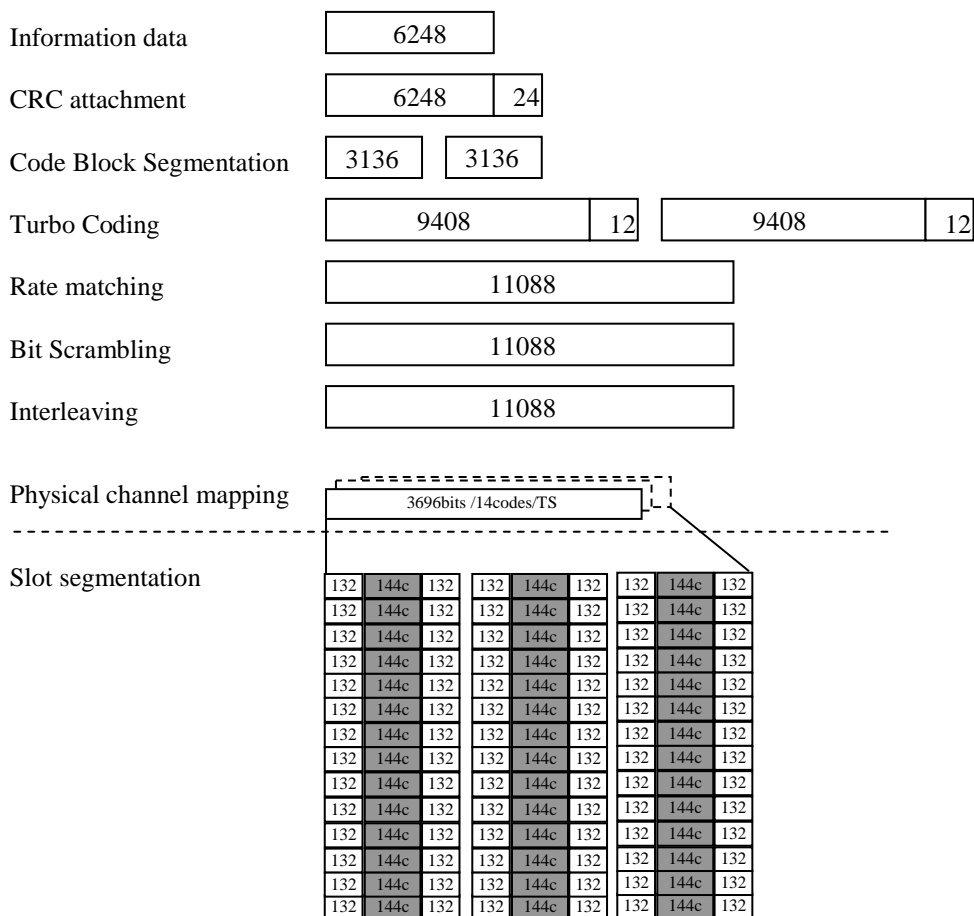

C.4.2.6.2 Reference measurement channel for category 19-21 UE

Parameter	Unit	Value
Modulation	-	<b>64QAM</b>
Maximum information bit throughput	Mbps	1.6976
Number of HARQ Processes	Processes	4
Information Bit Payload ( $N_{INF}$ )	Bits	8488
Number Code Blocks	Blocks	2
Total Available of Soft Channel bits in UE	Bits	67584
Number of Soft Channel bit per HARQ Proc.	Bits	16896
Number of coded bits per TTI	Bits	14784
Coding Rate	-	0.57
Number of HS-DSCH Timeslots	Slots	4
Number of HS-PDSCH codes per TS	Codes	14
Spreading factor	SF	16

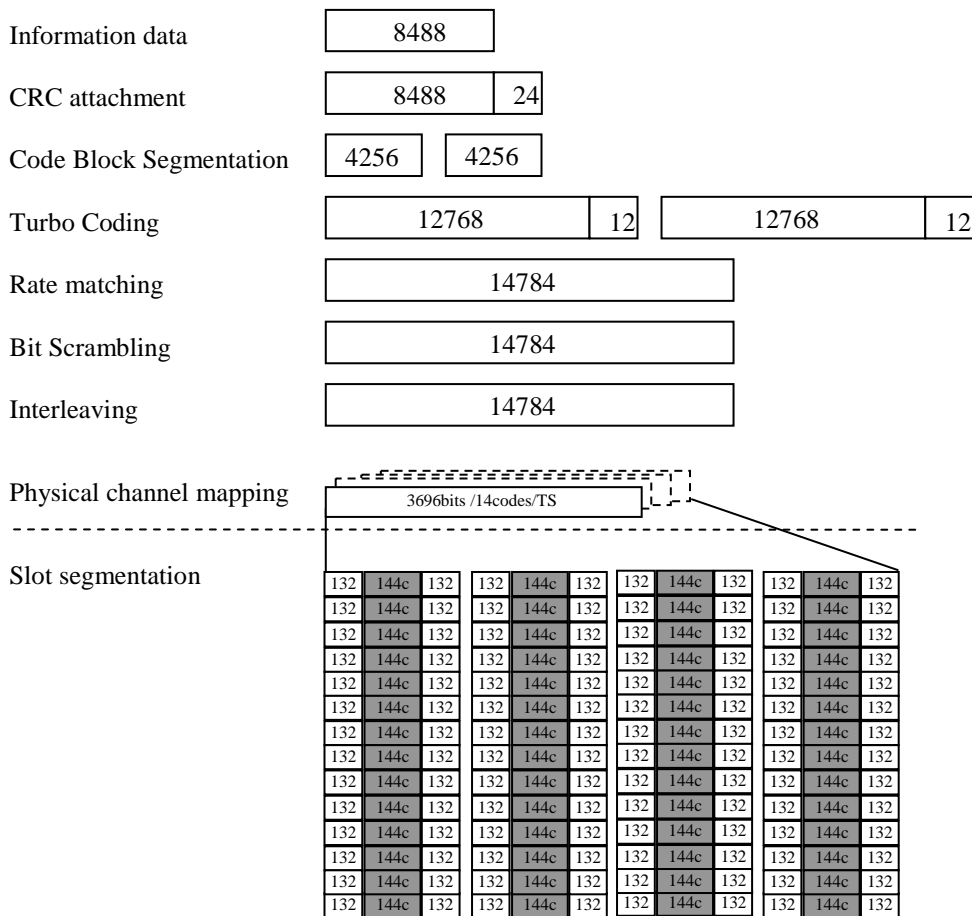

C.4.2.6.3 Reference measurement channel for category 22-24 UE

Parameter	Unit	Value
Modulation	-	<b>64QAM</b>
Maximum information bit throughput	Mbps	2.0464
Number of HARQ Processes	Processes	4
Information Bit Payload ( $N_{INF}$ )	Bits	10232
Number Code Blocks	Blocks	3
Total Available of Soft Channel bits in UE	Bits	84480
Number of Soft Channel bit per HARQ Proc.	Bits	21120
Number of coded bits per TTI	Bits	18480
Coding Rate	-	0.55
Number of HS-DSCH Timeslots	Slots	5
Number of HS-PDSCH codes per TS	Codes	14
Spreading factor	SF	16

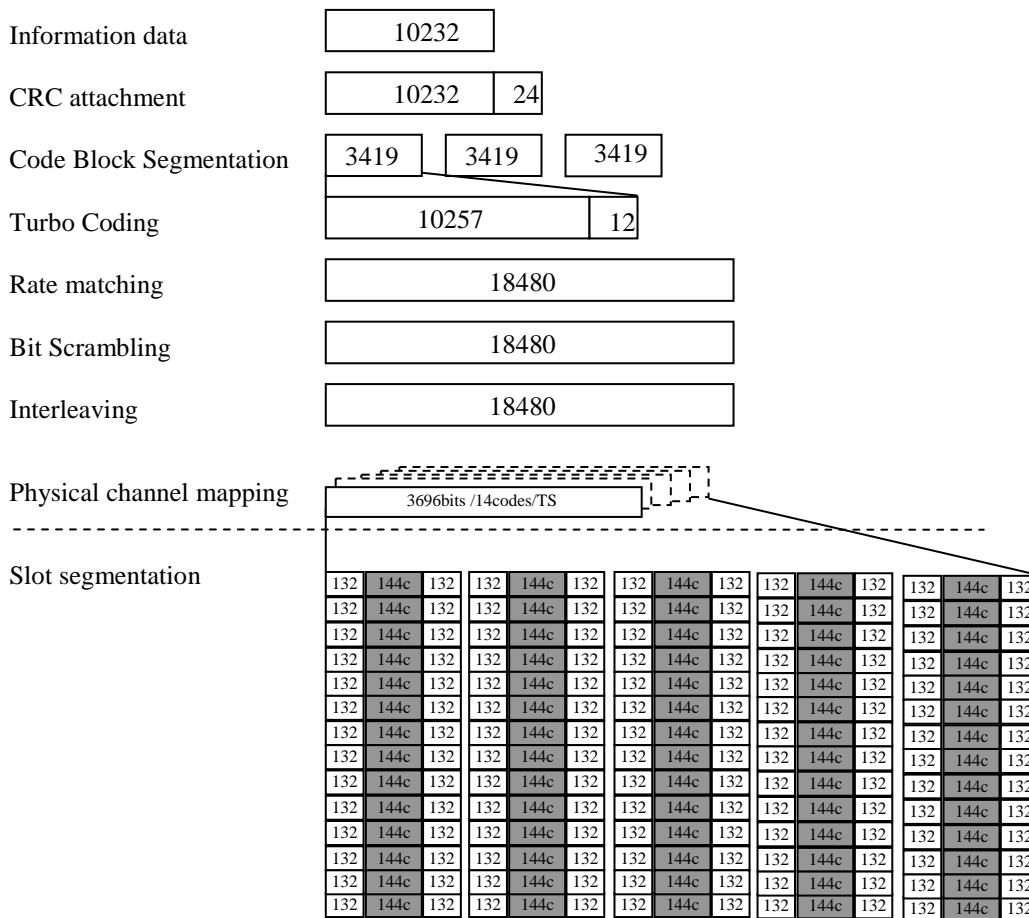

### C.4.2.7 Reference measurement channels for Category 25 UE

#### C.4.2.7.1 QPSK modulation scheme

**Table C.4.2.7.1: Reference Measurement Channel for Category 25 (QPSK)**

Parameter	Unit	Value	
		1 <sup>st</sup> stream	2 <sup>nd</sup> stream
Stream		1 <sup>st</sup> stream	2 <sup>nd</sup> stream
Modulation	-	QPSK	QPSK
Combined Nominal Avg. Inf. Bit Rate	Mbps	1.0976	
Nominal Avg. Inf. Bit Rate per stream	kbps	564.8	532.8
Number of HARQ Processes	Processes	4	4
Information Bit Payload ( $N_{INF}$ )	Bits	2824	2664
Number Code Blocks	Blocks	1	1
Total Available of Soft Channel bits in UE	Bits	202752	
Number of Soft Channel bit per HARQ Proc.	Bits	25344	25344
Number of coded bits per TTI	Bits	4224	4224
Coding Rate	-	0.6697	0.6323
Number of HS-DSCH Timeslots	Slots	3	3
Number of HS-PDSCH codes per TS	Codes	16	16
Spreading factor	SF	16	16
Note: For UE support SF=1 only in dual stream transmission, both the number of HS-PDSCH codes per TS and spreading factor in the FRC should be changed to 1.			



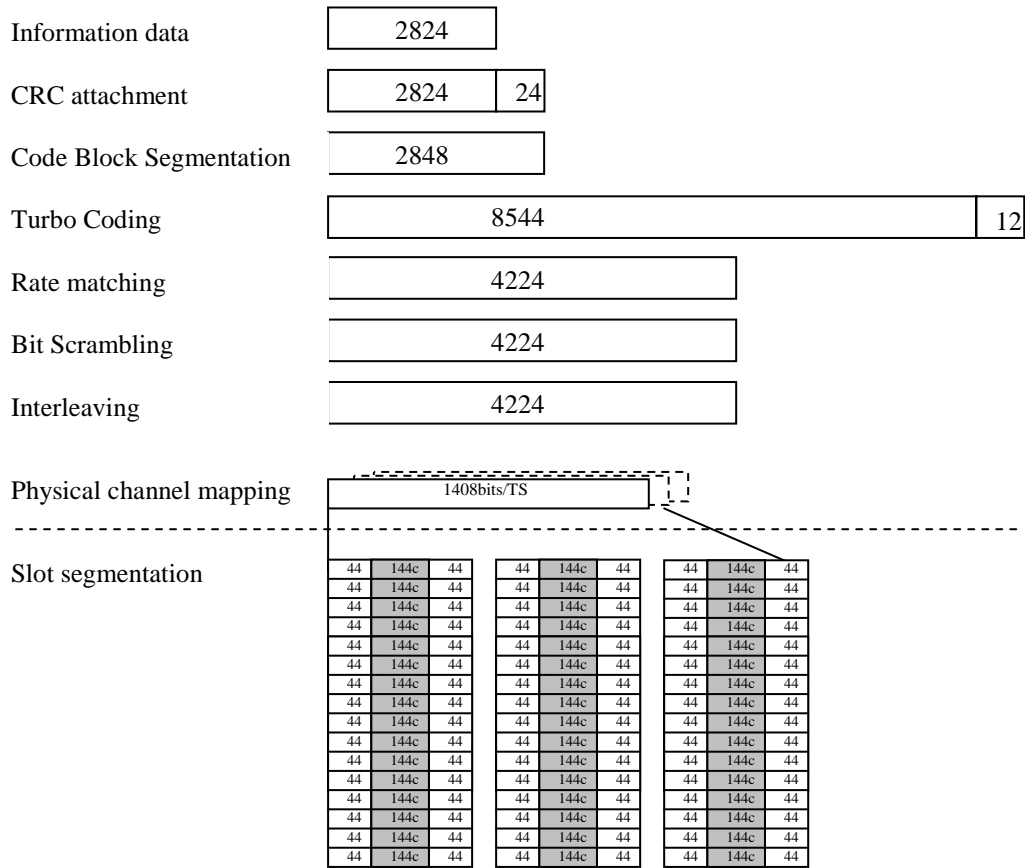

Figure C.4.2.7.1a Reference Measurement Channel for Category 25 (QPSK) - First Stream

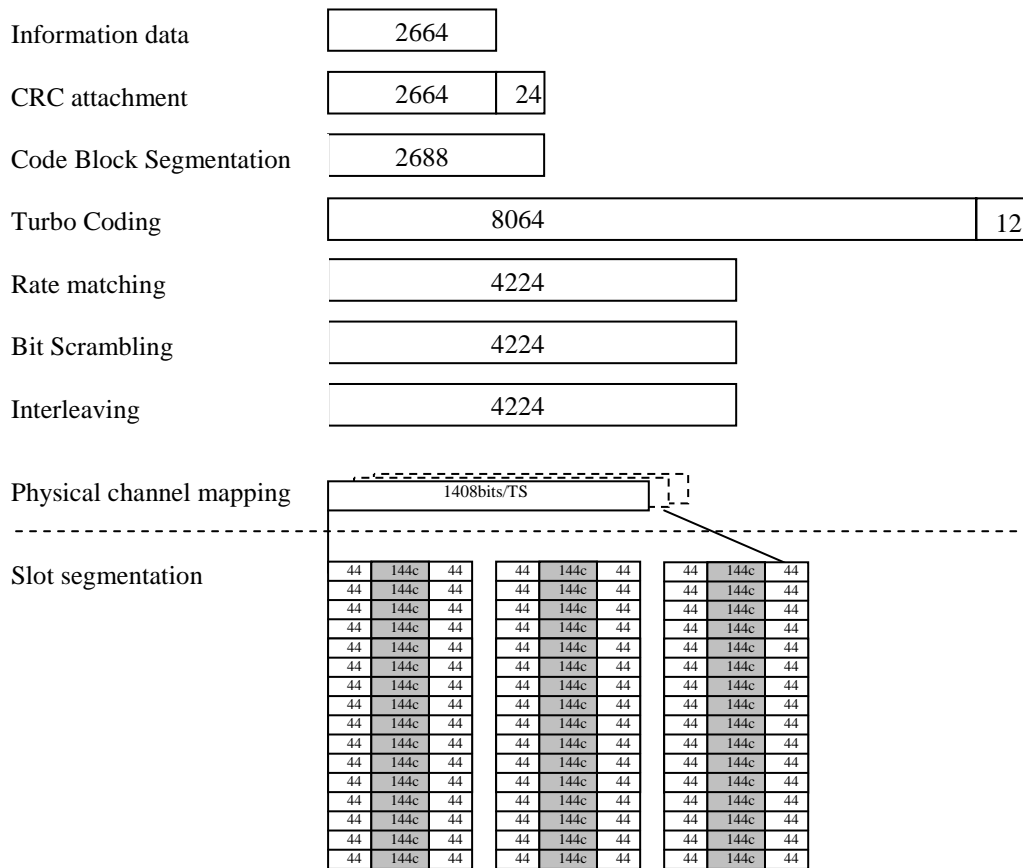

Figure C.4.2.7.1b Reference Measurement Channel for Category 25 (QPSK) - Second Stream

C.4.2.7.2 16QAM modulation scheme

Table C.4.2.7.2 Reference Measurement Channel for Category 25 (16QAM)

Parameter	Unit	Value	
		1 <sup>st</sup> stream	2 <sup>nd</sup> stream
Stream		1 <sup>st</sup> stream	2 <sup>nd</sup> stream
Modulation	-	16QAM	16QAM
Combined Nominal Avg. Inf. Bit Rate	Mbps	1.8416	
Nominal Avg. Inf. Bit Rate per stream	kbps	947.2	894.4
Number of HARQ Processes	Processes	4	4
Information Bit Payload ( $N_{INF}$ )	Bits	4736	4472
Number Code Blocks	Blocks	1	1
Total Available of Soft Channel bits in UE	Bits	202752	
Number of Soft Channel bit per HARQ Proc.	Bits	25344	25344
Number of coded bits per TTI	Bits	8448	8448
Coding Rate	-	0.561	0.529
Number of HS-DSCH Timeslots	Slots	3	3
Number of HS-PDSCH codes per TS	Codes	16	16
Spreading factor	SF	16	16

Note: For UE support SF=1 only in dual stream transmission, both the number of HS-PDSCH codes per TS and spreading factor in the FRC should be changed to 1.

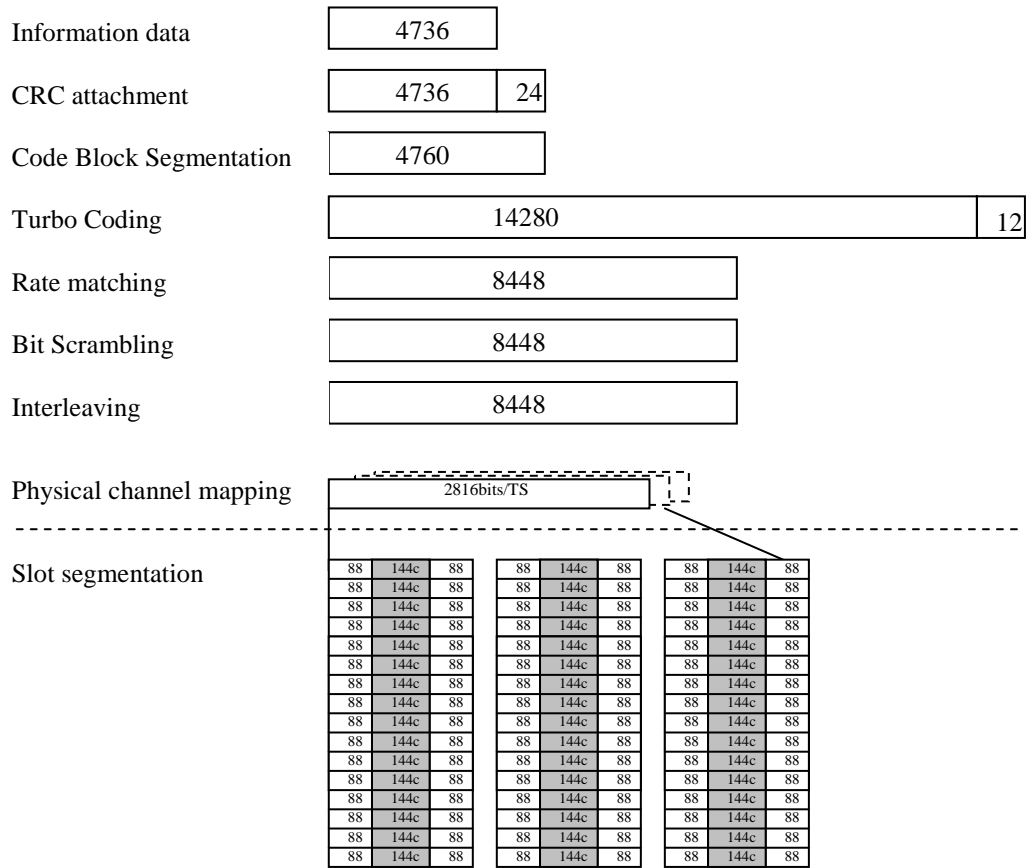

Figure C.4.2.7.2a Reference Measurement Channel for Category 25 (16QAM) - First Stream

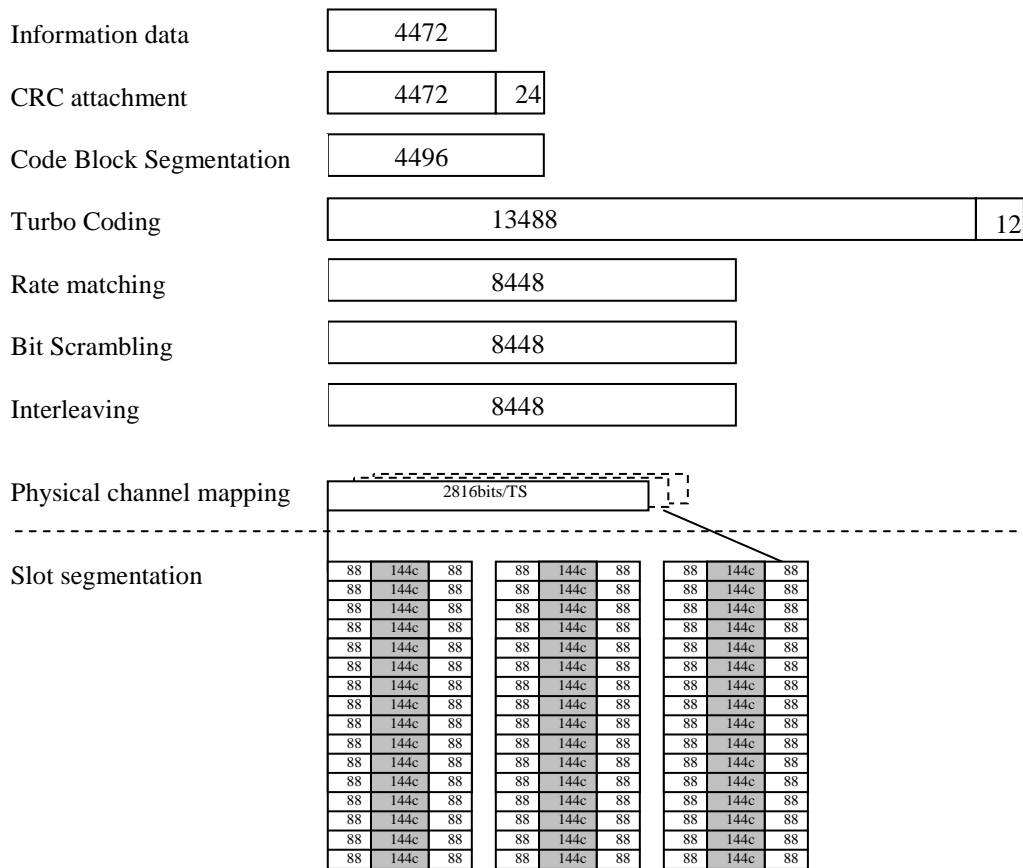

Figure C.4.2.7.2b Reference Measurement Channel for Category 25 (16QAM) - Second Stream

### C.4.2.8 Reference Measurement Channel for category 26 UE

#### C.4.2.8.1 QPSK modulation scheme

Table C.4.2.8.1: Reference Measurement Channel for Category 26 (QPSK)

Parameter	Unit	Value	
		1 <sup>st</sup> stream	2 <sup>nd</sup> stream
Stream		1 <sup>st</sup> stream	2 <sup>nd</sup> stream
Modulation	-	QPSK	QPSK
Combined Nominal Avg. Inf. Bit Rate	Mbps	1.5152	
Nominal Avg. Inf. Bit Rate per stream	kbps	780.8	734.4
Number of HARQ Processes	Processes	4	4
Information Bit Payload ( $N_{INF}$ )	Bits	3904	3672
Number Code Blocks	Blocks	1	1
Total Available of Soft Channel bits in UE	Bits	270336	
Number of Soft Channel bit per HARQ Proc.	Bits	33792	33792
Number of coded bits per TTI	Bits	5632	5632
Coding Rate	-	0.693	0.652
Number of HS-DSCH Timeslots	Slots	4	4
Number of HS-PDSCH codes per TS	Codes	16	16
Spreading factor	SF	16	16

Note: For UE support SF=1 only in dual stream transmission, both the number of HS-PDSCH codes per TS and spreading factor in the FRC should be changed to 1.

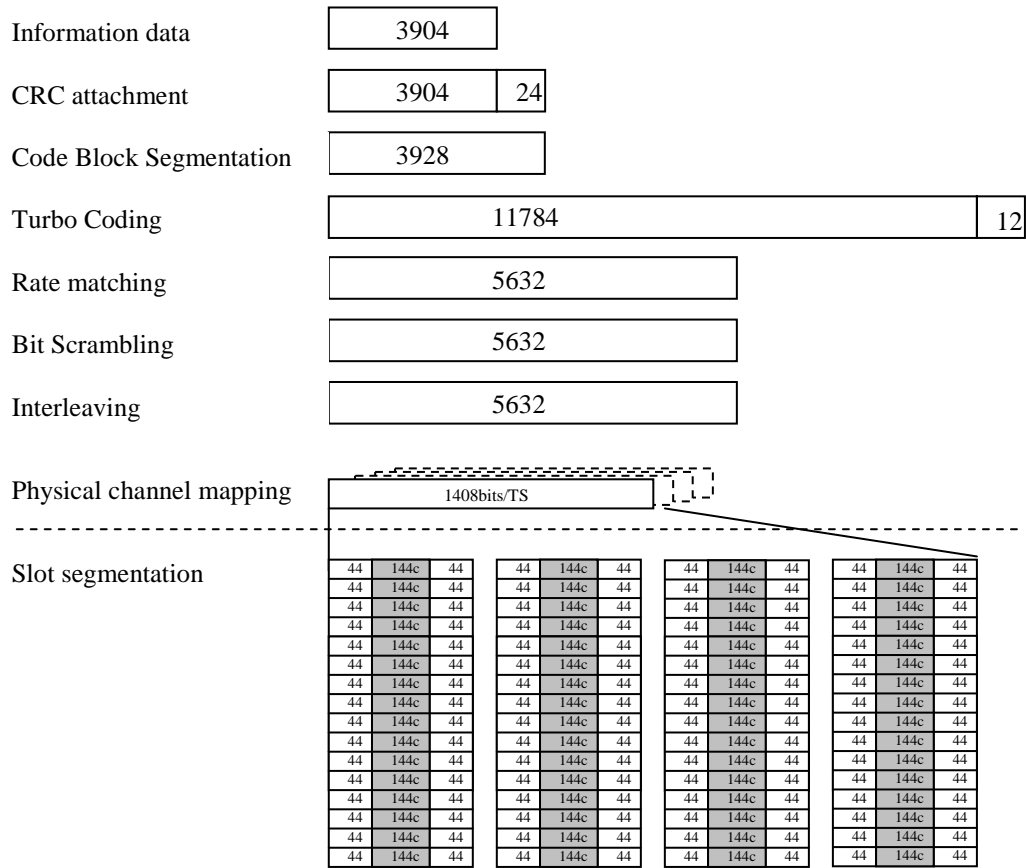

Figure C.4.2.8.1a Reference Measurement Channel for Category 26 (QPSK) - First Stream

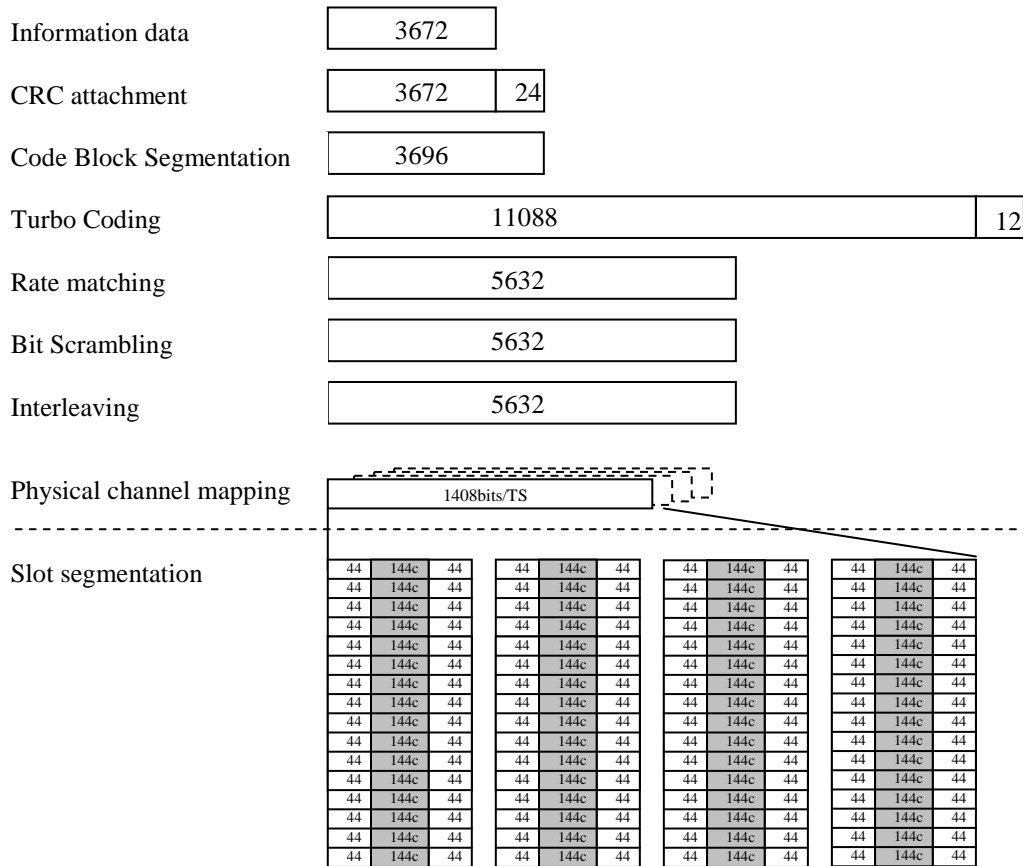

Figure C.4.2.8.1b: Reference Measurement Channel for Category 26 (QPSK) - Second Stream

C.4.2.8.2 16QAM modulation scheme

Table C.4.2.8.2: Reference Measurement Channel for Category 26 (16QAM)

Parameter	Unit	Value	
		1 <sup>st</sup> stream	2 <sup>nd</sup> stream
Stream		1 <sup>st</sup> stream	2 <sup>nd</sup> stream
Modulation	-	16QAM	16QAM
Combined Nominal Avg. Inf. Bit Rate	Mbps	2.8192	
Nominal Avg. Inf. Bit Rate per stream	kbps	1452.8	1366.4
Number of HARQ Processes	Processes	4	4
Information Bit Payload ( $N_{INF}$ )	Bits	7264	6832
Number Code Blocks	Blocks	2	2
Total Available of Soft Channel bits in UE	Bits	270336	
Number of Soft Channel bit per HARQ Proc.	Bits	33792	33792
Number of coded bits per TTI	Bits	11264	11264
Coding Rate	-	0.645	0.607
Number of HS-DSCH Timeslots	Slots	4	4
Number of HS-PDSCH codes per TS	Codes	16	16
Spreading factor	SF	16	16

Note: For UE support SF=1 only in dual stream transmission, both the number of HS-PDSCH codes per TS and spreading factor in the FRC should be changed to 1.

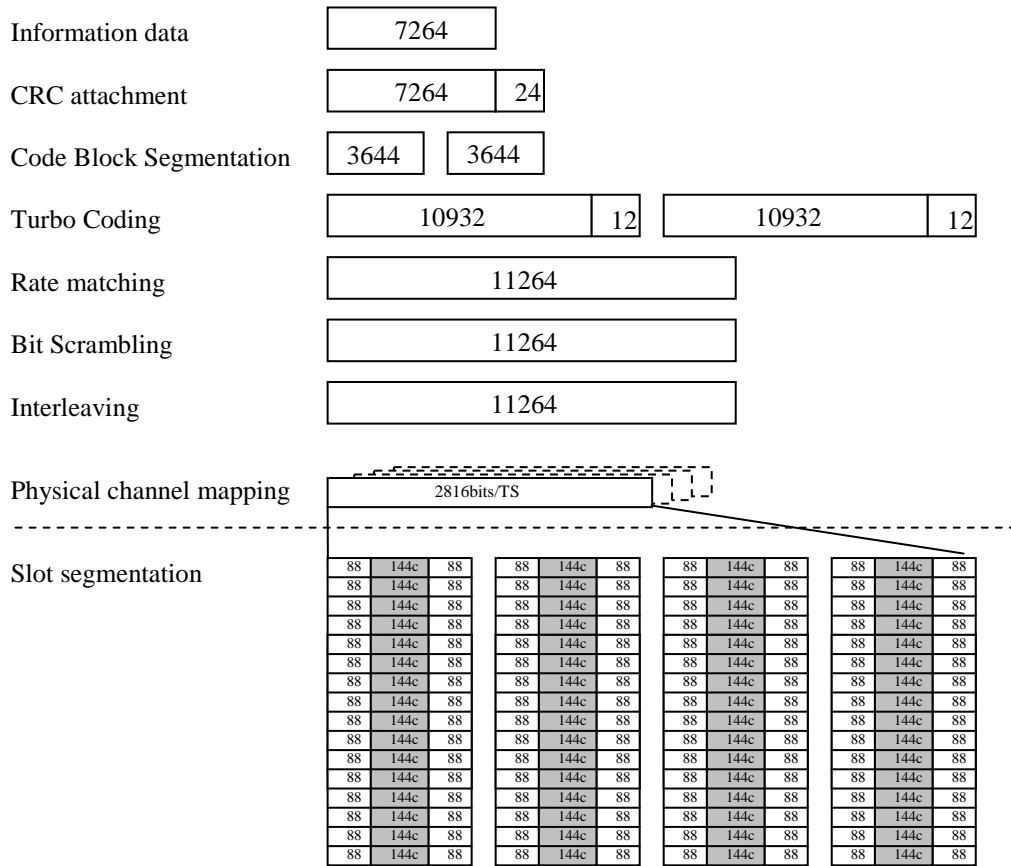

Figure C.4.2.8.2a Reference Measurement Channel for Category 26 (16QAM) - First Stream

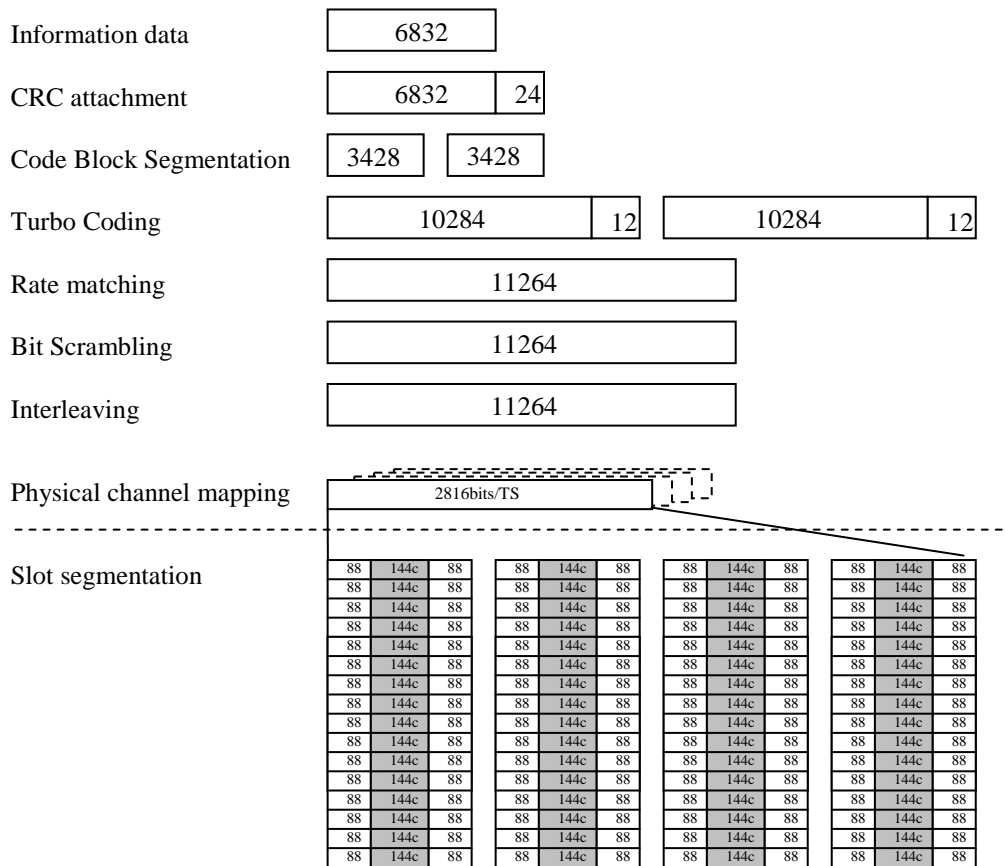

Figure C.4.2.8.2b Reference Measurement Channel for Category 26 (16QAM) - Second Stream

### C.4.2.9 Reference Measurement Channel for category 27 UE

#### C.4.2.9.1 QPSK modulation scheme

Table C.4.2.9.1 Reference Measurement Channel for Category 27 (QPSK)

Parameter	Unit	Value	
		1 <sup>st</sup> stream	2 <sup>nd</sup> stream
Stream		1 <sup>st</sup> stream	2 <sup>nd</sup> stream
Modulation	-	QPSK	QPSK
Combined Nominal Avg. Inf. Bit Rate	Mbps	1.7808	
Nominal Avg. Inf. Bit Rate per stream	kbps	920	860.8
Number of HARQ Processes	Processes	4	4
Information Bit Payload ( $N_{INF}$ )	Bits	4600	4304
Number Code Blocks	Blocks	1	1
Total Available of Soft Channel bits in UE	Bits	337920	
Number of Soft Channel bit per HARQ Proc.	Bits	42240	42240
Number of coded bits per TTI	Bits	7040	7040
Coding Rate	-	0.653	0.611
Number of HS-DSCH Timeslots	Slots	5	5
Number of HS-PDSCH codes per TS	Codes	16	16
Spreading factor	SF	16	16
Note: For UE support SF=1 only in dual stream transmission, both the number of HS-PDSCH codes per TS and spreading factor in the FRC should be changed to 1.			



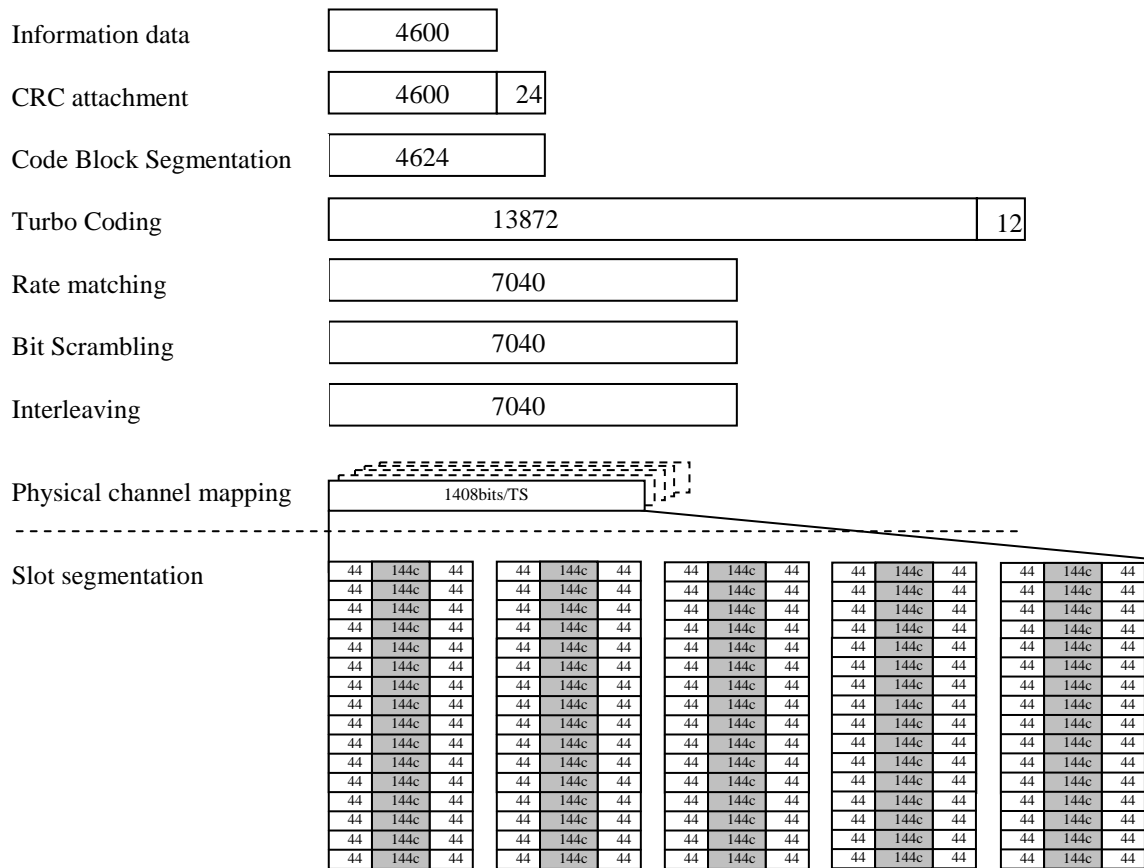

Figure C.4.2.9.1a Reference Measurement Channel for Category 27 (QPSK) - First Stream

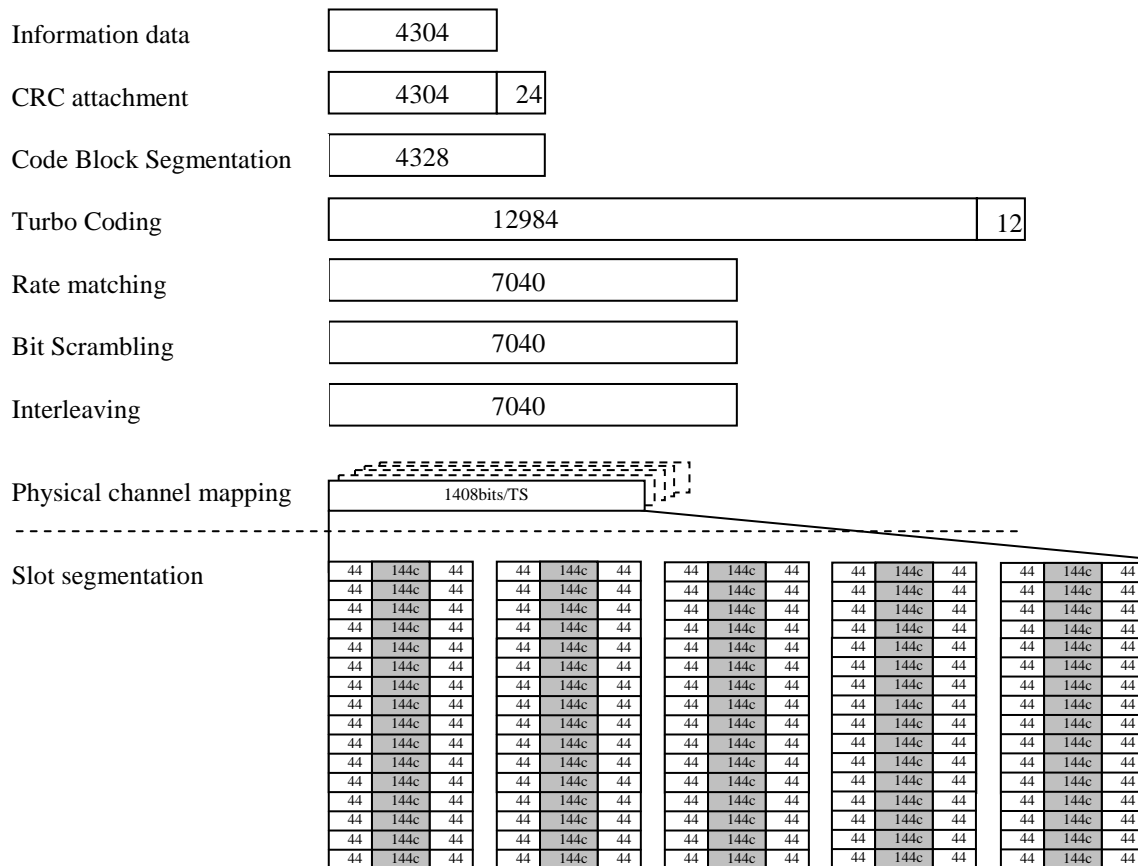

Figure C.4.2.9.1b Reference Measurement Channel for Category 27 (QPSK) - Second Stream

C.4.2.9.2 16QAM modulation scheme

Table A.25A: Reference Measurement Channel for Category 27 (16QAM)

Parameter	Unit	Value	
		1 <sup>st</sup> stream	2 <sup>nd</sup> stream
Stream		1 <sup>st</sup> stream	2 <sup>nd</sup> stream
Modulation	-	16QAM	16QAM
Combined Nominal Avg. Inf. Bit Rate	Mbps	3.4336	
Nominal Avg. Inf. Bit Rate per stream	kbps	1772.8	1660.8
Number of HARQ Processes	Processes	4	4
Information Bit Payload ( $N_{INF}$ )	Bits	8864	8304
Number Code Blocks	Blocks	2	2
Total Available of Soft Channel bits in UE	Bits	337920	
Number of Soft Channel bit per HARQ Proc.	Bits	42240	42240
Number of coded bits per TTI	Bits	14080	14080
Coding Rate	-	0.630	0.590
Number of HS-DSCH Timeslots	Slots	5	5
Number of HS-PDSCH codes per TS	Codes	16	16
Spreading factor	SF	16	16

Note: For UE support SF=1 only in dual stream transmission, both the number of HS-PDSCH codes per TS and spreading factor in the FRC should be changed to 1.

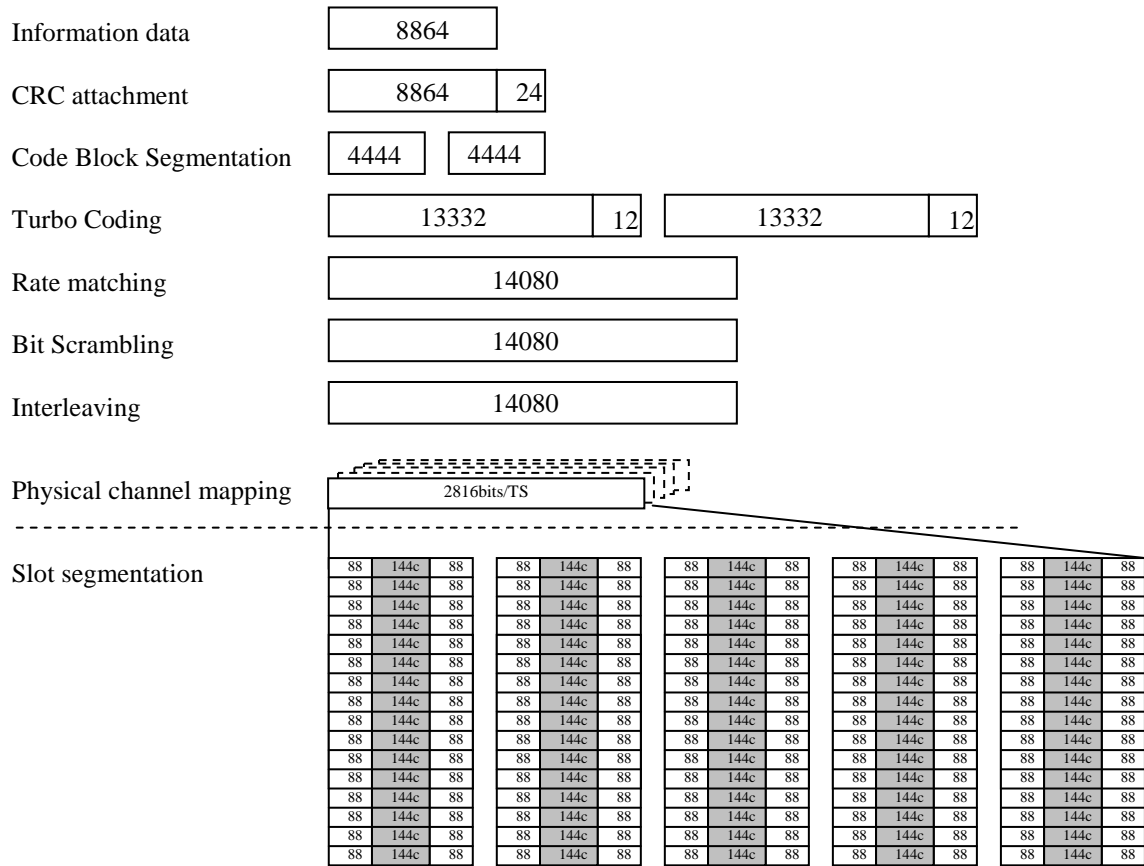

Figure C.4.2.9.2a: Reference Measurement Channel for Category 27 (16QAM) - First Stream

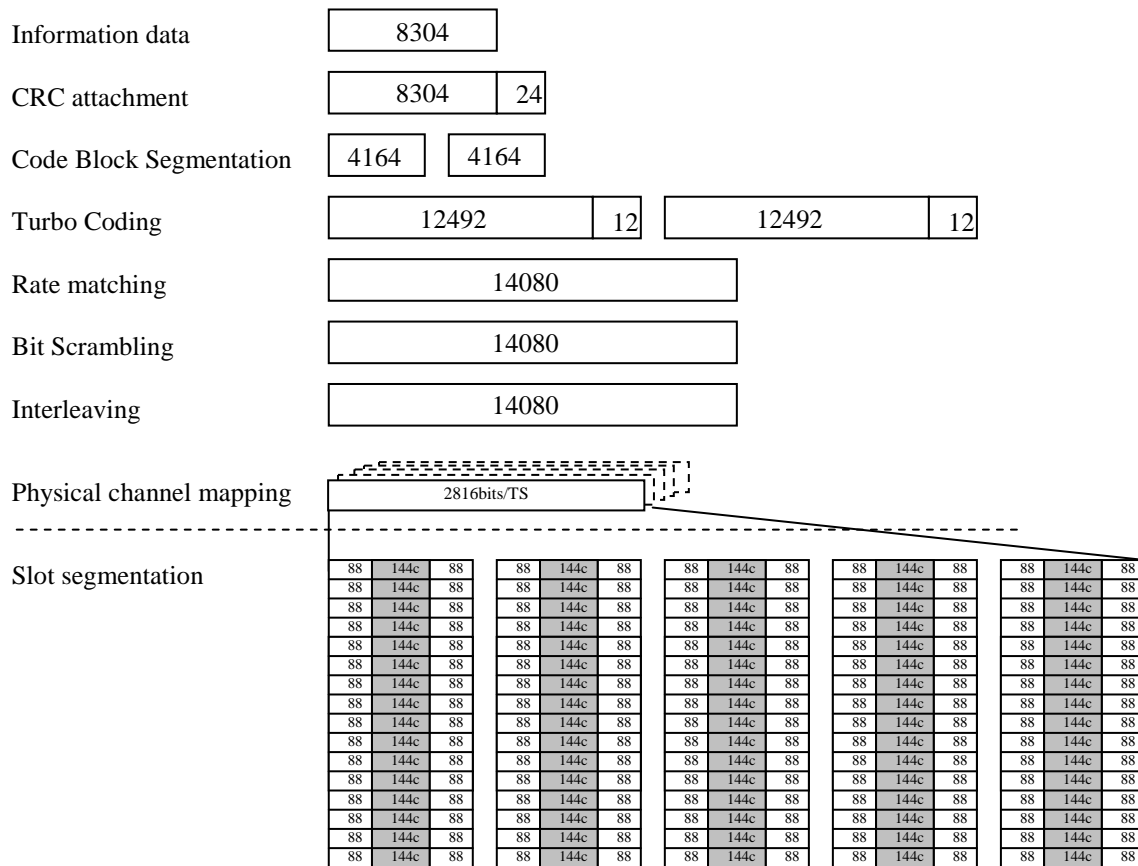

Figure C.4.2.9.2b: Reference Measurement Channel for Category 27 (16QAM) - Second Stream

### C.4.2.10 Reference Measurement Channel for category 28 UE

#### C.4.2.10.1 64QAM modulation scheme

Table C.4.2.10.1: Reference Measurement Channel for Category 28 (64QAM)

Parameter	Unit	Value	
		1 <sup>st</sup> stream	2 <sup>nd</sup> stream
Stream		1 <sup>st</sup> stream	2 <sup>nd</sup> stream
Modulation	-	64QAM	64QAM
Combined Nominal Avg. Inf. Bit Rate	Mbps	3.128	
Nominal Avg. Inf. Bit Rate per stream	kbps	1614.4	1513.6
Number of HARQ Processes	Processes	4	4
Information Bit Payload ( $N_{INF}$ )	Bits	8072	7568
Number Code Blocks	Blocks	2	2
Total Available of Soft Channel bits in UE	Bits	304128	
Number of Soft Channel bit per HARQ Proc.	Bits	38016	38016
Number of coded bits per TTI	Bits	12672	12672
Coding Rate	-	0.637	0.597
Number of HS-DSCH Timeslots	Slots	3	3
Number of HS-PDSCH codes per TS	Codes	16	16
Spreading factor	SF	16	16

Note: For UE support SF=1 only in dual stream transmission, both the number of HS-PDSCH codes per TS and spreading factor in the FRC should be changed to 1.

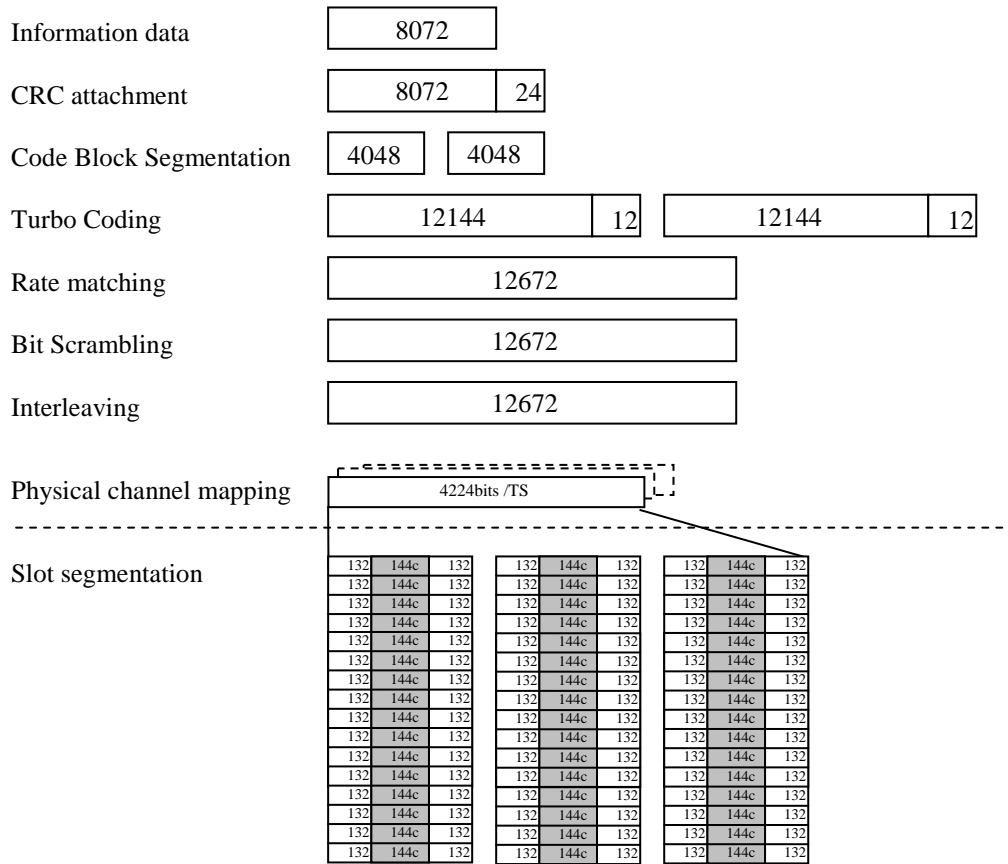

Figure C.4.2.10.1a: Reference Measurement Channel for Category 28 (64QAM) - First Stream

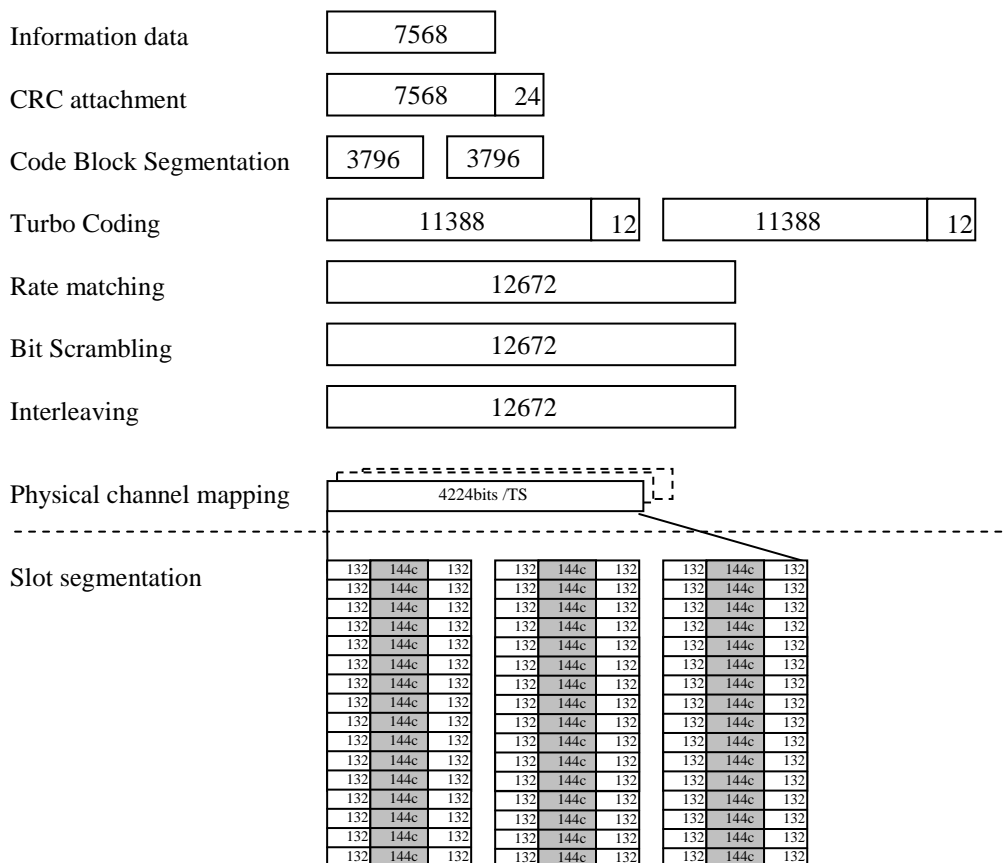

Figure C.4.2.10.1b: Reference Measurement Channel for Category 28 (64QAM) - Second Stream

### C.4.2.11 Reference Measurement Channel for category 29 UE

#### C.4.2.11.1 64QAM modulation scheme

Table C.4.2.11.1: Reference Measurement Channel for Category 29 (64QAM)

Parameter	Unit	Value	
		1 <sup>st</sup> stream	2 <sup>nd</sup> stream
Stream		1 <sup>st</sup> stream	2 <sup>nd</sup> stream
Modulation	-	64QAM	64QAM
Combined Nominal Avg. Inf. Bit Rate	Mbps	4.032	
Nominal Avg. Inf. Bit Rate per stream	kbps	2084.8	1947.2
Number of HARQ Processes	Processes	4	4
Information Bit Payload ( $N_{INF}$ )	Bits	10424	9736
Number Code Blocks	Blocks	3	2
Total Available of Soft Channel bits in UE	Bits	405504	
Number of Soft Channel bit per HARQ Proc.	Bits	50688	50688
Number of coded bits per TTI	Bits	16896	16896
Coding Rate	-	0.617	0.576
Number of HS-DSCH Timeslots	Slots	4	4
Number of HS-PDSCH codes per TS	Codes	16	16
Spreading factor	SF	16	16
Note: For UE support SF=1 only in dual stream transmission, both the number of HS-PDSCH codes per TS and spreading factor in the FRC should be changed to 1.			

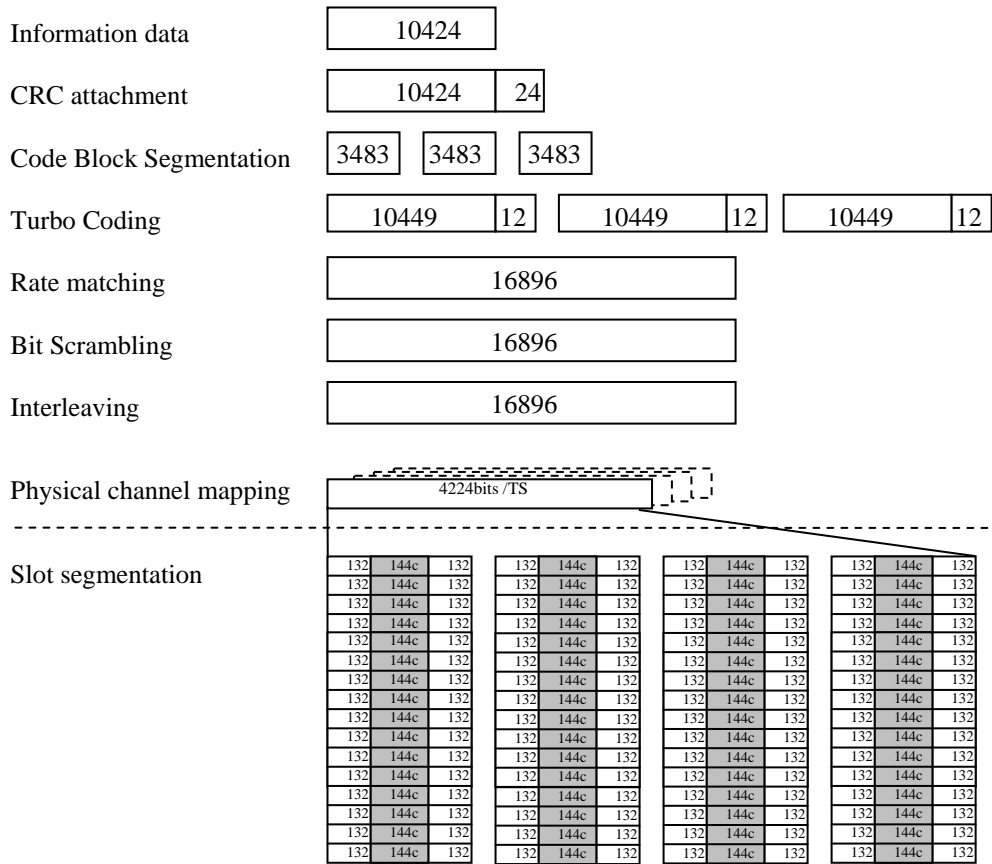

Figure C.4.2.11.1a: Reference Measurement Channel for Category 29 (64QAM) - First Stream

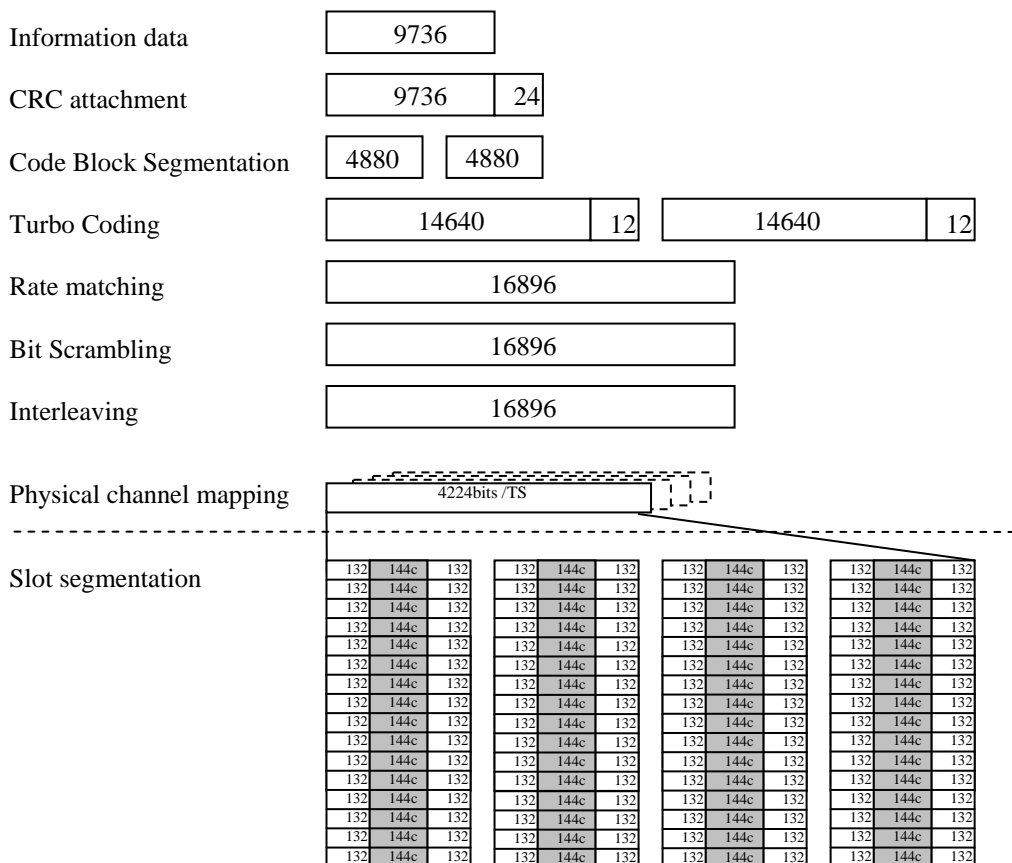

Figure C.4.2.11.1b: Reference Measurement Channel for Category 29 (64QAM) - Second Stream

### C.4.2.12 Reference Measurement Channel for category 30 UE

#### C.4.2.12.1 64QAM modulation scheme

Table C.4.2.12: Reference Measurement Channel for Category 30 (64QAM)

Parameter	Unit	Value	
		1 <sup>st</sup> stream	2 <sup>nd</sup> stream
Stream		1 <sup>st</sup> stream	2 <sup>nd</sup> stream
Modulation	-	64QAM	64QAM
Combined Nominal Avg. Inf. Bit Rate	Mbps	4.9072	
Nominal Avg. Inf. Bit Rate per stream	kbps	2542.4	2364.8
Number of HARQ Processes	Processes	4	4
Information Bit Payload ( $N_{INF}$ )	Bits	12712	11824
Number Code Blocks	Blocks	3	3
Total Available of Soft Channel bits in UE	Bits	506880	
Number of Soft Channel bit per HARQ Proc.	Bits	63360	63360
Number of coded bits per TTI	Bits	21120	21120
Coding Rate	-	0.602	0.560
Number of HS-DSCH Timeslots	Slots	5	5
Number of HS-PDSCH codes per TS	Codes	16	16
Spreading factor	SF	16	16

Note: For UE support SF=1 only in dual stream transmission, both the number of HS-PDSCH codes per TS and spreading factor in the FRC should be changed to 1.



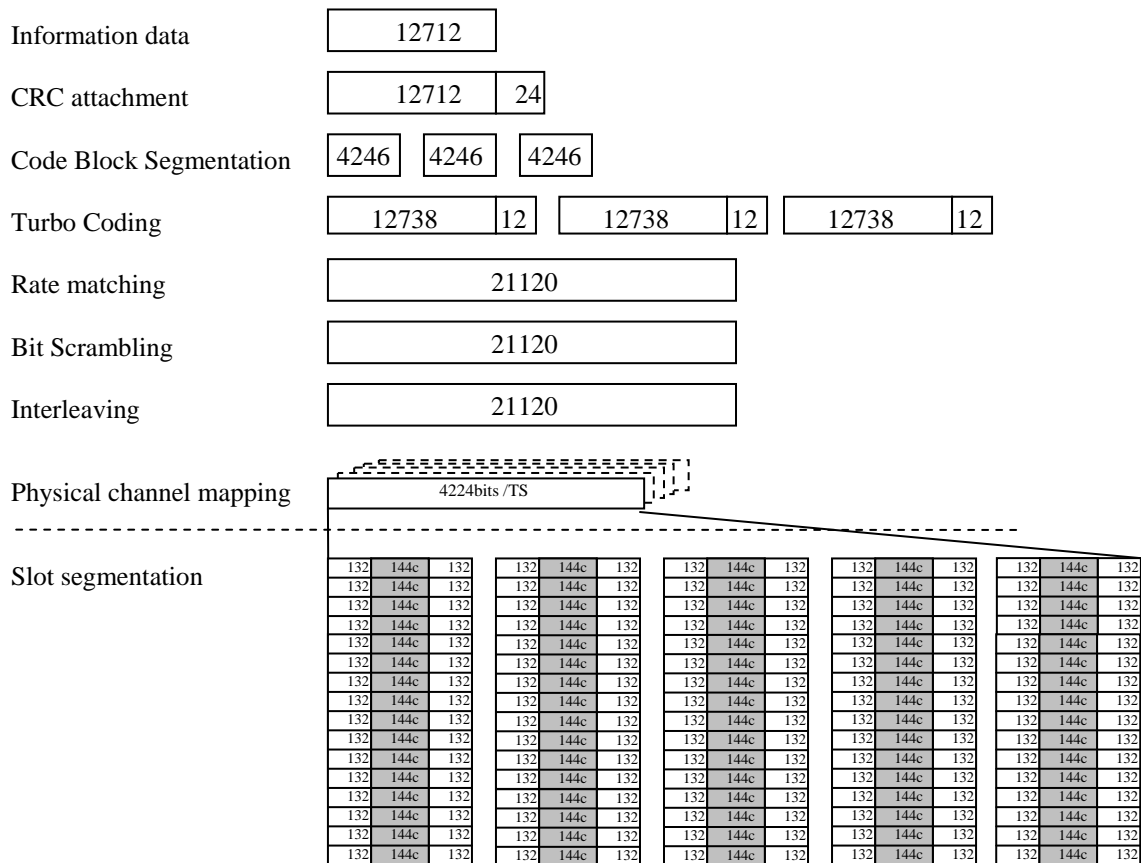

Figure C.4.2.12a: Reference Measurement Channel for Category 30 (64QAM) - First Stream

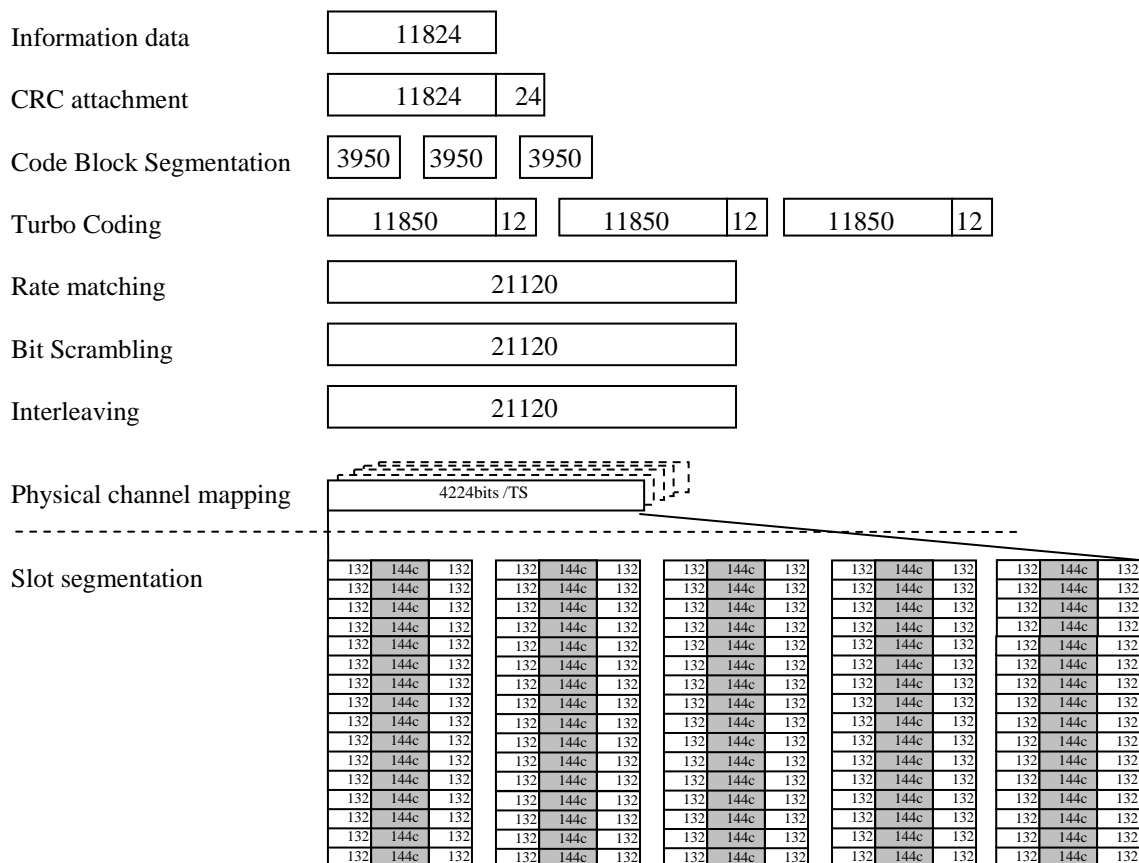

Figure C.4.2.12b: Reference Measurement Channel for Category 30 (64QAM) - Second Stream

### C.4.2A HSDPA reference measurement channels for 7,68 Mcps TDD option

#### C.4.2A.1 Reference measurement channels for 5,3 Mbps - Category 8 - UE

##### C.4.2A.1.1 QPSK modulation scheme for test 1, 2, 3 & 4

Table C.4.2A.1a: HS-PDSCH fixed reference channel for the PA3, PB3, VA30 and VA120 Channel models - Category 8

Parameter	Unit	Value
Maximum information bit throughput	Mbps	1.7612
Number of HARQ Processes	Processes	3
Information Bit Payload ( $N_{INF}$ )	Bits	17612
Number Code Blocks	Blocks	4
Total Available of Soft Channel bits in UE	Bits	211968
Number of Soft Channel bit per HARQ Proc.	Bits	70656
Number of coded bits per TTI	Bits	35328
Coding Rate		1/2
Number of HS-PDSCH Timeslots	Slots	4
Number of HS-PDSCH codes per TS	Codes	32
Spreading factor	SF	32

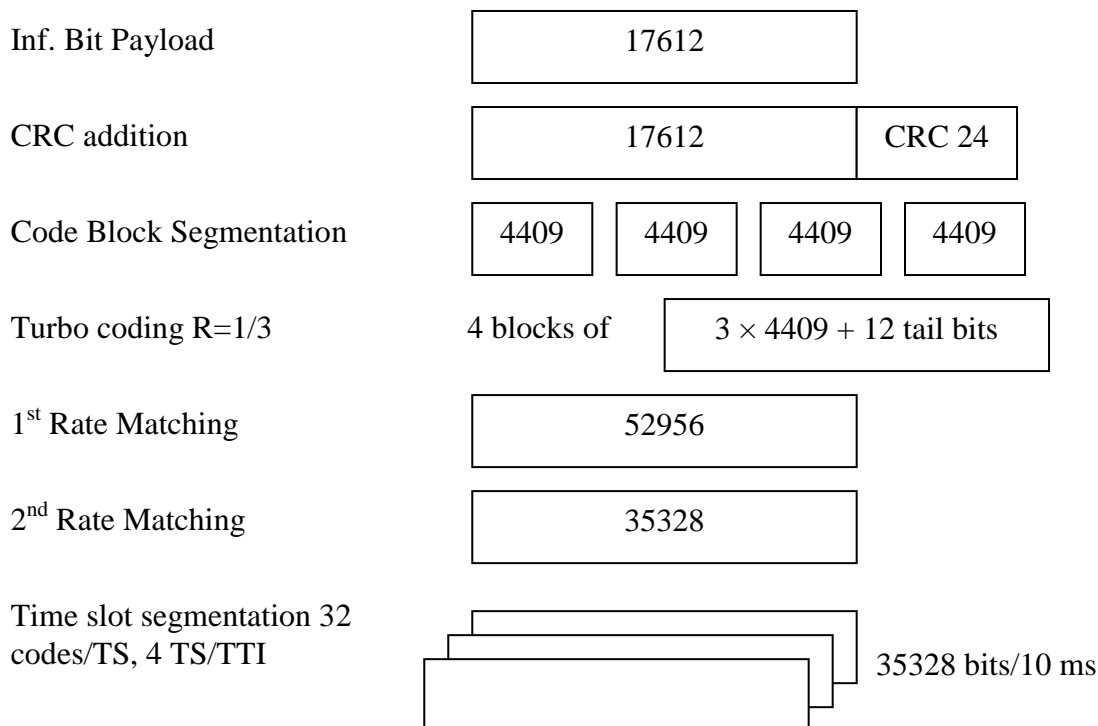
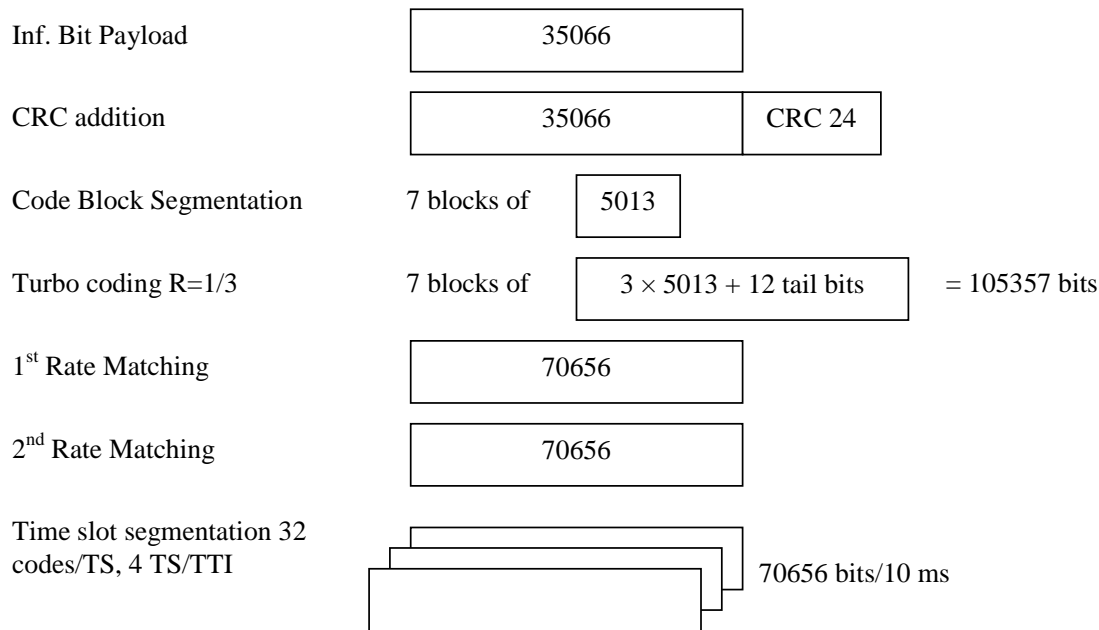

**Figure C.4.2A.1b: Coding for HS-PDSCH fixed reference channel with QPSK modulation for the PA3, PB3, VA30 and VA120 Channels - Category 8**

C.4.2A.1.2 16QAM modulation scheme for test 1, 2, 3 & 4

**Table C.4.2A.1c: HS-PDSCH fixed reference channel for the PA3, PB3, VA30 and VA120 Channel models - Category 8**

Parameter	Unit	Value
Modulation		<b>16-QAM</b>
Maximum information bit throughput	Mbps	3.5066
Number of HARQ Processes	Processes	3
Information Bit Payload ( $N_{INF}$ )	Bits	35066
Number Code Blocks	Blocks	7
Total Available of Soft Channel bits in UE	Bits	211968
Number of Soft Channel bit per HARQ Proc.	Bits	70656
Number of coded bits per TTI	Bits	70656
Coding Rate		$\frac{1}{2}$
Number of HS-PDSCH Timeslots	Slots	4
Number of HS-PDSCH codes per TS	Codes	32
Spreading factor	SF	32



**Figure C.4.2A.1d: Coding for HS-PDSCH fixed reference channel with 16-QAM modulation for the PA3 PB3, VA30 and VA120 Channels - Category 8**

### C.4.3 Variable Reference Channel definition for 3,84 Mcps and 1,28 Mcps TDD options

The variable reference measurement channels are defined by:

- a) The maximum information bit payload that is determined by the UE capability class under test and the allocated resource units (and hence implicitly by the CQI table applicable to the UE under test as derived from TS25.321).
- b) The most recently received UE CQI report.

## C.5 Downlink reference parameters for MBMS tests

### C.5.1 MCCH

#### C.5.1.1 3.84 Mcps TDD Option

The parameters for the MCCH demodulation tests are specified in Table C.5.1.1a and Table C.5.1.1b.

**Table C.5.1.1a: Physical channel parameters for S-CCPCH**

Parameter	Unit	Level
Channel bit rate	kbps	22.8
Channel symbol rate	ksps	11.4
Slot Format #i	-	3
TFCI	-	ON

**Table C.5.1.1b: Transport channel parameters for S-CCPCH**

Parameter	MCCH
User Data Rate	7.2 kbps
Number Transport Channel	1
Transport Block Size	581
Transport Block Set Size	581
RLC SDU block size	4088
Transmission Time Interval	80 ms
Repetition period	640 ms
Modification period	1280 ms
Type of Error Protection	Turbo
Coding Rate	1/3
Rate Matching attribute	256
Size of CRC	16

### C.5.1.2 1.28 Mcps TDD Option

The parameters for the MCCH demodulation tests are specified in Table C5.1.2a and Table C5.1.2b.

**Table C5.1.2a: Physical channel parameters for S-CCPCH**

Parameter	Unit	Level
Channel bit rate	kbps	17.6
Channel symbol rate	ksps	8.8
Slot Format		No TPC&SS
SF	-	16
TFCI	-	ON

**Table C5.1.2b: Transport channel parameters for S-CCPCH**

Parameter	MCCH
User Data Rate	7.6 kbps
Number Transport Channel	1
Transport Block Size	72
Transport Block Set Size	72
RLC SDU block size	4088
Transmission Time Interval	10 ms
Repetition period	640 ms
Modification period	1280 ms
Type of Error Protection	Convolutional code 1/3
Coding Rate	1/3
Rate Matching attribute	160
Size of CRC	16
TFCI	ON

### C.5.1.3 7.68 Mcps TDD Option

The parameters for the MCCH demodulation tests are specified in Table C.5.1.3a and Table C.5.1.3b.

**Table C.5.1.3a: Physical channel parameters for S-CCPCH**

Parameter	Unit	Level
Channel bit rate	kbps	22.8
Channel symbol rate	ksps	11.4
Slot Format #1	-	3
TFCI	-	ON

**Table C.5.1.3b: Transport channel parameters for S-CCPCH**

Parameter	MCCH
User Data Rate	7.2 kbps
Number Transport Channel	1
Transport Block Size	581
Transport Block Set Size	581
RLC SDU block size	4088
Transmission Time Interval	80 ms
Repetition period	640 ms
Modification period	1280 ms
Type of Error Protection	Turbo
Coding Rate	1/3
Rate Matching attribute	256
Size of CRC	16

## C.5.2 MTCH

### C.5.2.1 3.84 Mcps TDD Option (non-IMB)

The parameters for the MTCH demodulation tests are specified in Table C.5.2.1a and Table C.5.2.1b.

**Table C.5.2.1a: Physical channel parameters for S-CCPCH**

Parameter	Unit	Level	Level
User Data Rate	kbps	256	128
Channel bit rate	kbps	388.8	388.8
Channel symbol rate	ksps	194.4	194.4
Slot Format #i	-	3 and 0	3 and 0
TFCI	-	ON	ON

**Table C.5.2.1b: Transport channel parameters for S-CCPCH**

Parameter	MTCH	
User Data Rate	256 kbps	128 kbps
Number of Transport Channel	1	1
Transport Block Size	2561	2561
Transport Block Set Size	10244	5122
Nr of transport blocks/TTI	4	2
RLC SDU block size	10160	5072
Transmission Time Interval	40 ms	40 ms
Type of Error Protection	Turbo	Turbo
Coding Rate	1/3	1/3
Rate Matching attribute	256	256
Size of CRC	16	16

### C.5.2.1A 3.84 Mcps TDD Option (IMB)

The parameters for the MTCH demodulation tests are specified in Table A.46A, Table A.46B and Table A.46C.

**Table C.5.2.1Aa: Physical channel parameters for S-CCPCH frame type 2**

Parameter	Unit	Level
User Data Rate	kbps	512
Modulation	-	16QAM
Channel bit rate	kbps	960
Channel symbol rate	ksps	240
Slot Format #i	-	4 and 5
TFCI	-	ON
Physical resources	-	5 codes x SF16 1 x 2ms sub-frame

**Table C.5.2.1Ab: Transport channel parameters for S-CCPCH frame type 2**

Parameter	MTCH
User Data Rate	512 kbps
Number of Transport Channel	1
Transport Block Size	2560
Transport Block Set Size	40960
Nr of transport blocks/TTI	16
RLC SDU block size	40688
Transmission Time Interval	80 ms
Type of Error Protection	Turbo
Coding Rate	1/3
Rate matching Attribute	256
Size of CRC	16

**Table C.5.2.1Ac: Configuration of other physical channels during MTCH test**

Physical Channel	Power Ratio (Ec/Ior)	NOTE
P-CPICH	-10 dB	
T-CPICH	-0.457 dB	
P-CCPCH	-12 dB	
S-CCPCH frame type 1	-24 dB	
SCH	-12 dB	This power shall be divided equally between Primary and Secondary synchronous channels
OCNS	Necessary power so that total transmit power spectral density of Node B (Ior) adds to one	OCNS interference consists of 10 codes of equal power, each code using SF16 and QPSK modulation

### C.5.2.2 1.28 Mcps TDD Option

The parameters for the MTCH demodulation tests are specified in Table C5.2.2a and Table C5.2.2b.

**Table C5.2.2a: Physical channel parameters for S-CCPCH**

Parameter	Unit	Level	Level	level	level		
User Data Rate	kbps	128	64	384			
Channel bit rate	kbps	246.4	140.8	563.2 <sub>1</sub>	614.4 <sub>2</sub>	281.6 <sub>1</sub>	307.2 <sub>2</sub>
Channel symbol rate	ksps	123.2	70.4	140.8 <sub>1</sub>	153.6 <sub>2</sub>	140.8 <sub>1</sub>	153.6 <sub>2</sub>
Slot Format	-	No TPC&SS	No TPC&SS	No TPC SS		No TPC SS	
TFCI	-	ON	ON	ON		ON	
Note1 used for test 1 and test 2 in section 10.2A.2.2							
Note2 used for test 3 and test 4 in section 10.2A.2.2							

**Table C5.2.2b: Transport channel parameters for S-CCPCH**

Parameter	MTCH			
	128 kbps	64 kbps	384kbps	192k bps
User Data Rate	128 kbps	64 kbps	384kbps	192k bps
Number of Transport Channel	1	1	1	1
Transport Block Size	2561	1281	2561	2561
Transport Block Set Size	5122	2562	15366	7683
Nr of transport blocks/TTI	2	2	6	3
RLC SDU block size	5072	2512	15248	7616
Transmission Time Interval	40 ms	40 ms	40ms	40ms
Type of Error Protection	Turbo	Turbo	Turbo	Turbo
Coding Rate	1/3	1/3	1/3	1/3
Rate Matching attribute	2448	1392	256	256
Size of CRC	16	16	16	16

Parameters for combined MTCH demodulation and cell identification requirements are defined in Table C5.2.2c.

**Table C5.2.2c: Cell reselection parameters**

Parameter	Unit	Value
Serving cell in the initial condition	-	Cell1
Neighbour cells	-	Cell 2 and cell 3
Cell_selection_and_reselection_quality_measure	-	P-CCPCH
Qrxlevmin	dBm	-103
UE_TXPWR_MAX_RACH	dBm	21
Treselection	seconds	4
Sintrasearch	dB	not sent
IE "FACH Measurement occasion info"	-	not sent

### C.5.2.3 7.68 Mcps TDD Option

The parameters for the MTCH demodulation tests are specified in Table C.5.2.3a and Table C.5.2.3b.

**Table C.5.2.3a: Physical channel parameters for S-CCPCH**

Parameter	Unit	Level	Level
User Data Rate	kpbs	256	128
Channel bit rate	kpbs	388.8	388.8
Channel symbol rate	ksps	194.4	194.4
Slot Format #i	-	3 and 0	3 and 0
TFCI	-	ON	ON



**Table C.5.2.3b: Transport channel parameters for S-CCPCH**

Parameter	MTCH	
	256 kbps	128 kbps
User Data Rate	256 kbps	128 kbps
Number of Transport Channel	1	1
Transport Block Size	2561	2561
Transport Block Set Size	10244	5122
Nr of transport blocks/TTI	4	2
RLC SDU block size	10160	5072
Transmission Time Interval	40 ms	40 ms
Type of Error Protection	Turbo	Turbo
Coding Rate	1/3	1/3
Rate Matching attribute	256	256
Size of CRC	16	16

## C.6 E-DCH Reference measurement channels

### C.6.1 E-DCH Fixed Reference Channels

#### C.6.1.1 3,84 Mcps TDD Option

##### C.6.1.1.1 Fixed Reference Channel 1 (FRC1)

**Table C.6.1.1a: E-DCH Fixed Reference Channel 1 (3.84 Mcps TDD Option)**

Parameter	Unit	Value
Maximum information bit throughput	kbps	34.7
Information Bit Payload ( $N_{INF}$ )	Bits	347
Number Code Blocks	Blocks	1
Number of coded bits per TTI	Bits	1200
Coding Rate		0.312
Modulation		QPSK
Number of E-DCH Timeslots	Slots	6
Number of E-DCH codes per TS	Codes	1
Spreading factor	SF	16
Number of E-UCCH per TTI		4

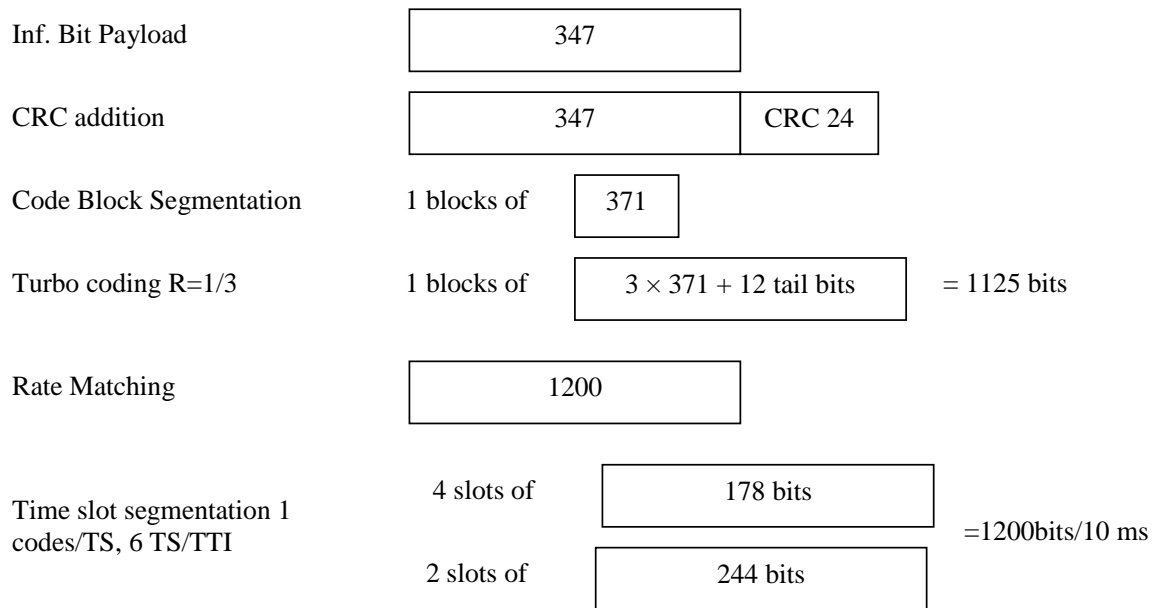
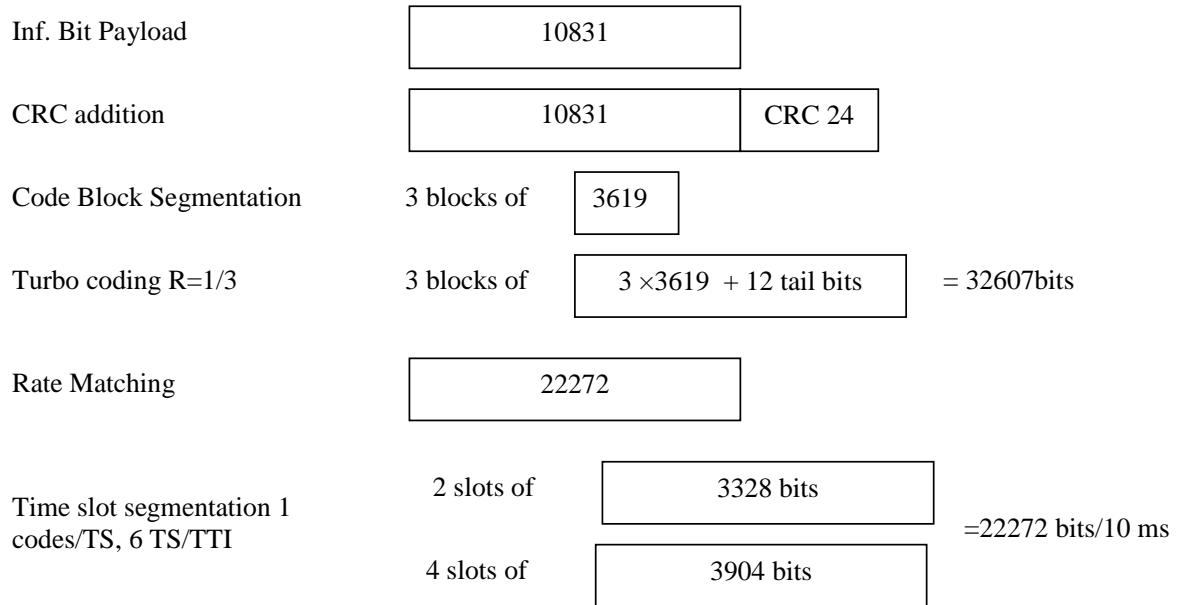

**Figure A.9: Coding for E-DCH FRC1 (3.84 Mcps TDD Option)**

#### C.6.1.1.2 Fixed Reference Channel 2 (FRC2)

**Table C.6.1.1b: E-DCH Fixed Reference Channel 2 (3.84 Mcps TDD Option)**

Parameter	Unit	Value
Maximum information bit throughput	kbps	1083.1
Information Bit Payload ( $N_{INF}$ )	Bits	10831
Number Code Blocks	Blocks	3
Number of coded bits per TTI	Bits	22272
Coding Rate		0.488
Modulation		16QAM
Number of E-DCH Timeslots	Slots	6
Number of E-DCH codes per TS	Codes	1
Spreading factor	SF	2
Number of E-UCCH per TTI		2

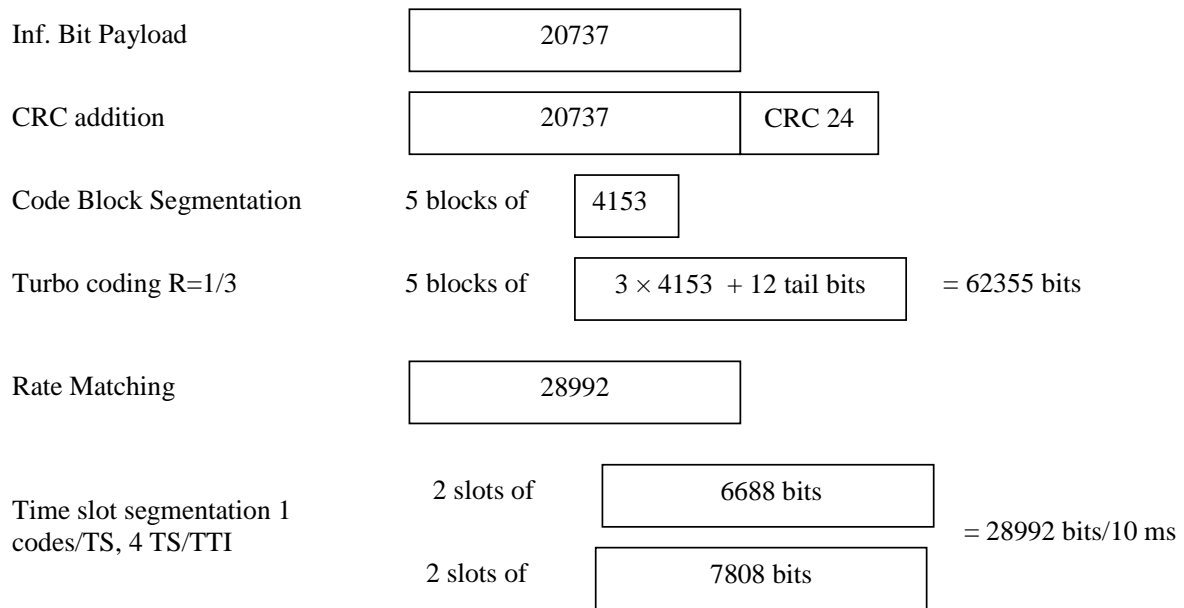

**Figure A.10: Coding for E-DCH FRC2 (3.84 Mcps TDD Option)**

C.6.1.1.3 Fixed Reference Channel 3 (FRC3)

**Table C.6.1.1c: E-DCH Fixed Reference Channel 3 (3.84 Mcps TDD Option)**

Parameter	Unit	Value
Maximum information bit throughput	kbps	2073.7
Information Bit Payload ( $N_{INF}$ )	Bits	20737
Number Code Blocks	Blocks	5
Number of coded bits per TTI	Bits	28992
Coding Rate		0.716
Modulation		16QAM
Number of E-DCH Timeslots	Slots	4
Number of E-DCH codes per TS	Codes	1
Spreading factor	SF	1
Number of E-UCCH per TTI		2



**Figure A.11: Coding for E-DCH FRC3 (3.84 Mcps TDD Option)**

### C.6.1.2 1.28Mcps TDD Option

#### C6.1.2.1 E-DCH Fixed reference channel 1(FRC1)

**Table A.9: E-DCH Fixed reference channel 1 (1.28Mcps TDD option)**

Parameter	Unit	Value
Maximum information bit throughput	kbps	56.4
Information Bit Payload ( $N_{INF}$ )	Bits	282
Number Code Blocks	Blocks	1
Number of coded bits per TTI	Bits	306
Coding Rate		0.5387
Modulation		QPSK
Number of E-DCH Timeslots	Slots	2
Number of E-DCH codes per TS	Codes	1
Spreading factor	SF	4
Number of E-UCCH per TTI		4

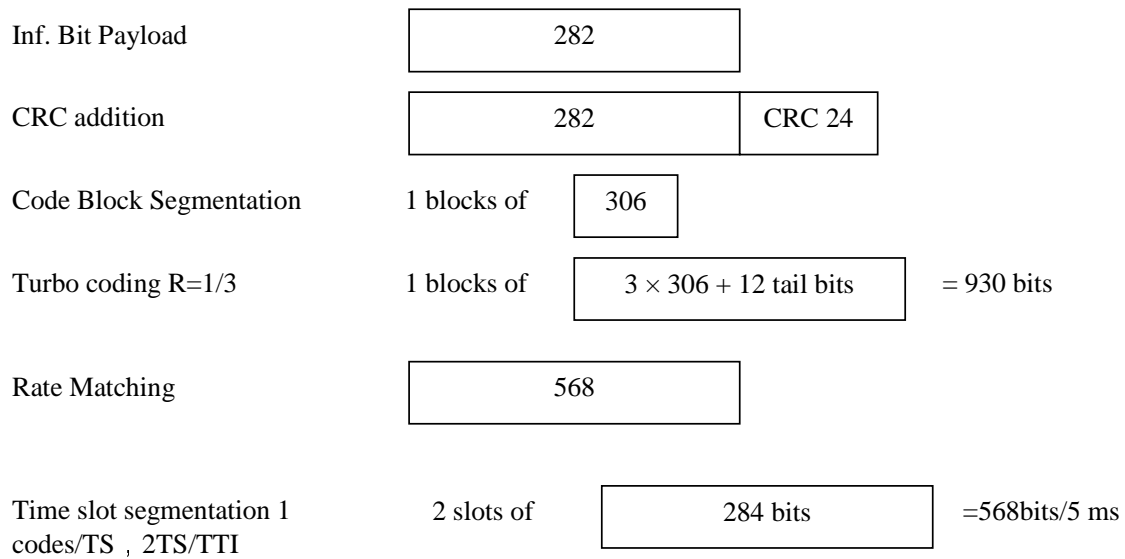

**Figure A.12: Coding for E-DCH FRC1 (1.28 Mcps TDD Option)**

#### C6.1.2.2 Fixed reference channel 2(FRC2)

**Table A.11: E-DCH Fixed reference channel 2 (1.28Mcps TDD option)**

Parameter	Unit	Value
Maximum information bit throughput	kbps	515.6
Information Bit Payload ( $N_{INF}$ )	Bits	2578
Number Code Blocks	Blocks	1
Number of coded bits per TTI	Bits	2602
Coding Rate		0.6365
Modulation		16QAM
Number of E-DCH Timeslots	Slots	3
Number of E-DCH codes per TS	Codes	1
Spreading factor	SF	2
Number of E-UCCH per TTI		2

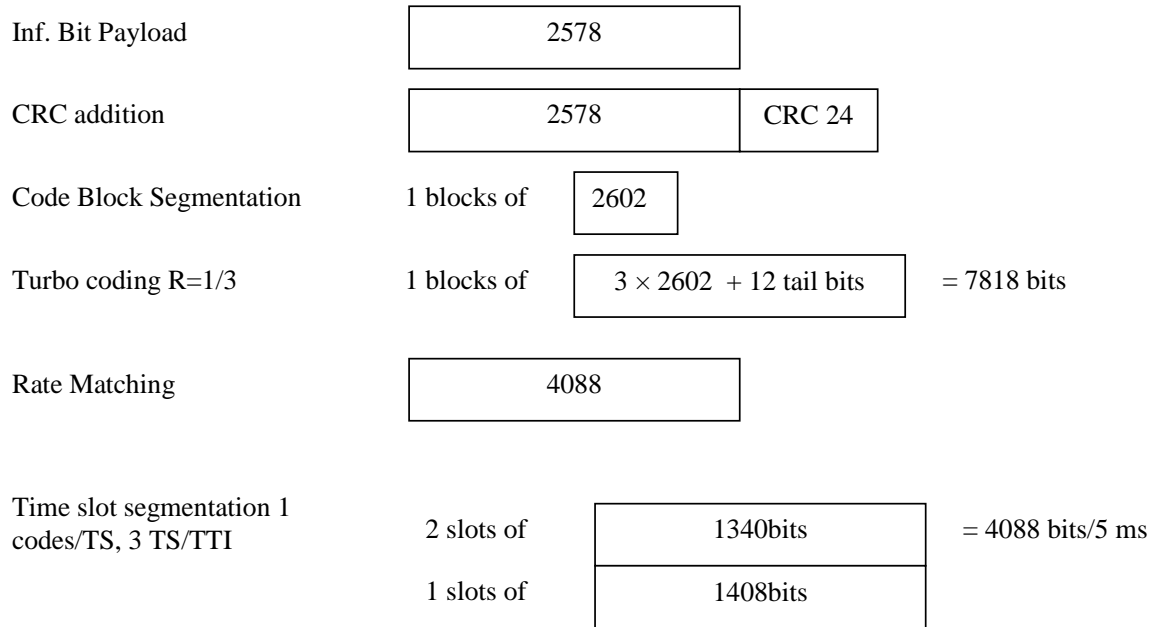
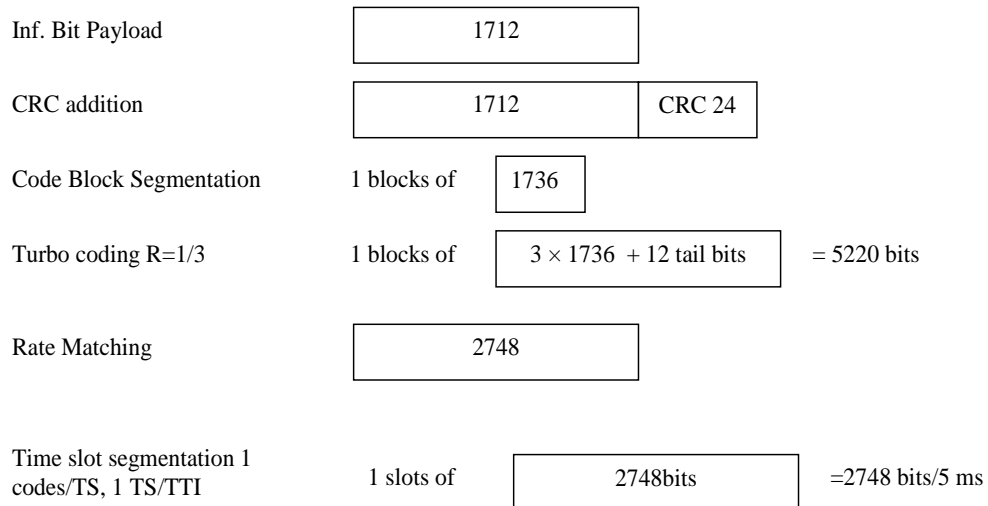

Figure A.13: Coding for E-DCH FRC2 (1.28 Mcps TDD Option)C.6.1.3 7,68 Mcps TDD Option

C6.1.2.3 Fixed reference channel 3(FRC3)

Table C6.1.2.3.a: E-DCH Fixed reference channel 3 (1.28Mcps TDD option)

Parameter	Unit	Value
Maximum information bit throughput	kbps	342.4
Information Bit Payload ( $N_{INF}$ )	Bits	1712
Number Code Blocks	Blocks	1
Number of coded bits per TTI	Bits	1736
Coding Rate		0.63173
Modulation		16QAM
Number of E-DCH Timeslots	Slots	1
Number of E-DCH codes per TS	Codes	1
Spreading factor	SF	1
Number of E-UCCH per TTI		1

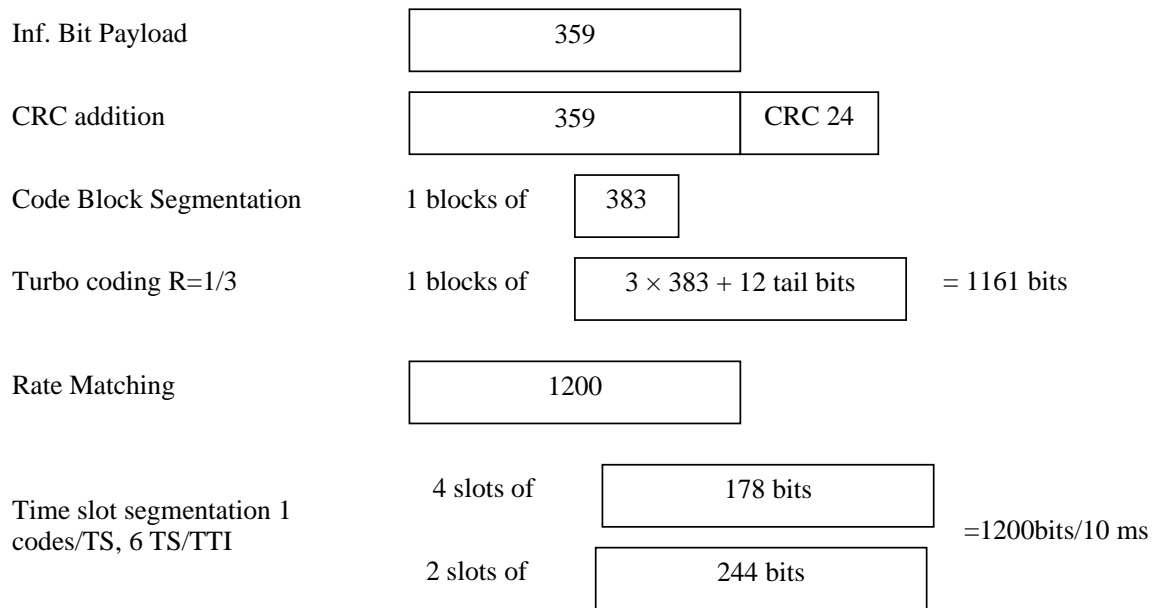

**Figure A.12: Coding for E-DCH FRC3 (1.28 Mcps TDD Option)**

#### C.6.1.3.1 Fixed Reference Channel 1 (FRC1)

**Table C.6.1.3a: E-DCH Fixed Reference Channel 1 (7.68 Mcps TDD Option)**

Parameter	Unit	Value
Maximum information bit throughput	kbps	35.9
Information Bit Payload ( $N_{INF}$ )	Bits	359
Number Code Blocks	Blocks	1
Number of coded bits per TTI	Bits	1200
Coding Rate		0.323
Modulation		QPSK
Number of E-DCH Timeslots	Slots	6
Number of E-DCH codes per TS	Codes	1
Spreading factor	SF	32
Number of E-UCCH per TTI		4



**Figure A.12: Coding for E-DCH FRC1 (7.68 Mcps TDD Option)**

C.6.1.3.2 Fixed Reference Channel 2 (FRC2)

**Table C.6.1.3b: E-DCH Fixed Reference Channel 2 (7.68 Mcps TDD Option)**

Parameter	Unit	Value
Maximum information bit throughput	kbps	1083.1
Information Bit Payload ( $N_{INF}$ )	Bits	10831
Number Code Blocks	Blocks	3
Number of coded bits per TTI	Bits	22272
Coding Rate		0.488
Modulation		16QAM
Number of E-DCH Timeslots	Slots	6
Number of E-DCH codes per TS	Codes	1
Spreading factor	SF	4
Number of E-UCCH per TTI		2



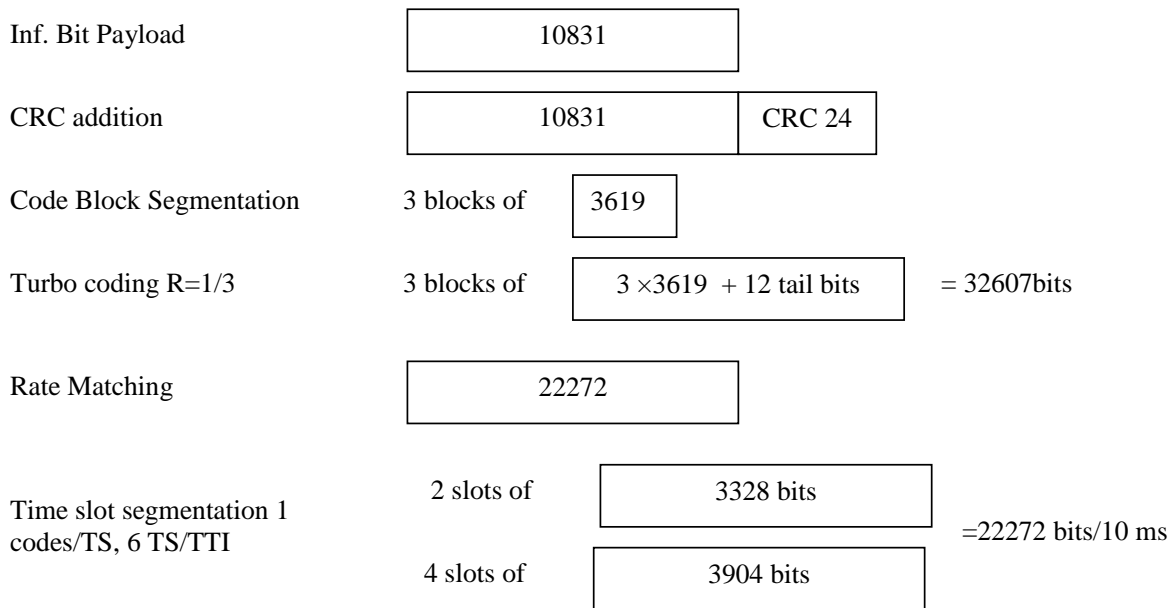
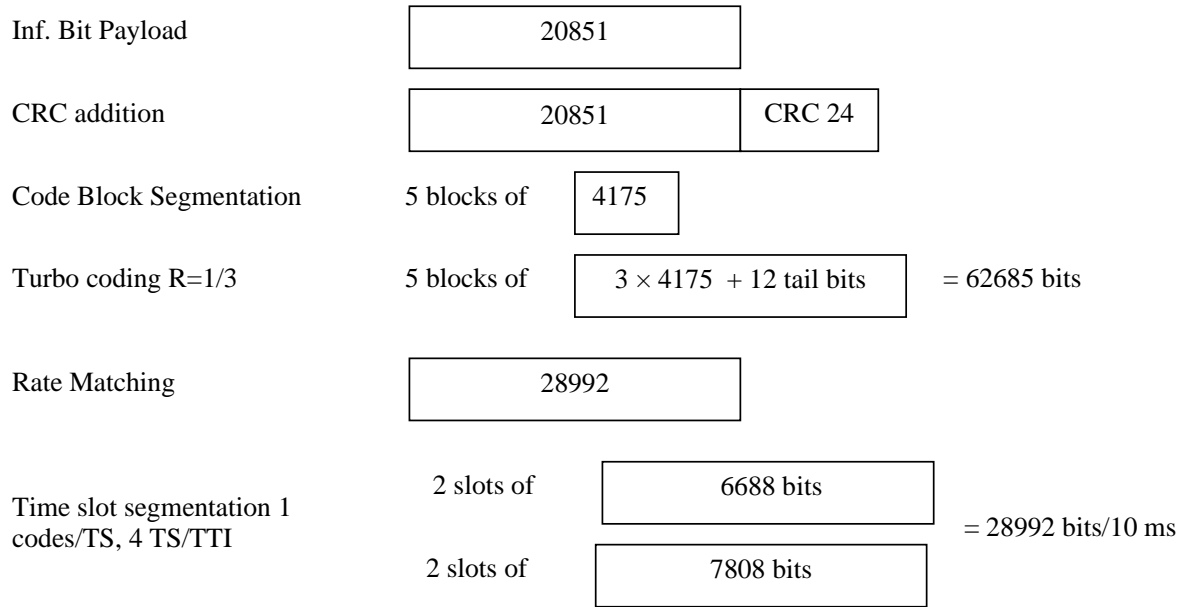

**Figure A.13: Coding for E-DCH FRC2 (7.68 Mcps TDD Option)**

C.6.1.3.3 Fixed Reference Channel 3 (FRC3)

**Table C.6.1.3c: E-DCH Fixed Reference Channel 3 (7.68 Mcps TDD Option)**

Parameter	Unit	Value
Maximum information bit throughput	kbps	2085.1
Information Bit Payload ( $N_{INF}$ )	Bits	20851
Number Code Blocks	Blocks	5
Number of coded bits per TTI	Bits	28992
Coding Rate		0.720
Modulation		16QAM
Number of E-DCH Timeslots	Slots	6
Number of E-DCH codes per TS	Codes	1
Spreading factor	SF	2
Number of E-UCCH per TTI		2



**Figure A.14: Coding for E-DCH FRC3 (7.68 Mcps TDD Option)**

## Annex D (normative): Propagation conditions

### D.1 Test Environments

Table D.1 details the test services, the information data and the propagation conditions.

**Table D.1: Test Environments for UE Performance Specifications**

Test Services	Information Data Rate	Static	Multipath Case 1	Multipath Case 2	Multipath Case 3
		<b>Performance metric</b>			
Paging Message			-	-	-
FACH Message			-	-	-
Circuit Switched Services	12,2 kbps	BLER <	BLER <	BLER <	BLER <
	64 kbps	BLER <	BLER <	BLER <	BLER <
	144 kbps	BLER <	BLER <	BLER <	BLER <
	384 kbps	BLER <	BLER <	BLER <	BLER <
	2048 kbps	BLER <	-	-	-
Packet Switched Data	TBD	TBD	TBD	TBD	TBD

### D.2 Propagation Conditions

#### D.2.1 Static propagation condition

The propagation for the static performance measurement is an Additive White Gaussian Noise (AWGN) environment. No fading and multi-paths exist for this propagation model.

#### D.2.2 Multi-path fading propagation conditions

##### D.2.2.1 3,84 Mcps TDD Option

Table D.2.2.1 shows propagation conditions that are used for the performance measurements in multi-path fading environment. All taps have classical Doppler spectrum.

**Table D.2.2.1: 3,84 Mcps Propagation Conditions for Multi path Fading Environments**

Case 1, speed 3km/h		Case 2, speed 3 km/h		Case 3, speed 120 km/h		Case 4, speed 3 km/h	
Relative Delay [ns]	Relative Mean Power [dB]	Relative Delay [ns]	Relative Mean Power [dB]	Relative Delay [ns]	Relative Mean Power [dB]	Relative Delay [ns]	Relative Mean Power [dB]
0	0	0	0	0	0	0	0
976	-10	976	0	260	-3	976	0
		12000	0	521	-6		
				781	-9		

**Table D.2.2.1A: Propagation Conditions for Multi-Path Fading Environments for HSDPA Performance Requirements**

ITU Pedestrian A Speed 3km/h (PA3)		ITU Pedestrian B Speed 3Km/h (PB3)		ITU vehicular A Speed 30km/h (VA30)		ITU vehicular A Speed 120km/h (VA120)	
Relative Delay [ns]	Relative Mean Power [dB]	Relative Delay [ns]	Relative Mean Power [dB]	Relative Delay [ns]	Relative Mean Power [dB]	Relative Delay [ns]	Relative Mean Power [dB]
0	0	0	0	0	0	0	0
110	-9.7	200	-0.9	310	-1.0	310	-1.0
190	-19.2	800	-4.9	710	-9.0	710	-9.0
410	-22.8	1200	-8.0	1090	-10.0	1090	-10.0
		2300	-7.8	1730	-15.0	1730	-15.0
		3700	-23.9	2510	-20	2510	-20

**Table D.2.2.1B: Propagation Conditions for Multi-Path Fading Environments for MTCH and MCCH Performance Requirements under an extended delay spread environment**

Extended Delay Spread Speed 3km/h (EDS)	
Relative Delay [ns]	Relative Mean Power [dB]
0	0
310	-1
710	-9
1090	-10
1730	-15
2510	-20
12490	-10
12800	-11
13200	-19
13580	-20
14220	-25
15000	-30
27490	-20
27800	-21
28200	-29
28580	-30
29220	-35
30000	-40

### D.2.2.2 1,28 Mcps TDD Option

Table D2.2.2 shows propagation conditions that are used for the performance measurements in multi-path fading environment. All taps have classical Doppler spectrum.

**Table D.2.2.2.1 : 1,28Mcps Propagation Conditions for Multi-Path Fading Environments**

Case 1		Case 2		Case 3	
Speed for operating band a, b, c, f: 3km/h		Speed for operating band a, b, c, f: 3km/h		Speed for operating band a, b, c, f: 120km/h	
Speed for operating band d: 2.3km/h		Speed for operating band d: 2.3km/h		Speed for operating band d: 92km/h	
Speed for operating band e: 2.6km/h		Speed for operating band e: 2.6km/h		Speed for operating band e: 102km/h	
Relative Delay [ns]	Relative Mean Power [dB]	Relative Delay [ns]	Relative Mean Power [dB]	Relative Delay [ns]	Relative Mean Power [dB]
0	0	0	0	0	0
2928	-10	2928	0	781	-3
		12000	0	1563	-6
				2344	-9

**Table D.2.2.2.2: 1,28Mcps Propagation Conditions for Multi-Path Fading Environments for HSDPA Performance Requirements**

ITU Pedestrian A (PA3)		ITU Pedestrian B (PB3)		ITU vehicular A (VA30)		ITU vehicular A (VA120)	
Speed for operating band a, b, c, f: 3km/h		Speed for operating band a, b, c, f: 3km/h		Speed for operating band a, b, c, f: 30km/h		Speed for operating band a, b, c, f: 120km/h	
Speed for operating band d: 2.3km/h		Speed for operating band d: 2.3km/h		Speed for operating band d: 23km/h		Speed for operating band d: 92km/h	
Speed for operating band e: 2.6km/h		Speed for operating band e: 2.6km/h		Speed for operating band e: 26km/h		Speed for operating band e: 102km/h	
Relative Delay [ns]	Relative Mean Power [dB]	Relative Delay [ns]	Relative Mean Power [dB]	Relative Delay [ns]	Relative Mean Power [dB]	Relative Delay [ns]	Relative Mean Power [dB]
0	0	0	0	0	0	0	0
110	-9.7	200	-0.9	310	-1.0	310	-1.0
190	-19.2	800	-4.9	710	-9.0	710	-9.0
410	-22.8	1200	-8.0	1090	-10.0	1090	-10.0
		2300	-7.8	1730	-15.0	1730	-15.0
		3700	-23.9	2510	-20	2510	-20

**Table D.2.2.2.3: Propagation Conditions for Multi-Path Fading Environments for MBSFN Demodulation Performance Requirements**

MBSFN model 1		MBSFN channel model 2	
Speed for Band a, b, c 30 km/h		Speed for Band a, b, c 30 km/h	
Speed for Band d: 23 km/h		Speed for Band d: 23 km/h	
Speed for Band e: 26 km/h		Speed for Band e: 26km/h	
Relative Delay [ns]	Relative Mean Power [dB]	Relative Delay [ns]	Relative Mean Power [dB]
0	0.0	0	0.0
310	-1.0	310	-1.0
710	-9.0	710	-9.0
1090	-10.0	1090	-10.0
1730	-15.0	1730	-15.0
2510	-20.0	2510	-20.0
2734	-6.6	5859	-6.8
3044	-7.6	6169	-7.8
3444	-15.6	6569	-15.8
3824	-16.6	6949	-16.8
4464	-21.6	7589	-21.8
5469	-8.5	10938	-13.3
5779	-9.5	11248	-14.3
6179	-17.5	11648	-22.3
6559	-18.5	12028	-23.3
8428	-12.6	15459	-15.0
8738	-13.6	15769	-16.0
9138	-21.6	16169	-24.0

NOTE: D.2.2.2.3 shows propagation conditions that are used for MBSFN demodulation performance measurements in multi-path fading environment. All taps have classical Doppler spectrum.

In the case of Rx diversity, the fading of the signals and the AWGN signals provided in each receiver antenna port shall be independent.

### D.2.2.3 7,68 Mcps TDD Option

Tables D.2.2.3.1 and D.2.2.3.2 shows propagation conditions that are used for the performance measurements in multi-path fading environment for frequency bands a, b and c in section 4.2. All taps have classical Doppler spectrum.

**Table D.2.2.3.1: Propagation Conditions for Multi path Fading Environments for operations referenced in 4.2 a), 4.2 b) and 4.2 c)**

Case 1 speed 3km/h		Case 2 speed 3 km/h		Case 3 speed 120 km/h		CASE 4 speed 50 km/h *	
Relative Delay [ns]	Relative Mean Power [dB]	Relative Delay [ns]	Relative Mean Power [dB]	Relative Delay [ns]	Relative Mean Power [dB]	Relative Delay [ns]	Relative Mean Power [dB]
0	0	0	0	0	0	0	0
976	-10	976	0	260	-3	976	-10
		12000	0	521	-6		
				781	-9		

**Table D.2.2.3.2: Propagation Conditions for Multi-Path Fading Environments for HSDPA Performance Requirements for operations referenced in 4.2 a), 4.2 b) and 4.2 c)**

ITU Pedestrian A Speed 3km/h (PA3)		ITU Pedestrian B Speed 3Km/h (PB3)		ITU vehicular A Speed 30km/h (VA30)		ITU vehicular A Speed 120km/h (VA120)	
Relative Delay [ns]	Relative Mean Power [dB]	Relative Delay [ns]	Relative Mean Power [dB]	Relative Delay [ns]	Relative Mean Power [dB]	Relative Delay [ns]	Relative Mean Power [dB]
0	0	0	0	0	0	0	0
110	-9.7	200	-0.9	310	-1.0	310	-1.0
190	-19.2	800	-4.9	710	-9.0	710	-9.0
410	-22.8	1200	-8.0	1090	-10.0	1090	-10.0
		2300	-7.8	1730	-15.0	1730	-15.0
		3700	-23.9	2510	-20	2510	-20

Tables D.2.2.3.3 and D.2.2.3.4 shows propagation conditions that are used for the performance measurements in multi-path fading environment for frequency band d in section 4.2.

**Table D.2.2.3.3: Propagation Conditions for Multi path Fading Environments for operations referenced in 4.2 d)**

Case 1 speed 2.3km/h		Case 2 speed 2.3 km/h		Case 3 speed 92 km/h		Case 4 speed 38 km/h *	
Relative Delay [ns]	Relative Mean Power [dB]	Relative Delay [ns]	Relative Mean Power [dB]	Relative Delay [ns]	Relative Mean Power [dB]	Relative Delay [ns]	Relative Mean Power [dB]
0	0	0	0	0	0	0	0
976	-10	976	0	260	-3	976	-10
		12000	0	521	-6		
				781	-9		

**Table D.2.2.3.4: Propagation Conditions for Multi-Path Fading Environments for HSDPA Performance Requirements for operations referenced in 4.2 d)**

ITU Pedestrian A Speed 2.3km/h (PA3)		ITU Pedestrian B Speed 2.3Km/h (PB3)		ITU vehicular A Speed 23 km/h (VA30)		ITU vehicular A Speed 92 km/h (VA120)	
Relative Delay [ns]	Relative Mean Power [dB]	Relative Delay [ns]	Relative Mean Power [dB]	Relative Delay [ns]	Relative Mean Power [dB]	Relative Delay [ns]	Relative Mean Power [dB]
0	0	0	0	0	0	0	0
110	-9.7	200	-0.9	310	-1.0	310	-1.0
190	-19.2	800	-4.9	710	-9.0	710	-9.0
410	-22.8	1200	-8.0	1090	-10.0	1090	-10.0
		2300	-7.8	1730	-15.0	1730	-15.0
		3700	-23.9	2510	-20	2510	-20

**Table D.2.2.3.5: Propagation Conditions for Multi-Path Fading Environments for MTCH and MCCH Performance Requirements under an extended delay spread environment**

Extended Delay Spread			
Operations referenced in 4.2 a), 4.2 b) and 4.2 c) Speed 3km/h (EDS)		Operations referenced in 4.2 d) Speed 2.3km/h (EDS)	
Relative Delay [ns]	Relative Mean Power [dB]	Relative Delay [ns]	Relative Mean Power [dB]
0	0	0	0
310	-1	310	-1
710	-9	710	-9
1090	-10	1090	-10
1730	-15	1730	-15
2510	-20	2510	-20
12490	-10	12490	-10
12800	-11	12800	-11
13200	-19	13200	-19
13580	-20	13580	-20
14220	-25	14220	-25
15000	-30	15000	-30
27490	-20	27490	-20
27800	-21	27800	-21
28200	-29	28200	-29
28580	-30	28580	-30
29220	-35	29220	-35
30000	-40	30000	-40

### D.2.3 Moving propagation conditions

The dynamic propagation conditions for the test of the baseband performance are non fading channel models with two taps. The moving propagation condition has two taps, one static, Path0, and one moving, Path1. The time difference between the two paths is according Equation D.2.3.1. The taps have equal strengths and equal phases.

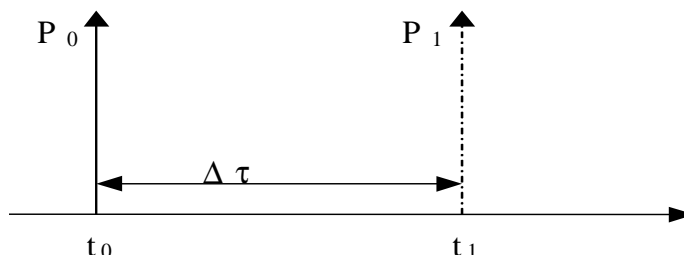

**Figure D.2.3.1: The moving propagation conditions**

$$\Delta\tau = B + \frac{A}{2}(1 + \sin(\Delta\omega \cdot t))$$

**Equation D.2.3.1**



The parameters in the equation are shown in.

A	5 $\mu$ s
B	1 $\mu$ s
$\Delta\omega$	$40 \cdot 10^{-3} \text{ s}^{-1}$

### D.2.4 Birth-Death propagation conditions

The dynamic propagation conditions for the test of the baseband performance is a non fading propagation channel with two taps. The moving propagation condition has two taps, Path1 and Path2 while alternate between 'birth' and 'death'. The positions the paths appear are randomly selected with an equal probability rate and are shown in figure D.2.4.1.

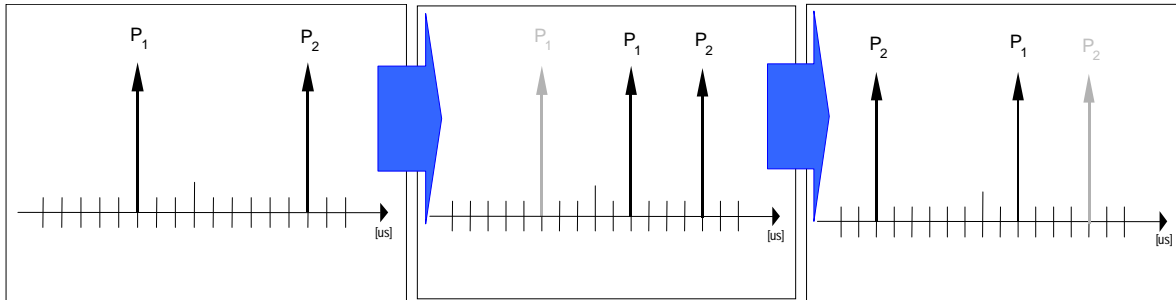

Figure D.2.4.1: Birth death propagation sequence

NOTE 1: Two paths, Path1 and Path2 are randomly selected from the group [-3, -2, -1, 0, 1, 2, 3] chip. The paths have equal strengths and equal phases.

NOTE 2: After 191 ms, Path1 vanishes and reappears immediately at a new location randomly selected from the group [-3, -2, -1, 0, 1, 2, 3]chip but excludes the point Path2.

NOTE 3: After additional 191 ms, Path2 vanishes and reappears immediately at a new location randomly selected from the group [-3, -2, -1, 0, 1, 2, 3] chip but excludes the point Path1.

NOTE 4: The sequence in 2) and 3) is repeated.

#### D.2.4A High speed train condition

The high speed train condition for the test of the baseband performance is a non fading propagation channel with one tap. Doppler shift is given by

$$f_s(t) = f_d \cos \theta(t) \tag{D.2.4A.1}$$

where  $f_s(t)$  is the Doppler shift and  $f_d$  is the maximum Doppler frequency. The cosine of angle  $\theta(t)$  is given by

$$\cos \theta(t) = \frac{D_s/2 - vt}{\sqrt{D_{\min}^2 + (D_s/2 - vt)^2}}, \quad 0 \leq t \leq D_s/v \tag{D.2.4A.2}$$

$$\cos \theta(t) = \frac{-1.5D_s + vt}{\sqrt{D_{\min}^2 + (-1.5D_s + vt)^2}}, \quad D_s/v < t \leq 2D_s/v \tag{D.2.4A.3}$$

$$\cos \theta(t) = \cos \theta(t \bmod (2D_s/v)), \quad t > 2D_s/v \tag{D.2.4A.4}$$

where  $D_s/2$  is the initial distance of the train from BS, and  $D_{min}$  is BS-Railway track distance, both in meters;  $v$  is the velocity of the train in m/s,  $t$  is time in seconds.

Doppler shift and cosine angle is given by equation D.2.4A.1 and D.2.4A.2-D.2.4A.4 respectively, where the required input parameters listed in table D.2.4A.1 and the resulting Doppler shift shown in Figure D.2.4A.1 are applied for all frequency bands.

**Table D.2.4A.1**

Parameter	Value
$D_s$	300 m
$D_{min}$	2 m
$v$	300 km/h
$f_d$	560 Hz

NOTE1: Parameters for HST conditions in table D.2.4A.1 including  $f_d$  and Doppler shift trajectories presented on figure D.2.4A.1 were derived for Band a).

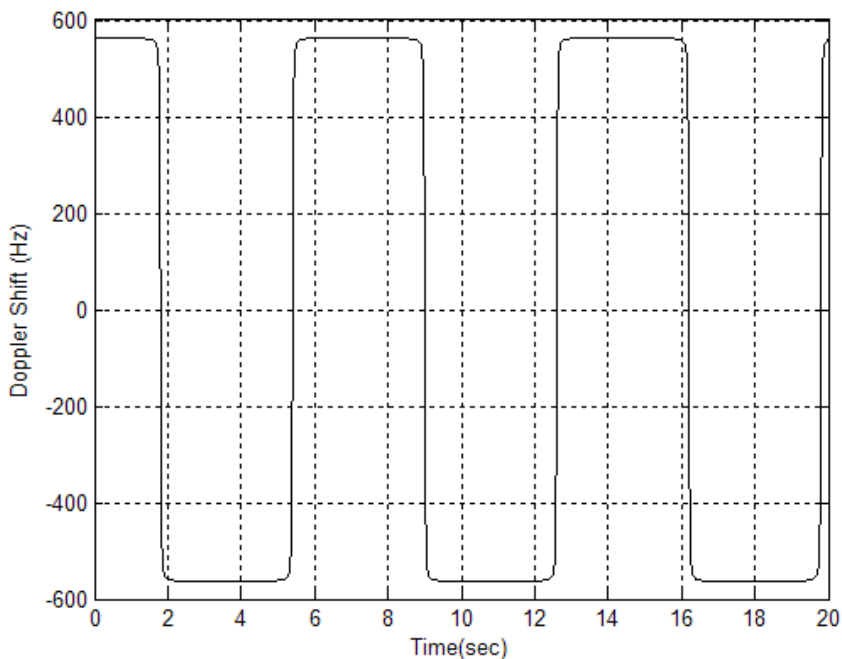

**Figure D.2.4A.1: Doppler shift trajectory**

## D.2.5 Multi-path fading propagation conditions

### D.2.5.1 3.84 Mcps TDD Option

<void>

### D.2.5.1 1.28 Mcps TDD Option

MIMO propagation conditions are defined for a 2x2 antenna configuration. The resulting propagation channel shall be characterized by a complex 2x2 matrix termed

$$\mathbf{H} = \begin{pmatrix} h_{11} & h_{12} \\ h_{21} & h_{22} \end{pmatrix}$$

### D.2.5.1.1 MIMO Dual Stream Static Orthogonal Conditions

The channel coefficients of the resulting propagation channel under MIMO dual stream conditions shall be given by

$$\mathbf{H} = \begin{pmatrix} h_{11} & h_{12} \\ h_{21} & h_{22} \end{pmatrix} = \begin{pmatrix} 1 & 1 \\ 1 & -1 \end{pmatrix}$$

The generation of the resulting channel coefficients for MIMO dual stream conditions and the association with the transmitter and receiver ports are depicted Figure D.2.5.1.1. Figure D.2.5.1.1 does not restrict test system implementation.

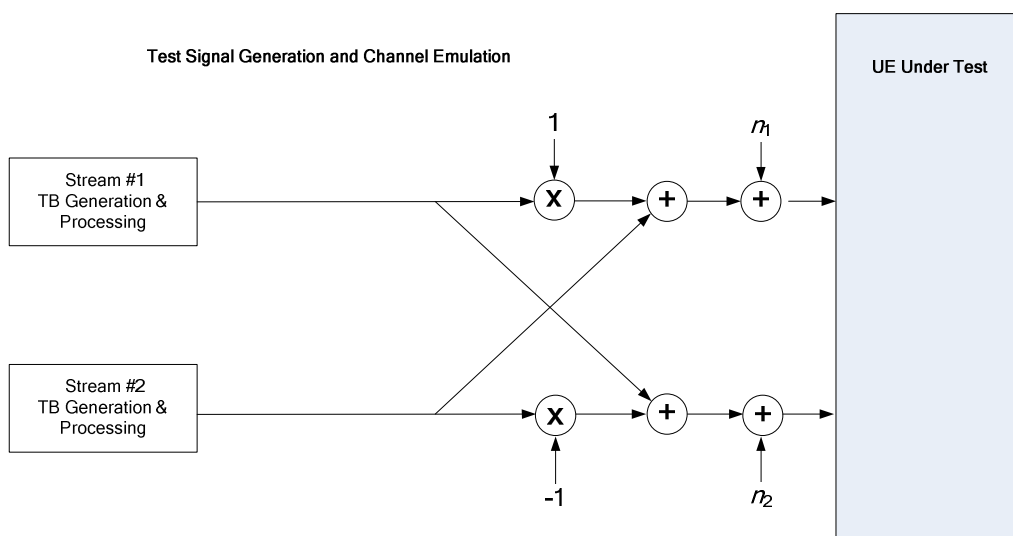

Figure D.2.5.1.1: Test setup under MIMO Dual Stream Static Orthogonal Conditions

### D.2.5.1 7.68 Mcps TDD Option

<void>

## Annex E (normative): Common RF test conditions

### E.1 General

This normative annex specifies the common RF test conditions that are needed for setting a connection and channels that are needed during a connection.

### E.2 Connection Set-up

Table E.2 describes the downlink Physical Channels that are required for connection set up.

**Table E.2: Downlink Physical Channels required for connection set-up**

Physical Channel
PSCH
PCCPCH
DPCH
PICH

### E.3 During connection

The following clauses describes the uplink and downlink Physical Channels that are transmitted during a connection i.e., when measurements are done.

#### E.3.1 Measurement of Tx Characteristics

Table E.3.1 is applicable for measurements on the Transmitter Characteristics (Clause 5) with the exception of clause 5.2 (UE maximum output power), 5.3 (Frequency Stability), 5.4.1 (Uplink Power Control). For these cases certain parameters are defined individually.

**Table E.3.1.1: Common downlink test condition RF parameters**

Physical Channel	Power
DPCH	-93 dBm Data content PRBS
PSCH	TBD
PCCPCH	TBD
PICH	TBD
OCNS	Nothing

**Table E.3.1.2: Common TX test parameters**

Parameter	Value/description
UL Reference measurement channel	12,2kbps, according to annex C.2.1
Uplink Power Control	SS level and signalling values such that UE transmits maximum power.
Data content	real life (sufficient irregular)

## E.3.2 Measurement of Rx Characteristics

Table E.3.2 is applicable for measurements on the Receiver Characteristics (Clause 6)

**Table E.3.2: Downlink Physical Channels transmitted during a connection.**

Physical Channel	Power
CPICH	TBD
PCCPCH	TBD
SCH	TBD
PICH	TBD
DPCH	TBD

## E.3.3 Measurement of Performance requirements

Table E.3.3 is applicable for measurements on the Performance requirements (Clause 7)

**Table E.3.3: Downlink Physical Channels transmitted during a connection.**

Physical Channel	Power	Note
CPICH	TBD	
PCCPCH	TBD	
SCH	TBD	
PICH	TBD	
DPCH	TBD	
OCNS	TBD	

---

## Annex F (normative): General test conditions and declarations

The requirements of this clause apply to all applicable tests in the present document.

Many of the tests in the present document measure a parameter relative to a value that is not fully specified in the UE specifications. For these tests, the Minimum Requirement is determined relative to a nominal value specified by the manufacturer.

When specified in a test, the manufacturer shall declare the nominal value of a parameter, or whether an option is supported.

.In all the relevant clauses in this clause all Bit Error Ratio (BER), Block Error Ratio (BLER) measurements shall be carried out according to the general rules for statistical testing in annex F.6.

---

### F.1 Acceptable uncertainty of Test System

The maximum acceptable uncertainty of the Test System is specified below for each test, where appropriate. The Test System shall enable the stimulus signals in the test case to be adjusted to within the specified range, and the equipment under test to be measured with an uncertainty not exceeding the specified values. All tolerances and uncertainties are absolute values, and are valid for a confidence level of 95 %, unless otherwise stated.

A confidence level of 95% is the measurement uncertainty tolerance interval for a specific measurement that contains 95% of the performance of a population of test equipment.

For RF tests it should be noted that the uncertainties in clause F.1 apply to the Test System operating into a nominal 50 ohm load and do not include system effects due to mismatch between the DUT and the Test System.

#### F.1.1 Measurement of test environments

The measurement accuracy of the UE test environments defined in Annex G, Test environments shall be.

- Pressure  $\pm 5$  kPa.
- Temperature  $\pm 2$  degrees.
- Relative Humidity  $\pm 5$  %.
- DC Voltage  $\pm 1,0$  %.
- AC Voltage  $\pm 1,5$  %.
- Vibration 10 %.
- Vibration frequency 0,1 Hz.

The above values shall apply unless the test environment is otherwise controlled and the specification for the control of the test environment specifies the uncertainty for the parameter.

## F.1.2 Measurement of transmitter

**Table F.1.2: Maximum Test System Uncertainty for transmitter tests**

Clause	Maximum Test System Uncertainty
5.2 UE Maximum Output Power	$\pm 0.7$ dB
5.3 Frequency Stability	$\pm 10$ Hz
5.4.1 Uplink power control	Relative $\pm [0.3]$ dB
5.4.2 Minimum Transmit Power	$\pm 1.0$ dB
5.4.3 Transmit OFF Power	$\pm 1.5$ dB
5.4.4 Transmit ON/OFF Power	TBD
5.4.5 Out-of-synchronisation handling of output power	$\pm 0,4$ dB
5.5.1 Occupied Bandwidth	$\pm 100$ kHz
5.5.2.1 Spectrum emission mask	$\pm 1.5$ dB
5.5.2.2 ACLR	$\pm 0,8$ dB
5.5.3 Spurious emissions	$\pm 2.0$ dB for UE and coexistence bands for results $> -60$ dBm $\pm 3.0$ dB for results $< -60$ dBm Outside above: $f \leq 2.2$ GHz : $\pm 1.5$ dB $2.2$ GHz $< f \leq 4$ GHz : $\pm 2.0$ dB $f > 4$ GHz : $\pm 4.0$ dB
5.6 Transmit intermodulation:	Will be based on BS, need to work out freq and level ranges.
5.7.1 Transmit modulation: EVM	$\pm 2.5$ %
5.7.2 Transmit modulation: peak code domain error	$\pm 1$ dB

## F.1.3 Measurement of receiver

**Table F.1.3 Maximum Test System Uncertainty for receiver tests**

Clause	Maximum Test System Uncertainty
6.2 Reference Sensitivity Level	± 0.7 dB
6.3 maximum input level:	TBD
6.4 Adjacent Channel Selectivity (ACS)	Overall system uncertainty ± 1.1 dB
6.5 Blocking Characteristics (3,84 Mcps TDD option)	Using ± 0.7 dB for signal and interferer as currently defined, and 68 dB ACLR @ 10 MHz. System error with f < 15 MHz offset: ± 1.4 dB  f ≥ 15 MHz offset and f ≤ 2.2 GHz: ± 1.0 dB 2.2 GHz < f ≤ 4 GHz : ±1.7 dB f > 4 GHz: ±3.1 dB
6.5 Blocking Characteristics (1,28 Mcps TDD option)	Using ± 0.7 dB for signal and interferer as currently defined, and 68 dB ACLR @ 3,2 MHz. System error with f < 4,8 MHz offset: ± 1.4 dB  f ≥ 4,8 MHz offset and f ≤ 2.2 GHz: ± 1.0 dB 2.2 GHz < f ≤ 4 GHz : ±1.7 dB f > 4 GHz: ±3.1 dB
6.6 Spurious Response	f < 2.2 GHz: ±1.0dB 2.2 < f < 4GHz: ±1.7dB f > 4 GHz: ±3.1dB
6.7 Intermodulation Characteristics	± 1.3 dB  with Formula = $\sqrt{(2 \cdot CW\_level\_error)^2 + (mod\_level\_error)^2 + (wanted\_signal\_level\_error)^2}$ (Using CW interferer ±0.5 dB, modulated interferer ±0.5 dB, wanted signal ±0.7 dB)
6.8 Spurious Emissions	± 3.0 dB for UE receive band Outside above: f ≤ 2.2GHz : ± 2.0dB 2.2 GHz < f ≤ 4 GHz : ± 2.0 dB f > 4 GHz : ±4.0 dB

## F.1.4 Performance requirement

**Table F.1.4 Maximum Test System Uncertainty for Performance Requirements**

Clause	Maximum Test System Uncertainty
7.6 Uplink Power Control	0.3 dB (relative tolerance for 10 dB stepsize)

## F.1.5 Requirements for support of RRM

TBD



## F.1.6 Performance requirement (HSDPA)

Table F.1.6: Maximum Test System Uncertainty for Performance Requirements (HSDPA)

Clause	Maximum Test System Uncertainty	Derivation of Test System Uncertainty
9.3.1 HS-DSCH throughput for Fixed Reference Channels	$\hat{I}_{or}/I_{oc}$ $\pm 0.6$ dB $I_{oc}$ $\pm 1.0$ dB $\frac{E_c}{I_{or}}$ $\pm 0.1$ dB	0.1 dB uncertainty in $E_c/I_{or}$ ratio  Worst case gain uncertainty due to the fader from the calibrated static profile is $\pm 0.5$ dB per output  In addition the same $\pm 0.3$ dB $\hat{I}_{or}/I_{oc}$ ratio error as 7.2.  These are uncorrelated so can be RSS.  Overall error in $\hat{I}_{or}/I_{oc}$ is $(0.5^2 + 0.3^2)^{0.5} = 0.6$ dB
9.3.2 HS-DSCH throughput for Variable Reference Channels	Same as 9.3.1	Same as 9.3.1
9.3.3 Reporting of HS-DSCH Channel Quality Indicator	No test system uncertainty applied	
9.3.4 HS-SCCH Detection Performance	Same as 9.3.1	Same as 9.3.1

## F.2 Test Tolerances (This clause is informative)

The Test Tolerances defined in this clause have been used to relax the Minimum Requirements in the present document to derive the Test Requirements.

The Test Tolerances are derived from Test System uncertainties, regulatory requirements and criticality to system performance. As a result, the Test Tolerances may sometimes be set to zero.

The test tolerances should not be modified for any reason e.g. to take account of commonly known test system errors (such as mismatch, cable loss, etc.).

## F.2.1 Transmitter

**Table F.2.1 Test Tolerances for transmitter tests.**

Clause	Test Tolerance
5.2 Maximum Output Power	0,7 dB
5.3 UE Frequency Stability	10 Hz
5.4.1.1 Uplink Power Control, Initial Accuracy	+1,0 dB
5.4.1.2 Uplink Power Control, differential Accuracy	1dB step: 0,1 dB 2 dB step: 0,15 dB 3dB step: 0,2 dB 10 dB step: 0,5 dB 20 dB step: 0,7 dB 30 dB step: 0,7 dB >30 dB step: 1,0 dB
5.4.1.3 Open Loop Power Control	+1,0 dB
5.4.2 Minimum Transmit Power	1,0 dB
5.4.5 Out-of-synchronisation handling of output power: $\frac{\Sigma DPCH - E_c}{I_{or}}$	0,4 dB
5.4.5 Out-of-synchronisation handling of output power: transmit ON/OFF time	0 ms
5.5.1 Transmit OFF power	1,5 dB
5.5.1 Occupied Bandwidth	0 kHz
5.5.2.1 Spectrum emission mask	1,5 dB
5.5.2.2 Adjacent Channel Leakage Power Ratio (ACLR)	0.8 dB
5.5.3 Spurious Emissions	0 dB
5.6 Transmit Intermodulation	0 dB
5.7.1 Error Vector Magnitude	0%
5.7.2 Peak code domain error	1,0 dB

NOTE: Unless explicitly specified test tolerances are set to be equal in the case of 3,84 Mcps TDD Option as well as in the case of 1,28 Mcps TDD Option.

## F.2.2 Receiver

**Table F.2.2 Test Tolerances for receiver tests.**

Clause	Test Tolerance
6.2 Reference sensitivity level	0.7 dB
6.4 Adjacent channel selectivity	0 dB
6.5 Blocking characteristics	0 dB
6.6 Spurious Response	0 dB
6.7 Intermodulation Characteristics	0 dB
6.8 Spurious emissions	0 dB

NOTE: Unless explicitly specified test tolerances are set to be equal in the case of 3,84 Mcps TDD Option as well as in the case of 1,28 Mcps TDD Option.

## F.2.3 Performance requirements

**Table F.2.3 Test Tolerances for Performance Requirements.**

Clause	Test Tolerance
7.2, Demodulation in Static Propagation Condition	0.3 dB for $\hat{I}_{or}/I_{oc}$
7.3, Demodulation of DCH in Multiplath Fading conditions	0.6 dB for $\hat{I}_{or}/I_{oc}$
7.3A Demodulation of DCH in high speed train conditions	0.6 dB for $\hat{I}_{or}/I_{oc}$
7.4, Base Station Transmit diversity modes	0.8 dB for $\hat{I}_{or}/I_{oc}$
7.6 Uplink Power Control	0.5 dB (relative tolerance for 10 dB stepsize)

## F.2.4 Requirements for support of RRM

### F.2.4.1 TDD/TDD Cell Reselection on intra-frequency cells

#### F.2.4.1.1 3,84 Mcps TDD Option

Void.

#### F.2.4.1.2 1,28 Mcps Option

The test tolerances TT1 and TT2 given in table 8.2.3.1.5.2 shall not exceed [0,2 dB] for the interacting cells 1, 2 and [0,7 dB] for the additional (e.g. noninteracting) cells 3-6, respectively with a DRX cycle length given in table F.2.4.1A.

**Table F.2.4.1A:  $T_{\text{measureNTDD}}$ ,  $T_{\text{evaluateNTDD}}$ ,  $T_{\text{measureTDD}}$ ,  $T_{\text{evaluateTDD}}$ ,  $T_{\text{measureFDD}}$ ,  $T_{\text{evaluateFDD}}$  and  $T_{\text{measureGSM}}$  (1,28 Mcps TDD Option)**

DRX cycle length [s]	$N_{\text{serv}}$ [number of successive measurements]	$T_{\text{measureTD}} [s]$ (number of DRX cycles)	$T_{\text{evaluateTD}} [s]$ (number of DRX cycles)	$T_{\text{measureD}} [s]$ (number of DRX cycles)	$T_{\text{evaluateD}} [s]$ (number of DRX cycles)
0,08	4	0,64 (8 DRX cycles)	2,56 (32 DRX cycles)	0,64 (8 DRX cycles)	2,56 (32 DRX cycles)
0,16	4	0,64 (4)	2,56 (16)	0,64 (4)	2,56 (16)
0,32	4	1,28 (4)	5,12 (16)	1,28 (4)	5,12 (16)
0,64	4	1,28 (2)	5,12 (8)	1,28 (2)	5,12 (8)
1,28	2	1,28 (1)	6,4 (5)	1,28 (1)	6,4 (5)
2,56	2	2,56 (1)	7,68 (3)	2,56 (1)	7,68 (3)
5,12	1	5,12 (1)	10,24 (2)	5,12 (1)	10,24 (2)

NOTE: In idle mode, UE shall support DRX cycles lengths 0.64, 1,28, 2.56 and 5.12 s.

#### F.2.4.1.3 7,68 Mcps TDD Option

Void

## F.2.5 Performance requirements (HSDPA)

**Table F.2.5: Test Tolerances for Performance Requirements (HSDPA).**

Clause	Test Tolerance
9.3.1 HS-DSCH throughput for Fixed Reference Channels	0.6 dB for $\hat{I}_{or}/I_{oc}$ 0.1 dB for $E_c/I_{or}$
9.3.2 HS-DSCH throughput for Variable Reference Channels	Same as 9.3.1
9.3.3 Reporting of HS-DSCH Channel Quality Indicator	No test tolerances applied
9.3.4 HS-SCCH Detection Performance	Same as 9.3.1

---

## F.3 Interpretation of measurement results

The measurement results returned by the Test System are compared - without any modification - against the Test Requirements as defined by the shared risk principle.

The Shared Risk principle is defined in ETR 273 Part 1 sub-part 2 clause 6.5.

The actual measurement uncertainty of the Test System for the measurement of each parameter shall be included in the test report.

The recorded value for the Test System uncertainty shall be, for each measurement, equal to or lower than the appropriate figure in clause F.1 of the present document.

If the Test System for a test is known to have a measurement uncertainty greater than that specified in clause F.1, it is still permitted to use this apparatus provided that an adjustment is made value as follows.

Any additional uncertainty in the Test System over and above that specified in clause F.1 shall be used to tighten the Test Requirement – making the test harder to pass. (For some tests e.g. receiver tests, this may require modification of stimulus signals). This procedure will ensure that a Test System not compliant with clause F.1 does not increase the chance of passing a device under test where that device would otherwise have failed the test if a Test System compliant with clause F.1 had been used.

---

## F.4 Derivation of Test Requirements (This clause is informative)

The Test Requirements in the present document have been calculated by relaxing the Minimum Requirements of the core specification using the Test Tolerances defined in clause F.2. When the Test Tolerance is zero, the Test Requirement will be the same as the Minimum Requirement. When the Test Tolerance is non-zero, the Test Requirements will differ from the Minimum Requirements, and the formula used for this relaxation is given in table F.4.

## F.4.1 3.84Mcps TDD Option

Table F.4.1 Derivation of Test Requirements

Test	Minimum Requirement in TS 25.102	Test Tolerance (TT)	Test Requirement in TS 34.122																								
5.2 Maximum Output Power	Power single code Power class 1 (30 dBm) Tolerance = +1/-3 dB Power class 2 (24 dBm) Tolerance = +1/-3 dB Power class 3 (21 dBm) Tolerance = +2/-2 dB Power multi code Power class 2 (21 dBm) Tolerance = +1/-3 dB Power class 3 (18 dBm) Tolerance = ±2 dB Power class 4 (10 dBm) Tolerance = ± 4 dB	0.7 dB	Formula: Upper Tolerance limit + TT Lower Tolerance limit – TT For power classes 1 and 2 (single and multi): Upper Tolerance limit = +1.7 dB Lower Tolerance limit = -3.7 dB For power class 3 (single and multi): Upper Tolerance limit = +2.7 dB Lower Tolerance limit = -2.7 dB For power class 4 (single and multi) Upper Tolerance limit = +4.7 dB Lower Tolerance limit = -4.7 dB																								
5.3 UE Frequency Stability	The UE modulated carrier frequency shall be accurate to within ±0.1 ppm compared to the carrier frequency received from the Node B.	10 Hz	Formula: modulated carrier frequency error + TT  modulated carrier frequency error = ±(0.1 ppm + 10 Hz).																								
5.4.1.1 Uplink Power Control, Initial accuracy	± 9dB normal conditions ± 12dB extreme conditions	1.0 dB	Formula: Upper Tolerance limit + TT Lower Tolerance limit – TT Nominal expected TX power ± 10dB (normal conditions) ± 13dB (extreme conditions)																								
5.4.1.2 Uplink Power Control, differential accuracy	<table border="0"> <tr> <td>SIR Target</td> <td>Pow Step Tol</td> <td>TT</td> </tr> <tr> <td>&lt;1 dB</td> <td>0.5 dB</td> <td>0.1 dB</td> </tr> <tr> <td>&lt;2dB</td> <td>1 dB</td> <td>0.15 dB</td> </tr> <tr> <td>&lt;3 dB</td> <td>1.5 dB</td> <td>0.2 dB</td> </tr> <tr> <td>&lt;10 dB</td> <td>2 dB</td> <td>0.5 dB</td> </tr> <tr> <td>&lt;20dB</td> <td>4 dB</td> <td>0.7 dB</td> </tr> <tr> <td>&lt;30 dB</td> <td>6 dB</td> <td>0.7 dB</td> </tr> <tr> <td>&gt; 30 dB</td> <td>9 dB</td> <td>1.0 dB</td> </tr> </table>	SIR Target	Pow Step Tol	TT	<1 dB	0.5 dB	0.1 dB	<2dB	1 dB	0.15 dB	<3 dB	1.5 dB	0.2 dB	<10 dB	2 dB	0.5 dB	<20dB	4 dB	0.7 dB	<30 dB	6 dB	0.7 dB	> 30 dB	9 dB	1.0 dB		Formula: Upper Tolerance limit + TT Lower Tolerance limit – TT
SIR Target	Pow Step Tol	TT																									
<1 dB	0.5 dB	0.1 dB																									
<2dB	1 dB	0.15 dB																									
<3 dB	1.5 dB	0.2 dB																									
<10 dB	2 dB	0.5 dB																									
<20dB	4 dB	0.7 dB																									
<30 dB	6 dB	0.7 dB																									
> 30 dB	9 dB	1.0 dB																									
5.4.1.3 Open Loop Power Control	± 9dB normal conditions ± 12dB extreme conditions	1.0 dB	Formula: Upper Tolerance limit + TT Lower Tolerance limit – TT Nominal expected TX power ± 10dB (normal conditions) ± 13dB (extreme conditions)																								
5.4.2 Minimum Transmit Power	UE minimum transmit power shall be less than –44 dBm	1.0 dB	Formula: UE minimum transmit power + TT UE minimum transmit power = –43 dBm																								

<p>5.4.5 Out-of-synchronisation handling of output power:</p>	<p><math>\frac{\Sigma DPCH\_E_c}{I_{or}}</math> levels before A -4.6 dB AB: -10 dB BD: -16 dB DE: -12 dB EF: -6 dB transmit ON/OFF time 200ms</p>	<p>0,4 dB for <math>\frac{\Sigma DPCH\_E_c}{I_{or}}</math> 0 ms for timing measurement</p>	<p>Formulas: Ratio between A and B + TT Ratio between B and D - TT Ratio between D and E - TT Ratio between E and F + TT transmit ON/OFF time + TT timing</p> <p><math>\frac{\Sigma DPCH\_E_c}{I_{or}}</math> levels: Before A: -4.6 AB: -10 + 0,4 dB BD: -16 - 0,4 dB DE: -12 - 0,4 dB EF: -6 + 0,4 dB Uncertainty of OFF power measurement is handled by Transmit OFF power test and uncertainty of ON power measurement is handled by Minimum output power test.transmit ON/OFF time 200ms</p>		
<p>5.5.1 Transmit OFF power</p>	<p>Transmit OFF power shall be less than -65 dBm</p>	<p>1.5 dB</p>	<p>Formula: Transmit OFF power + TT Transmit OFF power = -63.5 dBm</p>		
<p>5.5.1 Occupied Bandwidth</p>	<p>The occupied channel bandwidth shall be less than 5 MHz based on a chip rate of 3,84 Mcps.</p>	<p>0 kHz</p>	<p>Formula: occupied channel bandwidth: + TT occupied channel bandwidth = 5.0 MHz</p>		
<p>5.5.2.1 Spectrum emission mask</p>	<p>Minimum requirement defined in TS25.101 table 6.10. The lower limit shall be -50 dBm / 3,84 MHz or which ever is higher.</p>	<p>1.5 dB</p>	<p>Formula: Minimum requirement + TT Lower limit + TT Add 1.5 to Minimum requirement entries in TS25.101 table 6.10 The lower limit shall be -48.5 dBm / 3,84 MHz or which ever is higher.</p>		
<p>5.5.2.2 Adjacent Channel Leakage Power Ratio (ACLR)</p>	<p>Power Classes 2 and 3: UE channel +5 MHz or -5 MHz, ACLR limit: 33 dB UE channel +10 MHz or -10 MHz, ACLR limit: 43 dB</p>	<p>0.8 dB</p>	<p>Formula: ACLR limit - TT Power Classes 2 and 3: UE channel +5 MHz or -5 MHz, ACLR limit: 32.2 dB UE channel +10 MHz or -10 MHz, ACLR limit: 42.2 dB</p>		
<p>5.5.3 Spurious Emissions</p>			<p>Formula: Minimum Requirement+ TT Add zero to all the values of Minimum Requirements in table 5.5.3</p>		
	<p>Frequency Band</p>	<p>Minimum Requirement</p>		<p>Frequency Band</p>	<p>Minimum Requirement</p>
	<p>9 kHz ≤ f &lt; 150 kHz</p>	<p>-36dBm /1kHz</p>	<p>0 dB</p>	<p>9kHz ≤ f &lt; 1GHz</p>	<p>-36dBm /1kHz</p>
	<p>150 kHz ≤ f &lt; 30 MHz</p>	<p>-36dBm /10kHz</p>	<p>0 dB</p>	<p>150 kHz ≤ f &lt; 30 MHz</p>	<p>-36dBm /10kHz</p>
	<p>30 MHz ≤ f &lt; 1000 MHz</p>	<p>-36dBm /100kHz</p>	<p>0 dB</p>	<p>30 MHz ≤ f &lt; 1000 MHz</p>	<p>-36dBm /100kHz</p>
	<p>1 GHz ≤ f &lt; 12.75 GHz</p>	<p>-30dBm /1MHz</p>	<p>0 dB</p>	<p>1 GHz ≤ f &lt; 2.2 GHz</p>	<p>-30dBm /1MHz</p>
<p>0 dB</p>			<p>2.2 GHz ≤ f &lt; 4 GHz</p>	<p>-30dBm /1MHz</p>	
<p>0 dB</p>			<p>4 GHz ≤ f &lt; 12.75 GHz</p>	<p>-30dBm /1MHz</p>	

	925 MHz < f < 935 MHz	-67dBm /100kHz	0 dB	925 MHz < f < 935 MHz	-67dBm /100kHz
	935 MHz ≤ f ≤ 960 MHz	-79dBm /100kHz	0 dB	935 MHz ≤ f ≤ 960 MHz	-79dBm /100kHz
	1805 MHz < f ≤ 1880 MHz	-71dBm /100kHz	0 dB	1805 MHz < f ≤ 1880 MHz	-71dBm /100kHz
	1884.5 MHz ≤ f ≤ 1919.6 MHz	-41dBm* /300kHz	0 dB	1884.5 MHz ≤ f ≤ 1919.6 MHz	-41dBm* /300kHz
5.6 Transmit Intermodulation	Intermodulation Product 5MHz -31 dBc 10MHz -41 dBc		0 dB	Formula: Intermodulation Product + TT Intermodulation Product 5MHz -31 dBc 10MHz -41 dBc	
5.7.1 Error Vector Magnitude	The Error Vector Magnitude shall not exceed 17.5 %		0%	Formula: EVM limit + TT EVM limit = 17.5 %	
5.7.2 Peak code domain error	The peak code domain error shall not exceed -21dB		±1.0 dB	Formula: Peak code domain error + TT Peak code domain error = -20 dB	
6.2 Reference sensitivity level	I <sub>or</sub> = -105 dBm / 3,84 MHz BER limit = 0.001		0.7 dB	Formula: I <sub>or</sub> + T BER limit unchanged  I <sub>or</sub> = -104.3 dBm / 3,84 MHz	
6.4 Adjacent Channel Selectivity	I <sub>or</sub> = -91 dBm / 3,84 MHz I <sub>oac</sub> (modulated) = -52 dBm/3,84 MHz BER limit = 0.001		0 dB	Formula: I <sub>or</sub> unchanged I <sub>oac</sub> - TT BER limit unchanged  I <sub>oac</sub> = -52 dBm/3,84 MHz	
6.5 Blocking Characteristics	See table 6.5.2a and 6.5.2b. in TS34.122 BER limit = 0.001		0 dB	Formula: I <sub>blocking</sub> (modulated) - TT (dBm/3,84MHz) I <sub>blocking</sub> (CW) - TT (dBm) BER limit unchanged	
6.6 Spurious Response	I <sub>blocking</sub> (CW) -44 dBm F <sub>uw</sub> : Spurious response frequencies BER limit = 0.001		0 dB	Formula: I <sub>blocking</sub> (CW) - TT (dBm) F <sub>uw</sub> unchanged BER limit unchanged  I <sub>blocking</sub> (CW) -44 dBm	
6.7 Intermodulation Characteristics	I <sub>ow1</sub> (CW) -46 dBm I <sub>ow2</sub> (modulated) -46 dBm / 3,84 MHz F <sub>uw1</sub> (offset) 10 MHz F <sub>uw2</sub> (offset) 20 MHz  BER limit = 0.001		0 dB	Formula: TBD BER limit unchanged.	
6.8 Spurious Emissions				Formula: Maximum level+ TT Add zero to all the values of Maximum Level in table 6.8.1.	
	Frequency Band	Maximum level		Frequency Band	Maximum level
	9kHz ≤ f < 1GHz	-57dBm /100kHz	0 dB	9kHz ≤ f < 1GHz	-57dBm /100kHz
	1.9-1.92 GHz 2.01-2.025GHz 2.11-2.170GHz	-60 dBm / 3,84MHz	0 dB	1.9-1.92 GHz 2.01-2.025GHz 2.11-2.170GHz	-60 dBm / 3,84MHz
	1 -1.9GHz, 1.92-2.01 GHz 2.025-2.11GHz	-47 dBm/1MHz	0 dB	1 -1.9GHz, 1.92-2.01 GHz 2.025-2.11GHz	-47 dBm/1MHz

	1GHz ≤ f ≤ 12.75GHz		-47dBm /1MHz		0 dB	1GHz ≤ f ≤ 2.2GHz	-47dBm /1MHz	
					0 dB	2.2GHz < f ≤ 4GHz	-47dBm /1MHz	
					0 dB	4GHz < f ≤ 12.75GHz	-47dBm /1MHz	
7.6 Downlink Power Control		TS #1,9	TS #7,14	0.5 dB for 10 dB change in output power, 0 otherwise.	Formula for 10 dB change in transmit power: Upper Tolerance limit + TT Lower Tolerance limit – TT			
	1 <sup>st</sup> frame	15 ±4.0 dBm	5 ±0.5 dBm					
	2 <sup>nd</sup> frame	15 ±4.0 dBm	15 ±4.0 dBm					
9.3.1 HS-DSCH throughput for Fixed Reference Channels	$\frac{E_c}{I_{or}}$ -10,-9.5 dB				0.1 dB for $\frac{E_c}{I_{or}}$	Formulas: $\frac{E_c}{I_{or}} = \text{ratio} + \text{TT}$ $\hat{I}_{or}/I_{oc} = \text{ratio} + \text{TT}$ $I_{OC}$ unchanged		
	$I_{OC} = -60$ dBm				0.6 dB for $\hat{I}_{or}/I_{oc}$			
	$\hat{I}_{or}/I_{oc} = 10$ dB							
9.3.2 HS-DSCH throughput for Variable Reference Channels	$\frac{E_c}{I_{or}}$ -10dB				0.1 dB for $\frac{E_c}{I_{or}}$	Formulas: $\frac{E_c}{I_{or}} = \text{ratio} + \text{TT}$ $\hat{I}_{or}/I_{oc} = \text{ratio} + \text{TT}$ $I_{OC}$ unchanged		
	$I_{OC} = -60$ dBm				0.6 dB for $\hat{I}_{or}/I_{oc}$			
	$\hat{I}_{or}/I_{oc} = 8$ and 10 dB							
9.3.3 Reporting of HS-DSCH Channel Quality Indicator					No test tolerances applied			
9.3.4 HS-SCCH Detection Performance	$\frac{E_c}{I_{or}}$ -10dB				0.1 dB for $\frac{E_c}{I_{or}}$	Formulas: $\frac{E_c}{I_{or}} = \text{ratio} + \text{TT}$ $\hat{I}_{or}/I_{oc} = \text{ratio} + \text{TT}$ $I_{OC}$ unchanged		
	$I_{OC} = -60$ dBm				0.6 dB for $\hat{I}_{or}/I_{oc}$			
	$\hat{I}_{or}/I_{oc} = 12$ and 16 dB							
* Applicable for transmission in 2010-2025 MHz as defined in subclause 4.2 (a).								



## F.4.2 1.28Mcps TDD Option

### F.4.2.1 Transmitter

**Table F.4.2.1 Derivation of Transmitter Test Requirements**

Test	Minimum Requirement in TS 25.102	Test Tolerance (TT)	Test Requirement in TS 34.122																								
5.2 Maximum Output Power	Power single code Power class 1 (33 dBm) Tolerance = +1/-3 dB Power class 2 (24 dBm) Tolerance = +1/-3 dB Power class 3 (21 dBm) Tolerance = +2/-2 dB Power multi code Power class 2 (21 dBm) Tolerance = +1/-3 dB Power class 3 (18 dBm) Tolerance = ±2 dB Power class 4 (27 dBm) Tolerance = +1/-3 dB	0.7 dB	Formula: Upper Tolerance limit + TT Lower Tolerance limit – TT For power classes 1 and 2 (single and multi): Upper Tolerance limit = +1.7 dB Lower Tolerance limit = -3.7 dB For power class 3 (single and multi): Upper Tolerance limit = +2.7 dB Lower Tolerance limit = -2.7 dB For power class 4 (single and multi): Upper Tolerance limit = +1.7 dB Lower Tolerance limit = -3.7 dB																								
5.3 UE Frequency Stability	The UE modulated carrier frequency shall be accurate to within $\pm 0.1$ ppm compared to the carrier frequency received from the Node B.	10 Hz	Formula: modulated carrier frequency error + TT  modulated carrier frequency error = $\pm(0.1 \text{ ppm} + 10 \text{ Hz})$ .																								
5.4.1.1 Uplink Power Control, Initial accuracy	$\pm 9$ dB normal conditions $\pm 12$ dB extreme conditions	1.0 dB	Formula: Upper Tolerance limit + TT Lower Tolerance limit – TT Nominal expected TX power $\pm 10$ dB (normal conditions) $\pm 13$ dB (extreme conditions)																								
5.4.1.2 Uplink Power Control, differential accuracy	<table border="0"> <tr> <td>SIR Target</td> <td>Pow Step Tol</td> <td>TT</td> </tr> <tr> <td>&lt;1 dB</td> <td>0.5 dB</td> <td>0.1 dB</td> </tr> <tr> <td>&lt;2dB</td> <td>1 dB</td> <td>0.15 dB</td> </tr> <tr> <td>&lt;3 dB</td> <td>1.5 dB</td> <td>0.2 dB</td> </tr> <tr> <td>&lt;10 dB</td> <td>2 dB</td> <td>0.5 dB</td> </tr> <tr> <td>&lt;20dB</td> <td>4 dB</td> <td>0.7 dB</td> </tr> <tr> <td>&lt;30 dB</td> <td>6 dB</td> <td>0.7 dB</td> </tr> <tr> <td>&gt; 30 dB</td> <td>9 dB</td> <td>1.0 dB</td> </tr> </table>	SIR Target	Pow Step Tol	TT	<1 dB	0.5 dB	0.1 dB	<2dB	1 dB	0.15 dB	<3 dB	1.5 dB	0.2 dB	<10 dB	2 dB	0.5 dB	<20dB	4 dB	0.7 dB	<30 dB	6 dB	0.7 dB	> 30 dB	9 dB	1.0 dB		Formula: Upper Tolerance limit + TT Lower Tolerance limit – TT
SIR Target	Pow Step Tol	TT																									
<1 dB	0.5 dB	0.1 dB																									
<2dB	1 dB	0.15 dB																									
<3 dB	1.5 dB	0.2 dB																									
<10 dB	2 dB	0.5 dB																									
<20dB	4 dB	0.7 dB																									
<30 dB	6 dB	0.7 dB																									
> 30 dB	9 dB	1.0 dB																									
5.4.1.3 Open Loop Power Control	$\pm 9$ dB normal conditions $\pm 12$ dB extreme conditions	1.0 dB	Formula: Upper Tolerance limit + TT Lower Tolerance limit – TT Nominal expected TX power $\pm 10$ dB (normal conditions) $\pm 13$ dB (extreme conditions)																								
5.4.2 Minimum Transmit Power	UE minimum transmit power shall be less than –49 dBm	1.0 dB	Formula: UE minimum transmit power + TT UE minimum transmit power = –48 dBm																								

<p>5.4.5 Out-of-synchronisation handling of output power:</p>	<p><math>\frac{\Sigma DPCH - E_c}{I_{or}}</math> levels before A -2.4 dB AB: -10 dB BD: -16 dB DE: -12 dB EF: -6 dB transmit ON/OFF time 200ms</p>	<p>0,4 dB for <math>\frac{\Sigma DPCH - E_c}{I_{or}}</math> 0 ms for timing measurement</p>	<p>Formulas: Ratio between A and B + TT Ratio between B and D - TT Ratio between D and E - TT Ratio between E and F + TT transmit ON/OFF time + TT timing</p> <p><math>\frac{\Sigma DPCH - E_c}{I_{or}}</math> levels: Before A: -4,6 AB: -10 + 0,4 dB BD: -16 - 0,4 dB DE: -12 - 0,4 dB EF: -6 + 0,4 dB Uncertainty of OFF power measurement is handled by Transmit OFF power test and uncertainty of ON power measurement is handled by Minimum output power test.transmit ON/OFF time 200ms</p>		
<p>5.5.1 Transmit OFF power</p>	<p>Transmit OFF power shall be less than -65 dBm</p>	<p>1.5 dB</p>	<p>Formula: Transmit OFF power + TT Transmit OFF power = -63.5 dBm</p>		
<p>5.5.1 Occupied Bandwidth</p>	<p>The occupied channel bandwidth shall be less than 1.6 MHz based on a chip rate of 1.28 Mcps.</p>	<p>0 kHz</p>	<p>Formula: occupied channel bandwidth: + TT occupied channel bandwidth = 1.6 MHz</p>		
<p>5.5.2.1 Spectrum emission mask</p>	<p>Minimum requirement defined in TS25.102 table 6.5A. The lower limit shall be -55 dBm / 1.28 MHz or which ever is higher.</p>	<p>1.5 dB</p>	<p>Formula: Minimum requirement + TT Lower limit + TT Add 1.5 to Minimum requirement entries in TS25.102 table 6.5A The lower limit shall be -53.5 dBm / 1.28 MHz or which ever is higher.</p>		
<p>5.5.2.2 Adjacent Channel Leakage Power Ratio (ACLR)</p>	<p>Power Classes 2 and 3: UE channel +1.6 MHz or -1.6MHz, ACLR limit: 33 dB UE channel +3.2 MHz or -3.2 MHz, ACLR limit: 43 dB</p>	<p>0.8 dB</p>	<p>Formula: ACLR limit - TT Power Classes 2 and 3: UE channel +1.6 MHz or -1.6 MHz, ACLR limit: 32.2 dB UE channel +3.2 MHz or -3.2MHz, ACLR limit: 42.2 dB</p>		
<p>5.5.3 Spurious Emissions</p>			<p>Formula: Minimum Requirement+ TT Add zero to all the values of Minimum Requirements in table 5.5.3</p>		
	<p>Frequency Band</p>	<p>Minimum Requirement</p>	<p>Frequency Band</p>	<p>Minimum Requirement</p>	
	<p>9 kHz ≤ f &lt; 150 kHz</p>	<p>-36dBm /1kHz</p>	<p>0 dB</p>	<p>9kHz ≤ f &lt; 1GHz</p>	<p>-36dBm /1kHz</p>
	<p>150 kHz ≤ f &lt; 30 MHz</p>	<p>-36dBm /10kHz</p>	<p>0 dB</p>	<p>150 kHz ≤ f &lt; 30 MHz</p>	<p>-36dBm /10kHz</p>
	<p>30 MHz ≤ f &lt; 1000 MHz</p>	<p>-36dBm /100kHz</p>	<p>0 dB</p>	<p>30 MHz ≤ f &lt; 1000 MHz</p>	<p>-36dBm /100kHz</p>
	<p>1 GHz ≤ f &lt; 12.75 GHz</p>	<p>-30dBm /1MHz</p>	<p>0 dB</p>	<p>1 GHz ≤ f &lt; 2.2 GHz</p>	<p>-30dBm /1MHz</p>
<p>0 dB</p>			<p>2.2 GHz ≤ f &lt; 4 GHz</p>	<p>-30dBm /1MHz</p>	
<p>0 dB</p>			<p>4 GHz ≤ f &lt; 12.75 GHz</p>	<p>-30dBm /1MHz</p>	

	925 MHz < f < 935 MHz	-67dBm /100kHz	0 dB	925 MHz < f < 935 MHz	-67dBm /100kHz
	935 MHz ≤ f ≤ 960 MHz	-79dBm /100kHz	0 dB	935 MHz ≤ f ≤ 960 MHz	-79dBm /100kHz
	1805 MHz < f ≤ 1880 MHz	-71dBm /100kHz	0 dB	1805 MHz < f ≤ 1880 MHz	-71dBm /100kHz
	1884.5 MHz ≤ f ≤ 1919.6 MHz	-41dBm* /300kHz	0 dB	1884.5 MHz ≤ f ≤ 1919.6 MHz	-41dBm* /300kHz
5.6 Transmit Intermodulation	Intermodulation Product 1.6MHz -31 dBc 3.2MHz -41 dBc		0 dB	Formula: Intermodulation Product + TT Intermodulation Product 1.6MHz -31 dBc 3.2MHz -41 dBc	
5.7.1 Error Vector Magnitude	The Error Vector Magnitude shall not exceed 17.5 %		0%	Formula: EVM limit + TT EVM limit = 17.5 %	
5.7.2 Peak code domain error	The peak code domain error shall not exceed -21dB		□1.0 dB	Formula: Peak code domain error + TT Peak code domain error = -20 dB	

### F.4.2.2 Receiver

**Table F.4.2.2 Derivation of Receiver Test Requirements**

Test	Minimum Requirement in TS 25.102		Test Tolerance (TT)	Test Requirement in TS 34.122	
6.2 Reference sensitivity level	$\hat{I}_{or} = -108 \text{ dBm} / 1.28 \text{ MHz}$ BER limit = 0.001		0.7 dB	Formula: $\hat{I}_{or} + T$ BER limit unchanged  $\hat{I}_{or} = -107.3 \text{ dBm} / 1.28 \text{ MHz}$	
6.4 Adjacent Channel Selectivity	$\hat{I}_{or} = -91 \text{ dBm} / 1.28 \text{ MHz}$ $loac \text{ (modulated)} = -54 \text{ dBm} / 1.28 \text{ MHz}$ BER limit = 0.001		0 dB	Formula: $\hat{I}_{or}$ unchanged $loac - TT$ BER limit unchanged  $loac = -54 \text{ dBm} / 1.28 \text{ MHz}$	
6.5 Blocking Characteristics	See table 6.5.2a and 6.5.2b. in TS34.122 BER limit = 0.001		0 dB	Formula: $I_{\text{blocking}} \text{ (modulated)} - TT$ (dBm/1.28MHz) $I_{\text{blocking}} \text{ (CW)} - TT$ (dBm) BER limit unchanged	
6.6 Spurious Response	$I_{\text{blocking}} \text{ (CW)} -44 \text{ dBm}$ $F_{uw}$ : Spurious response frequencies BER limit = 0.001		0 dB	Formula: $I_{\text{blocking}} \text{ (CW)} - TT$ (dBm) $F_{uw}$ unchanged BER limit unchanged  $I_{\text{blocking}} \text{ (CW)} -44 \text{ dBm}$	
6.7 Intermodulation Characteristics	$lo_{uw1} \text{ (CW)} -46 \text{ dBm}$ $lo_{uw2} \text{ (modulated)} -46 \text{ dBm} / 1.28 \text{ MHz}$ $F_{uw1} \text{ (offset)} 3.2 \text{ MHz}$ $F_{uw2} \text{ (offset)} 6.4 \text{ MHz}$  BER limit = 0.001		0 dB	Formula: TBD BER limit unchanged.	
6.8 Spurious Emissions				Formula: Maximum level+ TT Add zero to all the values of Maximum Level in table 6.8.1.	
	Frequency Band	Maximum level		Frequency Band	Maximum level
	$9 \text{ kHz} \leq f < 1 \text{ GHz}$	-57dBm /100kHz	0 dB	$9 \text{ kHz} \leq f < 1 \text{ GHz}$	-57dBm /100kHz
	1.9-1.92 GHz 2.01-2.025GHz 2.11-2.170GHz	-60 dBm / 3,84MHz	0 dB	1.9-1.92 GHz 2.01-2.025GHz 2.11-2.170GHz	-60 dBm / 3,84MHz
	1 –1.9GHz, 1.92–2.01 GHz 2.025–2.11GHz	-47 dBm/1MHz	0 dB	1 –1.9GHz, 1.92–2.01 GHz 2.025–2.11GHz	-47 dBm/1MHz
	$1 \text{ GHz} \leq f \leq 12.75 \text{ GHz}$	-47dBm /1MHz	0 dB	$1 \text{ GHz} \leq f \leq 2.2 \text{ GHz}$	-47dBm /1MHz
			0 dB	$2.2 \text{ GHz} < f \leq 4 \text{ GHz}$	-47dBm /1MHz
		0 dB	$4 \text{ GHz} < f \leq 12.75 \text{ GHz}$	-47dBm /1MHz	
7.6 Downlink Power Control		TS #1,9	TS #7,14	Formula for 10 dB change in transmit power: Upper Tolerance limit + TT Lower Tolerance limit – TT	
	1 <sup>st</sup> frame	15 ±4.0 dBm	5 ±0.5 dBm		
	2 <sup>nd</sup> frame	15 ±4.0 dBm	15 ±4.0 dBm		



## F.4.2.3 Performance requirement

Table F.4.2.3 Derivation of Performance Test Requirements

Test	Minimum Requirement in TS 25.102			Test Tolerance (TT)	Test Requirement in TS 34.122
7.2, Demodulation in Static Propagation Condition	$\hat{I}_{or}/I_{oc} = 2.4$ to $3.6$ dB $I_{oc} = -60$ dBm/1.28MHz			0.3 dB for $\hat{I}_{or}/I_{oc}$	Formulas: $\hat{I}_{or}/I_{oc} = \text{Minimum Requirement} + \text{TT}$ $I_{oc}$ unchanged $\hat{I}_{or}/I_{oc} = 2.7$ to $3.9$ dB
7.3.1, Demodulation of DCH in Multiplath Fading case 1	$\hat{I}_{or}/I_{oc} = 15.8$ to $23.9$ dB $I_{oc} = -60$ dBm/1.28MHz			0.6 dB for $\hat{I}_{or}/I_{oc}$	Formulas: $\hat{I}_{or}/I_{oc} = \text{Minimum Requirement} + \text{TT}$ $I_{oc}$ unchanged $\hat{I}_{or}/I_{oc} = 16.4$ to $24.5$ dB
7.3.2, Demodulation of DCH in Multiplath Fading case 2	$\hat{I}_{or}/I_{oc} = 9.8$ to $14.4$ dB $I_{oc} = -60$ dBm/1.28MHz			0.6 dB for $\hat{I}_{or}/I_{oc}$	Formulas: $\hat{I}_{or}/I_{oc} = \text{Minimum Requirement} + \text{TT}$ $I_{oc}$ unchanged $\hat{I}_{or}/I_{oc} = 10.4$ to $15$ dB
7.3.3, Demodulation of DCH in Multiplath Fading case 3	$\hat{I}_{or}/I_{oc} = 9.0$ to $14.3$ dB $I_{oc} = -60$ dBm/1.28MHz			0.6 dB for $\hat{I}_{or}/I_{oc}$	Formulas: $\hat{I}_{or}/I_{oc} = \text{Minimum Requirement} + \text{TT}$ $I_{oc}$ unchanged $\hat{I}_{or}/I_{oc} = 9.6$ to $14.9$ dB
7.3A Demodulation of DCH in high speed train conditions	$\hat{I}_{or}/I_{oc} = 6.2$ to $8.5$ dB $I_{oc} = -60$ dBm/1.28MHz			0.6 dB for $\hat{I}_{or}/I_{oc}$	Formulas: $\hat{I}_{or}/I_{oc} = \text{Minimum Requirement} + \text{TT}$ $I_{oc}$ unchanged $\hat{I}_{or}/I_{oc} = 6.8$ to $9.1$ dB
7.6 Downlink Power Control		TS #1,9	TS #7,14	0.5 dB for 10 dB change in output power, 0 otherwise.	Formula for 10 dB change in transmit power: Upper Tolerance limit + TT Lower Tolerance limit – TT
	1 <sup>st</sup> frame	15 ±4.0 dBm	5 ±0.5 dBm		
	2 <sup>nd</sup> frame	15 ±4.0 dBm	15 ±4.0 dBm		

## F.4.2.4 Performance of HSDPA

Table F.4.2.4 Derivation of Performance of HSDPA Test Requirements

Test	Minimum Requirement in TS 25.102	Test Tolerance (TT)	Test Requirement in TS 34.122
9.3.1 HS-DSCH throughput for Fixed Reference Channels	$\frac{E_c}{I_{or}}$ -10,-9.5 dB $I_{oc} = -60$ dBm $\hat{I}_{or}/I_{oc} = 10$ dB	0.1 dB for $\frac{E_c}{I_{or}}$ 0.6 dB for $\hat{I}_{or}/I_{oc}$	Formulas: $\frac{E_c}{I_{or}} = \text{ratio} + \text{TT}$ $\hat{I}_{or}/I_{oc} = \text{ratio} + \text{TT}$ $I_{oc}$ unchanged
9.3.2 HS-DSCH throughput for Variable Reference Channels	$\frac{E_c}{I_{or}}$ -10dB $I_{oc} = -60$ dBm $\hat{I}_{or}/I_{oc} = 8$ and 10 dB	0.1 dB for $\frac{E_c}{I_{or}}$ 0.6 dB for $\hat{I}_{or}/I_{oc}$	Formulas: $\frac{E_c}{I_{or}} = \text{ratio} + \text{TT}$ $\hat{I}_{or}/I_{oc} = \text{ratio} + \text{TT}$ $I_{oc}$ unchanged
9.3.3 Reporting of HS-DSCH Channel Quality Indicator		No test tolerances applied	
9.3.4 HS-SCCH Detection Performance	$\frac{E_c}{I_{or}}$ -10dB $I_{oc} = -60$ dBm $\hat{I}_{or}/I_{oc} = 12$ and 16 dB	0.1 dB for $\frac{E_c}{I_{or}}$ 0.6 dB for $\hat{I}_{or}/I_{oc}$	Formulas: $\frac{E_c}{I_{or}} = \text{ratio} + \text{TT}$ $\hat{I}_{or}/I_{oc} = \text{ratio} + \text{TT}$ $I_{oc}$ unchanged

## F.4.3 7.68Mcps TDD Option

Table F.4.3 Derivation of Test Requirements

Test	Minimum Requirement in TS 25.102	Test Tolerance (TT)	Test Requirement in TS 34.122																								
5.2 Maximum Output Power	Power single code Power class 1 (30 dBm) Tolerance = +1/-3 dB Power class 2 (24 dBm) Tolerance = +1/-3 dB Power class 3 (21 dBm) Tolerance = +2/-2 dB Power multi code Power class 2 (21 dBm) Tolerance = +1/-3 dB Power class 3 (18 dBm) Tolerance = ±2 dB Power class 4 (10 dBm) Tolerance = ± 4 dB	0.7 dB	Formula: Upper Tolerance limit + TT Lower Tolerance limit – TT For power classes 1 and 2 (single and multi): Upper Tolerance limit = +1.7 dB Lower Tolerance limit = -3.7 dB For power class 3 (single and multi): Upper Tolerance limit = +2.7 dB Lower Tolerance limit = -2.7 dB For power class 4 (single and multi) Upper Tolerance limit = +4.7 dB Lower Tolerance limit = -4.7 dB																								
5.3 UE Frequency Stability	The UE modulated carrier frequency shall be accurate to within ±0.1 ppm compared to the carrier frequency received from the Node B.	10 Hz	Formula: modulated carrier frequency error + TT  modulated carrier frequency error = ±(0.1 ppm + 10 Hz).																								
5.4.1.1 Uplink Power Control, Initial accuracy	±9dB normal conditions ±12dB extreme conditions	1.0 dB	Formula: Upper Tolerance limit + TT Lower Tolerance limit – TT Nominal expected TX power ±10dB (normal conditions) ±13dB (extreme conditions)																								
5.4.1.2 Uplink Power Control, differential accuracy	<table border="0"> <tr> <td>SIR Target</td> <td>Pow Step Tol</td> <td>TT</td> </tr> <tr> <td>&lt;1 dB</td> <td>0.5 dB</td> <td>0.1 dB</td> </tr> <tr> <td>&lt;2dB</td> <td>1 dB</td> <td>0.15 dB</td> </tr> <tr> <td>&lt;3 dB</td> <td>1.5 dB</td> <td>0.2 dB</td> </tr> <tr> <td>&lt;10 dB</td> <td>2 dB</td> <td>0.5 dB</td> </tr> <tr> <td>&lt;20dB</td> <td>4 dB</td> <td>0.7 dB</td> </tr> <tr> <td>&lt;30 dB</td> <td>6 dB</td> <td>0.7 dB</td> </tr> <tr> <td>&gt; 30 dB</td> <td>9 dB</td> <td>1.0 dB</td> </tr> </table>	SIR Target	Pow Step Tol	TT	<1 dB	0.5 dB	0.1 dB	<2dB	1 dB	0.15 dB	<3 dB	1.5 dB	0.2 dB	<10 dB	2 dB	0.5 dB	<20dB	4 dB	0.7 dB	<30 dB	6 dB	0.7 dB	> 30 dB	9 dB	1.0 dB		Formula: Upper Tolerance limit + TT Lower Tolerance limit – TT
SIR Target	Pow Step Tol	TT																									
<1 dB	0.5 dB	0.1 dB																									
<2dB	1 dB	0.15 dB																									
<3 dB	1.5 dB	0.2 dB																									
<10 dB	2 dB	0.5 dB																									
<20dB	4 dB	0.7 dB																									
<30 dB	6 dB	0.7 dB																									
> 30 dB	9 dB	1.0 dB																									
5.4.1.3 Open Loop Power Control	±9dB normal conditions ±12dB extreme conditions	1.0 dB	Formula: Upper Tolerance limit + TT Lower Tolerance limit – TT Nominal expected TX power ±10dB (normal conditions) ±13dB (extreme conditions)																								
5.4.2 Minimum Transmit Power	UE minimum transmit power shall be less than –44 dBm	1.0 dB	Formula: UE minimum transmit power + TT UE minimum transmit power = –43 dBm																								



<p>5.4.5 Out-of-synchronisation handling of output power:</p>	<p><math>\frac{\Sigma DPCH - E_c}{I_{or}}</math> levels before A -4.6 dB AB: -10 dB BD: -16 dB DE: -12 dB EF: -6 dB transmit ON/OFF time 200ms</p>	<p>0,4 dB for <math>\frac{\Sigma DPCH - E_c}{I_{or}}</math> 0 ms for timing measurement</p>	<p>Formulas: Ratio between A and B + TT Ratio between B and D - TT Ratio between D and E - TT Ratio between E and F + TT transmit ON/OFF time + TT timing</p> <p><math>\frac{\Sigma DPCH - E_c}{I_{or}}</math> levels: Before A: -4.6 AB: -10 + 0,4 dB BD: -16 - 0,4 dB DE: -12 - 0,4 dB EF: -6 + 0,4 dB Uncertainty of OFF power measurement is handled by Transmit OFF power test and uncertainty of ON power measurement is handled by Minimum output power test.transmit ON/OFF time 200ms</p>		
<p>5.5.1 Transmit OFF power</p>	<p>Transmit OFF power shall be less than -65 dBm</p>	<p>1.5 dB</p>	<p>Formula: Transmit OFF power + TT Transmit OFF power = -63.5 dBm</p>		
<p>5.5.1 Occupied Bandwidth</p>	<p>The occupied channel bandwidth shall be less than 5 MHz based on a chip rate of 3,84 Mcps.</p>	<p>0 kHz</p>	<p>Formula: occupied channel bandwidth: + TT occupied channel bandwidth = 5.0 MHz</p>		
<p>5.5.2.1 Spectrum emission mask</p>	<p>Minimum requirement defined in TS25.101 table 6.10. The lower limit shall be -50 dBm / 3,84 MHz or which ever is higher.</p>	<p>1.5 dB</p>	<p>Formula: Minimum requirement + TT Lower limit + TT Add 1.5 to Minimum requirement entries in TS25.101 table 6.10 The lower limit shall be -48.5 dBm / 3,84 MHz or which ever is higher.</p>		
<p>5.5.2.2 Adjacent Channel Leakage Power Ratio (ACLR)</p>	<p>Power Classes 2 and 3: UE channel +5 MHz or -5 MHz, ACLR limit: 33 dB UE channel +10 MHz or -10 MHz, ACLR limit: 43 dB</p>	<p>0.8 dB</p>	<p>Formula: ACLR limit - TT Power Classes 2 and 3: UE channel +5 MHz or -5 MHz, ACLR limit: 32.2 dB UE channel +10 MHz or -10 MHz, ACLR limit: 42.2 dB</p>		
<p>5.5.3 Spurious Emissions</p>			<p>Formula: Minimum Requirement+ TT Add zero to all the values of Minimum Requirements in table 5.5.3</p>		
	<p>Frequency Band</p>	<p>Minimum Requirement</p>	<p>Frequency Band</p>	<p>Minimum Requirement</p>	
	<p>9 kHz ≤ f &lt; 150 kHz</p>	<p>-36dBm /1kHz</p>	<p>0 dB</p>	<p>9kHz ≤ f &lt; 1GHz</p>	<p>-36dBm /1kHz</p>
	<p>150 kHz ≤ f &lt; 30 MHz</p>	<p>-36dBm /10kHz</p>	<p>0 dB</p>	<p>150 kHz ≤ f &lt; 30 MHz</p>	<p>-36dBm /10kHz</p>
	<p>30 MHz ≤ f &lt; 1000 MHz</p>	<p>-36dBm /100kHz</p>	<p>0 dB</p>	<p>30 MHz ≤ f &lt; 1000 MHz</p>	<p>-36dBm /100kHz</p>
	<p>1 GHz ≤ f &lt; 12.75 GHz</p>	<p>-30dBm /1MHz</p>	<p>0 dB</p>	<p>1 GHz ≤ f &lt; 2.2 GHz</p>	<p>-30dBm /1MHz</p>
<p>0 dB</p>			<p>2.2 GHz ≤ f &lt; 4 GHz</p>	<p>-30dBm /1MHz</p>	
<p>0 dB</p>			<p>4 GHz ≤ f &lt; 12.75 GHz</p>	<p>-30dBm /1MHz</p>	

	925 MHz < f < 935 MHz	-67dBm /100kHz	0 dB	925 MHz < f < 935 MHz	-67dBm /100kHz
	935 MHz ≤ f ≤ 960 MHz	-79dBm /100kHz	0 dB	935 MHz ≤ f ≤ 960 MHz	-79dBm /100kHz
	1805 MHz < f ≤ 1880 MHz	-71dBm /100kHz	0 dB	1805 MHz < f ≤ 1880 MHz	-71dBm /100kHz
	1884.5 MHz ≤ f ≤ 1919.6 MHz	-41dBm* /300kHz	0 dB	1884.5 MHz ≤ f ≤ 1919.6 MHz	-41dBm* /300kHz
5.6 Transmit Intermodulation	Intermodulation Product 5MHz -31 dBc 10MHz -41 dBc		0 dB	Formula: Intermodulation Product + TT Intermodulation Product 5MHz -31 dBc 10MHz -41 dBc	
5.7.1 Error Vector Magnitude	The Error Vector Magnitude shall not exceed 17.5 %		0%	Formula: EVM limit + TT EVM limit = 17.5 %	
5.7.2 Peak code domain error	The peak code domain error shall not exceed -21dB		□ 1.0 dB	Formula: Peak code domain error + TT Peak code domain error = -20 dB	
6.2 Reference sensitivity level	I <sub>or</sub> = -105 dBm / 3,84 MHz BER limit = 0.001		0.7 dB	Formula: I <sub>or</sub> + T BER limit unchanged  I <sub>or</sub> = -104.3 dBm / 3,84 MHz	
6.4 Adjacent Channel Selectivity	I <sub>or</sub> = -91 dBm / 3,84 MHz I <sub>oac</sub> (modulated) = -52 dBm/3,84 MHz BER limit = 0.001		0 dB	Formula: I <sub>or</sub> unchanged I <sub>oac</sub> - TT BER limit unchanged  I <sub>oac</sub> = -52 dBm/3,84 MHz	
6.5 Blocking Characteristics	See table 6.5.2a and 6.5.2b. in TS34.122 BER limit = 0.001		0 dB	Formula: I <sub>blocking</sub> (modulated) - TT (dBm/3,84MHz) I <sub>blocking</sub> (CW) - TT (dBm) BER limit unchanged	
6.6 Spurious Response	I <sub>blocking</sub> (CW) -44 dBm F <sub>uw</sub> : Spurious response frequencies BER limit = 0.001		0 dB	Formula: I <sub>blocking</sub> (CW) - TT (dBm) F <sub>uw</sub> unchanged BER limit unchanged  I <sub>blocking</sub> (CW) -44 dBm	
6.7 Intermodulation Characteristics	I <sub>ow1</sub> (CW) -46 dBm I <sub>ow2</sub> (modulated) -46 dBm / 3,84 MHz F <sub>uw1</sub> (offset) 10 MHz F <sub>uw2</sub> (offset) 20 MHz  BER limit = 0.001		0 dB	Formula: TBD BER limit unchanged.	
6.8 Spurious Emissions				Formula: Maximum level+ TT Add zero to all the values of Maximum Level in table 6.8.1.	
	Frequency Band	Maximum level		Frequency Band	Maximum level
	9kHz ≤ f < 1GHz	-57dBm /100kHz	0 dB	9kHz ≤ f < 1GHz	-57dBm /100kHz
	1.9-1.92 GHz 2.01-2.025GHz 2.11-2.170GHz	-60 dBm / 3,84MHz	0 dB	1.9-1.92 GHz 2.01-2.025GHz 2.11-2.170GHz	-60 dBm / 3,84MHz
	1 -1.9GHz, 1.92-2.01 GHz 2.025-2.11GHz	-47 dBm/1MHz	0 dB	1 -1.9GHz, 1.92-2.01 GHz 2.025-2.11GHz	-47 dBm/1MHz
	1GHz ≤ f ≤	-47dBm	0 dB	1GHz ≤ f ≤ 2.2GHz	-47dBm

	12.75GHz	/1MHz				/1MHz
				0 dB	2.2GHz < f ≤ 4GHz	-47dBm /1MHz
				0 dB	4GHz < f ≤ 12.75GHz	-47dBm /1MHz
7.6 Downlink Power Control		TS #1,9	TS #7,14	0.5 dB for 10 dB change in output power, 0 otherwise.	Formula for 10 dB change in transmit power: Upper Tolerance limit + TT Lower Tolerance limit – TT	
	1 <sup>st</sup> frame	15 ±4.0 dBm	5 ±0.5 dBm			
	2 <sup>nd</sup> frame	15 ±4.0 dBm	15 ±4.0 dBm			
9.3.1 HS-DSCH throughput for Fixed Reference Channels	$\frac{E_c}{I_{or}}$ -10,-9.5 dB  $I_{oc} = -60$ dBm  $\hat{I}_{or}/I_{oc} = 10$ dB			0.1 dB for $\frac{E_c}{I_{or}}$  0.6 dB for $\hat{I}_{or}/I_{oc}$	Formulas: $\frac{E_c}{I_{or}} = \text{ratio} + TT$ $\hat{I}_{or}/I_{oc} = \text{ratio} + TT$ $I_{oc}$ unchanged	
9.3.2 HS-DSCH throughput for Variable Reference Channels	$\frac{E_c}{I_{or}}$ -10dB  $I_{oc} = -60$ dBm  $\hat{I}_{or}/I_{oc} = 8$ and 10 dB			0.1 dB for $\frac{E_c}{I_{or}}$  0.6 dB for $\hat{I}_{or}/I_{oc}$	Formulas: $\frac{E_c}{I_{or}} = \text{ratio} + TT$ $\hat{I}_{or}/I_{oc} = \text{ratio} + TT$ $I_{oc}$ unchanged	
9.3.3 Reporting of HS-DSCH Channel Quality Indicator				No test tolerances applied		
9.3.4 HS-SCCH Detection Performance	$\frac{E_c}{I_{or}}$ -10dB  $I_{oc} = -60$ dBm  $\hat{I}_{or}/I_{oc} = 12$ and 16 dB			0.1 dB for $\frac{E_c}{I_{or}}$  0.6 dB for $\hat{I}_{or}/I_{oc}$	Formulas: $\frac{E_c}{I_{or}} = \text{ratio} + TT$ $\hat{I}_{or}/I_{oc} = \text{ratio} + TT$ $I_{oc}$ unchanged	
* Applicable for transmission in 2010-2025 MHz as defined in subclause 4.2 (a).						

## F.5 Acceptable uncertainty of Test Equipment (This clause is informative)

This informative clause specifies the critical parameters of the components of an overall Test System (e.g. Signal generators, Signal Analyzers etc.) which are necessary when assembling a Test System that complies with clause F.1 Acceptable Uncertainty of Test System. These Test Equipment parameters are fundamental to the accuracy of the overall Test System and are unlikely to be improved upon through System Calibration.

## F.5.1 Transmitter measurements

**Table F.5.1 Equipment accuracy for transmitter measurements**

Test	Equipment accuracy	Test conditions
5.2 UE Maximum Output Power	Not applicable	
5.3 Frequency Stability	± 10Hz	
5.4.1 Uplink power control		
5.4.2 Minimum Transmit Power		
5.4.3 Transmit OFF Power		
5.4.4 Transmit ON/OFF Power		
5.4.5 Out-of-synchronisation handling of output power $\frac{DPCCH\_E_c}{I_{or}}$		
5.4.5 Out-of-synchronisation handling of output power: transmit ON/OFF time		
5.5.1 Occupied Bandwidth	100 kHz	
5.5.2.1 Spectrum emission mask	Not applicable	
5.5.2.2 ACLR		
5.5.3 Spurious emissions		
5.5.3 Spurious emissions: additional		
5.6 Transmit intermodulation:	Not applicable	
5.7.1 Transmit modulation: EVM	2.5 %	
5.7.2 Transmit modulation: peak code domain error	±[1 dB]	

## F.5.2 Receiver measurements

**Table F.5.2 Equipment accuracy for receiver measurements**

Clause	Equipment accuracy	Test conditions
6.2 Reference Sensitivity Level	Not applicable	
6.3 maximum input level:	Not applicable	
6.4 Adjacent Channel Selectivity (ACS)	Not applicable	
6.5 Blocking Characteristics	Not applicable	
6.6 Spurious Responce	Not applicable	
6.7 Intermodulation Characteristics	Not applicable	
6.8 Spurious Emissions	Not applicable	

## F.5.3 Performance measurements

**Table G.3 Equipment accuracy for performance measurements**

Clause	Equipment accuracy	Test conditions
TBD	TBD	

## F.5.5 Performance measurements (HSDPA)

**Table F.5.5: Equipment accuracy for performance measurements (HSDPA)**

Clause	Equipment accuracy	Test conditions
9.3.1 HS-DSCH throughput for Fixed Reference Channels	$\frac{E_c}{I_{or}}$ $\pm 0.1$ dB	-10 and -9.5dB
9.3.2 HS-DSCH throughput for Variable Reference Channels	Same as 9.3.1	-10dB
9.3.3 Reporting of HS-DSCH Channel Quality Indicator	Same as 9.3.1	-10dB
9.3.4 HS-SCCH Detection Performance	Same as 9.3.1	-10dB

## F.6 General rules for statistical testing

### F.6.1 Statistical testing of receiver BER/BLER performance

#### F.6.1.1 Error Definition

##### 1) Bit Error Ratio (BER)

The Bit Error Ratio is defined as the ratio of the bits wrongly received to all data bits sent. The bits are the information bits above the convolutional/turbo decoder

##### 2) Block Error Ratio (BLER)

A Block Error Ratio is defined as the ratio of the number of erroneous blocks received to the total number of blocks sent. An erroneous block is defined as a Transport Block, the cyclic redundancy check (CRC) of which is wrong.

#### F.6.1.2 Test Method

Each test is performed in the following manner:

- a) Setup the required test conditions.
- b) Record the number of samples tested and the number of occurred events (bit error or block error)
- c) Stop the test at a stop criterion which is minimum test time or an early pass or an early fail event.
- d) Once the test is stopped decide according to the pass fail decision rules ( subclause F.6.1.7)

#### F.6.1.3 Test Criteria

The test shall fulfil the following requirements:

- a) good pass fail decision
  - 1) to keep reasonably low the probability (risk) of passing a bad unit for each individual test;
  - 2) to have high probability of passing a good unit for each individual test;
- b) good balance between test time and statistical significance
  - 3) to perform measurements with a high degree of statistical significance;
  - 4) to keep the test time as low as possible.

## F.6.1.4 Calculation assumptions

### F.6.1.4.1 Statistical independence

It is assumed, that error events are rare ( $\lim_{BER, BLER} \rightarrow 0$ ) independent statistical events. However the memory of the convolutional /turbo coder is terminated after one TTI. Samples and errors are summed up every TTI. So the assumption of independent error events is justified.

In the BLER test with fading there is the memory of the multipath fading channel which interferes the statistical independence. A minimum test time is introduced to average fluctuations of the multipath fading channel. So the assumption of independent error events is justified approximately.

### F.6.1.4.2 Applied formulas

The formulas, applied to describe the BER BLER test, are primarily based on the following experiment:

(1) After having observed a certain number of errors (**ne**) the number of samples are counted to calculate BER BLER.

Provisions are made (note 1) such that the complementary experiment is valid as well:

(2) After a certain number of samples (**ns**) the number of errors, occurred, are counted to calculate BER BLER.

Experiment (1) stipulates to use the following Chi Square Distribution with degree of freedom  $ne$ :  $2 * dchisq(2 * NE, 2 * ne)$  for all calculations.

Experiment (2) stipulates to use the Poisson Distribution:  $dpois(ne, NE)$

(NE: average of the distribution)

To determine the early stop conditions, the following inverse cumulative operation is applied:

$0.5 * qchisq(D, 2 * ne)$ . This is applicable for experiment (1) and (2).

D: wrong decision risk per test step

NOTE: other inverse cumulative operations are available, however only this is suited for experiment (1) and (2).

### F.6.1.4.3 Test procedure

The test procedure is as follows:

During a running measurement for a UE  $ns$  (number of samples) and  $ne$  (number of errors) are accumulated and from this the preliminary BER BLER is calculated. Then new samples up to the next error are taken. The entire past and the new samples are basis for the next preliminary BER BLER. Depending on the result at every step, the UE can pass, can fail or must continue the test.

As early pass- and early fail-UEs leave the statistical totality under consideration, the experimental conditions are changed every step resulting in a distribution that is truncated more and more towards the end of the entire test. Such a distribution can not any more be handled analytically. The unchanged distribution is used as an approximation to calculate the early fail and early pass bounds.

### F.6.1.5 Definition of good pass fail decision

This is defined by the probability of wrong decision  $F$  at the end of the test. The probability of a correct decision is  $1-F$ .

The probability (risk) to fail a good DUT shall be  $\leq F$  according to the following definition: A DUT is failed, accepting a probability of  $\leq F$  that the DUT is still better than the specified error ratio (Test requirement).

The probability to pass a bad DUT shall be  $\leq F$  according to the following definition: A DUT is passed, accepting a probability of  $\leq F$  that the DUT is still worse than  $M$  times the specified error ratio. ( $M > 1$  is the bad DUT factor).

This definitions lead to an early pass and an early fail limit:

Early fail:  $ber \geq ber_{lim_{fail}}$

$$\text{ber lim}_{fail}(D, ne) = \frac{2 * ne}{qchisq(D, 2 * ne)} \quad (1)$$

For  $ne \geq [5]$

Early pass:  $\text{ber} \leq \text{berlimbad}_{pass}$

$$\text{ber limbad}_{pass}(D, ne) = \frac{2 * ne * M}{qchisq(1 - D, 2 * ne)} \quad (2)$$

For  $ne \geq 1$

With

ber (normalized BER,BLER): BER,BLER according to F.6.1.1 divided by Test requirement

D: wrong decision probability for a test step. This is a numerically evaluated fraction of F, the wrong decision probability at the end of the test. see table F.6.1.1

ne: Number of error events

M: bad DUT factor see table F.6.1.1

qchisq: inverse cumulative chi squared distribution

### F.6.1.6 Good balance between testtime and statistical significance

There independent test parameters are introduced into the test and shown in Table F.6.1.6.1. These are the obvious basis of test time and statistical significance. From the first two of them four dependent test parameters are derived. The third independent test parameter is justified separately.

**Table F.6.1.6.1 independent and dependent test parameters**

Independent test parameters			Dependent test parameters		
Test Parameter	Value	Reference	Test parameter	Value	Reference
Bad DUT factor M	1.5	Table F.6.1.8	Early pass/fail condition	Curves	Subclause F.6.1.5 Figure 6.1.9
Final probability of wrong pass/fail decision F	0.2% 0.02%, note 2	Subclause F.6.1.5	Target number of error events	345	Table 6.1.8
			Probability of wrong pass/fail decision per test step D	0.0085% 0.0008% and 0.008%, note 2	
			Test limit factor TL	1.234	Table 6.1.8
Minimum test time		Table F.6.1.6.2			

The minimum test time is derived from the following justification:

- 1) For no propagation conditions and static propagation condition

No early fail calculated from fractional number of errors <1

see note 1

- 2) For multipath fading condition

No stop of the test until 999 wavelengths are crossed during relevant UE reception timeslots, relevant for BER BLER testing, with the speed given in the fading profile.

**Table F.6.1.6.2 : minimum Test time**

Fading profile	Minimum test time
Multipath propagation 3 km/h	[164 s * TSPF/TSRX] <sup>1)</sup>
Multipath propagation 50 km/h	[9.8 s * TSPF/TSRX]
Multipath propagation 120 km/h	[4.1 s * TSPF/TSRX]
Multipath propagation 250 km/h	[2s * TSPF/TSRX]
<sup>1)</sup> TSPF = Time slots per frame, TSRX = relevant UE reception timeslots per frame, relevant for the BER BLER test	

TSPF and TSRX form the prolongation factor and depend on the user data rate and the TDD Option (3,84 Mchip/s, 1,28 Mchip/s or 7.68Mcps)

**Table F.6.1.6.3 : Prolongation factor for minimum Test time**

User Data rate	TSPF/TSRX for TDD 3,84 Mchip/s and 7,68Mchip/s	TSPF/TSRX for TDD 1,28 Mchip/s
12.2 kbit/s	15/1	7/1
64 kbit/s	15/1	7/1
144 kbit/s	15/1	7/2
384 kbit/s	15/3	7/4

In table F.6.1.8 the minimum test time is converted in minimum number of samples

### F.6.1.7 Pass fail decision rules

No decision is allowed before the minimum test time is elapsed

- 1) If minimum Test time < time for target number of error events then the following applies: The required confidence level 1-F (= correct decision probability) shall be achieved. This is fulfilled at an early pass or early fail event.

For BER: For every TTI (Transmit Time Interval) sum up the number of bits (ns) and the number if errors (ne) from the beginning of the test and calculate

$BER_1$  (including the artificial error at the beginning of the test (Note 1))and

$BER_0$  (excluding the artificial error at the beginning of the test (Note 1)).

If  $BER_0$  is above the early fail limit, fail the DUT.

If  $BER_1$  is below the early pass limit, pass the DUT.

Otherwise continue the test

For BLER: For every block sum up the number of blocks (ns) and the number if erroneous blocks (ne) from the beginning of the test and calculate,

$BLER_1$  (including the artificial error at the beginning of the test (Note 1))and

$BLER_0$  (excluding the artificial error at the beginning of the test (Note 1)).

If  $BLER_1$  is below the early pass limit, pass the DUT.

If  $BLER_0$  is above the early fail limit, fail the DUT.

Otherwise continue the test

- 2) If the minimum test time  $\geq$  time for target error events, then the test runs for the minimum test time and the decision is done by comparing the result with the test limit.

For BER:



For every TTI (Transmit Time Interval) sum up the number of bits (ns) and the number of errors (ne) from the beginning of the test and calculate  $BER_0$

For BLER:

For every block sum up the number of blocks (ns) and the number of erroneous blocks (ne) from the beginning of the test and calculate  $BLER_0$

If  $BER_0/BLER_0$  is above the test limit, fail the DUT.

If  $BER_0/BLER_0$  is on or below the test limit, pass the DUT.

### F.6.1.8 Test conditions for BER,BLER tests

Table F.6.1.8: Test conditions for a single BER/BLER tests

Type of test (BER)	Test requirement (BER/BLER)	Test limit (BER/BLER)= Test requirement (BER/BLER)x TL	Target number of error events (time)	Minimum number of samples	Prob that good unit will fail = Prob that bad unit will pass [%]	Bad unit BER/BLER factor M
Reference Sensitivity Level	0.001	1.234	345 (22.9s)	Note 1	0.2	1.5
Maximum Input Level	0.001	1.234	345 (22.9s)	Note 1	0.2	1.5
Adjacent Channel Selectivity	0.001	1.234	345 (22.9s)	Note 1	0.2	1.5
Blocking Characteristics Pass condition Note 2	0.001	1.251	403 (26.4s)	Note 1	0.2	1.5
Blocking Characteristics Fail condition Note 2	0.001	1.251	403 (26.4s)	Note 1	0.02	1.5
Spurious Response	0.001	1.234	345 (22.9s)	Note 1	0.2	1.5
Intermodulation Characteristics	0.001	1.234	345 (22.9s)	Note 1	0.2	1.5
HS-SCCH Detection Performance	0.01	FFS	FFS	Note 1	0.2	1.5

Table F.6.1.8-2: Test conditions for BLER tests

Type of test (BLER)	Information Bit rate	Test requirement (BER/BLER)	Test limit (BER/BLER)= Test requirement (BER/BLER)x TL  TL	Target number of error events (time)	Minimum number of samples  TDD 3,84 Mchip/s	Minimum number of samples  TDD 1,28 Mchip/s	Prob that bad unit will pass = Prob that good unit will fail [%]	Bad unit BER/BLER factor M
Demodulation in Static Propagation conditions	12.2 64 144 384	0.01 0.1 0.01 0.1 0.01	1.234	345 (559.16s) (55.92s) (559.16s) (55.92s) (559.16s) (27.96s) (279.58s)	Note1	Note1	0.2	1.5
Demodulation of DCH in Multi-path Fading conditions								
3km/h (Case 1, Case 2)	12.2 64 144 384	0.01 0.1 0.01 0.1 0.01 0.1 0.01	1.234	345 (559.16s) (55.92s) (559.16s) (55.92s) (559.16s) (27.96s) (279.58s)	[1350] [1350] [1350] [1350] [1350] [450] [450]	57400 57400 57400 28700 28700 14350 14350	0.2	1.5
120 km/h (Case3)	12.2 64 144 384	0.01 0.1 0.01 0.1 0.01 0.1 0.01	1.234	345 (559.16s) (55.92s) (559.16s) (55.92s) (559.16s) (27.96s) (279.58s)	[34] [34] [34] [34] [34] [12] [12]	1435 1435 1435 718 718 359 359	0.2	1.5
250 km/h								
Power control in the downlink				Not applicable				

### F.6.1.9 Practical Use (informative)

See figure F.6.1.9:

The early fail limit represents formula (1) in F.6.1.5 [The range of validity is  $ne > 7, > 8$  in case of blocking test] to  $ne = 345$

The early pass limit represents the formula (2) in F.6.1.5 [The range of validity is  $ne = 1$  to  $ne = 345$ . See note 1

The intersection co-ordinates of both curves are: Target number of errors  $ne = 345$  and test limit  $TL = 1.234$

The range of validity for TL is  $ne > 345$

A typical BER BLER test, calculated from the number of samples and errors (F.6.1.2.(b)) using experimental method (1) or (2) (see F.6.1.4. calculation assumptions) runs along the yellow trajectory. With an errorless sample the trajectory goes down vertically. With an erroneous sample it goes up right. The tester checks if the BER BLER test intersects the early fail or early pass limits. The real time processing can be reduced by the following actions:

BLER is calculated only in case of an error event.

BER is calculated only in case of an error event within a TTI.

So the early fail limit cannot be missed by errorless samples.

The check against the early pass limit may be done by transforming formula (2) in F.6.1.5 such that the tester checks against a Limit-Number-of-samples (NL(ne)) depending on the current number of errors.

Early pass if

$$NL(ne) \geq \frac{qchisq(1 - D, 2 * ne)}{2 * TR * M}$$

TR: test requirement (0.001)

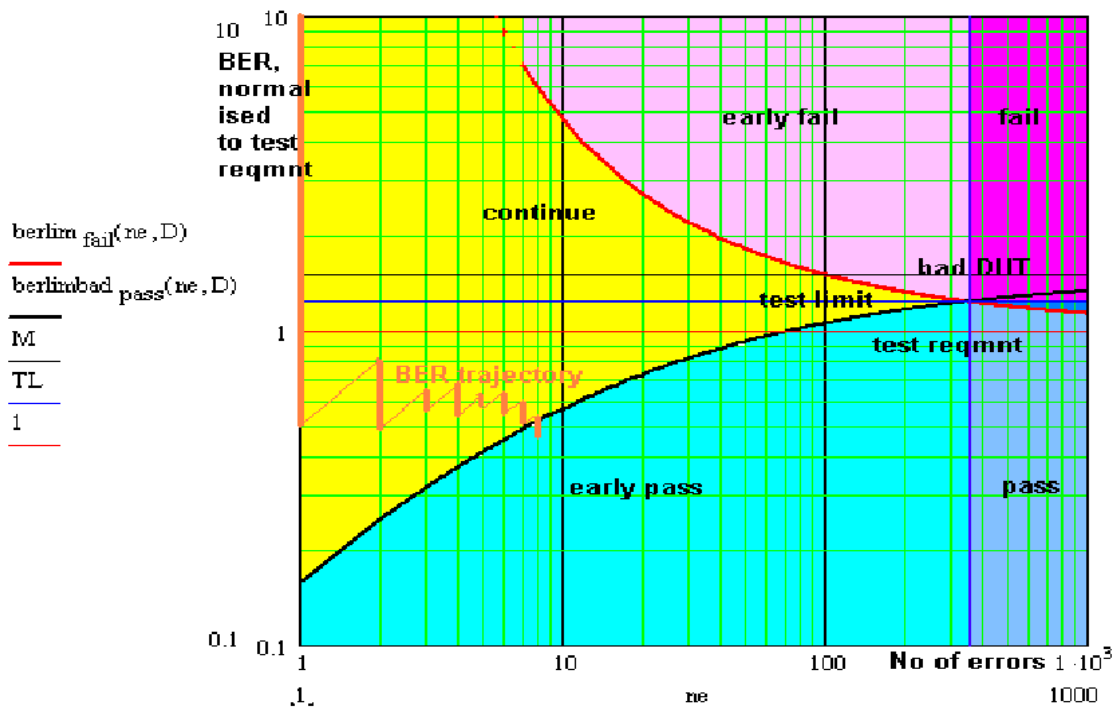

Figure F.6.1.9

NOTE 1: At the beginning of the test, an artificial error is introduced. This ensures that an ideal DUT meets the valid range of the early pass limit. In addition this ensures that the complementary experiment (F.6.1.4. bullet point (2)) is applicable as well.

Due to the nature of the test, namely discrete error events, the early fail condition shall not be valid, when fractional errors  $<1$  are used to calculate the early fail limit: Any early fail decision is postponed until number of errors  $n_e > 7$ . In the blocking test any early fail decision is postponed until number of errors  $n_e > 8$

NOTE 2:  $F=0.2\%$  is intended to be used for a test containing a few BER/BLER tests (e.g. receiver sensitivity is repeated 12 times). For a test containing many BER/BLER tests (e.g. blocking test) this value is not appropriate for a single BER/BLER test.

The blocking test contains approx. 12750 single BER tests. A DUT on the limit will fail approx. 25 to 26 times due to statistical reasons (wrong decision probability [0.2]%). 24 fails are allowed in the blocking test but they are reserved for spurious responses. This shall be solved by the following rule:

All passes (based on  $F=0.2\%$ ) are accepted, including the wrong decisions due to statistical reasons.

An early fail limit based on  $F=0.02\%$  instead of  $0.2\%$  is established, that ensures that wrong decisions due to statistical reasons are reduced to 2 to 3.

These asymmetric test conditions ensure that a DUT on the test limit consumes hardly more test time for a blocking test than in the symmetric case and on the other hand discriminates sufficiently between statistical fails and spurious response cases.

## F.6.2 Statistical testing of RRM delay performance

### F.6.2.1 Test Method

Each test is performed in the following manner:

- a) Setup the required test conditions.
- b) Measure the delay repeated times. Start each repetition after sufficient time, such that each delay test is independent from the previous one. The delay-times, measured, are simplified to:
  - a good delay, if the measured delay is  $\leq$  limit.
  - a bad delay, if the measured delay is  $>$  limit
- c) Record the number of delays ( $n_s$ ), tested, and the number of bad delays ( $n_e$ )
- d) Stop the test at an early pass or an early fail event.
- e) Once the test is stopped, decide according to the pass fail decision rules ( subclause F.6.2.7)

### F.6.2.2 Bad Delay Ratio (ER)

The Bad Delay Ratio (ER) is defined as the ratio of bad delays ( $n_e$ ) to all delays ( $n_s$ ).

( $1-ER$  is the success ratio)

### F.6.2.3 Test Criteria

The test shall fulfil the following requirements:

- a) good pass fail decision
  - 1) to keep reasonably low the probability (risk) of passing a bad unit for each individual test;
  - 2) to have high probability of passing a good unit for each individual test;
- b) good balance between test-time and statistical significance

- 3) to perform measurements with a high degree of statistical significance;
- 4) to keep the test time as low as possible.

## F.6.2.4 Calculation assumptions

### F.6.2.4.1 Statistical independence

It is arranged by test conditions, that bad delays are independent statistical events.

### F.6.2.4.2 Applied formulas

The specified ER is 10% in most of the cases. This stipulates to use the binomial distribution to describe the RRM delay statistics. With the binomial distribution optimal results can be achieved. However the inverse cumulative operation for the binomial distribution is not supported by standard mathematical tools. The use of the Poisson or Chi Square Distribution requires  $ER \rightarrow 0$ . Using one of this distributions instead of the binomial distribution gives sub-optimal results in the conservative sense: a pass fail decision is done later than optimal and with a lower wrong decision risk than predefined.

The formulas, applied to describe the RRM delay statistics test, are based on the following experiment:

(1) After having observed a certain number of bad delays (**ne**) the number of all delays (**ns**) are counted to calculate ER. Provisions are made (note 1) such that the complementary experiment is valid as well:

(2) After a certain number of delays (**ns**) the number of bad delays (**ne**), occurred, are counted to calculate ER.

Experiment (1) stipulates to use the Chi Square Distribution with degree of freedom  $ne: 2 * dchisq(2 * NE, 2 * ne)$ .

Experiment (2) stipulates to use the Poisson Distribution:  $dpois(ne, NE)$

(NE: mean value of the distribution)

To determine the early stop conditions, the following inverse cumulative operation is applied:

$0.5 * qchisq(D, 2 * ne)$  for experiment (1) and (2)

D: wrong decision risk per test step

NOTE: other inverse cumulative operations are available, however only this is suited for experiment (1) and (2).

### F.6.2.4.3 Approximation of the distribution

The test procedure is as follows:

During a running measurement for a UE  $ns$  (Number of Delays) and  $ne$  (Number of bad delays) are accumulated and from this the preliminary ER is calculated. Then new samples up to the next bad delay are taken. The entire past and the new samples are basis for the next preliminary ER. Depending on the result at every step, the UE can pass, can fail or must continue the test.

As early pass- and early fail-UEs leave the statistical totality under consideration, the experimental conditions are changed every step resulting in a distribution that is truncated more and more towards the end of the entire test. Such a distribution can not any more be handled analytically. The unchanged distribution is used as an approximation to calculate the early fail and early pass bounds.

## F.6.2.5 Definition of good pass fail decision.

This is defined by the probability of wrong decision  $F$  at the end of the test. The probability of a correct decision is  $1 - F$ .

The probability (risk) to fail a good DUT shall be  $\leq F$  according to the following definition: A DUT is failed, accepting a probability of  $\leq F$  that the DUT is still better than the specified bad delay ratio (Test requirement).

The probability (risk) to pass a bad DUT shall be  $\leq F$  according to the following definition: A DUT is passed, accepting a probability of  $\leq F$  that the DUT is still worse than  $M$  times the specified bad delay ratio. ( $M \geq 1$  is the bad DUT factor).

This definitions lead to an early pass and an early fail limit:

Early fail:  $er \geq erlim_{fail}$

$$erlim_{fail}(D, ne) = \frac{2 * ne}{qchisq(D, 2 * ne)} \quad (1)$$

For  $ne \geq [5]$ ,

Early pass:  $er \leq erlim_{pass}$

$$erlim_{pass}(D, ne) = \frac{2 * ne * M}{qchisq(1 - D, 2 * ne)} \quad (2)$$

For  $ne \geq 1$ ,

With,

er (normalized ER): ER according to F.6.2.2 divided by specified ER

D: wrong decision probability for a test step . This is a numerically evaluated fraction of F, the wrong decision probability at the end of the test. see table F.6.2.6.1

ne: Number of bad delays

M: bad DUT factor see table F.6.2.6.1

qchisq: inverse cumulative chi squared distribution

## F.6.2.6 Good balance between test-time and statistical significance

Two independent test parameters are introduced into the test and shown in Table F.6.2.6.1. These are the obvious basis of test time and statistical significance. From them four dependent test parameters are derived.

**Table F.6.2.6: Independent and dependent test parameters**

Independent test parameters			Dependent test parameters		
Test Parameter	Value	Reference	Test parameter	Value	Reference
Bad DUT factor M	1.5	Table F.6.1.8	Early pass/fail condition	Curves	Subclause F.6.2.5 Figure 6.2.9
Final probability of wrong pass/fail decision F	5%	Table F.6.2.8	Target number of bad delays	154	Table 6.2.8
			Probability of wrong pass/fail decision per test step D	0.6 %	
			Test limit factor TL	1.236	Table 6.2.8

## F.6.2.7 Pass fail decision rules

The required confidence level  $1-F$  (= correct decision probability) shall be achieved. This is fulfilled at an early pass or early fail event. Sum up the number of all delays (ns) and the number of bad delays from the beginning of the test and calculate:

$ER_1$  (including the artificial error at the beginning of the test (Note 1))and

$ER_0$  (excluding the artificial error at the beginning of the test (Note 1)).

If  $ER_0$  is on or above the early fail limit, fail the DUT.

If  $ER_1$  is on or below the early pass limit, pass the DUT.

Otherwise continue the test.

## F.6.2.8 Test conditions for RRM delay tests

Table F.6.2.8: Test conditions for a single RRM delay tests(3.84 Mcps TDD option)

Type of test	Test requirement Delay (s)	Test requirement (ER)	Testlimit(ER)= Test requirement (ER)x TL TL	Target number of bad delays	Prob that good unit will fail = Prob that bad unit will pass [%]	Bad unit factor M
8.2.2.1 TDD/TDD Cell re-selection in Idle mode (single carrier)	8	0.1	[1.236]	[154]	[5]	[1.5]
8.2.2.2 TDD/TDD Cell re-selection in Idle Mode (multicarrier)	8	0.1	[1.236]	[154]	[5]	[1.5]
8.2.2.3 TDD/FDD Cell re-selection in Idle Mode	8					
8.2.2.4 UTRAN to GSM cell re-selection in Idle Mode	27.9	0.1	[1.236]	[154]	[5]	[1.5]
8.3.1 TDD/TDD handover	40 ms	0.1	[1.236]	[154]	[5]	[1.5]
8.3.2 TDD/FDD handover	100 ms	0.1	[1.236]	[154]	[5]	[1.5]
8.3.3 TDD/GSM handover	40ms	0.1	[1.236]	[154]	[5]	[1.5]
8.3.4 TDD/TDD Cell Re-selection in CELL_FACH	2.5	0.1	[1.236]	[154]	[5]	[1.5]
8.3.5 TDD/TDD Cell Re-selection in CELL_PCH	8	0.1	[1.236]	[154]	[5]	[1.5]
8.3.6 TDD/TDD Cell Re-selection in URA_PCH	8	0.1	[1.236]	[154]	[5]	[1.5]

Table F.6.2.8A: Test conditions for a single RRM delay tests(1.28Mcps TDD option)

Type of test	Test requirement Delay (s)	Test requirement (ER)	Testlimit(ER)= Test requirement (ER)x TL TL	Target number of bad delays	Prob that good unit will fail = Prob that bad unit will pass [%]	Bad unit factor M
8.2.2.1 TDD/TDD Cell re-selection in Idle mode (single carrier)	8	0.1	1.236	154	5	1.5
8.2.2.2 TDD/TDD Cell re-selection in Idle Mode (multi-carrier)	8	0.1	1.236	154	5	1.5
8.2.2.3 TDD/FDD Cell re-selection in Idle Mode	8	0.1	1.236	154	5	1.5
8.2.2.4 UTRAN to GSM cell re-selection Scenario 4	8	0.1	1.236	154	5	1.5
8.2.2.5 UTRAN to GSM cell re-selection in Idle Mode Scenario 4A	27.9	0.1	1.236	154	5	1.5
8.3.1A TDD/TDD handover	160 ms	0.1	1.236	154	5	1.5
8.3.2A TDD/FDD handover	100 ms	0.1	1.236	154	5	1.5
8.3.3 TDD/GSM handover	90ms	0.1	1.236	154	5	1.5
8.3.4.1 TDD/TDD Cell Re-selection in CELL_FACH (single carrier)	1.6	0.1	1.236	154	5	1.5
8.3.4.2 TDD/TDD Cell Re-selection in CELL_FACH (multi-carrier)	2	0.1	1.236	154	5	1.5
8.3.5 TDD/TDD Cell Re-selection in CELL_PCH	8	0.1	1.236	154	5	1.5
8.3.6 TDD/TDD Cell Re-selection in URA_PCH	8	0.1	1.236	154	5	1.5



**Table F.6.2.8B: Test conditions for a single RRM delay tests(7.68 Mcps TDD option)**

Type of test	Test requirement Delay (s)	Test requirement (ER)	Testlimit(ER )= Test requirement (ER)x TL TL	Target number of bad delays	Prob that good unit will fail = Prob that bad unit will pass [%]	Bad unit factor M
8.2.2.1 TDD/TDD Cell re-selection in Idle mode (single carrier)	8	0.1	[1.236]	[154]	[5]	[1.5]
8.2.2.2 TDD/TDD Cell re-selection in Idle Mode (multicarrier)	8	0.1	[1.236]	[154]	[5]	[1.5]
8.2.2.3 TDD/FDD Cell re-selection in Idle Mode	8					
8.2.2.4 UTRAN to GSM cell re-selection in Idle Mode	27.9	0.1	[1.236]	[154]	[5]	[1.5]
8.3.1B TDD/TDD handover	40 ms	0.1	[1.236]	[154]	[5]	[1.5]
8.3.2B TDD/FDD handover	100 ms	0.1	[1.236]	[154]	[5]	[1.5]
8.3.3 TDD/GSM handover	40ms	0.1	[1.236]	[154]	[5]	[1.5]
8.3.4 TDD/TDD Cell Re-selection in CELL_FACH	2.5	0.1	[1.236]	[154]	[5]	[1.5]
8.3.5 TDD/TDD Cell Re-selection in CELL_PCH	8	0.1	[1.236]	[154]	[5]	[1.5]
8.3.6 TDD/TDD Cell Re-selection in URA_PCH	8	0.1	[1.236]	[154]	[5]	[1.5]

### F.6.2.9 Practical Use (informative)

See figure F.6.2.9:

The early fail limit represents formula (1) in F.6.2.5. The range of validity is  $n_e \geq 5$  to  $n_e = 154$

The early pass limit represents the formula (2) in F.6.2.5. The range of validity is  $n_e = 1$  to  $n_e = 154$ . See note 1. The intersection co-ordinates of both curves are : target number of bad delays  $n_e = 154$  and test limit  $TL = 1.236$ .

A typical delay test, calculated from the number of samples and errors (F.6.2.2) using experimental method (1) or (2) (see F.6.2.4.2. calculation assumptions) runs along the yellow trajectory. With an good delay the trajectory goes down vertically. With a bad delay it jumps up right. The tester checks if the ER test intersects the early fail or early pass limits.

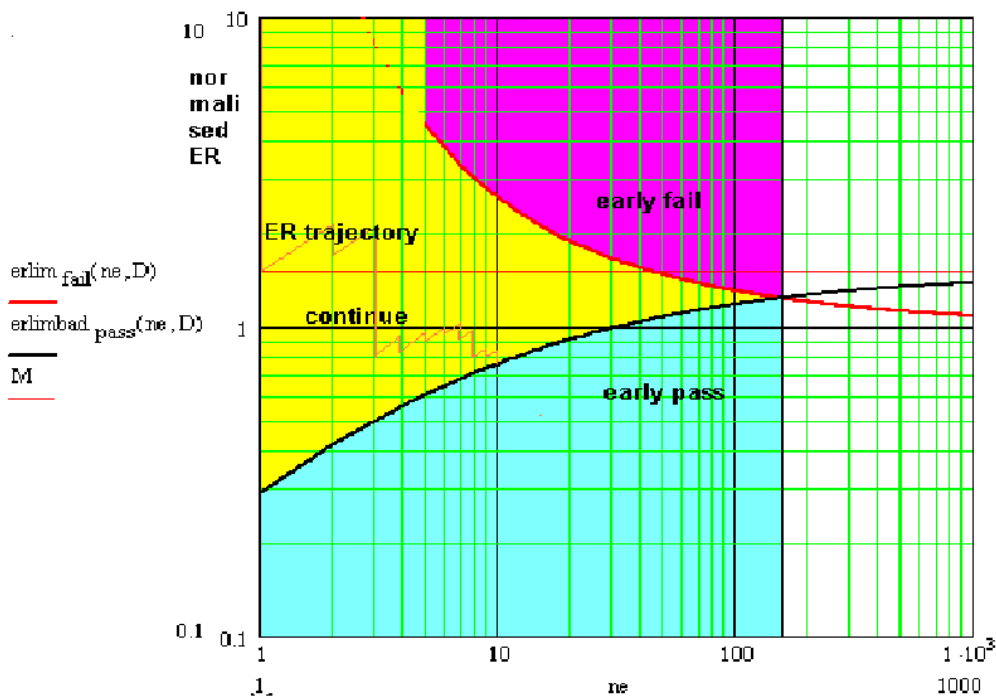

Figure F.6.2.9

NOTE 1: At the beginning of the test, an artificial bad delay is introduced. This ensures that an ideal DUT meets the valid range of the early pass limit. In addition this ensures that the complementary experiment (F.6.2.4.2. bullet point (2)) is applicable as well. For the check against the early fail limit the artificial bad delay sample, introduced at the beginning of the test, is disregarded.

Due to the nature of the test, namely discrete bad delay events, the early fail condition shall not be valid, when fractional bad delays  $<1$  are used to calculate the early fail limit: Any early fail decision is postponed until number of errors  $ne \geq [5]$ .

## F.6.3 Statistical Testing of HSDPA Receiver Performance

### F.6.3.1 Definition

Information Bit Throughput R:

The measured information bit throughput R is defined as the sum (in kilobits) of the information bit payloads (excluding the 24-bit HS-DSCH CRC) successfully received during the test interval, divided by the duration of the test interval (in seconds).

### F.6.3.2 Mapping throughput to block error ratio

- In measurement practice the UE indicates successfully received information bit payload by signalling an ACK to the SS.  
If payload is received, but damaged and cannot be decoded, the UE signals a NACK.
- Only the ACK and NACK signals, not the data bits received, are accessible to the SS.  
The number of bits is known in the SS from knowledge of what payload was sent.
- For fixed reference channel the number of bits in a TTI is fixed during one test.
- The time in the measurement interval is composed of successful TTIs (ACK), unsuccessful TTIs (NACK) and DTX-TTIs.

- e) DTX-TTIs occur regularly according to the test. (regDTX).  
In real live this is the time when other UEs are served.  
regDTX vary from test to test but are fixed within the test.
- f) Additional DTX-TTIs occur statistically when the UE is not responding ACK or NACK where it should.  
(statDTX)  
This may happen when the UE was not expecting data or decided that the data were not intended for it.

The pass / fail decision is done by observing the:

- number of NACKs
- number of ACKs and
- number of statDTXs (regDTX is implicitly known to the SS)

The ratio  $(\text{NACK} + \text{statDTX}) / (\text{NACK} + \text{statDTX} + \text{ACK})$  is the Block Error Ratio BLER. For fixed reference channel, taking into account the time consumed by the ACK-, NACK-, and DTX-TTIs (regular and statistical), BLER can be mapped unambiguously to throughput for any single test.

### F.6.3.3 Bad DUT factor

NOTE: Data throughput in a communication system is of statistical nature and must be measured and decided pass or fail. The specified limit of throughput related to the ideal throughput in different throughput tests is in the range of a few % to near 100%. To make it comparable with BER, we define the complement of the relative throughput: BLER as defined above. Complementary this is in the range of near 100% down to a few % For e.g. BLER = 1%, the currently in BER BLER used Bad DUT factor M=1.5 is highly meaningful. For e.g. BLER = 99%, the currently used M=1.5 obviously meaningless.

An appropriate definition of the bad DUT factor is illustrated in figure F.6.3.3: constant and variable Bad DUT factor.

It illustrates how to find the Bad BLER when the nominal BLER is given.

- 1) In the range  $0\% < \text{nominal BLER} > 10\%$  the Bad DUT factor is constant 1.5
- 2) In the range  $90\% < \text{bad BLER} > 100\%$  it decreases to 1. (symmetrical to (1))
- 3) The range in between is interpolated by an arc section.

The example shows: nominal BLER=35,6%  $\rightarrow$  bad BLER=47.67.5%  $\rightarrow$  M=1.34

(blue mapping)

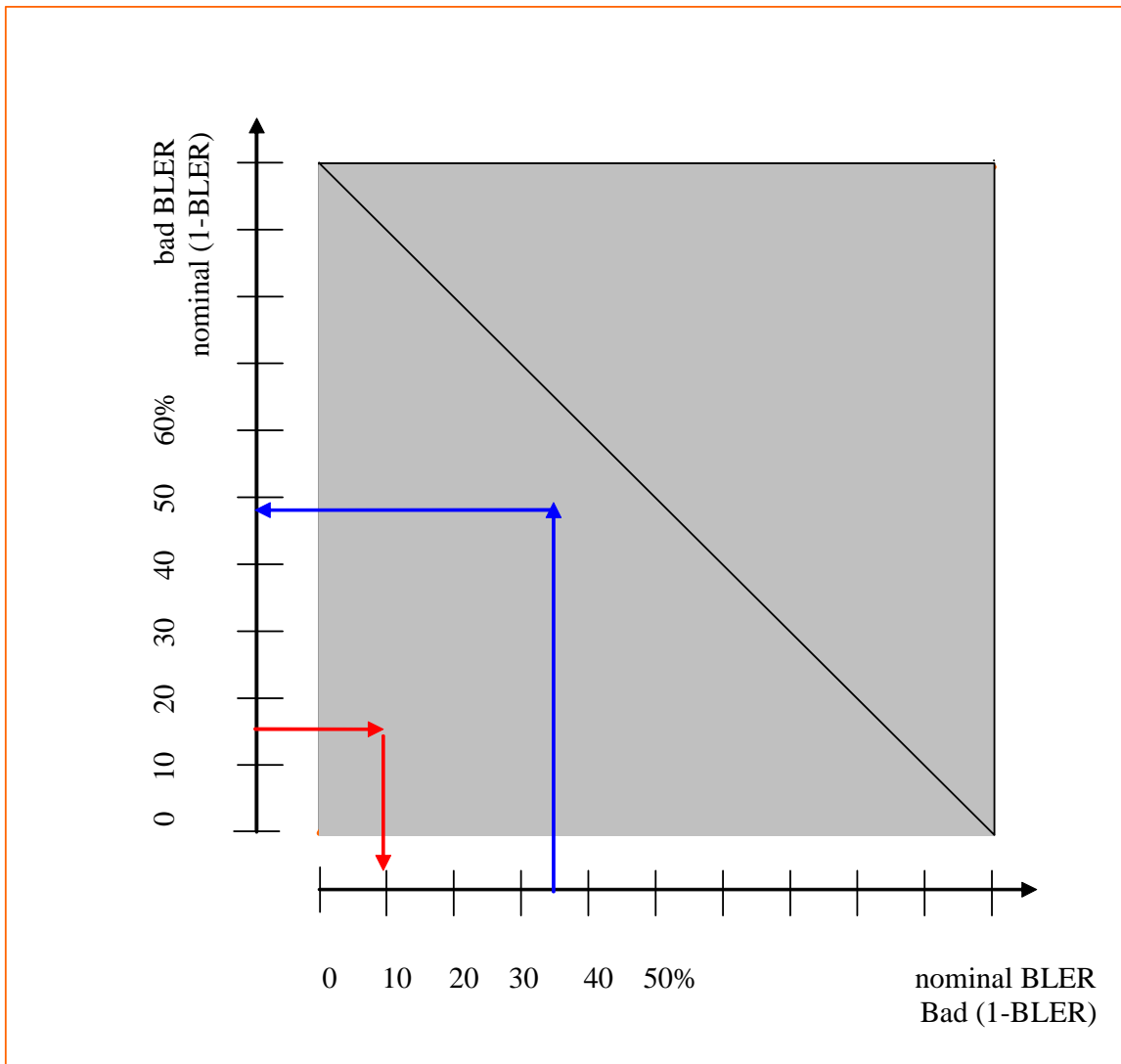

**Figure F.6.3.3: constant and variable Bad DUT factor**

Formula:

For  $0 < \text{BLER} \leq 0.1$   $M = 1.5$

$$M(\text{BLER}) := \frac{\sqrt{r^2 - (\text{BLER} - 2.35)^2}}{\text{BLER}} - \frac{1.35}{\text{BLER}}$$

For  $0.1 < \text{BLER} < 0.9$

For  $0.9 \leq \text{BLER} < 1$   $M(\text{BLER}) = 2/3\text{BLER} + 1/3$

With BLER: nominal Block Error Ratio ( $0 < \text{BLER} < 1$ )

With  $r = 2.70415$  (Radius of the arc)

### F.6.3.3.1 Bad DUT factor, range of applicability

Inaccuracy is one practical reason to avoid the grey shaded area of figure F.6.3.3: constant and variable Bad DUT factor. For BLER near 1 the Bad DUT factor M is near 1. For  $M=1$ , exactly, the pass and fail criteria do not intersect. The test never is finalised.

For M near 1 the pass and fail criteria exhibit a very smooth intersection. In addition the binomial distribution and its inverse are of discrete nature. Therefore the test limit and the number of samples is calculable only very ambiguous.

It is proposed to apply the bad DUT factor only in the not shaded area of figure F.6.3.3.

This is done by the following:

BLER mode:

Use BLER as defined above in the range of 0 to 50%, use  $M > 1$  as defined above.

The Test Limit will be  $>$  the Test Requirement in the table F.6.3.5. below.

Relative Throughput mode:

If BLER is in the range 50 to 100%, use 1-BLER instead. Use  $m < 1$  instead of  $M$ .

1-BLER is the relative throughput with respect to the ideal throughput.

As a consequence, the Test Limit  $<$  Test Requirement

Formula for  $m$ :

For  $0 < (1-\text{BLER}) \leq 0.15$   $m = 1/1.5$

$$m := \frac{2.35 - \sqrt{r^2 - [(1 - \text{BLER}) + 1.35]^2}}{(1 - \text{BLER})}$$

For  $0.15 < (1-\text{BLER}) < 0.85$

In the figure F.6.3.3: this is represented by the red mapping.

The tables F.6.3.5. below distinguish between  $m$  and  $M$ .

### F.6.3.4 Minimum Test time

Same as with BER BLER there is a minimum test time is necessary for multipath fading profiles with the same justification:

profile	Minimum Test time
PA3, PB3	164s
VA30	16.4s
VA 120	4.1s

### F.6.3.5 Pass fail decision rules

The purpose of tables F.6.3.5.1 to F.6.3.5.2 is to decide throughput pass or fail.

(the  $I_{or}/I_{oc}$  levels are only for reference)

Meaning of a decision:

- A passed DUT is not worse than a Bad DUT with 95% confidence level.
- A failed DUT is not better than a Limit DUT with 95% confidence level.

The minimum Test Time is

- 1) the minimum test time due to statistical reasons

( To ensure the confidence level, the test must be continued until a certain number of samples (NACK+statDTX +ACK) is reached.)

- 2) the minimum test time due to multipath fading.

The longer test time applies. It is marked in table F.6.3.5. which one applies.

Statistical independence:

If a process works within an incremental redundancy sequence, the samples are not independent. The incremental redundancy sequence for every process must be finalised, successfully or unsuccessfully, on or beyond the minimum test time.

Then the BLER (or 1-BLER) is compared with the Test Limit to decide pass or fail.

NOTE: It is FFS, if correlation within groups of retransmissions may influence the confidence level of the test.

Formula:

The theory, to derive the minimum number of samples and the Test Limit, takes into consideration that BLER is in the range of near 0% to near 100%. Hence it is based on the binomial distribution and its inverse cumulative function: qbinom:

For the BLER test mode:

$$ne_{low}=qbinom(D,ns,M*BLER_{limit}) \quad (1)$$

$$ne_{high}=qbinom(1-D,ns,BLER_{limit}) \quad (2)$$

given: 1-D: confidence level= 95%

$BLER_{limit}$ =Block error ratio at the limit

M: Bad DUT factor >1

Input: ns: number of samples (NACK+ statDTX + ACK)

Output ne: number of events (NACK+ statDTX)

The intersection of (1) and (2) is the Test Limit with the coordinates: ns and ne

For the Relative Throughput test mode:

$$ne_{low}=qbinom(D,ns,1-BLER_{limit}) \quad (3)$$

$$ne_{high}=qbinom(1-D,ns,m*(1-BLER_{limit})) \quad (4)$$

given: 1-D: confidence level= 95%

$1-BLER_{limit}$ = Relative Throughput at the limit

m: Bad DUT factor <1

Input: ns: number of samples (NACK+ statDTX + ACK)

Output ne: number of events (ACK)

The intersection of (3) and (4) is the Test Limit with the coordinates: ns and ne

NOTE: In contrast to BER BLER test, this approach does not contain any test time optimisation.

(early pass, early fail)

Nomenclature used in the tables F.6.3.5 below:

- NACK+ statDTX + ACK is summarised as No of samples
- NACK+ statDTX is summarised as No of errors
- ACK is summarised as No of successes
- In the BLER test mode the ratio: No of errors/ No of samples is recorded. In this mode a pass is below the test limit
- In the Relative Throughput test mode (1-BLER) the ratio: No of successes/ No of samples is recorded. In this mode a pass is above the test limit

- The test mode, used, is indicated in the rightmost column with BL or RT
- The transition from the BL to the RT test mode can also be seen in the column relative test requirement: BLER%  $\rightarrow$  (1-BLER%)
- The generic term for No of errors (BLER mode) or No of successes (Relative Throughput mode) is No of events. This is used in the table column Test Limit.

**Table F.6.3.5.1: Test case 9.3.1A for fixed reference measurement channel requirements for 0.5 Mbps UE class QPSK of 1.28Mcps HS-DSCH**

Single link performance	Absolute Test requirement (kbps)		Relative Test requirement (normalized to ideal=199.2kbps)  No of events / No of samples in %	Test limit expressed as No of events / min No of samples  ( Bad DUT factor)	Min No of samples  ( number of events to pass)  Mandatory, if applicable	Test time in s  Mandatory if fading,  Informative and approx. if statistical	BL / RT
	lor/loc=10dB						
Test1 QPSK	PA3	160	19.68%	54/226 (M=1.4527)	N.A.	164s (fading)	BL
Test2	PB3	170	14.66%	52/289 (M=1.4845)	N.A.	164s (fading)	BL
Test3	VA30	161	19.18%	55/236 (M=1.4562)	N.A.	16.4s(fading)	BL
Test4	VA120	153	23.20%	57/204 (M=1.4277)	N.A.	4.1s(fading)	BL

**Table F.6.3.5.2: Test case 9.3.1B for fixed reference measurement channel requirements for 1.1 Mbps UE class 16QAM of 1.28Mcps HS-DSCH**

Single link performance	Absolute Test requirement (kbps)		Relative Test requirement (normalized to ideal=578.6kbps)  No of events / No of samples in %  No of events/No of samples in % BL $\rightarrow$ (RT)	Test limit expressed as No of events / min No of samples  ( Bad DUT factor)	Min No of samples  ( number of events to pass)  Mandatory, if applicable	Test time in s  Mandatory if fading,  Informative and approx. if statistical	BL / RT
	lor/loc=15dB						
Test1	PA3	388	32.94%	69/179 (M=1.3573)	N.A.	164s (fading)	BL
Test2	PB3	347	40.03%	78/169 (M=1.3085)	N.A.	164s (fading)	BL
Test3	VA30	316	45.39%	84/163 (M=1.2735)	N.A.	16.4s(fading)	BL
Test4	VA120	274	52.74% $\rightarrow$ (47.36%)	70/170 (m=0.7459)	N.A.	4.1s(fading)	RT

**Table F.6.3.5.3: Test case 9.3.1C for fixed reference measurement channel requirements for 1.6 Mbps UE class QPSK of 1.28Mcps HS-DSCH**

Single link performance	Absolute Test requirement (kbps)		Relative Test requirement (normalized to ideal=357.4kbps) No of events / No of samples in %	Test limit expressed as No of events / min No of samples  ( Bad DUT factor)	Min No of samples  ( number of events to pass)  Mandatory, if applicable	Test time in s  Mandatory if fading,  Informative and approx. if statistical	BL / RT
	lor/loc=10dB						
Test1	PA3	270	24.45%	59/201 (M=1.4186)	N.A.	164s (fading)	BL
Test2	PB3	278	22.22%	57/212 (M=1.4348)	N.A.	164s (fading)	BL
Test3	VA30	259	27.53%	60/183 (M=1.3962)	N.A.	16.4s(fading)	BL
Test4	VA120	242	32.29%	65/171 (M=1.3620)	N.A.	4.1s(fading)	BL

**Table F.6.3.5.4: Test case 9.3.1C for fixed reference measurement channel requirements for 1.6 Mbps UE class 16QAM of 1.28Mcps HS-DSCH**

Single link performance	Absolute Test requirement (kbps)		Relative Test requirement (normalized to ideal=634.6kbps) No of events / No of samples in %	Test limit expressed as No of events / min No of samples  ( Bad DUT factor)	Min No of samples  ( number of events to pass)  Mandatory, if applicable	Test time in s  Mandatory if fading,  Informative and approx. if statistical	BL / RT
	lor/loc=15dB						
Test5	PA3	488	23.10%	57/205 (M=1.4284)	N.A.	164s (fading)	BL
Test6	PB3	471	25.78%	58/188 (M=1.4089)	N.A.	164s (fading)	BL
Test7	VA30	431	32.18%	65/172 (M=1.3634)	N.A.	16.4s(fading)	BL
Test8	VA120	377	40.59%	78/167 (M=1.3047)	N.A.	4.1s(fading)	BL



**Table F.6.3.5.5: Test case 9.3.1D for fixed reference measurement channel requirements for 2.2 Mbps UE class QPSK of 1.28Mcps HS-DSCH**

Single link performance	Absolute Test requirement (kbps)		Relative Test requirement (normalized to ideal=539kbps)  No of events / No of samples in %	Test limit expressed as No of events / min No of samples  ( Bad DUT factor)	Min No of samples  ( number of events to pass)  Mandatory, if applicable	Test time in s  Mandatory if fading,  Informative and approx. if statistical	BL / RT
Test1	PA3	360	33.21%	67/172 (M=1.3554)	N.A.	164s (fading)	BL
Test2	PB3	343	36.36%	71/168 (M=1.3334)	N.A.	164s (fading)	BL
Test3	VA30	320	40.63%	79/169 (M=1.3045)	N.A.	16.4s(fading)	BL
Test4	VA120	275	48.98%	92/167 (M=1.2509)	N.A.	4.1s(fading)	BL

**Table F.6.3.5.6: Test case 9.3.1D for fixed reference measurement channel requirements for 2.2 Mbps UE class 16QAM of 1.28Mcps HS-DSCH**

Single link performance	Absolute Test requirement (kbps)		Relative Test requirement (normalized to ideal=782.2kbps)  No of events / No of samples in %	Test limit expressed as No of events / min No of samples  ( Bad DUT factor)	Min No of samples  ( number of events to pass)  Mandatory, if applicable	Test time in s  Mandatory if fading,  Informative and approx. if statistical	BL / RT
Test5	PA3	615	21.38%	57/220 (M=1.4408)	N.A.	164s (fading)	BL
Test6	PB3	606	22.53%	56/206 (M=1.4325)	N.A.	164s (fading)	BL
Test7	VA30	554	29.17%	63/182 (M=1.3843)	N.A.	16.4s(fading)	BL
Test8	VA120	493	36.97%	71/165 (M=1.3292)	N.A.	4.1s(fading)	BL

**Table F.6.3.5.7: Test case 9.3.1E for fixed reference measurement channel requirements for 2.8 Mbps UE class QPSK of 1.28Mcps HS-DSCH**

Single link performance	Absolute Test requirement (kbps)		Relative Test requirement (normalized to ideal=621kbps)  No of events / No of samples in %	Test limit expressed as No of events / min No of samples  ( Bad DUT factor)	Min No of samples  ( number of events to pass)  Mandatory, if applicable	Test time in s  Mandatory if fading,  Informative and approx. if statistical	BL / RT
	lor/loc=10dB						
Test1	PA3	461	25.76%	60/195 (M=1.4090)	N.A.	164s (fading)	BL
Test2	PB3	470	24.32%	59/202 (M=1.4196)	N.A.	164s (fading)	BL
Test3	VA30	438	29.47%	63/180 (M=1.3822)	N.A.	16.4s(fading)	BL
Test4	VA120	409	34.14%	69/173 (M=1.3489)	N.A.	4.1s(fading)	BL

**Table F.6.3.5.8: Test case 9.3.1E for fixed reference measurement channel requirements for 2.8 Mbps UE class 16QAM of 1.28Mcps HS-DSCH**

Single link performance	Absolute Test requirement (kbps)		Relative Test requirement (normalized to ideal=1278.6kbps)  No of events / No of samples in %	Test limit expressed as No of events / min No of samples  ( Bad DUT factor)	Min No of samples  ( number of events to pass)  Mandatory, if applicable	Test time in s  Mandatory if fading,  Informative and approx. if statistical	BL / RT
	lor/loc=15dB						
Test5	PA3	890	30.39%	64/178 (M=1.3755)	N.A.	164s (fading)	BL
Test6	PB3	810	36.65%	72/169 (M=1.3315)	N.A.	164s (fading)	BL
Test37	VA30	730	42.91%	80/163 (M=1.2895)	N.A.	16.4s(fading)	BL
Test8	VA120	630	50.73%→ ( 49.27% )	71/165 (m=0.7528)	N.A.	4.1s(fading)	RT

Table F.6.3.5.9 Test case 9.2.1 demodulation of 3.84Mcps HS-DSCH(QPSK)

Single link Performance	Absolute Test requirement (kbps)		Relative test requirement (normalized to: ideal for tests 1,2,3=2649.6 kbps ideal for test 4=2317.6 kbps)  No of events/No of samples in % BL → (RT)	Test limit expressed as No of events/min No of samples  (Bad DUT factor)	Min No of samples  (number of events to pass)  Mandatory if applicable	Test time in s  Mandatory if fading  Informative and approx. if statistical	BL / RT
QPSK							
Test number							
1 ( $\hat{I}_{or}/I_{oc} = 8,5$ dB)	PA3	1300	50.94%→ (49.06%)	77/179 (m = 0.752)	N.A.	164s (fading)	RT
2 ( $\hat{I}_{or}/I_{oc} = 9,0$ dB)	PB3	1300	50.94%→ (49.06%)	77/179 (m = 0.752)	N.A.	164s (fading)	RT
3 ( $\hat{I}_{or}/I_{oc} = 9,75$ dB)	VA30	1300	50.94%→ (49.06%)	77/179 (m = 0.752)	N.A.	164s (fading)	RT
4 ( $\hat{I}_{or}/I_{oc} = 11,5$ dB)	VA12 0	1400	39.59%	80/175 (M=1.312)	N.A.	164s (fading)	BL

Table F.6.3.5.10 Test case 9.2.1 demodulation of 3.84Mcps HS-DSCH(16QAM)

Single link Performance	Absolute Test requirement (kbps)		Relative test requirement (normalized to: ideal for tests 1,2,3=5299.6 kbps ideal for tests 4=3477.3 kbps)  No of events/No of samples in % BL → (RT)	Test limit expressed as No of events/min No of samples  (Bad DUT factor)	Min No of samples  (number of events to pass)  Mandatory if applicable	Test time in s  Mandatory if fading  Informative and approx. if statistical	BL / RT
QPSK							
Test number							
1 ( $\hat{I}_{or}/I_{oc} = 16.0$ dB)	PA3	2600	50.94%→ (49.06%)	77/179 (m = 0.752)	N.A.	164s (fading)	RT
2 ( $\hat{I}_{or}/I_{oc} = 17.5$ dB)	PB3	2600	50.94%→ (49.06%)	77/179 (m = 0.752)	N.A.	164s (fading)	RT
3 ( $\hat{I}_{or}/I_{oc} = 18.5$ dB)	VA30	2600	50.94%→ (49.06%)	77/179 (m = 0.752)	N.A.	164s (fading)	RT
4 ( $\hat{I}_{or}/I_{oc} = 14.5$ dB)	VA12 0	1600	53.99%→ (46.01%)	72/180 (M=0.741)	N.A.	164s (fading)	BL

Table F.6.3.5.11 Test case 9.4.1 demodulation of 7.68Mcps HS-DSCH(QPSK)

Single link Performance	Absolute Test requirement (kbps)		Relative test requirement (normalized to: ideal =2119.68 kbps)	Test limit expressed as No of events/min No of samples	Min No of samples (number of events to pass)	Test time in s	BL / RT
QPSK			No of events/No of samples in % BL → (RT)	(Bad DUT factor)	Mandatory if applicable	Mandatory if fading Informative and approx. if statistical	
Test number							
1 ( $\hat{I}_{or}/I_{oc} = 5,2$ dB)	PA3	880	58.48%→ (41.52%)	68/190 (m = 0.7261)	N.A.	164s (fading)	RT
2 ( $\hat{I}_{or}/I_{oc} = 5,5$ dB)	PB3	880	58.48%→ (41.52%)	68/190 (m = 0.7261)	N.A.	164s (fading)	RT
3 ( $\hat{I}_{or}/I_{oc} = 6,2$ dB)	VA30	880	58.48%→ (41.52%)	68/190 (m = 0.7261)	N.A.	164s (fading)	RT
4 ( $\hat{I}_{or}/I_{oc} = 6,2$ dB)	VA12 0	880	58.48%→ (41.52%)	68/190 (m = 0.7261)	N.A.	164s (fading)	BL

Table F.6.3.5.12 Test case 9.4.1 demodulation of 7.68Mcps HS-DSCH(16QAM)

Single link Performance	Absolute Test requirement (kbps)		Relative test requirement (normalized to: ideal =4239.36 kbps)	Test limit expressed as No of events/min No of samples	Min No of samples (number of events to pass)	Test time in s	BL / RT
QPSK			No of events/No of samples in % BL → (RT)	(Bad DUT factor)	Mandatory if applicable	Mandatory if fading Informative and approx. if statistical	
Test number							
1 ( $\hat{I}_{or}/I_{oc} = 11.1$ dB)	PA3	1765	58.37%→ (41.63%)	77/179 (m = 0.7264)	N.A.	164s (fading)	RT
2 ( $\hat{I}_{or}/I_{oc} = 13.2$ dB)	PB3	1765	58.37%→ (41.63%)	77/179 (m = 0.752)	N.A.	164s (fading)	RT
3 ( $\hat{I}_{or}/I_{oc} = 13.7$ dB)	VA30	1765	58.37%→ (41.63%)	77/179 (m = 0.752)	N.A.	164s (fading)	RT
4 ( $\hat{I}_{or}/I_{oc} = 13.6$ dB)	VA12 0	1765	58.37%→ (41.63%)	72/180 (M=0.741)	N.A.	164s (fading)	BL

**Table F.6.3.5.13 Maximum Input Level for HS-PDSCH Reception (16QAM)**

Maximum Input Level for HS-PDSCH Reception (16QAM)	Absolute Test requirement (kbps)	Relative test requirement (normalized to ideal=578.6 kbps) No of events/No of samples in %	Test limit expressed as No of events/min No of samples (Bad DUT factor)	Min No of samples (number of events to pass) Mandatory if applicable	Test time in s Mandatory if fading Informative and approx. if statistical	BL / RT
16 QAM						
	500	13.58%	53/317 (M=1.4899)	N.A	2.8s (stat)	BL

# Annex G (normative): Environmental conditions

## G.1 General

This normative annex specifies the environmental requirements of the UE. Within these limits the requirements of the present documents shall be fulfilled.

## G.2 Environmental requirements

The requirements in this clause apply to all types of UE(s)

### G.2.1 Temperature

The UE shall fulfil all the requirements in the full temperature range of:

+15°C to +35°C	for normal conditions (with relative humidity of 25 % to 75 %)
-10°C to +55°C	for extreme conditions (see IEC publications 68-2-1 and 68-2-2)

Outside this temperature range the UE, if powered on, shall not make ineffective use of the radio frequency spectrum. In no case shall the UE exceed the transmitted levels as defined in TS 25.102 [1] for extreme operation.

Some tests in the present document are performed also in extreme temperature conditions. These test conditions are denoted as TL (temperature low, -10°C) and TH (temperature high, +55°C).

### G.2.2 Voltage

The UE shall fulfil all the requirements in the full voltage range, i.e. the voltage range between the extreme voltages.

The manufacturer shall declare the lower and higher extreme voltages and the approximate shutdown voltage. For the equipment that can be operated from one or more of the power sources listed below, the lower extreme voltage shall not be higher, and the higher extreme voltage shall not be lower than that specified below.

Power source	Lower extreme voltage	Higher extreme voltage	Normal conditions voltage
AC mains	0,9 * nominal	1,1 * nominal	nominal
Regulated lead acid battery	0,9 * nominal	1,3 * nominal	1,1 * nominal
Non regulated batteries: Leclanché / lithium Mercury/nickel & cadmium	0,85 * nominal 0,90 * nominal	Nominal Nominal	Nominal Nominal

Outside this voltage range the UE if powered on, shall not make ineffective use of the radio frequency spectrum. In no case shall the UE exceed the transmitted levels as defined in [1] TS 25.102 for extreme operation. In particular, the UE shall inhibit all RF transmissions when the power supply voltage is below the manufacturer declared shutdown voltage.

Some tests in the present document are performed also in extreme voltage conditions. These test conditions are denoted as VL (lower extreme voltage) and VH (higher extreme voltage).

## G.2.3 Vibration

The UE shall fulfil all the requirements when vibrated at the following frequency/amplitudes:

<b>Frequency</b>	<b>ASD (Acceleration Spectral Density) random vibration</b>
5 Hz to 20 Hz	0,96 m <sup>2</sup> /s <sup>3</sup>
20 Hz to 500 Hz	0,96 m <sup>2</sup> /s <sup>3</sup> at 20 Hz, thereafter –3 dB/Octave

Outside the specified frequency range the UE, if powered on, shall not make ineffective use of the radio frequency spectrum. In no case shall the UE exceed the transmitted levels as defined in TS 25.102 [1] for extreme operation.

## G.2.4 Specified frequency range

The manufacturer shall declare, which of the frequency bands defined in clause 4.2 is supported by the UE.

Some tests in the present document are performed also in low, mid and high range of the operating frequency band of the UE. The UARFCN's to be used for low, mid and high range are defined in TS 34.108 [3] clause 5.1.2.



## Annex H (normative): Terminal Baseline and Service Implementation Capabilities (TDD)

### H.1 Baseline Implementation Capabilities of 3.84 Mcps TDD

**Table H.1: Baseline implementation capabilities of 3.84 Mcps TDD**

Capability TDD	Clause	UE*	Comments
Chip rate 3,84 Mcps		M	
Frequency bands: (uplink and downlink)			
1900-1920 MHz		M	
2010-2025 MHz		M	
1850-1910 MHz		M	
1930-1990 MHz		M	
1910-1930 MHz		M	
Other spectrum		O	As Declared
Carrier raster 200 kHz		M	
UE maximum output power	6.2.1	M	2, 3

(\* M = mandatory, O = optional)

- The special conformance testing functions and the logical test interface as specified in TS 34.109 [3]. This issue is currently under investigation.
- Uplink reference measurement channel 12,2 kbps (TDD), TS 25.102 [1] clause A.2.1.
- Downlink reference measurement channel 12,2 kbps (TDD), TS 25.102 [1] clause A.2.2.

### H.1A Baseline Implementation Capabilities of 1.28 Mcps TDD

**Table H.1A: Baseline implementation capabilities of 1.28 Mcps TDD**

Capability TDD	Clause	Value range
Chip rate 1.28 Mcps		Yes
Frequency bands: (uplink and downlink)	25.102 clause 5.2[1]	a), b), c), a+b), a+c), b+c), a+b+c)
UE maximum output power	25.102 clause 6.2.1[1]	2, 3

- The special conformance testing functions and the logical test interface as specified in TS 34.109 [3]. This issue is currently under investigation.
- Uplink reference measurement channel 12,2 kbps (TDD), TS 25.102 [1] clause A.2.1.
- Downlink reference measurement channel 12,2 kbps (TDD), TS 25.102 [1] clause A.2.2.

## H.1B Baseline Implementation Capabilities of 7.68 Mcps TDD

**Table H.1: Baseline implementation capabilities of 7.68 Mcps TDD**

Capability TDD	Clause	UE*	Comments
Chip rate 7,68 Mcps		M	
Frequency bands: (uplink and downlink)			
1900-1920 MHz		M	
2010-2025 MHz		M	
1850-1910 MHz		M	
1930-1990 MHz		M	
1910-1930 MHz		M	
2570-2620 MHz		M	
Other spectrum		O	As Declared
Carrier raster 200 kHz		M	
UE maximum output power	6.2.1	M	2, 3

(\* M = mandatory, O = optional)

- The special conformance testing functions and the logical test interface as specified in TS 34.109 [3]. This issue is currently under investigation.
- Uplink reference measurement channel 12,2 kbps (TDD), TS 25.102 [1] clause A.2.1.3.
- Downlink reference measurement channel 12,2 kbps (TDD), TS 25.102 [1] clause A.2.2.3.

## H.2 Service Implementation Capabilities:

- Downlink reference measurement channel 64 kbps (TDD), TS 25.102 clause A.2.3.
- Downlink reference measurement channel 144 kbps (TDD), TS 25.102 clause A.2.4.
- Down-link reference measurement channel 384 kbps (TDD), TS 25.102 clause A.2.5.
- BCH Reference Measurement Channel(TDD),TS 25.102 clause A.2.6.

## Annex I (normative): Default Message Contents

This Annex contains the default values of common messages, other than those described in TS 34.108. The messages are primarily concerning the RRM test cases in clause 8 and unless indicated otherwise in specific test cases, shall be transmitted and checked by the system simulator. The necessary messages are listed in alphabetical order.

In this Annex, decimal values are normally used. However, sometimes, a hexadecimal value, indicated by an "H", or a binary value, indicated by a "B" is used.

Contents of MEASUREMENT REPORT message for Intra frequency 3,84 Mcps option TDD test cases

Information Element	Value/remark
Message Type	
Integrity check info	The presence of this IE is dependent on IXIT statements in TS 34.123-2. If integrity protection is indicated to be active, this IE shall be present with the values of the sub IEs as stated below. Else, this IE and the sub-IEs shall be absent.
- Message authentication code	This IE is checked to see if it is present. The value is compared against the XMAC-I value computed by SS.
- RRC Message sequence number	This IE is checked to see if it is present. The value is used by SS to compute the XMAC-I value.
Measurement identity	1
Measured Results	
- Intra-frequency measured results list	
- Cell measured results	
- Cell Identity	Not present
- SFN-SFN observed time difference	Checked that this IE is present
- Cell synchronisation information	
- CHOICE mode	TDD
- OFF	Checked that this IE is present
- CHOICE mode	TDD
- Cell Parameters ID	4
- Primary CCPCH RSCP	Checked that this IE is present
- Pathloss	Checked that this IE is present
- Timeslot ISCP	Checked that this IE is present
Measured results on RACH	Checked that this IE is absent
Additional measured results	Checked that this IE is absent
Event results	Checked that this IE is absent

## Contents of MEASUREMENT REPORT message for Intra frequency 1,28 Mcps option TDD test cases

Information Element/Group name	Semantics description
Message Type	
Integrity check info	The presence of this IE is dependent on IXIT statements in TS 34.123-2. If integrity protection is indicated to be active, this IE shall be present with the values of the sub IEs as stated below. Else, this IE and the sub-IEs shall be absent.
- Message authentication code	This IE is checked to see if it is present. The value is compared against the XMAC-I value computed by SS.
- RRC Message sequence number	This IE is checked to see if it is present. The value is used by SS to compute the XMAC-I value.
Measurement identity	1
Measured Results	
- Intra-frequency measured results list	
- Cell measured results	
- Cell Identity	Not present
- Cell synchronisation information	
- CHOICE mode	TDD
- COUNT-C-SFN frame difference	Checked that this IE is present
- OFF	Checked that this IE is present
- CHOICE mode	TDD
- Cell Parameters ID	4
- Primary CCPCH RSCP	Checked that this IE is present
- Pathloss	Checked that this IE is absent
- Timeslot ISCP	Checked that this IE is absent
Measured Results on RACH	Checked that this IE is absent
Additional Measured results	Checked that this IE is absent
Event results	Checked that this IE is absent

## Contents of MEASUREMENT REPORT message for Intra frequency 7,68 Mcps option TDD test cases

Information Element	Value/remark
Message Type	
Integrity check info	The presence of this IE is dependent on IXIT statements in TS 34.123-2. If integrity protection is indicated to be active, this IE shall be present with the values of the sub IEs as stated below. Else, this IE and the sub-IEs shall be absent.
- Message authentication code	This IE is checked to see if it is present. The value is compared against the XMAC-I value computed by SS.
- RRC Message sequence number	This IE is checked to see if it is present. The value is used by SS to compute the XMAC-I value.
Measurement identity	1
Measured Results	
- Intra-frequency measured results list	
- Cell measured results	
- Cell Identity	Not present
- Cell synchronisation information	
- CHOICE mode	TDD
- COUNT-C-SFN frame difference	Checked that this IE is present
- OFF	Checked that this IE is present
- CHOICE mode	TDD
- Cell Parameters ID	4
- Primary CCPCH RSCP	Checked that this IE is present
- Pathloss	Checked that this IE is present
- Timeslot ISCP	Checked that this IE is present
Measured results on RACH	Checked that this IE is absent
Additional measured results	Checked that this IE is absent
Event results	Checked that this IE is absent

## Contents of MEASUREMENT REPORT message for Inter frequency 3,84 Mcps option TDD test cases

Information Element	Value/remark
Message Type	
Integrity check info	The presence of this IE is dependent on IXIT statements in TS 34.123-2. If integrity protection is indicated to be active, this IE shall be present with the values of the sub IEs as stated below. Else, this IE and the sub-IEs shall be absent.
- Message authentication code	This IE is checked to see if it is present. The value is compared against the XMAC-I value computed by SS.
- RRC Message sequence number	This IE is checked to see if it is present. The value is used by SS to compute the XMAC-I value.
Measurement identity	1
Measured Results	
- Inter-frequency measured results list	
- UTRA Carrier RSSI	Checked that this IE is present
- Inter-frequency cell measurement results	
- Cell measured results	
- Cell Identity	Not present
- SFN-SFN observed time difference	Checked that this IE is present
- Cell synchronisation information	
- CHOICE mode	TDD
- OFF	Checked that this IE is present
- CHOICE mode	TDD
- Cell Parameters ID	4
- Primary CCCPCH RSCP	Checked that this IE is present
- Pathloss	Checked that this IE is present
- Timeslot ISCP	Checked that this IE is present
Measured results on RACH	Checked that this IE is absent
Additional measured results	Checked that this IE is absent
Event results	Checked that this IE is absent

## Contents of MEASUREMENT REPORT message for Inter frequency 1,28 Mcps option TDD test cases

Information Element	Value/remark
Message Type	
Integrity check info	The presence of this IE is dependent on IXIT statements in TS 34.123-2. If integrity protection is indicated to be active, this IE shall be present with the values of the sub IEs as stated below. Else, this IE and the sub-IEs shall be absent.
- Message authentication code	This IE is checked to see if it is present. The value is compared against the XMAC-I value computed by SS.
- RRC Message sequence number	This IE is checked to see if it is present. The value is used by SS to compute the XMAC-I value.
Measurement identity	1
Measured Results	
- Inter-frequency measured results list	
- UTRA Carrier RSSI	Checked that this IE is present
- Inter-frequency cell measurement results	
- Cell measured results	
- Cell Identity	Not present
- SFN-SFN observed time difference	Checked that this IE is present
- Cell synchronisation information	
- CHOICE mode	TDD
- OFF	Checked that this IE is present
- CHOICE mode	TDD
- Cell Parameters ID	4
- Primary CCCPCH RSCP	Checked that this IE is present
- Pathloss	Checked that this IE is present
- Timeslot ISCP	Checked that this IE is present
Measured results on RACH	Checked that this IE is absent
Additional measured results	Checked that this IE is absent
Event results	Checked that this IE is absent

## Contents of MEASUREMENT REPORT message for Inter frequency 7,68 Mcps option TDD test cases

Information Element	Value/remark
Message Type	
Integrity check info	The presence of this IE is dependent on IXIT statements in TS 34.123-2. If integrity protection is indicated to be active, this IE shall be present with the values of the sub IEs as stated below. Else, this IE and the sub-IEs shall be absent.
- Message authentication code	This IE is checked to see if it is present. The value is compared against the XMAC-I value computed by SS.
- RRC Message sequence number	This IE is checked to see if it is present. The value is used by SS to compute the XMAC-I value.
Measurement identity	1
Measured Results	
- Inter-frequency measured results list	
- UTRA Carrier RSSI	Checked that this IE is present
- Inter-frequency cell measurement results	
- Cell measured results	
- Cell Identity	Not present
- SFN-SFN observed time difference	Checked that this IE is present
- Cell synchronisation information	
- CHOICE mode	TDD
- COUNT-C-SFN frame difference	Checked that this IE is present
- OFF	Checked that this IE is present
- CHOICE mode	TDD
- Cell Parameters ID	4
- Primary CCCPCH RSCP	Checked that this IE is present
- Pathloss	Checked that this IE is present
- Timeslot ISCP	Checked that this IE is present
Measured results on RACH	Checked that this IE is absent
Additional measured results	Checked that this IE is absent
Event results	Checked that this IE is absent

## Contents of MEASUREMENT REPORT message for Inter frequency FDD test cases

Information Element	Value/remark
Message Type	
Integrity check info	The presence of this IE is dependent on IXIT statements in TS 34.123-2. If integrity protection is indicated to be active, this IE shall be present with the values of the sub IEs as stated below. Else, this IE and the sub-IEs shall be absent.
- Message authentication code	This IE is checked to see if it is present. The value is compared against the XMAC-I value computed by SS.
- RRC Message sequence number	This IE is checked to see if it is present. The value is used by SS to compute the XMAC-I value.
Measurement identity	1
Measured Results	
- Inter-frequency measured results list	
- UTRA Carrier RSSI	Checked that this IE is present
- Inter-frequency cell measurement results	
- Cell measured results	
- Cell Identity	Not present
- SFN-SFN observed time difference	Checked that this IE is present
- Cell synchronisation information	
-Tm	Checked that this IE is present
- OFF	Checked that this IE is present
- CHOICE mode	FDD
- Primary CPICH info	Checked that this IE is present
- Primary scrambling code	150
- CPICH Ec/N0	Checked that this IE is present
- CPICH RSCP	Checked that this IE is present
- Pathloss	Checked that this IE is present
Measured results on RACH	Checked that this IE is absent
Additional measured results	Checked that this IE is absent
Event results	Checked that this IE is absent

## Contents of MEASUREMENT REPORT message for inter – RAT test cases

Information Element	Value/remark
Message Type	
Integrity check info	The presence of this IE is dependent on IXIT statements in TS 34.123-2. If integrity protection is indicated to be active, this IE shall be present with the values of the sub IEs as stated below. Else, this IE and the sub-IEs shall be absent.
- Message authentication code	This IE is checked to see if it is present. The value is compared against the XMAC-I value computed by SS.
- RRC Message sequence number	This IE is checked to see if it is present. The value is used by SS to compute the XMAC-I value.
Measurement identity	1
Measured Results	
- Inter-RAT measured results list	
- CHOICE system	GSM
- Measured GSM cells	Checked that this IE is present
- GSM carrier RSSI	Checked that this IE is present
- Pathloss	Checked that this IE is present
- Observed time difference to GSM cell	Checked that this IE is present
Measured results on RACH	Checked that this IE is absent
Additional measured results	Checked that this IE is absent
Event results	Checked that this IE is absent
Inter-RAT cell info indication	Checked that this IE is absent

## Annex J (informative): Change history

Meeting -1st- Level	Doc-1st-Level	CR	Rev	Subject	Cat	Version - Current	Version -New	Doc-2nd- Level
TP-22	TP-030281	181	1	Addition of LCR GSM neighbour reporting	F	4.9.0	5.0.0	T1-031615
TP-22	TP-030281	182	1	Addition of LCR GSM handover test	F	4.9.0	5.0.0	T1-031616
TP-22	TP-030281	183	1	Update to LCR GSM RSSI measurement	F	4.9.0	5.0.0	T1-031617
TP-22	TP-030281	184	1	Update to inter frequency measurements	F	4.9.0	5.0.0	T1-031618
TP-22	TP-030281	185	1	Correction of LCR ISCP test case	F	4.9.0	5.0.0	T1-031619
TP-22	TP-030281	186	1	Addition of TDD HSDPA section & creation Rel 5	B	4.9.0	5.0.0	T1-031620
TP-22	TP-030281	187	1	HSDPA HS DSCH throughput (fixed and variable)	B	4.9.0	5.0.0	T1-031621
TP-22	TP-030281	188	1	Addition of Reporting of HS DSCH CQI	B	4.9.0	5.0.0	T1-031622
TP-22	TP-030281	189	1	Addition of HS-SCCH Detection Performance	B	4.9.0	5.0.0	T1-031623
RP-29	RP-050514	190	-	CR to 34.122 Rel-5: Correction to Cell Re-selection in CELL_FACH for 1.28Mcps TDD	F	5.0.0	5.1.0	R5-051217
RP-29	RP-050514	191	-	CR to 34.122 Rel-5: Correction to Cell Re-selection in idle for 1.28Mcps TDD	F	5.0.0	5.1.0	R5-051218
RP-29	RP-050514	192	-	CR to 34.122 Rel-5: Correction to UE Measurements Procedures for 1.28Mcps TDD	F	5.0.0	5.1.0	R5-051219
RP-29	RP-050514	193	-	CR to 34.122 Rel-5: Correction to UE Measurements Performance Requirements for 1.28Mcps TDD	F	5.0.0	5.1.0	R5-051220
RP-30	RP-050777	194	-	Adding terminal Baseline and Service Implementation Capabilities of 1.28Mcps TDD	F	5.1.0	5.2.0	R5-051886
RP-30	RP-050777	195	-	Correction to power control downlink – 1.28 Mcps TDD option	F	5.1.0	5.2.0	R5-051887
RP-30	RP-050777	196	-	Correction to blocking exceptions for 1.28 Mcps TDD option	F	5.1.0	5.2.0	R5-051888
RP-30	RP-050777	197	-	Name correction of logical and transport channels	F	5.1.0	5.2.0	R5-051889
RP-30	RP-050777	198	-	Correction to power definitions	F	5.1.0	5.2.0	R5-051890
RP-30	RP-050777	199	-	Completing 1.28Mcps TDD/FDD cell reselection in idle mode	F	5.1.0	5.2.0	R5-051891
RP-30	RP-050777	200	-	Adding OCNS_Ec/Ior and correcting loc	F	5.1.0	5.2.0	R5-051892
RP-30	RP-050777	201	-	Correction of Cell Re-selection in CELL_FACH	F	5.1.0	5.2.0	R5-051893
RP-31	RP-060163	202	-	Correcting cell reselection test procedure	F	5.2.0	5.3.0	R5-060453
RP-31	RP-060146	203	-	Adding statistical Testing of HSDPA Receiver Performance	F	5.2.0	5.3.0	R5-060034
RP-31	RP-060146	204	-	Completing the test of reporting of HS-DSCH Channel Quality Indicator	F	5.2.0	5.3.0	R5-060033
RP-31	RP-060146	205	-	Completing HS-SCCH Detection Performance test	F	5.2.0	5.3.0	R5-060032
RP-31	RP-060146	206	-	Completing HS-DSCH throughput for variable reference channels	F	5.2.0	5.3.0	R5-060031
RP-31	RP-060146	207	-	Completing HS-DSCH throughput for fixed reference channels	F	5.2.0	5.3.0	R5-060030
RP-31	RP-060146	208	-	Adding general test conditions and declarations for HSDPA	F	5.2.0	5.3.0	R5-060029
RP-32	RP-060329	209	-	Update of HCR reference channels	F	5.3.0	5.4.0	R5-061150
RP-32	RP-060328	210	-	Correcting the handover delay for 1.28Mcps TDD option	F	5.3.0	5.4.0	R5-061426
RP-32	RP-060328	211	-	Correcting inter RAT cell re-selection for 1.28Mcps TDD option	F	5.3.0	5.4.0	R5-061427
RP-32	RP-060336	212	-	Addition of HCR HS-DSCH throughput for fixed reference channels	F	5.3.0	5.4.0	R5-061142
RP-32	RP-060336	213	-	Addition of HCR HS-DSCH throughput for variable reference channels	F	5.3.0	5.4.0	R5-061143
RP-32	RP-060336	214	-	Addition of HCR reporting of HS-DSCH channel quality indicator	F	5.3.0	5.4.0	R5-061144
RP-32	RP-060336	215	-	Addition of HCR HSDPA reference channels	F	5.3.0	5.4.0	R5-061145
RP-32	RP-060336	216	-	Addition of HCR multi-path fading environments for HSDPA performance requirements	F	5.3.0	5.4.0	R5-061146
RP-32	RP-060336	217	-	Addition of statistical testing of HSDPA receiver performance for HCR to Annex F	F	5.3.0	5.4.0	R5-061147
RP-33	RP-060552	218	-	Correction to Handover to GSM for 1.28Mcps TDD option	F	5.4.0	5.5.0	R5-062124
RP-33	RP-060552	219	-	Correcting the RRC re-establishment delay for 1.28Mcps TDD option	F	5.4.0	5.5.0	R5-062125
RP-33	RP-060552	220	-	Correcting the statistical testing of receiver BER/BLER performance	F	5.4.0	5.5.0	R5-062126
RP-33	RP-060552	221	-	Correcting the statistical testing of RRM delay performance	F	5.4.0	5.5.0	R5-062128



RP-33	RP-060549	222	-	Clarification of Tx spurious emission level from 3.84 Mcps TDD UE into PHS band.	F	5.4.0	5.5.0	R5-062267_r1
RP-34	RP-060732	223	-	Adding test case of GSM measurement of without BSIC verification required	F	5.5.0	5.6.0	R5-063106
RP-34	RP-060732	224	-	Correction to GSM measurement for 1.28Mcps TDD option	F	5.5.0	5.6.0	R5-063154
RP-34	RP-060747	225	-	HS-SCCH detection test for HCR TDD	F	5.5.0	5.6.0	R5-063218
RP-35	RP-070104	228		Correcting the inter frequency measurement for 1.28Mcps TDD option	F	5.6.0	5.7.0	R5-070119
RP-35	RP-070104	229		Correcting the intra frequency measurement test case for 1.28Mcps TDD option	F	5.6.0	5.7.0	R5-070120
RP-35	RP-070104	230		Correcting the test case of open loop power control for 1.28Mcps TDD option	F	5.6.0	5.7.0	R5-070121
RP-35	RP-070104	231		Adding the test criteria in RRM test cases for 1.28Mcps TDD option	F	5.6.0	5.7.0	R5-070122
RP-35	RP-070104	232		Adding test case of Timing Advance for 1.28Mcps TDD option	F	5.6.0	5.7.0	R5-070123
RP-35	RP-070105	227		34.122 v5.7.0 pointer to Release 6 version	F	5.6.0	5.7.0	R5-070076
RP-35	RP-070111	226		34.122 v6.0.0 pointer to Release 7 version	F	5.6.0	6.0.0	R5-070075
RP-35	RP-070091	233		Addition of 7.68Mcps to Frequency bands and channel arrangement (section 4 of 34.122)	F	5.6.0	7.0.0	R5-070175
RP-35	RP-070091	234		Addition of 7.68Mcps tests to transmitter characteristics (section 5 of 34.122)	F	5.6.0	7.0.0	R5-070538
RP-35	RP-070091	235		Addition of 7.68Mcps tests to receiver characteristics (section 6 of 34.122)	F	5.6.0	7.0.0	R5-070539
RP-35	RP-070091	236		Addition of 7.68Mcps tests to performance requirements (section 7 of 34.122)	F	5.6.0	7.0.0	R5-070178
RP-35	RP-070091	237		Addition of 7.68Mcps tests to connected mode mobility requirements for support of RRM (section 8.3 of 34.122)	F	5.6.0	7.0.0	R5-070540
RP-35	RP-070091	238		Addition of 7.68Mcps tests to RRC connection control for support of RRM (section 8.4 of 34.122)	F	5.6.0	7.0.0	R5-070180
RP-35	RP-070091	239		Addition of 7.68Mcps tests to idle mode requirements for support of RRM (section 8.2 of 34.122)	F	5.6.0	7.0.0	R5-070181
RP-35	RP-070091	240		Addition of 7.68Mcps tests to UE measurement procedures (section 8.6 of 34.122)	F	5.6.0	7.0.0	R5-070182
RP-35	RP-070091	241		Addition of 7.68Mcps tests to measurements performance requirements (section 8.7 of 34.122)	F	5.6.0	7.0.0	R5-070183
RP-35	RP-070091	242		Addition of 7.68Mcps tests to timing characteristics for support of RRM (section 8.5 of 34.122)	F	5.6.0	7.0.0	R5-070184
RP-35	RP-070091	243		Addition of 7.68Mcps tests to Performance requirements for HSDPA (section 9 of 34.122)	F	5.6.0	7.0.0	R5-070541
RP-35	RP-070091	244		Addition of 7.68Mcps reference measurement channels to Annex C of 34.122	F	5.6.0	7.0.0	R5-070542
RP-35	RP-070091	245		Addition of 7.68Mcps propagation conditions to Annex D of 34.122	F	5.6.0	7.0.0	R5-070543
RP-35	RP-070091	246		Addition of 7.68Mcps cases to Annex F of 34.122	F	5.6.0	7.0.0	R5-070544
RP-35	RP-070091	247		Addition of 7.68Mcps to Annex H of 34.122	F	5.6.0	7.0.0	R5-070545
RP-35	RP-070091	248		Addition of 7.68Mcps messages to Annex I of 34.122	F	5.6.0	7.0.0	R5-070190
RP-35	RP-070092	249		Addition of measurement parameters for MBMS tests to Annex C of 34.122	F	5.6.0	7.0.0	R5-070192
RP-35	RP-070093	250		Addition of E-DCH reference measurement channels for E-DCH tests to Annex C of 34.122	F	5.6.0	7.0.0	R5-070191
RP-36	RP-070366	251		Addition of E-AGCH demodulation performance tests for 3.84 and 7.68Mcps TDD	F	7.0.0	7.1.0	R5-071281
RP-36	RP-070364	252		Addition of Scenario 2C: 3,84 Mcps TDD cell re-selection for 7,68 Mcps TDD UE (section 8 of 34.122)	F	7.0.0	7.1.0	R5-071285
RP-36	RP-070365	253		MTCH demodulation tests for 3.84 and 7.68Mcps TDD	F	7.0.0	7.1.0	R5-071288
RP-36	RP-070364	254		Addition of Scenario 2D: 3,84 Mcps TDD cell re-selection for 7,68 Mcps TDD UE (section 8 of 34.122)	F	7.0.0	7.1.0	R5-071313
RP-36	RP-070344	255		Correcting the test requirement for 1.28Mcps TDD option	F	7.0.0	7.1.0	R5-071425
RP-36	RP-070344	256		Correcting the message content for 1.28Mcps TDD option	F	7.0.0	7.1.0	R5-071426
RP-36	RP-070344	257		Correcting the Spectrum emission mask for 1.28Mcps TDD option	F	7.0.0	7.1.0	R5-071427
RP-37	RP-070609	258	-	Addition of MCCH demodulation tests for 3.84Mcps and 7.68Mcps	F	7.1.0	7.2.0	R5-072294
RP-37	RP-070610	259	-	Addition of Detection of E-DCH HARQ ACK Indicator Channel (E-HICH) for 3.84Mcps and 7.68Mcps TDD	F	7.1.0	7.2.0	R5-072293
RP-37	RP-070616	260	-	Adding the test case of MTCH demodulation	F	7.1.0	7.2.0	R5-072382

				performance for 1.28Mcps TDD option				
RP-37	RP-070616	261	-	Adding the test case of MTCH demodulation and cell identification for 1.28Mcps TDD option	F	7.1.0	7.2.0	R5-072383
RP-38	RP-070876	262		Introduction of multi-frequency operation for LCR TDD and corrections	F	7.2.0	7.3.0	R5-073331
RP-38	RP-070876	263		Correcting the test case of maximum output power for 1.28Mcps TDD option	F	7.2.0	7.3.0	R5-073293
RP-38	RP-070876	264		Updating of HSDPA demodulation performance requirements for 1.28Mcps TDD option	F	7.2.0	7.3.0	R5-073294
RP-38	RP-070878	265		Deleting test case of MCCCH demodulation requirement for 1.28Mcps TDD option	F	7.2.0	7.3.0	R5-073295
RP-38	RP-070878	266		Correcting test case of MTCH demodulation requirement for 1.28Mcps TDD option	F	7.2.0	7.3.0	R5-073296
RP-39	RP-080102	267		Correcting the pass fail decision rule in annex F6.3.5 for 1.28Mcps TDD option	F	7.3.0	7.4.0	R5-080389
RP-39	RP-080102	268		Adding the test tolerance of performance requiremet for 1.28Mcps TDD option	F	7.3.0	7.4.0	R5-080095
RP-39	RP-080102	269		Adding the test parameter of midamble allocation for performance requiremet for LCR TDD	F	7.3.0	7.4.0	R5-080096
RP-39	RP-080102	270		Adding the test case of maximum input level for HS-PDSCH reception for 1.28Mcps TDD option	F	7.3.0	7.4.0	R5-080097
RP-39	RP-080115	271		Adding the test case of E-HICH detection parameter for 1.28Mcps TDD Option	F	7.3.0	7.4.0	R5-080191
RP-39	RP-080115	272		Adding the test case of E-AGCH detection parameter for 1.28Mcps TDD Option	F	7.3.0	7.4.0	R5-080192
RP-40	RP-080377	0273		Adding the test case of E-AGCH detection parameters for 1.28Mcps TDD Option	F	7.4.0	7.5.0	R5-081103
RP-40	RP-080377	0274		Adding the test case of E-HICH detection parameter for 1.28Mcps TDD Option	F	7.4.0	7.5.0	R5-081104
RP-40	RP-080377	0275		Adding the test case of EVM with E-DCH16QAM for 1.28Mcps TDD Option	F	7.4.0	7.5.0	R5-081105
RP-40	RP-080365	0276		Modifying the test parameter of HS-SCCH for 1.28Mcps TDD Options	F	7.4.0	7.5.0	R5-081106
RP-41	RP-080557	0277		Correction to test case RRC re-establishment delay to a known target cell test parameters	F	7.5.0	7.6.0	R5-083057
RP-41	RP-080557	0278		Correction to test case RRC re-establishment delay to an unknown target cell test parameters	F	7.5.0	7.6.0	R5-083058
RP-41	RP-080557	0279		Correcting the test case of spurious emissions	F	7.5.0	7.6.0	R5-083303
RP-41	RP-080557	0280		Adding the test tolerance of performance requirement for HSDPA	F	7.5.0	7.6.0	R5-083304
RP-41	RP-080569	0281		Adding the test case of MBSFN capable UE for LCR TDD	F	7.5.0	7.6.0	R5-083305
RP-41	RP-080568	0282		Addition of RF tests for MBSFN for 3.84Mcps and 7.68Mcps TDD	F	7.6.0	8.0.0	R5-083320
RP-41	RP-080568	0283		Update of annex with new test configuration and multi path channel definition required for MBSFN testing for 3.84Mcps and 7.68Mcps TDD	F	7.6.0	8.0.0	R5-083823
RP-41	RP-080565	0284		Adding the test case of UE Transmission Power Headroom for 1.28Mcps TDD Option	F	7.5.0	7.6.0	R5-083824
RP-41	RP-080561	0285		Update of Detection of E-DCH HARQ ACK Indicator Channel (E-HICH) and Demodulation of E-DCH Absolute Grant Channel (E-AGCH) tests for 3.84Mcps and 7.68Mcps TDD	F	7.6.0	8.0.0	R5-083826
RP-43	RP-090219	0286	-	Maximum Input Level for HS-PDSCH Reception (1.28TDD 64QAM)	F	8.0.0	8.1.0	R5-090249
RP-43	RP-090219	0287	-	Test requirements for HS-DSCH 64QAM 1.28TDD	F	8.0.0	8.1.0	R5-090251
RP-43	RP-090200	0288	-	Modifying the reference measurement channel and performance requirement of 384kbps for LCR TDD	F	8.0.0	8.1.0	R5-090331
RP-43	RP-090200	0289	-	Adding the additional requirement of Adjacent Channel Selectivity for LCR TDD	F	8.0.0	8.1.0	R5-090332
RP-43	RP-090200	0290	-	Correction Intra/Inter-frequency cell power level of cell re-selection and handover test cases for LCR TDD	F	8.0.0	8.1.0	R5-090333
RP-43	RP-090200	0291	-	Changing the tables of HSDPA reference measurement channels for LCR TDD	F	8.0.0	8.1.0	R5-090334
RP-43	RP-090200	0292	-	Changing the tables of E-DCH fixed reference channels for LCR TDD	F	8.0.0	8.1.0	R5-090335
RP-43	RP-090200	0293	-	Adding the test parameters of MBMS for LCR TDD	F	8.0.0	8.1.0	R5-090336
RP-43	RP-090200	0294	-	Modifying P-CCPCH RSCP intra frequency relative requirement for LCR TDD	F	8.0.0	8.1.0	R5-090337
RP-43	RP-090201	0295	-	Modifications of Test Parameters for LCR-TDD HSDPA Performance	F	8.0.0	8.1.0	R5-090540
RP-43	RP-090204	0296	-	Introduction of UE Transmitted Power	F	8.0.0	8.1.0	R5-091099
RP-44	RP-090448	0297	-	UTRA TDD to E-UTRA TDD cell reselection: E-UTRA is of lower priority scenario	F	8.1.0	8.2.0	R5-092313

RP-44	RP-090448	0298	-	UTRA TDD to E-UTRA TDD cell reselection: E-UTRA is of higher priority scenario	F	8.1.0	8.2.0	R5-092314
RP-44	RP-090434	0299	-	Correction on 64QAM Reference measurement channel for 1.28Mcps TDD	F	8.1.0	8.2.0	R5-092446
RP-44	RP-090434	0300	-	Correction on UPH reporting accuracy and UE transmitted power absolute accuracy requirements for 1.28Mcps TDD	F	8.1.0	8.2.0	R5-092447
RP-45	RP-090803	0301	-	Correction on the test case of MBSFN capable UE for LCR TDD	F	8.2.0	8.3.0	R5-094275
RP-45	RP-090801	0302	-	UTRA TDD to E-UTRA TDD Cell search	F	8.2.0	8.3.0	R5-094543
RP-45	RP-090801	0303	-	UTRA TDD to E-UTRA FDD Cell search	F	8.2.0	8.3.0	R5-094544
RP-45	RP-090801	0304	-	Add new spec references in 34.122	F	8.2.0	8.3.0	R5-094545
RP-45	RP-090798	0305	-	Corrections on LCR TDD 64QAM FRCs and requirements	F	8.2.0	8.3.0	R5-094954
RP-45	RP-090801	0306	-	Addition of the UTRA TDD to E-UTRA FDD handover test case	F	8.2.0	8.3.0	R5-094964
RP-45	RP-090801	0307	-	Addition of the UTRA TDD to E-UTRA TDD handover test case	F	8.2.0	8.3.0	R5-094965
RP-46	RP-091130	0308	-	Introduction of 3.84 Mcps TDD IMB option in 34.122	F	8.3.0	8.4.0	R5-095690
RP-46	RP-091130	0309	-	Receiver characteristics for 3.84 Mcps TDD IMB	F	8.3.0	8.4.0	R5-095692
RP-46	RP-091119	0310	-	Maximum output power with E-DCH for TDD And FRC	F	8.3.0	8.4.0	R5-095760
RP-46	RP-091130	0311	-	Tests to verify the demodulation of MTCH for 3.84 Mcps TDD IMB UEs	F	8.3.0	8.4.0	R5-095779
RP-46	RP-091119	0312	-	Adding Demodulation test case for LCR TDD 64QAM	F	8.3.0	8.4.0	R5-096094
RP-46	RP-091119	0313	-	Adding CQI test for LCR TDD 64QAM	F	8.3.0	8.4.0	R5-096095
RP-46	RP-091121	0314	-	Combined UTRA TDD - UTRA TDD and E-UTRA FDD cell search in fading	F	8.3.0	8.4.0	R5-096249
RP-46	RP-091130	0315	-	DL reference measurement parameters for 3.84 Mcps TDD IMB tests	F	8.3.0	8.4.0	R5-096279
RP-47	RP-100142	0316	-	maximum output power with multi-code for TDD	F	8.4.0	8.5.0	R5-100194
RP-47	RP-100142	0317	-	maximum output power with HS-SICH and DPCH for TDD	F	8.4.0	8.5.0	R5-100195
RP-47	RP-100142	0318	-	ACLR with HS-SICH and DPCH for TDD	F	8.4.0	8.5.0	R5-100196
RP-47	RP-100142	0319	-	Spectrum emission mask with HS-SICH and DPCH for TDD	F	8.4.0	8.5.0	R5-100197
RP-47	RP-100142	0320	-	EVM with HS-SICH and DPCH for TDD	F	8.4.0	8.5.0	R5-100198
RP-47	RP-100142	0321	-	Demodulation of DCH in birth-death conditions for TDD	F	8.4.0	8.5.0	R5-100199
RP-47	RP-100142	0322	-	Demodulation of DCH in moving conditions for TDD	F	8.4.0	8.5.0	R5-100200
RP-47	RP-100142	0323	-	HS-SICH and DPCH reference measurement channel	F	8.4.0	8.5.0	R5-100201
RP-47	RP-100142	0324	-	Moving conditions for TDD	F	8.4.0	8.5.0	R5-100202
RP-47	RP-100142	0325	-	Birth-Death conditions for TDD	F	8.4.0	8.5.0	R5-100203
RP-47	RP-100142	0326	-	E-TFC selection in UE	F	8.4.0	8.5.0	R5-100204
RP-47	RP-100142	0327	-	Serving HS-DSCH cell change	F	8.4.0	8.5.0	R5-100205
RP-47	RP-100142	0344	-	Test case of E-UTRA TDD RSRP absolute accuracy in UTRAN TDD mode	F	8.4.0	8.5.0	R5-100208
RP-47	RP-100142	0345	-	Test case of E-UTRA TDD RSRQ absolute accuracy in UTRAN TDD mode	F	8.4.0	8.5.0	R5-100209
RP-47	RP-100158	0346	-	Introduction of HS-DSCH Performance test case for MIMO of 1.28Mcps TDD	F	8.4.0	8.5.0	R5-100390
RP-47	RP-100142	0328	-	Addition of BLER requirements for 3.84 Mcps TDD IMB receiver characteristics	F	8.4.0	8.5.0	R5-100413
RP-47	RP-100138	0329	-	Reorganization and update of section 9.3.1 HS-DSCH throughput for Fixed Reference Channels	F	8.4.0	8.5.0	R5-100423
RP-47	RP-100138	0330	-	Reorganization and update of section 9.3.2 HS-DSCH throughput for Variable Reference Channels	F	8.4.0	8.5.0	R5-100424
RP-47	RP-100138	0331	-	Reorganization and update of section 9.3.3 Reporting of HS-DSCH Channel Quality Indicator	F	8.4.0	8.5.0	R5-100425
RP-47	RP-100138	0332	-	Addition of new test case-UTRAN to GSM Cell Re-Selection: HCS with only UTRA level changed for 1,28 Mcps TDD Option	F	8.4.0	8.5.0	R5-100426

RP-47	RP-100138	0333	-	Addition of test case-Cell Re-selection in CELL_FACH: Cell Reselection to GSM for 1,28 Mcps TDD	F	8.4.0	8.5.0	R5-100429
RP-47	RP-100138	0334	-	Addition of 2 test cases - Random Access for 1,28 Mcps TDD	F	8.4.0	8.5.0	R5-100430
RP-47	RP-100138	0335	-	Addition of test case - TDD/TDD Handover for 1,28 Mcps Option: Handover to inter-band cell: Scenario 2	F	8.4.0	8.5.0	R5-100431
RP-47	RP-100138	0336	-	Inter-band handover for 1.28Mcps TDD	F	8.4.0	8.5.0	R5-100477
RP-47	RP-100138	0337	-	Inter-band Cell Re-selection for 1.28Mcps TDD	F	8.4.0	8.5.0	R5-100478
RP-47	RP-100138	0338	-	Extension of P-CCPCH RSCP absolute accuracy requirement for 1.28Mcps TDD	F	8.4.0	8.5.0	R5-100484
RP-47	RP-100142	0339	-	UTRAN TDD - E-UTRAN FDD RSRP Measurement Accuracy Tests	F	8.4.0	8.5.0	R5-100870
RP-47	RP-100142	0340	-	UTRAN TDD - E-UTRAN FDD RSRQ Measurement Accuracy Tests	F	8.4.0	8.5.0	R5-100871
RP-47	RP-100141	0341	-	Combined UTRA TDD inter-frequency and GSM cell search under AWGN	F	8.4.0	8.5.0	R5-100884
RP-47	RP-100141	0342	-	UTRAN TDD to GSM Handover: Non-synchronization target cell Test Case	F	8.4.0	8.5.0	R5-100885
RP-47	RP-100158	0343	-	Introduction of CQI test case for MIMO of 1.28Mcps TDD	F	8.4.0	8.5.0	R5-101182
RP-47	-	-	-	Moved to v9.0.0 with no change	-	8.5.0	9.0.0	-
RP-48	RP-100506	0347	-	Addition of test case - Inter-RAT cell change order from UTRAN TDD to GSM(GPRS) for 1.28 Mcps TDD Option	F	9.0.0	9.1.0	R5-103194
RP-48	RP-100506	0348	-	Addition of 2 test cases - UE uplink synchronization control during handover for 1.28 Mcps TDD	F	9.0.0	9.1.0	R5-103195
RP-48	RP-100506	0349	-	Modification of test case - Event 1H and 1I triggered reporting in AWGN propagation condition for 1.28 Mcps TDD Option	F	9.0.0	9.1.0	R5-103197
RP-48	RP-100530	0350	-	UE test requirements in high speed train condition for LCR TDD	F	9.0.0	9.1.0	R5-103269
RP-48	RP-100527	0351	-	Introduction of measurement channels for MIMO of 1.28Mcps TDD	F	9.0.0	9.1.0	R5-103431
RP-48	RP-100511	0352	-	Introduction of Band e and Band f requirements for LCR TDD	F	9.0.0	9.1.0	R5-103722
RP-48	RP-100527	0353	-	Introduction of method of CQI test for MIMO of 1.28Mcps TDD	F	9.0.0	9.1.0	R5-103772
RP-49	RP-100812	0361	-	SEM with E-DCH for TDD	F	9.1.0	9.2.0	R5-104843
RP-49	RP-100812	0358	-	maximum output power with E-DCH for TDD	F	9.1.0	9.2.0	R5-104349
RP-49	RP-100812	0359	-	ACLR with E-DCH for TDD	F	9.1.0	9.2.0	R5-104350
RP-49	RP-100828	0360	-	Test case of E-UTRAN TDD - UTRAN TDD handover: unknown target cell	F	9.1.0	9.2.0	R5-104386
RP-49	RP-100809	0355	-	Correction to test case 8.3.4 - Cell Re-selection in CELL_FACH	F	9.1.0	9.2.0	R5-104227
RP-49	RP-100809	0357	-	Correction to test case 8.3.6 - Cell Re-selection in URA_PCH	F	9.1.0	9.2.0	R5-104229
RP-49	RP-100809	0356	-	Correction to test case 8.3.5 - Cell Re-selection in CELL_PCH	F	9.1.0	9.2.0	R5-104228
RP-49	RP-100809	0354	-	Correction to test case 5.5.2.1 and 5.5.2.1B - Remove 0.8M offset of Spectrum emission mask for 1.28M TDD	F	9.1.0	9.2.0	R5-104223
RP-50	RP-101137	0362	-	Correction in test procedure to remove redundant frequency range of measurement	F	9.2.0	9.3.0	R5-106161
RP-50	RP-101146	0363	-	Correction in Procedure Settings for test case 9.3.1A till 9.3.1E and corresponding Annex F.6.3.5	F	9.2.0	9.3.0	R5-106173
RP-50	RP-101137	0364	-	Introduction of new Power Control TC in the Downlink for 1.28Mcps TDD	F	9.2.0	9.3.0	R5-106860
RP-51	RP-110156	0365	-	Correction in test requirement of 9.3.2A/B/C/D/E	F	9.3.0	9.4.0	R5-110321
RP-51	RP-110156	0366	-	Add Mid UARFCN channel testing in Clause 5.5.2.1, 5.5.2.1A & 5.5.2.1B Initial Conditions settings	F	9.3.0	9.4.0	R5-110322
RP-51	RP-110165	0367	-	Correction on Annex F.6.3.5, Table F.6.3.5.1 to correlate Clause 9.3.1A.5, Table 9.3.1A.3	F	9.3.0	9.4.0	R5-110323
RP-51	RP-110156	0368	-	Correction in Test Requirements Settings for test case 9.3.2E based on corresponding Annex F.2.5, Table F.2.5	F	9.3.0	9.4.0	R5-110324

RP-51	RP-110157	0369	-	Correction of Maximum Input Level Test for HS-PDSCH Transmission for 1.28Mcps TDD	F	9.3.0	9.4.0	R5-110614
RP-51	RP-110156	0370	-	Introduction of new DL power control TC, wind up effects for 1.28Mcps TDD	F	9.3.0	9.4.0	R5-110923
RP-51	RP-110156	0371	-	Modification of a test case for inter-band handover for 1.28 Mcps TDD Scenario 2	F	9.3.0	9.4.0	R5-110924
RP-51	RP-110156	0372	-	Addition of a new test case for inter-band handover for 1.28 Mcps TDD Scenario 3	F	9.3.0	9.4.0	R5-110925
RP-51	RP-110156	0373	-	Correction in test procedure of User Equipment maximum output power with HS-SICH and DPCH test cases	F	9.3.0	9.4.0	R5-110977
RP-52	RP-110639	0375	-	Correction in test procedure of User Equipment maximum output power with HS-SICH and DPCH test cases	F	9.4.0	9.5.0	R5-112198
RP-52	RP-110639	0376	-	Complement release applicability for 1.28Mcps TDD (clause 5)	F	9.4.0	9.5.0	R5-112344
RP-52	RP-110639	0377	-	Complement the release applicability for 1.28Mcps TDD (clause 7)	F	9.4.0	9.5.0	R5-112345
RP-52	RP-110639	0378	-	Complement the release applicability for 1.28Mcps TDD (clause 8)	F	9.4.0	9.5.0	R5-112346
RP-52	RP-110639	0379	-	Addition of test case - UE uplink synchronization control for PRACH for 1,28 Mcps TDD	F	9.4.0	9.5.0	R5-112347

---

## History

<b>Document history</b>		
V9.0.0	July 2010	Publication
V9.1.0	July 2010	Publication
V9.2.0	November 2010	Publication
V9.3.0	April 2011	Publication
V9.4.0	July 2011	Publication
V9.5.0	August 2011	Publication