

ETSI TS 134 123-3 V10.1.0 (2012-10)



Technical Specification

**Universal Mobile Telecommunications System (UMTS);
User Equipment (UE) conformance specification;
Part 3: Abstract test suite (ATS)
(3GPP TS 34.123-3 version 10.1.0 Release 10)**



ReferenceRTS/TSGR-0534123-3va10

KeywordsUMTS

ETSI

650 Route des Lucioles
F-06921 Sophia Antipolis Cedex - FRANCE

Tel.: +33 4 92 94 42 00 Fax: +33 4 93 65 47 16

Siret N° 348 623 562 00017 - NAF 742 C
Association à but non lucratif enregistrée à la
Sous-Préfecture de Grasse (06) N° 7803/88

Important notice

Individual copies of the present document can be downloaded from:

<http://www.etsi.org>

The present document may be made available in more than one electronic version or in print. In any case of existing or perceived difference in contents between such versions, the reference version is the Portable Document Format (PDF). In case of dispute, the reference shall be the printing on ETSI printers of the PDF version kept on a specific network drive within ETSI Secretariat.

Users of the present document should be aware that the document may be subject to revision or change of status.

Information on the current status of this and other ETSI documents is available at

<http://portal.etsi.org/tb/status/status.asp>

If you find errors in the present document, please send your comment to one of the following services:

http://portal.etsi.org/chaicor/ETSI_support.asp

Copyright Notification

No part may be reproduced except as authorized by written permission.
The copyright and the foregoing restriction extend to reproduction in all media.

© European Telecommunications Standards Institute 2012.

All rights reserved.

DECT™, PLUGTESTS™, UMTS™ and the ETSI logo are Trade Marks of ETSI registered for the benefit of its Members.
3GPP™ and LTE™ are Trade Marks of ETSI registered for the benefit of its Members and
of the 3GPP Organizational Partners.

GSM® and the GSM logo are Trade Marks registered and owned by the GSM Association.

Intellectual Property Rights

IPRs essential or potentially essential to the present document may have been declared to ETSI. The information pertaining to these essential IPRs, if any, is publicly available for **ETSI members and non-members**, and can be found in ETSI SR 000 314: *"Intellectual Property Rights (IPRs); Essential, or potentially Essential, IPRs notified to ETSI in respect of ETSI standards"*, which is available from the ETSI Secretariat. Latest updates are available on the ETSI Web server (<http://ipr.etsi.org>).

Pursuant to the ETSI IPR Policy, no investigation, including IPR searches, has been carried out by ETSI. No guarantee can be given as to the existence of other IPRs not referenced in ETSI SR 000 314 (or the updates on the ETSI Web server) which are, or may be, or may become, essential to the present document.

Foreword

This Technical Specification (TS) has been produced by ETSI 3rd Generation Partnership Project (3GPP).

The present document may refer to technical specifications or reports using their 3GPP identities, UMTS identities or GSM identities. These should be interpreted as being references to the corresponding ETSI deliverables.

The cross reference between GSM, UMTS, 3GPP and ETSI identities can be found under <http://webapp.etsi.org/key/queryform.asp>.

Contents

Intellectual Property Rights	2
Foreword.....	2
Foreword.....	14
Introduction	14
1 Scope	15
2 References	15
3 Definitions and abbreviations.....	18
3.1 Definitions	18
3.2 Abbreviations	18
4 Requirements on the TTCN development.....	18
5 ATS structure	19
5.1 Modularity	20
5.1.1 Module structure.....	20
5.1.2 Contents of the modules	22
5.1.3 Example of a working platform	22
6 Test method and testing architecture.....	23
6.1 Test method	23
6.2 Testing architecture	24
6.2.1 Lower Tester (LT)	24
6.2.2 Configuration and initialization	24
6.2.3 Upper Tester (UT)	25
6.2.4 TTCN.....	25
6.2.5 Model extension.....	25
6.2.6 Multiplexing of RLC services.....	25
6.3 NAS test method and architecture.....	25
6.3.1 Test configuration.....	25
6.3.2 Routing UL NAS messages in SS.....	26
6.4 RRC and RAB test method and architecture	27
6.4.1 Test configuration.....	27
6.4.2 RAB test method.....	28
6.4.2.1 Sending data on the same TTI.....	28
6.4.2.2 Sending continuous data on consecutive TTIs	28
6.5 RLC test method and architecture	29
6.5.1 Testing architecture.....	29
6.5.2 Test method	30
6.5.2.1 Handling SUFIs in TTCN	33
6.5.2.2 Void.....	34
6.6 SMS test method and architecture.....	34
6.6.1 SMS CS test method and architecture.....	34
6.6.2 SMS PS test method and architecture	34
6.6.3 SMS Cell broadcasting test method and architecture.....	34
6.7 MAC test method and architecture.....	34
6.7.1 Testing architecture.....	34
6.7.2 Test method	35
6.7.2.1 Abnormal decoding situations.....	35
6.7.2.2 MAC_es/e test method (Rel-6 or later).....	35
6.7.2.3 MAC_is/i test method (Rel-8 or later)	36
6.8 BMC test method and architecture	38
6.8.1 BMC test architecture	38
6.8.2 BMC test method.....	38
6.9 PDCP test	40

6.9.1	PDCP test architecture	40
6.9.2	PDCP test method.....	41
6.9.2.1	CS voice over HSPA.....	41
6.9.2.2	Network initiated secondary PDP context.....	42
6.10	Multi-RAT Handover Test Model.....	42
6.10.1	Overview	42
6.10.2	ASP function description	43
6.10.2.1	Identities.....	43
6.10.2.2	Cell configuration and control.....	43
6.10.2.3	L1 (GERAN) configuration and control	43
6.10.2.3.1	Basic physical channel configuration	44
6.10.2.3.2	Multislot configuration for circuit or packet switched channels.....	44
6.10.2.3.3	Frame in the near future.....	45
6.10.2.3.4	L1 header.....	45
6.10.2.4	L2 configuration and control.....	45
6.10.2.4.1	Don't response to some handover access bursts.....	45
6.10.2.4.2	No UA reply to SABM.....	45
6.10.2.5	System Information sending.....	45
6.10.2.6	Paging	46
6.10.2.7	Generic procedures for GPRS signalling	46
6.10.2.7.1	GPRS generic attach procedures and ciphering mode control.....	46
6.10.2.7.2	Cell change order within a TBF.....	48
6.10.2.8	Generic configuration procedure for GSM ciphering mode control	50
6.10.2.9	L H bits convention and bit padding in DL	50
6.10.2.9.1	GERAN DL RLC/MAC message bit padding.....	50
6.10.2.9.2	GSM DL message spare padding	51
6.10.2.9.3	L H convention in rest octets of GSM DL messages	51
6.10.2.9.4	Spare Bits	51
6.10.2.9.5	GSM System Information messages on SACCH	51
6.10.2.9.6	GSM Measurement Information messages on SACCH.....	51
6.11	DCH-DSCH model (R99 or Rel-4)	53
6.12	DCH with HS-DSCH (MAC-hs) model (FDD, Rel-5 or later)	54
6.12a	DCH with HS-DSCH model for 1.28 Mcps TDD (Rel-5 or later)	55
6.12b	DCH with HS-DSCH (MAC-ehs) model (FDD, Rel-7 or later)	56
6.12c	HS-DSCH (MAC-hs/ehs) model (FDD, Rel-7 or later)(No DCH Associated)	57
6.12d	HS-DSCH (MAC-ehs) model for DC-HSDPA (FDD, Rel-8 or later)	58
6.13	E-DCH model (Rel-6 or later).....	58
6.13.1	MAC-e/MAC-es test model.....	58
6.13.2	MAC-i/MAC-is test model (Rel-8 or later)	61
6.13.2.1	MAC-i/MAC-is test model for Enhanced UL in Cell_FACH (Rel-8 or later).....	62
6.13.2.2	MAC-i/MAC-is test model for DC-HSUPA (Rel-9 or later)	62
6.14	MBMS model (Rel-6 or later)	63
6.14.1	MBMS RLC test model	65
6.14.1.1	RLC test model for MTCH test.....	65
6.14.1.2	RLC test model for MCCH test.....	65
7	PCO and ASP definitions	65
7.1	NAS PCO and ASP definitions	65
7.1.1	NAS PCO Definitions.....	65
7.1.2	Primitives used at Dc PCO	66
7.2	Ut PCO and ASP definitions	67
7.2.1	Ut PCO Declarations	67
7.2.2	Primitives used at Ut PCO	67
7.3	RRC PCO and ASP definitions	68
7.3.1	AM/UM/TM PCO and ASP definitions.....	68
7.3.1.1	SAP and PCO for data transmission and reception	68
7.3.2	Control PCO and ASP	69
7.3.2.1	SAP and PCO for control primitives transmission and reception	69
7.3.2.2	Control ASP Type Definition.....	70
7.3.2.2.1	CPHY_AICH_AckModeSet.....	70
7.3.2.2.2	CPHY_Cell_Config.....	71
7.3.2.2.3	CPHY_Cell_Release	72

7.3.2.2.3a	CPHY_Cell_TimingAdjust	72
7.3.2.2.3b	CPHY_Detect_TFCI	73
7.3.2.2.4	CPHY_Ini	74
7.3.2.2.5	CPHY_Cell_TxPower_Modify	74
7.3.2.2.6	CPHY_Frame_Number	75
7.3.2.2.6a	CPHY_SFN (Rel-6 or later)	75
7.3.2.2.6b	CPHY_MBMS_MICH_q (Rel-6 or later)	76
7.3.2.2.6c	CPHY_MBMS_NI (Rel-6 or later)	79
7.3.2.2.7	CPHY_Out_of_Sync	80
7.3.2.2.8	CPHY_PRACH_Measurement	80
7.3.2.2.9	CPHY_RL_Modify	81
7.3.2.2.10	CPHY_RL_Release	82
7.3.2.2.11	CPHY_RL_Setup	83
7.3.2.2.12	CPHY_Sync	97
7.3.2.2.12a	CPHY_HS_DPCCH_AckNack (Rel-5 or later)	97
7.3.2.2.12b	CPHY_HS_DPCCH_CQI (Rel-5 or later)	98
7.3.2.2.12b1	CPHY_HS_DPCCH_CQI_DC (Rel-8 or later)	99
7.3.2.2.12c	CPHY_HS_DSCH_CRC_Mode (Rel-5 or later)	100
7.3.2.2.13	CPHY_TrCH_Config	101
7.3.2.2.14a	CPHY_UL_PowerModify	107
7.3.2.2.14	CPHY_TrCH_Release	108
7.3.2.2.15	CMAC_BMC_Scheduling	108
7.3.2.2.16	CMAC_Ciphering_Activate	109
7.3.2.2.16a	CMAC_FACH_MeasOccas	110
7.3.2.2.17	CMAC_Config	110
7.3.2.2.17a	CMAC_MAChs_MACehs_TFRCconfigure (Rel-5 or later)	115
7.3.2.2.17a0	CMAC_MAChs_MACehs_HARQprocAssign	118
7.3.2.2.17a1	CMAC_MACehs_HARQAssign_MultiFlows (Rel-7 or later)	118
7.3.2.2.17aa	CMAC_MACehs_HS_SCCH_Orders (Rel-7 or later)	119
7.3.2.2.17b	CMAC_MACe_Config (Rel-6 or later)	120
7.3.2.2.17c	CMAC_MACe_NodeB_CellMapping (Rel-6 or later)	121
7.3.2.2.17d	CMAC_MACes_Config (Rel-6 or later)	121
7.3.2.2.17e	CMAC_MACe_AG (Rel-6 or later)	122
7.3.2.2.17f	CMAC_MACe_AckNack (Rel-6 or later)	123
7.3.2.2.17g	CMAC_MACe_E_TFC_Restriction (Rel-6 or later)	124
7.3.2.2.17h	CMAC_MACe_RG (Rel-6 or later)	124
7.3.2.2.17ha	Void	125
7.3.2.2.17i	CMAC_MACes_SI_IND (Rel-6 or later)	125
7.3.2.2.17j	CMAC_MACes_SI_Config (Rel-6 or later)	125
7.3.2.2.17k	CMAC_MACi_Config (Rel-8 or later)	125
7.3.2.2.17l	CMAC_MACi_NodeB_CellMapping (Rel-8 or later)	127
7.3.2.2.17m	CMAC_MACis_Config (Rel-8 or later)	127
7.3.2.2.17n	CMAC_MACi_AG (Rel-8 or later)	129
7.3.2.2.17o	CMAC_MACi_AckNack (Rel-8 or later)	129
7.3.2.2.17p	CMAC_MACi_E_TFC_Restriction (Rel-8 or later)	130
7.3.2.2.17q	CMAC_MACi_RG (Rel-8 or later)	130
7.3.2.2.17r	Void	131
7.3.2.2.17s	CMAC_MACis_SI_IND	131
7.3.2.2.17t	CMAC_MACis_SI_Config (Rel-8 or later)	131
7.3.2.2.17u	CMAC_MBMS_ConfigInfo (Rel-6 or later)	131
7.3.2.2.18	CMAC_PAGING_Config	132
7.3.2.2.19	CMAC_Restriction	133
7.3.2.2.20	CMAC_SecurityMode_Config	134
7.3.2.2.21	CMAC_SequenceNumber	134
7.3.2.2.22	CMAC_SYSINFO_Config	134
7.3.2.2.22a	CRLC_Bind_TestData_TTI	135
7.3.2.2.22b	CRLC_BindTestDataInOneMAChs_MACehs_PDU (Rel-5 or later)	136
7.3.2.2.22c	CRLC_BindTestDataInMultipleMACehs_PDU_MultiFlows (Rel-7 or later)	136
7.3.2.2.23	CRLC_Ciphering_Activate	137
7.3.2.2.24	CRLC_Config	138
7.3.2.2.25	CRLC_Integrity_Activate	141
7.3.2.2.26	CRLC_Integrity_Failure	142

7.3.2.2.26a	CRLC_MAC_I_Mode	142
7.3.2.2.26b	CRLC_NotAckNxtRxSDU	143
7.3.2.2.26c	CRLC_ProhibitRLC_Ack	143
7.3.2.2.27	CRLC_Resume	144
7.3.2.2.27a	CRLC_RRC_MessageSN	144
7.3.2.2.28	CRLC_SecurityMode_Config	145
7.3.2.2.28a	CRLC_SetRRC_MessageSN	146
7.3.2.2.28b	CRLC_Set_Count_I	146
7.3.2.2.29	CRLC_SequenceNumber	147
7.3.2.2.29a	CRLC_SendContinuousData_TTI	147
7.3.2.2.30	CRLC_Status	148
7.3.2.2.31	CRLC_Suspend	148
7.3.2.2.31a	CRLC_MTCH_Scheduling (Rel-6 or later)	149
7.3.2.2.32	CBMC_Config	150
7.3.2.2.32b	DEC_PERbitstring	150
7.3.2.2.32c	ENC_PERbitstring	152
7.3.2.2.33	RLC_TR_DATA	152
7.3.2.2.34	RLC_AM_DATA	153
7.3.2.2.34a	RLC_UM_ACCESSInfo (Rel-6 or later)	155
7.3.2.2.34b	RLC_UM_CriticalMCCHMsg (Rel-6 or later)	156
7.3.2.2.34c	RLC_TR_SeqOfRlcPdus	156
7.3.2.2.35	RLC_UM_DATA	157
7.3.2.2.35a	RLC_UM_MSCH_Msg (Rel-6 or later)	157
7.3.2.2.36	RLC_TR_MACesDATA_IND (Rel-6 or later)	159
7.3.2.2.36a	RLC_TR_MACisDATA_IND (Rel-8 or later)	159
7.3.2.2.36b	RLC_TR_MACisDATA_ExtTSN_IND (Rel-9 or later)	160
7.3.2.3	Specific ASP and IE definitions for 1.28 Mcps TDD (Rel-4 or later)	160
7.3.2.3.1	Specific ASP definitions	161
7.3.2.3.2	Specific IE definitions	171
7.3.3	TTCN primitives	186
7.3.3.1	UTRAN TTCN primitives	186
7.3.4	GERAN PCO and ASP definitions	189
7.3.4.1	PCO Type definitions	189
7.3.4.1.1	PCO type for data transmission and reception in GERAN	189
7.3.4.1.2	PCO type for configuration and control in GERAN	190
7.3.4.2	PCO definitions	190
7.3.4.2.1	PCOs for data transmission and reception in GERAN	190
7.3.4.2.2	PCOs for control primitives transmission and reception in GERAN	190
7.3.4.3	GERAN ASP Definitions	192
7.3.4.3.1	ASPs for data transmission and reception in GERAN	192
7.3.4.3.2	ASPs for control primitive transmission and reception in GERAN	203
7.3.5	A-GPS Upper tester, PCO and ASP definitions	216
7.3.5.1	Upper tester	216
7.3.5.2	SV PCO	216
7.3.5.3	A-GPS Primitives	216
7.3.5.3.1	Control ASP Type Definition	217
7.3.5.3.2	Data ASP Type Definition	217
7.3.6	ROHC test model and ASP	218
7.3.6.1	ROHC test method	218
7.3.6.2	ASP and PCO for control primitives transmission and reception	219
7.3.6.2.1	PCO definition	219
7.3.6.2.2	CPDCP_Config	220
7.3.6.2.3	CPDCP_ComProtocolControl	221
7.3.6.3	ASP and PCO for data transmission and reception	222
7.3.6.3.1	PCO definition	222
7.3.6.3.2	PDCP_DATA	222
7.3.6.3.3	PDCP_DL_FeedBack	222
7.3.7	Handling RLP for CS non-transparent data	224
7.3.7.1	UTRAN cell	224
7.3.7.2	GERAN cell	226
7.3.7.3	ASP and PCO for control primitives	226
7.3.7.4	ASP and PCO for data transmission and reception	227

8	Design Considerations.....	229
8.1	Channel mapping.....	229
8.2	Channel and RB identity	229
8.2.1	Physical channels.....	234
8.2.2	Transport channels.....	235
8.2.2.1	Support of Default Configurations.....	235
8.2.3	Logical Channels.....	236
8.2.4	Radio bearers.....	236
8.2.5	Scrambling and channelization codes.....	239
8.2.6	MAC-d.....	243
8.2.6.1	MAC-d configuration examples.....	243
8.2.7	Configuration of compressed mode.....	244
8.2.7.1	UE Side.....	244
8.2.7.2	SS Side.....	244
8.2.8	Use of U-RNTI and C-RNTI.....	245
8.3	Channels configurations.....	245
8.3.1	Configuration of Cell_FACH.....	245
8.3.2	Configuration of Cell_DCH_StandAloneSRB.....	246
8.3.3	Configuration of Cell_DCH_Speech.....	247
8.3.4	Configuration of Cell_DCH_64kCS_RAB_SRB.....	248
8.3.5	Configuration of Cell_DCH_57_6kCS_RAB_SRB.....	249
8.3.6	Configuration of Cell_RLC_DCH_RAB.....	250
8.3.7	Configuration of Cell_FACH_BMC.....	250
8.3.8	Configuration of PS Cell_DCH_64kPS_RAB_SRB and Cell_PDCP_AM_RAB.....	251
8.3.9	Configuration of Cell_Two_DTCH.....	252
8.3.10	Configuration of Cell_Single_DTCH (CS).....	253
8.3.11	Configuration of PS Cell_PDCP_UM_RAB.....	253
8.3.12	Configuration of PS Cell_PDCP_AM_UM_RAB.....	254
8.3.13	Configuration of Cell_2SCCPCH_BMC.....	255
8.3.14	Configuration of Cell_Four_DTCH_CS_PS, Cell_Four_DTCH_PS_CS.....	256
8.3.14a	Configuration of Cell_Five_DTCH_CS_PS.....	257
8.3.15	Configuration of Cell_Two_DTCH_CS_PS, Cell_Two_DTCH_PS_CS.....	258
8.3.16	Configuration of Cell_Four_DTCH_CS.....	259
8.3.17	Configuration of Cell_DCH_MAC_SRB.....	260
8.3.18	Configuration of Cell_FACH_MAC_SRB.....	261
8.3.19	Configuration of Cell_FACH_MAC_SRB0.....	262
8.3.20	Configuration of Cell_FACH_2SCCPCH_StandAlonePCH.....	263
8.3.21	Configuration of PS Cell_DCH_2AM_PS.....	263
8.3.21a	Configuration of Cell_DCH_3AM_PS.....	264
8.3.22	Configuration of PS Cell_DCH_2_PS_Call.....	265
8.3.23	Configuration of Cell_FACH_3_SCCPCH_4_FACH_Cnfg1.....	266
8.3.24	Configuration of Cell_FACH_3_SCCPCH_4_FACH_Cnfg2.....	267
8.3.25	Configuration of Cell_FACH_3_SCCPCH_3_FACH_CTCH.....	268
8.3.26	Configuration of PS Cell_DCH_DSCH_PS_RAB.....	269
8.3.27	Configuration of Cell_DCH_DSCH_CS_PS.....	269
8.3.28	Configuration of Cell_FACH_2SCCPCH_StandAlonePCH_2a.....	270
8.3.29	Configuration of Cell_FACH_3_SCCPCH_4_FACH_2a_Cnfg1.....	271
8.3.30	Configuration of Cell_FACH_3_SCCPCH_4_FACH_2a_Cnfg2.....	272
8.3.31	Configuration of Cell_FACH_3_SCCPCH_3_FACH_CTCH_2a.....	273
8.3.32	Configuration of Cell_DCH_HS_DSCH (Rel-5 or later).....	274
8.3.32a	Configuration of Cell_DCH_E_DPCH_PS.....	274
8.3.33	Configuration of cell_One_DTCH_HS_DSCH_MAC (Rel-5 or later).....	275
8.3.33a	Configuration of cell_Three_DTCH_1Q_HS_DSCH_MAC (Rel-7 or later).....	276
8.3.33b	Configuration of cell_Three_DTCH_3Q_HS_DSCH_MAC (Rel-7 or later).....	277
8.3.33c	Configuration of Cell_E_HS_SRB_MAC_TM_RAB (Rel-7 or later).....	278
8.3.34	Configuration of Cell_2UM_3AM_DCH_HS_DSCH (Rel-5 or later).....	279
8.3.35	Configuration of Cell_DCH_Speech_WAMR (Rel-5 or later).....	280
8.3.36	Configuration of PS Cell_Four_DTCH_HS_CS and Cell_Four_DTCH_CS_HS (Rel-5 or later).....	281
8.3.37	Configuration of PS Cell_Two_DTCH_HS_CS (Rel-5 or later).....	281
8.3.38	Configuration of PS Cell_DCH_64kPS_RAB_SRB_HS (Rel-5 or later).....	282
8.3.39	Configuration of PS Cell_DCH_2AM_HS_DSCH (Rel-5 or later).....	283
8.3.39a	Configuration of Cell_DCH_2AM_E_DPCH.....	283

8.3.40	Configuration of Cell_Three_DTCH_5SRB (Rel-5 or later).....	285
8.3.41	Configuration of Cell_Five_DTCH_CS_HS (Rel-5 or later)	286
8.3.41a	Configuration of Cell_FiveDTCH_E_DPCH	287
8.3.42	Configuration of Cell_DCH_E_HS (Rel-6 or later)	288
8.3.43	Configuration of Cell_DCH_dLSRB_E_HS (Rel-6 or later).....	288
8.3.44	Configuration of Cell_E_HS (Rel-6 or later).....	289
8.3.45	Configuration of PS Cell_Four_DTCH_E_HS_CS and Cell_Four_DTCH_CS_E_HS (Rel-6 or later) ..	289
8.3.45a	Configuration of Cell_FourDTCH_E_DPCH.....	290
8.3.46	Configuration of Cell_2DCH_2AM_dLSRB_E_HS (Rel-6 or later)	291
8.3.47	Configuration of Cell_E_HS_MAC_TM_RAB (Rel-6 or later).....	292
8.3.48	Configuration of Cell_2DCH_MAC_2TM_dLSRB_E_HS (Rel-6 or later).....	292
8.3.49	Configuration of Cell_2DCH_1AM_1UM_E_HS (Rel-6 or later).....	293
8.3.50	Configuration of Cell_3DCH_2AM_1UM_E_HS (Rel-6 or later).....	294
8.3.51	Configuration of Cell_Four_DTCH_CS_E_HS_5SRB (Rel-6 or later)	295
8.3.52	Configuration of Cell_Four_DTCH_HS_5SRB (Rel-5 or later)	295
8.3.53	Configuration of Cell_E_HS_StandAloneSRB/ Cell_E_HS_StandAloneSRB_NoConn (Rel-6 or later).....	297
8.3.54	MBMS channel configuration (Rel-6 or later).....	298
8.3.54.1	Configuration cell_MBMS_MCCH (Rel-6 or later)	298
8.3.54.2	Configuration cell_MBMS_MCCH_One_MTCH (Rel-6 or later)	298
8.3.55	Configuration of PS Cell_DCH_64kPS_AM_RAB	299
8.3.56	Configuration of PS Cell_MBMS_PTPRB.....	300
8.3.57	Configuration of PS Cell_MBMS_PTPRB_AM	300
8.3.58	Configuration of Cell_FACH_MCCH_SRB / Cell_FACH_MCCH_NoDedicated	301
8.3.59	Configuration of Cell_DCH_MCCH_PS.....	302
8.3.60	Configuration of PS Cell_DCH_1AM_2AM_HS_DSCH (Rel-6 or later)	303
8.3.61	Configuration of Cell_FACH_enhDL_PCH (Rel-7 or later).....	303
8.3.62	Configuration of Cell_FACH_enhDL_PS (Rel-7 or later)	304
8.3.63	Configuration of Cell_E_HS_UM (Rel-7 or later)	305
8.3.64	Configuration of Cell_FACH_enhDL_SRB (Rel-7 or later)	306
8.3.65	Configuration of Cell_DCH_3TM_dLSRB_E_HS (Rel-8 or later).....	307
8.3.66	Configuration of Cell_E_HS_TM (Rel-8 or later).....	308
8.3.67	Dual cell configurations (Rel-8 or later).....	309
8.3.67.1	Configuration of cell_SecondaryDualCell_SRB (Rel-8 or later).....	309
8.3.67.2	Configuration of cell_SecondaryDualCell_RAB (Rel-8 or later)	309
8.3.67.3	Configuration of cell_SecondaryDualCell_2RAB (Rel-8 or later)	310
8.3.68	Enhanced FACH Uplink configurations (Rel-8 or later)	310
8.3.68.1	Configuration of Cell_FACH_UL_SRB and Cell_FACH_UL_SRB_NoConn (Rel-8 or later)	310
8.3.68.2	Configuration of Cell_FACH_UL_PS (Rel-8 or later)	311
8.3.68.3	Configuration of Cell_FACH_UL_TM_PS (Rel-8 or later)	311
8.3.69	Configuration of Cell_FACH_2_SCCPCH_CTCHenhDL_PS (Rel-8 or later)	312
8.3.70	Configuration of Cell_FACH_2_SCCPCH_CTCHenhDL_PCH (Rel-8 or later)	313
8.3.71	Configuration of Cell_FACH_HS (rel-7 or later).....	314
8.4	System information blocks scheduling.....	315
8.4.1	Grouping SIBs for testing.....	315
8.4.2	SIB configurations	315
8.4.3	Test SIB default schedule	315
8.4.3.1	Test SIB schedule for idle mode, measurement and Inter-RAT UTRAN to GERAN test cases	315
8.4.4	Test SIB special schedule	316
8.4.4.1	Test SIB schedule for two S-CCPCH or two PRACH	316
8.4.4.2	Test SIB schedule for Inter-Rat Handover from GERAN to UTRAN Test	316
8.4.5	Handling the transmission of SIB	316
8.4.5.1	Delivery of System Information content.....	316
8.4.5.2	Scheduling of system Information blocks	316
8.4.5.3	Example of usage	316
8.5	Security in testing.....	318
8.5.1	Authentication.....	318
8.5.2	Ciphering	318
8.5.3	Integrity	320
8.5.4	Test security scenarios	320
8.5.4.1	Start security function	321
8.5.4.1.1	Start integrity protection without start of ciphering.....	321

8.5.4.1.2	Start both integrity protection and ciphering	321
8.5.4.1.3	Void	322
8.5.4.2	RB setup	322
8.5.4.2.1	AM / UM RB	322
8.5.4.2.2	TM RB	323
8.5.4.3	RB Reconfiguration for AM RAB modification of RLC size	324
8.5.4.3.1	"RB mapping info" in CELL UPDATE CONFIRM	324
8.5.4.3.2	"RB mapping info" in RB RECONFIGURATION / RELEASE	324
8.5.4.4	Security modification	324
8.5.4.4.1	Integrity started, ciphering not started	325
8.5.4.4.2	Integrity and ciphering started	325
8.5.4.5	SRNS relocation	326
8.5.4.5.1	Void	326
8.5.4.5.2	Presence of "Integrity protection mode info" but absence of "Ciphering mode info"	326
8.5.4.5.3	Presence of "Integrity protection mode info" and "Ciphering mode info" IE	329
8.5.4.6	CELL/URA update	332
8.5.4.6.1	RLC re-establish (RB2, RB3, RB4)	332
8.5.4.6.2	RLC re-establish (RAB)	333
8.5.4.7	Inter RAT handover to UTRAN	333
8.5.4.7.1	ciphering has not been activated	333
8.5.4.7.2	ciphering has been activated	334
8.5.4.8	Hard handover	334
8.5.5	Test USIM configurations	335
8.5.5.1	Test USIM for Idle mode tests	335
8.6	Downlink power setting in SS	339
8.7	Test suite operation definitions	339
8.7.1	Test suite operation definitions in the common modules	339
8.7.1.1	Specific test suite operation for RLC defined in BasicM	352
8.7.1.1.1	Pseudocode in a C like notation	352
8.7.2	Specific test suite operation definitions for Multi RAT Handover testing	354
8.7.3	Specific test suite operation for Multi RAB testing	356
8.7.4	Specific test suite operation for InterSystem Handover testing	357
8.7.5	Specific test suite operation for RAB_HS testing	357
8.7.6	Specific test suite operation for Intersystem HS Testing	359
8.7.7	Specific test suite operation for A-GPS testing	360
8.7.8	Specific test suite operation for E-DCH Testing	363
8.7.9	Specific test suite operation for E-DCH/HS-ENH and MBMS testing	364
8.8	AT commands	370
8.8.1	AT command lists in ATs	371
8.8.1.1	AT commands in IR_U ATs:	371
8.8.1.2	AT commands in MAC and RLC ATs:	371
8.8.1.3	AT commands in NAS ATs:	372
8.8.1.4	AT commands in RAB ATs:	373
8.8.1.5	AT commands in RRC ATs:	374
8.8.1.6	AT commands SMS ATs:	375
8.8.1.7	AT commands in HSDPA ATs (Rel-5 or later):	376
8.8.1.8	AT commands for E-DCH testing (Rel-6 or later) and HS-ENH testing (Rel-7 or later)	377
8.8.2	AT Command Handling in TTCN	377
8.8.2.1	AT Command Interface	377
8.8.2.2	AT Command Dialogues	378
8.8.2.3	AT Response Types	378
8.8.2.3.1	'OK' Response	378
8.8.2.3.2	Name String	378
8.8.2.3.3	Error strings	378
8.8.2.4	AT Command Parameters And Options	378
8.9	Bit padding	379
8.9.1	Requirements for implementation	379
8.10	Test PDP contexts	379
8.10.1	Mapping of Quality of service and AT command for HSPA DL testing	381
8.10.1a	Mapping of Quality of service and AT command for LCR TDD HSPA DL testing	382
8.10.2	Mapping of Quality of service and AT command for HSPA UL testing	383
8.10.2a	Mapping of Quality of service and AT command for LCR TDD HSPA UL testing	384

8.10.3	Peak Throughput Class for HSPA testing	385
8.11	DCH-DSCH Configurations.....	385
8.11a	DCH with HS-DSCH Configurations (Rel-5 or later).....	386
8.11aa	HS-DSCH Configurations without DCH associated (Rel-6 or later)	388
8.11b	HS-DSCH Configuration Verification	391
8.11c	HS-DSCH Configurations for enhanced Cell FACH (Rel-7 or later) [Mapping CCCH/BCCH/PCCH on HS-DSCH]	391
8.12	Pre- and postambles for GERAN to UTRAN tests	392
8.12.1	Preamble for GERAN to UTRAN tests	392
8.12.2	Postamble for GERAN to UTRAN tests.....	392
8.12.2.1	GERAN to UTRAN handover in CS	392
8.12.2.2	GERAN to UTRAN cell change in PS (in PMM-CONNECTED)	393
8.12.2.3	GERAN to UTRAN DTM test cases	394
8.13	E-DCH configurations (Rel-6 or later).....	395
8.13.1	DPCH (SRB) and E-DCH (RAB) configuration	395
8.13.1.1	Serving E-DCH cell	395
8.13.1.2	SHO - addition of E-DCH RL in a serving RL cell (intra node B)	397
8.13.1.3	SHO – addition of E-DCH RL in a non-serving RL cell (inter node B)	398
8.13.2	DPCH/HS-DSCH/E-DCH setup and release order.....	399
8.13.3	Serving E-DCH cell with UL DTX Configured [Rel-7].....	399
8.14	Guidelines of MBMS implementations	400
8.14.1	MCCH scheduling implementation	400
8.14.2	MSCH scheduling and service data on MTCH.....	401
8.14.2.1	Scheduled service data on MTCH without MSCH configured	402
8.15	Cell mapping	404
8.16	Guidelines for CS voice over HSPA implementation	405
Annex A (normative): Abstract Test Suites (ATS).....		406
A.1	Version of specifications	406
A.2	NAS ATS	406
A.2.1	Void.....	409
A.2.2	The TTCN Machine Processable form (TTCN.MP)	409
A.3	SMS ATS	409
A.3.1	Void.....	409
A.3.2	The TTCN Machine Processable form (TTCN.MP)	409
A.4	RRC ATS	410
A.4.1	Void.....	415
A.4.2	The TTCN Machine Processable form (TTCN.MP)	415
A.5	RLC ATS.....	415
A.5.1	Void.....	416
A.5.2	The TTCN Machine Processable form (TTCN.MP)	416
A.6	MAC ATS	416
A.6.1	Void.....	416
A.6.2	The TTCN Machine Processable form (TTCN.MP)	416
A.7	BMC ATS	416
A.7.1	Void.....	416
A.7.2	The TTCN Machine Processable form (TTCN.MP)	416
A.8	PDCP ATS	417
A.8.1	Void.....	417
A.8.2	The TTCN Machine Processable form (TTCN.MP)	417
A.9	RAB ATS	417
A.9.1	Void.....	419
A.9.2	The TTCN Machine Processable form (TTCN.MP)	419
A.10	IR_U ATS	419
A.10.1	Void.....	420
A.10.2	The TTCN Machine Processable form (TTCN.MP)	420

A.11	AGPS ATS	421
A.11.1	Void.....	421
A.11.2	The TTCN Machine Processable form (TTCN.MP)	421
A.12	HSD_ENH ATS	421
A.12.1	Void.....	424
A.12.2	The TTCN Machine Processable form (TTCN.MP)	424
A.13	HSU_ENH ATS	424
A.13.1	Void.....	426
A.13.2	The TTCN Machine Processable form (TTCN.MP)	426
A.14	MBMS ATS	427
A.14.1	Void.....	428
A.14.2	The TTCN Machine Processable form (TTCN.MP)	428
A.15	HSPA7_ENH ATS	428
A.15.1	Void.....	430
A.15.2	The TTCN Machine Processable form (TTCN.MP)	430
A.16	HSPA8_ENH ATS	431
A.16.1	Void.....	432
A.16.2	The TTCN Machine Processable form (TTCN.MP)	432
A.17	HSPA9_ENH ATS	432
A.17.1	Void.....	432
A.17.2	The TTCN Machine Processable form (TTCN.MP)	432
Annex B (normative): Partial IXIT proforma.....		433
B.0	Introduction	433
B.1	Parameter values	433
B.1.1	BasicM test suite parameter declarations	433
B.1.2	L3M test suite parameters declarations	436
B.1.3	NAS test suite parameters declarations	438
B.1.4	SMS test suite parameters declarations	438
B.1.5	RRC_M test suite parameters declarations.....	439
B.1.6	PDCCP test suite parameters declarations	440
B.1.7	BMC test suite parameters declarations	441
B.1.8	RRC test suite parameters declarations	441
B.1.9	RAB test suite parameters declarations	442
B.1.10	RLC and MAC test suite parameters declarations.....	442
B.1.11	Multi RAT test suite parameters declarations	443
B.1.12	MMI questions	444
B.1.13	A-GPS test suite parameters declarations.....	446
B.1.14	HSD_ENH test suite parameters declarations	446
B.1.15	HSU_ENH test suite parameters declarations	447
B.1.16	HS_ENH test suite parameters declarations.....	447
B.1.17	Audit capabilities test suite parameters declarations	448
B.1.18	eCall and HSPA8 test suite parameters declarations	452
B.1.19	IR_U test suite parameters declarations	453
Annex C (informative): Additional information to IXIT.....		454
C.1	Identification Summary.....	454
C.2	Abstract Test Suite Summary.....	454
C.3	Test Laboratory	455
C.3.1	Test Laboratory Identification.....	455
C.3.2	Accreditation status of the test service	455
C.3.3	Manager of Test Laboratory	455
C.3.4	Contact person of Test Laboratory	455
C.3.5	Means of Testing.....	456
C.3.6	Instructions for Completion.....	456

C.4	Client	457
C.4.1	Client Identification	457
C.4.2	Client Test Manager	457
C.4.3	Client Contact person	458
C.4.4	Test Facilities Required	458
C.5	System Under Test	459
C.5.1	SUT Information	459
C.5.2	Limitations of the SUT	459
C.5.3	Environmental Conditions	460
C.6	Ancillary Protocols	460
C.6.1	Ancillary Protocols 1	460
C.6.2	Ancillary Protocols 2	461
Annex D (informative):	PCTR Proforma	462
Annex E (informative):	TTCN style guide for 3GPP ATS	463
E.1	Introduction	463
E.2	ETR 141 rules and applicability	463
E.2.1	Multiple words are separated by upper case letters at the start of each word	464
E.2.2	Identifiers shall be protocol standard aligned	465
E.2.3	Identifiers shall be distinguishing (use of prefixes)	466
E.2.4	Identifiers should not be too long (use standard abbreviations)	468
E.2.5	Test suite operations must not use global data	471
E.3	3GPP ATS implementation guidelines	475
E.3.1	Test case groups shall reflect the TSS&TP document	475
E.3.2	Test case names correspond to the clause number in the prose	475
E.3.3	Use standard template for test case and test step header	476
E.3.4	Do not use identical tags in nested CHOICE constructions	477
E.3.5	Incorrect usage of enumerations	478
E.3.6	Structured type as OCTETSTRING should not be used	478
E.3.7	Wildcards in PDU constraints for structured types should not be used	478
E.3.8	TSOs should be passed as many parameters as meaningful to facilitate their implementation	479
E.3.9	Specification of Encoding rules and variation should be indicated	480
E.3.10	Use of global data should be limited	480
E.3.11	Limit ATS scope to a single layer / sub-layer	480
E.3.12	Place system information in specially designed data structures	480
E.3.13	Place channel configuration in specially designed data structures	480
E.3.14	PICS / PIXIT parameters	480
E.3.15	Dynamic vs. static choices	481
E.3.16	Definition of Pre-Ambls and Post Ambls	481
E.3.17	Use test steps to encapsulate AT and MMI commands	482
E.3.18	Use system failure guard timers	482
E.3.19	Mapping between prose specification and individual test cases	482
E.3.20	Verdict assignment	482
E.3.20.1	General	482
E.3.20.2	Test cases	483
E.3.20.3	Test steps	484
E.3.20.4	Defaults	485
E.3.21	Test suite and test case variables	485
E.3.22	Use of macros is forbidden	486
E.3.23	Support for future Radio Access Technologies	486
E.3.24	Managing multiple representations of the same information	486
E.3.24.1	Predefined types	486
E.3.24.2	Simple types	487
E.3.24.3	Structured types	487
E.3.24.4	Conversion responsibility	487
E.3.24.5	Option 1: Calling party conversions	487
E.3.24.5.1	Advantages	487
E.3.24.5.2	Disadvantages	488

E.3.24.6	Option 2: Called party conversions.....	488
E.3.24.6.1	Advantages.....	488
E.3.24.6.2	Disadvantages	488
E.3.25	Assignment using constraint.....	488
E.3.26	Guidelines for use of timers when tolerances are applicable.....	488
E.3.26.1	Specific situations	488
E.3.26.2	Example situations	489
E.3.26.2.1	Example of situation 1	489
E.3.26.2.2	Example of situation 2	489
E.3.26.2.3	Example of situation 3	490
Annex F (informative):	Void	491
Annex G (informative):	Recommendation of a unique ICS/IXIT electronic exchange format...	492
G.1	Syntax.....	492
G.2	Examples	493
Annex H (informative):	A-GPS ASN.1 module.....	494
Annex I (informative):	Guidance on test execution.....	505
I.1	Void.....	505
I.2	FDD test execution on different frequency bands.....	505
I.2.1	FDD Band VI, XIII, IX, XIV	505
I.2.2	FDD Band XII, XIX, XX, XXI	505
I.3	Void.....	505
I.4	InterRAT test execution	505
Annex J (informative):	Change history	506
History		563

Foreword

This Technical Specification has been produced by the 3rd Generation Partnership Project (3GPP).

The contents of the present document are subject to continuing work within the TSG and may change following formal TSG approval. Should the TSG modify the contents of the present document, it will be re-released by the TSG with an identifying change of release date and an increase in version number as follows:

Version x.y.z

where:

x the first digit:

- 1 presented to TSG for information;
- 2 presented to TSG for approval;
- 3 or greater indicates TSG approved document under change control.

y the second digit is incremented for all changes of substance, i.e. technical enhancements, corrections, updates, etc.

z the third digit is incremented when editorial only changes have been incorporated in the document.

Introduction

The present document is part 3 of a multi-part conformance test specification for UE. The specification contains a TTCN2 design frame work and the detailed test specifications in TTCN for UE at the Uu interface.

3GPP TS 34.123-1 [1]: "User Equipment (UE) conformance specification; Part 1: Protocol conformance specification".

3GPP TS 34.123-2 [2]: "User Equipment (UE) conformance specification; Part 2: Implementation Conformance Statement (ICS) proforma specification".

3GPP TS 34.123-3: "Abstract Test Suite (ATS)" (the present document).

1 Scope

The present document specifies the protocol conformance testing in TTCN for the 3GPP User Equipment (UE) at the Uu interface.

The present document is the 3rd part of a multi-part test specification, 3GPP TS 34.123. The following TTCN test specification and design considerations can be found in the present document:

- the overall test suite structure;
- the testing architecture;
- the test methods and PCO definitions;
- the test configurations;
- the design principles, assumptions, and used interfaces to the TTCN tester (System Simulator);
- TTCN styles and conventions;
- the partial PIXIT proforma;
- the TTCN.MP and TTCN.GR forms for the mentioned protocols tests.

The Abstract Test Suites designed in the document are based on the test cases specified in prose (3GPP TS 34.123-1 [1]).

The present document is valid for UE implemented according to 3GPP Release 1999, Release 4, Release 5, Release 6, Release 7, Release 8, Release 9, Release 10.

2 References

The following documents contain provisions, which, through reference in this text, constitute provisions of the present document.

- References are either specific (identified by date of publication, edition number, version number, etc.) or non-specific.
- For a specific reference, subsequent revisions do not apply.
- For a non-specific reference, the latest version applies. In the case of a reference to a 3GPP document (including a GSM document), a non-specific reference implicitly refers to the latest version of that document *in the same Release as the present document*.
 - For a Release 1999 UE, references to 3GPP documents are to version 3.x.y, when available.
 - For a Release 4 UE, references to 3GPP documents are to version 4.x.y, when available.
 - For a Release 5 UE, references to 3GPP documents are to version 5.x.y, when available.
 - For a Release 6 UE, references to 3GPP documents are to version 6.x.y, when available.
 - For a Release 7 UE, references to 3GPP documents are to version 7.x.y, when available.
 - For a Release 8 UE, references to 3GPP documents are to version 8.x.y, when available.
 - For a Release 9 UE, references to 3GPP documents are to version 9.x.y, when available.
 - For a Release 10 UE, references to 3GPP documents are to version a.x.y, when available.

[1] 3GPP TS 34.123-1: "User Equipment (UE) conformance specification; Part 1: Protocol conformance specification".

- [2] 3GPP TS 34.123-2: "User Equipment (UE) conformance specification; Part 2: Implementation Conformance Statement (ICS) proforma specification".
- [3] 3GPP TS 34.108: "Common test environments for User Equipment (UE) conformance testing".
- [4] 3GPP TS 34.109: "Terminal logical test interface; Special conformance testing functions".
- [5] 3GPP TR 21.905: "Vocabulary for 3GPP specifications".
- [6] 3GPP TS 23.003: "Numbering, addressing and identification".
- [7] 3GPP TS 23.101: "General UMTS architecture".
- [8] 3GPP TS 24.007: "Mobile radio interface signalling layer 3; General aspects".
- [9] 3GPP TS 24.008: "Mobile radio interface layer 3 specification; Core network protocols; Stage 3".
- [10] 3GPP TS 24.011: "Point-to-Point (PP) Short Message Service (SMS) support on mobile radio interface".
- [11] 3GPP TS 24.012: "Short Message Service Cell Broadcast (SMSCB) support on the mobile radio interface".
- [12] 3GPP TS 25.214: "Physical layer procedures (FDD)".
- [13] 3GPP TS 25.224: "Physical layer procedures (TDD)".
- [14] 3GPP TS 25.301: "Radio interface protocol architecture".
- [15] 3GPP TS 25.303: "Interlayer procedures in connected mode".
- [16] 3GPP TS 25.304: "User Equipment (UE) procedures in idle mode and procedures for cell reselection in connected mode".
- [17] 3GPP TS 25.321: "Medium Access Control (MAC) protocol specification".
- [18] 3GPP TS 25.322: "Radio Link Control (RLC) protocol specification".
- [19] 3GPP TS 25.323: "Packet Data Convergence Protocol (PDCP) specification".
- [20] 3GPP TS 25.324: "Broadcast/Multicast Control (BMC)".
- [21] 3GPP TS 25.331: "Radio Resource Control (RRC) protocol specification".
- [22] 3GPP TS 27.005: "Use of Data Terminal Equipment - Data Circuit terminating Equipment (DTE-DCE) interface for Short Message Service (SMS) and Cell Broadcast Service (CBS)".
- [23] 3GPP TS 27.007: "AT command set for 3G User Equipment (UE)".
- [24] 3GPP TS 27.060: "Packet domain; Mobile Station (MS) supporting Packet Switched services".
- [25] 3GPP TS 33.102: "3G security; Security architecture".
- [26] 3GPP TS 51.010-1: "Mobile Station (MS) conformance specification; Part 1: Conformance specification".
- [27] ETSI TR 101 666 (V1.0.0): "Information technology; Open Systems Interconnection Conformance testing methodology and framework; The Tree and Tabular Combined Notation (TTCN) (Ed. 2++)".
- [28] ITU-T Recommendation X.691 (1997) "Information technology - ASN.1 encoding rules: Specification of Packed Encoding Rules (PER)".
- [29] ISO/IEC 8824 (all parts): "Information technology - Abstract Syntax Notation One (ASN.1)".
- [30] IETF RFC 2507: "IP Header Compression".

- [31] 3GPP TS 45.002: "Multiplexing and multiple access on the radio path".
3GPP TS 05.02: "Digital cellular telecommunications system (Phase 2+); Multiplexing and multiple access on the radio path".
- [32] 3GPP TS 44.060: "General Packet Radio Service (GPRS); Mobile Station (MS) - Base Station System (BSS) interface; Radio Link Control/Medium Access Control (RLC/MAC) protocol".
3GPP TS 04.60: "Digital cellular telecommunications system (Phase 2+); General Packet Radio Service (GPRS); Mobile Station (MS) - Base Station System (BSS) interface; Radio Link Control/Medium Access Control (RLC/MAC) protocol".
- [33] 3GPP TS 44.064: "Mobile Station - Serving GPRS Support Node (MS-SGSN) Logical Link Control (LLC) layer specification".
- [34] 3GPP TS 23.038: "Alphabets and language-specific information".
- [35] 3GPP TS 23.040: "Technical realization of Short Message Service (SMS)".
- [36] 3GPP TS 23.041: "Technical realization of Cell Broadcast Service (CBS)".
- [37] ETSI ETR 141: "Methods for Testing and Specification (MTS); Protocol and profile conformance testing specifications; The Tree and Tabular Combined Notation (TTCN) style guide".
- [38] ETSI TR 101 101: "Methods for Testing and Specification (MTS); TTCN interim version including ASN.1 1994 support [ISO/IEC 9646-3] (Second Edition Mock-up for JTC1/SC21 Review)".
- [39] ITU-T Recommendation X.680: "Information technology - Abstract Syntax Notation One (ASN.1): Specification of basic notation".
- [40] 3GPP TS 25.211: "Physical channels and mapping of transport channels onto physical channels (FDD)".
- [41] ISO/IEC 9646 (all parts): "Information technology - Open Systems Interconnection - Conformance testing methodology and framework".
- [42] 3GPP TS 44.006: "Mobile Station - Base Stations System (MS - BSS) Interface Data Link (DL) layer specification".
- [43] 3GPP TS 44.018: "Mobile radio interface layer 3 specification; Radio Resource Control (RRC) protocol".
3GPP TS 04.18: "Digital cellular telecommunications system (Phase 2+); Mobile radio interface layer 3 specification; Radio Resource Control (RRC) protocol".
- [44] 3GPP TR 25.925: "Radio interface for Broadcast/Multicast Services".
- [45] ITU-T Recommendation O.153: "Basic parameters for the measurement of error performance at bit rates below the primary rate".
- [46] IETF RFC 1144: "Compressing TCP/IP headers for low-speed serial links".
- [47] ITU-T Recommendation V.42bis: "Data compression procedures for data circuit-terminating equipment (DCE) using error correction procedures".
- [48] ITU-T Recommendation V.44: "Data compression procedures".
- [49] 3GPP TS 44.008: "Mobile radio interface layer 3 specification".
3GPP TS 04.08: "Digital cellular telecommunications system (Phase 2+); Mobile radio interface layer 3 specification".
- [50] 3GPP TS 24.080: "Mobile radio interface layer 3 supplementary services specification; Formats and coding".
- [51] 3GPP TS 29.002: "Mobile Application Part (MAP) specification".
- [52] ITU-T Recommendation Q.773: "Signalling System No. 7 - Transaction Capabilities Formats and Encoding".

- [53] ITU-T Recommendation X.880: "Information Technology - Remote Operations: Concepts, Model and Notation".
- [54] IETF RFC 3095: "RObust Header Compression (ROHC): Framework and four profiles: RTP, UDP, ESP, and uncompressed".
- [55] 3GPP TS 34.022: "Radio Link Protocol (RLP) for circuit switched bearer and teleservices".
- [56] 3GPP TS 36.571-4: "Evolved Universal Terrestrial Radio Access (E-UTRA) and Evolved Packet Core (EPC); User Equipment (UE) conformance specification for UE positioning; Part 4: Test suites".
- [57] 3GPP TS 25.433: "UTRAN Iub interface Node B Application Part (NBAP) signalling".
- [58] 3GPP TS 25.212: "Multiplexing and channel coding (FDD)".
- [59] 3GPP TS 25.306: "UE Radio Access capabilities".
- [60] 3GPP TS 23.060: "General Packet Radio Service (GPRS); Service description; Stage 2".
- [61] 3GPP TS 44.118: "Mobile radio interface layer 3 specification, Radio Resource Control (RRC) protocol; Iu mode".
- [62] 3GPP TS 36.523-3: "Evolved Universal Terrestrial Radio Access (E-UTRA) and Evolved Packet Core (EPC); User Equipment (UE) conformance specification; Part 3: Abstract Test Suites (ATS)".
- [63] 3GPP TS 37.571-2: "Universal Terrestrial Radio Access (UTRA) and Evolved UTRA (E-UTRA) and Evolved Packet Core (EPC); User Equipment (UE) conformance specification for UE positioning; Part 2: Protocol conformance".
- [64] 3GPP TS 37.571-4: "Universal Terrestrial Radio Access (UTRA) and Evolved UTRA (E-UTRA) and Evolved Packet Core (EPC); User Equipment (UE) conformance specification for UE positioning; Part 4: Test suites".

3 Definitions and abbreviations

3.1 Definitions

For the purposes of the present document, the terms and definitions given in 3GPP TS 34.123-1 [1] apply.

3.2 Abbreviations

For the purposes of the present document, the abbreviations given in 3GPP TS 34.123-1 [1], 3GPP TS 24.008 [9], 3GPP TS 25.331 [21] and TR 101 666 [27] apply.

4 Requirements on the TTCN development

A number of requirements are identified for the development and production of TTCN specification for 3GPP UE at Uu interface.

1. Top-down design, following 3GPP TS 34.123-1 [1], 3GPP TS 34.108 [3] and 3GPP TS 34.109 [4].
2. A unique testing architecture and test method for testing all protocol layers of UE.
3. Uniform TTCN style and naming conventions.
4. Improve TTCN readability.

5. Using TTCN-2++ (TR 101 666 [27]) for R99, Release 4, Release 5, Release 6, Release 7, Release 8 and Release 9 avoid the use of the TTCN 2 features TTCN 3 does not support.
6. TTCN specification feasible, implementable and compilable.
7. Test cases shall be designed in a way for easily adaptable, upwards compatible with the evolution of the 3GPP core specifications and the future Releases.
8. The test declarations, data structures and data values shall be largely reusable.
9. Modularity and modular working method.
10. NAS ATS should be designed being independent from the radio access technologies.
11. Minimizing the requirements of intelligence on the emulators of the lower testers. Especially the functionality of the RRC emulator in the TTCN tester should be reduced and simplified, the behaviours should be standardized as the TTCN RRC test steps in the TTCN modular library.
12. Giving enough design freedom to the test equipment manufacturers.
13. Maximizing reuse of ASN.1 definitions from the relevant core specifications.

In order to fulfil these requirements and to ensure the investment of the test equipment manufacturers having a stable testing architecture for a relatively long period, a unique testing architecture and test method are applied to the 3GPP UE protocol tests.

5 ATS structure

The total TTCN specification for the UE testing is structured in a number of separate layered ATSs. The number of ATS being produced corresponds to the number of the 3GPP core specifications referred. The separation of ATSs reduces the size of ATSs. The layer-specific test preambles and test data can be confined to one test suite and parallel development of test suites can be facilitated. The separation of ATSs enables also easily to follow the evolution of the core specifications.

- NAS ATSs:
 - 1) GSM MAP L3 ATS including MM, CC, GMM, SM test groups;
 - 2) SMS ATS;
 - 3) A-GPS ATS
- AS ATSs:
 - 1) RRC ATS including Single cell and multicell test group;
 - 2) RLC ATS;
 - 3) MAC ATS;
 - 4) BMC ATS;
 - 5) PDCP ATS;
 - 6) RAB ATS;
 - 7) IR_U ATS;
 - 8) HSD_ENH ATS (Rel-5 or later);
 - 9) HSU_ENH ATS (Rel-6 or later);
 - 10) MBMS ATS (Rel-6 or later);
 - 11) HSPA7_ENH ATS (Rel-7 or later);

12)HSPA8_ENH ATS (Rel-8 or later);

13)HSPA9_ENH ATS (Rel-9 or later).

5.1 Modularity

The modular TTCN approach is used for the development of the 3GPP ATS specification work. Three modules, BasicM, RRC_M and L3M are installed.

5.1.1 Module structure

The module structure is shown in Figure 5.1.1.

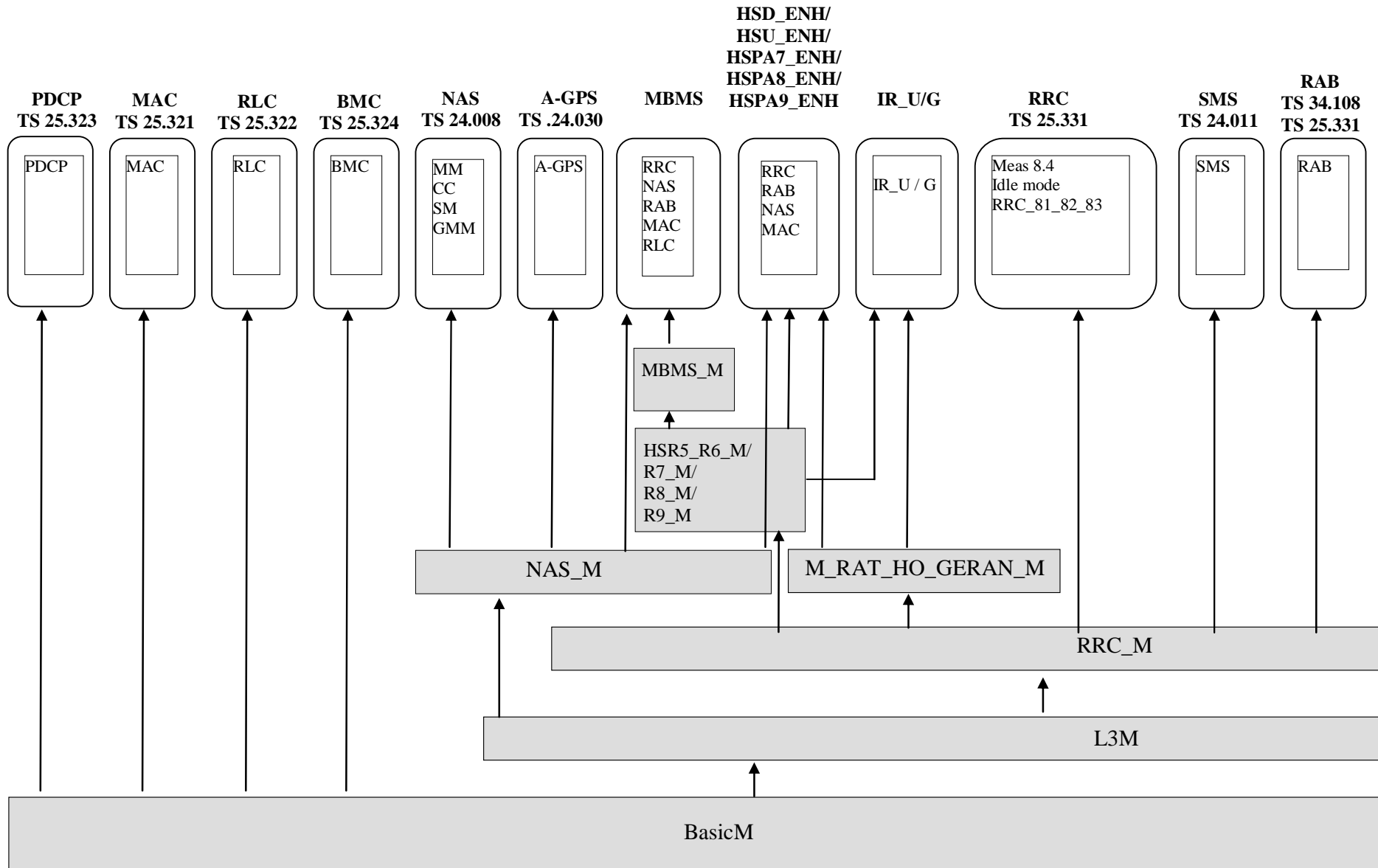

Figure 5.1.1: Module structure

The BasicM (**Basic Module**) is a minimum module commonly for the layer 2 and layer 3 testing. The L3M (**Layer 3 Module**) contains all the items to be shared by the RRC, NAS, SMS, RAB, IR_U/G, A-GPS, HSD_ENH, HSU_ENH and MBMS ATSS. NAS is applied to the NAS, A-GPS, HSD_ENH, HSU_ENH, MBMS, HSPA7_ENH, HSPA8_ENH and HSPA9_ENH ATSS. The RRC_M is a module containing common object for RRC, RAB, IR_U/G, SMS, A-GPS, HSD_ENH, HSU_ENH, MBMS, HSPA7_ENH, HSPA8_ENH and HSPA9_ENH ATSS.

5.1.2 Contents of the modules

The BasicM module includes objects related to the RRC, the layer 2 and the physical layer. It includes also all test steps needed by the layer 2 and layer 3 test cases for configurations and all objects related to the definition of the steps:

- Common test steps and default test steps defined as generic procedures in 3GPP TS 34.108 [3];
- RRC declarations related to the steps: types, timers, PDU types, ASP type, PCOs, TSOs, constants;
- Related ICS and IXIT parameters needed for testing and respectively defined in 3GPP TS 34.123-2 [2] and the present document;
- Defaults constraints based on the default message contents defined in 3GPP TS 34.108 [3];
- MMI PCO and ASPs;
- All TTCN objects related to the SS configuration, e.g. PCOs, declaration of the components.

The L3M module includes the NAS configuration steps and all related TTCN objects:

- Common test steps and default test steps defined as generic procedures in 3GPP TS 34.108 [3];
- NAS declarations related to these steps: types, PDU, ASP, PCOs, TSOs, constants;
- Related ICS and IXIT parameters needed for testing and respectively defined in 3GPP TS 34.123-2 [2] and the present document;
- Default constraints based on the default message contents defined in 3GPP TS 34.108 [3].

The RRC_M module includes the RRC steps common to RRC and RAB test cases and all related TTCN objects.

5.1.3 Example of a working platform

Figure 5.1.3 shows the working platform for the user that is writing the SMS test cases.

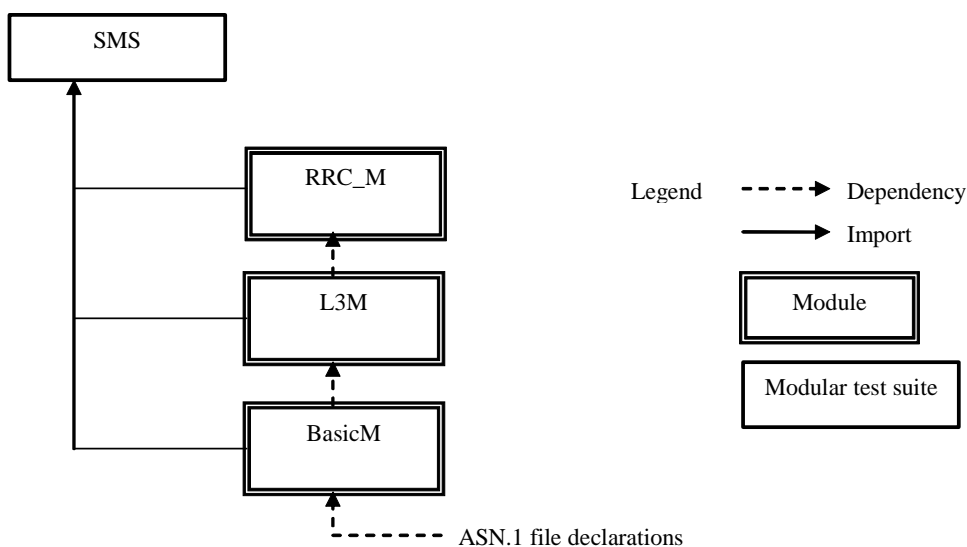

Figure 5.1.3: An example of working platform for SMS

6 Test method and testing architecture

6.1 Test method

The distributed single party test method is used for the UE testing. The lower tester configures the emulator and communicates with the UE under test via the emulator. An upper tester interfaces UE as (E)MMI.

All common parts in 3GPP TS 34.108 [3], 3GPP TS 34.109 [4] and 3GPP TS 34.123-2 [2] are developed in a TTCN library including the declarations, default constraints, preambles and postambles. They have the following characteristics:

- Very complex;
- Worked in different layers;
- Including data representing the radio parameters for SS setting and the data representing the UE capabilities (PICS parameters);
- Including the generic procedures to bring the UE into certain test states or a test mode (C-plane);
- Setting RABs at U-plane and SRBs in C-plane;
- Being used by every test cases no matter which layer the test case belongs to;
- No affect on the test verdict of PASS or FAIL.

The layer-specific test cases have the characteristics:

- relatively simple and straight forward;
- having narrow test scope and test purposes;
- test scenarios in a single layer (one PCO);
- assigning the test verdict.

6.2.3 Upper Tester (UT)

An Upper Tester (UT) exists in the test system. The UT interfaces toward UE with any optional EMMI (3GPP TS 34.109 [4], clause 7). TTCN communicates with the UT by passing coordination primitives via a Ut PCO. The primitives can either contain AT commands aiming at the automatic tests, or some informal commands as MMI, in order to request the UE for certain actions and to provide simple means for observations of UE.

6.2.4 TTCN

TTCN is used as specification language based on TR 101 666 [27] (TTCN 2++). The importation of ASN.1 modules and modular TTCN are two of the most important features used in the design of the ATSSs.

The TTCN test suites have been designed to maximize the portability from the language TTCN 2 to TTCN 3.

6.2.5 Model extension

If a test case needs to handle a concurrent situation two or more LTs can be configured at the same time. The following test scenarios identified may require multiple testers in the test configuration.

6.2.6 Multiplexing of RLC services

For the RRC and NAS testing, the TTCN RRC test steps (on RB1 and RB2) and the RRC emulator (on RB3 and RB4 for the NAS messages) share the same service access point (AM SAP). The RLC emulator shall provide separate message queues (buffers) for the TTCN RRC test steps and the RRC emulator for the TTCN NAS test cases, according to the signalling radio bearer identities.

6.3 NAS test method and architecture

6.3.1 Test configuration

The NAS test method is shown in Figure 6.3.1.

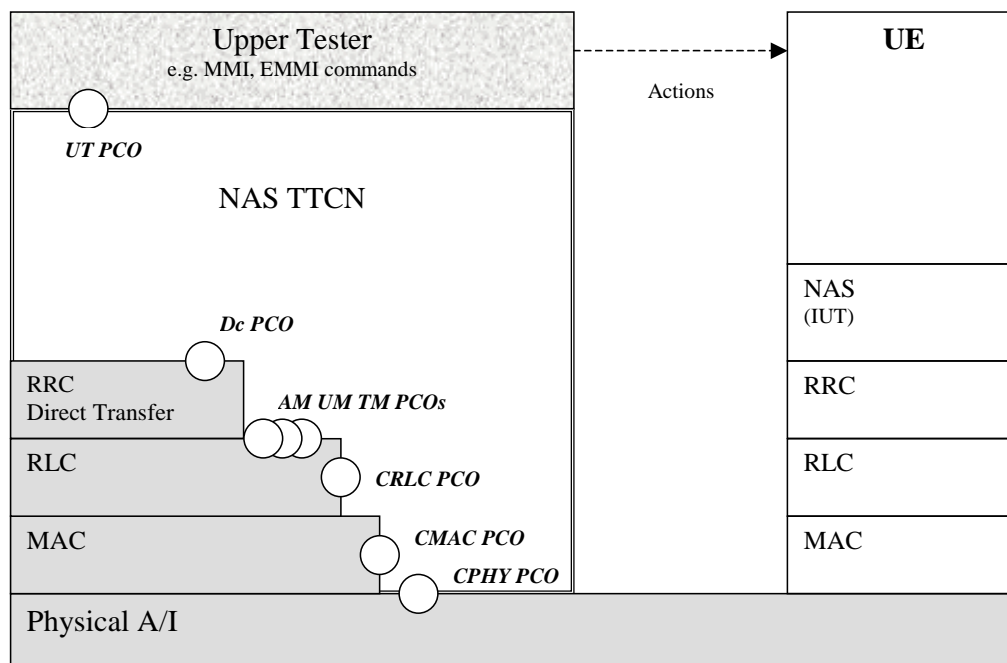

Figure 6.3.1: NAS testing architecture

The single layer distributed test method is used.

The Point of Control and Observation (PCO) are defined as the Dc (Dedicated control) SAP. The NAS test verdicts are assigned depending on the behaviours observed at the PCO.

The TTCN tester provides the NAS TTCN test cases and steps with a simple RRC direct transfer function which buffers the NAS PDU data, converts the data from the NAS TTCN table format into ASN.1, or in reverse way, and delivers all lower layer services of AM-SAP for RB3 and RB4.

The NAS TTCN test cases make also intensively use of the RRC TTCN test steps, in order to:

- Configure, initialize and control the L2 emulator;
- Initialize the UE for testing.

The RRC test steps, which are called by the NAS test cases or steps, interface with the RLC PCOs (UM, AM and TR), the control PCOs CRLC, CMAC and CPHY.

The General control (Gc) SAP and the Notification (Nt) SAP are not applied. Messages exchanged via these SAPs will be replaced with the corresponding RRC TTCN test steps.

The Ut PCO (so called logical interface [4]) is served as the interface to the UE EMMI to allow a remote control of operations, which have to be performed during execution of a test case such as to switch the UE on/off, initiate a call, etc.

6.3.2 Routing UL NAS messages in SS

The UL NAS messages are embedded in RRC messages INITIAL / UL DIRECT TRANSFER. In the UE test, the received UL NAS messages can either be routed to the Dc PCO and verified at the NAS message level, or routed to AM PCO and verified at the RRC message level.

- 1) RBid = 3 at the SS side indicates that the UL NAS high priority messages to be routed to Dc PCO. RB3 applies to RRC_DataInd/Req.
- 2) RBid = -16 at the SS side indicates the received messages to be routed to RLC AM PCO. RB-16 applies to RLC_DataInd/Req.

The RB3 and RB-16 do not coexist. The TTCN writer uses the MAC and RLC reconfigurations to re-map the RB and the corresponding logical channels. If RB3 has been configured, but a test case needs to re-map the logical channel from RB3 to RB-16 the following way is to replace RB3 with RB-16.

- CMAC_CONFIG_REQ (reconfiguration, RB-16).

Re-mapping on RB-16 which appears in the transport channel and logical channel mapping list.

- CRLC_CONFIG_REQ (reconfiguration, RB-16).

RB-16 appears in the routing info, in order to replace the original mapping on RB3.

Mapping from RB-16 to RB3 is done in the reverse way.

6.4 RRC and RAB test method and architecture

6.4.1 Test configuration

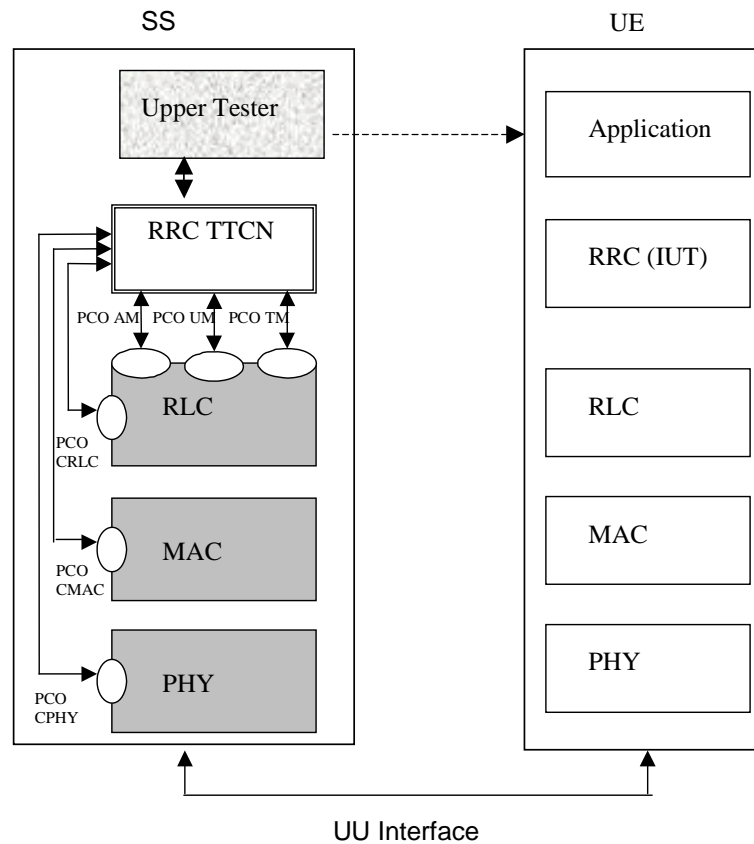

Figure 6.4.1: RRC testing architecture

The single layer distributed test method is used.

The PCOs are defined as the AM (Acknowledged Mode), UM (Unacknowledged Mode) and TM (Transparent Mode) SAPs. The RRC test verdicts are assigned depending on the behaviours observed at the PCO. The RRC TTCN interface also with the control PCOs CRLC, CMAC and CPHY, for the configuration, initialization and control of the System Simulator.

The RRC TTCN test cases also make use of the NAS TTCN test steps in order to:

- Bring UE to Idle state;
- Bring UE to state U10.

The NAS test steps, which are called by the RRC test cases or steps, interface with the Dc PCO.

The Ut PCO (so called logical interface [4]) is served as the interface to the UE EMMI to allow a remote control of operations, which have to be performed during execution of a test case such as to switch the UE on/off, initiate a call, etc.

According to 3GPP TS 25.331 [21], clause 12.1.1, the encoding of RRC PDUs is obtained by applying UNALIGNED PER to the abstract syntax value as specified in ITU-T Recommendation X.691 [28]. The two tables below show the declaration of the encoding rule and an example of the use in the definition of an RRC PDU.

Table 6.4.1.1: PER_Unaligned Encoding Rule

Encoding Rule Name	PER_Unaligned
Reference	ITU-T Recommendation X.691 [28]
Default	
Comments	Packet encoding rules (ITU-T Recommendation X.691 [28]) unaligned and with adapted padding

Table 6.4.1.2: Definition of the RRC ASN.1 DL_DCCH_Message type by reference

PDU Name	DL_DCCH_Message
PCO Type	DSAP
Type Reference	DL-DCCH-Message
Module Identifier	Class-definitions
Enc Rule	PER_Unaligned
Enc Variation	

6.4.2 RAB test method

6.4.2.1 Sending data on the same TTI

The RAB test requires a specific test method to send the test data on the same TTI. The TFC restriction method is used in this case. A specific TFC subset is allowed to ensure the test data are sent on different RBs on the same TTI. The downlink restriction can be used to ensure that the SS uses a specific TFC for transmission of data, by only allowing the "No data" TFC, and the "desired" TFC. It may also be necessary to include one or more "signalling only" TFCs to allow signalling to occur. The uplink restriction can be used to verify that the UE has used a specific TFC. Any data received by the SS using a forbidden TFCI shall be discarded.

6.4.2.2 Sending continuous data on consecutive TTIs

The RBS ATS is developed using the tabular TTCN notation. In order to test of multiple-RB combinations and simultaneous signalling, the SS shall be capable of sending continues test data in every TTI using the downlink transport format combination under test. A specific TSO is designed to request the SS sending continuous data. The information about the number of RLC SDUs and their sizes for each RAB will be provided to the system simulator through TSO.

6.5 RLC test method and architecture

6.5.1 Testing architecture

Figure 6.5.1 illustrates a typical realization of the RLC ATS.

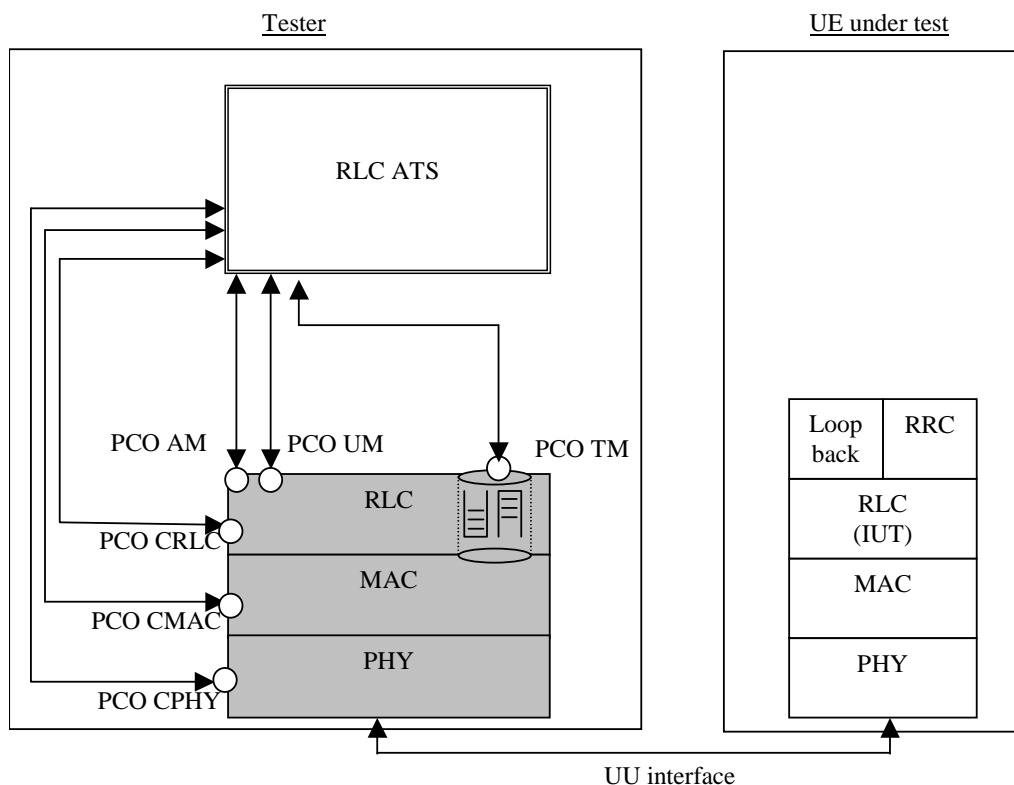

Figure 6.5.1: RLC ATS single party test method

The single party test method is used for RLC testing.

Separation of TTCN test cases from the configuration of the tester and initialization of the UE is achieved by using test steps. For each RLC test case, common test steps will be used to perform the configuration of the tester and the appropriate generic setup procedures as described in 3GPP TS 34.108 [3]. These test steps will make use of PCOs AM, UM, TM, CRLC, CMAC, and CPHY.

Three PCOs are provided at the top of the RLC emulation in the tester, one corresponding to each of the available RLC modes: acknowledged, unacknowledged, and transparent. Routing information for different radio bearers used at these PCOs will be provided in ASP parameters.

The queues shown in the RLC emulation in Figure 6.5.1 indicate that normal RLC transmit and receive buffering will be used to isolate the TTCN test suite from the real time issues involved if messages are sent directly to the MAC layer.

The RLC TTCN test cases make also use of the NAS TTCN test steps in order to bring UE to Idle state. The NAS test steps, which are called by the RLC test cases or steps, interface with the Dc PCO.

6.5.2 Test method

Figure 6.5.2.1 illustrates an example configuration for downlink UM testing. Uplink and AM tests will use similar configurations. A Tr-Entity is established on the tester side using a CRLC-CONFIG-REQ. A corresponding UM-Entity is created in the UE by sending a Radio Bearer Setup PDU. RLC PDUs are specified in the TTCN test suite, and sent to TM PCO. These PDUs shall be carefully designed so that the Tr-Entity will not perform any segmentation. The system simulator is responsible for direct encoding the abstract representation of transmitted PDUs into a bitstring to be sent by the Transmitting Tr entity. Direct encoding is performed by concatenation of all of the present fields in the abstract representation. It is the TTCN author's responsibility to ensure that the PDU is valid. To test reassembly in the UE side, the segmentation must be explicitly coded in TTCN. To test various aspects of the RLC header (e.g. sequence numbering, length indications, etc.), the RLC header must be explicitly coded in TTCN. Ciphering will not be tested using this approach, and will be disabled in the UE UM Entity.

The segmentation block in the SS Tr-entity is shown in grey to indicate that the functionality is present in the SS, but the test cases shall be carefully designed to ensure that segmentation is not used in the SS Tr-entity for RLC testing.

The deciphering block in the UE UM-entity is shown in grey to indicate that the functionality may be present in the UE, but shall be disabled for RLC testing.

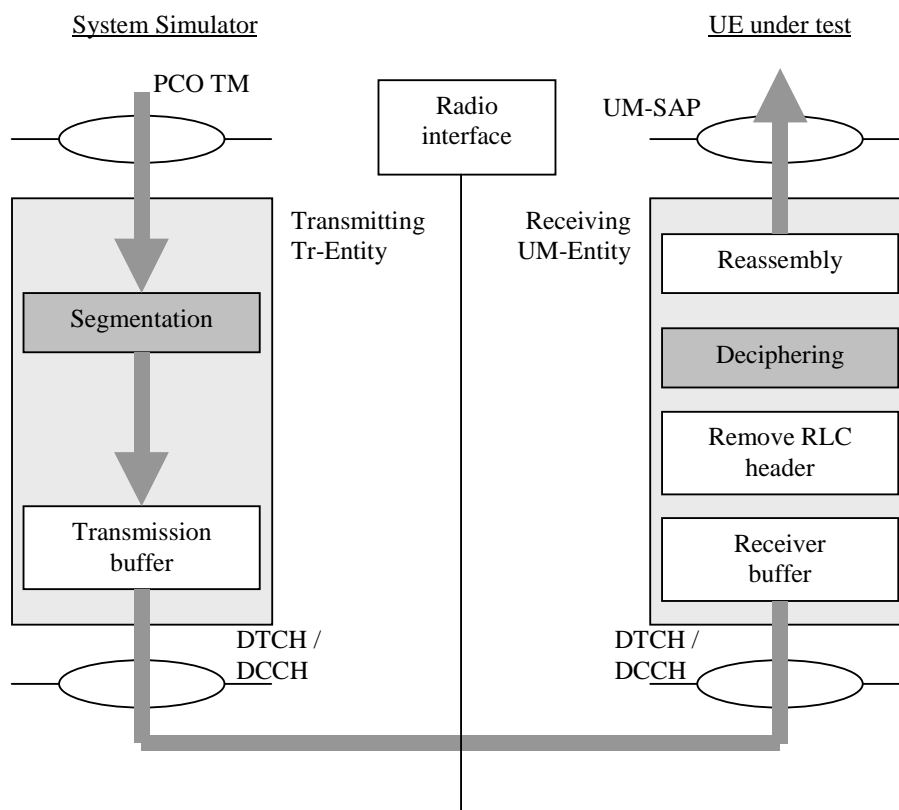

Figure 6.5.2.1: Example configuration for downlink RLC UM testing

The TFCS used for RLC testing must guarantee that Tr mode segmentation will not occur. This is to prevent transmission of more than one Tr PDU per TTI.

All RLC tests that require uplink data will make use of the UE test loop mode 1 defined in 3GPP TS 34.109 [4]. The UE test loop mode 1 function provides all Upper Tester (UT) functionality required, so an UT PCO is not required for RLC tests. Test Loop mode 1 is only available in the user plane, so all RLC tests will be performed in the user plane, using DTCH and DCCH logical channels mapped to DCH transport channels.

Ciphering will be disabled for all RLC test cases. Ciphering will be tested implicitly by other test cases that have ciphering enabled.

Figure 6.5.2.2 illustrates an example configuration for uplink UM testing, and reception of an example UMD PDU. Figure 6.5.2.3 illustrates an example configuration for uplink AM testing, reception of an example STATUS_PDU, and the use of the superFields and superFieldsRec fields.

The ciphering and deciphering blocks in the UE RLC entities are shown in grey to indicate that the functionality may be present in the UE, but shall be disabled for RLC testing.

The reassembly blocks in the SS Tr-entities are shown in grey to indicate that the functionality is present in the SS, but the test cases shall be carefully designed to ensure that reassembly is not used in the SS Tr-entity for RLC testing.

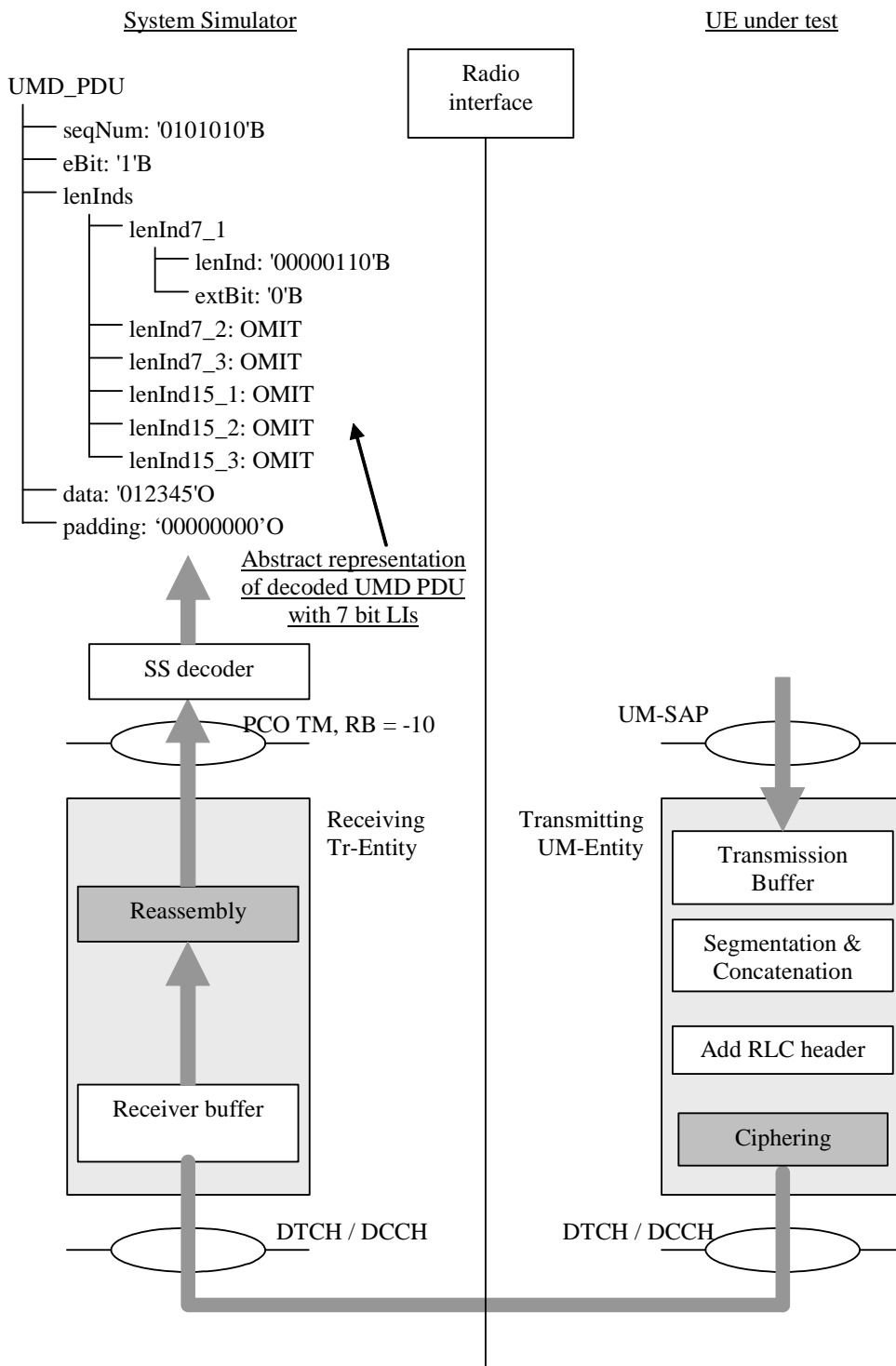

Figure 6.5.2.2: Example configuration for uplink RLC UM testing

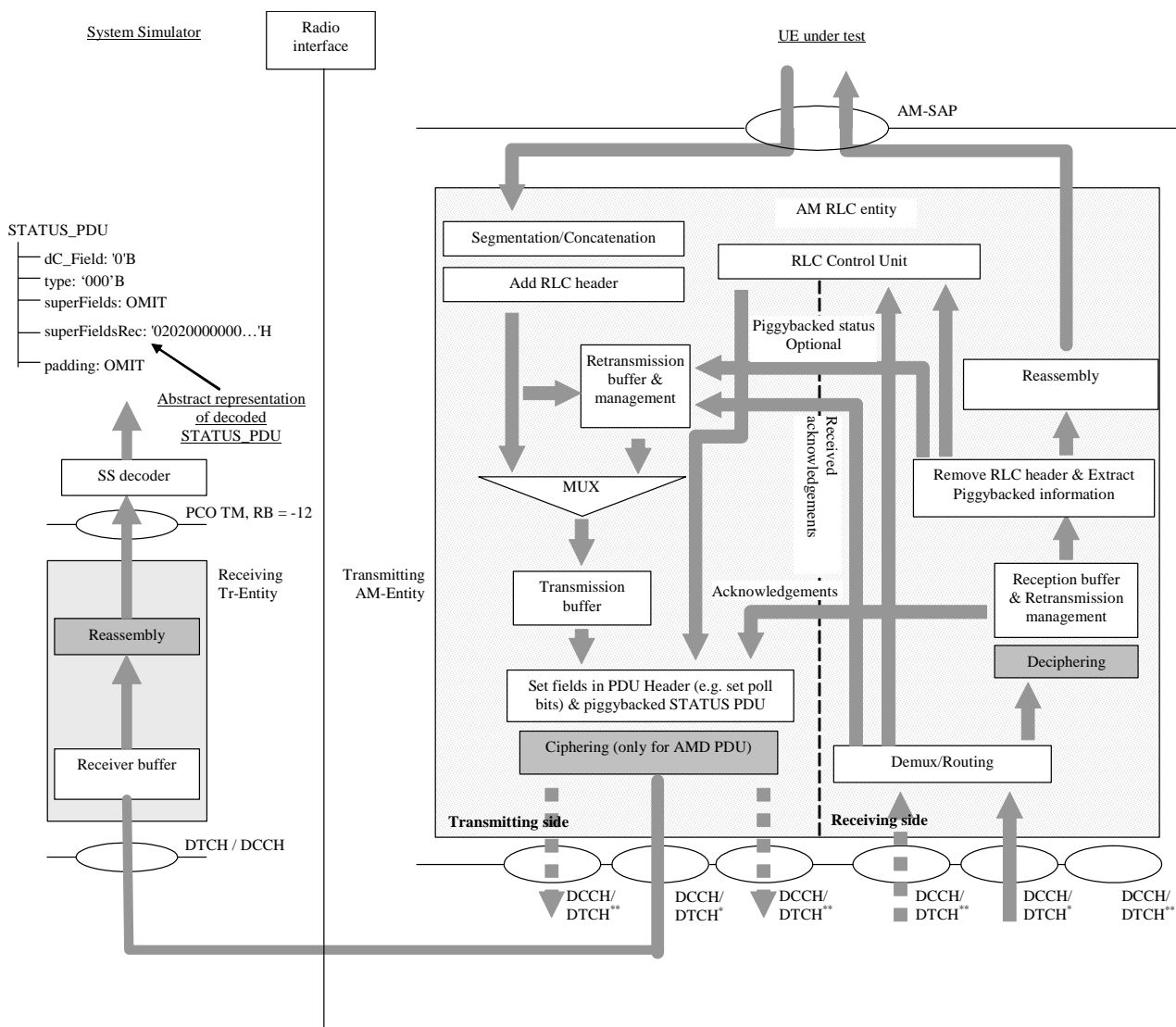

Figure 6.5.2.3: Example configuration for uplink RLC AM testing

Uplink data uses a similar approach to downlink, but the received data must be decoded in the correct way, depending on the current UE configuration. In the example in Figure 6.5.2.2, the SS must decode the data received at the TM PCO into an abstract representation of the structure defined in the TTCN for a UMD_PDU, using 7 bit length indicators. This structure is then compared with an abstract representation of the expected data to see if the receive event is successful. Refer to TR 101 666 [27], clause B.5.2.10 for more information.

For RLC testing, the following RB Ids are used within the system simulator, depending on the RLC mode, and length indicator size being simulated.

RLC mode	LI Size	RB Id
UM	7	-10
UM	15	-11
AM	7	-12
AM	15	-13
UM/AM (Rel-7 or later)	7/15	-25

The SS decoder can use the RB Id to determine which abstract structure to create during the decode process. The SS decoder must also understand the RLC peer-to-peer protocol enough to determine which fields are present.

EXAMPLE 1: The semantics of LI extension bits must be known to determine how many LIs are present.

EXAMPLE 2: The contents of the LIs must be interpreted to determine how many octets of data, and how many octets of padding are present.

The SUFI list and any subsequent padding in a received STATUS_PDU or PiggyBackedSTATUS_PDU shall be decoded as a HEXSTRING, and put in the 'superFieldsRec' field of the abstract representation of the STATUS PDU. The "superFields" and "padding" fields shall be omitted for received STATUS PDUs. This is illustrated in Figure 6.5.2.3.

As in downlink testing, the TFCS must be defined to guarantee that the Tr entity does not perform any reassembly. This is to prevent reception of more than one Tr PDU per TTI so that the TTCN does not need to manage possible interleaving problems due to multiple PDUs received at the same time (i.e. they may be placed on the PCO queue in any order).

6.5.2.1 Handling SUFIs in TTCN

The SUFIs are a very flexible set of information elements contained in the RLC protocol. The order of the fields varies, the existence of a field may depend upon the presence of another one. A field can be present multiple times. For matching received SUFIs, it is convenient to define the SUFIs as a HEXSTRING which is treated by a TSO **o_SUFI_Handler**.

Depending upon which SUFIs and which aspects of SUFIs are to be checked, the TSO is provided with the information (**SUFI_Params**) on what checking it is expected to perform. If the check is successful the result TRUE will be returned, otherwise FALSE. Additionally the TSO will return an object which is structured as the SUFIs used in transmission (SuperFields). This will allow to make use of information received and needed to establish SUFIs to be transmitted.

The input parameters to **o_SUFI_Handler** to be used as checking criteria are collected in tabular data structure **SUFI_Params** which is filled each time before the TSO is called. These data are to allow the checking of the presence and the value of SUFIs. All entries shall be set to well-defined values if these are to be used by **o_SUFI_Handler**. As a principle values specifically set are used as criteria for checking, values omitted are used as AnyOrOmit values. The resulting SUFI list is established by **o_SUFI_Handler** and can be retrieved in the data structure returned by the TSO. Details have to be defined in the TSO itself.

Tasks **o_SUFI_Handler** has to perform:

- Transfer the SUFIs received into the structure of SuperFields; this is the SUFI list structure existing today.
- If multiple occurrences of SUFI are found then use the **last** one to fill the SuperFields structure. The LIST SUFI is an exception: multiple SUFIs may be used to transfer the complete LIST information.
- Check for all parameters in SUFI_Params set to a specific expected value that one of the SUFIs using this value is present and that the value received matches the specific expected value.
- Check that if SUFIs are received for which an expected value of Any is specified, the SUFI is consistent if that SUFI is received.
- Check that if SUFIs are received for the presence of which no entry is specified in SUFI_Params, the SUFI is consistent.
- Check that sequence numbers are in the range between LB and UB if specific values are set.

Entries in **SUFI_Params**.

Element Name	Significance	Comment
LB	Lower bound of sequence number range	Lowest SN for checking SNs acknowledged
UB	Upper bound of sequence number range	Highest SN for checking SNs acknowledged
WSN_presence	Window Size SUFI present	To check the presence of the Window Size SUFI
MRW_presence	Move Receive Window SUFI present	To check the presence of the MRW SUFI
Nack1	SN of 1 st PDU negatively acknowledged	For the NackList to check SN to be negatively acknowledged
Nack2	SN of 2 nd PDU negatively acknowledged	For the NackList to check SN to be negatively acknowledged
Nack3	SN of 3 rd PDU negatively acknowledged	For the NackList to check SN to be negatively acknowledged

More entries may be required in the future if specific SUFI field values are to be checked. The concept allows to add more fields easily.

6.5.2.2 Void

6.6 SMS test method and architecture

6.6.1 SMS CS test method and architecture

The test method used for SMS CS tests is the same as the NAS test method, see clause 6.3, and the same ASPs, see clause 7.1.2.

6.6.2 SMS PS test method and architecture

The test method used for SMS PS tests is the same as the NAS test method, see clause 6.3, and the same ASPs, see clause 7.1.2.

6.6.3 SMS Cell broadcasting test method and architecture

The test method used for SMS CB tests is the same as the BMC test method, see clause 6.8, and the same ASPs, see clause 7.3.1.1.

6.7 MAC test method and architecture

6.7.1 Testing architecture

Figure 6.7.1 illustrates a typical realization of the MAC ATS.

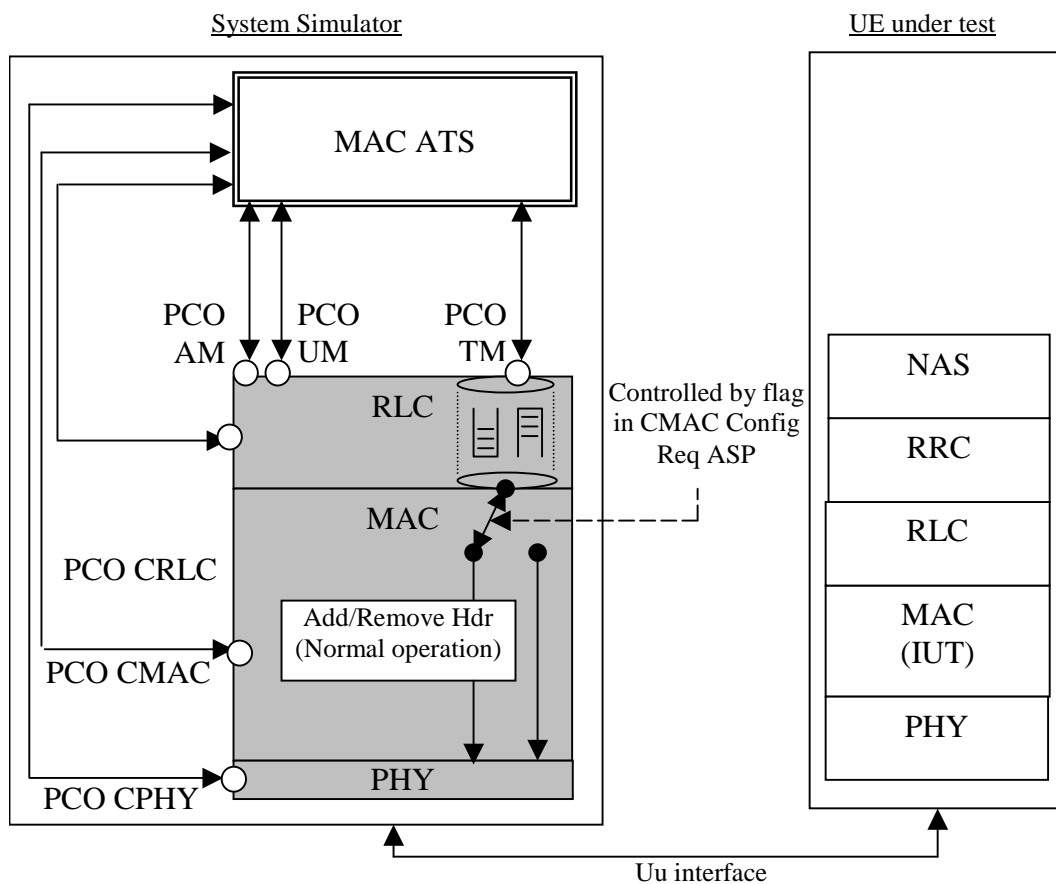

Figure 6.7.1: MAC ATS single party test method

6.7.2 Test method

The single party test method is used for MAC testing.

Separation of TTCN test cases from the configuration of the tester and initialization of the UE is achieved by using test steps. For each MAC test case, common test steps will be used to perform the configuration of the tester and the appropriate generic setup procedures as described in 3GPP TS 34.108 [3]. These test steps will make use of PCOs AM, UM, TM, CRLC, CMAC, and CPHY.

Three PCOs are provided at the top of the RLC emulation in the tester, one corresponding to each of the available RLC modes: acknowledged, unacknowledged, and transparent. Routing information for different radio bearers used at these PCOs will be provided in ASP parameters.

The queues shown in the RLC emulation in Figure 6.5.2.2 indicate that normal RLC transmit and receive buffering will be used to isolate the TTCN test suite from the real time issues involved if messages are sent directly to the MAC layer.

A flag is required within the CMAC Config Req to indicate that the SS MAC emulation must not add or remove any MAC header information, even if header fields should be present according to the configured channels. This flag shall allow control of the MAC header on a per logical channel basis. For example, it shall be possible to configure 4 DCCHs and a DTCH mapped to a DCH, such that the MAC will add / remove header information for the DCCHs, but not for the DTCH.

The MAC TTCN test cases make also use of the NAS TTCN test steps in order to bring UE to Idle state. The NAS test steps, which are called by the MAC test cases or steps, interface with the Dc PCO.

For MAC testing, the following RB Ids are used for the high priority NAS RB within the system simulator depending on the MAC configuration being simulated.

RB Id	Simulated configuration
-14	DCCH mapped to FACH
-15	DCCH mapped to DCH
-18	CCCH mapped to FACH

The SS decoder can use the RB Id to determine which MAC header fields are present, and create the appropriate abstract structure during the decode process. The SS decoder must understand enough of the MAC peer-to-peer protocol to determine which fields are present.

For example, the semantics of the UE Id Type field must be known to determine how many bits should be present in the UE Id field.

The MAC PDUs for MAC testing will always contain an AM RLC PDU (data or status) using 7 bit length indicators. See the RLC test method for further information on the SS decoder requirements for RLC PDUs.

Ciphering shall be disabled for all MAC tests.

6.7.2.1 Abnormal decoding situations

If the SS decoder cannot convert the received data into the supported structure, the SS shall terminate the test case immediately and indicate that a test case error has occurred.

6.7.2.2 MAC_es/e test method (Rel-6 or later)

MAC test method for MAC_es/e is depicted in the following figure. In the UE side the RLC entity is AM mode, in the SS the mode of RLC in downlink direction is TM, the AM mode functions are implemented in TTCN. In the uplink direction, the mapping between RB identity and logical channel identity is configured in the RLC entity, the RLC entity passes any data block received on the logical channel to the RB identified by `tsc_RB_DTCH_E_DCH_MAC`(value is -20), `tsc_RB_DTCH_E_DCH_MAC1`(-21), or `tsc_RB_DTCH_E_DCH_MAC2`(-22). Whenever a RLC pdu received through one of the specified RB identifiers, the TTCN shall generate a RLC ack for it and send it on the downlink direction.

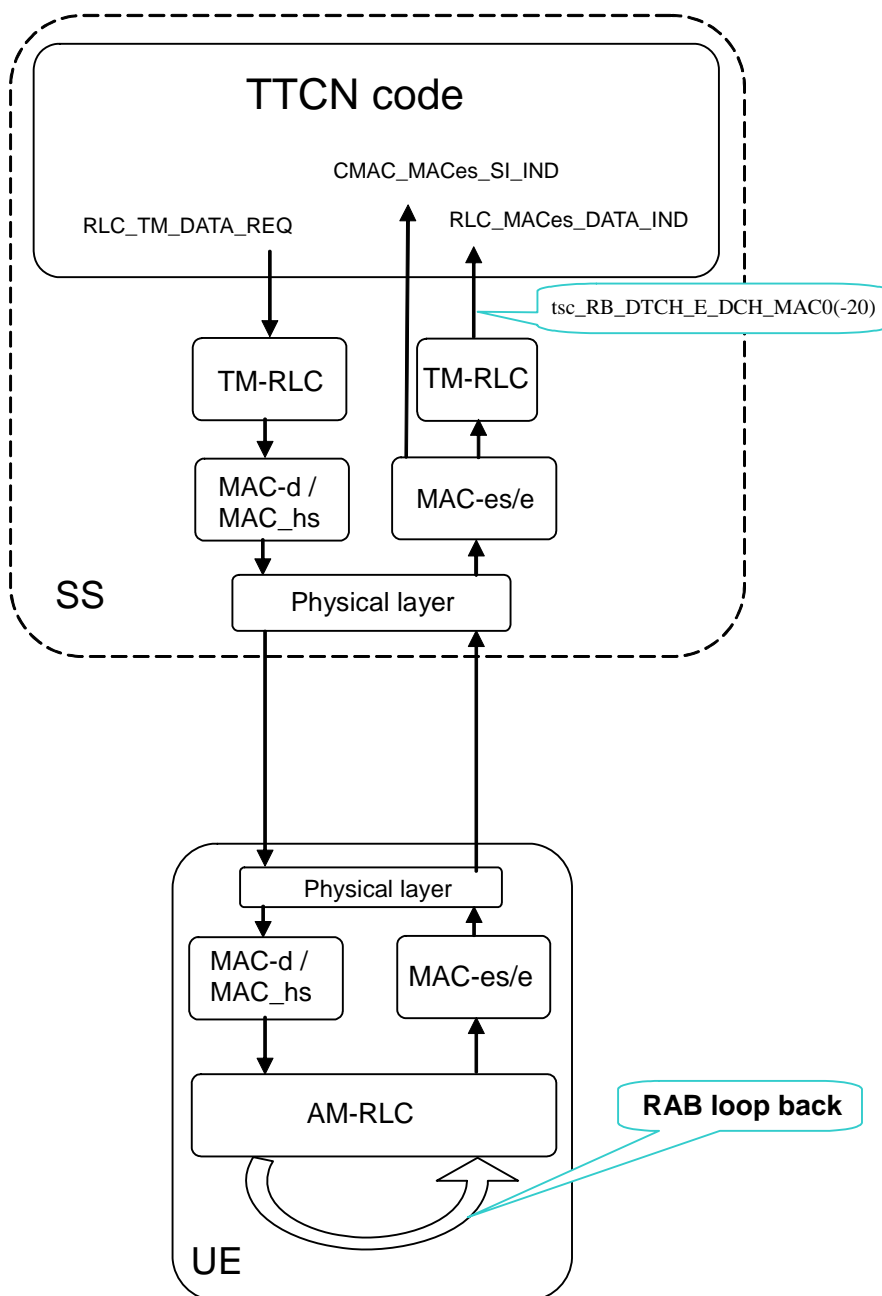

Figure 6.7.2.2: MAC_es/e testing model

6.7.2.3 MAC_is/i test method (Rel-8 or later)

MAC test method for MAC is/i is depicted in the following figure. In the UE side the RLC entity is AM or UM mode, in the SS the mode of RLC in downlink direction is TM, the AM or UM mode functions are implemented in TTCN. In the uplink direction, the mapping between RB identity and logical channel identity is configured in the RLC entity, the RLC entity passes any data block received on the logical channel to the RB identified by tsc_RB_DTCH_E_DCH_MAC(value is -20), tsc_RB_DTCH_E_DCH_MAC1(-21), or tsc_RB_DTCH_E_DCH_MAC2(-22). Whenever a RLC pdu received through one of the specified RB identifiers, the TTCN shall generate a RLC ack for it and send it on the downlink direction.

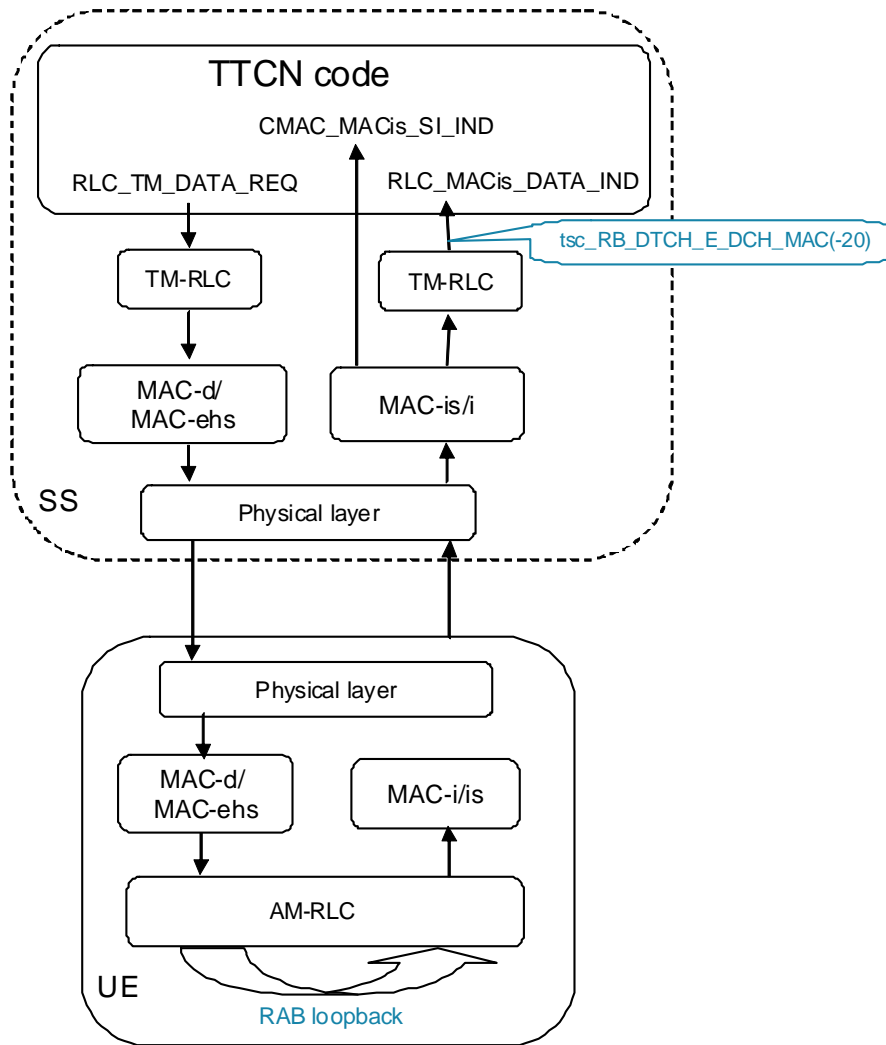

Figure 6.7.2.3: MAC_is/i testing model

6.8 BMC test method and architecture

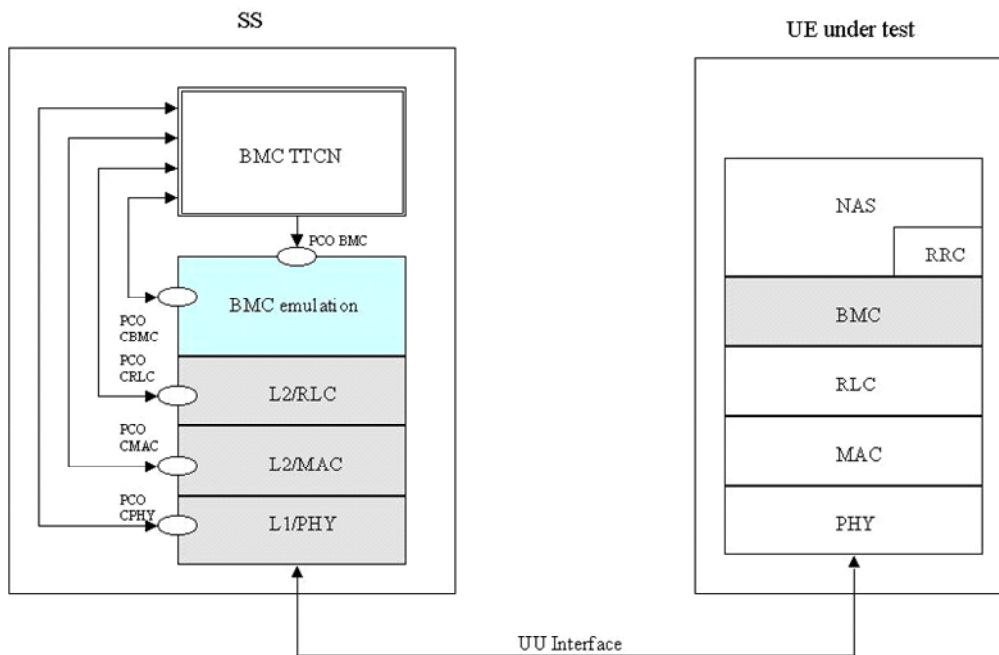

Figure 6.8: BMC testing architecture single party method

6.8.1 BMC test architecture

The single party test method is used for BMC testing, i.e. it does not exist an Upper Tester. BMC emulation is used as shown in Figure 6.8. The BMC emulation makes use of two PCOs. The CBMC PCO is defined, to pass configuration information for a BMC entity. The BMC PCO is defined for BMC message data transfer.

Separation of TTCN test cases from the configuration of the tester and initialization of the UE is achieved by using test steps. For BMC test cases, common test steps and newly defined test steps for BMC configuration will be used to perform the configuration of the tester and on UE side. These test steps make use of PCOs, CRLC, CMAC, and CPHY.

The UE shall be able to activate and deactivate a certain CB MessageID according CB data to be sent while testing.

BMC messages are sent in BMC message blocks on the CTCH. For sending BMC messages (BMC Scheduling Message (Level 2, DRX) and BMC CBS Message) a configuration in downlink direction shall be performed to map the CTCH (RB#30) onto the FACH - S-CCPCH.

6.8.2 BMC test method

For BMC testing, only PS Cell Broadcast Service as distributed BMC service is applied. CBS Messages and BMC Schedule Messages are only sent in downlink direction. No uplink is used for BMC testing. The BMC test data with necessary CBS information shall be given by PIXIT parameter with a description of the indication on the display.

There are two level of BMC scheduling, Level 1 for CTCH configuration and Level 2 for DRX. The BMC scheduling information is conveyed to both BMC and MAC layer.

Level 1 scheduling is used to configure the CTCH on the S-CCPCH. For BMC testing (FDD), the Level 1 scheduling parameter M_{TTI} contains one radio frame in the TTI of the FACH used for CTCH. Therefore, only Level 1 scheduling information N (period of CTCH allocation on S-CCPCH) and K (CBS frame offset to synchronize to the SFN cycle (0 to 4 095 frames per cycle)) are necessary to configure the CTCH onto the S-CCPCH.

The Level 1 scheduling is done in the SS MAC layer, therefore this information is given by using the primitive "CMAC_BMCscheduling_REQ" to inform the MAC on SS side about K and N. The Level 1 scheduling information, K and N, is broadcast as system information in SIB 5 and SIB 6. After having performed the CTCH configuration as Level 1 scheduling, the SS is configured to send BMC messages and the UE has to listen to each CTCH for a BMC message.

Segmentation of BMC messages is performed by RLC in UM according to the payload size on RB#30 (152 bits).

If only one CB data as BMC CBS message is sent and repeated for a BMC test case, Level 1 scheduling is adequate, i.e. no BMC Scheduling Message (Level 2) is needed. Then, no level 2 scheduling information are included in the "CMAC_BMCscheduling_REQ" primitive. If more then one BMC CBS message are transmitted and repeated or if BMC Scheduling Messages are transmitted, BMC scheduling Level 2 message shall be performed. Level 2 scheduling is used to predict the sent event of the next BMC message blocks and the BS index contents.

BMC scheduling Level 2 predicts exactly, which information is contained on a certain CTCH block set with an aligned Block Set index number and how many spare CTCH blocks are given as offset, before the next BMC message block will be sent. Figure 6.8.2.1 shows an example, how the messages flow shall be done for BMC scheduling Level 2.

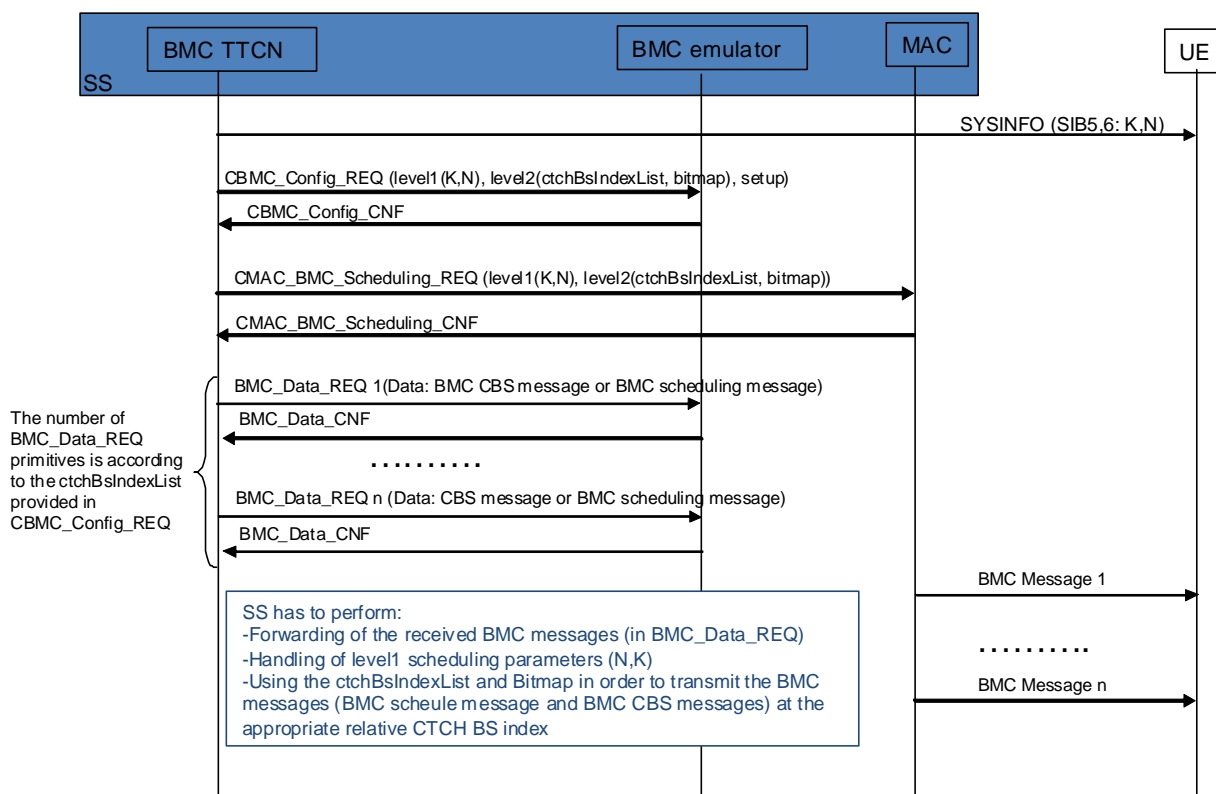

Figure 6.8.2.1: BMC Scheduling

The BMC test method makes use of the primitive: "BMC_Data_REQ" to transmit the BMC Messages to RLC. If BMC Scheduling Level 2 is used, it includes BMC CBS PDUs or BMC Schedule PDUs, created by the BMC TTCN and forwarded to the BMC emulation. The transmission of BMC PDU is confirmed through the primitive BMC_Data_CNF.

According to the K and N value, the MAC layer at SS side determines the CTCH blocks for the BMC use. The CTCH blocks are indexed ($i = 1 \dots 256$).

If BMC DRX is needed, the BMC scheduling Level 2 information indicates the occupancy/spare of the available CTCH blocks by using a DRX_Selection_Bitmap and the list of CTCH BS index offsets. In the bitmap each bit, set to '1', corresponds to an actually available CTCH block belonging to the DRX period for the SS transmission. The all consecutive occupied CTCH blocks constitutes a BMC DRX period, whilst the consecutive spared blocks indicate the DRX offset as spare CTCH slot. Following the DRX_Selection_Bitmap, the segmented BMC messages are transmitted. Each BMC PDU is transmitted in a BMC_Data_REQ primitive in the order of expected transmission. The list of CTCH BS index offset indicating the offset relative to the previous message transmitted is included in the CMAC_BMC_Scheduling_REQ. If any, the retransmission is handled by the BMC TTCN.

The figure 6.8.2.2 shows an example of DRX level2 scheduling when sending 4 BMC messages (either BMC schedule or CBS BMC data messages) with the CTCH BS Index Offset List={0,6,1,11} and the Bitmap='107002'0.

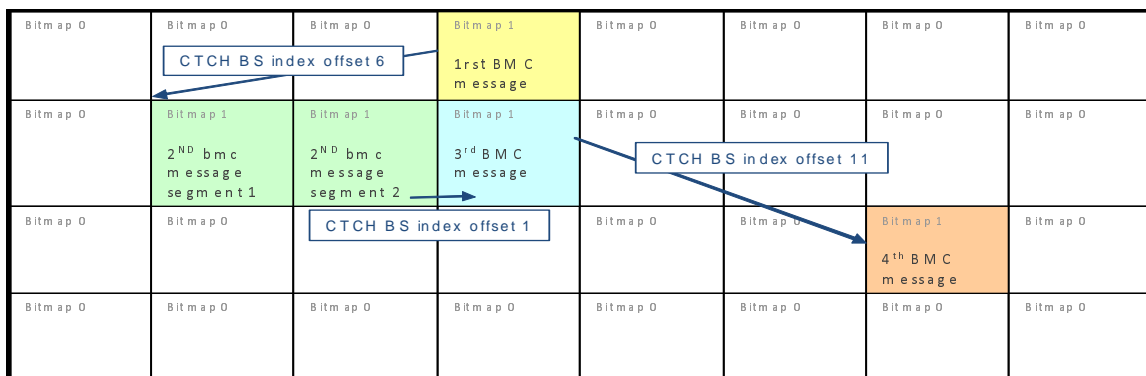

Figure 6.8.2.2: Example of BMC DRX scheduling: CTCH BS index offset list and Bitmap handling

6.9 PDCP test

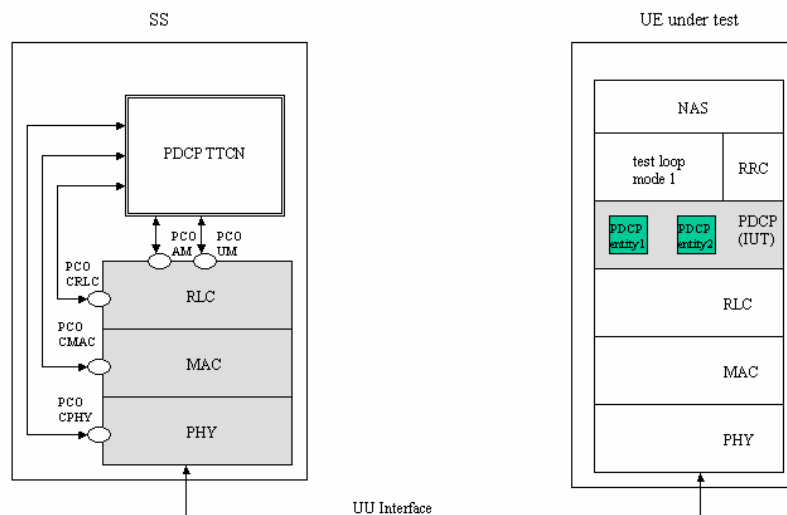

Figure 6.9: PDCP testing architecture 1: single party test method, with test loop mode 1

6.9.1 PDCP test architecture

The single party test method is used for PDCP testing. All PDCP tests that require uplink data will make use of the UE test loop mode 1 defined in 3GPP TS 34.109 [4]. Test Loop mode 1 is only available in the user plane, so all PDCP tests

will be performed in the user plane, using the same logical channels mapped to transport channels as defined in RLC test cases, except for test case, clause 7.3.2.2.4, where a configuration of combined radio bearers used only for this test case is defined.

Separation of TTCN test cases from the configuration of the tester and initialization of the UE is achieved by using test steps. For PDCP test cases, common test steps and newly defined test steps for PDCP configuration will be used to perform the configuration of the tester and the appropriate generic setup procedures as described in 3GPP TS 34.108 [3] and in clause 7.3 of 3GPP TS 34.123-1 [1]. These test steps will make use of PCOs RLC AM, RLC UM, CRLC, CMAC, and CPHY.

The PDCP TTCN test cases make also use of the NAS TTCN test steps in order to setup a PS session.

For PDCP testing, the IP Header Compression protocol as described in RFC 2507 [30] is used as optimization method. The IP header compression and decompression mechanisms as described in RFC 2507 [30] is not part of PDCP TTCN. PDCP testing make use of uncompressed, compressed and decompressed TCP/IP header packets of a certain packet stream and uncompressed, compressed and decompressed UDP/IP header packets of a certain generation. This parameters are given as test parameter (PIXIT information).

PDCP testing includes transmission/reception of compressed/decompressed IP header packets, PDCP sequence numbering while lossless SRNS relocation and PID assignment rules as well as PDCP configuration tests as described in 3GPP TS 25.323 [19]. It does not test optimization specific protocol behaviour as error recovery and packet reordering as described in RFC 2507 [30].

6.9.2 PDCP test method

For PDCP testing, the RB test mode is used with test loop mode 1. After establishing a PS session with RB in RLC UM or/and AM, the UE is configured to support a negotiated PDCP configuration. UDP/IP header packets are used as Non-TCP/IP header packets as PDCP test data.

There are different input parameter as PIXIT values necessary for PDCP testing.

For TCP/IP header packets, uncompressed TCP/IP header packets shall be defined as PIXIT input parameter. In addition, there are the corresponding RFC 2507 [30] FULL_HEADER packet, COMPRESSED_TCP packet and COMPRESSED_TCP_NONDELTA packet given for each TCP/IP header packet as PIXIT information.

For UDP/IP header packets, uncompressed UDP/IP header packets shall be defined as PIXIT input parameter. In addition, there are the corresponding RFC 2507 [30] FULL_HEADER packet and COMPRESSED_NON_TCP packet given for each UDP/IP header packet as PIXIT information.

To check the use of certain PID values assigned to IP compressed header types, a given IP header packet (PIXIT) will be sent to the UE. The UE shall return a appropriate valid IP header packet type, which corresponds to the previous sent IP header packet. The usage of valid compressed/uncompressed IP header packets shall be checked by comparing the given PIXIT IP header packet types for each IP header packet previously sent.

The IP header packet order as described in RFC 2507 [30] shall be applied within a test case.

If for example an TCP/IP header packet of type "COMPRESSED_TCP" shall be sent, the TTCN uses the given TCP/IP header packet (PIXIT) for transmission to the UE. The UE shall decompress the received packets appropriate, afterwards it will be returned by the loop back entity and it shall be sent by applying IP header compression rules as described in RFC 2507 [30] and as configured. Then, the SS receives returned IP header packets and compares it with all valid IP header packets given as PIXIT parameter corresponding to the previously sent IP header packet. It is checked, whether or not the IP header packet with assigned PID is valid and a configured PDCP PDU where used for transmission. In this way, it is checked, that the UE performs IP header compression as configured and is able to assign the correct PID values.

6.9.2.1 CS voice over HSPA

For PDCP CS voice over HSPA tests, the RB test mode used is test loop mode 1 with loopback of PDCP SDUs (as per 3GPP TS 34.109 [4], clause 5.3.2.6.1). The CS domain voice RAB is associated with one RB and one PDCP entity. The two RLC entities (DL/UL) are configured in UM with SN_delivery mode. The PDCP entity serving CS service does not use header compression, therefore no ROHC is configured.

6.9.2.2 Network initiated secondary PDP context

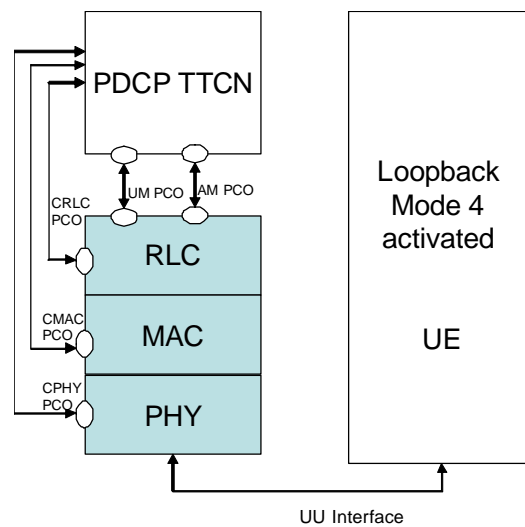

Figure 6.9.2.2: Network initiated secondary PDP testing architecture

For the network initiated secondary PDP context tests using data loopback, the UE test loop mode 4 is applied with loopback of IP PDUs (as per 3GPP TS 34.109 [4], clause 5.3.2.8.1). No header compression is tested, therefore no ROHC is configured.

6.10 Multi-RAT Handover Test Model

6.10.1 Overview

The test model is shown in Figure 6.10.2.9.6. The SS in the model consists of UTRAN emulation part and GERAN emulation part, GERAN emulation part includes protocol emulation modules for GSM CS services and protocol emulation modules for GPRS service. Protocol stack L1 (GERAN), L2 is for GSM CS service function emulation, protocol stack L1, RLC/MAC, LLC, SNDCP is for GPRS service function emulation. SNDCP emulation model and relevant PCO's can be removed if "traffic channel gets through" is not tested.

L1 (GERAN) provides necessary physical layer functionality for both GSM and GPRS. A control PCO and a set of ASP's are defined for configuring and controlling its protocol behaviour required in the test cases. L1 (GERAN) provides services to L2 and RLC/MAC emulation modules, the interfaces between them are not specified in this test model, it is implementation dependent and shall follow the relevant GSM and GPRS specifications.

L2 emulates necessary GSM L2 protocol functionality used in testing. A data PCO and a set of ASP's are defined for this module and used for transmitting and receiving layer 3 signalling messages and use data. The definition of the PCO and these ASP's are based on the logical channel concept of GSM specification. A control PCO and related ASP's are also defined for L2, they are used to introduce abnormal layer 2 behaviour required by the test purposes.

RLC/MAC is emulation module for GPRS Radio Link Control/Medium Access Control protocol. Two PCO's and related ASP's are defined for the module. Control PCO is used to set TBF and assign physical resources to it, actual physical resources (packet channels) are created by L1 (GERAN) ASP's beforehand. Data PCO is for transmitting and receiving RLC control messages (RLC control block). Before any RLC data or control block is sent (or received) a proper TBF shall be configured. In addition RLC/MAC module provides service to LLC emulation module, the interface between them is determined by implementation and shall be compliant with relevant core specification.

LLC performs GPRS Logical Link Control protocol emulation. Its data PCO and ASP's are used for exchange GMM signalling messages between TTCN and the UE under test. The current defined ASP's on control PCO are subset of the primitives defined in core specification, they are used to assign, un-assign TLLI and ciphering parameters, or get status report.

6.10.2 ASP function description

6.10.2.1 Identities

- Within the SS, a cell is identified by cell identifier (cellId), which is of TTCN type CellId (INTEGER).
- Within a cell, a basic physical channel is identified by physical channel identifier (physicalChId), which is of TTCN type PhysicalChId (INTEGER). In multislot configuration a basic physical channel is identified by physical channel identifier (physicalChId) and timeslot, which is of TTCN type TN (INTEGER).
- Within a physical channel, logical channel is identified by logical channel type (g_LogicChType), which is of TTCN type G_LogicChType (INTEGER). When multiple logical channels of same type are carried by (mapped to) the same basic physical channel, they are differentiated by sub-channel number (subChannel), which is of TTCN type SubChannelNumber (INTEGER).
- At the top boundary of L2 emulation module two service access points (SAP) are available, they are identified by SAPI. SAPI=3 is used for short message service; SAPI=0 is used for L3 signalling messages and user data.

EXAMPLE: If G_L2_DATA_REQ ASP has the following parameter setting:

- cellId = tsc_CellA;
- sAPI = tsc_SAPI_0;
- physicalChId = tsc_PhyCh0;
- g_LogicChType = tsc_SDCCH4; and
- subChannel = tsc_SubChannel1;

it sends PDU on the SDCCH4(1) logical channel which is carried by the physical channel tsc_PhyCh0 in cell A.

6.10.2.2 Cell configuration and control

In GSM each base station has a base station identity code BSIC, it consists of network colour code and base station colour code (NCC + BCC). BSIC is continuously broadcasted on the SCH channel, and it shall be used as the training sequence code for broadcast and common control channels.

In the test model the function of G_CL1_CreateCell_REQ ASP is to create a cell and pass parameter BSIC to it. This ASP establishes the cell identifier which shall be used in the ASP's related to this cell.

This is the first step to configure L1 (GERAN) emulation module of the SS.

6.10.2.3 L1 (GERAN) configuration and control

Configuration and control functions identified for L1 (GERAN) of a cell are:

- creation of basic physical channels;
- creation of multislot configuration;
- release of basic physical channel;
- modifications of channel mode, ciphering parameters and transmission power level;
- reporting of L1 header of SACCH channel;
- pickup a frame in near future, which can carry L3 message.

6.10.2.3.1 Basic physical channel configuration

A basic physical channel uses a combination of frequency and time domain resources, therefore, the definition of a particular basic physical channel consists of a description in the frequency domain and a description in the time domain. In time domain the resource is called Time Slot, there are 8 time slots in one frame, numbered from 0 to 7. In frequency domain a basic physical channel may use only one frequency or may use multiple frequencies in frequency hopping.

Basic physical channel carrying FCCH + SCH + BCCH + CCCH (PCH, AGCH, RACH) or FCCH + SCH + BCCH + CCCH + SDCCH4 logical channels shall be located in time slot 0, and uses single frequency (non-hopping). The basic physical channel carrying additional BCCH, CCCH (PCH, AGCH, RACH) logical channels shall be located in time slot 2, 4, 6 and uses the same single frequency as the frequency used by the physical channel carrying FCCH, SCH.

GSM specification defines 24 permitted combinations of different logical channels, which can be mapped on to a basic physical channel. The combination defines which logical channels are carried by a basic physical channel, and it is also an indication of which modulation (GMSK or 8PSK) is used for the basic physical channel.

Training Sequence Code (TSC) is another parameter needed by physical channel. Common control and broadcast channel have to use BCC as its TSC.

Dedicated control channel and dedicated traffic channel need more parameters to configure. Parameter "Channel Mode" is needed to specify channel coding (therefore the user data rate). Ciphering related parameters are required to define the ciphering behaviour of the channel.

Common control channels need parameters to configure where in the 51-multiframe paging and access grant blocks are located.

Transmission power level is provided as per physical channel parameter, power level of each physical channel can be controlled independently.

The function of ASP_G_CL1_CreateBasicPhyCh_REQ is to create a basic physical channel which has the required property defined by all the parameters mentioned above.

In the process of L1 (GERAN) configuration, calling the ASP is the next step after calling G_CL1_CreateCell_REQ.

6.10.2.3.2 Multislot configuration for circuit or packet switched channels

Multislot configuration for circuit switched connection consists of multiple circuit switched traffic channels, in L1 point of view these traffic channels are independent basic physical channels with the same frequency parameters (ARFCN or MA, MAIO, HSN) and the same training sequence code but located in different time slots, one of the basic physical channels is the main channel of the configuration carrying the main signalling (FACCH, SACCH, IACCH) for the configuration. The main channel shall be bi-directional channel and with channelCombination TCH/F+FACCH/F+SACCH/M or E-TCH/F+E-IACCH/F+E-FACCH/F+E-SACCH/M. When transmitting user data (not signalling message) stream is divided into substreams, each substream is transmitted independently on a channel in the configuration. At the receiving side all substreams are combined back to user stream.

According to the test model creation of a multislot configuration for circuit switched connection needs two ASP calls. Firstly, G_L1_CreatedBasicPhyCh_REQ is called to establish the main channel, then G_L1_CreateMultiSlotConfig_REQ is called to allocate more timeslots to the channel established by the previous ASP. A substream of a multislot configuration is identified with the physicalChId and timeslot.

Multislot configuration for packet switched connection consists of multiple PDCHs which can carry PDTCH/Us or PDTCH/Ds. All these PDCHs use the same frequency parameters (ARFCN or MA, MAIO, HSN) and the same training sequence code, but are located on different timeslots.

Similarly, a multislot configuration for packet switched connection is created with two ASP calls. First G_L1_CreatedBasicPhyCh_REQ is called to establish the first PDCH channel, then G_L1_CreateMultiSlotConfig_REQ is called to allocate more timeslots to the channel established by the previous ASP. All data ASP on packet data channel use physicalChId and timeslot to address the physical channels.

6.10.2.3.3 Frame in the near future

ASP `G_CL1_ComingFN_REQ` is defined to request L1 (GERAN) return the reduced frame number (FN modulo 42432) which is far enough in the future from current frame number and is able to carry L3 message on the specified channel. "far enough" means that there is enough time left for TTCN to prepare a L3 message to be sent on that frame. When calculating `startingTime`, this ASP could be useful. The starting time usually is set to a frame number in a time distance from current frame number. TTCN writer can use `G_CL1_ComingFN_REQ` to get a frame number in the future then add a certain number of frames as time distance to it and use the result as the value for `startingTime`.

6.10.2.3.4 L1 header

The layer 1 header of SACCH from UE to network carries information of timing advance and UE uplink transmission power level, verifying L1 header contents is required in some test cases, ASP `G_CL1_L1Header_REQ` and `G_CL1_L1Header_CNF` are defined for fulfilling this requirement.

6.10.2.4 L2 configuration and control

For normal operation there is no parameter configurable in L2. Some abnormal L2 behaviours are required in test cases. In the test model two ASP's are currently defined to introduce abnormal L2 behaviour. When creating a dedicated channel the initial SACCH header is set to the values in `powerLevel` and `timingAdvance` fields of `DedCH_Info`.

6.10.2.4.1 Don't response to some handover access bursts

In non-synchronized handover procedure UE/MS, having received handover command, sends handover access bursts on the target channel repeatedly till it receives `PHYSICAL INFORMATION` message from network or T3124 times out. Normally network replies `PHYSICAL INFORMATION` as soon as it receives handover access burst. Some test cases require that the SS ignores several incoming handover access bursts then responses to the one that follows. ASP `G_CL2_HoldPhyInfo_REQ` is defined for fulfilling this requirement. It is used together with and before a data ASP sending `PHYSICAL INFORMATION` message. When SS receives the `G_CL2_HoldPhyInfo_REQ`, it does not transmit the `PHYSICAL INFORMATION` message until n handover access bursts have been received.

6.10.2.4.2 No UA reply to SABM

GSM L2 protocol is adapted from LAPD (HDLC subset). The multiframe operation mode is established through exchange of supervisory frame SABM and unnumbered frame UA between peer entities, and SABM is always sent by UE/MS, UA is always sent by network. UE/MS will repeatedly transmit SABM till it receives UA or retransmission counter is reached. Some handover test cases require that the SS does not response to the incoming SABM, so handover fails. `G_CL2_NoUAforSABM_REQ` is used for such purpose, it commands the SS not to send UA response to the UE when SABM is received.

6.10.2.5 System Information sending

There are 17 different `SYSTEM INFORMATION` messages on BCCH and 4 different `SYSTEM INFORMATION` messages on SACCH defined for circuit switched services in GSM specification. In a particular test case not all of them are required. `SYSTEM INFORMATION` messages on BCCH shall be broadcasted periodically by the SS, `SYSTEM INFORMATION TYPE 5, 6` and optionally `5bis` and `5ter` messages shall be sent on SACCH by the SS when nothing else has to be sent on that channel.

`G_L2_SYSINFO_REQ` is defined to deliver a `SYSTEM INFORMATION` message and its type `SysInfoType` to the SS, SS shall store the `SYSTEM INFORMATION` and transmit it periodically according to the scheduling rules specified in 3GPP TS 45.002 [31], clause 6.3.1.3. `SYSTEM INFORMATION` message newly delivered shall override the same type `SYSTEM INFORMATION` message previously stored in the SS.

`SYSTEM INFORMATION` message type 18, 19, 20 are scheduled by scheduling information in `SYSTEM INFORMATION` type 9. ASP for scheduling these messages has not been defined yet because these messages are not required in current test cases.

6.10.2.6 Paging

Paging message for a particular UE/MS shall be sent on the right CCCH_GROUP and PAGING_GROUP which are determined by IMSI of the UE/MS and other parameters. In the test model TTCN code is responsible to calculate the value of CCCH_GROUP and the value of PAGING_GROUP.

TTCN selects the right channel according to the value of CCCH_GROUP, then PAGING REQUEST message and the value of PAGING_GROUP are passed to the SS by using:

- ASP G_L2_Paging_REQ in case of UE/MS in idle mode or the UE/MS not supporting SPLIT_PG_CYCLE on CCCH when it is in GPRS attached mode.

The SS shall determine the position where the paging block is located using the value PAGING_GROUP and other CCCH parameters configured by G_CL1_CreateBasicPhyCH_REQ, then send the PAGING REQUEST message according the parameter pagingMode in the ASP:

- send the message on the paging block determined by PAGING_GROUP if pagingMode = "normal paging";
- send the message on the paging block determined by PAGING_GROUP and the "next but one" position on the PCH if pagingMode = "extended paging";
- send the message on all paging blocks if pagingMode = "paging reorganization".

6.10.2.7 Generic procedures for GPRS signalling

Two channel combinations are applied to configure a GERAN cell for the GPRS signalling:

- The channel combinations 5 + 13, (FCCH + SCH + BCCH + CCCH + SDCCH/4(0..3) + SACCH/C4(0..3)) + (PDTCH/F+PACCH/F+PTCCH/F), are considered as default at the interRAT tests and GERAN to UTRAN Inter-RAT test cases in clause 42.4.7 of TS 51.010-1.

The following generic procedures show the usages of GPRS ASP's for the GPRS generic attach procedures, the generic cell change order within a TBF and the GSM ciphering procedure.

6.10.2.7.1 GPRS generic attach procedures and ciphering mode control

6.10.2.7.1.1 GPRS attach procedure in channel combinations 5 and 13

Direction	ASP	message	Comments
SS	G_CL1_CreateCell_REQ		Create the cell
SS	G_CL1_CreateBasicPhyCh_REQ		Create the physical channel combination 5 for FCCH+SCH+BCCH+CCCH+SDCCH/4(0..3)+SACCH/C4(0..3)
SS	G_CL1_CreateBasicPhyCh_REQ		Create the physical channel combination 13 for PDTCH/F+PACCH/F+PTCCH/F
SS -> MS	G_L2_SYSINFO_REQ	SYSTEM INFORMATION TYPE1, SYSTEM INFORMATION TYPE2, SYSTEM INFORMATION TYPE2quater, SYSTEM INFORMATION TYPE3, SYSTEM INFORMATION TYPE4, SYSTEM INFORMATION TYPE13	Broadcast system information messages : SI 1-4; SI 13
SS	G_CRLC_CreateRLC_MAC_REQ		Create RLC/MAC emulation entity
SS	G_CLLC_CreateLLE_REQ		Create LLC emulation entity
SS	MMI_CmdReq		Power on the UE/MS
MS-> SS	G_L2_ACCESS_IND	CHANNEL REQUEST	RACH, TBF establishment with Establishment Cause = one phase packet access.

Direction	ASP	message	Comments
SS	G_CRLC_UL_TBF_Config_REQ		Set up uplink TBF in RLC/MAC entity in SS, this TBF is corresponding to what indicated in IMMEDIATE ASSIGNMENT.
SS -> MS	G_L2_UNITDATA_REQ	IMMEDIATE ASSIGNMENT	Assign the uplink resources (uplink TBF) to MS. Polling bit and Starting Time are set
MS -> SS	G_RLC_ControlMsg_IND	PACKET CONTROL ACKNOWLEDGEMENT	
SS	G_CLLC_Assign_REQ		Assign TLLI, ciphering key and algorithm. The ciphering algorithm = "ciphering not used". The value of ciphering key shall be the one generated in the following authentication procedure.
MS -> SS	G_LLC_UNITDATA_IND	ATTACH REQUEST	If there is no user data traffic in acknowledged mode before authentication procedure the ciphering algorithm may be set to one of the GPRS ciphering algorithm, and the late G_CLLC_Assign_REQ shall be not used.
SS	G_CRLC_DL_TBF_Config_REQ		MS uses the assigned uplink TBF to transmit the L3 message to SS, the SS manages the operation of the TBF without TTCN intervention and releases the TBF automatically according the countdown procedure. The SS reassembles the received data blocks into the L3 message and passes it to the LLC DATA PCO G_LLC.
SS -> MS	G_L2_Paging_REQ	IMMEDIATE ASSIGNMENT	Set up downlink TBF in RLC/MAC entity in SS
SS -> MS	G_LLC_UNITDATA_REQ	AUTHENTICATION AND CIPHERING REQUEST	Downlink TBF establishment
MS-> SS	G_L2_ACCESS_IND	CHANNEL REQUEST	RACH, TBF establishment with Establishment Cause = one phase packet access.
SS	G_CRLC_UL_TBF_Config_REQ		Set up uplink TBF in RLC/MAC entity in SS, this TBF is corresponding to what indicated in IMMEDIATE ASSIGNMENT.
SS -> MS	G_L2_UNITDATA_REQ	IMMEDIATE ASSIGNMENT	Assign the uplink resources (uplink TBF) to MS. Polling bit and Starting Time are set
MS -> SS	G_RLC_ControlMsg_IND	PACKET CONTROL ACKNOWLEDGEMENT	
SS	G_CLLC_Assign_REQ		Assign TLLI, if changed
MS -> SS	G_LLC_UNITDATA_IND	AUTHENTICATION AND CIPHERING RESPONSE	
SS	G_CLLC_Assign_REQ		Keep TLLI unchanged, ciphering algorithm = one of the GPRS ciphering algorithm. The value of ciphering key shall be the one generated in the authentication procedure.
SS	G_CRLC_DL_TBF_Config_REQ		If no user data traffic in acknowledged mode before authentication procedure, this ASP is not needed.
SS -> MS	G_L2_Paging_REQ	IMMEDIATE ASSIGNMENT	Set up downlink TBF in RLC/MAC entity in SS
SS -> MS	G_L2_Paging_REQ	IMMEDIATE ASSIGNMENT	Downlink TBF establishment

Direction	ASP	message	Comments
SS -> MS	G_LLC_UNITDATA_REQ	ATTACH ACCEPT	SS uses the established downlink TBF to transmit the L3 message to MS, the SS manages the operation of the TBF without TTCN intervention and releases the TBF automatically after all data blocks of the L3 message are transmitted
MS-> SS	G_L2_ACCESS_IND	CHANNEL REQUEST	RACH, TBF establishment with Establishment Cause = one phase packet access.
SS	G_CRLC_UL_TBF_Config_REQ		Set up uplink TBF in RLC/MAC entity in SS
SS -> MS	G_L2_UNITDATA_REQ	IMMEDIATE ASSIGNMENT	Assign the uplink resources (uplink TBF) to MS. Polling bit and Starting Time are set
MS -> SS	G_RLC_ControlMsg_IND	PACKET CONTROL ACKNOWLEDGEMENT	
SS	G_CLLC_Assign_REQ		Assign new TLLI
MS -> SS	G_LLC_UNITDATA_IND	ATTACH COMPLETE	MS uses the assigned uplink TBF to transmit the L3 message to SS, the SS manages the operation of the TBF without TTCN intervention and releases the TBF automatically according to the countdown procedure
SS	G_CRLC_DeleteRLC_MAC_REQ		Release resources in the SS for RLC/MAC emulation entity
SS	G_CLLC_DeleteLLE_REQ		Release resources in the SS for LLC emulation entity
SS	G_CL1_DeleteChannel_REQ		Release SS resources of channel combination 13
SS	G_CL1_DeleteChannel_REQ		Release SS resources of channel combination 5
SS	G_CL1_DeleteCell_REQ		

6.10.2.7.1.2 Void

6.10.2.7.2 Cell change order within a TBF

6.10.2.7.2.1 Cell change order procedure in channel combinations 5 and 13

Direction	ASP	message	Comments
SS	G_CL1_CreateCell_REQ		
SS	G_CL1_CreateBasicPhyCh_REQ		Create the physical channel combination 5 for FCCH+SCH+BCCH+CCCH+SDCC H/4(0..3)+SACCH/C4(0..3)
SS	G_CL1_CreateBasicPhyCh_REQ		Create the physical channel combination 13 for PDTCH/F+PACCH/F+PTCCH/F
SS -> MS	G_L2_SYSINFO_REQ	SYSTEM INFORMATION TYPE1, SYSTEM INFORMATION TYPE2, SYSTEM INFORMATION TYPE2quarter, SYSTEM INFORMATION TYPE3, SYSTEM INFORMATION TYPE4, SYSTEM INFORMATION TYPE13	Broadcast system information messages: SI 1~4; SI 13
SS	G_CRLC_CreateRLC_MAC_REQ		Create RLC/MAC emulation entity
SS	G_CLLC_CreateLLE_REQ		Create LLC emulation entity
SS	G_CLLC_Assign_REQ		Assign TLLI, ciphering key and algorithm

Direction	ASP	message	Comments
MS			MS is GPRS attached, PDP context activated, then trigger MS to send two SNDCP PDU on LLC SAPI 3, each with 500 bytes user data.
MS-> SS	G_L2_ACCESS_IND	CHANNEL REQUEST	RACH, TBF establishment with Establishment Cause = one phase packet access.
SS	G_CRLC_UL_TBF_Config_REQ		Set up uplink TBF in RLC/MAC entity in SS, this TBF is corresponding to what indicated in the next IMMEDIATE ASSIGNMENT. The USFRate is set to 5 USF per second.
SS -> MS	G_L2_UNITDATA_REQ	IMMEDIATE ASSIGNMENT	Assign the uplink resources (uplink TBF) to MS
MS -> SS	G_LLC_UNITDATA_IND	User data on SAPI 3, the first SNDCP PDU	The TBF shall not be in countdown process
SS -> MS	G_RLC_ControlMsg_REQ	PACKET MEASUREMENT ORDER	This is within the TBF established above, which is in the process handling the second SNDCP PDU REPORT_TYPE = 1
MS -> SS	G_RLC_ControlMsg_IND	PACKET MEASUREMENT REPORT	MS sends the PACKET MEASUREMENT REPORT
SS -> MS	G_RLC_ControlMsg_REQ	PACKET CELL CHANGE ORDER	This is within the TBF established above what follows are in UTRAN cell, not present here

6.10.2.7.2.2 Void

6.10.2.8 Generic configuration procedure for GSM ciphering mode control

Direction	ASP	message	Comments
	...		Other necessary configuration ASP's
SS	G_CL1_CreateBasicPhyCh_REQ		Create a dedicated physical channel, e.g. combination 1 with ciphering not started: This ASP download Kc and ciphering algorithm to the SS with startingCiph = 0 in cipherMode. If there is no authentication procedure before CIPHERING MODE COMMAND, the value of Kc in this ASP shall be the one generated in previous authentication procedure, otherwise the value of Kc shall be the one generated by forthcoming authentication procedure.
	...		Any other signalling message sending/receiving or configuration ASP's
SS	G_CL1_CipheringControl_REQ		rcvCipherMode = '1', the SS starts ciphering on receiving
SS	G_CL1_CipheringControl_CNF		
SS -> MS	G_L2_DATA_REQ	CIPHERING MODE COMMAND	Sent without ciphering
SS			Before this point both transmitting and receiving in the SS are not ciphered.
MS -> SS	G_L2_DATA_IND	CIPHERING MODE COMPLETE	After receiving this message the SS shall start ciphering on transmitting, The CIPHERING MODE COMPLETE is ciphered Any signalling message or user data sending/receiving in ciphered mode
	...		

6.10.2.9 L/H bits convention and bit padding in DL

6.10.2.9.1 GERAN DL RLC/MAC message bit padding

The length of a GPRS RLC/MAC control messages is an integer number of RLC/MAC control blocks. Padding bits are necessary to fill the message up to the desired length. The padding bits may be the 'null' string. Otherwise, the padding bits starts with bit '0', followed by "spare padding". The padding sequence used for "spare padding" in the present document, is a repetition of octet '00101011', starting on an octet boundary.

< padding bits > ::= { null | 0 < spare padding >

"<spare padding>" ::= <spare L> { null | < spare padding > }

In the TTCN a specific encoding variation - encoding rule 1 - is defined according to the rules described above. This shall be used in the definition of the message itself. No 'padding bits' field will be defined in the TTCN. The implementation shall ensure that after encoding the message contents defined in the TTCN, the remainder of the message shall be filled with 'padding bits'.

6.10.2.9.2 GSM DL message spare padding

A number of GPRS information elements are defined in the rest octets of certain GSM DL messages, for instance, IA Rest Octets, SI 2quater Rest Octets, SI 3 Rest Octets, SI 4 Rest Octets, SI 13 Rest Octets, etc. These rest octets were filled in a repetition of bit padding '00101011' or '2B'O, starting on an octet boundary to a certain length.

In the TTCN, a second encoding variation - encoding rule 2 - shall be used in the definition of the message itself, which shall be of a fixed length (always 23 octets). No "spare padding" field will be defined in the TTCN. The implementation shall ensure that after encoding the message contents defined in the TTCN, the remainder of the message, up to the defined fixed length, shall be filled with "spare padding".

6.10.2.9.3 L | H convention in rest octets of GSM DL messages

A number of GPRS information elements are defined in the rest octets of certain GSM DL messages. The special notations "L" and "H" are used to denote respectively the bit's logical value corresponding to the padding spare bit for that position, and the other value. The actual value of the bit transmitted by SS therefore depends upon its position within the octet - this involves counting bits.

In the TTCN a third encoding variation - encoding rule 3 - is defined for this purpose. This encoding variation is applied to those specific TTCN Rest Octets definitions which contain the L|H convention.

6.10.2.9.4 Spare Bits

Where the IE definition of RLC/MAC blocks contains bits defined to be 'spare bits', these bits shall set to the value '0' by the TTCN writers, according to the defined length indicator.

6.10.2.9.5 GSM System Information messages on SACCH

Certain GSM System Information messages, for instance, SI 5 and SI 6 are sent as a B4 frame on the SACCH. These messages are defined in 3GPP TS 44.006 [42], clause 8.8.3, to have a maximum of 19 octets.

In the TTCN a fourth encoding variation - encoding rule 4 - shall be used in the definition of the message itself. The implementation shall ensure that after encoding the message contents defined in the TTCN, the remainder of the message, up to the fixed length of 19 octets, shall be filled with "spare padding".

6.10.2.9.6 GSM Measurement Information messages on SACCH

The GSM Measurement Information message is sent as a Bter UI frame on the SACCH. This messages is defined in 3GPP TS 44.006 [42], clause 8.8.3 to have a maximum of 21 octets.

In the TTCN a fifth encoding variation - encoding rule 5 - shall be used in the definition of the message itself. The implementation shall ensure that after encoding the message contents defined in the TTCN, the remainder of the message, up to the fixed length of 21 octets, shall be filled with "spare padding".

6.11 DCH-DSCH model (R99 or Rel-4)

The model illustrates the relationship between various channels from logical channel to physical channels. DCH are associated with DSCH.

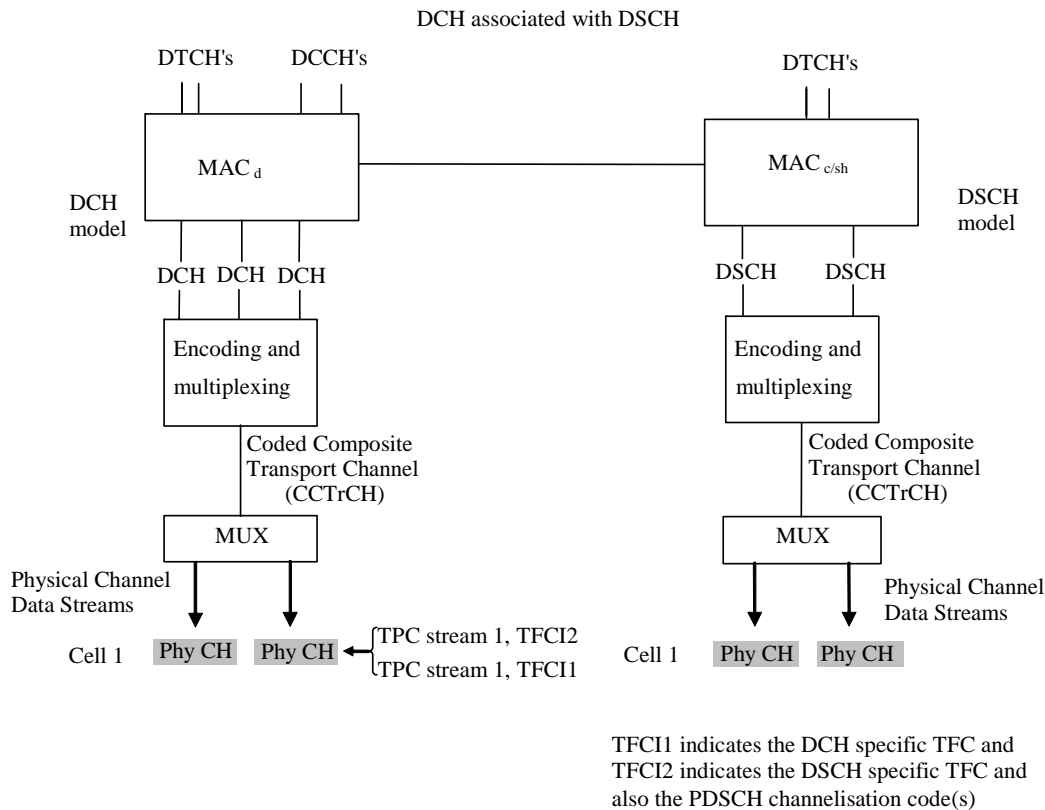

Figure 6.11: Associated DCH-DSCH model

The model associating DCH with DSCH enable in the SS:

- to define DSCH transport channel;
- to define TFCI(field2) for DSCH;
- to configure PDSCH;
- to define DSCH-RNTI value.

6.12 DCH with HS-DSCH (MAC-hs) model (FDD, Rel-5 or later)

The test model illustrates the relationship between various channels from logical channels to physical channels. All DCH are associated with a single HS-DSCH.

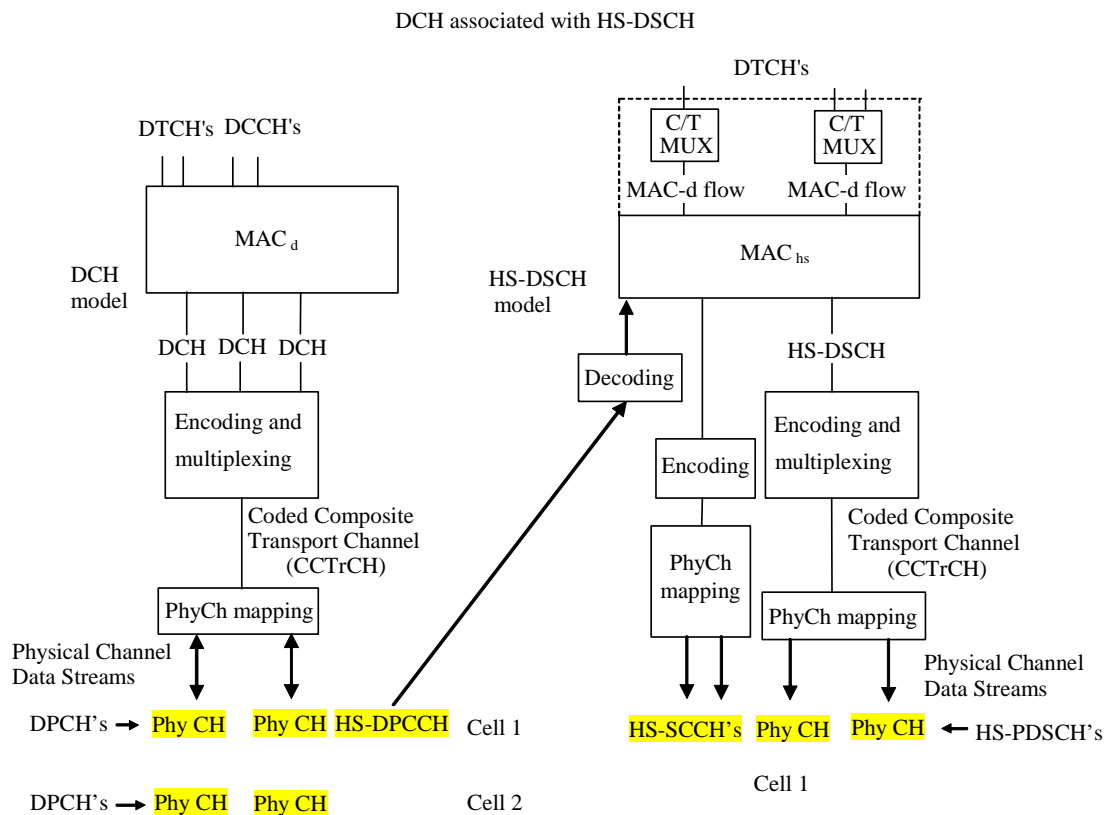

Figure 6.12: Associated DCH with HS-DSCH model

Associating DCH with HS-DSCH, the model enables in the SS:

- to define MAC-hs and multiplexing of logical channels DTCHs onto MAC-d flows;
- to configure HS-DSCH transport channel and MAC-d flows;
- to configure HS-PDSCHs and HS-SCCHs;
- to define the H-RNTI value.

6.12a DCH with HS-DSCH model for 1.28 Mcps TDD (Rel-5 or later)

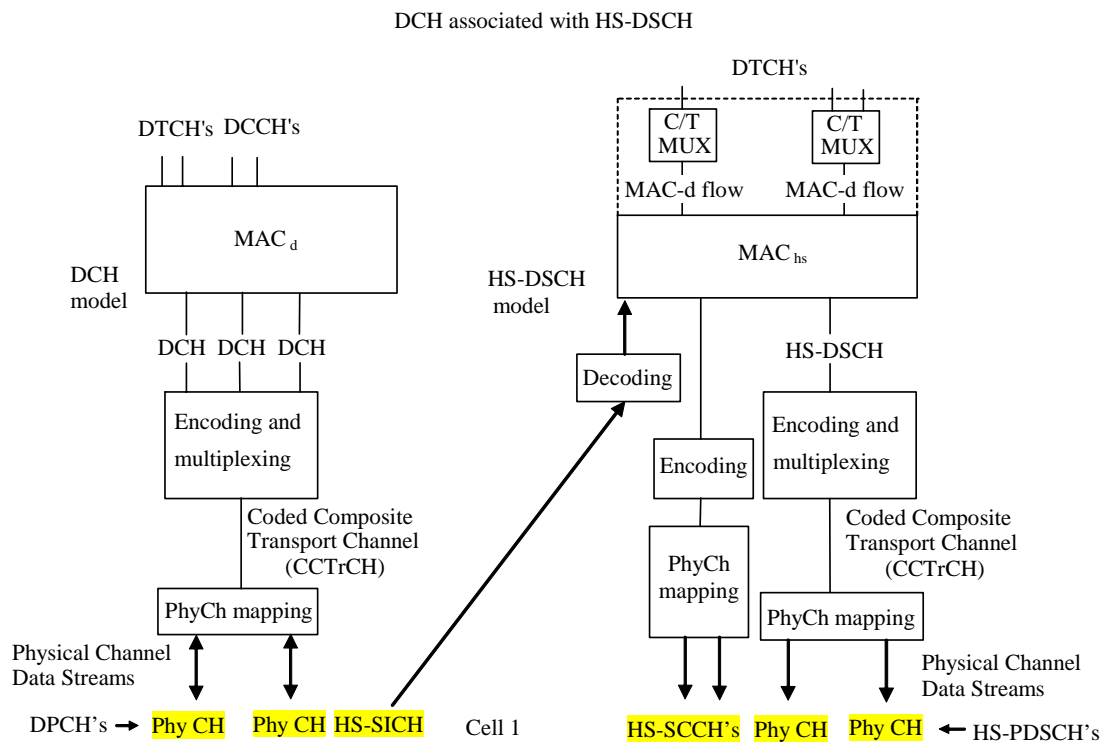

Figure 6.12a: Associated DCH with HS-DSCH model for 1.28 Mcps TDD

Associating DCH with HS-DSCH, the model enables in the SS:

- to define MAC-hs and multiplexing of logical channels DTCHs onto MAC-d flows;
- to configure HS-DSCH transport channel and MAC-d flows;
- to configure HS-PDSCHs and HS-SCCHs;
- to define the H-RNTI value.

6.12b DCH with HS-DSCH (MAC-ehs) model (FDD, Rel-7 or later)

The test model illustrates the relationship between various channels from logical channels to physical channels. All DCH are associated with a single HS-DSCH.

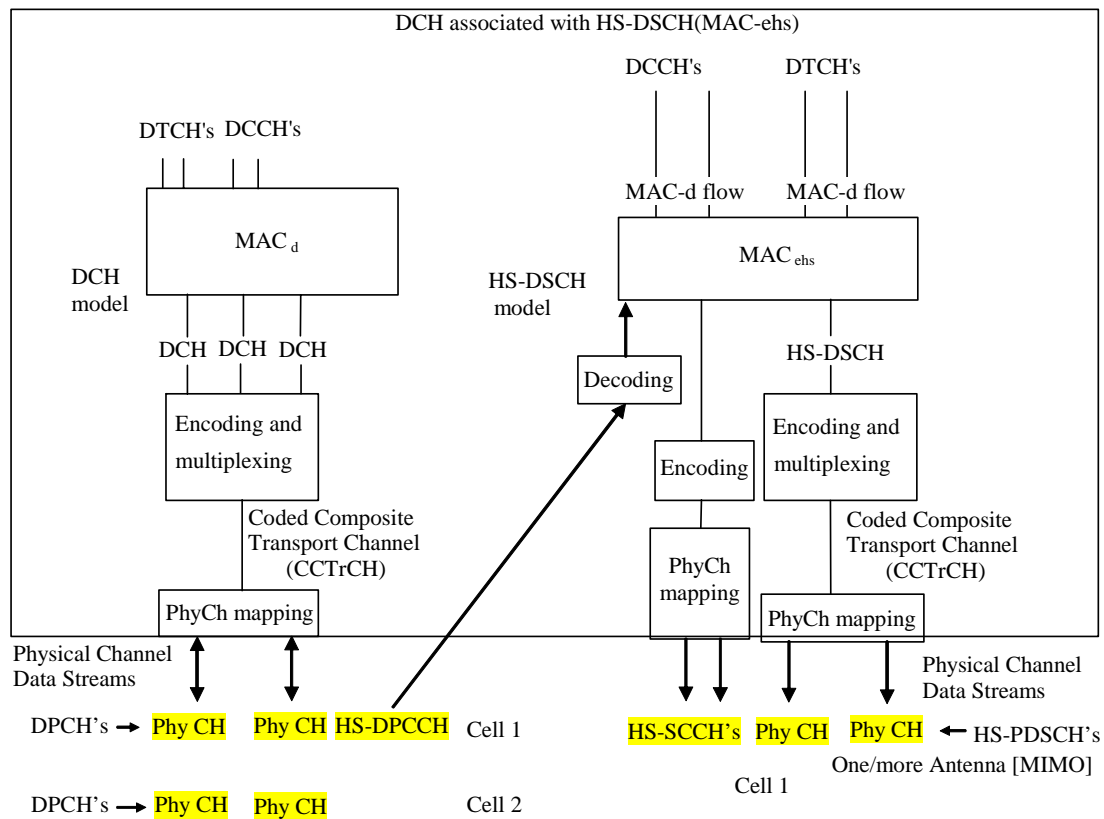

Figure 6.12b: Associated DCH with HS-DSCH model

Associating DCH with HS-DSCH, the model enables in the SS:

- to define MAC-ehs and multiplexing of logical channels DTCHs & DCCHs onto MAC-d flows;
- to configure HS-DSCH transport channel and MAC-d flows;
- to configure HS-PDSCHs and HS-SCCHs;
- to define the H-RNTI value.
- to configure MIMO;

6.12c HS-DSCH (MAC-hs/ehs) model (FDD, Rel-7 or later)(No DCH Associated)

The test model illustrates the relationship between various channels from logical channels to physical channels.

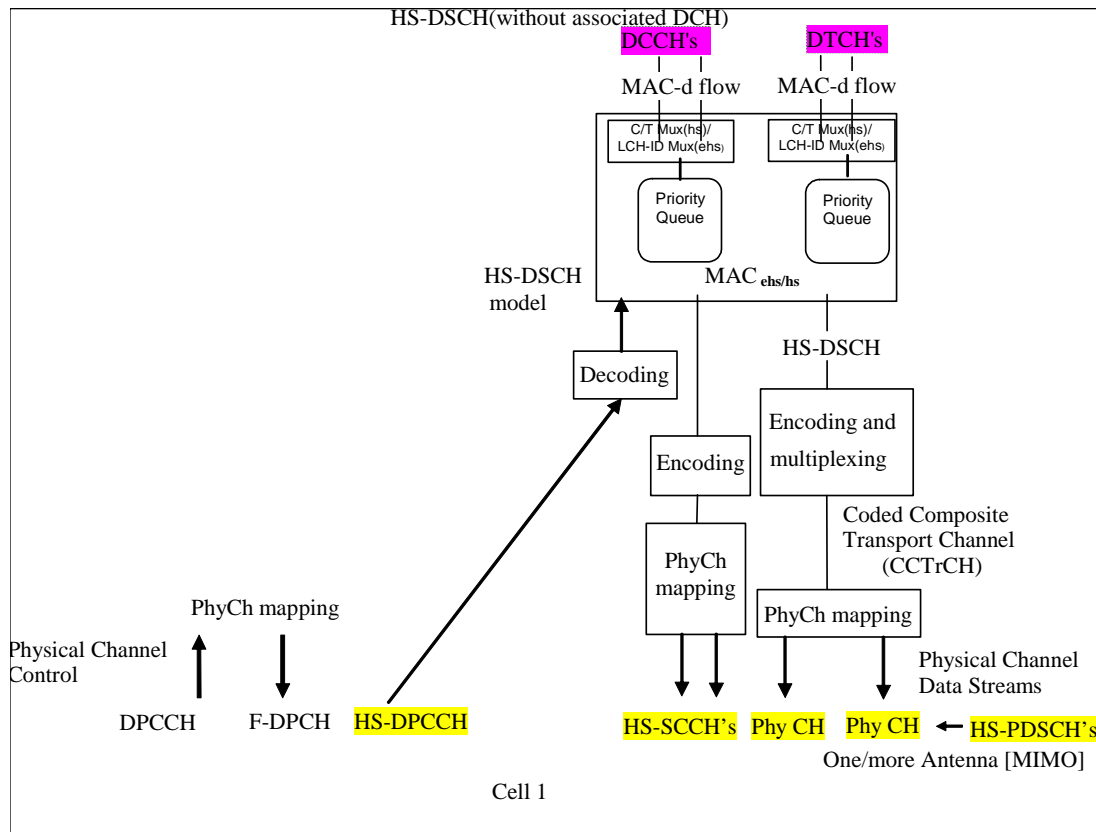

Figure 6.12c: HS-DSCH model without DCH associated

The model enables in the SS:

- to define MAC-ehs/hs and multiplexing of logical channels DTCHs & DCCHs onto MAC-d flows;
- to configure HS-DSCH transport channel and MAC-d flows/MAC-ehs Queues;
- to configure HS-PDSCHs and HS-SCCHs;
- to define the H-RNTI value(s);
- to configure MIMO.
- during the active set updating (soft handover), the test case configurations involves more than one cell; but one MAC-ehs entity is configured.

6.12d HS-DSCH (MAC-ehs) model for DC-HSDPA (FDD, Rel-8 or later)

The test model illustrates the relationship between various channels from logical channels to physical channels.

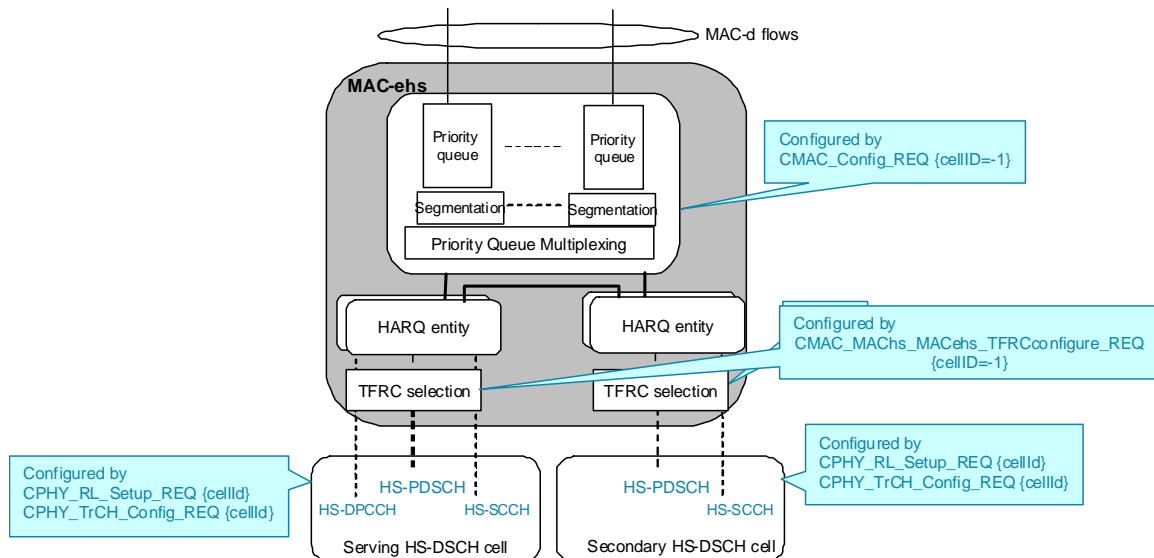

Figure 6.12d: HS-DSCH model with intra-NodeB DC-HSDPA

The model enables in the SS to configure DC-HSDPA:

- MAC-ehs and the served RLC are cell-independent and are configured by using the cell-id =-1. During reconfigurations, cell changes and state transitions, the relevant counters in the RLC are maintained
- to define MAC-ehs and multiplexing of logical channels DTCHs & DCCHs onto MAC-ehs queues;
- to configure HS-DSCH transport channel and MAC-ehs Queues;
- to configure HS-PDSCHs and HS-SCCHs on the serving and secondary HS-DSCH cells;
- to configure HS-DPCCH in the serving cell;
- to define the H-RNTI value(s);
- MIMO and DC-HSDPA do not co-exist in Rel-8;
- to configure combined DC-HSDPA and MIMO in Rel-9 or later Releases.

6.13 E-DCH model (Rel-6 or later)

6.13.1 MAC-e/MAC-es test model

The E-DCH model illustrates the relationship between various channels from logical channel to physical channels. In this model the TTCN writer can:

- define MAC-e/es and multiplexing of logical channels onto MAC-d flows;
- configure E-DCH transport channel and MAC-d flows;
- configure E-DPDCH, E-DPCCH, E-HICH, E-RGCH and E-AGCH.

MAC-es and the served RLC are cell-independent and are configured by using the cell-id = -1. During reconfigurations, cell changes and state transitions, the relevant counters in the RLC are maintained.

For the reason of simplicity, the E-DCH testing model does not shown the relation between E-DCH and related DCH and HS-DPCH, however the TTCN writer shall understand that the E-DCH active set is a subset of the DCH active set, when configuring E-DCH in the SS the TTCN writer shall keep this requirement respected.

During the active set updating (soft handover), the test case configurations may involve more than one cell. Those cells are under the control of the same Node B (intra-node) or under several Node B's (inter-node). For the signalling testing no macro diversity is required in the SS. In such test configurations only one E-DPDCH is necessary to be configured (together with corresponding E-DCH) for each Node B. Preferably, the E-DPDCH in the serving E-DCH cell controlled by the serving Node B is chosen for the configuration. In the inter-node soft handover cases, the E-DPDCH in a Non-serving RL cell of another Node B may require to be configured, instead of the one in the serving E-DCH cell. When the configuration involves several Node B's only one MAC-e (Node B) is necessary to be connected to the MAC-es. All possible connections are represented by dashed line and the preferable connection is the connection between MAC-es and the Node B controlling the serving E-DCH cell.

Since the UL-DPCCH is needed as reference channel for the E-DPCCH the UL-DPCH is configured in every cell where an E-DCH is configured (i.e. in serving and non-serving cell). In order to simplify the implementation and to avoid macro diversity in all non-serving cells the UL-DPCH is configured without the associated transport channel configuration, i.e. the physical channel is not connected to MAC-d.

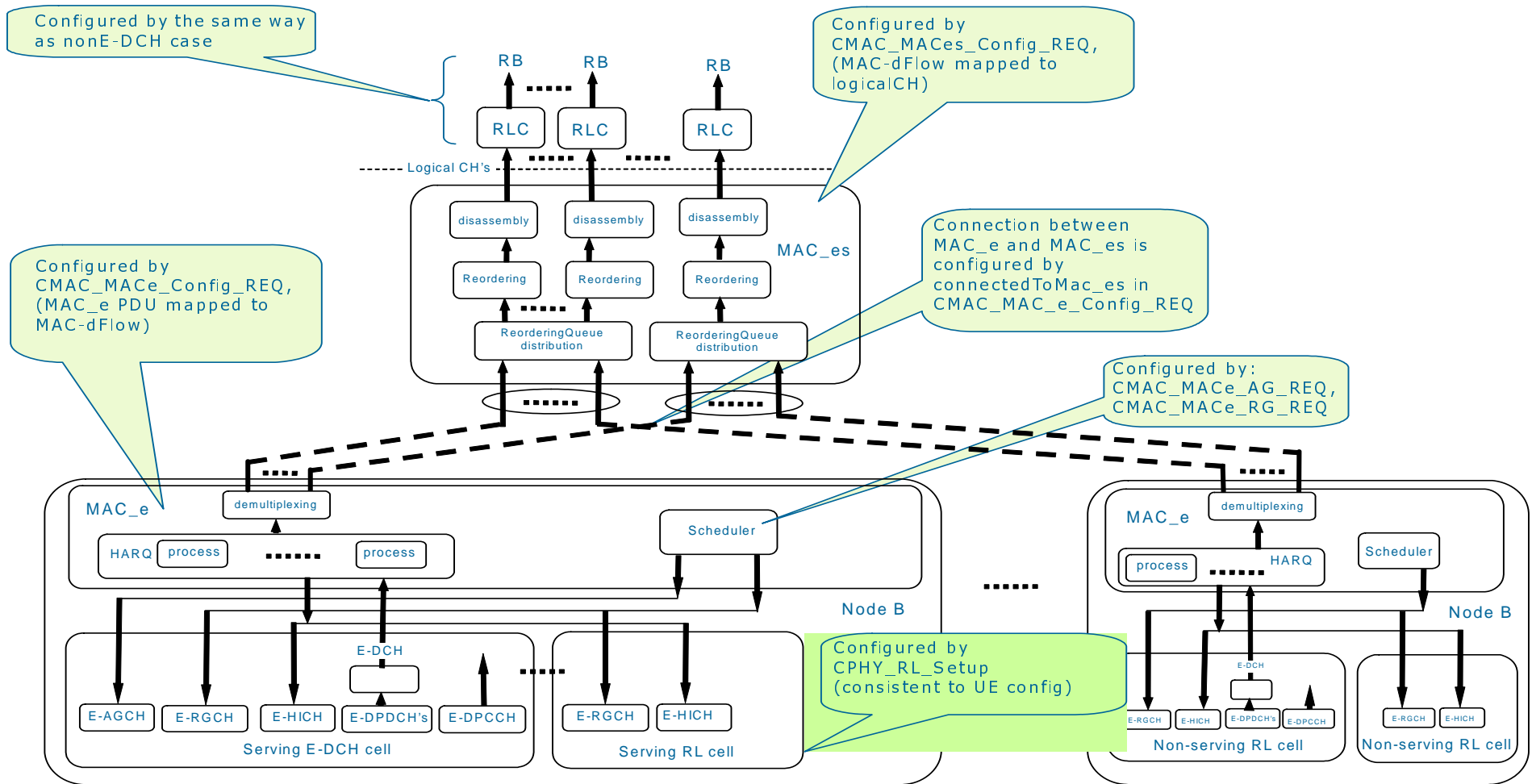

Figure 6.13.1: The model of E-DCH testing with MAC-e/MAC-es

6.13.2 MAC-i/MAC-is test model (Rel-8 or later)

For channel configuration and activate set update, the same requirement apply as for MAC-e/Mac-es in clause 6.13.1.

The MAC-i/is E-DCH test model is provided in Figure 6.13.2.

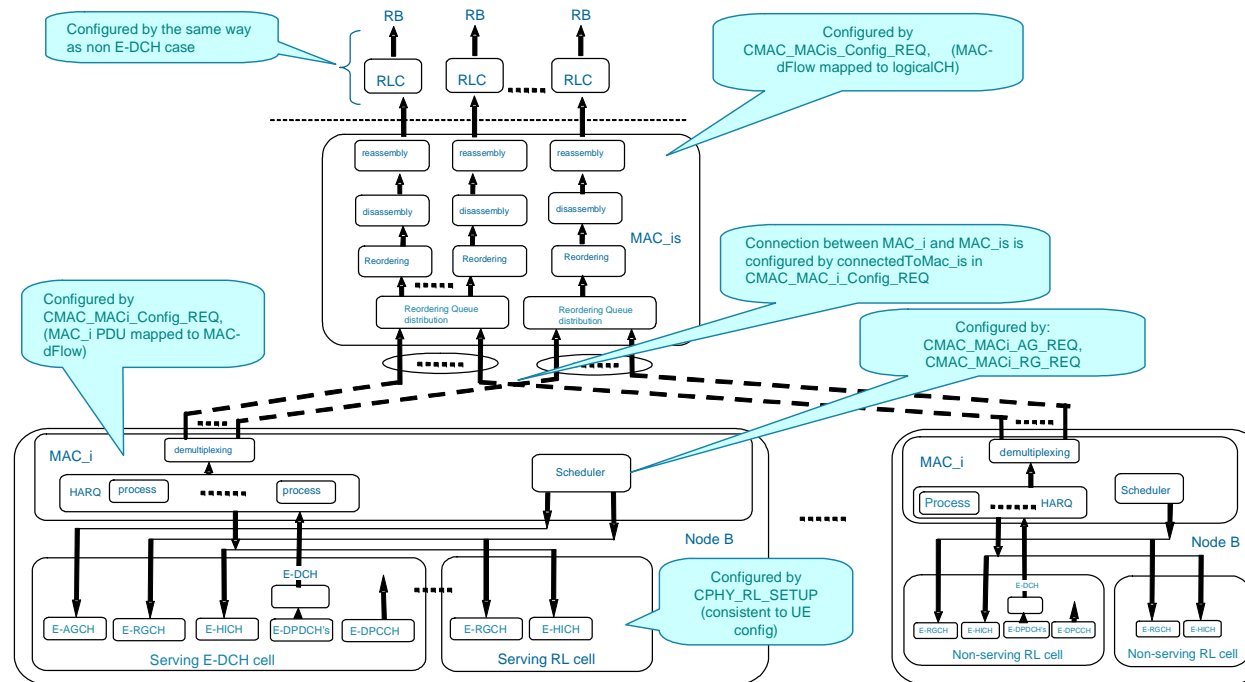

Figure 6.13.2: The model of E-DCH testing with MAC-i/MAC-is

6.13.2.1 MAC-i/MAC-is test model for Enhanced UL in Cell_FACH (Rel-8 or later)

The MAC-i/is E-DCH test model for enhanced UL in cell_FACH is provided in Figure 6.13.2.1.

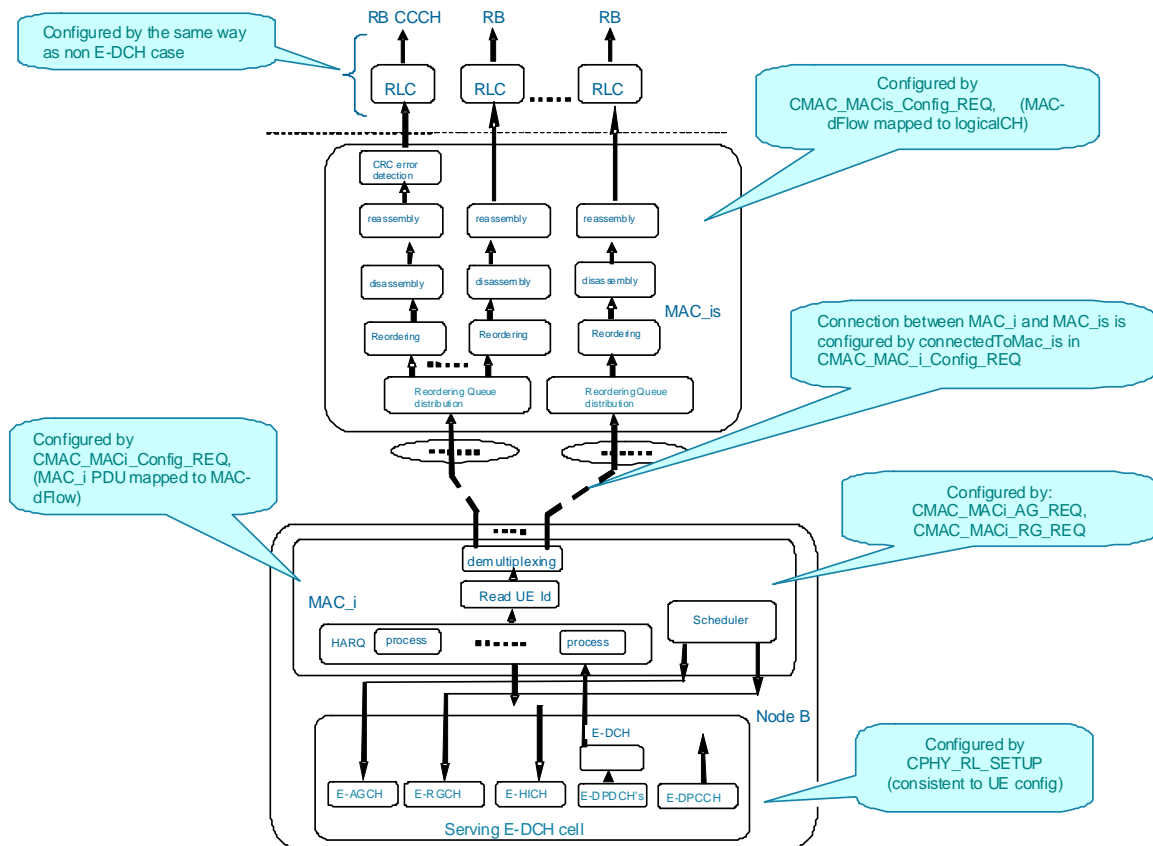

Figure 6.13.2.1: The model of E-DCH testing with MAC-i/MAC-is for enhanced uplink in CELL_FACH state

If the UE is in CELL_FACH state or Idle mode, the UE's E-DCH active set consists of a single serving cell.

6.13.2.2 MAC-i/MAC-is test model for DC-HSUPA (Rel-9 or later)

The E-DCH model illustrates the relationship between various channels from logical channel to physical channels in DC-HSUPA configuration. In this model the TTCN can:

- define MAC-i/-is and multiplexing of logical channels onto MAC-d flows;
- configure E-DCH transport channel and MAC-d flows on all cells;
- configure E-DPDCH, E-DPCCH, E-HICH, E-RGCH and E-AGCH on primary and secondary uplink frequency.

MAC-is and the served RLC are cell-independent and are configured by using the cell-id = -1. During reconfigurations, cell changes and state transitions, the relevant counters in the RLC are maintained. MAC-i entities are mapped to a NodeB id and the two MAC-i entities related to the serving RL and the secondary Serving RL are connected to the MAC-is entity.

For the reason of simplicity, the E-DCH testing model does not shown the relation between E-DCH and related DCH and HS-DPCH, however, it is understood that the E-DCH active set is a subset of the DCH active set, when configuring E-DCH in the SS. The HS-DPCCH channel is configured only in the primary uplink frequency cell. Since the UL-DPCCH is needed as reference channel for the E-DPCCH the UL-DPCH is configured in every cell where ver an E-DCH is configured (i.e. in serving and secondary serving cell).

During the active set updating (soft handover), the added RL are configured in the same way as for MAC-e/es.

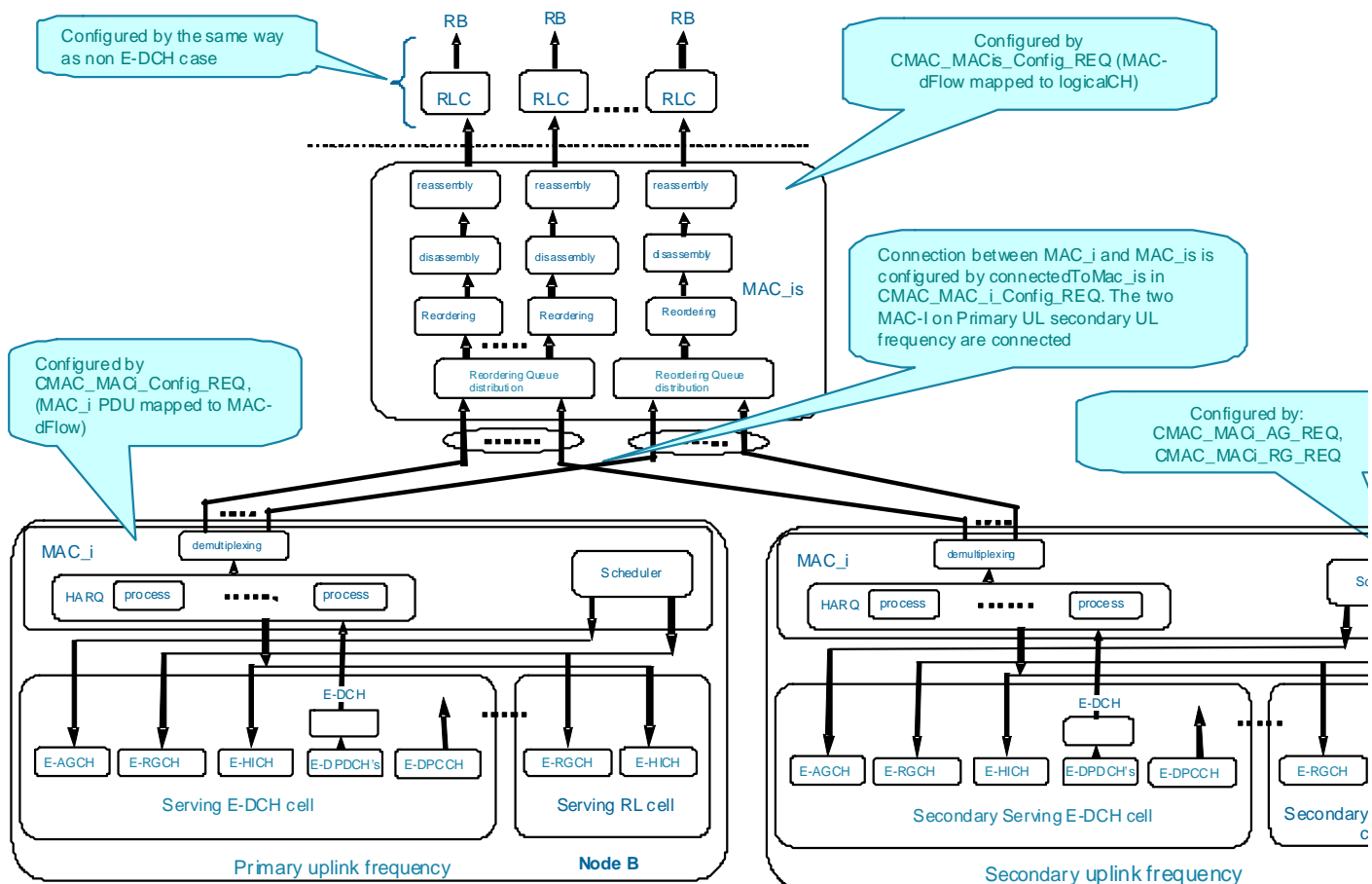

Figure 6.13.2.2: The model of E-DCH testing with MAC-i/MAC-is for DC-HSUPA

6.14 MBMS model (Rel-6 or later)

The MBMS test model illustrates the relationship between various channels, from logical channel to physical channels applied to the MBMS test. The MBMS-dedicated stand-alone SCCPCH, MICH, MAC-m, MCCH, MSCH and MTCH are configured by the TTCN.

During softcombining, MTCHs which have the same logical channel identity but in different cells are connected to the same UM RLC.

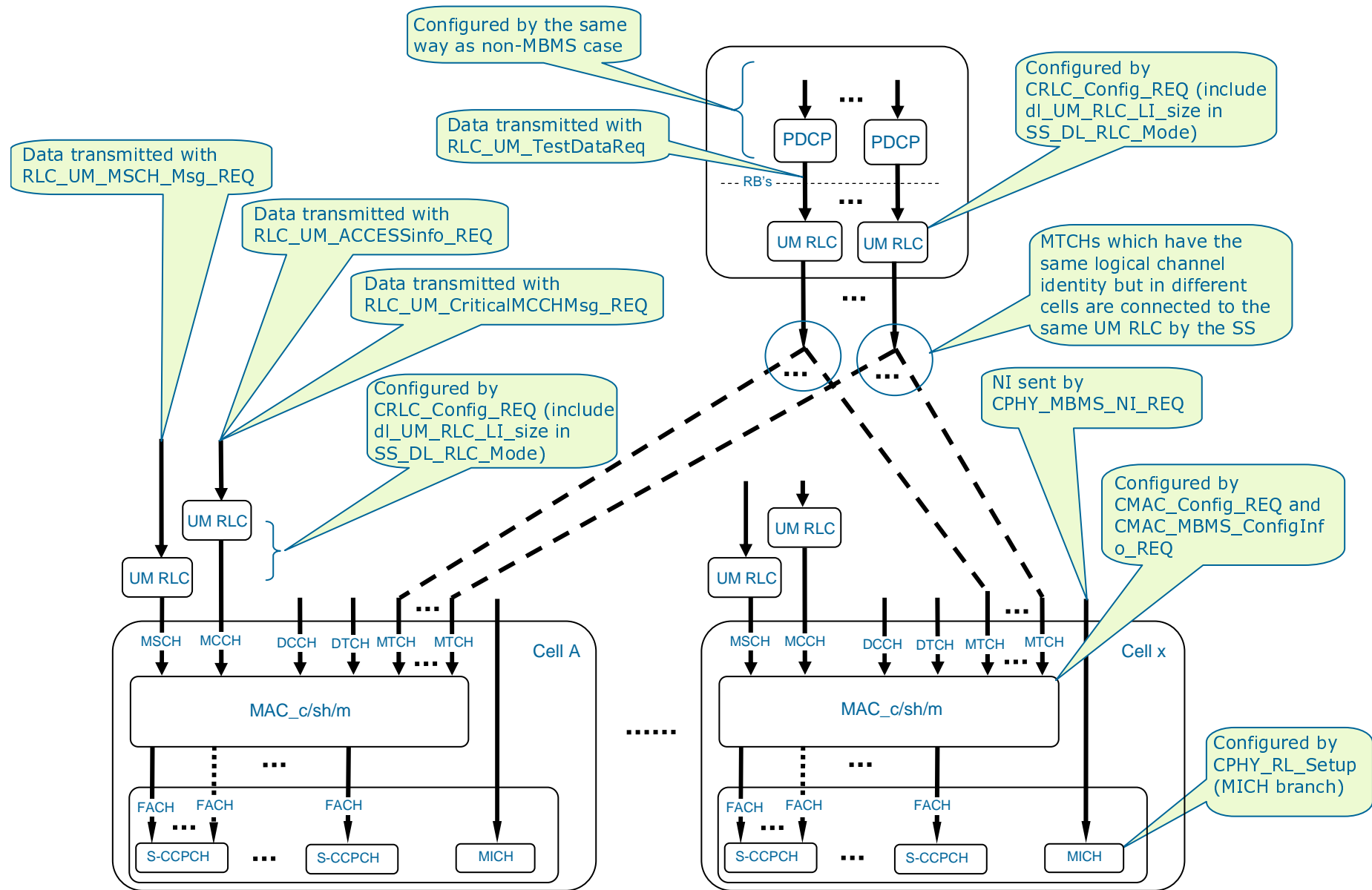

Figure 6.14: The model of MBMS testing

6.14.1 MBMS RLC test model

6.14.1.1 RLC test model for MTCH test

For RLC tests on MTCH a TR radio bearer is configured (tsc_RB_MTCH_RLC_TR). Similar to the UM mode, data scheduling is applied at the test.

When reconfiguring back from TR to UM mode, MAC is reconfigured and RLC is released/reconfigured again. It implies that UM will restart with sequence number 0; the corresponding RLC state variables are set to 0. Sequence numbers between the one used in the last PDU sent in TR mode and the sequence number 0 are considered by the UE as lost sequence numbers and shall have no impact on the test in the UM mode.

6.14.1.2 RLC test model for MCCH test

For RLC tests the MCCH critical messages can be sent as a DL sequence of PER encoded UM RLC PDUs in RLC TR mode. To achieve this, the normal UM radio bearer on MCCH is replaced with a TR radio bearer configured with a negative RB Id (tsc_RB_MCCH_RLC_TR). This is achieved by reconfiguring MAC and releasing the existing RLC UM entity /configuring a new TR RLC entity. It results in only one RLC entity being able to map on MCCH at the test.

It is assumed that the necessary MCCH data are completely sent out before the reconfiguration procedure mentioned above takes place.

When changing from UM to TR the care should be taken on the sequence numbers used in the RLC PDUs. That can be achieved by querying the SN from SS with CRLC_SequenceNumber_REQ. When changing back to UM the RLC may continue with the sequence number following the last sequence number used before changing to TR mode. That implies, the UM part of the RLC in SS does not need to take care of the UM PDUs sent in TR mode. The UE will regard it as PDU lost.

To support re-synchronization the 'specialLI' of the RLC_UM_CriticalMCCHMsg_REQ following TR mode can be set to TRUE.

7 PCO and ASP definitions

7.1 NAS PCO and ASP definitions

7.1.1 NAS PCO Definitions

Table 7.1.1.1: Dc PCO Type Declarations

PCO Type Declarations	
PCO Type	Dc_SAP
Role	LT
Comments	The PCO type for NAS testing

Table 7.1.1.2: Dc PCO Declarations

PCO Declarations	
PCO Name	Dc
PCO Type	Dc_SAP
Role	LT
Comments	Carry transmission and reception of NAS messages

7.1.2 Primitives used at Dc PCO

The Dc PCO is used to transmit and receive NAS (MM, CC, SM, SS) messages. Two categories of primitives are operated at the Dc PCO:

- RRC_DataReq for transmission of a NAS PDU;
- RRC_DataInd for reception of a NAS PDU.

These primitives are declared in TTCN tabular form, see Tables 7.1.2.1-1 and 7.1.2.1-2.

Table 7.1.2.1-1: Primitive RRC_DataInd used at the Dc PCO

ASP Name	RRC_DataInd	
PCO Type	Dc_SAP	
Comments	The ASP is used to indicate the receipt of the NAS PDU message using acknowledged operation (NAS <- RRC).	
Parameter Name	Parameter Type	Comments
cellId	INTEGER	Cell Id
rB_Id	SS_RB_Identity	RB identity (RB3 or RB4)
ch	LogicChGERAN	Logical channel (used for interworking with GERAN)
sapId	SapId	RRC SAP identifier (SAP0)
cN_Domain	SS_CN_DomainIdentity	CN domain identity
start	START_Value	Mandatory in INITIAL DIRECT TRANSFER
msg	PDU	NAS PDU
Detailed Comments		

Table 7.1.2.1-2: Primitive RRC_DataReq used at the Dc PCO

ASP Name	RRC_DataReq	
PCO Type	Dc_SAP	
Comments	The ASP is used to request the transmission of the NAS PDU message using acknowledged operation (NAS -> RRC).	
Parameter Name	Parameter Type	Comments
cellId	INTEGER	Cell Id
rB_Id	SS_RB_Identity	RB identity (RB3 or RB4)
ch	LogicChGERAN	Logical channel (used for interworking with GERAN)
sapId	SapId	RRC SAP identifier (SAP0)
cN_Domain	SS_CN_DomainIdentity	CN domain identity
msg	PDU	NAS PDU
Detailed Comments		

The RB Identity and CN domain parameters defined in the primitives are mandatory for UTRAN and not applicable for GERAN.

The START parameter is mandatory in INITIAL DIRECT TRANSFER; each time when it is received the new START shall be downloaded to the SS to reinitialize counters-C and counters-I.

The LogicChGSM and SapId parameters are mandatory for GERAN and not applicable for UTRAN. They are defined because they may be used for future TTCN test cases.

Except the initial, uplink and downlink direct transfer procedures, the NAS TTCN specification uses the TTCN test steps to realize all RRC functions for testing. The single layer test concept is kept for the NAS tests.

A simple RRC emulation shall be maintained for the NAS tests. It has four functions:

- Emulate the three direct transfer procedures.
- Convert the NAS downlink messages defined in 3GPP TS 24.008 [9] in table format to the NAS message in ASN.1 octet string specified in 3GPP TS 25.331 [21]. Convert the NAS uplink message in the reverse way.
- PER encoding and decoding.

- Have the integrity protection.

RB3 and RB4 are specifically used for the NAS signalling. When an uplink message entered the receiving buffer at AM-SAP from the RLC emulation, either an RRC test step if running will take it out; or the RRC emulation if running will pick the received message from the buffer. Activation of any RRC test steps and activation of any NAS test steps at the same time shall be excluded in TTCN (no concurrency between them).

7.2 Ut PCO and ASP definitions

7.2.1 Ut PCO Declarations

The Ut PCO is served as the interface to the UE EMMI for remote control of operations, which have to be performed during execution of a test case such as to switch the UE on/off, initiate a call, etc.

Table 7.2.1.1: Declaration of the upper tester PCO type

PCO Type Declarations	
PCO Type	MMI
Role	UT
Comments	The PCO type for MMI or EMMI of the upper tester

Table 7.2.1.2: Declaration of the Ut PCO

PCO Declarations	
PCO Name	Ut
PCO Type	MMI
Role	UT
Comments	Carry transmission commands and reception of results for the upper tester

7.2.2 Primitives used at Ut PCO

The Ut PCO is used to indicate to the upper tester actions and to receive the acknowledgement of these actions. The AT commands are used wherever the suitable commands exist within 3GPP TS 27.007 [23], 3GPP TS 27.005 [22] and 3GPP TS 27 060 [24]. An MMI command is used, when AT commands does not exit for the action to performed. The primitives used at the Ut PCO, are declared in TTCN tabular form, see Table 7.2.2.1.

Table 7.2.2.1: Primitives used at the Ut PCO

Primitive	Parameters	Use
AT_CmdReq	Command: IA5String SMS_BlockMode: HEXSTRING	Request an AT command to the upper tester.
AT_CmdInd	Command: IA5String SMS_BlockMode: HEXSTRING	Indication of a result from the upper tester.
AT_CmdCnf	Result: BOOLEAN ResultString: IA5String SMS_BlockMode: HEXSTRING	Return a positive or negative result from the command previously sent. Both the Boolean result and String parameter are optional.
MMI_CmdReq	Command: IA5String	Request a command to the upper tester.
MMI_CmdCnf	Result: BOOLEAN ResultString: IA5String	Return a positive or negative result from the command previously sent. The String parameter is optional.

The AT_CmdReq primitive for sending AT commands is mostly used to trigger electronically an uplink access, such as initiating of a call, attaching or detaching, starting packet data transfer etc. The MMI_primitive is defined mainly for observation of some test events via a test operator, such as checking DTMF tone or checking called party number, etc.

The AT_CmdInd primitive for receiving AT commands is mostly used to transfer unsolicited result codes from the UE to the lower tester.

The SMS_BlockMode parameter is used to control and observe the Block mode procedure for SMS. This parameter is not yet used; it is defined for future development. The Command and SMS_BlockMode parameters are mutually exclusive

For the Command in the AT_CmdReq and AT_CmdInd primitives, the verbose format is used as defined in 3GPP TS 27.007 [23]. For the Command in MMI_CmdReq, just a descriptive IA5 string line, like "Check DTMF tone" is used.

7.3 RRC PCO and ASP definitions

7.3.1 AM/UM/TM PCO and ASP definitions

7.3.1.1 SAP and PCO for data transmission and reception

Table 7.3.1.1.1: Declaration of the RRC PCO Type

PCO Type Definition	
PCO Type	DSAP
Role	LT
Comment	DATA transmission and reception

Table 7.3.1.1.2: PCO TM declaration

PCO Type Definition	
PCO Name	TM
PCO Type	DSAP
Role	LT
Comment	Carry Transparent Mode RLC PDU

Table 7.3.1.1.3: PCO AM declaration

PCO Type Definition	
PCO Name	AM
PCO Type	DSAP
Role	LT
Comment	Carry Acknowledged Mode RLC PDU

Table 7.3.1.1.4: PCO UM declaration

PCO Type Definition	
PCO Name	UM
PCO Type	DSAP
Role	LT
Comment	Carry Unacknowledged Mode RLC PDU

Table 7.3.1.1.5: PCO BMC declaration

PCO Type Definition	
PCO Name	BMC
PCO Type	DSAP
Role	LT
Comment	Provide Unacknowledged Mode BMC data transmission service

7.3.2 Control PCO and ASP

7.3.2.1 SAP and PCO for control primitives transmission and reception

Table 7.3.2.1.1: SAP declaration

PCO Type Definition	
PCO Type	CSAP
Role	LT
Comment	Control primitives transmission and reception

Table 7.3.2.1.2: PCO CPHY

PCO Definition	
PCO Name	CPHY
PCO Type	CSAP
Role	LT
Comment	Control Physical Layer

Table 7.3.2.1.3: PCO CRLC

PCO Definition	
PCO Name	CRLC
PCO Type	CSAP
Role	LT
Comment	Control RLC Layer

Table 7.3.2.1.4: PCO CMAC

PCO Definition	
PCO Name	CMAC
PCO Type	CSAP
Role	LT
Comment	Control MAC Layer

Table 7.3.2.1.5: PCO CBMC

PCO Definition	
PCO Name	CBMC
PCO Type	CSAP
Role	LT
Comment	Control BMC Layer

Table 7.3.2.1.6: ExternalAsn1Codec declaration

PCO Type Definition	
PCO Type	ExternalAsn1Codec
Role	LT
Comment	Control decoder primitives transmission and reception

Table 7.3.2.1.7: PCO CCodec

PCO Definition	
PCO Name	CCodec
PCO Type	ExternalAsn1Codec
Role	LT
Comment	Control asn.1 CONTAINING decoder

Table 7.3.2.1.8: ExternalStructure Codec declaration

PCO Type Definition	
PCO Type	ExternalStructureCodec
Role	LT
Comment	Control decoder from a BITSTRING to a structure type primitives transmission and reception

Table 7.3.2.1.9: PCO CCodecS

PCO Definition	
PCO Name	CCodecS
PCO Type	ExternalStructureCodec
Role	LT
Comment	Control BITSTRING to structure type decoder

7.3.2.2 Control ASP Type Definition

7.3.2.2.1 CPHY_AICH_AckModeSet

ASN.1 ASP Type Definition	
Type Name	CPHY_AICH_AckModeSet_REQ
PCO Type	CSAP
Comment	To request for setting of AICH Acknowledge Mode
Type Definition	
SEQUENCE	{ cellId INTEGER(0..63), routingInfo RoutingInfo, ratType RatType, aICH_Mode AICH_Mode }

ASN.1 ASP Type Definition	
Type Name	CPHY_AICH_AckModeSet_CNF
PCO Type	CSAP
Comment	To confirm setting of AICH Acknowledge Mode
Type Definition	
SEQUENCE	{ cellId INTEGER(0..63), routingInfo RoutingInfo }

ASN.1 Type Definition	
Type Name	AICH_Mode
Comment	Normal operation: The AICH will operate as normal, and will acknowledge or negatively acknowledge on all UE RACH/E-DCH transmission attempts, appropriately. No Acknowledge: The AICH shall not transmit acknowledge or Negative Acknowledge on all UE RACH/E-DCH transmission attempts. Negative Acknowledge: The AICH shall transmit Negative Acknowledge on all UE RACH/E-DCH transmission attempts
Type Definition	
ENUMERATED	{ normal (0), noAck (1), negACK (2) }

7.3.2.2.2 CPHY_Cell_Config

ASN.1 ASP Type Definition	
Type Name	CPHY_Cell_Config_CNF
PCO Type	CSAP
Comment	To confirm to setup the cell parameter
Type Definition	
SEQUENCE {	
cellId	INTEGER(0..63)
}	

ASN.1 ASP Type Definition	
Type Name	CPHY_Cell_Config_REQ
PCO Type	CSAP
Comment	To request to setup the cell parameter. The unit of tcell is chip; the unit of sfnOffset is frame number. The sfnOffset is defined as the number of frames the SFN shall be shifted, i.e. the frames lagging behind or in advance, in comparison to a system reference time. The both interpretations are valid for the test. The primary scrambling code number of the cell is 16*primaryScramblingCode_SS. The unit of dLtxAttenuationLevel is dB; If set to 123 the cell becomes a non-suitable off cell (CPICH_Ec ≤ -122 dBm/3.84 MHz of an off cell).
Type Definition	
SEQUENCE {	
cellId	INTEGER(0..63),
tcell	INTEGER(0..38399),
sfnOffset	INTEGER(0..4095),
frequencyInfo	FrequencyInfo,
primaryScramblingCode_SS	INTEGER(0..511),
cellTxPowerLevel	CellTxPowerLevel,
dLtxAttenuationLevel	INTEGER(0..30 123),
frequencyBandIndicator	FrequencyBandFDD
}	

ASN.1 Type Definition	
Type Name	CellTxPowerLevel
Comment	The defaultCellTxPowerLvl is a default setting and is used for the most signalling tests. The real total cell DL Tx power level equals to the sum of the DL Tx power of the individual physical channels configured. The totalCellTxPowerLvl applies to e.g. the idle mode tests in a non-default multi-cell radio environment.
Type Definition	
CHOICE {	
defaultCellTxPowerLvl	NULL,
totalCellTxPowerLvl	DL_TxPower
}	

ASN.1 Type Definition	
Type Name	FrequencyBandFDD
Comment	The frequency band indicator indicates how to interpret the radio frequency broadcast.
Type Definition	
CHOICE {	
frequencyBandIndicator	RadioFrequencyBandFDD,
frequencyBandIndicator2	RadioFrequencyBandFDD2,
frequencyBandIndicator3	RadioFrequencyBandFDD3
}	

7.3.2.2.3 CPHY_Cell_Release

ASN.1 ASP Type Definition	
Type Name	CPHY_Cell_Release_CNF
PCO Type	CSAP
Comment	The confirmation to the CPHY_Cell_Release_Req
Type Definition	
<pre>SEQUENCE { soft_Reset BOOLEAN, cell_ID_List SEQUENCE (SIZE (1..8)) OF INTEGER(0..63) -- cell IDs }</pre>	

ASN.1 ASP Type Definition	
Type Name	CPHY_Cell_Release_REQ
PCO Type	CSAP
Comment	<ol style="list-style-type: none"> 1. This Primitive with "Soft_Reset" flag ON gives a common known starting point/state of SS for a test case. The SS performs the following whenever it receives this primitive with "Soft_Reset" flag ON: Releases all configured Channels and cells (if any) irrespective of Cell ID list IE. 2. Releases the associated Memory Buffers (if any). 3. Cancels all active timers (if any) With "Soft_Reset" flag OFF: <ol style="list-style-type: none"> 1. Releases cells listed in IE Cell_ID_List and associated configured Channels (if any) 2. Releases the Memory Buffers(if any) associated with Cells listed in IE Cell_ID_List 3. Cancels all active timers (if any) associated with Cells listed in IE Cell_ID_List. Presence of rbConfig_List IE indicates the configured Channels in the associated cells in the list to be released. If rbConfig_List IE is present, then for each entry in cell_ID_List a corresponding entry in rbConfig_List shall be present. The configuration values applied in rbConfig_List follows RB_ConfigType.
Type Definition	
<pre>SEQUENCE { soft_Reset BOOLEAN, cell_ID_List SEQUENCE (SIZE (1..8)) OF INTEGER(0..63) , -- cell IDs rbConfig_List SEQUENCE (SIZE (1..8)) OF INTEGER OPTIONAL }</pre>	

7.3.2.2.3a CPHY_Cell_TimingAdjust

ASN.1 ASP Type Definition	
Type Name	CPHY_Cell_TimingAdjust_CNF
PCO Type	CSAP
Comment	To confirm to set the cell timing parameter
Type Definition	
<pre>SEQUENCE { cellId INTEGER (0..63) }</pre>	

ASN.1 ASP Type Definition	
Type Name	CPHY_Cell_TimingAdjust_REQ
PCO Type	
Comment	To request the cell identified by cellId to adjust its timing to the amount of deltTcell given in this ASP. Usage: The deltTcell is a relative value, which specifies the timing difference between the original timing (i.e. before calling this ASP) and the timing after calling this ASP. Example: assume the cell 1 is initially 5 chips advance of cell 2 in timing, the test case requires timing change of cell 2 being -19 chips delay with respect to cell 1 (i.e. cell 2 is 19 chips advance of cell 1 in timing) , TTCN can use this ASP with deltTcell = -24 and cellId = cell 2 to adjust the timing; later on the test case requires timing change again: cell 2 being 19 chips delay with respect to cell 1, TTCN can use this ASP with deltTcell = 38 and cellId = cell 2 to achieve the required timing difference.
Type Definition	
<pre>SEQUENCE { cellId INTEGER (0..63), deltTcell INTEGER (-128..127) }</pre>	

7.3.2.2.3b CPHY_Detect_TFCI

ASN.1 ASP Type Definition	
Type Name	CPHY_DetectTFCI_CNF
PCO Type	CSAP
Comment	To confirm to CPHY_DetetTFCI_REQ
Type Definition	
<pre>SEQUENCE { cellId INTEGER (0..63) , routingInfo RoutingInfo }</pre>	

ASN.1 ASP Type Definition	
Type Name	CPHY_DetectTFCI_REQ
PCO Type	CSAP
Comment	To set the mode of the SS for detecting whether the specified list of TFCI values occurred. Usage: At the SS initialization, the default mode is stop. When the mode is set to start, the SS shall detect whether the specified list of TFCI values (tfci_List) happens on the specified uplink physical channel. When happened the SS generates a CPHY_TFCI_Detected_IND and stop further detection. Otherwise keeps monitoring until a CPHY_DetectTFCI_REQ with mode = stop received.
Type Definition	
<pre>SEQUENCE { cellId INTEGER (0..63) , routingInfo RoutingInfo, mode ENUMERATED {start(0), stop(1)}, tfci_List TFCI_List }</pre>	

ASN.1 ASP Type Definition	
Type Name	CPHY_TFCI_Detected_IND
PCO Type	CSAP
Comment	To indicate the TFCI value specified in the CPHY_DetectTFCI_REQ has been detected.
Type Definition	
<pre>SEQUENCE { cellId INTEGER (0..63) , routingInfo RoutingInfo, tfciValue INTEGER (0..1023) }</pre>	

ASN.1 Type Definition	
Type Name	TFCI_List
Comment	
Type Definition	
SEQUENCE (SIZE (1..1024)) OF INTEGER (0..1023)	

7.3.2.2.4 CPHY_Ini

ASN.1 ASP Type Definition	
Type Name	CPHY_Ini_REQ
PCO Type	CSAP
Comment	Request to initialize the test
Type Definition	
<pre> ENUMERATED { defaultRadioEnvironment(0), nonDefaultMultiCell(1) } </pre>	

ASN.1 ASP Type Definition	
Type Name	CPHY_Ini_CNF
PCO Type	CSAP
Comment	Confirm the test initialization
Type Definition	
<pre> SEQUENCE { confirmation NULL } </pre>	

7.3.2.2.5 CPHY_Cell_TxPower_Modify

ASN.1 ASP Type Definition	
Type Name	CPHY_Cell_TxPower_Modify_CNF
PCO Type	CSAP
Comment	To confirm to change the DL power
Type Definition	
<pre> SEQUENCE { cellId INTEGER(0..63) } </pre>	

ASN.1 ASP Type Definition	
Type Name	CPHY_Cell_TxPower_Modify_REQ
PCO Type	CSAP
Comment	To request to change the DL power If the Tx attenuation level value is set to 123, the cell becomes a non-suitable off cell (CPICH_Ec ≤ -122 dBm/3.84 MHz of an off cell).
Type Definition	
<pre> SEQUENCE { cellId INTEGER(0..63), dLtxAttenuationLevel INTEGER(0..40 123) } </pre>	

7.3.2.2.6 CPHY_Frame_Number

ASN.1 ASP Type Definition	
Type Name	CPHY_Frame_Number_CNF
PCO Type	CSAP
Comment	To return the requested connection frame number. The routingInfo indicates a physical channel. The frameNumber is set to (SFN mod 256) when requested on S-CCPCH in PCH/FACH.
Type Definition	
SEQUENCE	{ cellId INTEGER(0..63), routingInfo RoutingInfo, frameNumber INTEGER(0..255) }

ASN.1 ASP Type Definition	
Type Name	CPHY_Frame_Number_REQ
PCO Type	CSAP
Comment	To request the physical layer to return a connection frame number on which the next message can be sent at the specified PCO on the specified logical channel. The return frame number shall leave time from current frame number in order to leave some execution time for TTCN preparing next message. The routingInfo indicates a physical channel
Type Definition	
SEQUENCE	{ cellId INTEGER(0..63), routingInfo RoutingInfo }

7.3.2.2.6a CPHY_SFN (Rel-6 or later)

ASN.1 ASP Type Definition	
Type Name	CPHY_SFN_CNF
PCO Type	CSAP
Comment	To return the requested system frame number of the cell. The routingInfo indicates the P-CCPCH physical channel. In MBMS the MICH Connection Frame Number (CFN) corresponds to the Cell SFN of the frame in which the start of the S-CCPCH frame is located.
Type Definition	
SEQUENCE	{ cellId INTEGER(0..63), routingInfo RoutingInfo, currentSFN INTEGER(0..4095) }

ASN.1 ASP Type Definition	
Type Name	CPHY_SFN_REQ
PCO Type	CSAP
Comment	To request the physical layer to return the current SFN of the cell. The routingInfo indicates the P-CCPCH physical channel. In MBMS the MICH Connection Frame Number (CFN) corresponds to the Cell SFN of the frame in which the start of the S-CCPCH frame is located. The timing of S-CCPCH relative to P-CCPCH can be configured as timingOffset in steps of 256 chips.
Type Definition	
SEQUENCE	{ cellId INTEGER(0..63), routingInfo RoutingInfo }

7.3.2.2.6b CPHY_MBMS_MICH_q (Rel-6 or later)

ASN.1 ASP Type Definition	
Type Name	CPHY_MBMS_MICH_q_CNF
PCO Type	CSAP
Comment	To confirm CPHY_MBMS_MICH_q_REQ. The routingInfo indicates the MICH physical channel.
Type Definition	
SEQUENCE	{ cellId INTEGER (0..63), routingInfo RoutingInfo }

ASN.1 ASP Type Definition	
Type Name	CPHY_MBMS_MICH_q_REQ
PCO Type	CSAP
Comment	To request the physical layer to transmit MBMS notification Indicators on the MICH physical channel. The transmission shall start on the SFN specified by the parameter mICHCFN and be continued for one modification period indicated by parameter modiCoefficient. The routingInfo indicates the MICH physical channel. The notification indicators to be transmitted are specified by the parameter indicatorList.
Type Definition	
SEQUENCE	{ cellId INTEGER(0..63), routingInfo RoutingInfo, mICHCFN MICH_CFN, modiPeriodCoefficient INTEGER(7..10), indicatorList MBMS_q_List }

ASN.1 Type Definition	
Type Name	MBMS_q_List
Comment	The maximum number of notification indicators per frame for the nn18 alternative is 18. The maximum number of notification indicators per frame for the nn36 alternative is 36. The maximum number of notification indicators per frame for the nn72 alternative is 72. The maximum number of notification indicators per frame for the nn144 alternative is 144.
Type Definition	
CHOICE	{ nn18 Q_List18, nn36 Q_List36, nn72 Q_List72, nn144 Q_List144 }

ASN.1 Type Definition	
Type Name	Q_List18
Comment	This type is a list which holds 128 or 256 or 512 or 1024 values of ListOf18q, each value of ListOf18q is also a list of (1..18) values of INTEGER. The first value of ListOf18q is corresponding to the MICH frame which starts the modification period, the second value of ListOf18q is corresponding to the next MICH frame in the modification period and so on, the last value of ListOf18q is corresponding to the last MICH frame of the modification period. Be noted that for different modification period configurations the number of values of ListOf18q are different and shall match the configuration. The SS sets the bits {b0, ..., b287} of the MICH frame according to the INTEGER values in the ListOf18q corresponding to the MICH frame (see 3GPP TS 25.211 [40], subclause 5.3.3.15)
Type Definition	
CHOICE	{ FRM128 SEQUENCE SIZE((128)) OF ListOf18q, FRM256 SEQUENCE SIZE((256)) OF ListOf18q, FRM512 SEQUENCE SIZE((512)) OF ListOf18q, FRM1024 SEQUENCE SIZE((1024)) OF ListOf18q }

ASN.1 Type Definition	
Type Name	ListOf18q
Comment	<p>This type holds (1..18) values of the "q" for a MICH frame which MICH CFN = the SFN of the P-CCPCH radio frame during which the start of the MICH radio frame occurs The values of q are calculated by TTCN according to formula:</p> $q = \left\lfloor \left((C \times (NI \oplus ((C \times SFN) \bmod G))) \bmod G \right) \times \frac{Nn}{G} \right\rfloor$ <p>where: $G = 2^{16}$, $C = 25033$; NI = Notification Indicator (0..65535) is computed by the TTCN for each TMGI according to the formula: $NI = (TMGI + \lfloor TMGI / G \rfloor) \bmod G$ where $G = 2^{16}$; the number of TMGI could be 1 to 18; SFN = the SFN of the P-CCPCH radio frame during which the start of the MICH radio frame occurs; Nn = the number of notification indicators per frame:</p>
Type Definition	
SEQUENCE (SIZE(1..18)) OF INTEGER (0..17)	

ASN.1 Type Definition	
Type Name	Q_List36
Comment	<p>This type is a list which holds 128 or 256 or 512 or 1024 values of ListOf36q, each value of ListOf36q is also a list of (1..36) values of INTEGER. The first value of ListOf36q is corresponding to the MICH frame which starts the modification period, the second value of ListOf36q is corresponding to the next MICH frame in the modification period and so on, the last value of ListOf36q is corresponding to the last MICH frame of the modification period. Be noted that for different modification period configurations the number of values of ListOf36q are different and shall match the configuration. The SS sets the bits {b0, ..., b287} of the MICH frame according to the INTEGER values in the ListOf36q corresponding to the MICH frame (see 3GPP TS 25.211 [40], subclause 5.3.3.15).</p>
Type Definition	
<pre>CHOICE { frm128 SEQUENCE (SIZE(128)) OF ListOf36q, frm256 SEQUENCE (SIZE(256)) OF ListOf36q, frm512 SEQUENCE (SIZE(512)) OF ListOf36q, frm1024 SEQUENCE (SIZE(1024)) OF ListOf36q }</pre>	

ASN.1 Type Definition	
Type Name	ListOf36q
Comment	<p>This type holds (1..36) values of the "q" for a frame which MICH CFN = the SFN of the P-CCPCH radio frame during which the start of the MICH radio frame occurs The values of q are calculated by TTCN according to formula:</p> $q = \left\lfloor \left((C \times (NI \oplus ((C \times SFN) \bmod G))) \bmod G \right) \times \frac{Nn}{G} \right\rfloor$ <p>where: $G = 2^{16}$, $C = 25033$; NI = Notification Indicator (0..65535) is computed by the TTCN for each TMGI according to the formula: $NI = (TMGI + \lfloor TMGI / G \rfloor) \bmod G$ where $G = 2^{16}$; the number of TMGI could be 1 to 36; SFN = the SFN of the P-CCPCH radio frame during which the start of the MICH radio frame occurs; Nn = the number of notification indicators per frame:</p>
Type Definition	
SEQUENCE (SIZE(1..36)) OF INTEGER (0..35)	

ASN.1 Type Definition	
Type Name	Q_List72
Comment	This type is a list which holds 128 or 256 or 512 or 1024 values of ListOf72q, each value of ListOf72q is also a list of (1..72) values of INTEGER. The first value of ListOf72q is corresponding to the MICH frame which starts the modification period, the second value of ListOf72q is corresponding to the next MICH frame in the modification period and so on, the last value of ListOf72q is corresponding to the last MICH frame of the modification period. Be noted that for different modification period configurations the number of values of ListOf72q are different and shall match the configuration. The SS sets the bits {b0, ..., b287} of the MICH frame according to the INTEGER values in the ListOf72q corresponding to the MICH frame (see 3GPP TS 25.211 [40], subclause 5.3.3.15).
Type Definition	
CHOICE {	
fRM128	SEQUENCE (SIZE(128)) OF ListOf72q,
fRM256	SEQUENCE (SIZE(256)) OF ListOf72q,
fRM512	SEQUENCE (SIZE(512)) OF ListOf72q,
fRM1024	SEQUENCE (SIZE(1024)) OF ListOf72q
}	

ASN.1 Type Definition	
Type Name	ListOf72q
Comment	This type holds (1..72) values of the "q" for a frame which MICH CFN = the SFN of the P-CCPCH radio frame during which the start of the MICH radio frame occurs The values of q are calculated by TTCN according to formula: $q = \left\lfloor \left((C \times (NI \oplus ((C \times SFN) \bmod G))) \bmod G \right) \times \frac{Nn}{G} \right\rfloor$ <p>where: $G = 2^{16}$, $C = 25033$; NI = Notification Indicator (0..65535) is computed by the TTCN for each TMGI according to the formula: $NI = (TMGI + \lfloor TMGI / G \rfloor) \bmod G$ where $G = 2^{16}$; the number of TMGI could be 1 to 72; SFN = the SFN of the P-CCPCH radio frame during which the start of the MICH radio frame occurs; Nn = the number of notification indicators per frame:</p>
Type Definition	
SEQUENCE (SIZE(1..72)) OF INTEGER (0..71)	

ASN.1 Type Definition	
Type Name	Q_List144
Comment	This type is a list which holds 128 or 256 or 512 or 1024 values of ListOf144q, each value of ListOf144q is also a list of (1..144) values of INTEGER. The first value of ListOf144q is corresponding to the MICH frame which starts the modification period, the second value of ListOf144q is corresponding to the next MICH frame in the modification period and so on, the last value of ListOf144q is corresponding to the last MICH frame of the modification period. Be noted that for different modification period configurations the number of values of ListOf144q are different and shall match the configuration. The SS sets the bits {b0, ..., b287} of the MICH frame according to the INTEGER values in the ListOf144q corresponding to the MICH frame (see 3GPP TS 25.211 [40], subclause 5.3.3.15).
Type Definition	
CHOICE {	
fRM128	SEQUENCE (SIZE(128)) OF ListOf144q,
fRM256	SEQUENCE (SIZE(256)) OF ListOf144q,
fRM512	SEQUENCE (SIZE(512)) OF ListOf144q,
fRM1024	SEQUENCE (SIZE(1024)) OF ListOf144q
}	

ASN.1 Type Definition	
Type Name	ListOf144q
Comment	<p>This type holds (1..144) values of the "q" for a frame which MICH CFN = the SFN of the P-CCPCH radio frame during which the start of the MICH radio frame occurs. The values of q are calculated by TTCN according to formula:</p> $q = \left\lfloor \left((C \times (NI \oplus ((C \times SFN) \bmod G))) \bmod G \right) \times \frac{Nn}{G} \right\rfloor$ <p>where: $G = 2^{16}$, $C = 25033$; NI = Notification Indicator (0..65535) is computed by the TTCN for each TMGI according to the formula: $NI = (TMGI + \lfloor TMGI / G \rfloor) \bmod G$ where $G = 2^{16}$; the number of <i>TMGI</i> could be 1 to 144; SFN = the SFN of the P-CCPCH radio frame during which the start of the MICH radio frame occurs; Nn = the number of notification indicators per frame:</p>
Type Definition	
SEQUENCE (SIZE(1..144)) OF INTEGER (0..143)	

ASN.1 Type Definition	
Type Name	MICH_CFN
Comment	Subclause 9.2.1.46a of 3GPP TS 25.433 [57]
Type Definition	
INTEGER (0..4095)	

7.3.2.2.6c CPHY_MBMS_NI (Rel-6 or later)

ASN.1 ASP Type Definition	
Type Name	CPHY_MBMS_NI_CNF
PCO Type	CSAP
Comment	To confirm CPHY_MBMS_NI_REQ. The routingInfo indicates the MICH physical channel.
Type Definition	
<pre>SEQUENCE { cellId INTEGER(0..63), routingInfo RoutingInfo }</pre>	

ASN.1 ASP Type Definition	
Type Name	CPHY_MBMS_NI_REQ
PCO Type	CSAP
Comment	<p>To request the physical layer to transmit MBMS Notification Indicators on the MICH physical channel. The transmission shall start on the SFN specified by the parameter startingTime and be continued for one modification period indicated by parameter modiPeriodCoefficient. The routingInfo indicates the MICH physical channel. The notification indicators to be transmitted are specified by the parameter indicatorList.</p> <p>If value of invert is TRUE, all notification indicators Nq are set to "0" and all other indicators are set to "1".</p>
Type Definition	
<pre>SEQUENCE { cellId INTEGER(0..63), routingInfo RoutingInfo, startingTime MICH_CFN, modiPeriodCoefficient INTEGER(7..10), nIList MBMSIndicatorList, invert BOOLEAN DEFAULT FALSE }</pre>	

ASN.1 Type Definition	
Type Name	MBMSIndicatorList
Comment	<p>The TTCN calculates Notification Indicator (NI, 0..65535) for each TMGI according to the formula:</p> $NI = (TMGI + \lfloor TMGI / G \rfloor) \bmod G$ <p>where $G = 2^{16}$ and sends these NI to the SS by the MBMSIndicatorList;</p> <p>The SS shall calculate the q values for every MICH frame of a modification period according to formula:</p> $q = \left\lfloor \left((C \times (NI \oplus ((C \times SFN) \bmod G))) \bmod G \right) \times \frac{Nn}{G} \right\rfloor$ <p>where: $G = 2^{16}$, $C = 25033$; SFN = the SFN of the P-CCPCH radio frame during which the start of the MICH radio frame occurs; Nn = the number of notification indicators per frame: Then the SS sets the bits {b0, ..., b287} of the MICH frame according to the calculated q values which corresponds to the MICH frame (see 3GPP TS 25.211 [40], subclause 5.3.3.15).</p>
Type Definition	
<pre>CHOICE { nn18 SEQUENCE (SIZE(1..18)) OF SEQUENCE { nI INTEGER (0..65535)}, nn36 SEQUENCE (SIZE(1..36)) OF SEQUENCE { nI INTEGER (0.. 65535)}, nn72 SEQUENCE (SIZE(1..72)) OF SEQUENCE { nI INTEGER (0.. 65535)}, nn144 SEQUENCE (SIZE(1..144)) OF SEQUENCE { nI INTEGER (0.. 65535)} }</pre>	

7.3.2.2.7 CPHY_Out_of_Sync

ASN.1 ASP Type Definition	
Type Name	CPHY_Out_of_Sync_IND
PCO Type	CSAP
Comment	To report that the physical channel synchronization (in FDD mode, sync with uplink DPCCH) was lost as detected by the SS receiver.
Type Definition	
<pre>SEQUENCE { cellId INTEGER(0..63), routingInfo RoutingInfo }</pre>	

7.3.2.2.8 CPHY_PRACH_Measurement

ASN.1 ASP Type Definition	
Type Name	CPHY_PRACH_Measurement_CNF
PCO Type	CSAP
Comment	To Confirm PRACH Measurement Req
Type Definition	
<pre>SEQUENCE { cellId INTEGER(0..63), routingInfo RoutingInfo }</pre>	

ASN.1 ASP Type Definition	
Type Name	CPHY_PRACH_Measurement_REQ
PCO Type	CSAP
Comment	To request for Start or Stop of PRACH Measurements to be done every PRACH PREAMBLE or MESSAGE received. If reportSFN is set to TRUE, SS shall report in the IE PRACH_MeasurementReport the SFN value at which the event is received.
Type Definition	
SEQUENCE	{ cellId INTEGER(0..63), routingInfo RoutingInfo, ratType RatType, pRACH_MeasurementInd PRACH_MeasurementInd, reportSFN BOOLEAN DEFAULT FALSE -- Rel-8 or later }

ASN.1 Type Definition	
Type Name	PRACH_MeasurementInd
Comment	1) StartMeas: The SS shall start the sending PRACH parameters Measurement report on CPHY PCO, for each PRACH Preamble or MESSAGE received from the UE by primitive CPHY_PRACH_Measurement_Report_IND on CPHY PCO. 2) StopMeas: The SS shall stop sending of PRACH parameters Measurement report on CPHY PCO, for each PRACH Preamble or MESSAGE received from the UE by primitive CPHY_PRACH_Measurement_Report_IND on CPHY PCO.
Type Definition	
ENUMERATED	{ startMeas (0), stopMeas (1) }

ASN.1 ASP Type Definition	
Type Name	CPHY_PRACH_Measurement_Report_IND
PCO Type	CSAP
Comment	SS indicates a PRACH parameters measurement report for each PRACH Preambles or MESSAGE received from the UE
Type Definition	
SEQUENCE	{ cellId INTEGER(0..63), routingInfo RoutingInfo, ratType RatType, measurementReport PRACH_MeasurementReport }

ASN.1 Type Definition	
Type Name	PRACH_MeasurementReport
Comment	sfn is included if reportSFN is TRUE in CPHY_PRACH_Measurement_REQ.
Type Definition	
SEQUENCE	{ usedPRACH_AccessSlot INTEGER (0..14), usedPRACH_Signature INTEGER (0..15) OPTIONAL, sfn INTEGER (0..4095) OPTIONAL -- Rel-8 or later }

7.3.2.2.9 CPHY_RL_Modify

ASN.1 ASP Type Definition	
Type Name	CPHY_RL_Modify_CNF
PCO Type	CSAP
Comment	To confirm to modify the Radio Link
Type Definition	
SEQUENCE	{ cellId INTEGER(0..63), routingInfo RoutingInfo }

ASN.1 ASP Type Definition	
Type Name	CPHY_RL_Modify_REQ
PCO Type	CSAP
Comment	To request to modify the Radio Link HardHandover (PhysicalChannelReconfig) ChannelizationCodeChange FrequencyChange PhysicalChannelModifyForTrCHReconfig CompressedMode(PhysicalChannelReconfig) Re_Synchronized HardHandover SoftHandover
Type Definition	
SEQUENCE	{ cellId INTEGER(0..63), routingInfo RoutingInfo, ratType RatType, modifyMessage CphyRlModifyReq }

ASN.1 Type Definition	
Type Name	CphyRlModifyReq
Comment	
Type Definition	
SEQUENCE	{ activationTime SS_ActivationTime, physicalChannelInfo CHOICE { dpch_CompressedModeStatusInfo Dpch_CompressedModeStatusInfo, secondaryCCPCHInfo SecondaryCCPCHInfo, pRACHInfo PRACHInfo, dPCHInfo DPCHInfo, dPCHInfo_r5 DPCHInfo_r5OrLater, -- Rel-5 or later hs_PDSCHInfo HS_PDSCHInfo_r5OrLater, -- Rel-5 or later e_DPCHInfo SS_E_DPCH_Info_r6OrLater, -- Rel-6 or later e_AGCHInfo SS_E_AGCH_Info, -- Rel-6 or later e_HICHInfo SS_E_HICH_Info, -- Rel-6 or later e_RGCHInfo SS_E_RGCH_Info, -- Rel-6 or later mBMS_MICHInfo SS_MBMS_MICHConfigurationInfo_r6, -- Rel-6 or later aICHInfo AICHInfo }, trchConfigToFollow BOOLEAN DEFAULT TRUE }

ASN.1 Type Definition	
Type Name	SS_ActivationTime
Comment	
Type Definition	
CHOICE	{ activationCFN ActivationTime, activateNow NULL }

7.3.2.2.10 CPHY_RL_Release

ASN.1 ASP Type Definition	
Type Name	CPHY_RL_Release_CNF
PCO Type	CSAP
Comment	PHY emulator confirms that a specified physical channel has been released.
Type Definition	
SEQUENCE	{ cellId INTEGER(0..63), routingInfo RoutingInfo }

ASN.1 ASP Type Definition	
Type Name	CPHY_RL_Release_REQ
PCO Type	CSAP
Comment	To request to release the Radio Link
Type Definition	
SEQUENCE	{
cellId	INTEGER(0..63),
routingInfo	RoutingInfo,
activationTime	SS_ActivationTime
}	

7.3.2.2.11 CPHY_RL_Setup

ASN.1 ASP Type Definition	
Type Name	CPHY_RL_Setup_CNF
PCO Type	CSAP
Comment	To confirm to setup the Radio Link
Type Definition	
SEQUENCE	{
cellId	INTEGER(0..63),
routingInfo	RoutingInfo
}	

ASN.1 ASP Type Definition	
Type Name	CPHY_RL_Setup_REQ
PCO Type	CSAP
Comment	To request to setup the associated transport channels and the Radio Link itself.
Type Definition	
SEQUENCE	{
cellId	INTEGER(0..63),
routingInfo	RoutingInfo,
ratType	RatType,
setupMessage	CphyRlSetupReq
}	

ASN.1 Type Definition	
Type Name	CphyRlSetupReq
Comment	To request to setup the Radio Link
Type Definition	
SEQUENCE	{
physicalChannelInfo	CHOICE {
primaryCPICHInfo	PrimaryCPICHInfo,
secondaryCPICHInfo	SecondaryCPICHInfo,
primarySCHInfo	PrimarySCHInfo,
secondarySCHInfo	SecondarySCHInfo,
primaryCCPCHInfo	PrimaryCCPCHInfo,
secondaryCCPCHInfo	SecondaryCCPCHInfo,
pRACHInfo	PRACHInfo,
pICHInfo	PICHInfo,
aICHInfo	AICHInfo,
dPCHInfo	DPCHInfo,
pDSCHInfo	PDSCHInfo,
dPCHInfo_r5	DPCHInfo_r5OrLater, -- Rel-5 or later
hs_PDSCHInfo	HS_PDSCHInfo_r5OrLater, -- Rel-5 or later
e_DPCHInfo	SS_E_DPCH_Info_r6OrLater, -- Rel-6 or later
e_AGCHInfo	SS_E_AGCH_Info, -- Rel-6 or later
e_HICHInfo	SS_E_HICH_Info, -- Rel-6 or later
e_RGCHInfo	SS_E_RGCH_Info, -- Rel-6 or later
mBMS_MICHInfo	SS_MBMS_MICHConfigurationInfo_r6
	-- Rel-6 or later
},	
activationTime	SS_ActivationTime,
trchConfigToFollow	BOOLEAN DEFAULT TRUE
}	

ASN.1 Type Definition	
Type Name	PrimaryCPICHInfo
Comment	mimoAntenna2CPICH indicates if MIMO is either not configured or configured with a P-CPICH or with an S-CPICH on the MIMO antenna2 (see figure 7 of 3GPP TS 25.214 [12], clause 9). dC_SecondaryServingCell indicates if the cell is configured as secondary HS-DSCH serving cell, without other common channel than P-CPICH. MIMO and DC-HSDPA do not co-exist.
Type Definition	
<pre>SEQUENCE { dl_TxPower_PCPICH DL_TxPower_PCPICH, tx_diversityIndicator BOOLEAN, mimoAntenna2CPICH MimoAntennaConfigType DEFAULT noMimo, -- Rel-7 or later dC_SecondaryServingCell BOOLEAN DEFAULT FALSE -- Rel-8 or later }</pre>	

ASN.1 Type Definition	
Type Name	SecondaryCPICHInfo
Comment	The channel can be configured for the MIMO antenna2. The value antenna2pCPICH is not applicable.
Type Definition	
<pre>SEQUENCE { scramblingCode INTEGER(0..15), dl_ChannelizationCode SF512_AndCodeNumber, dl_TxPower DL_TxPower, mimoAntenna MimoAntennaConfigType DEFAULT noMimo -- Rel-7 or later }</pre>	

ASN.1 Type Definition	
Type Name	MimoAntennaConfigType
Comment	Rel-7 or later
Type Definition	
<pre>ENUMERATED {noMimo(0), antenna2pCPICH(1), antenna2sCPICH(2), spare(3)}</pre>	

ASN.1 Type Definition	
Type Name	PrimarySCHInfo
Comment	
Type Definition	
<pre>SEQUENCE { tstIndicator BOOLEAN, dl_TxPower DL_TxPower }</pre>	

ASN.1 Type Definition	
Type Name	SecondarySCHInfo
Comment	
Type Definition	
<pre>SEQUENCE { tstIndicator BOOLEAN, dl_TxPower DL_TxPower }</pre>	

ASN.1 Type Definition	
Type Name	PrimaryCCPCHInfo
Comment	
Type Definition	
<pre>SEQUENCE { sttd_Indicator BOOLEAN, dl_TxPower DL_TxPower }</pre>	

ASN.1 Type Definition	
Type Name	SecondaryCCPCHInfo
Comment	The range for powerOffsetOfTFICI_PO1 and powerOffsetOfPILOT_PO3 is 0 dB to 6 dB, 0.25 dB per step. mbms_softCombTimingOffset is present when L1-combination applies When configuring SCCPCH for MBMS "positionFixedOrFlexible" shall be set to Flexible, and sCCPCHSlotFormat shall be chosen to the one without pilot bits
Type Definition	
<pre>SEQUENCE { scramblingCode INTEGER (0..15), dl_ChannelizationCode SF256_AndCodeNumber, sCCPCHSlotFormat SCCPCHSlotFormat, timingOffset INTEGER (0..149), positionFixedOrFlexible PositionFixedOrFlexible, sttd_Indicator BOOLEAN, dl_TxPower DL_TxPower, powerOffsetOfTFICI_PO1 INTEGER (0..24), powerOffsetOfPILOT_PO3 INTEGER (0..24), mbms_softCombTimingOffset MBMS_SoftComb_TimingOffset OPTIONAL --Rel-6 or later }</pre>	

ASN.1 Type Definition	
Type Name	PRACHInfo
Comment	
Type Definition	
<pre>SEQUENCE { fdd_tdd CHOICE { fdd SEQUENCE { preambleSignature AvailableSignatures, spreadingFactorForDataPart SF_PRACH, preambleScramblingCode PreambleScramblingCodeWordNumber, puncturingLimit PuncturingLimit, accessSlot AvailableSubChannelNumbers }, tdd SEQUENCE { -- timeSlot TimeSlot, -- spreadingCode SpreadingCode, -- midambleCode MidambleCode }, fdd_prachForEnhUL -- Rel-8 or later SEQUENCE{ preambleSignature AvailableSignatures, preambleScramblingCode PreambleScramblingCodeWordNumber, puncturingLimit PuncturingLimit, accessSlot AvailableSubChannelNumbers } } }</pre>	

ASN.1 Type Definition	
Type Name	PICHInfo
Comment	When the PICH is associated to the HS-SCCH , sccpchId_associated is set to 32 (Rel-7 or later).
Type Definition	
<pre>SEQUENCE { pichinfo PICH_Info, dl_TxPower PICH_PowerOffset, sccpchId_associated INTEGER (0..32) -- Value 32 used in Rel-7 or later }</pre>	

ASN.1 Type Definition	
Type Name	AICHInfo
Comment	When e_AI_Info is present, the Extended Acquisition Indicators is transmitted on AICH.
Type Definition	
SEQUENCE	{ aichinfo AICH_Info, dl_TxPower AICH_PowerOffset, e_AI_Info E_AI_InfoType OPTIONAL -- Rel-8 or later }

ASN.1 Type Definition	
Type Name	DPCHInfo
Comment	At least one of the fields shall be present.
Type Definition	
SEQUENCE	{ ul_DPCHInfo UL_DPCH_Info OPTIONAL, dl_DPCHInfo DL_DPCHInfo OPTIONAL }

ASN.1 Type Definition	
Type Name	DL_DPCHInfo
Comment	
Type Definition	
SEQUENCE	{ dl_CommonInformation DL_CommonInformation, dl_DPCH_InfoPerRL DL_DPCH_InfoPerRL, rl_Information RL_Information }

ASN.1 Type Definition	
Type Name	HS_DPCCHInfo
Comment	mimoStatus represents status of MIMO and shall be set only if mimo_Parameters are provided in HS-PDSCH configuration
Type Definition	
SEQUENCE	{ cqi_RepetitionFactor CQI_RepetitionFactor, ackNackRepetitionFactor ACK_NACK_repetitionFactor, mimoStatus BOOLEAN DEFAULT FALSE -- Rel-7 or later }

ASN.1 Type Definition	
Type Name	HS_DPCCHInfo_r8
Comment	mimoStatus represents status of MIMO and shall be set only if mimo_Parameters are provided in HS-PDSCH configuration. secondaryServing_HS_DSCH_Cell indicates if the HS-DSCH secondary serving cell is activated (see 3GPP TS 25.214 [12], clause 6A.1)
Type Definition	
SEQUENCE	{ cqi_RepetitionFactor CQI_RepetitionFactor, ackNackRepetitionFactor ACK_NACK_repetitionFactor, mimoStatus BOOLEAN DEFAULT FALSE, secondaryServing_HS_DSCH_Cell ENUMERATED { deactivated (0), activated (1) } DEFAULT deactivated -- Rel-8 or later }

ASN.1 Type Definition	
Type Name	DL_DPCHInfo_r5
Comment	Applicable Rel-5 or later
Type Definition	
SEQUENCE	{
dl_CommonInformation	DL_CommonInformation_r5,
dl_DPCH_InfoPerRL	DL_DPCH_InfoPerRL_r5,
rl_Information	RL_Information
	}

ASN.1 Type Definition	
Type Name	DL_TxPower_PCPICH
Comment	Absolute Tx Power of PCPICH
Type Definition	
INTEGER	(-60..-30)

ASN.1 Type Definition	
Type Name	DL_TxPower
Comment	Downlink Tx Power relative to PCPICH
Type Definition	
INTEGER	(-35..+15)

ASN.1 Type Definition	
Type Name	SCCPCHSlotFormat
Comment	Reference to 3GPP TS25.211 [40]
Type Definition	
INTEGER	(0..17)

ASN.1 Type Definition	
Type Name	PDSCHInfo
Comment	
Type Definition	
SEQUENCE	{
fdd_tdd	CHOICE {
fdd	SEQUENCE {
pdsch_CodeMapping	PDSCH_CodeMapping
tdd	SEQUENCE {
--pdsch_Identity	PDSCH_Identity,
--pdsch_Info	PDSCH_Info,
--pdsch_PowerControlInfo	PDSCH_PowerControlInfo OPTIONAL
dl_TxPower	DL_TxPower
	}
	}

ASN.1 Type Definition	
Type Name	DPCHInfo_r5OrLater
Comment	<p>Applicable Rel-5 or later</p> <p>At least one of the first two fields ul_DPCHInfo or dl_DPCHInfo shall be present. Presence of hs_DPCCHInd means that the HS-DPCCH shall be configured in the uplink DPCH. If hs_DPCCHInd is absent no HS-DPCCH shall be configured in the uplink DPCH, or the configured HS-DPCCH shall be removed in the modify ASP. In the active set which has radio links from more than one cell the HS-DPCCH is configured only in the HS-DSCH serving cell.</p> <p>Three combinations are valid: ul_DPCH_Info only, dl_DPCHInfo only and ul_DPCH_Info + hs_DPCCHInd.</p> <p>Presence of ss_UL_DPCCH_DRX_Info if UL DPCH being configured and presence of ss_DRX_Info if DL F-DPCH being configured indicates that UL_DTX is enabled.</p> <p>ss_DRX_Info is provided as F-DPCH TPC commands need not be transmitted during gaps due to UL-DPCCH DTX (3GPP TS 25.214 [12], subclause 5.1.2.2.1).</p> <p>ul_DPCH_TimingOffset is the timing offset relative to P-CCPCH, it is provided in Rel-7 only when Enhanced Cell FACH Downlink (common_HS_PDSCH_Info) is configured.</p>
Type Definition	
CHOICE {	
r5 SEQUENCE {	
ul_DPCHInfo	UL_DPCH_Info_r5 OPTIONAL,
dl_DPCHInfo	DL_DPCHInfo_r5 OPTIONAL,
hs_DPCCHInd	HS_DPCCHInfo OPTIONAL
},	
r6 SEQUENCE {	
ul_DPCHInfo	UL_DPCH_Info_r6 OPTIONAL,
dl_DPCHInfo	DL_DPCHInfo_r6 OPTIONAL,
hs_DPCCHInd	HS_DPCCHInfo OPTIONAL
},	
r7 SEQUENCE{	
ul_DPCHInfo	UL_DPCH_Info_r7 OPTIONAL,
ul_DPCH_TimingOffset	INTEGER (0..38399) OPTIONAL,
-- timing offset relative to P-CCPCH	
-- applicable to Rel-7 when Enhanced Cell FACH DL is configured	
dl_DPCHInfo	DL_DPCHInfo_r7 OPTIONAL,
hs_DPCCHInd	HS_DPCCHInfo OPTIONAL,
ss_UL_DPCCH_DRX_Info	SS_UL_DPCCH_DRX_Info OPTIONAL,
ss_DRX_Info	DTX_Info OPTIONAL
},	
r8 SEQUENCE{	
ul_DPCHInfo	UL_DPCH_Info_r7 OPTIONAL,
dl_DPCHInfo	DL_DPCHInfo_r8 OPTIONAL,
hs_DPCCHInd	HS_DPCCHInfo_r8 OPTIONAL,
ss_UL_DPCCH_DRX_Info	SS_UL_DPCCH_DRX_Info OPTIONAL,
ss_DRX_Info	DTX_Info OPTIONAL
},	
r10 SEQUENCE{	
ul_DPCHInfo	UL_DPCH_Info_r7 OPTIONAL,
dl_DPCHInfo	DL_DPCHInfo_r10 OPTIONAL,
hs_DPCCHInd	HS_DPCCHInfo_r8 OPTIONAL,
ss_UL_DPCCH_DRX_Info	SS_UL_DPCCH_DRX_Info OPTIONAL,
ss_DRX_Info	DTX_Info OPTIONAL
},	
spare2 SEQUENCE {	
}	

ASN.1 Type Definition	
Type Name	DL_DPCHInfo_r6
Comment	Applicable Rel-6 For SS reconfiguration from DL-DPCH to F-DPCH and vice versa the dl_CommonInformation shall include the defaultDPCH_OffsetValue as additional information for SS even when this is not included in the corresponding RRC message sent to the UE and the timing is maintained.
Type Definition	
SEQUENCE	{
dl_CommonInformation	DL_CommonInformation_r6,
dl_Dpch_InfoPerRL	CHOICE {
dl_DPCH_InfoPerRL	DL_DPCH_InfoPerRL_r6,
dl_FDPCH_InfoPerRL	DL_FDPCH_InfoPerRL_r6
},	
rl_Information	RL_Information
}	

ASN.1 Type Definition	
Type Name	DL_DPCHInfo_r7
Comment	Applicable Rel-7 or later
Type Definition	
SEQUENCE	{
dl_CommonInformation	DL_CommonInformation_r7,
dl_Dpch_InfoPerRL	CHOICE {
dl_DPCH_InfoPerRL	DL_DPCH_InfoPerRL_r7,
dl_FDPCH_InfoPerRL	DL_FDPCH_InfoPerRL_r7
},	
rl_Information	RL_Information
}	

ASN.1 Type Definition	
Type Name	DL_DPCHInfo_r8
Comment	Applicable Rel-8 or later
Type Definition	
CHOICE	{
r8 SEQUENCE	{
dl_CommonInformation	DL_CommonInformation_r8,
dl_Dpch_InfoPerRL	CHOICE {
dl_DPCH_InfoPerRL	DL_DPCH_InfoPerRL_r7,
dl_FDPCH_InfoPerRL	DL_FDPCH_InfoPerRL_r7
},	
rl_Information	RL_Information
},	
spare1 NULL	
}	

ASN.1 Type Definition	
Type Name	DL_DPCHInfo_r10
Comment	Applicable Rel-10 or later
Type Definition	
SEQUENCE	{
dl_CommonInformation	DL_CommonInformation_r10,
dl_Dpch_InfoPerRL	CHOICE {
dl_DPCH_InfoPerRL	DL_DPCH_InfoPerRL_r7,
dl_FDPCH_InfoPerRL	DL_FDPCH_InfoPerRL_r7
},	
rl_Information	RL_Information
}	

ASN.1 Type Definition	
Type Name	SS_UL_DPCCH_DRX_Info
Comment	
Type Definition	
SEQUENCE	{
ss_DRX_Info	DTX_Info OPTIONAL,
dtx_DRX_timingInfo	DTX_DRX_TimingInfo_r7 OPTIONAL,
uplink_DPCCHSlotFormatInformation	Uplink_DPCCH_Slot_Format_Information
}	

ASN.1 Type Definition	
Type Name	HS_PDSCHInfo_r5OrLater
Comment	<p>Applicable Rel-5 or later</p> <p>When CHY_RL_Setup_REQ is called with CHOICE of hS_PDSCHInfo HS_PDSCH and HS-SCCH shall be configured in SS.</p> <p>The following HS-DSCH related parameters are passed to the SS implicitly by HSDSCH_physical_layer_category:</p> <ul style="list-style-type: none"> - Maximum number of HS-DSCH codes can be received by UE. - Minimum inter-TTI interval. - Maximum number of bits of an HS-DSCH transport block within an HS-DSCH TTI. - Total number of soft channel bits". <p>HSDSCH_physical_Layer_category is also used for interpretation of the meaning of CQI value.</p> <p>If hs_DPCCHToFollow is FALSE, the hs_DPCCHInd IE shall not be present when ul_DPCHInfo is configured or reconfigured.</p>
Type Definition	
<pre> CHOICE { r5 SEQUENCE { hSDSCHPhysicalLayerCategory HSDSCH_physical_layer_category, h_RNTI H_RNTI, dlHSPDSCHInformation DL_HSPDSCH_Information, sttd_Indicator BOOLEAN, hs_SCCH_TxPower DL_TxPower, -- offset related to CPICH hs_DPCCHToFollow BOOLEAN DEFAULT TRUE }, r6 SEQUENCE { hSDSCHPhysicalLayerCategory HSDSCH_physical_layer_category, h_RNTI H_RNTI, dlHSPDSCHInformation DL_HSPDSCH_Information_r6, sttd_Indicator BOOLEAN, hs_SCCH_TxPower DL_TxPower, -- offset related to CPICH hs_DPCCHToFollow BOOLEAN DEFAULT TRUE }, r7 HS_PDSCHInfo_r7, r8 HS_PDSCHInfo_r8, r9 HS_PDSCHInfo_r9 } </pre>	

ASN.1 Type Definition	
Type Name	HS_PDSCHInfo_r7
Comment	<p>Rel-7 or later.</p> <p>Choice of hS_PDSCH_Info will be used for configuring HSD-DSCH with 64QAM and/or CPC.</p> <p>Choice of common_HS_PDSCH_Info will be used for Enhanced Cell_FACH. commonOrDedicated_H_RNTI indicates, the H-RNTI that will be used by UE (either dedicated H-RNTI if provided in RRC message, or selected common H-RNTI transmitted in SIB5).</p> <p>The transmission of BCCH on HS-DSCH is performed by using BCCH specific H-RNTI on the first indexed HS-SCCH code indicated in system information broadcast.</p> <p>Presence of ss_DTX_Info makes DL DRX to be enabled.</p> <p>Presence of hs_scch_LessInfo makes HS-SCCH less operation enabled.</p> <p>Presence of mimo_Parameters indicate MIMO is to be started.</p> <p>MIMO and HS-SCCH less operation do not co-exist. MIMO is not applicable for non DCH states.</p> <p>The two IE "hSDSCHPhysicalLayerCategory" and "hdsch_physical_layer_category_ext" are mutually exclusive. One of the IE shall be present in the SS configuration. The IE "hdsch_physical_layer_category_ext" is present when MAC-ehs is configured.</p> <p>If commonOrDedicated_H_RNTI is omitted, HS-SCCHless is to be applied.</p> <p>If hs_DPCCHToFollow is FALSE, the hs_DPCCHInd IE shall not be present when ul_DPCHInfo is configured or reconfigured. In common_HS_PDSCH_Info, hs_DPCCHToFollow is set to FALSE unless HS-DPCCH is required in specific configuration.</p>
Type Definition	
<pre> CHOICE { hS_PDSCH_Info SEQUENCE { hSDSCHPhysicalLayerCategory HSDSCH_physical_layer_category OPTIONAL, hdsch_physical_layer_category_ext HSDSCH_physical_layer_category_ext OPTIONAL, h_RNTI H_RNTI, dlHSPDSCHInformation DL_HSPDSCH_Information_r7, sttd_Indicator BOOLEAN, hs_SCCH_TxPower DL_TxPower, -- offset related to CPICH ss_DTX_Info DRX_Info OPTIONAL, hs_scch_LessInfo HS_SCCH_LessInfo_r7 OPTIONAL, mimo_Parameters MIMO_Parameters_r7 OPTIONAL, hs_DPCCHToFollow BOOLEAN DEFAULT TRUE, hs_SCCH_SttdIndicator BOOLEAN DEFAULT FALSE }, common_HS_PDSCH_Info SEQUENCE { hdsch_physical_layer_category_ext HSDSCH_physical_layer_category_ext, commonOrDedicated_H_RNTI H_RNTI OPTIONAL, bcchSpecific_H_RNTI H_RNTI, hs_scch_SystemInfo HS_SCCH_SystemInfo, hs_dsch_PagingSystemInformation HS_DSCH_PagingSystemInformation OPTIONAL, sttd_Indicator BOOLEAN, hs_SCCH_TxPower DL_TxPower, -- offset related to CPICH hs_DPCCHToFollow BOOLEAN DEFAULT TRUE }, spare2 SEQUENCE {}, spare3 SEQUENCE {} } </pre>	

ASN.1 Type Definition	
Type Name	HS_PDSCHInfo_r8
Comment	<p>Rel-8 or later.</p> <p>Choice of hs_PDSCH_Info will be used for configuring HSD-DSCH with 64QAM and/or CPC.</p> <p>Choice of common_HS_PDSCH_Info will be used for Enhanced Cell_FACH. commonOrDedicated_H_RNTI indicates, the H-RNTI that will be used by UE (either dedicated H-RNTI if provided in RRC message, or selected common H-RNTI transmitted in SIB5).</p> <p>The transmission of BCCH on HS-DSCH is performed by using BCCH specific H-RNTI on the first indexed HS-SCCH code indicated in system information broadcast.</p> <p>Presence of ss_DTX_Info makes DL DRX to be enabled.</p> <p>Presence of hs_scch_LessInfo makes HS-SCCH less operation enabled.</p> <p>Presence of mimo_Parameters indicate MIMO is to be started.</p> <p>MIMO and HS-SCCH less operation do not co-exist. MIMO is not applicable for non DCH states.</p> <p>The three IE "hSDSCHPhysicalLayerCategory", "hdsch_physical_layer_category_ext" and "hdsch_physical_layer_category_ext2" are mutually exclusive. One of the IE shall be present in the SS configuration. The IE "hdsch_physical_layer_category_ext2" is present when DC-HSDPA is configured.</p> <p>If commonOrDedicated_H_RNTI is omitted, HS-SCCHless is to be applied.</p> <p>If hs_DPCCHToFollow is FALSE, the hs_DPCCHInd IE shall not be present when ul_DPCHInfo is configured or reconfigured.</p> <p>Presence of ss_HS_DSCH_DtxCellFach makes HS-DSCH DRX operation enabled and SS shall transmit any requested HS-SCCH and HS-DSCH only in occasions when UE will be listening.</p>
Type Definition	
	<pre> CHOICE { hs_PDSCH_Info SEQUENCE { hSDSCHPhysicalLayerCategory HSDSCH_physical_layer_category OPTIONAL, hdsch_physical_layer_category_ext HSDSCH_physical_layer_category_ext OPTIONAL, hdsch_physical_layer_category_ext2 HSDSCH_physical_layer_category_ext2 OPTIONAL, h_RNTI H_RNTI, dlHSPDSCHInformation DL_HSPDSCH_Information_r8, sttd_Indicator BOOLEAN, hs_SCCH_TxPower DL_TxPower, -- offset related to CPICH ss_DTX_Info DRX_Info OPTIONAL, hs_scch_LessInfo HS_SCCH_LessInfo_r7 OPTIONAL, mimo_Parameters MIMO_Parameters_r8 OPTIONAL, hs_DPCCHToFollow BOOLEAN DEFAULT TRUE, hs_SCCH_StdIndicator BOOLEAN DEFAULT FALSE }, common_HS_PDSCH_Info SEQUENCE { hdsch_physical_layer_category_ext HSDSCH_physical_layer_category_ext, commonOrDedicated_H_RNTI H_RNTI OPTIONAL, bcchSpecific_H_RNTI H_RNTI, hs_scch_SystemInfo HS_SCCH_SystemInfo, hs_dsch_PagingSystemInformation HS_DSCH_PagingSystemInformation OPTIONAL, sttd_Indicator BOOLEAN, hs_SCCH_TxPower DL_TxPower, -- offset related to CPICH hs_DPCCHToFollow BOOLEAN DEFAULT TRUE, ss_HS_DSCH_DtxCellFach HS_DSCH_DrxCellfach_info OPTIONAL }, spare2 SEQUENCE {}, spare3 SEQUENCE {} } </pre>

ASN.1 Type Definition	
Type Name	HS_PDSCHInfo_r9
Comment	<p>Rel-9 or later.</p> <p>Choice of hS_PDSCH_Info will be used for configuring HSD-DSCH with 64QAM and/or CPC.</p> <p>Choice of common_HS_PDSCH_Info will be used for Enhanced Cell_FACH. commonOrDedicated_H_RNTI indicates, the H-RNTI that will be used by UE (either dedicated H-RNTI if provided in RRC message, or selected common H-RNTI transmitted in SIB5).</p> <p>The transmission of BCCH on HS-DSCH is performed by using BCCH specific H-RNTI on the first indexed HS-SCCH code indicated in system information broadcast.</p> <p>Presence of ss_DTX_Info makes DL DRX to be enabled.</p> <p>Presence of hs_scch_LessInfo makes HS-SCCH less operation enabled.</p> <p>Presence of mimo_Parameters indicate MIMO is to be started.</p> <p>MIMO and HS-SCCH less operation do not co-exist. MIMO is not applicable for non DCH states.</p> <p>The IEs "hSDSCHPhysicalLayerCategory", "hdsch_physical_layer_category_ext", "hdsch_physical_layer_category_ext2" and "hdsch_physical_layer_category_ext3" are mutually exclusive. One of the IE shall be present in the SS configuration. The IE "hdsch_physical_layer_category_ext2" is present when DC-HSDPA is configured. The IE "hdsch_physical_layer_category_ext3" is present when DC-HSDPA with MIMO is configured.</p> <p>If commonOrDedicated_H_RNTI is omitted, HS-SCCHless is to be applied.</p> <p>If hs_DPCCHToFollow is FALSE, the hs_DPCCHInd IE shall not be present when ul_DPCCHInfo is configured or reconfigured.</p> <p>Presence of ss_HS_DSCH_DtxCellFach makes HS-DSCH DRX operation enabled and SS shall transmit any requested HS-SCCH and HS-DSCH only in occasions when UE will be listening.</p>
Type Definition	
<pre> CHOICE { hS_PDSCH_Info SEQUENCE { hSDSCHPhysicalLayerCategory HSDSCH_physical_layer_category OPTIONAL, hdsch_physical_layer_category_ext HSDSCH_physical_layer_category_ext OPTIONAL, hdsch_physical_layer_category_ext2 HSDSCH_physical_layer_category_ext2 OPTIONAL, hdsch_physical_layer_category_ext3 HSDSCH_physical_layer_category_ext3 OPTIONAL, h_RNTI H_RNTI, dlHSPDSCHInformation DL_HSPDSCH_Information_r9, sttd_Indicator BOOLEAN, hs_SCCH_TxPower DL_TxPower, -- offset related to CPICH ss_DTX_Info DRX_Info OPTIONAL, hs_scch_LessInfo HS_SCCH_LessInfo_r7 OPTIONAL, mimo_Parameters MIMO_Parameters_r9 OPTIONAL, hs_DPCCHToFollow BOOLEAN DEFAULT TRUE, hs_SCCH_SttdIndicator BOOLEAN DEFAULT FALSE }, common_HS_PDSCH_Info SEQUENCE { hdsch_physical_layer_category_ext HSDSCH_physical_layer_category_ext, commonOrDedicated_H_RNTI H_RNTI OPTIONAL, bcchSpecific_H_RNTI H_RNTI, hs_scch_SystemInfo HS_SCCH_SystemInfo, hs_dsch_PagingSystemInformation HS_DSCH_PagingSystemInformation OPTIONAL, sttd_Indicator BOOLEAN, hs_SCCH_TxPower DL_TxPower, -- offset related to CPICH hs_DPCCHToFollow BOOLEAN DEFAULT TRUE, ss_HS_DSCH_DtxCellFach HS_DSCH_DrxCellfach_info OPTIONAL }, spare2 SEQUENCE {}, spare3 SEQUENCE {} } </pre>	

ASN.1 Type Definition	
Type Name	SS_E_DPCH_Info_r6OrLater
Comment	<p>Rel-6 or later.</p> <p>If there is an UL-DPCH configured in the cell the E-DPCH shall use the same scramblingCodeType and scramblingCode as the UL-DPCH.</p> <p>Presence of ul_16QAM_Settings enables usage of 16QAM in UL. With 16QAM configured the value of "E-TFCI table index" is increased by 2, and indices in the SG-Table refer to Scheduling Grant Table 2 in 3GPP TS 25.321 [17].</p> <p>The IEs "edch_PhysicalLayerCategory", "edch_PhysicalLayerCategory_extension" and "edch_PhysicalLayerCategory_extension2" are mutually exclusive. One of the IE shall be present in the SS configuration. The IE "edch_PhysicalLayerCategory_extension" is present only for UE categories greater than or equal to 7. "edch_PhysicalLayerCategory_extension2" is present when Dual Cell E-DCH operation is configured.</p>
Type Definition	
CHOICE	<pre> { r6 SEQUENCE { e_DPCCH_Info E_DPCCH_Info, e_DPDCH_Info E_DPDCH_Info, scramblingCodeType ScramblingCodeType OPTIONAL, scramblingCode UL_ScramblingCode OPTIONAL, tti E_DCH_TTI OPTIONAL, edch_PhysicalLayerCategory INTEGER (1..16) }, r7 SEQUENCE { e_DPCCH_Info E_DPCCH_Info_r7, e_DPDCH_Info E_DPDCH_Info_r7, scramblingCodeType ScramblingCodeType OPTIONAL, scramblingCode UL_ScramblingCode OPTIONAL, tti E_DCH_TTI OPTIONAL, edch_PhysicalLayerCategory INTEGER (1..16) OPTIONAL, edch_PhysicalLayerCategory_extension INTEGER (7) OPTIONAL, ul_16QAM_Settings UL_16QAM_Settings OPTIONAL }, r8 SEQUENCE { e_DPCCH_Info E_DPCCH_Info_r7, e_DPDCH_Info E_DPDCH_Info_r8, scramblingCodeType ScramblingCodeType OPTIONAL, scramblingCode UL_ScramblingCode OPTIONAL, tti E_DCH_TTI OPTIONAL, edch_PhysicalLayerCategory INTEGER (1..16) OPTIONAL, edch_PhysicalLayerCategory_extension INTEGER (7) OPTIONAL, ul_16QAM_Settings UL_16QAM_Settings OPTIONAL, s_offset INTEGER (0..9) OPTIONAL -- Used for enhFACH UL }, r9 SEQUENCE { e_DPCCH_Info E_DPCCH_Info_r7, e_DPDCH_Info E_DPDCH_Info_r8, scramblingCodeType ScramblingCodeType OPTIONAL, scramblingCode UL_ScramblingCode OPTIONAL, tti E_DCH_TTI OPTIONAL, edch_PhysicalLayerCategory INTEGER (1..16) OPTIONAL, edch_PhysicalLayerCategory_extension INTEGER (7) OPTIONAL, edch_PhysicalLayerCategory_extension2 INTEGER (8..9) OPTIONAL, ul_16QAM_Settings UL_16QAM_Settings OPTIONAL, s_offset INTEGER (0..9) OPTIONAL -- Used for enhFACH UL }, spare1 SEQUENCE {}, spare2 SEQUENCE {} } </pre>

ASN.1 Type Definition	
Type Name	SS_E_AGCH_Info
Comment	Rel-6 or later. Presence of ss_DTX_Info indicates DL_DRX is enabled and SS shall transmit any requested AGCH only in occasions when UE will be listening.
Type Definition	
<pre> CHOICE { r6 SEQUENCE { e_AGCHInfo E_AGCH_Information, tti E_DCH_TTI, e_AGCH_PowerOffset INTEGER (0..255) -- Range and Step are FFS (25.433, 9.2.2.13If) -- Offset relative to P-CPICH, e_RNTI_Primary E_RNTI OPTIONAL, e_RNTI_Secondary E_RNTI OPTIONAL, ss_DTX_Info DRX_Info OPTIONAL, -- Rel-7 or later sttdIndicator BOOLEAN DEFAULT FALSE }, r8 SEQUENCE { -- Rel-8 or later e_AGCHInfo E_AGCH_Information_r8, tti E_DCH_TTI, e_AGCH_PowerOffset INTEGER (0..255), -- Range and Step are FFS (25.433, 9.2.2.13If) -- Offset relative to P-CPICH e_RNTI_Primary E_RNTI OPTIONAL, e_RNTI_Secondary E_RNTI OPTIONAL, ss_DTX_Info DRX_Info OPTIONAL, initialServingGrantValue INTEGER (0..37) OPTIONAL, -- Used for enhFACH UL sttdIndicator BOOLEAN DEFAULT FALSE }, spare1 SEQUENCE {}, spare2 SEQUENCE {} } </pre>	

ASN.1 Type Definition	
Type Name	SS_E_HICH_Info
Comment	Rel-6 or later. Only one of e_HICHInfo and e_HICHInfoCommonEDCH can be present.
Type Definition	
<pre> SEQUENCE { e_HICHInfo E_HICH_Information OPTIONAL, e_HICHInfoCommonEDCH E_HICH_Information_CommonEdch OPTIONAL, -- Rel-8 or later tti E_DCH_TTI, e_HICH_PowerOffset INTEGER (0..255), -- PowerOffset = -32 + offset * 0.25 -- Unit dB, Range -32dB .. +31.75dB, Step +0.25dB -- (25.433, 9.2.2.13Id), offset relative to P-CPICH sttdIndicator BOOLEAN DEFAULT FALSE } </pre>	

ASN.1 Type Definition	
Type Name	SS_E_RGCH_Info
Comment	Rel-6 or later. Presence of ss_DTX_Info indicates DL_DRX is enabled and SS shall transmit any requested RGCH only in occasions when UE is going to listen. Only one of e_RGCHInfo and e_RHCHInfoCommonEDCH can be present.
Type Definition	
<pre> SEQUENCE { e_RGCHInfo E_RGCH_Information OPTIONAL, e_RHCHInfoCommonEDCH E_RGCH_Information_CommonEdch OPTIONAL, -- Rel-8 or later tti E_DCH_TTI, e_RGCH_PowerOffset INTEGER (0..255), -- Range Range:-32 .. +31.75 dB, Step: 0.25 dB -- Offset relative to P-CPICH ss_DTX_Info DRX_Info OPTIONAL, -- Rel-7 or later sttdIndicator BOOLEAN DEFAULT FALSE } </pre>	

ASN.1 Type Definition	
Type Name	RL_Information
Comment	<p>The range for powerOffsetOfTPC_PO2 and powerOffsetOfTFCI_PO1 and powerOffsetOfPILOT_PO3 is 0 dB to 6 dB, 0,25 dB per step.</p> <p>The IE cfnTgtSfnFrameOffset is applied when adding another RL or moving the UE to another cell in DCH state in the timing-maintained hard handover or in the softhandover. The cfnTgtSfnFrameOffset is defined as being the time difference between the CFN and the SFN of the cell in which the RL is to be added.</p> <p>The use of cfnTgtSfnFrameOffset and DOFF (Default DPCH Offset Value) is mutually exclusive. The IE cfnTgtSfnFrameOffset is omitted when configuring the 1st RL, or configuring the RL in the timing re-initialized hard handover where the required synchronization information is provided in defaultDPCH_offsetValue in DL_CommonInformation.</p> <p>In addition, TmTgt value is provided to dpch_FrameOffset in DL_DPCH_InfoPerRL_r5 or DL_DPCH_InfoPerRL_r6 as CFNchipOffset_Tgt. TmTgt can be observed by the UE, or calculated by the TTCN. If it is calculated, $TmTgt = (DOFF * 512 + 38400 + TCell_Ref - TCell_Tgt) \text{ Mod } 38400$.</p> <p>dl_FDPCH_ShoConfig set to TRUE, indicates that F-DPCH is configured in softHO.</p>
Type Definition	
<pre>SEQUENCE { powerOffsetOfTFCI_PO1 INTEGER (0..24), powerOffsetOfTPC_PO2 INTEGER (0..24), powerOffsetOfPILOT_PO3 INTEGER (0..24), dl_TxPower DL_TxPower, dl_TxPowerMax DL_TxPower, dl_TxPowerMin DL_TxPower, cfnTgtSfnFrameOffset CfnTgtSfnFrameOffset OPTIONAL, dl_FDPCH_ShoConfig BOOLEAN DEFAULT FALSE -- Rel-6 or later }</pre>	

ASN.1 Type Definition	
Type Name	CfnTgtSfnFrameOffset
Comment	<ol style="list-style-type: none"> The observedValue is provided if the UE reads SFN when measuring "Cell synchronization information" and sends it to the SS in MEASUREMENT REPORT message. The OFF value in IE COUNT-C-SFN frame difference is applied to the observedValue. If the synchronization between the target cell and the reference cell is calculated the calculatedAbsoluteValue is applied. Depending upon how to interpret SfnOffset two valid calculations exist. <ol style="list-style-type: none"> If SfnOffset is interpreted as the frames lagging behind: $\text{calculated_sfnLagging} = (((4096 * 38400) + \text{SfnOffset_Ref} * 38400 + \text{TCell_Ref} + \text{DOFF} * 512 - (\text{SfnOffset_Tgt} * 38400 + \text{TCell_Tgt})) \text{ mod } (256 * 38400)) / 38400$ If SfnOffset is interpreted as the frames in advance: $\text{calculated_sfnInAdvance} = (((4096 + \text{SfnOffset_Tgt} - \text{SfnOffset_Ref}) * 38400 + \text{TCell_Ref} + \text{DOFF} * 512 - \text{TCell_Tgt}) \text{ mod } (256 * 38400)) / 38400$ <p>The formula can be further simplified in the default condition if SfnOffset_Ref and TCell_Ref are equal to 0:</p> $\text{calculated_sfnLagging} = (((4096 * 38400) + \text{DOFF} * 512 - (\text{SfnOffset_Tgt} * 38400 + \text{TCell_Tgt})) \text{ mod } (256 * 38400)) / 38400$ $\text{calculated_sfnInAdvance} = ((\text{DOFF} * 512 + \text{SfnOffset_Tgt} * 38400 - \text{TCell_Tgt}) \text{ Mod } (256 * 38400)) / 38400$ $\text{calculated_sfnInAdvance} = (\text{calculated_sfnLagging} + 2 * \text{SfnOffset_Tgt}) \text{ mod } 256$ $\text{calculated_sfnLagging} = (\text{calculated_sfnInAdvance} + (4096 - \text{SfnOffset_Tgt}) * 2) \text{ mod } 256$ <p>The TTCN provides calculated_sfnLagging.</p>
Type Definition	
<pre>SEQUENCE { referenceCellId INTEGER(0..63), cfnFrameOffset CHOICE { observed INTEGER (0..255), calculated INTEGER (0..255) } }</pre>	

ASN.1 Type Definition	
Type Name	SS_MBMS_MICHConfigurationInfo_r6
Comment	Rel-6 or later.
Type Definition	
SEQUENCE	{
michinfo	MBMS_MICHConfigurationInfo_r6,
sccpchId_associated	INTEGER (0..31)
	}

Type Name	E_AI_InfoType
Comment	defaultE_DCH_ResourceIndex is the index (range 0 to 31) in SIB5/5bis of the E-DCH resource to be used by SS when providing the resource configuration index to UE in the E-AI indication. defaultE_DCH_ResourceIndex = -1 indicates that any E-DCH resource index is used as appropriate and as indicated by UE in the access preamble. The totalNumberE_DCH is the total number of E-DCH resources configured in SIB5/5bis.
Type Definition	
SEQUENCE	{
defaultE_DCH_ResourceIndex	INTEGER (-1..31),
totalNumberE_DCH	INTEGER (1..32)
	}

7.3.2.2.12 CPHY_Sync

ASN.1 ASP Type Definition	
Type Name	CPHY_Sync_IND
PCO Type	CSAP
Comment	To indicate that physical channel synchronization (in FDD mode, sync with DPCCH) has been achieved.
Type Definition	
SEQUENCE	{
cellId	INTEGER(0..63),
routingInfo	RoutingInfo
	}

7.3.2.2.12a CPHY_HS_DPCCH_AckNack (Rel-5 or later)

ASN.1 ASP Type Definition	
Type Name	CPHY_HS_DPCCH_AckNack_CNF
PCO Type	CSAP
Comment	Applicable Rel-5 or later To Confirm CPHY_HS_DPCCH_AckNack_REQ
Type Definition	
SEQUENCE	{
cellId	INTEGER(0..63)
	}

ASN.1 ASP Type Definition	
Type Name	CPHY_HS_DPCCH_AckNack_REQ
PCO Type	CSAP
Comment	Applicable Rel-5 or later To request for start or stop reporting Ack/Nack received on the HS-DPCCH for the HARQ process hARQProcessId. Harq Process ID 0..15 represent the respective process Id with HS-SCCH type 1 operation. Value 31 represents all HARQ process IDs; it is used for HS-SCCH less/HS-SCCH Type 2 operation. At the initialization the SS is at the "sTOPRep" state without reporting any Ack/Nack
Type Definition	
SEQUENCE	{ cellId INTEGER(0..63), ratType RatType, ackNackReportReq AckNackReportReq, hARQProcessId INTEGER(0..15 31) }

ASN.1 Type Definition	
Type Name	AckNackReportReq
Comment	Applicable Rel-5 or later startRep: The SS shall start reporting the HARQ-ACK information received on HS-DPCCH by primitive CPHY_HS_DPCCH_AckNack_IND on CPHY PCO. stopRep: The SS shall stop reporting.
Type Definition	
ENUMERATED	{ startRep (0), stopRep (1) }

ASN.1 ASP Type Definition	
Type Name	CPHY_HS_DPCCH_AckNack_IND
PCO Type	CSAP
Comment	Applicable Rel-5 or later SS reports the HARQ-ACK information received on HS_DPCCH, each received Ack/Nack generates a CPHY_HS_DPCCH_AckNack_IND Harq Process ID 0..15 represent the process Id with HS-SCCH type 1 operation. Value 31 represents all HARQ process IDs; it is used for HS-SCCH less/HS-SCCH Type 2 operation.
Type Definition	
SEQUENCE	{ cellId INTEGER(0..63), ratType RatType, hARQ_ACKInfo ENUMERATED {ack(0), nack(1)}, hARQProcessId INTEGER(0..15 31) }

7.3.2.2.12b CPHY_HS_DPCCH_CQI (Rel-5 or later)

ASN.1 ASP Type Definition	
Type Name	CPHY_HS_DPCCH_CQI_CNF
PCO Type	CSAP
Comment	Applicable Rel-5 or later To Confirm CPHY_HS_DPCCH_CQI_REQ
Type Definition	
SEQUENCE	{ cellId INTEGER(0..63) }

ASN.1 ASP Type Definition	
Type Name	CPHY_HS_DPCCH_CQI_REQ
PCO Type	CSAP
Comment	Applicable Rel-5 or later To enable the SS to start reporting N times of the CQI value received on the HS-DPCCH. After N times the SS stops reporting. N is specified in numberOfReports. At the SS initialization reporting of CQI values is disabled
Type Definition	
SEQUENCE	{ cellId INTEGER (0..63), ratType RatType, numberOfReports INTEGER (1..32) }

ASN.1 ASP Type Definition	
Type Name	CPHY_HS_DPCCH_CQI_IND
PCO Type	CSAP
Comment	Applicable Rel-5 or later SS generates the indication when a CQI value is received on HS_DPCCH after invocation of ASP CPHY_HS_DPCCH_CQI_REQ and before the numberOfReports is reached. This ASP is used for verifying whether the UE has configured the HS-DSCH and starts reception of HS-DSCH (3GPP TS 25.331 [21], subclause 8.6.6.34). 'second_cqi' shall be reported when MIMO is configured and dual transport block type A CQI report is received. When second_cqi is present, allowed values for 'cqi' are 0..14. In all other cases (i.e. non MIMO operation, MIMO operation but with CQI type B or single transport block type A CQI reports] 'second_cqi' shall not be reported and range for cqi is 0..30. 'pci' and cqiType shall be present when MIMO is configured.
Type Definition	
SEQUENCE	{ cellId INTEGER (0..63), ratType RatType, cfn INTEGER (0..255), -- Rel-7 or later subframe INTEGER (0..4), -- Rel-7 or later cqi INTEGER (0..30), cqiExt CQI_ExtensionType }

ASN.1 Type Definition	
Type Name	CQI_ExtensionType
Comment	Rel-7 or later The value -1 for second_cqi indicates the absence of the second CQI.
Type Definition	
SEQUENCE	{ second_cqi INTEGER (-1..14) OPTIONAL, pci INTEGER (0..3) OPTIONAL, -- MIMO cqiType ENUMERATED {cqiTypeA(0), cqiTypeB(1)} OPTIONAL -- MIMO }

7.3.2.2.12b1 CPHY_HS_DPCCH_CQI_DC (Rel-8 or later)

ASN.1 ASP Type Definition	
Type Name	CPHY_HS_DPCCH_CQI_DC_CNF
PCO Type	CSAP
Comment	Applicable Rel-8 or later To Confirm CPHY_HS_DPCCH_CQI_DC_REQ
Type Definition	
SEQUENCE	{ cellId INTEGER (0..63) }

ASN.1 ASP Type Definition	
Type Name	CPHY_HS_DPCCH_CQI_DC_REQ
PCO Type	CSAP
Comment	Applicable Rel-8 or later To enable the SS to start reporting N times of the CQI value received on the HS-DPCCH on cellId when DC-HSDPA is configured. After N times the SS stops reporting. N is specified in numberOfReports. At the SS initialization reporting of CQI values is disabled.
Type Definition	
SEQUENCE	{
cellId	INTEGER(0..63),
ratType	RatType,
numberOfReports	INTEGER(1..32)
	}

ASN.1 ASP Type Definition	
Type Name	CPHY_HS_DPCCH_CQI_DC_IND
PCO Type	CSAP
Comment	Applicable Rel-8 or later SS generates the indication when a CQI value is received on HS-DPCCH after invocation of ASP CPHY_HS_DPCCH_CQI_REQ and before the numberOfReports is reached. This ASP is used for verifying whether the UE has configured the HS-DSCH and starts reception of HS-DSCH (3GPP TS 25.331 [21], subclause 8.6.6.34 and 3GPP TS 25.212 [58], subclause 4.7.3.A2).
Type Definition	
SEQUENCE	{
cellId	INTEGER(0..63),
ratType	RatType,
cfn	INTEGER(0..255),
subframe	INTEGER(0..4) OPTIONAL,
cqi_dCHSDPA	INTEGER(0..1023)
	}

7.3.2.2.12c CPHY_HS_DSCH_CRC_Mode (Rel-5 or later)

ASN.1 ASP Type Definition	
Type Name	CPHY_HS_DSCH_CRC_Mode_CNF
PCO Type	CSAP
Comment	Applicable Rel-5 or later Confirm a previous CPHY_HS_DSCH_CRC_Mode_REQ being successful.
Type Definition	
SEQUENCE	{
cellId	INTEGER(-1..63),
routingInfo	RoutingInfo
	}

ASN.1 ASP Type Definition	
Type Name	CPHY_HS_DSCH_CRC_Mode_REQ
PCO Type	CSAP
Comment	Applicable Rel-5 or later To set the CRC calculation mode for HS-DSCH. If mode = normal, the SS generates the correct CRC. If mode = erroneous, the SS always generates any wrong CRC value which is different from the correct one on the specified MACdFlow/mac-ehs Queue. If mode = error1AndNormal, the SS generates wrong CRC for first transmission and correct CRC on first retransmission. Later SS operates in normal mode. If mode = error2AndNormal, the SS generates wrong CRC for first transmission, first retransmission and correct CRC second retransmission. The corrupted bits in first error transmission and second error transmission are different, so that when UE combines the data from three transmission, shall result in correct data. Later SS operates in normal mode. As default, the normal mode is applied. When the HS-DSCH first configured or reconfigured the SS enters the normal CRC calculation mode.
Type Definition	
SEQUENCE	{ cellId INTEGER (-1..63) , routingInfo RoutingInfo, flow_Queue_Id Flow_Queue_ID, mode ENUMERATED {normal(0), erroneous(1), error1AndNormal(2), error2AndNormal(3)} }

ASN.1 Type Definition	
Type Name	Flow_Queue_ID
Comment	Choice MAC_d_Flow is used when MAC-hs is configured and MAC_ehs_Queue is used when MAC-ehs is configured.
Type Definition	
CHOICE	{ mac_dFlowId MAC_d_FlowIdentity, mac_ehs_QueueId NULL }

7.3.2.2.13 CPHY_TrCH_Config

ASN.1 ASP Type Definition	
Type Name	CPHY_TrCH_Config_CNF
PCO Type	CSAP
Comment	To confirm to configure the transport channel
Type Definition	
SEQUENCE	{ cellId INTEGER (0..63) , routingInfo RoutingInfo }

ASN.1 ASP Type Definition	
Type Name	CPHY_TrCH_Config_REQ
PCO Type	CSAP
Comment	To request to configure the transport channel
Type Definition	
SEQUENCE	{ cellId INTEGER (0..63) , routingInfo RoutingInfo, ratType RatType, trchConfigType TrchConfigType, configMessage CphyTrchConfigReq }

ASN.1 Type Definition	
Type Name	CphyTrchConfigReq
Comment	<p>To request to configure the transport channel. The same TFCS information should be provided to the PHY and MAC layers at all times. When a CPHY_TrCH_Config_REQ is used to configure the PHY layer, a corresponding CMAC_Config_REQ should be sent to the MAC layer to ensure that the configuration is consistent. HS-DSCH MAC-d/EHS-DSCH/EHS-DSCH-Common flows or E-DCH MAC-d flows shall be separately configured whilst the ulconnectedTrCHList, ulTFCS, dlconnectedTrCHList and dlTFCS are omitted. For configuring MBMS if the default TFCS used in the RRC message the dlTFCS shall use the "complete" CHOICE in "ExplicitTFCS-Configuration" IE and the TFCS configuration shall be in line with clause 14.10.1.1/14.10.1.2 of 3GPP TS 25.331 [21]. ehs_DSCH_Flow or ehs_DSCH_Flows_r9 is used when MAC-ehs is to be configured in Cell_DCH state. ehs_DSCH_CommonFlows shall be used for configuring MAC_ehs layer in common connected mode states. Only one of hsDSCHMacdFlows, ehs_DSCH_Flows, ehs_DSCH_CommonFlows, ehs_DSCH_Flows_r9, can be present. e_DCHMacd_CommonFlows shall be used for configuring MACi/is in common connected mode states.</p>
Type Definition	
<pre> SEQUENCE { activationTime SS_ActivationTime, ulconnectedTrCHList SEQUENCE (SIZE (0..maxTrCH)) OF SEQUENCE { trchid TransportChannelIdentity, ul_TransportChannelType SS_UL_TransportChannelType, transportChannelInfo CommonOrDedicatedTFS } OPTIONAL, ulTFCS TFCS OPTIONAL, dlconnectedTrCHList SEQUENCE (SIZE (0..maxTrCH)) OF SEQUENCE { trchid TransportChannelIdentity, dl_TransportChannelType SS_DL_TransportChannelType, transportChannelInfo CommonOrDedicatedTFS } OPTIONAL, dlTFCS TFCS OPTIONAL, hsDSCHMacdFlows HS_DSCHMACdFlows OPTIONAL, -- Rel-5 or later e_DCHMacdFlows E_DCHMACdFlows OPTIONAL, -- Rel-6 or later ehs_DSCH_Flows EHS_DSCH_Flows OPTIONAL, -- Rel-7 or later ehs_DSCH_CommonFlows EHS_DSCH_CommonFlows OPTIONAL, -- Rel-7 or later e_DCHMacd_CommonFlows CommonE_DCHMACdFlows OPTIONAL, -- Rel-8 or later ehs_DSCH_Flows_r9 EHS_DSCH_Flows_r9 OPTIONAL -- Rel-9 or later } </pre>	

ASN.1 Type Definition	
Type Name	RoutingInfo
Comment	To route between each channels.
Type Definition	
<pre> CHOICE { physicalChannelIdentity INTEGER {0..31}, transportChannelIdentity TransportChannelIdentity, logicalChannelIdentity LogicalChannelIdentity, rB_Identity INTEGER {-31..32}, cn_DomainIdentity CN_DomainIdentity } </pre>	

ASN.1 Type Definition	
Type Name	RatType
Comment	To select route between each channels.
Type Definition	
<pre> ENUMERATED { fdd (0), tdd (1) } </pre>	

ASN.1 Type Definition	
Type Name	CommonOrDedicatedTFS
Comment	Transport Format Set
Type Definition	
<pre>SEQUENCE { tti tti10 CHOICE { tti20 CommonOrDedicatedTF_InfoList, tti40 CommonOrDedicatedTF_InfoList, tti80 CommonOrDedicatedTF_InfoList, dynamic CommonOrDedicatedTF_InfoList_DynamicTTI }, semistaticTF_Information SemistaticTF_Information }</pre>	

ASN.1 Type Definition	
Type Name	CommonOrDedicatedTF_InfoList
Comment	Transport Format Set
Type Definition	
<pre>SEQUENCE (SIZE (1..maxTF)) OF CommonOrDedicatedTF_Info</pre>	

ASN.1 Type Definition	
Type Name	CommonOrDedicatedTF_Info
Comment	Transport Format Set
Type Definition	
<pre>SEQUENCE { tb_Size INTEGER (0..5035), numberOfTbSizeList SEQUENCE (SIZE (1..maxTF)) OF NumberOfTransportBlocks, logicalChannelList SS_LogicalChannelList }</pre>	

ASN.1 Type Definition	
Type Name	CommonOrDedicatedTF_InfoList_DynamicTTI
Comment	Transport Format Set for TDD mode
Type Definition	
<pre>SEQUENCE { tb_Size INTEGER (0..5035), numberOfTbSizeList SEQUENCE (SIZE (1..maxTF)) OF NumberOfTransportBlocks, logicalChannelList SS_LogicalChannelList }</pre>	

ASN.1 Type Definition	
Type Name	TrchConfigType
Comment	
Type Definition	
<pre>CHOICE { nonDch NULL, dch ENUMERATED {normal(0), softHO(1)} }</pre>	

ASN.1 Type Definition	
Type Name	HS_DSCHMACdFlows
Comment	Applicable Rel-5 or later Within the ACK/NACK repetition period indicated by ackNackRepetitionFactor the SS shall not transmit MAC-hs PDU's on HS-PDSCH. Only one among harqInfo and harqInfo_r7 shall be present. Harq_Info_r7 shall be used for Rel-7 or later. mimoStatus represents status of MIMO, and shall be set only if mimo_Parameters are provided in HS-PDSCH configuration
Type Definition	
<pre>SEQUENCE { harqInfo HARQ_Info OPTIONAL, addOrReconfMACdFlow SS_AddOrReconfMAC_dFlow OPTIONAL, ackNackRepetitionFactor ACK_NACK_repetitionFactor OPTIONAL, harqInfo_r7 HARQ_Info_r7 OPTIONAL -- to be used for Rel-7 or later. }</pre>	

ASN.1 Type Definition	
Type Name	EHS_DSCH_Flows
Comment	Applicable Rel-7 or later Within the ACK/NACK repetition period indicated by ackNackRepetitionFactor the SS shall not transmit MAC-hs PDU's on HS-PDSCH. mimoStatus represents status of MIMO, and shall be set only if mimo_Parameters are provided in HS-PDSCH configuration
Type Definition	
<pre>SEQUENCE { harqInfo_r7 HARQ_Info_r7 OPTIONAL, addOrReconfMAC_ehs_ReordQ SS_MAC_ehs_AddReconfReordQueueList OPTIONAL, ackNackRepetitionFactor ACK_NACK_repetitionFactor OPTIONAL, mimoStatus BOOLEAN OPTIONAL }</pre>	

ASN.1 Type Definition	
Type Name	SS_MAC_ehs_AddReconfReordQueueList
Comment	Applicable Rel-7 or later
Type Definition	
<pre>SEQUENCE (SIZE (1..maxQueueIDs)) OF SS_MAC_ehs_AddReconfReordQ</pre>	

ASN.1 Type Definition	
Type Name	SS_MAC_ehs_AddReconfReordQ
Comment	Applicable Rel-7 or later The priority of PriorityQueue shall set according to the priority of logical channels which is mapped on to this priority queue. NOTE: The range of priority of PriorityQueue is from 0 to 7 and 0 is the lowest priority.
Type Definition	
<pre>SEQUENCE { mac_ehs_AddReconfReordQ MAC_ehs_AddReconfReordQ, priority INTEGER (0..7) }</pre>	

Type Name	EHS_DSCH_Flows_r9
Comment	Applicable Rel-9 or later Within the ACK/NACK repetition period indicated by ackNackRepetitionFactor the SS shall not transmit MAC-hs PDU's on HS-PDSCH. mimoStatus represents status of MIMO, and is set only if mimo_Parameters are provided in HS-PDSCH configuration. In dedicated MAC configuration mimostatus is not applicable.
Type Definition	
<pre>SEQUENCE { harqInfo_r7 HARQ_Info_r7 OPTIONAL, addOrReconfMAC_ehs_ReordQ SS_MAC_ehs_AddReconfReordQueueList_r9 OPTIONAL, ackNackRepetitionFactor ACK_NACK_repetitionFactor OPTIONAL, mimoStatus BOOLEAN OPTIONAL }</pre>	

ASN.1 Type Definition	
Type Name	SS_MAC_ehs_AddReconfReordQueueList_r9
Comment	Applicable Rel-9 or later
Type Definition	
SEQUENCE (SIZE (1..maxQueueIDs)) OF SS_MAC_ehs_AddReconfReordQ_r9	

ASN.1 Type Definition	
Type Name	SS_MAC_ehs_AddReconfReordQ_r9
Comment	Applicable Rel-9 or later The priority of PriorityQueue shall set according to the priority of logical channels which is mapped on to this priority queue. NOTE: The range of priority of PriorityQueue is from 0 to 7 and 0 is the lowest priority.
Type Definition	
<pre>SEQUENCE { MAC_ehs_AddReconfReordQ MAC_ehs_AddReconfReordQ_r9, priority INTEGER (0..7) }</pre>	

ASN.1 Type Definition	
Type Name	EHS_DSCH_CommonFlows
Comment	Applicable Rel-7 or later
Type Definition	
<pre>SEQUENCE { harqInfo_r7 HARQ_Info_r7 OPTIONAL, common_MAC_ehs_ReorderingQueueList SS_Common_MAC_ehs_ReorderingQueueList OPTIONAL }</pre>	

ASN.1 Type Definition	
Type Name	SS_Common_MAC_ehs_ReorderingQueueList
Comment	Applicable Rel-7 or later
Type Definition	
SEQUENCE (SIZE (1..maxQueueIDs)) OF SS_Common_MAC_ehs_ReorderingQueue	

Type Name	SS_Common_MAC_ehs_ReorderingQueue
Comment	Applicable Rel-7 or later The priority of PriorityQueue shall set according to the priority of logical channels which is mapped on to this priority queue. NOTE: The range of priority of PriorityQueue is from 0 to 7 and 0 is the lowest priority.
Type Definition	
<pre>SEQUENCE { common_MAC_ehs_ReorderingQueue Common_MAC_ehs_ReorderingQueue, priority INTEGER (0..7) }</pre>	

ASN.1 Type Definition	
Type Name	SS_AddOrReconfMAC_dFlow
Comment	Applicable Rel-5 or later
Type Definition	
<pre>SEQUENCE { mac_hs_AddReconfQueue_List SEQUENCE (SIZE (1..maxQueueIDs)) OF SEQUENCE { mac_hs_AddReconfQueue SS_MAC_hs_AddReconfQueue} OPTIONAL, mac_hs_DelQueue_List SEQUENCE (SIZE (1..maxQueueIDs)) OF SEQUENCE { mac_hsQueueId INTEGER (0..7)} OPTIONAL }</pre>	

ASN.1 Type Definition	
Type Name	SS_MAC_hs_AddReconfQueue
Comment	Applicable Rel-5 or later The priority of PriorityQueue shall set according to the priority of logical channels which is mapped on to this priority queue. NOTE: The range of priority of PriorityQueue is from 0 to 7 and 0 is the lowest priority. DiscardTimer defines the time (unit ms) to live for a MAC-hs SDU starting from the instant of its arrival into an HSDPA Priority Queue. The SS shall use this information to discard out-of-data MAC-hs SDUs from the HSDPA Priority Queues.
Type Definition	
<pre>SEQUENCE { mChsAddReconfQueue MAC_hs_AddReconfQueue, logicalChannelList SEQUENCE OF LogicalChannelIdentity, -- logical channels mapping onto the priority queue -- which is specified in mChsAddReconfQueue priority INTEGER(0..7), discardTimer ENUMERATED { v20(0),v40(1),v60(2),v80(3),v100(4),v120(5),v140(6),v160(7),v180(8),v200(9), v250(10),v300(11),v400(12),v500(13),v750(14),v1000(15),v1250(16),v1500(17),v1750(18),v2000(19),v2500(20),v3000(21),v3500(22),v4000(23),v4500(24),v5000(25),v7500(26) } OPTIONAL }</pre>	

ASN.1 Type Definition	
Type Name	E_DCHMACdFlows
Comment	Rel-6 or later addReconf_MAC_d_FlowList and addReconf_MAC_d_FlowList_r7 are mutually exclusive. One of these shall be present.
Type Definition	
<pre>SEQUENCE { tti E_DCH_TTI, harq_Info ENUMERATED {rv0(0),rvtable(1)}, addReconf_MAC_d_FlowList E_DCH_AddReconf_MAC_d_FlowList OPTIONAL, -- Rel-6 addReconf_MAC_d_FlowList_r7 E_DCH_AddReconf_MAC_d_FlowList_r7 OPTIONAL -- Rel-7 or later }</pre>	

ASN.1 Type Definition	
Type Name	CommonE_DCHMACdFlows
Comment	Rel-6 or later addReconf_MAC_d_FlowList and addReconf_MAC_d_FlowList_r7 are mutually exclusive. One of these shall be present.
Type Definition	
<pre>SEQUENCE { tti E_DCH_TTI, harq_Info ENUMERATED {rv0(0),rvtable(1)}, addReconfMAC_d_FlowList Common_E_DCH_MAC_d_FlowsList }</pre>	

ASN.1 Type Definition	
Type Name	SS_LogicalChannelList
Comment	
Type Definition	
<pre>CHOICE { allSizes NULL, configured NULL, explicitList SEQUENCE (SIZE (1..15)) OF SS_LogicalChannelByRB }</pre>	

ASN.1 Type Definition	
Type Name	SS_LogicalChannelByRB
Comment	logChOfRb is an optional and currently unused
Type Definition	
SEQUENCE	{
rb_Identity	INTEGER (-31..32),
logChOfRb	INTEGER (0..1) OPTIONAL
	}

7.3.2.2.14a CPHY_UL_PowerModify

ASN.1 ASP Type Definition	
Type Name	CPHY_UL_PowerModify_CNF
PCO Type	CSAP
Comment	To confirm the increase/decrease in UE uplink DPCH power transmission or send the TPC commands as instructed.
Type Definition	
SEQUENCE	{
cellId	INTEGER(0..63),
routingInfo	RoutingInfo
	}

ASN.1 ASP Type Definition	
Type Name	CPHY_UL_PowerModify_REQ
PCO Type	CSAP
Comment	To request increase/decrease in the UE uplink DPCH transmission by the delta value given in dB, from the existing transmission level or make UE to transmit at maximum or minimum power level. It is assumed that the UE UL DPCH transmission power level is set to -20 dbm by default at beginning of each test. For routing Info the DL DPCH Physical channel ID shall be used. For IE ul_DPCH_Id, the physical channel ID of associated UL DPCH shall be given. SS can use it or neglect it. UI_UE_TxPower gives either the value in dB, by which SS shall increase/decrease the uplink transmission power of UE from the existing transmission power, when this primitive is called or Start transmission of TPC commands on DL DPCCCH as configured
Type Definition	
SEQUENCE	{
cellId	INTEGER(0..63),
routingInfo	RoutingInfo,
ul_DPCH_Id	INTEGER(0..31),
ul_UE_Tx_Power	Ul_UE_Tx_Power
	}

ASN.1 Type Definition	
Type Name	UI_UE_Tx_Power
Comment	Choice delta gives the value in dB, by which the existing UE UL DPCH transmission power level is to be increased or decreased. After reaching the new desired level SS shall make UE to maintain this new transmission power level. WithChoice maxMin, and ENUM 'tpc_Up' selection, SS shall start transmitting TPC commands on the DL DPCCCH, as '1' every slot so as to ask UE to increase the transmission power. With Choice maxMin, and ENUM 'tpc_Down' selection, SS shall start transmitting TPC commands on the DL DPCCCH, as '0' every slot so as to ask UE to decrease the transmission power. With Choice maxMin, and ENUM 'tpc_Maintain' selection, SS will start transmitting TPC commands on the DL DPCCCH, as alternate '0' and '1' in alternate slots so as to maintain the UE uplink transmission power
Type Definition	
CHOICE	{
delta	INTEGER (-64..63),
maxMin	ENUMERATED{ tpc_Up(0), tpc_Down(1), tpc_Maintain(2) }
	}

7.3.2.2.14 CPHY_TrCH_Release

ASN.1 ASP Type Definition	
Type Name	CPHY_TrCH_Release_REQ
PCO Type	CSAP
Comment	To request to release the Radio Link
Type Definition	
SEQUENCE	{
cellId	INTEGER(0..63),
routingInfo	RoutingInfo,
trchConfigType	TrchConfigType,
activationTime	SS_ActivationTime
	}

ASN.1 ASP Type Definition	
Type Name	CPHY_TrCH_Release_CNF
PCO Type	CSAP
Comment	To confirm to release the Radio Link
Type Definition	
SEQUENCE	{
cellId	INTEGER(0..63),
routingInfo	RoutingInfo
	}

7.3.2.2.15 CMAC_BMC_Scheduling

ASN.1 ASP Type Definition	
Type Name	CMAC_BMC_Scheduling_CNF
PCO Type	CSAP
Comment	To confirm the BMC scheduling.
Type Definition	
SEQUENCE	{
cellId	INTEGER(0..63),
routingInfo	RoutingInfo
	}

ASN.1 ASP Type Definition	
Type Name	CMAC_BMC_Scheduling_REQ
PCO Type	CSAP
Comment	Send the BMC scheduling information to the MAC.
Type Definition	
SEQUENCE	{
cellId	INTEGER(0..63),
routingInfo	RoutingInfo,
ratType	RatType,
schedulingInfo	BMC_SchedulingInfo
	}

ASN.1 Type Definition	
Type Name	BMC_SchedulingInfo
Comment	
Type Definition	
SEQUENCE	{
level1Info	BMC_SchedulingLevel1Info,
level2Info	BMC_SchedulingLevel2Info OPTIONAL
	}

ASN.1 Type Definition	
Type Name	BMC_SchedulingLevel2Info
Comment	ctchBsIndexList contains a CTCH BS index offset value for each BMC PDU transmitted, the offset is relative to the previous BMC PDU transmitted. The offset for the first BMC PDU is set to 0.
Type Definition	
<pre>SEQUENCE { ctchBsIndexList SEQUENCE (SIZE(1..256)) OF INTEGER (0..255), drxSelectionBitmap OCTET STRING }</pre>	

ASN.1 Type Definition	
Type Name	BMC_SchedulingLevel1Info
Comment	$0 \leq K \leq N-1$ (3GPP TS 25.331 [21], subclause 8.5.16)
Type Definition	
<pre>SEQUENCE { ctchAllocationPeriod INTEGER (1..256), -- N cbsFrameOffset INTEGER (0..255) -- K }</pre>	

7.3.2.2.16 CMAC_Ciphering_Activate

ASN.1 ASP Type Definition	
Type Name	CMAC_Ciphering_Activate_CNF
PCO Type	CSAP
Comment	To confirm to activate or inactivate the ciphering
Type Definition	
<pre>SEQUENCE { cellId INTEGER(-1..63), routingInfo RoutingInfo }</pre>	

ASN.1 ASP Type Definition	
Type Name	CMAC_Ciphering_Activate_REQ
PCO Type	CSAP
Comment	<p>To request to start or restart downlink ciphering or uplink deciphering. The physicalChannelIdentity of DPCH applies to routingInfo. Initialize the 20 MSB of HFN component of COUNT-C to the START value stored. If the value of incHFN is set to "NotInc" the SS initializes the remaining LSBs of HFN component in COUNT-C to zero and the SS shall not increment HFN part of COUNT-C at every CFN cycle. If the value of incHFN is set to "IncPerCFN_Cycle" the SS initializes the remainingLSBs of HFN component in COUNT-C accordingly. If it is absent the SS initialize the LSBs of HFN component in COUNT-C to zero, increments the HFN component in COUNT-C by one and then starts the increment HFN part of COUNT-C at every CFN cycle. Only one among cipheringModelInfo and CipheringModelInfo_r7 shall be present. The later being applicable from Rel 7 onwards.</p>
Type Definition	
<pre>SEQUENCE { cellId INTEGER(-1..63), routingInfo RoutingInfo, ratType RatType, cn_DomainIdentity CN_DomainIdentity, cipheringModeInfo CipheringModeInfo OPTIONAL, cipheringModeInfo_r7 CipheringModeInfo_r7 OPTIONAL, -- Rel 7 or later incHFN Increment_Mode }</pre>	

ASN.1 Type Definition	
Type Name	Increment_Mode
Comment	
Type Definition	
<pre>ENUMERATED {incPerCFN_Cycler(0), notInc(1), incByOne_IncPerCFN_Cycle(2)}</pre>	

7.3.2.2.16a CMAC_FACH_MeasOccas

ASN.1 ASP Type Definition	
Type Name	CMAC_FACH_MeasOccas_CNF
PCO Type	CSAP
Comment	To confirm to config FACH Measurement Occasions
Type Definition	
SEQUENCE	{
	cellId INTEGER(0..63),
	routingInfo RoutingInfo
	}

ASN.1 ASP Type Definition	
Type Name	CMAC_FACH_MeasOccas_REQ
PCO Type	CSAP
Comment	To request MAC layer to configure FACH Measurement Occasions (FMO). If IE "Inter-frequency FDD measurement indicator" is set to TRUE, the UE will start inter-frequency FMO at the activationTime. If this IE is set to FALSE, the UE inter-frequency FMO will be stopped at the activation Time. For the FDD test, the IE "Inter-frequency TDD measurement indicator" is set to FALSE. If IE "Inter-RAT measurement indicators" is included, the UE will start inter-RAT FMO at the activationTime. If this IE is omitted, the UE inter-RAT FMO will be stopped at the activation Time. largest_TTI_Number is the TTI (in number of 10ms frames) of the FACH having the largest TTI on the SCCPCH.
Type Definition	
SEQUENCE	{
	cellId INTEGER(0..63),
	routingInfo RoutingInfo,
	fMO FACH_MeasurementOccasionInfo,
	largest_TTI INTEGER(1..8),
	activationTime SS_ActivationTime
	}

7.3.2.2.17 CMAC_Config

ASN.1 ASP Type Definition	
Type Name	CMAC_Config_CNF
PCO Type	CSAP
Comment	For MAC emulator to report that a previous attempt to setup, reconfigure or release a logical channel is successful.
Type Definition	
SEQUENCE	{
	cellId INTEGER(-1..63),
	routingInfo RoutingInfo
	}

ASN.1 ASP Type Definition	
Type Name	CMAC_Config_REQ
PCO Type	CSAP
Comment	To request to configure MAC entity. Setup is used for creation of the MAC instances or the MAC resources. Release is used for free the all MAC resources. The reconfiguration is to change the MAC parameters, it is not the MAC modification.
Type Definition	
SEQUENCE	{ cellId INTEGER (-1..63), routingInfo RoutingInfo, ratType RatType, configMessage CHOICE { setup CmacConfigReq, reconfigure CmacConfigReq, release SS_ActivationTime } }

ASN.1 Type Definition	
Type Name	CmacConfigReq
Comment	To request to configure MAC The IE associatedPhychConfigToFollow should be set to TRUE when there is a associated physical channel configuration to follow (e.g configuration of PICH or MICH). The implementation of the IE "associatedPhychConfigToFollow" can be left to the SS either to wait for the associated physical channel before MAC is configured or to continue the configuration of MAC without waiting for the associated physical channel. If Dual Cell is configured, IE servingAndSecondaryCellActivation is included. Presence of tSN_FieldExtension indicates that the TSN field extension is used as defined in TS 25.321[17]; the absence indicates that 6 bits TSN is used.
Type Definition	
SEQUENCE	{ activationTime SS_ActivationTime, uE_Info UE_Info, trCHInfo TrCHInfo, trCH_LogCHMapping TrCH_LogCHMappingList1, associatedPhychConfigToFollow BOOLEAN DEFAULT FALSE, servingAndSecondaryCellActivation ServingAndSecondaryCellActivation_Type OPTIONAL, -- for Dual Cell Rel-8 or later tSN_FieldExtension BOOLEAN DEFAULT FALSE -- Rel-9 or later }

ASN.1 Type Definition	
Type Name	UE_Info
Comment	The value of c_RNTI_DSCH_RNTI is 16 bits, used either for C-RNTI or DSCH-RNTI. DSCH is configured if the physical channel in CMAC_config_REQ is a PDSCH. Otherwise, C-RNTI is applied. At the MAC-hs configuration both u_RNTI and c_RNTI_DSCH_RNTI are omitted. If MAC is being configured with Common_MAC_ehs flows, UE Info U-RNTI shall be provided when the common H-RNTI is applied and is applied in MAC-c header on SRB#1.
Type Definition	
SEQUENCE	{ u_RNTI U_RNTI OPTIONAL, c_RNTI C_RNTI OPTIONAL }

ASN.1 Type Definition	
Type Name	TrCH_LogCHMappingList1
Comment	<p>maxulTrCH = maxdlTrCH = 16</p> <p>dlconnectedMACdFlows is used for MAC-hs and dlconnectedMAC_ehsFlows for MAC-ehs configurations in dedicated.</p> <p>dlconnectedMAC_ehsCommonFlow is used for MAC-ehs in Common state. For BCCH and PCCH in common state, the mac_ehs_QueueId is omitted, no reordering is applied and the TSN and SI fields are always set to zero (according to 3GPP TS 25.321 [17], subclauses 9.1.4 and 11.6.4.4)</p> <p>dlconnectedMAC_ehsFlowsDC is used when dual cell is activated.</p>
Type Definition	
<pre> SEQUENCE { ulconnectedTrCHList SEQUENCE (SIZE (1..maxulTrCH)) OF SEQUENCE { trchid TransportChannelIdentity, trCH_LogCHMappingList TrCH_LogCHMappingList } OPTIONAL, dlconnectedTrCHList SEQUENCE (SIZE (1..maxdlTrCH)) OF SEQUENCE { trchid TransportChannelIdentity, trCH_LogCHMappingList TrCH_LogCHMappingList } OPTIONAL, dlconnectedMACdFlows SEQUENCE (SIZE (1..8)) OF SEQUENCE { mac_dFlowId MAC_d_FlowIdentity, trCH_LogCHMappingList TrCH_LogCHMappingList } OPTIONAL, -- Rel-5 or later dlconnectedMAC_ehsFlows SEQUENCE (SIZE (1..8)) OF SEQUENCE { mac_ehs_QueueId MAC_ehs_QueueId, trCH_LogCHMappingList TrCH_LogCHMappingList } OPTIONAL, -- Rel-7 or later dlconnectedMAC_ehsCommonFlows SEQUENCE (SIZE (1..8)) OF SEQUENCE { mac_ehs_QueueId MAC_ehs_QueueId OPTIONAL, -- not present for BCCH/PCCH trCH_LogCHMappingList TrCH_LogCHMappingList } OPTIONAL, -- Rel-7 or later dlconnectedMAC_ehsFlowsDC SEQUENCE (SIZE (1..8)) OF SEQUENCE { mac_ehs_QueueId MAC_ehs_QueueId, trCH_LogCHMappingList TrCH_LogCHMappingList, } OPTIONAL -- Rel-8 or later } </pre>	

ASN.1 Type Definition	
Type Name	TrCH_LogCHMappingList
Comment	maxLogCHperTrCH = 15
Type Definition	
SEQUENCE (SIZE (1..maxLogCHperTrCH)) OF TrCH_LogicalChannelMapping	

ASN.1 Type Definition	
Type Name	TrCHInfo
Comment	<p>The same TFCS information should be provided to the PHY and MAC layers at all times. When a CMAC_Config_REQ is used to configure the MAC layer, a corresponding CPHY_TrCH_Config_REQ should be sent to the PHY layer to ensure that the configuration is consistent.</p> <p>For MAC-hs configuration: When ulconnectedTrCHList, ulTFCS, dlconnectedTrCHList and dlTFCS are omitted and hsDSCHMacdFlows is present this ASP configures an MAC-hs entity.</p> <p>For MAC-ehs configuration: When ulconnectedTrCHList, ulTFCS, dlconnectedTrCHList and dlTFCS are omitted and ehs_DSCH_Flows or E-HS-DSCH_Common Flows or ehs_DSCH_Flows_r9 is present this ASP configures an MAC-ehs entity. Only one of hsDSCHMacdFlows or ehs_DSCH_Flows or ehs_DSCH_Flows_r9 can be present (Only one of MAC-hs or MAC-ehs layer can be configured).</p>
Type Definition	
<pre>SEQUENCE { ulconnectedTrCHList SEQUENCE (SIZE (1..maxulTrCH)) OF SEQUENCE { trchid TransportChannelIdentity, transportChannelInfo CommonOrDedicatedTFS } OPTIONAL, ulTFCS TFCS OPTIONAL, dlconnectedTrCHList SEQUENCE (SIZE (1..maxdlTrCH)) OF SEQUENCE { trchid TransportChannelIdentity, transportChannelInfo CommonOrDedicatedTFS } OPTIONAL, dlTFCS TFCS OPTIONAL, hsDSCHMacdFlows HS_DSCHMACdFlows OPTIONAL, -- Rel-5 or later ehs_DSCH_Flows EHS_DSCH_Flows OPTIONAL, -- Rel-7 or later ehs_DSCH_CommonFlows EHS_DSCH_CommonFlows OPTIONAL, -- Rel-7 or later ehs_DSCH_Flows_r9 EHS_DSCH_Flows_r9 OPTIONAL -- Rel-9 or later }</pre>	

ASN.1 Type Definition	
Type Name	TrCH_LogicalChannelMapping
Comment	<p>When used for logical channel to MAC_d flow mapping dl_LogicalChannelMapping shall be chosen,</p>
Type Definition	
<pre>SEQUENCE { logicalChannel_Mapping CHOICE { ul_LogicalChannelMapping SS_UL_LogicalChannelMapping, dl_LogicalChannelMapping SS_DL_LogicalChannelMapping }, rB_Identity INTEGER (-31..32) OPTIONAL, cn_DomainIdentity CN_DomainIdentity OPTIONAL }</pre>	

ASN.1 Type Definition	
Type Name	SS_UL_LogicalChannelMapping
Comment	<p>If the macHeaderManipulation field is 'NormalMacHeader', then data received on the transport channel supporting this logical channel shall have it's MAC header inspected to determine the appropriate routing, and removed as normal. The MAC SDU shall be passed to the appropriate logical channel.</p> <p>If the macHeaderManipulation field is 'OmitMacHeader', then data received on the transport channel supporting this logical channel shall have it's MAC header inspected to determine the appropriate routing, but the MAC layer shall not remove the MAC header. Thus the entire MAC PDU shall be passed to the appropriate logical channel, and the MAC header can be checked by the TTCN.</p>
Type Definition	
<pre>SEQUENCE { macHeaderManipulation MAC_HeaderManipulation, ul_TransportChannelType SS_UL_TransportChannelType, logicalChannelIdentity LogicalChannelIdentity, logicalChannelType LogicalChannelType }</pre>	

ASN.1 Type Definition	
Type Name	SS_DL_LogicalChannelMapping
Comment	<p>If the macHeaderManipulation field is 'NormalMacHeader', then data transmitted on this logical channel shall have an appropriate MAC header added before it is sent to lower layers for transmission.</p> <p>If the macHeaderManipulation field is 'OmitMacHeader', then data transmitted on this logical channel shall not have any MAC header information added, even if the logical channel type and mapping indicates that there should be a MAC header present. This allows the entire MAC PDU to be specified in the TTCN, so individual fields in the MAC header can be modified.</p> <p>When used for DTCH mapping to MAC_d flow, rlc_SizeList shall choose "configured" according to the configured mACHsAddReconfQueue values.</p> <p>When the logical channel is MTCH, the logicalChannelIdentity shall be consistent with MBMS_LogicalChIdentity in MBMS_PTM_RBInformation_N and MBMS_PTM_RBInformation_C.</p>
Type Definition	
<pre>SEQUENCE { macHeaderManipulation MAC_HeaderManipulation, dlTransportChannelType SS_DL_TransportChannelType, logicalChannelIdentity LogicalChannelIdentity, logicalChannelType LogicalChannelType, rlc_SizeList CHOICE { allSizes NULL, configured NULL, explicitList RLC_SizeExplicitList}, mac_LogicalChannelPriority MAC_LogicalChannelPriority OPTIONAL }</pre>	

ASN.1 Type Definition	
Type Name	SS_UL_TransportChannelType
Comment	
Type Definition	
<pre>ENUMERATED { dch (0), rach (1), cpch (2), usch (3), edch (4) -- Rel-6 or later }</pre>	

ASN.1 Type Definition	
Type Name	SS_DL_TransportChannelType
Comment	
Type Definition	
<pre>ENUMERATED { dch (0), fach (1), bch (2), pch (3), dsch (4), hsdsch (5) -- Rel-5 or later }</pre>	

ASN.1 Type Definition	
Type Name	LogicalChannelType
Comment	
Type Definition	
<pre>ENUMERATED { bCCH (0), pCCH (1), cCCH (2), cTCH (3), dCCH (4), dTCH (5), sHCCH (6), mTCH (7), -- Rel-6 or later mCCH (8), -- Rel-6 or later mSCH (9) -- Rel-6 or later }</pre>	

ASN.1 Type Definition	
Type Name	MAC_HeaderManipulation
Comment	
Type Definition	
<pre> ENUMERATED { normalMacHeader (0), omitMacHeader (1) } </pre>	

ASN.1 Type Definition	
Type Name	ServingAndSecondaryCellActivation_Type
Comment	
Type Definition	
<pre> SEQUENCE { servingCellId INTEGER(0..63), secondaryCellId INTEGER(0..63), secondaryServing_HS_DSCH_Cell ENUMERATED { deactivated (0), activated (1) } DEFAULT deactivated } </pre>	

7.3.2.2.17a CMAC_MACHs_MACehs_TFRCconfigure (Rel-5 or later)

ASN.1 ASP Type Definition	
Type Name	CMAC_MACHs_MACehs_TFRCconfigure_CNF
PCO Type	CSAP
Comment	Applicable Rel-5 or later Confirm a previous CMAC_MACHs_MACehs_TFRCconfigure_REQ being successful.
Type Definition	
<pre> SEQUENCE { cellId INTEGER(-1..63) } </pre>	

ASN.1 ASP Type Definition	
Type Name	CMAC_MAChs_MACehs_TFRCconfigure_REQ
PCO Type	CSAP
Comment	<p>Applicable Rel-5 or later</p> <p>To configure the TFRC selection in the MAC-hs entity, channelisationCodeOffset + noOfChannelisationCodes shall not be great than 15.</p> <p>If explicitlyConfigured is selected in <code>tfrcConfigMode</code>, the SS shall use all the parameter values specified to configure a correct transport format and radio resources. This configuration is used for HS-SCCH associated HS-DSCH transmission.</p> <p>If <code>sS_Configured</code> is selected, the parameter value range is specified. SS shall dynamically select the suitable values for the parameters "modulationScheme", "channelisationCodeOffset", "noOfChannelisationCodes ", ".tbSizeIndexOnHS_SCCH", "redundancyVersion" and "hs_PDSCH_TxPower" according to UE's capability category and CQI information reported by the UE. As HS-SCCH less operation and MIMO cannot be simultaneously configured, only one among <code>hs_scch_LessInfo</code> and <code>mimoStatus</code> can be present. When both are absent non MIMO, non HS-SCCH less operation is configured.</p> <p><code>explicitHS_SCCH_LessMode</code> is used to force SS to use HS-SCCH less operation. <code>explicitMIMO</code> is used for MIMO dual stream transmission. Presence of <code>ss_DTX_Info</code> indicates DL_DRX is enabled.</p> <p>If <code>minimumInterTTIinterval</code> is set to 1, Data is sent every TTI. If it is set to 2, every TTI with Data shall be followed by at least 1 TTI without Data. If it is set to 3, every TTI with Data shall be followed by at least 2 TTI without Data. This field needs to be set as per UE category as defined in Table 5.1a of 3GPP TS 25.306 [59].</p>
Type Definition	

```

SEQUENCE {
  cellId          INTEGER(-1..63),
  tfrcConfigMode CHOICE {
    explicitlyConfigured SEQUENCE {
      modulationScheme      ModulationScheme,
      channelisationCodeOffset INTEGER (1..15),
      noOfChannelisationCodes INTEGER (1..15),
      tbSizeIndexOnHS_SCCH  INTEGER (0..63),
      minimumInterTTIinterval INTEGER (1..3),
      redundancyVersions     RedundancyVersionList,
      hs_PDSCH_TxPower      DL_TxPower -- default offset related
                                -- to p-CPICH or s-CPICH
    },
    sS_Configured SEQUENCE {
      minChannelisationCodeOffset INTEGER (1..15),
      maxNoOfChannelisationCodes  INTEGER (1..15),
      iniHS_PDSCH_TxPower         DL_TxPower, -- default offset related
                                -- to p-CPICH or s-CPICH
      hs_scch_LessInfo           HS_SCCH_LessInfo_r7 OPTIONAL,
      mimoStatus                 BOOLEAN          DEFAULT FALSE
    },
    explicitHS_SCCH_LessMode SEQUENCE{
      hs_pdsch_CodeIndex      INTEGER (1..15),
      hs_scch_LessTFI         INTEGER (1..90),
      hs_scch_LessSecondCodeApplicability BOOLEAN,
      tbs                     INTEGER (0..3),
                                -- the index of tbs for HS-SCCH less operation
                                -- The value should be consistent with code index, TFI and second
                                -- code applicability
      minimumInterTTIinterval INTEGER (1..3),
      hs_PDSCH_TxPower        DL_TxPower
                                -- default offset related to p-CPICH or s-CPICH
    },
    explicitMIMO SEQUENCE {
      modulationSchemeAndNumTB INTEGER(0..7),
                                -- set according to table 14 of 25.212
                                -- Values 1,2 and 5 are used for 64QAM+MIMO. Rel-8 or later
      channelisationCodeOffset INTEGER (1..15),
      noOfChannelisationCodes  INTEGER (1..15),
      precodingWeight2         INTEGER (0..3),
                                -- set according to table 14a of 25.212
      primaryTB_SizeIndexOnHS_SCCH INTEGER (0..63),
      secondaryTB_SizeIndexOnHS_SCCH INTEGER (0..63) OPTIONAL,
                                --present only if second TB is to be tx as per modulationSchemeAndNumTB
      minimumInterTTIinterval  INTEGER (1..3),
      primaryRedundancyVersions RedundancyVersionList,
      secondaryRedundancyVersions RedundancyVersionList OPTIONAL,
                                --present only if second TB is to be tx as per modulationSchemeAndNumTB
      hs_PDSCH_TxPower         DL_TxPower -- default offset related
                                -- to p-CPICH or s-CPICH
    },
    sS_Configured_DC SEQUENCE {
      serving_minChannelisationCodeOffset INTEGER (1..15),
      serving_maxNoOfChannelisationCodes  INTEGER (1..15),
      serving_mimoStatus                 BOOLEAN DEFAULT FALSE, -- Rel-9 or later
      sec_minChannelisationCodeOffset    INTEGER (1..15),
      sec_maxNoOfChannelisationCodes     INTEGER (1..15),
      sec_mimoStatus                     BOOLEAN DEFAULT FALSE, -- Rel-9 or later
      iniHS_PDSCH_TxPower                DL_TxPower,
                                -- default offset related
                                -- to p-CPICH or s-CPICH
      hs_scch_LessInfo                   HS_SCCH_LessInfo_r7 OPTIONAL
    },
    explicitlyDC SEQUENCE {
      servingTFRC SEQUENCE{
        modulationScheme      ModulationScheme,
        channelisationCodeOffset INTEGER (1..15),
        noOfChannelisationCodes INTEGER (1..15),
        tbSizeIndexOnHS_SCCH  INTEGER (0..63),
        minimumInterTTIinterval INTEGER (1..3),
        redundancyVersions     RedundancyVersionList,
        hs_PDSCH_TxPower      DL_TxPower -- default offset related
                                -- to p-CPICH or s-CPICH
      } OPTIONAL,
      -- when omitted then no data is sent on the serving HS-DSCH cell
      secondaryTFRC SEQUENCE{
        modulationScheme      ModulationScheme,
        channelisationCodeOffset INTEGER (1..15),
        noOfChannelisationCodes  INTEGER (1..15),
        tbSizeIndexOnHS_SCCH  INTEGER (0..63),
        minimumInterTTIinterval INTEGER (1..3),
        redundancyVersions     RedundancyVersionList,
        hs_PDSCH_TxPower      DL_TxPower -- default offset related
                                -- to p-CPICH or s-CPICH
      }
    }
  }
}

```

ASN.1 Type Definition	
Type Name	RedundancyVersionList
Comment	Gives the Redundancy and constellation version coding sequence (Xrv) to be used for every transmission / retransmission. The SIZE (number of Xrv elements in there) of the SEQUENCE implies the number of HARQ transmission / retransmissions to be required.
Type Definition	
SEQUENCE (SIZE (1..8)) OF INTEGER (0..7)	

ASN.1 Type Definition	
Type Name	ModulationScheme
Comment	
Type Definition	
ENUMERATED {qpsk (0), qam16 (1), qam64 (2), spare1 (3)}	

7.3.2.2.17a0 CMAC_MACChs_MACehs_HARQprocAssign

ASN.1 ASP Type Definition	
Type Name	CMAC_MACChs_MACehs_HARQprocAssign_CNF
PCO Type	CSAP
Comment	Applicable Rel-5 or later Confirm a previous CMAC_MACChs_MACehs_HARQprocAssign_REQ being successful.
Type Definition	
SEQUENCE { cellId INTEGER (-1..63) }	

ASN.1 ASP Type Definition	
Type Name	CMAC_MACChs_MACehs_HARQprocAssign_REQ
PCO Type	CSAP
Comment	Applicable Rel-5 or later To assign a HARQ process handling the next MAC-hs PDU transmission. This ASP provides TTCN the ability to select an HARQ process serving the next MAC-hs PDU which follows the ASP. After successful transmission the MAC-hs returns back to normal operation. In the normal operation a suitable HARQ process is selected by HARQ entity in the MAC-hs to serve the MAC-hs PDU without TTCN intervening.
Type Definition	
SEQUENCE { cellId INTEGER (-1..63), harqProcessId INTEGER (0..15 31) }	

7.3.2.2.17a1 CMAC_MACehs_HARQAssign_MultiFlows (Rel-7 or later)

ASN.1 ASP Type Definition	
Type Name	CMAC_MACehs_HARQAssign_MultiFlows_CNF
PCO Type	CSAP
Comment	Applicable Rel-7 or later Confirm a previous CMAC_MACehs_HARQAssign_MultiFlows_REQ being successful.
Type Definition	
SEQUENCE { cellId INTEGER (-1..63) }	

ASN.1 ASP Type Definition	
Type Name	CMAC_MACehs_HARQAssign_MultiFlows_REQ
PCO Type	CSAP
Comment	<p>Applicable Rel-7 or later</p> <p>To assign the HARQ processes for the simultaneous transmission of the MAC-ehs PDUs on the different flows on the same TTI .</p> <p>After successful transmission the MAC-ehs returns back to normal operation. In the normal operation suitable HARQ processes are selected by HARQ entities in the MAC-ehs to serve the MAC-ehs PDU without TTCN intervening.</p> <p>For Dual Cell, the primaryFlow corresponds to the serving cell, the secPrimaryFlow corresponds to the secondary cell.</p> <p>For MIMO, the primary and secondary HARQ process identities (of serving cell) are set as per 3GPP TS 25.212 [58], subclause 4.6B.2.5.</p> <p>For combined DC-HSDPA and MIMO the primaryFlow and secondary flow correspond to the serving cell, the secPrimaryFlow and secSecondaryFlow to the secondary cell.</p>
Type Definition	
<pre>SEQUENCE { cellId INTEGER (-1..63), primaryFlowHarqProcessId INTEGER (0..15 31), -- of serving cell secondaryFlowHarqProcessId INTEGER (0..15 31) OPTIONAL, -- of serving cell secPrimaryFlowHarqProcessId INTEGER (0..15 31) OPTIONAL, -- of secondary cell Rel-9 or later secSecondaryFlowHarqProcessId INTEGER (0..15 31) OPTIONAL -- of secondary cell Rel-9 or later }</pre>	

7.3.2.2.17aa CMAC _MACehs_HS_SCCH_Orders (Rel-7 or later)

ASN.1 ASP Type Definition	
Type Name	CMAC_MACehs_HS_SCCH_OrdersCNF
PCO Type	CSAP
Comment	<p>Applicable Rel-7 or later</p> <p>Confirm a previous CMAC _MACehs_HS_SCCH_Orders_REQ being successful.</p>
Type Definition	
<pre>SEQUENCE { cellId INTEGER (-1..63), routingInfo RoutingInfo -- Physical Channel ID }</pre>	

ASN.1 ASP Type Definition	
Type Name	CMAC_MACehs_HS_SCCH_OrdersREQ
PCO Type	CSAP
Comment	<p>Applicable Rel-7 or later</p> <p>To instruct SS to transmit requested HS-SCCH orders at requested time: OrderType, drx_order, dtx_Order are as per 3GPP TS 25.212 [58], subclause 4.6c.2.</p> <p>Cfn and subframe together indicate, the time on which the HS-SCCH order is to be transmitted.</p>
Type Definition	
<pre>SEQUENCE { cellId INTEGER (-1..63), routingInfo RoutingInfo, -- Physical Channel ID cfn INTEGER (0..255), subframe INTEGER (0..4), ordertype INTEGER (0..7), xord1 INTEGER (0..1), xord2 INTEGER (0..1), xord3 INTEGER (0..1), h_RNTI H_RNTI }</pre>	

7.3.2.2.17b CMAC_MACe_Config (Rel-6 or later)

ASN.1 ASP Type Definition	
Type Name	CMAC_MACe_Config_CNF
PCO Type	CSAP
Comment	Confirm a previous CMAC_MACe_Config_REQ being successful.
Type Definition	
<pre>SEQUENCE { nodeB_Id INTEGER(0..63) }</pre>	

ASN.1 ASP Type Definition	
Type Name	CMAC_MACe_Config_REQ
PCO Type	CSAP
Comment	
Type Definition	
<pre>SEQUENCE { nodeB_Id INTEGER(0..63), configMessage CHOICE { setup MACeConfig, reconfig MACeConfig, reset NULL, release SS_ActivationTime } }</pre>	

ASN.1 Type Definition	
Type Name	MACeConfig
Comment	<p>If the macHeaderManipulation field is 'NormalMacHeader' in ddiMappingList, then data received on the E-DCH (MAC_e PDU) shall have it's MAC header inspected to de-multiplex and to determine the appropriate routing, and the MACes PDU shall be passed to the MAC_es together with the relevant DDI, N, CFN and subframe number.</p> <p>If the macHeaderManipulation field field is 'OmitMacHeader', then data received on the E-DCH (MAC_e PDU) shall have it's MAC header inspected to de-multiplex and to determine the appropriate routing, then the MAC_e layer shall delivery the MAC-es PDU, SI and the related CFN, subframe number to the MAC_es entity.</p> <p>connectedToMAC_es field is used to provide the possibility that the E-DCH-MACdFlows from only one MAC_e entity are connected to the MAC_es entity in the inter node B soft handover test cases.</p> <p>The IEs ddiMappinglist and e_DCHMacdFlows can be OMITted when changing the serving cell MAC-e without modification of MAC-e configurations. It will be applied in EDCH SHO.</p> <p>ss_DRX_MAC_Info presence indicates UL DRX shall be applied.</p>
Type Definition	
<pre>SEQUENCE { activationTime SS_ActivationTime, ddiMappinglist DDI_MappingList OPTIONAL, e_DCHMacdFlows E_DCHMACdFlows OPTIONAL, connectedToMAC_es BOOLEAN DEFAULT TRUE, -- can be set to FALSE in inter nodeB SHO ss_DRX_MAC_Info SS_DRX_MAC_Info OPTIONAL }</pre>	

ASN.1 Type Definition	
Type Name	SS_DRX_MAC_Info
Comment	Consistent with E-DCH TTI, either of mac_dtx_Cycle_2ms or mac_dtx_Cycle_10ms shall be present.
Type Definition	
<pre>SEQUENCE { mac_InactivityThreshold MAC_InactivityThreshold, mac_dtx_Cycle_2ms MAC_DTX_Cycle_2ms OPTIONAL, mac_dtx_Cycle_10ms MAC_DTX_Cycle_10ms OPTIONAL, timingInfo NewTiming }</pre>	

7.3.2.2.17c CMAC_MACe_NodeB_CellMapping (Rel-6 or later)

ASN.1 ASP Type Definition	
Type Name	CMAC_MACe_NodeB_CellMapping_CNF
PCO Type	CSAP
Comment	Confirm a previous CMAC_MACe_NodeB_CellMapping_REQ being successful.
Type Definition	
SEQUENCE {	
nodeB_Id	INTEGER (0..63)
}	

ASN.1 ASP Type Definition	
Type Name	CMAC_MACe_NodeB_CellMapping_REQ
PCO Type	CSAP
Comment	To put a set of cells under the control of a MAC_e entity indicated by nodeB_Id, which is configured by CMAC_MAC_e_Config_REQ. This ASP establishes the routing relation between E-DCH related channels in these cells with a MAC_e entity. A cell is mapped to only one NodeB, and the cellId allocation is unique in a test.
Type Definition	
SEQUENCE {	
nodeB_Id	INTEGER (0..63),
celllist	SEQUENCE OF INTEGER (0..63)
}	

7.3.2.2.17d CMAC_MACes_Config (Rel-6 or later)

ASN.1 ASP Type Definition	
Type Name	CMAC_MACes_Config_CNF
PCO Type	CSAP
Comment	Confirm a previous CMAC_MACes_Config_REQ being successful. cellId=-1.
Type Definition	
SEQUENCE {	
cellId	INTEGER (-1..63)
}	

ASN.1 ASP Type Definition	
Type Name	CMAC_MACes_Config_REQ
PCO Type	CSAP
Comment	This ASP is used for creating and configuring, reconfiguring, resetting or releasing an MAC_es, a cell / nodeB-independent entity in the SS. cellId=-1.
Type Definition	
SEQUENCE {	
cellId	INTEGER (-1..63),
configMessage	CHOICE {
setup	MACesConfig,
reconfig	MACesConfig,
reset	NULL,
release	SS_ActivationTime}
}	

ASN.1 Type Definition	
Type Name	MACesConfig
Comment	MACesConfig establishes the mapping between logical channels and E-DCH_MACd_Flows. When the macTestMode is TRUE, the re-ordering entity shall not eliminate the duplicated packets, but passes them to RLC. macTestMode = "TRUE" is used for testing the retransmission function of HARQ process.
Type Definition	
SEQUENCE	{ activationTime SS_ActivationTime, ddiMappingList DDI_MappingList, macTestMode BOOLEAN DEFAULT FALSE }

ASN.1 Type Definition	
Type Name	DDI_MappingList
Comment	
Type Definition	
SEQUENCE (SIZE (1..31)) OF	DDI_Mapping

ASN.1 Type Definition	
Type Name	DDI_Mapping
Comment	Both SRBs and RBs can be mapped onto E-DCH. The mechanism for control of MAC header manipulation (macHeaderManipulation) is applied to individual logical channels to be mapped on E-DCH. Typically, the SRBs are configured in 'NormalMacHeader' mode while the RBs in user plane can be configured either in 'NormalMacHeader' or in 'OmitMacHeader' mode. If more than one UL RLC PDU size is configured for the RB (represent by logicalChannelIdentity), the different sizes will use subsequent DDI values starting from the DDI value in this table. If the value of macHeaderManipulation field is 'NormalMacHeader', then data received on the E-DCH MACd flows supporting this logical channel shall have its MAC header inspected to determine the appropriate routing, and removed as normal. The MACes SDU shall be passed to the appropriate logical channel. If the value of macHeaderManipulation field is 'OmitMacHeader', then data received on the E-DCH MACd flows supporting this logical channel shall have its MAC header inspected to determine the appropriate routing, then the MAC_es layer shall deliver the MAC-es SDU, SI and the related CFN, subframe number, HARQ process identity to the appropriate logical channel. The TTCN receives these fields by RLC_TR_MACesDATA_IND, then these fields can be checked by the TTCN. HARQ ID = CFN mod 4 for TTI=10ms; HARQ ID = (5*CFN + subframe number) mod 8 for TTI=2ms
Type Definition	
SEQUENCE {	macHeaderManipulation MAC_HeaderManipulation, logicalChannelIdentity LogicalChannelIdentity, e_DCH_MAC_d_FlowIdentity E_DCH_MAC_d_FlowIdentity, ddi DDI, rlc_PDU_SizeList RLC_PDU_SizeList, includeInSchedulingInfo BOOLEAN, mac_LogicalChannelPriority MAC_LogicalChannelPriority, logicalChannelType LogicalChannelType, rB_Identity INTEGER (-31..32) OPTIONAL }

7.3.2.2.17e CMAC_MACe_AG (Rel-6 or later)

ASN.1 ASP Type Definition	
Type Name	CMAC_MACe_AG_CNF
PCO Type	CSAP
Comment	Confirm a previous CMAC_MACe_AG_REQ being successful.
Type Definition	
SEQUENCE {	nodeB_Id INTEGER (0..63) }

ASN.1 ASP Type Definition	
Type Name	CMAC_MACe_AG_REQ
PCO Type	CSAP
Comment	The hARQProclId shall be converted to the nearest CFN (and subframe number if TTI = 2 ms) by the SS, and the Absolute Grant is sent in that CFN (and subframe number if TTI = 2 ms)
Type Definition	
SEQUENCE	{ nodeB_Id INTEGER(0..63), grantType ENUMERATED {primary(0), secondary(1)}, absoluteGrantValue BIT STRING(SIZE(5)), absoluteGrantScope BIT STRING(SIZE(1)), hARQProcId INTEGER(0..7), activationTime SS_ActivationTime }

7.3.2.2.17f CMAC_MACe_AckNack (Rel-6 or later)

ASN.1 ASP Type Definition	
Type Name	CMAC_MACe_AckNack_CNF
PCO Type	CSAP
Comment	To Confirm CMAC_e_AckNack_REQ
Type Definition	
SEQUENCE	{ nodeB_Id INTEGER(0..63) }

ASN.1 ASP Type Definition	
Type Name	CMAC_MACe_AckNack_REQ
PCO Type	CSAP
Comment	To request the SS to set operation mode of the Ack/Nack function for the HARQ process hARQProclId. The harqProclId, between 0 to 3 for 10 ms TTI or 0 to 7 for 2 msTTI, is individually applied to the configuration for the normal / nack mode. If the special hARQProclId -1 is used, all active HARQ processes (0..3 for 10 ms TTI and 0..7 for 2 ms TTI) will be configured according to ackNackFunction. At the SS initialization Ack/Nack function is in normal operation mode
Type Definition	
SEQUENCE	{ nodeB_Id INTEGER(0..63), hARQProcId INTEGER(-1 0..7), ackNackFunction AckNackFunction }

ASN.1 Type Definition	
Type Name	AckNackFunction
Comment	normal : put the HARQ process in normal operation mode, it generates the ACK or NACK according to whether the received TB block can be decoded correctly and delivery the correctly decoded data to higher layer. When the MAC_e is configured the HARQ process is in normal operation mode. nack : put the HARQ process in the special operation mode in which the HARQ process always sends NACK for the received TB block till the number of the retransmissions reaches the number indicated in this field. The HARQ process is back to the normal operation mode after the number is reached or received a normal mode request. Except each received TB shall be passed to higher layer, other operations are the same as a real NACK occurred.
Type Definition	
CHOICE	{ normal NULL, nack E_DCH_MAC_d_FlowMaxRetrans }

7.3.2.2.17g CMAC_MACe_E_TFC_Restriction (Rel-6 or later)

ASN.1 ASP Type Definition	
Type Name	CMAC_MACe_E_TFC_Restriction_CNF
PCO Type	CSAP
Comment	For MAC emulator to report that a previous attempt of restricting TFCs have been successful.
Type Definition	
SEQUENCE	{ nodeB_Id INTEGER (0..63) }

ASN.1 ASP Type Definition	
Type Name	CMAC_MACe_E_TFC_Restriction_REQ
PCO Type	CSAP
Comment	To request to configure MACe entity. The field restrictAllowedTFCs is provided to allow the E-TFCI to be restricted. The IE fullE_TFCS will be used to remove any previous E_TFCS restriction configured.
Type Definition	
SEQUENCE	{ nodeB_Id INTEGER (0..63), restrictAllowedTFCs CHOICE { e_TFCS_Restriction E_TFCS_Restriction, fullE_TFCS NULL } }

ASN.1 Type Definition	
Type Name	E_TFCS_Restriction
Comment	The E_TFCS restriction is a list of E-TFCIs, and can be used to verify that the UE has used a specific TFC. Any data received by the SS using a forbidden TFCI shall be discarded.
Type Definition	
SEQUENCE OF INTEGER (0..127)	

7.3.2.2.17h CMAC_MACe_RG (Rel-6 or later)

ASN.1 ASP Type Definition	
Type Name	CMAC_MACe_RG_CNF
PCO Type	CSAP
Comment	Confirm a previous CMAC_MACe_RG_REQ being successful.
Type Definition	
SEQUENCE	{ nodeB_Id INTEGER (0..63) }

ASN.1 ASP Type Definition	
Type Name	CMAC_MACe_RG_REQ
PCO Type	CSAP
Comment	For non-serving RL the value for relativeGrant is limited to "down" and "hold". The SS shall convert the hARQProcId to the nearest CFN (and subframe number if TTI = 2 ms) by the SS and send the Relative Grant in that CFN (and subframe number if TTI = 2 ms)
Type Definition	
SEQUENCE	{ nodeB_Id INTEGER (0..63), relativeGrant ENUMERATED {up(0), down(1), hold(2)}, hARQProcId INTEGER (0..7), activationTime SS_ActivationTime }

7.3.2.2.17ha Void

7.3.2.2.17i CMAC_MACes_SI_IND (Rel-6 or later)

ASN.1 ASP Type Definition	
Type Name	CMAC_MACes_SI_IND
PCO Type	CSAP
Comment	This ASP is used for MACes delivering scheduling information in MAC_es testing. cellId=-1. If the SI was sent alone in a MAC-e PDU or sent together with other MAC-es PDU in a MAC-e PDU but without a special DDI associated the value of specialDDIpresence is set to absent; If the SI was sent together with other MAC-es PDU in a MAC-e PDU with a special DDI (DDI 63) associated the specialDDIpresence is set to present.
Type Definition	
SEQUENCE	{
cellId	INTEGER (-1..63),
cfn	INTEGER (0..255),
subframe	INTEGER (0..4 7), -- 0..4 when TTI=2ms, 7 when
TTI=10ms	
specialDDIpresence	ENUMERATED {absent (0), present (1)},
uePowerHeadRoom	BIT STRING (SIZE(5)),
totalE_DCHBufferStatus	BIT STRING (SIZE(5)),
highestPriorityLogChBS	BIT STRING (SIZE(4)),
highestPriorityLogChId	BIT STRING (SIZE(4))
	}

7.3.2.2.17j CMAC_MACes_SI_Config (Rel-6 or later)

ASN.1 ASP Type Definition	
Type Name	CMAC_MACes_SI_Config_CNF
PCO Type	CSAP
Comment	Applicable Rel-6 or later To Confirm CMAC_MACes_SI_Config_REQ, cellId=-1.
Type Definition	
SEQUENCE	{
cellId	INTEGER (-1..63)
	}

ASN.1 ASP Type Definition	
Type Name	CMAC_MACes_SI_Config_REQ
PCO Type	CSAP
Comment	Applicable Rel-6 or later To configure the SS to enable / disable to report the reception of Scheduling Information in MAC-es PDU's via primitive CMAC_MACes_SI_IND. At the SS initialization, the default mode is SI reporting disabled. cellId=-1.
Type Definition	
SEQUENCE	{
cellId	INTEGER (-1..63),
sI_reportEnable	ENUMERATED {disable(0), enable(1)} DEFAULT disable
	}

7.3.2.2.17k CMAC_MACi_Config (Rel-8 or later)

ASN.1 ASP Type Definition	
Type Name	CMAC_MACi_Config_CNF
PCO Type	CSAP
Comment	Confirm a previous CMAC_MACi_Config_REQ being successful.
Type Definition	
SEQUENCE	{
nodeB_Id	INTEGER (0..63)
	}

ASN.1 ASP Type Definition	
Type Name	CMAC_MACi_Config_REQ
PCO Type	CSAP
Comment	
Type Definition	
<pre>SEQUENCE { nodeB_Id INTEGER(0..63), configMessage CHOICE { setup MACiConfig, reconfig MACiConfig, reset NULL, release SS_ActivationTime } }</pre>	

ASN.1 Type Definition	
Type Name	MACiConfig
Comment	<p>If the macHeaderManipulation field is 'NormalMacHeader' in ICH_Mappinglist, then data received on the E-DCH (MAC_i PDU) shall have it's MAC header inspected to de-multiplex and to determine the appropriate routing, and the MACis PDU shall be passed to the MAC_is together with the relevant LCH_ID, length, F, CFN and subframe number.</p> <p>If the macHeaderManipulation field field is 'OmitMacHeader', then data received on the E-DCH (MAC-i PDU) shall have it's MAC header inspected to de-multiplex and to determine the appropriate routing, then the MAC-i layer shall deliver the MAC-is PDU, SI and the related CFN, subframe number to the MAC-is entity.</p> <p>connectedToMAC_is field is used to provide the possibility that the E-DCH-MACdFlows from only one MAC-i entity are connected to the MAC_is entity in the inter node B soft handover test cases. When MAC-i is configured in enhanced FACH UL using commonMac_i_r8, the MAC-i entity is always connected to MAC-is. In DC-HSUPA configuration, two MAC-i entities are connected to the MAC-is entity.</p> <p>The IEs ICH_Mappinglist and e_DCHMacdFlows can be OMITted when changing the serving cell MAC-i without modification of MAC-i configurations. It will be applied in EDCH SHO.</p> <p>ss_DRX_MAC_Info presence indicates UL DRX shall be applied.</p>
Type Definition	
<pre>CHOICE { mac_i_r8 SEQUENCE { activationTime SS_ActivationTime, lch_Mappinglist LCH_MappingList OPTIONAL, e_DCHMacdFlows E_DCHMACdFlows OPTIONAL, connectedToMAC_is BOOLEAN DEFAULT TRUE, -- can be set to FALSE in inter nodeB SHO ss_DRX_MAC_Info SS_DRX_MAC_Info OPTIONAL }, commonMac_i_r8 SEQUENCE { activationTime SS_ActivationTime, lch_Mappinglist LCH_MappingList OPTIONAL, e_DCHMacdFlows CommonE_DCHMACdFlows OPTIONAL, additional_E_DCH_TransmitBackoff INTEGER (0..15), max_CCCH_ResourceAllocation ENUMERATED { tti8(0), tti12(1), tti16(2), tti20(3), tti24(4), tti32(5), tti40(6), tti80(7)}, max_PeriodForCollisionResolution INTEGER (8..24) }, spare1 NULL }</pre>	

7.3.2.2.17l CMAC_MACi_NodeB_CellMapping (Rel-8 or later)

ASN.1 ASP Type Definition	
Type Name	CMAC_MACi_NodeB_CellMapping_CNF
PCO Type	CSAP
Comment	Confirm a previous CMAC_MACi_NodeB_CellMapping_REQ being successful.
Type Definition	
SEQUENCE {	
nodeB_Id	INTEGER (0..63)
}	

ASN.1 ASP Type Definition	
Type Name	CMAC_MACi_NodeB_CellMapping_REQ
PCO Type	CSAP
Comment	To put a set of cells under the control of a MAC_i entity indicated by nodeB_Id, which is configured by CMAC_MAC_i_Config_REQ. This ASP establishes the routing relation between E-DCH related channels in these cells with a MAC_i entity. A cell is mapped to only one NodeB, and the cellId allocation is unique in a test.
Type Definition	
SEQUENCE {	
nodeB_Id	INTEGER (0..63),
celllist	SEQUENCE OF INTEGER (0..63)
}	

7.3.2.2.17m CMAC_MACis_Config (Rel-8 or later)

ASN.1 ASP Type Definition	
Type Name	CMAC_MACis_Config_CNF
PCO Type	CSAP
Comment	Confirm a previous CMAC_MACis_Config_REQ being successful. cellId=-1.
Type Definition	
SEQUENCE {	
cellId	INTEGER (-1..63)
}	

ASN.1 ASP Type Definition	
Type Name	CMAC_MACis_Config_REQ
PCO Type	CSAP
Comment	This ASP is used for creating and configuring, reconfiguring, resetting or releasing an MAC_is, a cell / nodeB-independent entity in the SS, cellId=-1.
Type Definition	
SEQUENCE {	
cellId	INTEGER (-1..63),
configMessage	CHOICE {
setup	MACisConfig,
reconfig	MACisConfig,
reset	NULL,
release	SS_ActivationTime}
}	

ASN.1 Type Definition	
Type Name	MACisConfig
Comment	MACisConfig establishes the mapping between logical channels and E-DCH_MACd_Flows. When the macTestMode is TRUE, the re-ordering entity shall not eliminate the duplicated packets, but passes them to RLC. macTestMode = "TRUE" is used for testing the retransmission function of HARQ process.
Type Definition	
<pre>CHOICE { macIs_r8 SEQUENCE { activationTime SS_ActivationTime, -- Rel-8 or later lCHMappinglist LCH_MappingList, macTestMode BOOLEAN DEFAULT FALSE }, macIs_r9 SEQUENCE { activationTime SS_ActivationTime, -- Rel-9 or later lCHMappinglist LCH_MappingList, macTestMode BOOLEAN DEFAULT FALSE, tSN_FieldExtension BOOLEAN DEFAULT FALSE -- Used in DC-HSUPA }, spare1 NULL }</pre>	

ASN.1 Type Definition	
Type Name	LCH_MappingList
Comment	
Type Definition	
SEQUENCE (SIZE (1..31)) OF LCH Mapping	

ASN.1 Type Definition	
Type Name	LCH_Mapping
Comment	<p>Both SRBs and RBs can be mapped onto E-DCH. The mechanism for control of MAC header manipulation (macHeaderManipulation) is applied to individual logical channels to be mapped on E-DCH. Typically, the SRBs are configured in 'NormalMacHeader' mode while the RBs in user plane can be configured either in 'NormalMacHeader' or in 'OmitMacHeader' mode.</p> <p>If the value of macHeaderManipulation field is 'NormalMacHeader', then data received on the E-DCH MACd flows supporting this logical channel shall have its MAC header inspected to determine the appropriate routing, and removed as normal. The MACis SDU shall be passed to the appropriate logical channel.</p> <p>If the value of macHeaderManipulation field is 'OmitMacHeader', then data received on the E-DCH MACd flows supporting this logical channel shall have its MAC header inspected to determine the appropriate routing, then the MAC_is layer shall deliver the MAC-is SDU, LCH_ID, Length, F,SI and the related CFN, subframe number, HARQ process identity to the appropriate logical channel. The TTCN receives these fields by RLC_TR_MACis_DATA_IND, then these fields can be checked by the TTCN. HARQ ID = CFN mod 4 for TTI=10ms; HARQ ID = (5*CFN + subframe number) mod 8 for TTI=2ms</p>
Type Definition	
<pre>SEQUENCE { macHeaderManipulation MAC_HeaderManipulation, logicalChannelIdentity LogicalChannelIdentity, e_DCH_MAC_d_FlowIdentity E_DCH_MAC_d_FlowIdentity, rlc_PDU_Size CHOICE { flexibleSize RLC_PDU_SizeConstraint, fixedSize RLC_PDU_SizeList }, includeInSchedulingInfo BOOLEAN, mac_LogicalChannelPriority MAC_LogicalChannelPriority, logicalChannelType LogicalChannelType, rB_Identity INTEGER (-31..32) OPTIONAL }</pre>	

7.3.2.2.17n CMAC_MACi_AG (Rel-8 or later)

ASN.1 ASP Type Definition	
Type Name	CMAC_MACi_AG_CNF
PCO Type	CSAP
Comment	Confirm a previous CMAC_MACi_AG_REQ being successful.
Type Definition	
SEQUENCE {	
nodeB_Id	INTEGER (0..63)
}	

ASN.1 ASP Type Definition	
Type Name	CMAC_MACi_AG_REQ
PCO Type	CSAP
Comment	The hARQProcId shall be converted to the nearest CFN (and subframe number if TTI = 2 ms) by the SS, and the Absolute Grant is sent in that CFN (and subframe number if TTI = 2 ms).
Type Definition	
SEQUENCE {	
nodeB_Id	INTEGER (0..63),
grantType	ENUMERATED {primary(0), secondary(1)},
absoluteGrantValue	BIT STRING (SIZE(5)),
absoluteGrantScope	BIT STRING (SIZE(1)),
hARQProcId	INTEGER (0..7),
activationTime	SS_ActivationTime
}	

7.3.2.2.17o CMAC_MACi_AckNack (Rel-8 or later)

ASN.1 ASP Type Definition	
Type Name	CMAC_MACi_AckNack_CNF
PCO Type	CSAP
Comment	To Confirm CMAC_i_AckNack_REQ
Type Definition	
SEQUENCE {	
nodeB_Id	INTEGER (0..63)
}	

ASN.1 ASP Type Definition	
Type Name	CMAC_MACi_AckNack_REQ
PCO Type	CSAP
Comment	To request the SS to set operation mode of the Ack/Nack function for the HARQ process hARQProcId. The harQProcId, between 0 to 3 for 10 ms TTI or 0 to 7 for 2 msTTI, is individually applied to the configuration for the normal / nack mode. If the special hARQProcId -1 is used, all active HARQ processes (0..3 for 10 ms TTI and 0..7 for 2 ms TTI) will be configured according to ackNackFunction. At the SS initialization Ack/Nack function is in normal operation mode.
Type Definition	
SEQUENCE {	
nodeB_Id	INTEGER (0..63),
hARQProcId	INTEGER (-1 0..7),
ackNackFunction	AckNackFunction
}	

7.3.2.2.17p CMAC_MACi_E_TFC_Restriction (Rel-8 or later)

ASN.1 ASP Type Definition	
Type Name	CMAC_MACi_E_TFC_Restriction_CNF
PCO Type	CSAP
Comment	For MAC emulator to report that a previous attempt of restricting TFCs have been successful.
Type Definition	
SEQUENCE	{ nodeB_Id INTEGER (0..63) }

ASN.1 ASP Type Definition	
Type Name	CMAC_MACi_E_TFC_Restriction_REQ
PCO Type	CSAP
Comment	To request to configure MACi entity. The field restrictAllowedTFCs is provided to allow the E-TFCI to be restricted. The IE fullE_TFCS will be used to remove any previous E_TFCS restriction configured.
Type Definition	
SEQUENCE	{ nodeB_Id INTEGER (0..63), restrictAllowedTFCs CHOICE { e_TFCS_Restriction E_TFCS_Restriction, fullE_TFCS NULL } }

7.3.2.2.17q CMAC_MACi_RG (Rel-8 or later)

NOTE: These ASPs are currently not used in ATs

ASN.1 ASP Type Definition	
Type Name	CMAC_MACi_RG_CNF
PCO Type	CSAP
Comment	Confirm a previous CMAC_MACi_RG_REQ being successful.
Type Definition	
SEQUENCE	{ nodeB_Id INTEGER (0..63) }

ASN.1 ASP Type Definition	
Type Name	CMAC_MACi_RG_REQ
PCO Type	CSAP
Comment	For non-serving RL the value for relativeGrant is limited to "down" and "hold". The SS shall convert the hARQProcId to the nearest CFN (and subframe number if TTI = 2 ms) by the SS and send the Relative Grant in that CFN (and subframe number if TTI = 2 ms).
Type Definition	
SEQUENCE	{ nodeB_Id INTEGER (0..63), relativeGrant ENUMERATED {up(0), down(1), hold(2)}, hARQProcId INTEGER (0..7), activationTime SS_ActivationTime }

7.3.2.2.17r Void

7.3.2.2.17s CMAC_MACis_SI_IND

ASN.1 ASP Type Definition	
Type Name	CMAC_MACis_SI_IND
PCO Type	CSAP
Comment	This ASP is used for MACis delivering scheduling information in MAC_is testing, cellId=-1. nodeB_Id included if the si_ReportNodeB_Id is enabled in CMAC_MACis_SI_Config_REQ.
Type Definition	
SEQUENCE	{
cellId	INTEGER (-1..63),
nodeB_Id	INTEGER (0..63) OPTIONAL, -- Used in DC-HSUPA
cfn	INTEGER (0..255),
subframe	INTEGER (0..4 7),
	-- 0..4 when TTI=2ms, 7 when TTI=10ms
uePowerHeadRoom	BIT STRING (SIZE(5)),
totalE_DCHBufferStatus	BIT STRING (SIZE(5)),
highestPriorityLogChBS	BIT STRING (SIZE(4)),
highestPriorityLogChId	BIT STRING (SIZE(4))
	}

7.3.2.2.17t CMAC_MACis_SI_Config (Rel-8 or later)

ASN.1 ASP Type Definition	
Type Name	CMAC_MACis_SI_Config_CNF
PCO Type	CSAP
Comment	Applicable Rel-8 or later To Confirm CMAC_MACis_SI_Config_REQ, cellId=-1.
Type Definition	
SEQUENCE	{
cellId	INTEGER (-1..63)
	}

ASN.1 ASP Type Definition	
Type Name	CMAC_MACis_SI_Config_REQ
PCO Type	CSAP
Comment	Applicable Rel-8 or later To configure the SS to enable / disable to report the reception of Scheduling Information in MAC-is PDU's via primitive CMAC_MACis_SI_IND. At the SS initialization, the default mode is SI reporting disabled cellId=-1.
Type Definition	
SEQUENCE	{
cellId	INTEGER (-1..63),
si_reportEnable	ENUMERATED {disable(0), enable(1)} DEFAULT disable,
si_ReportNodeB_Id	ENUMERATED {disable(0), enable(1)} DEFAULT disable
	-- Used in DC-HSUPA
	}

7.3.2.2.17u CMAC_MBMS_ConfigInfo (Rel-6 or later)

ASN.1 ASP Type Definition	
Type Name	CMAC_MBMS_ConfigInfo_CNF
PCO Type	CSAP
Comment	To confirm CMAC_MBMS_ConfigInfo_REQ. The routingInfo indicates the physical channel which carries logical channel of type: MCCH, MSCH.
Type Definition	
SEQUENCE	{
cellId	INTEGER (0..63),
routingInfo	RoutingInfo
	}

ASN.1 ASP Type Definition	
Type Name	CMAC_MBMS_ConfigInfo_REQ
PCO Type	CSAP
Comment	To provide the SS MCCH or MSCH configuration information. The routingInfo indicates the physical channel which carries logical channel of type : MCCH or MSCH. This ASP shall be called after the ASP CMAC_Config_REQ used for MCCH or MSCH configuration.
Type Definition	
SEQUENCE	{ cellId INTEGER (0..63), routingInfo RoutingInfo, mCCH_ConfigInfo MBMS_MCCH_ConfigurationInfo_r6 OPTIONAL, mSCH_ConfigInfo MBMS_MSCH_ConfigurationInfo_r6 OPTIONAL }

7.3.2.2.18 CMAC_PAGING_Config

ASN.1 ASP Type Definition	
Type Name	CMAC_PAGING_Config_CNF
PCO Type	CSAP
Comment	To confirm to setup the paging message
Type Definition	
SEQUENCE	{ cellId INTEGER (0..63), routingInfo RoutingInfo }

ASN.1 ASP Type Definition	
Type Name	CMAC_PAGING_Config_REQ
PCO Type	CSAP
Comment	To request MAC layer to send the Paging message on the specified configuration.
Type Definition	
SEQUENCE	{ cellId INTEGER (0..63), routingInfo RoutingInfo, ratType RatType, configMessage CmacPagingConfigReq }

ASN.1 Type Definition	
Type Name	CmacPagingConfigReq
Comment	The IE t_pich_T_sccpch is obsolete for the purpose of the UE conformance test in all Releases. The timing relation of PICH / S-CCPCH and PICH/HS-SCCH are specified in 3GPP TS 25.211 [40], subclauses 7.1, 7.2 and 7.2A. A desired clean correction is to remove this IE. However, for the backwards /forwards compatibility, the proposed solution is to set this IE always to FALSE. The SS can ignore this IE, but shall behave according to the corresponding core spec.
Type Definition	
SEQUENCE	{ pI_BitMapInfo CHOICE { e18 BIT STRING (SIZE (18)), e36 BIT STRING (SIZE (36)), e72 BIT STRING (SIZE (72)), e144 BIT STRING (SIZE (144)) }, dRX_CycleLength INTEGER {3..9}, iMSI SEQUENCE (SIZE (6..15)) OF Digit, t_pich_T_sccpch BOOLEAN -- T_pich>T_sccpch then FALSE }

7.3.2.2.19 CMAC_Restriction

ASN.1 ASP Type Definition	
Type Name	CMAC_Restriction_CNF
PCO Type	CSAP
Comment	For MAC emulator to report that a previous attempt of restricting TFCs have been successful.
Type Definition	
SEQUENCE	{ cellId INTEGER (-1..63), routingInfo RoutingInfo }

ASN.1 ASP Type Definition	
Type Name	CMAC_Restriction_REQ
PCO Type	CSAP
Comment	To request to configure MAC entity. The field restrictAllowedTFCs is provided to allow the UL and/or DL SS TFCS to be restricted for a specific transport channel. This information only needs to be sent to the MAC layer, since it is the MAC layer's responsibility to determine the set of valid TFCs each TTI.
Type Definition	
SEQUENCE	{ cellId INTEGER (-1..63), routingInfo RoutingInfo, ratType RatType, restrictAllowedTFCs TFC_Restriction }

ASN.1 Type Definition	
Type Name	TFC_Restriction
Comment	This type is used to specify the allowed TFCs within the current TFCS. A TFC restriction is applicable until a subsequent TFC restriction is applied. TFC restrictions are not cumulative, so each TFC restriction completely replaces the previous TFC restriction. The downlink restriction can be used to ensure that the SS uses a specific TFC for transmission of data, by only allowing the 'No data' TFC, and the 'desired' TFC. It may also be necessary to include one or more 'signalling only' TFCs to allow signalling to occur. The uplink restriction can be used to verify that the UE has used a specific TFC. Any data received by the SS using a forbidden TFCI shall be discarded.
Type Definition	
SEQUENCE	{ ulTFCI_Restriction TFC_Subset OPTIONAL, dlTFCI_Restriction TFC_Subset OPTIONAL }
Detailed Comments	<p>SS requirements for downlink.</p> <ol style="list-style-type: none"> 1. The SS MAC layer shall not use a restrictednon-allowed TFC for DL. 2. The SS MAC layer shall not use a TFC that requires the SS RLC layer to provide padding PDUs (3GPP TS 25.322 [18]) 3. In the case that there is data pending on one or more RLC entities, but not enough to use one of the allowed TFCs: <ol style="list-style-type: none"> a. The SS MAC layer shall use the 'No data' TFC until there is enough data in the RLC to use another allowed TFC. b. The SS RLC layer shall buffer the data until there is enough data in the RLC entities for the MAC layer to use an allowed TFC other than the 'No data' TFC for transmission of the data. <p>NOTE: The TTCN author is responsible for ensuring:</p> <ol style="list-style-type: none"> 1. The SDU discard function is not configured for TM and UM entities in the UE, and is configured to no_discard for AM entities in the UE. 2. That RLC SDUs that are expected to be sent in the same TTI (due to a TFC restriction) are sent as quickly as possible to minimize the number of 'no data' TFCs used by the MAC layer, and the amount of buffering that must be performed by the RLC layer. <p>SS requirements for uplink: The SS shall discard all data received using a restricted non-allowed TFC.</p>

7.3.2.2.20 CMAC_SecurityMode_Config

ASN.1 ASP Type Definition	
Type Name	CMAC_SecurityMode_Config_CNF
PCO Type	CSAP
Comment	To confirm to configure the MAC security mode
Type Definition	
SEQUENCE	{
	cellId INTEGER (-1..63)
	}

ASN.1 ASP Type Definition	
Type Name	CMAC_SecurityMode_Config_REQ
PCO Type	CSAP
Comment	To request to configure the MAC security mode. If there are several CMAC_Ciphering_Activate_REQ follow this ASP, the SS shall take a serial of specified actions on the same contents in this ASP at the activation time indicated in each CMAC_Ciphering_Activate_REQ.
Type Definition	
SEQUENCE	{
	cellId INTEGER (-1..63),
	macCipheringInfo SecurityInfo
	}

7.3.2.2.21 CMAC_SequenceNumber

ASN.1 ASP Type Definition	
Type Name	CMAC_Sequence_Number_CNF
PCO Type	CSAP
Comment	To return the requested counter sequence number on MAC-d DCH. The physicalChannelIdentity of DPCH applies to routingInfo.
Type Definition	
SEQUENCE	{
	cellId INTEGER (-1..63),
	routingInfo RoutingInfo,
	count_C_MSB_UL COUNT_C_MSB ,
	count_C_MSB_DL COUNT_C_MSB
	}

ASN.1 ASP Type Definition	
Type Name	CMAC_SequenceNumber_REQ
PCO Type	CSAP
Comment	To request the MAC layer to return current counter sequence numbers. The physicalChannelIdentity of DPCH applies to routingInfo.
Type Definition	
SEQUENCE	{
	cellId INTEGER (-1..63),
	routingInfo RoutingInfo
	}

7.3.2.2.22 CMAC_SYSINFO_Config

ASN.1 ASP Type Definition	
Type Name	CMAC_SYSINFO_Config_CNF
PCO Type	CSAP
Comment	To confirm to setup the system information block
Type Definition	
SEQUENCE	{
	cellId INTEGER (0..63),
	routingInfo RoutingInfo
	}

ASN.1 ASP Type Definition	
Type Name	CMAC_SYSINFO_Config_REQ
PCO Type	CSAP
Comment	To request MAC layer to send the BCCH message on the specified configuration.
Type Definition	
SEQUENCE	{
cellId	INTEGER(0..63),
routingInfo	RoutingInfo,
ratType	RatType,
configMessage	CmacSysinfoConfigReq
}	

ASN.1 Type Definition	
Type Name	CmacSysinfoConfigReq
Comment	
Type Definition	
SEQUENCE	{
sg_REP	INTEGER (2..12), -- Repetition period is the sg_REP-th power of 2.
sg_POS	INTEGER (0..2047), -- The position of each segment is 2 * sg_POS.
bcch_ModificationTime	BCCH_ModificationTime OPTIONAL
}	

7.3.2.2.22a CRLC_Bind_TestData_TTI

ASN.1 ASP Type Definition	
Type Name	CRLC_Bind_TestData_TTI_CNF
PCO Type	CSAP
Comment	To confirm the request of binding subsequent data sending RLC_TR_TestDataReq on the different DL RBs in the same TTI.
Type Definition	
SEQUENCE	{
cellId	INTEGER(-1..63),
result	ENUMERATED{failure(0), success(1)}
}	

ASN.1 ASP Type Definition	
Type Name	CRLC_Bind_TestData_TTI_REQ
PCO Type	CSAP
Comment	To request binding subsequent data sending RLC_TR_TestDataReq on the different DL RBs in the same TTI. On the request, the transmission of the test data is temporarily suppressed on those radio bearers which follow subsequently this CRLC_Bind_TestData_TTI_REQ and have 'numOfDiffRb' different RB IDs. Having received the number 'numOfDiffRb' of RLC_TR_TestDataReq, the SS RLC sends the test data on those RBs in the same TTI according to the allowed DL TFCS.
Type Definition	
SEQUENCE	{
cellId	INTEGER(-1..63),
numOfDiffRb	INTEGER(2..6) -- Number of different RB IDs
}	

7.3.2.2.22b CRLC_BindTestDataInOneMAChs_MACehs_PDU (Rel-5 or later)

ASN.1 ASP Type Definition	
Type Name	CRLC_BindTestDataInOneMAChs_MACehs_PDU_CNF
PCO Type	CSAP
Comment	To confirm the request of binding subsequent data sending RLC_TR/UM/AM_TestDataReq on the specified RB mapped on HS-DSCH in the same MAC-hs/MAC-ehs PDU.
Type Definition	
<pre>SEQUENCE{ cellId INTEGER(-1..63), routingInfo RoutingInfo, -- RB ID desired to be given result ENUMERATED{failure(0), success(1)} }</pre>	

ASN.1 ASP Type Definition	
Type Name	CRLC_BindTestDataInOneMAChs_MACehs_PDU_REQ
PCO Type	CSAP
Comment	To request of binding subsequent data sending RLC_TR/UM/AM_TestDataReq on the specified RB mapped on HS-DSCH in the same MAC-hs/MAC-ehs PDU. On the request, the transmission of the test data is temporarily suppressed on the radio bearers till 'numOfSDU's are received by RLC layer on the Radio Bearer. After receiving all SDU's the RLC layer submits to MAC such that all of them are sent in one MAC-hs/ MAC-ehs PDU.
Type Definition	
<pre>SEQUENCE{ cellId INTEGER(-1..63), routingInfo RoutingInfo, -- RB ID desired to be given numOfSDUs INTEGER -- Number of RLC SDU's }</pre>	

7.3.2.2.22c CRLC_BindTestDataInMultipleMACehs_PDU_MultiFlows (Rel-7 or later)

ASN.1 ASP Type Definition	
Type Name	CRLC_BindTestDataInMultipleMACehs_PDU_MultiFlows_CNF
PCO Type	CSAP
Comment	To confirm the request of binding subsequent data sending RLC_TR/UM/AM_TestDataReq on the specified RB mapped on HS-DSCH.
Type Definition	
<pre>SEQUENCE{ cellId INTEGER(-1..63), routingInfo RoutingInfo, -- RB ID desired to be given result ENUMERATED{failure(0), success(1)} }</pre>	

ASN.1 ASP Type Definition	
Type Name	CRLC_BindTestDataInMultipleMACehs_PDU_MultiFlows_REQ
PCO Type	CSAP
Comment	To request of binding subsequent data sending RLC_TR/UM/AM_TestDataReq on the specified RB mapped on HS-DSCH in two MAC-ehs PDUs, one for each primary and secondary flow. On the request, the transmission of the test data is temporarily suppressed on the radio bearer till all SDUs for all flows are received by RLC layer on the Radio Bearer. After receiving all SDU's the RLC layer submits to MAC such that all of them are sent in two MAC-ehs PDUs.
Type Definition	
<pre>SEQUENCE{ cellId INTEGER(-1..63), routingInfo RoutingInfo, -- RB ID desired to be given primaryFlowNumOfSDUs INTEGER, -- Number of RLC SDU's for primary flow of serving cell secondaryFlowNumOfSDUs INTEGER OPTIONAL, -- Number of RLC SDU's for secondary flow of serving cell secPrimaryFlowNumOfSDUs INTEGER OPTIONAL, -- Number of RLC SDU's for secondary cell primary flow Rel-9 or later secSecondaryFlowNumOfSDUs INTEGER OPTIONAL -- Number of RLC SDU's for secondary cell secondary flow Rel-9 or later }</pre>	

7.3.2.2.23 CRLC_Ciphering_Activate

ASN.1 ASP Type Definition	
Type Name	CRLC_Ciphering_Activate_CNF
PCO Type	CSAP
Comment	To confirm to activate or inactivate the ciphering
Type Definition	
<pre>SEQUENCE { cellId INTEGER(-1..63) }</pre>	

ASN.1 ASP Type Definition	
Type Name	CRLC_Ciphering_Activate_REQ
PCO Type	CSAP
Comment	To request to start orrestart downlink ciphering or uplink deciphering. Each call of the ASP includes one RLC SN in rb-DL-CiphActivationTimeInfo for the corresponding rb-identity. Initialize the 20 MSB of HFN component of COUNT-C to the START value stored. For RLC_UM COUNT-C: - If the value of incHFN is set to "NotInc" the SS initializes the remaining LSBs of HFN component in UM COUNT-C to zero. - If the value of incHFN is set to "Inc" the SS initializes the remaining LSBs of HFN component in UM COUNT-C to zero, then increments the HFN by one. For RLC_AM COUNT-C: - If the value of incHFN is set to "NotInc" no further action is needed. - If the value of incHFN is set to "Inc" the SS increments the HFN by one.
Type Definition	
<pre>SEQUENCE { cellId INTEGER(-1..63), ratType RatType, cn_DomainIdentity CN_DomainIdentity, ciphActivationInfo CiphActivationInfo, incHFN RLC_IncMode }</pre>	

ASN.1 Type Definition	
Type Name	CiphActivationInfo
Comment	DL or UL ciphering activation info If RB is omitted in rB_UL_CiphActivationTimeInfo the SS takes no action on this RB and the ciphering configuration keeps unchanged on this RB. CipheringModeCommand = dummy NULL means no ciphering.
Type Definition	
CHOICE { cipheringModeInfo CipheringModeInfo, rb_UL_CipheringActivationTimeInfo RB_ActivationTimeInfoList, cipheringModeInfo_r7 CipheringModeInfo_r7 -- Rel-7 or later }	

ASN.1 Type Definition	
Type Name	RLC_IncMode
Comment	
Type Definition	
ENUMERATED{notInc(0), inc(1)}	

7.3.2.2.24 CRLC_Config

ASN.1 ASP Type Definition	
Type Name	CRLC_Config_CNF
PCO Type	CSAP
Comment	For RLC emulator to confirm that a previous attempt to establish, re_configure or release a radio bearer has been successful.
Type Definition	
SEQUENCE { cellId INTEGER(-1..63), routingInfo RoutingInfo }	

ASN.1 ASP Type Definition	
Type Name	CRLC_Config_REQ
PCO Type	CSAP
Comment	To request to setup, reconfigure or release RLC entity
Type Definition	
SEQUENCE { cellId INTEGER(-1..63), routingInfo RoutingInfo, ratType RatType, configMessage CrlcConfigReq, activationTime SS_ActivationTime OPTIONAL -- Rel-7 or later }	

ASN.1 Type Definition	
Type Name	CrlcConfigReq
Comment	To request to setup, re_configure release RLC entity The Stop parameter indicates that the RLC entity shall not transmit or receive RLC PDUs. The Continue parameter indicates that the RLC entity shall continue transmission and reception of RLC PDUs. When the RLC entity is stopped, the all protocol parameters, such as the protocol variables, RLC timers and status are not affected. Triggered polls and status transmissions are delayed until the RLC entity is continued.
Type Definition	
CHOICE { setup RBInfo, reconfigure RBInfo, release NULL, sS_stop NULL, sS_continue NULL }	

ASN.1 Type Definition	
Type Name	RBInfo
Comment	
Type Definition	
<pre>SEQUENCE { sS_rlc_Info SS_RLC_Info OPTIONAL, sS_rlc_Info_r8 SS_RLC_Info_r8OrLater OPTIONAL, -- Rel-8 or Later rB_LogCH_Mapping RB_LogCH_Mapping }</pre>	

ASN.1 Type Definition	
Type Name	RB_LogCH_Mapping
Comment	Provide mapping information between RB, logical channel and CN domain. When the logical channel is MTCH, the logicalChannelIdentity shall be consistent with MBMS_LogicalChIdentity in MBMS_PTM_RBInformation_N and MBMS_PTM_RBInformation_C being sent to the UE.
Type Definition	
<pre>SEQUENCE { uLogicalChannelIdentity LogicalChannelIdentity OPTIONAL, dLogicalChannelIdentity LogicalChannelIdentity OPTIONAL, logicalChannelType LogicalChannelType OPTIONAL, cn_DomainIdentity CN_DomainIdentity OPTIONAL }</pre>	

ASN.1 Type Definition	
Type Name	SS_RLC_Info
Comment	<p>UL and DL have been swapped intentionally in this type definition. This is to maximize re-use of the type definitions in 3GPP TS 25.331 [21] which are intended to configure a UE, where UL is transmission, and DL is reception. For the SS, UL is reception, and DL is transmission.</p> <p>For example, consider configuring a DL AM RLC entity (transmitter) in the SS. The transmission parameters to be configured include PollingInformation, Transmission-RLC-Discard etc. If the DL-AM-RLC-Mode type definition is used to configure this entity, it is only possible to configure reception parameters such as StatusInformation, and receiving window size.</p> <p>By swapping UL and DL, it is possible to configure the DL AM RLC entity using the existing type definition UL-AM-RLC-Info, which contains all of the required transmission parameters.</p> <p>When uM_SN_DeliveryMode is set to configured, the RLC entity does not concatenate nor segment RLC SDUs (see 3GPP TS 25.322 [18], subclause 8.2). If the IE useSpecialValueOfHEField is set to true, the last octet of the PDU is the last octet of an SDU and there is no SDU concatenation inside the PDU.</p> <p>Applicable for Rel-99 to Rel-7</p>
Type Definition	
<pre>SEQUENCE { sS_ul_RLC_Mode DL_RLC_Mode OPTIONAL, sS_dl_RLC_Mode SS_DL_RLC_Mode OPTIONAL, rlc_OneSidedReEst BOOLEAN DEFAULT FALSE, altE_bitInterpretation ENUMERATED {false (0), true (1)} DEFAULT false, -- applicable only for UM RLC mode of Rel-7 or later useSpecialValueOfHEField ENUMERATED {false (0), true (1)} DEFAULT false, -- applicable only for AM RLC mode of Rel-7 or later uM_SN_DeliveryMode ENUMERATED { nonConfigured(0), configured(1)} DEFAULT nonConfigured -- applicable for UM RLC mode of Rel-7 or later }</pre>	

Type Name	SS_RLC_Info_r8OrLater
Comment	<p>Applicable for Rel-8 or Later.</p> <p>UL and DL have been swapped intentionally in this type definition. This is to maximize re-use of the type definitions in 3GPP TS 25.331 [21], which are intended to configure a UE, where UL is transmission, and DL is reception. For the SS, UL is reception, and DL is transmission.</p> <p>For example, consider configuring a DL AM RLC entity (transmitter) in the SS. The transmission parameters to be configured include PollingInformation, Transmission-RLC-Discard etc. If the DL-AM-RLC-Mode type definition is used to configure this entity, it is only possible to configure reception parameters such as StatusInformation, and receiving window size.</p> <p>By swapping UL and DL, it is possible to configure the DL AM RLC entity using the existing type definition UL-AM-RLC-Info, which contains all of the required transmission parameters.</p> <p>When uM_SN_DeliveryMode is set to configured, the RLC entity does not concatenate nor segment RLC SDUs (see 3GPP TS 25.322 [18], subclause 8.2). If the IE useSpecialValueOfHEField is set to true, the last octet of the PDU is the last octet of an SDU and there is no SDU concatenation inside the PDU.</p>
Type Definition	
<pre>CHOICE { r8 SEQUENCE { sS_ul_RLC_Mode DL_RLC_Mode_r7 OPTIONAL, sS_dl_RLC_Mode SS_DL_RLC_Mode OPTIONAL, rlc_OneSidedReEst BOOLEAN DEFAULT FALSE, altE_bitInterpretation ENUMERATED {false (0), true (1)} DEFAULT false, -- applicable only for UM RLC mode useSpecialValueOfHEField ENUMERATED {false (0), true (1)} DEFAULT false, -- applicable only for AM RLC mode uM_SN_DeliveryMode ENUMERATED { nonConfigured(0), configured(1)} DEFAULT nonConfigured -- applicable for UM RLC mode of Rel-7 or later }, spare1 NULL }</pre>	

ASN.1 Type Definition	
Type Name	SS_DL_RLC_Mode
Comment	<p>"dl_UM_outOfSeqDelivery" is present only for the DL_RLC entity connected to MCCH, and in the configuration with dl_UM_outOfSeqDelivery present the UM RLC can transmit RLC PDU containing SDU of ACCESS INFORMATION message out of sequence when it is necessary</p> <p>Maximum one among dl_RLC_PDU_size & dl_PayloadSize shall be included.</p> <p>For RLC UM configuration, with altE_bitInterpretation set to TRUE, neither dl_PayloadSize nor dl_RLC_PDU_size can be present.</p>
Type Definition	
<pre>SEQUENCE { dl_PayloadSize PayloadSize OPTIONAL, dl_RLCModeInfo UL_RLC_Mode, dl_UM_RLC_LI_size DL_UM_RLC_LI_size OPTIONAL, -- only for UM RLC configuration of Rel-5 or later dl_UM_outOfSeqDelivery UM_RLC_OutOSeqDelivery_Info_r6 OPTIONAL, -- Rel-6 or later dl_RLC_PDU_size CHOICE { fixedSize OctetModeRLC_SizeInfoType1, flexibleSize SS_FlexibleSize } OPTIONAL -- Only for AM RLC Configuration of Rel-7 or later }</pre>	

ASN.1 Type Definition	
Type Name	PayloadSize
Comment	
Type Definition	
INTEGER (0..4992)	

ASN.1 Type Definition	
Type Name	SS_FlexibleSize
Comment	Rel-7 or later If max_RLC_DataField_Size is present, SS shall guarantee that the size of data field of DL RLC PDU does not exceed the size specified in Bytes.
Type Definition	
<pre>SEQUENCE { li_Size ENUMERATED { size7 (0), size15 (1)}, -- Size of length indicator max_RLC_DataField_Size INTEGER (1..1503) OPTIONAL - Maximum size of data field of RLC PDU (25.322, 9.2.2.9 and 25.433, 9.2.1.38c) }</pre>	

7.3.2.2.25 CRLC_Integrity_Activate

ASN.1 ASP Type Definition	
Type Name	CRLC_integrity_Activate_CNF
PCO Type	CSAP
Comment	To confirm to activate or inactivate the integrity protection
Type Definition	
<pre>SEQUENCE { cellId INTEGER (-1..63) }</pre>	

ASN.1 ASP Type Definition	
Type Name	CRLC_Integrity_Activate_REQ
PCO Type	CSAP
Comment	To request to start or to modify the downlink or uplink integrity protection. The ASP shall be called before send SECURITY MODE COMMAND. It activates the integrity on all SRBs in DL. The SS initializes the 20 MSB of HFN component of COUNT-I to the START value stored and set the remaining LSBs of HFN component in COUNT-I to zero. If integrityModeCommand in ASP is set to "startIntegrityProtection", the SS shall start the downlink integrity protection from the first downlink RRC message. If the integrityModeCommand in ASP is set to "modify", the SS shall start the downlink integrity protection at the RRC message sequence number specified in "dl_IntegrityProtActivationInfo".
Type Definition	
<pre>SEQUENCE { cellId INTEGER (-1..63), cn_DomainIdentity CN_DomainIdentity, integrityActivationInfo IntegrityActivationInfo }</pre>	

ASN.1 Type Definition	
Type Name	IntegrityActivationInfo
Comment	DL or UL integrity activation info At the RRC message sequence numbers specified in the ul_IntegProtActivationInfo the SS shall initialize COUNT-I for the SRB's indicated in the ul_IntegrityProtActivationInfo and start using the new configuration on uplink for the indicated SRB's. If the START value is omitted in the CRLC_SecurityMode_Config_REQ above COUNT-I initialization shall not be performed.
Type Definition	
<pre>CHOICE { integrityProtectionModeInfo IntegrityProtectionModeInfo, ul-IntegProtActivationInfo IntegrityProtActivationInfoList, integrityProtectionModeInfo_r7 IntegrityProtectionModeInfo_r7 -- Rel-7 or later }</pre>	

ASN.1 Type Definition	
Type Name	IntegrityProtActivationInfoList
Comment	List of SS IntegrityProtActivationInfo
Type Definition	
<pre>SEQUENCE (SIZE (1..maxRB)) OF SS_IntegrityProtActivationTimeInfo</pre>	

ASN.1 Type Definition	
Type Name	SS_IntegrityProtActivationTimeInfo
Comment	Omitting rrc_MessageSequenceNumber means activation time set to "now".
Type Definition	
<pre>SEQUENCE { rb_Identity INTEGER (-31..32), rrc_MessageSequenceNumber RRC_MessageSequenceNumber OPTIONAL }</pre>	

7.3.2.2.26 CRLC_Integrity_Failure

ASN.1 ASP Type Definition	
Type Name	CRLC_Integrity_Failure_IND
PCO Type	CSAP
Comment	RLC emulator reports the occurrences of a failure in integrity protection, i.e. reception of an integrity-protected RLC AM/UM SDU containing a non-matching X-MAC value compared to the desired.
Type Definition	
<pre>SEQUENCE { cellId INTEGER (-1..63), routingInfo RoutingInfo, failureCause ENUMERATED { codeNotMatched(0) } -- the enumerated types of failure cause field is ffs }</pre>	

7.3.2.2.26a CRLC_MAC_I_Mode

ASN.1 ASP Type Definition	
Type Name	CRLC_MAC_I_Mode_CNF
PCO Type	CSAP
Comment	Confirm a previous CRLC_MAC_I_Mode_REQ being successful.
Type Definition	
<pre>SEQUENCE { cellId INTEGER (-1..63), srbId INTEGER (0..4) }</pre>	

ASN.1 ASP Type Definition	
Type Name	CRLC_MAC_I_Mode_REQ
PCO Type	CSAP
Comment	To set the MAC-I calculation mode. The ASP does not affect the UL integrity calculation. If mode = normal, the SS generates the correct MAC-I. If mode = erroneous, the SS generates any wrong MAC-I value different from the one it shall be. As default, when the integrity protection is jswitched on the SS enters the normal MAC-I calculation mode.
Type Definition	
<pre>SEQUENCE { cellId INTEGER (-1..63), srbId INTEGER (0..4), mode ENUMERATED {normal(0), erroneous(1)} }</pre>	

7.3.2.2.26b CRLC_NotAckNxtRxSDU

ASN.1 ASP Type Definition	
Type Name	CRLC_NotAckNxtRxSDU_CNF
PCO Type	CSAP
Comment	To confirm that the next received SDU has not been acknowledged.
Type Definition	
SEQUENCE	{
	cellId INTEGER(-1..63),
	routingInfo RoutingInfo
	}

ASN.1 ASP Type Definition	
Type Name	CRLC_NotAckNxtRxSDU_REQ
PCO Type	CSAP
Comment	To request that the next received SDU is not acknowledged. The received SDU is passed to the upper layers.
Type Definition	
SEQUENCE	{
	cellId INTEGER(-1..63),
	routingInfo RoutingInfo,
	mode ENUMERATED{start(0)}
	}

7.3.2.2.26c CRLC_ProhibitRLC_Ack

The use of the pair of ASPs should be restricted to each start of SRB3 Uplink ciphering only. The SS behaviours are not specified if the ASPs are used in any other procedures.

ASN.1 ASP Type Definition	
Type Name	CRLC_ProhibitRLC_Ack_CNF
PCO Type	CSAP
Comment	To confirm that the reception of a CRLC_ProhibitRLC_Ack_REQ.
Type Definition	
SEQUENCE	{
	cellId INTEGER(-1..63),
	routingInfo RoutingInfo,
	supportFlag SupportFlag DEFAULT noNeed
	}

ASN.1 ASP Type Definition	
Type Name	CRLC_ProhibitRLC_Ack_REQ
PCO Type	CSAP
Comment	To request the SS to prohibit/Continue acknowledging RLC SDUs.
Type Definition	
SEQUENCE	{
	cellId INTEGER(-1..63),
	routingInfo RoutingInfo,
	mode ENUMERATED{prohibit(0), continue(1)}
	}

ASN.1 Type Definition	
Type Name	SupportFlag
Comment	The default value noNeed indicates that the SS does not perform the operation mentioned in CRLC_ProhibitRLC_Ack_REQ, but performs the suspension / resume of UL RLC PDU data. If the non default values are taken, the SS has either prohibited, or continued acknowledging RLC SDUs.
Type Definition	
ENUMERATED	{ackProhibited(0), ackContinued(1), noNeed (2)}

7.3.2.2.27 CRLC_Resume

ASN.1 ASP Type Definition	
Type Name	CRLC_Resume_CNF
PCO Type	CSAP
Comment	To confirm the resume request
Type Definition	
SEQUENCE	{
cellId	INTEGER(-1..63),
routingInfo	RoutingInfo
	}

ASN.1 ASP Type Definition	
Type Name	CRLC_Resume_REQ
PCO Type	CSAP
Comment	To request to resume data transmission. If the SS implemented the optional suspension of UL data PDUs, then the processing in the UL of data PDUs shall be resumed. Any suspended UL control PDUs and Piggybacked Status shall be preceded or resumed.
Type Definition	
SEQUENCE	{
cellId	INTEGER(-1..63),
routingInfo	RoutingInfo
	}

7.3.2.2.27a CRLC_RRC_MessageSN

ASN.1 ASP Type Definition	
Type Name	CRLC_RRC_MessageSN_CNF
PCO Type	CSAP
Comment	To return the counter I values (HFN and RRC message sequence number) for sending the next DL RRC message or for receiving the next UL RRC message on the concerned SRB. COUNT_I_MSB is the 28 MSB of the COUNT-I (HFN)
Type Definition	
SEQUENCE	{
cellId	INTEGER(-1..63),
routingInfo	RoutingInfo,
count_I_MSB_UL	COUNT_I_MSB,
count_I_LSB_UL	RRC_SequenceNumber,
count_I_MSB_DL	COUNT_I_MSB,
count_I_LSB_DL	RRC_SequenceNumber
	}

ASN.1 Type Definition	
Type Name	COUNT_I_MSB
Comment	28 bits long
Type Definition	
INTEGER (0..268435455)	

ASN.1 Type Definition	
Type Name	RRC_SequenceNumber
Comment	4 bits long
Type Definition	
INTEGER (0..15)	

7.3.2.2.28a CRLC_SetRRC_MessageSN

ASN.1 ASP Type Definition	
Type Name	CRLC_SetRRC_MessageSN_CNF
PCO Type	CSAP
Comment	To confirm the RRC message sequence number setting request
Type Definition	
SEQUENCE	{
cellId	INTEGER(-1..63),
routingInfo	RoutingInfo
}	

ASN.1 ASP Type Definition	
Type Name	CRLC_SetRRC_MessageSN_REQ
PCO Type	CSAP
Comment	To request the SS to set the RRC message sequence number in COUNT-I to the value specified in this ASP. The ASP is used to initialize SS RRC SN.
Type Definition	
SEQUENCE	{
cellId	INTEGER(-1..63),
routingInfo	RoutingInfo,
count_I_LSB_UL	RRC_SequenceNumber OPTIONAL,
count_I_LSB_DL	RRC_SequenceNumber OPTIONAL
}	

7.3.2.2.28b CRLC_Set_Count_I

ASN.1 ASP Type Definition	
Type Name	CRLC_Set_Count_I_CNF
PCO Type	CSAP
Comment	To confirm the count_I_MSB and the RRC message sequence number setting request
Type Definition	
SEQUENCE	{
cellId	INTEGER(-1..63),
routingInfo	RoutingInfo
}	

ASN.1 ASP Type Definition	
Type Name	CRLC_Set_Count_I_REQ
PCO Type	CSAP
Comment	To request the SS to set the 28 MSB and 4 LSB (RRC message sequence number) in COUNT-I according to the parameter values specified in this ASP. Parameters omitted in this ASP shall leave the corresponding bits in the SS COUNT-I unchanged. Typically the parameters count_I_MSB_UL and count_I_MSB_DL are omitted. They are only applied in a few specific security test cases requiring restoration of the used integrity context. NOTE: The 28 MSBs are initialized with the UE-provided START value plus 8 bits set to 0, using a different ASP (CRLC_SecurityMode_Config_REQ).
Type Definition	
SEQUENCE	{
cellId	INTEGER(-1..63),
routingInfo	RoutingInfo,
count_I_LSB_UL	RRC_SequenceNumber OPTIONAL,
count_I_LSB_DL	RRC_SequenceNumber OPTIONAL,
count_I_MSB_UL	COUNT_I_MSB OPTIONAL,
count_I_MSB_DL	COUNT_I_MSB OPTIONAL
}	

7.3.2.2.29 CRLC_SequenceNumber

ASN.1 ASP Type Definition	
Type Name	CRLC_Sequence_Number_CNF
PCO Type	CSAP
Comment	To return the requested counter sequence number to which the next DL PDU to be sent or the expected UL PDU to be received. The length of count_C_MSB_UL/DL and count_C_LSB_UL/DL are according to the long and short sequence number in 3GPP TS 33.102 [25], subclause 6.6.4.1.
Type Definition	
SEQUENCE	<pre> { cellId INTEGER(-1..63), routingInfo RoutingInfo, count_C_MSB_UL COUNT_C_MSB, count_C_LSB_UL RLC_SequenceNumber, count_C_MSB_DL COUNT_C_MSB, count_C_LSB_DL RLC_SequenceNumber } </pre>

ASN.1 ASP Type Definition	
Type Name	CRLC_SequenceNumber_REQ
PCO Type	CSAP
Comment	To request the RLC layer to return current counter sequence numbers to which the next DL PDU to be sent or the expected UL PDU to be received.
Type Definition	
SEQUENCE	<pre> { cellId INTEGER(-1..63), routingInfo RoutingInfo } </pre>

7.3.2.2.29a CRLC_SendContinuousData_TTI

ASN.1 ASP Type Definition	
Type Name	CRLC_SendContinuousData_CNF
PCO Type	CSAP
Comment	Confirm sending data in every TTI on each requested RB
Type Definition	
SEQUENCE	<pre> { cellId INTEGER(-1..63), result ENUMERATED{failure(0), success(1)} } </pre>

ASN.1 ASP Type Definition	
Type Name	CRLC_SendContinuousData_REQ
PCO Type	CSAP
Comment	To request sending data in every TTI on each RB identified. After the CMAC_Restriction_REQ, the TFC under test will be the one corresponding to the maximum CTFC value in the Restricted list, so that SS can select the number of Transport blocks and the size of Transport blocks on individual Transport channels derived from this CTFC. SS shall take care about all kind of discard info in all RLC modes and the final goal is that the DL TFCs under test shall be selected in downlink for sending data on the request RBs in each TTI.
Type Definition	
SEQUENCE	<pre> { cellId INTEGER(-1..63), rabTxInfo RabTxInfo } </pre>

ASN.1 Type Definition	
Type Name	RbTxInfo
Comment	Provide test data, number of RBs, and RB Tx info of each RB (RB id, SDU size and number of SDUs) to be transmitted in consecutive TTIs
Type Definition	
SEQUENCE {	
testData	BIT STRING (SIZE (8..163840)),
rbTxInfoList	SEQUENCE (SIZE (1..6)) OF RbTxInfo
}	

ASN.1 Type Definition	
Type Name	RbTxInfo
Comment	Info on RB id and the actual DL test data size (SDU_Size * number of SDUs). The actual test data is extracted from the first (SDU_Size * number of SDUs) bits in the raw testData buffer. SS shall transmit the actual test data in every TTI. The value nomOfSdu = T / TTI , whereby T=1200 is the duration of the data transmitting in the RAB test, taking into account the test tolerance (+50 %) of the UE loop back delay (< 800 ms).
Type Definition	
SEQUENCE {	
rB_Identity	INTEGER (-31..32),
sduSize	INTEGER (1..163840),
nomOfSdu	INTEGER (0..255) -- 0 is set for no data on this RB
}	

7.3.2.2.30 CRLC_Status

ASN.1 ASP Type Definition	
Type Name	CRLC_Status_IND
PCO Type	CSAP
Comment	To report the occurrence of certain events to RRC. NOTE: The possible event types to be defined for this ASP is FFS.
Type Definition	
SEQUENCE {	
cellId	INTEGER(-1..63),
routingInfo	RoutingInfo,
ratType	RatType,
statusInd	CrlcStatusInd
}	

ASN.1 Type Definition	
Type Name	CrlcStatusInd
Comment	
Type Definition	
ENUMERATED {	
dataLinkFailure (0)	
maxRESET (1),	
sDUDiscarded (2)	
-- More event types are to be added here	
}	

7.3.2.2.31 CRLC_Suspend

ASN.1 ASP Type Definition	
Type Name	CRLC_Suspend_CNF
PCO Type	CSAP
Comment	To confirm the suspension of data transmission. The parameter vt indicates either the value of the Send State Variable VT(S) for AM, or the value of Data State Variable VT(US) for UM.
Type Definition	
SEQUENCE {	
cellId	INTEGER(-1..63),
routingInfo	RoutingInfo,
vt	RLC_SequenceNumber
}	

ASN.1 ASP Type Definition	
Type Name	CRLC_Suspend_REQ
PCO Type	CSAP
Comment	To request the suspension of data transmission. The parameter n indicates that an RLC entity will not send a PDU with "Sequence Number"≥VT(S)+N for AM and "Sequence Number"≥VT(US)+N for UM, where N is a non-negative integer. Optionally an SS may start immediate suspension of processing of data PDUs in the UL. The UL control PDUs and Piggybacked Status may optionally be processed.
Type Definition	
SEQUENCE	{ cellId INTEGER(-1..63), routingInfo RoutingInfo, n RLC_SequenceNumber }

7.3.2.2.31a CRLC_MTCH_Scheduling (Rel-6 or later)

ASN.1 ASP Type Definition	
Type Name	CRLC_MTCH_Scheduling_CNF
PCO Type	CSAP
Comment	To confirm the CRLC_MTCH_Scheduling_REQ
Type Definition	
SEQUENCE	{ cellId INTEGER(-1..63), routingInfo RoutingInfo }

ASN.1 ASP Type Definition	
Type Name	CRLC_MTCH_Scheduling_REQ
PCO Type	CSAP
Comment	Applied to the RLC entity carrying MTCH. MBMS serviceSchedulingInfo can contain a list of MBMS ServiceSchedulingInfo for multiple consecutive scheduling periods of discontinuous MBMS services. mSCH_REPconfiguration provides the timing of scheduling periods. serviceShedulingInfos provides a list of SS_ServiceSchedulingInfo corresponding to multiple scheduling periods. On or after the start and within the duration of a MBMS session, the RLC behaves as normal entity. Outside of these ranges the RLC regards the buffer occupancy as being zero, prohibiting the MAC from requesting PDU's. The same is valid for the service silence period (noServiceData). Each call of the ASP replaces the existing whole scheduling information list or creates a new scheduling information list if the list does not exist. The absence of IE mSCH_REPconfiguration and schedulingInfoInfos indicates continuous MBMS services. The SS shall delete the existing scheduling information list if it has existed. The RLC entity behaves as normal.
Type Definition	
SEQUENCE	{ cellId INTEGER(-1..63), routingInfo RoutingInfo, mSCH_REPconfiguration MSCH_REPconfiguration OPTIONAL, serviceShedulingInfos ServiceSchedulingInfoList OPTIONAL }

ASN.1 Type Definition	
Type Name	ServiceSchedulingInfoList
Comment	Multiple ServiceSchedulingInfo can be submitted to the SS. Each ServiceSchedulingInfo corresponds to a MSCH scheduling period.
Type Definition	
SEQUENCE	(SIZE(1.. MaxNumMSCHMsgs))OF SS_ServiceSchedulingInfo

ASN.1 Type Definition	
Type Name	SS_ServiceSchedulingInfo
Comment	The IE is applied to the discontinuous MBMS service and contains pairs of "start" and "duration" within a scheduling period. The start value indicates the start of the service transmission in number of 4-frames relative to: either the 1 st TTI on which the MBMS SCHEDULING INFORMATION message of the corresponding scheduling period is sent if MSCH is configured; or the IE scheduledSFN value in MSCH_REPconfiguration if MSCH is not configured. The duration value indicates how long the service is transmitted in unit of 4-frames. noServiceData is applied to the scheduling period when no MBMS service data are sent on that MTCH.
Type Definition	
CHOICE { mbms_ServiceTransmInfoList MBMS_ServiceTransmInfoList, noServiceData NULL }	

7.3.2.2.32 CBMC_Config

ASN.1 ASP Type Definition	
Type Name	CBMC_Config_CNF
PCO Type	CSAP
Comment	To confirm the BMC configuration, reconfiguration or release.
Type Definition	
SEQUENCE { cellId INTEGER(0..63), routingInfo RoutingInfo -- RBid }	

ASN.1 ASP Type Definition	
Type Name	CBMC_Config_REQ
PCO Type	CSAP
Comment	To request the configuration, reconfiguration or release of BMC.
Type Definition	
SEQUENCE { cellId INTEGER(0..63), routingInfo RoutingInfo, -- RBid configMessage CHOICE { setup BMC_SchedulingInfo, release NULL } }	

7.3.2.2.32b DEC_PERbitstring

ASN.1 ASP Type Definition	
Type Name	DEC_PERbitstring_CNF
PCO Type	ExternalAsn1Codec
Comment	To receive the decoded BIT STRING.
Type Definition	
SEQUENCE { containedType ContainedType }	

ASN.1 ASP Type Definition	
Type Name	DEC_PERbitstring_REQ
PCO Type	ExternalAsn1Codec
Comment	To request decoding of the BITSTRING received from UE in receivedBITSTRING with the type specified in containingType.
Type Definition	
<pre>SEQUENCE { receivedBITSTRING BIT STRING, containingType ContainingPERbitstringType }</pre>	

ASN.1 PDU Type Definition	
Type Name	ContainedType
Comment	
Type Definition	
<pre>CHOICE { ue_CapabilityContainer_IEs UE_CapabilityContainer_IEs, rrcConnectionSetupComplete_r3_add_ext_IEs RRCCConnectionSetupComplete_r3_add_ext_IEs, ueCapabilityInformation_r3_add_ext_IEs UECapabilityInformation_r3_add_ext_IEs, interRATHandoverInfo_r3_add_ext InterRATHandoverInfo_r3_add_ext_IEs, interRATHandoverInfo InterRATHandoverInfo, ue_RadioAccessCapabilityInfo UE_RadioAccessCapabilityInfo }</pre>	

ASN.1 Type Definition	
Type Name	ContainingPERbitstringType
Comment	
Type Definition	
<pre>ENUMERATED { ue_CapabilityContainer_IEs (0), rrcConnectionSetupComplete_r3_add_ext_IEs (1), ueCapabilityInformation_r3_add_ext_IEs (2), interRATHandoverInfo_r3_add_ext_IEs (3), interRATHandoverInfo (4), ue_RadioAccessCapabilityInfo (5) }</pre>	

ASN.1 ASP Type Definition	
Type Name	DEC_PERbitstringEUTRA_CNF
PCO Type	ExternalAsn1Codec
Comment	Rel-9 or later To receive the decoded BIT STRING.
Type Definition	
<pre>SEQUENCE { containedType ContainedEUTRA_Type }</pre>	

ASN.1 ASP Type Definition	
Type Name	DEC_PERbitstringEUTRA_REQ
PCO Type	ExternalAsn1Codec
Comment	Rel-9 or later To request decoding of the BITSTRING received from UE in receivedBITSTRING with an E-UTRA type specified in containingType.
Type Definition	
<pre>SEQUENCE { receivedBITSTRING BIT STRING, containingType ContainingPER_BitstringEUTRA_Type }</pre>	

ASN.1 PDU Type Definition	
Type Name	ContainedEUTRA_Type
Comment	
Type Definition	
CHOICE { ue_EUTRA_Capability UE_EUTRA_Capability -- defined in 36.331 }	

ASN.1 Type Definition	
Type Name	ContainingPER_BitstringEUTRA_Type
Comment	
Type Definition	
ENUMERATED { uE_EUTRA_Capability (0) }	

7.3.2.2.32c ENC_PERbitstring

ASN.1 ASP Type Definition	
Type Name	ENC_PERbitstring_CNF
PCO Type	ExternalAsn1Codec
Comment	To receive the encoded BIT STRING.
Type Definition	
SEQUENCE { encodedBITSTRING BIT STRING }	

ASN.1 ASP Type Definition	
Type Name	ENC_PERbitstring_REQ
PCO Type	ExternalAsn1Codec
Comment	To request encoding of asn.1 PDU or IE.
Type Definition	
CHOICE { mcchMessage MCCH_Message, radioBearerSetup_r7_add_ext RadioBearerSetup_r7_add_ext_IEs }	

7.3.2.2.33 RLC_TR_DATA

ASN.1 ASP Type Definition	
Type Name	RLC_TR_DATA_REQ
PCO Type	DSAP
Comment	To request to transmit DATA using transparent mode.
Type Definition	
SEQUENCE { cellId INTEGER(-1..63), routingInfo RoutingInfo, tM_Message CHOICE { dL_DCCH_Message DL_DCCH_Message, dL_CCCH_Message DL_CCCH_Message, pCCH_Message PCCH_Message, dL_SHCCH_Message DL_SHCCH_Message, bCCH_FACH_Message BCCH_FACH_Message, bCCH_BCH_Message BCCH_BCH_Message } }	

ASN.1 ASP Type Definition	
Type Name	RLC_TR_DATA_IND
PCO Type	DSAP
Comment	To indicate to receive DATA using transparent mode.
Type Definition	
SEQUENCE	{
cellId	INTEGER (-1..63),
routingInfo	RoutingInfo,
tm_Message	CHOICE {
uL_DCCH_Message	UL_DCCH_Message,
uL_CCCH_Message	UL_CCCH_Message,
uL_SHCCH_Message	UL_SHCCH_Message}
	}

7.3.2.2.34 RLC_AM_DATA

ASN.1 ASP Type Definition	
Type Name	RLC_AM_DATA_REQ
PCO Type	DSAP
Comment	To request to transmit DATA using acknowledged mode.
Type Definition	
SEQUENCE	{
cellId	INTEGER (-1..63),
routingInfo	RoutingInfo,
confirmationRequest	AmConfirmationRequest,
aM_Message	CHOICE {
dL_DCCH_Message	DL_DCCH_Message,
dL_CCCH_Message	DL_CCCH_Message,
pCCH_Message	PCCH_Message,
dL_SHCCH_Message	DL_SHCCH_Message,
bCCH_FACH_Message	BCCH_FACH_Message,
bCCH_BCH_Message	BCCH_BCH_Message,
invalid_dL_DCCH_Message	Invalid_DL_DCCH_Message}
	}

ASN.1 Type Definition	
Type Name	AmConfirmationRequest
Comment	If the noConfirmationRequested option is used, then an RLC_AM_DATA_CNF is not expected from the RLC AM entity. If the confirmationRequested option is used, then the RLC AM entity is being requested to provide an RLC_AM_DATA_CNF primitive containing the same Mui value.
Type Definition	
CHOICE	{
noConfirmationRequest	NULL,
confirmationRequested	Mui
	}

ASN.1 Type Definition	
Type Name	Mui
Comment	
Type Definition	
INTEGER	{0..4095}

ASN.1 ASP Type Definition	
Type Name	RLC_AM_DATA_IND
PCO Type	DSAP
Comment	To indicate to receive DATA using acknowledged mode.
Type Definition	
SEQUENCE	{
cellId	INTEGER(-1..63),
routingInfo	RoutingInfo,
integrityResult	IntegrityResult,
aM_Message	CHOICE {
uL_DCCH_Message	UL_DCCH_Message,
uL_CCCH_Message	UL_CCCH_Message,
uL_SHCCH_Message	UL_SHCCH_Message}
	}

ASN.1 Type Definition	
Type Name	IntegrityResult
Comment	
Type Definition	
CHOICE	{
integrityNotUsed	NULL,
integrityUsed	IntegrityStatus
	}

ASN.1 Type Definition	
Type Name	IntegrityStatus
Comment	
Type Definition	
ENUMERATED	{
i_pass(0), i_fail(1)	
	}

ASN.1 ASP Type Definition	
Type Name	RLC_AM_DATA_CNF
PCO Type	DSAP
Comment	For RLC emulator to report to the upper layer that a previously transmitted SDU has been acknowledged correctly by the UE
Type Definition	
SEQUENCE	{
cellId	INTEGER(-1..63),
routingInfo	RoutingInfo,
mui	Mui
	}

7.3.2.2.34a RLC_UM_ACCESSInfo (Rel-6 or later)

ASN.1 ASP Type Definition	
Type Name	RLC_UM_ACCESSInfo_REQ
PCO Type	DSAP
Comment	To request to transmit ACCESS INFORMATION messages using unacknowledged mode. This ASP is valid for the RLC entity configured for the logical channel MCCH. When an RLC_UM_ACCESSInfo_REQ with uM_Messages present is received the ongoing transmission of ACCESS INFORMATION, if any, shall be stopped in the modification period indicated by startingTime. At the same time, the SS starts transmitting the ACCESS INFORMATION messages passed by the ASP, then repeats the transmission in each next modification period. When an RLC_UM_ACCESSInfo_REQ without uM_Messages is received the SS stops the ongoing ACCESS INFORMATION transmission at the modification period specified by startingTime.
Type Definition	
<pre>SEQUENCE { cellId INTEGER(-1..63), routingInfo RoutingInfo, startingTime INTEGER(0..4095), -- pointing to the first frame of a modification uM_Messages AI_MsgList OPTIONAL }</pre>	

ASN.1 Type Definition	
Type Name	AI_MsgList
Comment	AI_MsgList is an ordered list of AI messages. The order corresponds to the AI_Msg transmission timing in a modification period. A modification period can have 1, 2, 4 or 8 access information periods depending on MCCH configuration. The size of the list shall be consistent with the MCCH configuration.
Type Definition	
SEQUENCE (SIZE(1 2 4 8)) OF AI_Msg	

ASN.1 Type Definition	
Type Name	AI_Msg
Comment	The ai_Message is sent on the first TTI of the access information period. If the corresponding ai_Message is empty there is no ACCESS INFORMATION scheduled for that access information period.
Type Definition	
<pre>CHOICE { ai_Message MBMSAccessInformation, ai_EmptyMsg NULL }</pre>	

7.3.2.2.34b RLC_UM_CriticalMCCHMsg (Rel-6 or later)

ASN.1 ASP Type Definition	
Type Name	RLC_UM_CriticalMCCHMsg_REQ
PCO Type	DSAP
Comment	To request to transmit critical MCCH messageList using unacknowledged mode. This ASP is valid only for the RLC entity configured for the logical channel MCCH. When an RLC_UM_CriticalMCCHMsg_REQ with non-empty uM_Messages is received the SS stops ongoing critical MCCH information transmission in the modification period indicated by startingTime. At the same time, the SS starts transmitting the set of critical MCCH messageList passed by the ASP in the same order as they appear in the uM_MessageList, and then repeats the transmission in each next repetition period until another RLC_UM_CriticalMCCHMsg_REQ is received to modify the critical messages at start of the next modification period. When an RLC_UM_CriticalMCCHMsg_REQ without uM_Messages is received the SS stops the ongoing critical MCCH message transmission at the modification period specified by startingTime. If specialLI is set to TRUE all SUDs sent within the RLC_UM_CriticalMCCHMsg_REQ have the special LI set to indicate beginning of the RLC SDU.
Type Definition	
SEQUENCE	{ cellId INTEGER (-1..63), routingInfo RoutingInfo, startingTime INTEGER (0..4095), -- pointing to the first frame of a modification uM_Messages MCCH_MessageList OPTIONAL, specialLI BOOLEAN DEFAULT FALSE }

ASN.1 Type Definition	
Type Name	MCCH_MessageList
Comment	MBMSAccessInformation shall not be included in the MCCH_MessageList.
Type Definition	
SEQUENCE	(SIZE (1..maxNumMCCHMsgs)) OF MCCH_MessageType

ASN.1 Type Definition	
Type Name	maxNumMCCHMsgs
Comment	For covering the configuration with 20 neighbouring cells
Type Definition	
INTEGER	(25)

7.3.2.2.34c RLC_TR_SeqOfRlcPdus

ASN.1 ASP Type Definition	
Type Name	RLC_TR_SeqOfRlcPdus_REQ
PCO Type	DSAP
Comment	To request to transmit a sequence of RLC PDUs using transparent mode: The first PDU is sent in the frame at startingTime, the other PDUs are subsequently sent in the following frames. This primitive can be used e.g. to send fully coded RLC PDUs of critical messages at the beginning of a repetition period. Each sequence of RLC PDUs is sent just once i.e. not repeated at the beginning of the next repetition period. Therefore the sequence may also contain Access Information. Furthermore the sequence may contain corrupted PDUs.
Type Definition	
SEQUENCE	{ cellId INTEGER (-1..63), routingInfo RoutingInfo, startingTime INTEGER (0..4095), -- pointing to the first frame of a modification seqOfPdus MCCH_RlcPduList }

ASN.1 Type Definition	
Type Name	MCCH_RlcPduList
Comment	Each RLC PDU is completely encoded and consists of RLC UM header and RLC SDU
Type Definition	
SEQUENCE (SIZE(1..maxNumMCCHRlcPdus)) OF BIT STRING	

ASN.1 Type Definition	
Type Name	maxNumMCCHRlcPdus
Comment	Maximum number of RLC PDUs in RLC tests of MCCH
Type Definition	
INTEGER (64)	

7.3.2.2.35 RLC_UM_DATA

ASN.1 ASP Type Definition	
Type Name	RLC_UM_DATA_REQ
PCO Type	DSAP
Comment	To request to transmit DATA using unacknowledged mode.
Type Definition	
<pre>SEQUENCE { cellId INTEGER(-1..63), routingInfo RoutingInfo, uM_Message CHOICE { dL_DCCH_Message DL_DCCH_Message, dL_CCCH_Message DL_CCCH_Message, pCCH_Message PCCH_Message, dL_SHCCH_Message DL_SHCCH_Message, bCCH_FACH_Message BCCH_FACH_Message, bCCH_BCH_Message BCCH_BCH_Message, invalid_dL_DCCH_Message Invalid_DL_DCCH_Message}, specialLI BOOLEAN }</pre>	

ASN.1 ASP Type Definition	
Type Name	RLC_UM_DATA_IND
PCO Type	DSAP
Comment	To indicate to receive DATA using unacknowledged mode.
Type Definition	
<pre>SEQUENCE { cellId INTEGER(-1..63), routingInfo RoutingInfo, integrityResult IntegrityResult, uM_Message CHOICE { uL_DCCH_Message UL_DCCH_Message, uL_CCCH_Message UL_CCCH_Message, uL_SHCCH_Message UL_SHCCH_Message} }</pre>	

7.3.2.2.35a RLC_UM_MSCH_Msg (Rel-6 or later)

ASN.1 ASP Type Definition	
Type Name	RLC_UM_MSCH_Msg_REQ
PCO Type	DSAP
Comment	To request to transmit MSCH_MessageList using unacknowledged mode. The ASP is applied to the RLC entity configured for the logical channel MSCH.
Type Definition	
<pre>SEQUENCE { cellId INTEGER(-1..63), routingInfo RoutingInfo, mSCH_REPconfiguration MSCH_REPconfiguration, uM_Messages MSCH_MessageList }</pre>	

ASN.1 Type Definition	
Type Name	MSCH_REPconfiguration
Comment	<p>MSCH_REPconfiguration describes how the scheduled data to be transmitted.</p> <p>If MSCH is configured MSCH_REPconfiguration specifies when series of MSCH scheduling repetitions start and how long the scheduling period is. The scheduledSFN fulfils: $\text{scheduledSFN} = ((\text{SFNss} / \text{MSCH_REP} + 1) * \text{MSCH_REP} + \text{MSCH_OFF} + (\text{SCTO} / 10\text{ms})) \bmod 4096,$ where SFNss is the value of currentSFN provided by SS via CPHY_SFN_CNF. The SS shall start sending the 1st SCHEDULING INFORMATION message on the frame indicated by scheduledSFN and successively send the remaining MSCH messages in the list on the 1st TTI of every mSCH_REP.</p> <p>If MSCH is not configured the scheduledSFN fulfils: $\text{scheduledSFN} = (\text{SFNss} + (\text{SCTO} / 10\text{ms})) \bmod 4096,$ mSCH_REP is omitted.</p>
Type Definition	
<pre>SEQUENCE { scheduledSFN INTEGER(0..4095), mSCH_REP ENUMERATED { sp32(0), sp64(1), sp128(2), sp256(3), sp512(4), sp1024(5) } OPTIONAL }</pre>	

ASN.1 Type Definition	
Type Name	MSCH_MessageList
Comment	Multiple MSCH messages can be submitted to the SS. Every scheduling period a new message in the sequence is transmitted according to the appearing order in the sequence.
Type Definition	
SEQUENCE (SIZE(1.. maxNumMSCHMsgs)) OF SS MSCH Message	

ASN.1 Type Definition	
Type Name	SS_MSCH_Message
Comment	noSend of SS_MSCH_Message is applied to the scheduling period when no MBMS service data are sent on all MTCH.
Type Definition	
<pre>CHOICE { mSCH_Message MSCH_MessageType, noSend NULL} </pre>	

ASN.1 Type Definition	
Type Name	maxNumMSCHMsgs
Comment	Covering a sufficiently long duration of multiple MSCH scheduling periods for test
Type Definition	
INTEGER (64)	

7.3.2.2.36 RLC_TR_MACesDATA_IND (Rel-6 or later)

ASN.1 ASP Type Definition	
Type Name	RLC_TR_MACesDATA_IND
PCO Type	DSAP
Comment	<p>This ASP is used for MACes delivering data in MAC_es testing.</p> <p>The IE cellId = -1, The routingInfo is RB identity, corresponding to RLC in TM, (tsc_RB_DTCH_E_DCH_MAC0(-20), tsc_RB_DTCH_E_DCH_MAC1(-21), or tsc_RB_DTCH_E_DCH_MAC2(-22)).</p> <p>The cfn and subframe indicate the CFN and sub-frame number on which the mACesSDUs (RLC PDUs) were received.</p> <p>The ddi, tsn and n are the reported values in the header of each MAC-es PDU that carries the mACesSDUs.</p> <p>If SI is received together with other MACes PDUs in a MAC-e PDU but without a special DDI associated, the SS shall split SI from MACes data and the latter ones are delivered with the ASP.</p>
Type Definition	
SEQUENCE	<pre> { cellId INTEGER (-1..63), routingInfo RoutingInfo, cfn INTEGER (0..255), subframe INTEGER (0..4 7), -- Value 7 applied when TTI=10ms happyBit ENUMERATED {happy(0), unhappy(1)}, ddi INTEGER (0..62), tsn INTEGER (0..63), n INTEGER (0..63), mACesSDUs MACesSDU_List } </pre>

ASN.1 Type Definition	
Type Name	MACesSDU_List
Comment	
Type Definition	
SEQUENCE (SIZE (1..63)) OF	MACesSDU

ASN.1 Type Definition	
Type Name	MACesSDU
Comment	
Type Definition	
BIT STRING	-- RLC PDU in TM

7.3.2.2.36a RLC_TR_MACisDATA_IND (Rel-8 or later)

ASN.1 ASP Type Definition	
Type Name	RLC_TR_MACisDATA_IND
PCO Type	DSAP
Comment	<p>This ASP is used for MACis delivering data in MAC_is testing.</p> <p>The IE cellId = -1, the routingInfo is RB identity, corresponding to RLC in TM.</p> <p>The cfn and subframe indicate the CFN and sub-frame number on which the mACisSDUs (RLC PDUs) were received.</p> <p>The LCH_Id, length, F are the reported values in the header of each MAC-is SDU. The SS, tsn are the reported values in the header of each MAC-is PDU that carries the mACisSDUs.</p>
Type Definition	
SEQUENCE	<pre> { cellId INTEGER (-1..63), routingInfo RoutingInfo, cfn INTEGER (0..255), subframe INTEGER (0..4 7), -- Value 7 applied when TTI=10ms happyBit ENUMERATED {happy(0), unhappy(1)}, mACi_Header MACi_HeaderList_Type, ss INTEGER (0..3), tsn INTEGER (0..63), mACisSDUs MACisSDU_List } </pre>

ASN.1 Type Definition	
Type Name	MACi_HeaderList_Type
Comment	
Type Definition	
SEQUENCE (SIZE (1..63)) OF MACi_Header_Type	

ASN.1 Type Definition	
Type Name	MACi_Header_Type
Comment	
Type Definition	
<pre>SEQUENCE { LCH_ID INTEGER (0..15), length INTEGER (0..2047) OPTIONAL, f INTEGER (0..1) OPTIONAL, cRC_Present BOOLEAN DEFAULT FALSE, eRNTI BIT STRING (SIZE (16)) OPTIONAL }</pre>	

ASN.1 Type Definition	
Type Name	MACisSDU_List
Comment	
Type Definition	
SEQUENCE (SIZE (1..63)) OF MACisSDU	

ASN.1 Type Definition	
Type Name	MACisSDU
Comment	
Type Definition	
BIT STRING -- RLC PDU in TM	

7.3.2.2.36b RLC_TR_MACisDATA_ExtTSN_IND (Rel-9 or later)

ASN.1 ASP Type Definition	
Type Name	RLC_TR_MACisDATA_ExtTSN_IND
PCO Type	DSAP
Comment	<p>Rel-9 or later</p> <p>This ASP is used for MACis delivering data in MAC_is testing when extended TSN is configured.</p> <p>The IE cellId = -1, the routingInfo is RB identity, corresponding to RLC in TM. The cfn and subframe indicate the CFN and sub-frame number on which the mACisSDUs (RLC PDUs) were received.</p> <p>The LCH_Id, length, F are the reported values in the header of each MAC-is SDU. The SS, tsN are the reported values in the header of each MAC-is PDU that carries the mACisSDUs.</p>
Type Definition	
<pre>SEQUENCE { cellId INTEGER (-1..63), nodeB_Id INTEGER (0..63), routingInfo RoutingInfo, cfn INTEGER (0..255), subframe INTEGER (0..4 7), -- Value 7 applied when TTI=10ms happyBit ENUMERATED {happy(0), unhappy(1)}, mACi_Header MACi_HeaderList_Type, ss INTEGER (0..3), tsN INTEGER (0..16383), mACisSDUs MACisSDU_List }</pre>	

7.3.2.3 Specific ASP and IE definitions for 1.28 Mcps TDD (Rel-4 or later)

The ASP definitions in 7.3.2.2 are applied to 1.28 Mcps TDD with the exceptions.

- The ASP definition CPHY_AICH_AckModeSet is not applied.

- Specific IE definitions in this clause replace the definitions in clause 7.3.2.2.

7.3.2.3.1 Specific ASP definitions

ASN.1 ASP Type Definition	
Type Name	CPHY_Cell_Config_REQ
PCO Type	CSAP
Comment	Applicable Rel-4 or later To request to setup the cell parameter. The unit of tcell is chip; the unit of sfnOffset is frame number; the primary scrambling code number of the cell is 16*primaryScramblingCode_SS; the unit of dLTxAttenuationLevel is dB.
Type Definition	
<pre>SEQUENCE { cellId INTEGER (0..63), sfnOffset INTEGER (0 .. 4095), frequencyInfo FrequencyInfo, cellTxPowerLevel CellTxPowerLevel, dLTxAttenuationLevel INTEGER(0..30 123), cellParametersID CellParametersID, timeSlotConfigurationList_LCR TimeSlotConfigurationList_LCR, dwPCHInfo DwpCHInfo, transmissionDiversityApplied ENUMERATED {notApplied (0),applied (1)}OPTIONAL, secondaryFrequencyInfo SecondaryFrequencyInfoList OPTIONAL, upPCHposition UpPCHposition_LCR OPTIONAL }</pre>	

ASN.1 ASP Type Definition	
Type Name	CPHY_HS_SICH_AckNack_CNF
PCO Type	CSAP
Comment	Applicable Rel-5 or later To Confirm CPHY HS_SICH_AckNack_REQ
Type Definition	
<pre>SEQUENCE{ cellId INTEGER (0..63) }</pre>	

ASN.1 ASP Type Definition	
Type Name	CPHY_HS_SICH_AckNack_REQ
PCO Type	CSAP
Comment	Applicable Rel-5 or later To request for Start or Stop of reporting Ack/Nack received on the SICH for the HARQ process hARQProcessId. At the SS initialization reporting of Ack/Nack is in "STOP" state
Type Definition	
<pre>SEQUENCE{ cellId INTEGER(0..63), ratType RatType, ackNackReportReq AckNackReportReq, hARQProcessId INTEGER(0..7) }</pre>	

ASN.1 ASP Type Definition	
Type Name	CPHY_HS_SICH_AckNack_IND
PCO Type	CSAP
Comment	Applicable Rel-5 or later SS reports the HARQ-ACK information received on HS_DPCCH, each received Ack/Nack generates a CPHY_HS_DPCCH_AckNack_IND
Type Definition	
<pre>SEQUENCE { cellId INTEGER(0..63), ratType RatType, hARQ_ACKInfo ENUMERATED {ack(0), nack(1)}, hARQProcessId INTEGER(0..7) }</pre>	

ASN.1 ASP Type Definition	
Type Name	CPHY_HS_SICH_CQI_CNF
PCO Type	CSAP
Comment	Applicable Rel-5 or later. To Confirm CPHY_HS_SICH_CQI_REQ
Type Definition	
<pre>SEQUENCE{ cellId INTEGER(0..63) }</pre>	

ASN.1 ASP Type Definition	
Type Name	CPHY_HS_SICH_CQI_REQ
PCO Type	CSAP
Comment	Applicable Rel-5 or later. To enable the SS to start reporting N times of the CQI value received on the HS-SICH. At the SS initialization reporting of CQI values is disabled
Type Definition	
<pre>SEQUENCE{ cellId INTEGER(0..63), ratType RatType, cQIReport ENUMERATED {startRep (0),stopRep (1) } }</pre>	

ASN.1 ASP Type Definition	
Type Name	CPHY_HS_SICH_CQI_IND
PCO Type	CSAP
Comment	Applicable Rel-5 or later. SS generates the indication when the CQI information is received on HS_SICH after invocation of ASP CPHY_HS_SICH_CQI_REQ. This ASP is used for verifying whether the UE has configured the HS-DSCH and starts reception of HS-DSCH. (3GPP TS 25.331 [21], subclause 8.6.6.34)
Type Definition	
<pre>SEQUENCE { cellId INTEGER(0..63), ratType RatType, rMS ENUMERATED {qpsk (0),qam16 (1) }, rTB INTEGER(0..63) }</pre>	

ASN.1 ASP Type Definition	
Type Name	CMAC_MACChs_TFRCconfigure_CNF
PCO Type	CSAP
Comment	Applicable Rel-5 or later. Confirm a previous CMAC_MACChs_TFRCconfigure_REQ being successful.
Type Definition	
<pre>SEQUENCE { cellId INTEGER(-1..63) }</pre>	

Type Name	CMAC_MAChs_TFRCconfigure_REQ
PCO Type	CSAP
Comment	<p>Applicable Rel-5 or later</p> <p>To configure the TFRC selection in the MAC-hs entity</p> <p>If explicitlyConfigured is selected in <code>tfrConfigMode</code>, the SS shall use all the parameter values specified to configure a correct transport format and radio resources.</p> <p>If <code>sS_Configured</code> is selected, the parameter value range is specified. SS shall dynamically select the suitable values for the parameters "modulationScheme", "dLTimeslotandCode", "noOfChannelisationCodes ", "tbSizeIndexOnHS_SCCH", "redundancyVersion" and "hs_PDSCH_TxPower" according to UE's capability category and CQI information reported by the UE.</p> <p>MaxnoofDLtsLCR=6</p>
Type Definition	
<pre> SEQUENCE { cellId INTEGER(-1..63), tfrConfigMode CHOICE { explicitlyConfigured SEQUENCE { modulationScheme ModulationScheme, noOfTimeSlots B5, startCode HS_ChannelisationCode_LCR, stopCode HS_ChannelisationCode_LCR, noOfCodesPerTimeslot INTEGER(0..16), tbSizeIndexOnHS_SCCH INTEGER(0..63), redundancyVersions RedundancyVersionList, hs_PDSCH_TxPower DL_TxPower -- default offset related -- to p-PCCPCH }, sS_Configured SEQUENCE { numofTimeslots INTEGER(0..6), startCode HS_ChannelisationCode_LCR, stopCode HS_ChannelisationCode_LCR, numofCodesPerTimeslot INTEGER(0..16), iniHS_PDSCH_TxPower DL_TxPower -- default offset related -- to p-PCCPCH } } } </pre>	

ASN.1 ASP Type Definition	
Type Name	CMAC_MAChs_MACehs_TFRCconfigure_REQ
PCO Type	CSAP
Comment	<p>Applicable Rel-8 or later</p> <p>To configure the TFRC selection in the MAC-hs entity, If explicitlyConfigured is selected in tfrcConfigMode, the SS shall use all the parameter values specified to configure a correct transport format and radio resources. This configuration is used for HS-SCCH associated HS-DSCH transmission.</p> <p>If sS_Configured is selected, the parameter value range is specified. SS shall dynamically select the suitable values for the parameters "modulationScheme", "channelisationCodeOffset", "noOfChannelisatonCodes ", ".tbSizeIndexOnHS_SCCH", "redundancyVersion" and "hs_PDSCH_TxPower" according to UE's capability category and CQI information reported by the UE. As sps_Information_TDD128 and MIMO cannot be simultaneously configured, only one among sps_Information_TDD128 and mimoStatus can be present. When both are absent non MIMO, non sps_Information_TDD128 is configured.</p> <p>If minimumInterTTIinterval is set to 1, Data is sent every TTI. If it is set to 2, every TTI with Data shall be followed by at least 1 TTI without Data. If it is set to 3, every TTI with Data shall be followed by at least 2 TTI without Data. This field needs to be set as per UE category as defined in Table 5.1a of 25.306.</p>
Type Definition	
<pre> SEQUENCE { cellId INTEGER(-1..63), tfrcConfigMode CHOICE { explicitlyConfigured SEQUENCE { modulationScheme ModulationScheme, noOfTimeSlots B5, startCode HS_ChannelisationCode_LCR, stopCode HS_ChannelisationCode_LCR, noOfCodesPerTimeslot INTEGER (0..16), tbSizeIndexOnHS_SCCH INTEGER (0..63), redundancyVersions RedundancyVersionList, hs_PDSCH_TxPower DL_TxPower --default offset related to p-PCCPCH }, sS_Configured SEQUENCE { numofTimeSlots INTEGER (0..6), startCode HS_ChannelisationCode_LCR, stopCode HS_ChannelisationCode_LCR, numofCodesPerTimeslot INTEGER (0..16), iniHS_PDSCH_TxPower DL_TxPower --default offset related to p-PCCPCH mimoStatus BOOLEAN DEFAULT FALSE, sps_Information_TDD128 SPS_Information_TDD128_r8 OPTIONAL } }, activationTime SS_ActivationTime OPTIONAL, } </pre>	

ASN.1 ASP Type Definition	
Type Name	CMAC_MAChs_HARQprocAssign_REQ
PCO Type	CSAP
Comment	<p>Applicable Rel-5 or later.</p> <p>To assign a HARQ process for handling next one MAC-hs PDU transmission.</p> <p>In normal operation a suitable HARQ process is, without TTCN intervening, selected by HARQ entity in the MAC-hs to service the MAC-hs PDU and the HARQ process identifier is set accordingly. This ASP provides TTCN the ability of selecting an HARQ process servicing the next one MAC-hs PDU which follows the ASP. After successful transmission the MAC-hs returns back to normal operation.</p>
Type Definition	
<pre> SEQUENCE { cellId INTEGER(-1..63), harqProcessId INTEGER(0..7) } </pre>	

ASN.1 ASP Type Definition	
Type Name	CMAC_MAChs_HARQprocAssign_CNF
PCO Type	CSAP
Comment	Applicable Rel-5 or later. Confirm a previous CMAC_MAChs_HARQprocAssign_REQ being successful.
Type Definition	
SEQUENCE { cellId INTEGER (-1..63) }	

ASN.1 ASP Type Definition	
Type Name	CMAC_MAChs_Reset_REQ
PCO Type	CSAP
Comment	Applicable Rel-5 or later. To reset the MAC-hs entity.
Type Definition	
SEQUENCE { cellId INTEGER (-1..63) }	

ASN.1 ASP Type Definition	
Type Name	CMAC_MAChs_Reset_CNF
PCO Type	CSAP
Comment	Applicable Rel-5 or later. Confirm a previous CMAC_MAChs_Reset_REQ being successful.
Type Definition	
SEQUENCE { cellId INTEGER (-1..63) }	

Type Name	CMAC_MACe_AG_REQ
PCO Type	CSAP
Comment	Applicable Rel-7 or later.
Type Definition	
SEQUENCE { nodeB_Id INTEGER (0..63), absoluteGrantValue BIT STRING (SIZE(5)), ChannelisationCode UL_TS_ChannelisationCode, TRRI BIT STRING (SIZE(5)), RDI INTEGER (0..7), ECSN INTEGER (0..7), EI INTEGER (0..3), ENI INTEGER (0..7), hARQProcId INTEGER (0..7), activationTime SS_ActivationTime }	

ASN.1 ASP Type Definition	
Type Name	CMAC_MACe_SI_Config_CNF
PCO Type	CSAP
Comment	Applicable Rel-7 or later To confirm CMAC_MACe_SI_Config_REQ, cellId=-1.
Type Definition	
SEQUENCE { cellId INTEGER (-1..63) }	

ASN.1 ASP Type Definition	
Type Name	CMAC_MACe_SI_Config_REQ
PCO Type	CSAP
Comment	Applicable Rel-7 or later To configure the SS to enable / disable to report the reception of Scheduling Information in MAC-es PDU's via primitive CMAC_MACe_SI_IND. At the SS initialization, the default mode is SI reporting disabled. cellId=-1.
Type Definition	
<pre>SEQUENCE { cellId INTEGER(-1..63), sI_reportEnable ENUMERATED {disable(0), enable(1)} DEFAULT disable }</pre>	

ASN.1 ASP Type Definition	
Type Name	CMAC_MACe_SI_IND
PCO Type	CSAP
Comment	This ASP is used for MAC-e delivering scheduling information in MAC-e testing. cellId=-1. If the SI was sent alone in a MAC-e PDU or sent together with other MAC-e PDU in a MAC-e PDU but without a special DDI associated the value of specialDDIpresence is set to absent; If the SI was sent together with other MAC-es PDU in a MAC-e PDU with a special DDI (DDI 63) associated the specialDDIpresence is set to present.
Type Definition	
<pre>SEQUENCE { cellId INTEGER(-1..63), cfn INTEGER(0..255), subframe INTEGER(0..1), specialDDIpresence ENUMERATED {absent(0), present(1)}, sNPL BIT STRING(SIZE(5)), uePowerHeadRoom BIT STRING(SIZE(5)), totalE_DCHBufferStatus BIT STRING(SIZE(5)), highestPriorityLogChBS BIT STRING(SIZE(4)), highestPriorityLogChId BIT STRING(SIZE(4)) }</pre>	

ASN.1 ASP Type Definition	
Type Name	RLC_TR_MACesDATA_IND
PCO Type	DSAP
Comment	This ASP is used for MACes delivering data in MAC_es testing. The IE cellId = -1, The routingInfo is RB identity, corresponding to RLC in TM, (tsc_RB_DTCH_E_DCH_MAC0(-20), tsc_RB_DTCH_E_DCH_MAC1(-21), or tsc_RB_DTCH_E_DCH_MAC2(-22)). The cfn and subframe indicate the CFN and sub-frame number on which the mACesSDUs (RLC PDUs) were received. The ddi, tsn and n are the reported values in the header of each MAC-es PDU that carries the mACesSDUs. If SI is received together with other MACes PDUs in a MAC-e PDU but without a special DDI associated, the SS shall split SI from MACes data and the latter ones are delivered with the ASP.
Type Definition	
<pre>SEQUENCE { cellId INTEGER(-1..63), routingInfo RoutingInfo, cfn INTEGER(0..255), subframe INTEGER(0..1), ddi INTEGER(0..62), tsn INTEGER(0..63), n INTEGER(0..63), mACesSDUs MACesSDU_List }</pre>	

Type Name	CMAC_MACi_AG_REQ
PCO Type	CSAP
Comment	Applicable Rel-8 or later.
Type Definition	
<pre>SEQUENCE { nodeB_Id INTEGER (0..63), absoluteGrantValue BIT STRING (SIZE(5)), ChannelisationCode UL_TS_ChannelisationCode, TRRI BIT STRING (SIZE(5)), RDI INTEGER (0..7), ECSN INTEGER (0..7), EI INTEGER (0..3), ENI INTEGER (0..7), hARQProcId INTEGER (0..7), activationTime SS_ActivationTime }</pre>	

ASN.1 ASP Type Definition	
Type Name	CMAC_MACi_SI_Config_CNF
PCO Type	CSAP
Comment	Applicable Rel-8 or later. To confirm CMAC_MACi_SI_Config_REQ, cellId=-1.
Type Definition	
<pre>SEQUENCE { cellId INTEGER (-1..63) }</pre>	

ASN.1 ASP Type Definition	
Type Name	CMAC_MACi_SI_Config_REQ
PCO Type	CSAP
Comment	Applicable Rel-8 or later To configure the SS to enable / disable to report the reception of Scheduling Information in MAC-is PDU's via primitive CMAC_MACi_SI_IND. At the SS initialization, the default mode is SI reporting disabled. cellId=-1.
Type Definition	
<pre>SEQUENCE { cellId INTEGER (-1..63), sI_reportEnable ENUMERATED {disable(0), enable(1)} DEFAULT disable }</pre>	

ASN.1 ASP Type Definition	
Type Name	CMAC_MACi_SI_IND
PCO Type	CSAP
Comment	Applicable Rel-8 or later This ASP is used for MAC-e delivering scheduling information in MAC-i testing. cellId=-1. If the SI was sent alone in a MAC-e PDU or sent together with other MAC-i PDU in a MAC-i PDU but without a special DDI associated the value of specialDDIpresence is set to absent; If the SI was sent together with other MAC-is PDU in a MAC-i PDU with a special DDI (DDI 63) associated the specialDDIpresence is set to present.
Type Definition	
<pre>SEQUENCE { cellId INTEGER (-1..63), cfn INTEGER (0..255), subframe INTEGER (0..1), sNPL BIT STRING (SIZE(5)), uePowerHeadRoom BIT STRING (SIZE(5)), totalE_DCHBufferStatus BIT STRING (SIZE(5)), highestPriorityLogChBS BIT STRING (SIZE(4)), highestPriorityLogChId BIT STRING (SIZE(4)) }</pre>	

ASN.1 ASP Type Definition	
Type Name	RLC_TR_MACisDATA_IND
PCO Type	DSAP
Comment	<p>Applicable Rel-8 or later</p> <p>This ASP is used for MACis delivering data in MAC_is testing.</p> <p>The IE cellId = -1, The routingInfo is RB identity, corresponding to RLC in TM, (tsc_RB_DTCH_E_DCH_MAC0(-20), tsc_RB_DTCH_E_DCH_MAC1(-21), or tsc_RB_DTCH_E_DCH_MAC2(-22)).</p> <p>The cfn and subframe indicate the CFN and sub-frame number on which the mACisSDUs (RLC PDUs) were received.</p> <p>The ddi, tsn and n are the reported values in the header of each MAC-is PDU that carries the mACisSDUs.</p> <p>If SI is received together with other MACis PDUs in a MAC-i PDU but without a special DDI associated, the SS shall split SI from MACes data and the latter ones are delivered with the ASP.</p>
Type Definition	
<pre>SEQUENCE { cellId INTEGER(-1..63), routingInfo RoutingInfo, cfn INTEGER(0..255), subframe INTEGER(0..1), mACi_Header MACi_HeaderList_Type, ss INTEGER(0..3), tsn INTEGER(0..63), mACisSDUs MACisSDU_List }</pre>	

ASN.1 ASP Type Definition	
Type Name	CPHY_RL_Setup_REQ
PCO Type	CSAP
Comment	To request to setup the associated transport channels and the Radio Link itself.
Type Definition	
<pre>SEQUENCE { cellId INTEGER(0..63), secondaryFrequency UARFCN OPTIONAL, routingInfo RoutingInfo, ratType RatType, setupMessage CphyRlSetupReq }</pre>	

ASN.1 ASP Type Definition	
Type Name	CPHY_RL_Modify_REQ
PCO Type	CSAP
Comment	<p>To request to modify the Radio Link</p> <p>HardHandover (PhysicalChannelReconfig)</p> <p>ChannelisationCodeChange</p> <p>FrequencyChange</p> <p>PhysicalChannelModifyForTrCHReconfig</p> <p>Re_Synchronized HardHandover</p>
Type Definition	
<pre>SEQUENCE { cellId INTEGER(0..63), secondaryFrequency UARFCN OPTIONAL, routingInfo RoutingInfo, ratType RatType, setupMessage CphyRlSetupReq }</pre>	

ASN.1 ASP Type Definition	
Type Name	CPHY_UpPCH_IND
PCO Type	CSAP
Comment	To indicate SS the UpPCH and PRACH received from the UE. sync_UL is the summary of sync UL UE sent in a period. pRACH is the summary of PRACH UE sent in a period.
Type Definition	
SEQUENCE	{
cellId	INTEGER (0..63),
sync_UL	INTEGER (0..256),
pRACH	INTEGER (0..256)
}	}

ASN.1 ASP Type Definition	
Type Name	CPHY_FPACH_REQ
PCO Type	CSAP
Comment	To request for Start or Stop of FPACH to reponse UpPCH received. If send_FPACH is FALSE, SS should not send FPACH to UE, else SS should send FPACH.If fPACH_Channel_Code is FALSE, SS should send FPACH to UE with wrong channel code, else SS should send FPACH with correct channel code.If signature is FALSE, SS should send FPACH to UE with wrong signature, else SS should send FPACH with correct signature. If subFrame_Number is FALSE, SS should send FPACH to UE with wrong subFrame Number, else SS should send FPACH with correct subFrame Number.
Type Definition	
SEQUENCE	{
cellId	INTEGER (0..63),
send_FPACH	BOOLEAN,
fPACH_Channel_Code	BOOLEAN,
signature	BOOLEAN,
subFrame_Number	BOOLEAN
}	}

ASN.1 ASP Type Definition	
Type Name	CPHY_Cell_Tx_Timing_Modify_REQ
PCO Type	CSAP
Comment	Applicable to Rel-4 or later for LCR TDD To request to modify Tx timing of a cell. The unit of tcell is 0.125 chip.
Type Definition	
SEQUENCE	{
cellId	INTEGER (0..63),
tcell	INTEGER (0..127)
}	}

ASN.1 ASP Type Definition	
Type Name	CPHY_Cell_Tx_Timing_Modify_CNF
PCO Type	CSAP
Comment	Applicable to Rel-4 or later for LCR TDD The confirmation to the CPHY_Cell_Tx_Timing_Modify_REQ
Type Definition	
SEQUENCE	{
cellId	INTEGER (0..63)
}	}

ASN.1 ASP Type Definition	
Type Name	RLC_AM_DATA_CNF
PCO Type	DSAP
Comment	For RLC emulator to report to the upper layer that a previously transmitted SDU has been acknowledged correctly by the UE
Type Definition	
<pre>SEQUENCE { cellId INTEGER(-1..63), secondaryFrequency UARFCN OPTIONAL, routingInfo RoutingInfo, mui Mui }</pre>	

ASN.1 ASP Type Definition	
Type Name	CPHY_RL_Release_REQ
PCO Type	CSAP
Comment	To request to release the Radio Link
Type Definition	
<pre>SEQUENCE { cellId INTEGER(0..63), routingInfo RoutingInfo, activationTime SS_ActivationTime OPTIONAL }</pre>	

ASN.1 ASP Type Definition	
Type Name	CPHY_TrCH_Release_CNF
PCO Type	CSAP
Comment	To confirm to release tthe Radio Link
Type Definition	
<pre>SEQUENCE { cellId INTEGER(0..63), routingInfo RoutingInfo }</pre>	

ASN.1 ASP Type Definition	
Type Name	CPHY_TrCH_Release_REQ
PCO Type	CSAP
Comment	To request to release the Radio Link
Type Definition	
<pre>SEQUENCE { cellId INTEGER(0..63), routingInfo RoutingInfo, trchConfigType TrchConfigType, activationTime SS_ActivationTime OPTIONAL }</pre>	

ASN.1 ASP Type Definition	
Type Name	CRLC_BindTestDataInOneMACHs_PDU_CNF
PCO Type	CSAP
Comment	To confirm the request of binding subsequent data sending RLC_TR/UM/AM_TestDataReq on the specified RB mapped on HS-DSCH in the same MACHs PDU.
Type Definition	
<pre>SEQUENCE { cellId INTEGER(-1..63), routingInfo RoutingInfo, --RB ID desired to be given result ENUMERATED{failure(0), success(1)} }</pre>	

ASN.1 ASP Type Definition	
Type Name	CRLC_BindTestDataInOneMAChs_PDU_REQ
PCO Type	CSAP
Comment	To request of binding subsequent data sending RLC_TR/UM/AM_TestDataReq on the specified RB mapped on HS-DSCH in the same Mac-HS PDU. On the request, the transmission of the test data is temporarily suppressed on the radio bearers till 'numOfSDU's' are received by RLC layer on the Radio Bearer. After receiving all SDU's the RLC layer submits to MAC such that all of them are sent in one MAC-Hs PDU.
Type Definition	
<pre>SEQUENCE { cellId INTEGER (-1..63), routingInfo RoutingInfo, --RB ID desired to be given numOfSDUs INTEGER -- Number of RLC SDU's }</pre>	

7.3.2.3.2 Specific IE definitions

ASN.1 Type Definition	
Type Name	CphyRIModifyReq
Comment	Applicable Rel-4 or later for LCR TDD
Type Definition	
<pre>SEQUENCE { activationTime SS_ActivationTime, physicalChannelInfo CHOICE { secondaryCCPCHInfo SecondaryCCPCHInfo, pRACHInfo PRACHInfo, dPCHInfo DPCHInfo, dPCHInfo_r5 DPCHInfo_r5 OrLater, hS_DPSCHInfo HS_DPSCHInfo_r5OrLater, e_DCHInfo SS_E_DCH_Info_r7, e_DCH_Non_ScheduledTransGrantInfo SS_Non_ScheduledTransGrantInfoTDD, e_AGCHInfo SS_E_AGCH_Info, e_HICHInfo SS_E_HICH_Info, mBMS_MICHInfo SS_MBMS_MICHConfigurationInfo_r6 }, trchConfigToFollow BOOLEAN DEFAULT TRUE }</pre>	

ASN.1 Type Definition	
Type Name	CphyRISetupReq
Comment	Applicable Rel-4 or later for LCR TDD [1] To request to setup the Radio Link; [2] Physical channel of FPACH is defined inside PRACHInfo.
Type Definition	
<pre>SEQUENCE { physicalChannelInfo CHOICE { primaryCCPCHInfo PrimaryCCPCHInfo, secondaryCCPCHInfo SecondaryCCPCHInfo, pRACHInfo PRACHInfo, pICHInfo PICHInfo, dPCHInfo DPCHInfo, pDSCHInfo PDSCHInfo, pUSCHInfo PUSCHInfo, dPCHInfo_r5 DPCHInfo_r5 OrLater, hS_DPSCHInfo HS_DPSCHInfo_r5OrLater, e_DCHInfo SS_E_DCH_Info_r7, e_DCH_Non_ScheduledTransGrantInfo SS_Non_ScheduledTransGrantInfoTDD, e_AGCHInfo SS_E_AGCH_Info, e_HICHInfo SS_E_HICH_Info, mBMS_MICHInfo SS_MBMS_MICHConfigurationInfo_r6 }, activationTime SS_ActivationTime OPTIONAL, trchConfigToFollow BOOLEAN DEFAULT TRUE }</pre>	

ASN.1 Type Definition	
Type Name	CmacConfigReq
Comment	To request to configure MAC. The IE associatedPhychConfigToFollow should be set to TRUE when there is a associated physical channel configuration to follow (e.g configuration of PICH or MICH), The implementation of the IE "associatedPhychConfigToFollow" can be left to the SS either to wait for the associated physical channel before MAC is configured or to continue the configuration of MAC without waiting for the associated physical channel. If Dual Cell is configured, IE servingAndSecondaryCellActivation is included.
Type Definition	
<pre>SEQUENCE { activationTime SS_ActivationTime, uE_Info UE_Info, trCHInfo TrCHInfo, trCH_LogCHMapping TrCH_LogCHMappingList1, associatedPhychConfigToFollow SEQUENCE (SIZE(1..4)) OF INTEGER OPTIONAL }</pre>	

ASN.1 Type Definition	
Type Name	PrimaryCCPCHInfo
Comment	Applicable Rel-4 or later for LCR TDD
Type Definition	
<pre>SEQUENCE { sctd_Indicator ENUMERATED {notApplied (0), applied (1)}, tst_d_Indicator ENUMERATED {notApplied (0), applied (1)}, commonTimeSlotInfo CommonTimeSlotInfo, dL_TxPower_PCCPCH DL_TxPower_PCCPCH }</pre>	

ASN.1 Type Definition	
Type Name	SecondaryCCPCHInfo
Comment	Applicable Rel-4 or later for LCR TDD The range for powerOffsetOfTFCI_PO1 is 0-6 dB, 0.25 dB per step.
Type Definition	
<pre>SEQUENCE { tst_d_Indicator ENUMERATED {notApplied (0), applied (1)}, sctd_Indicator ENUMERATED {notApplied (0), applied (1)}, dl_TxPower DL_TxPower, commonTimeSlotInfo CommonTimeSlotInfoSCCPCH, channelisationCode SCCPCH_ChannelisationCodeList, individualTimeSlotInfo IndividualTimeSlotInfo_LCR_r4, powerOffsetOfTFCI_PO1 INTEGER (0..24) OPTIONAL }</pre>	

ASN.1 Type Definition	
Type Name	PRACHInfo
Comment	Applicable Rel-4 or later for LCR TDD
Type Definition	
<pre>SEQUENCE { prach_RACH_Info_LCR_r4 PRACH_RACH_Info_LCR_r4, accessServiceClass_TDD_LCR AccessServiceClass_TDD_LCR_r4, fpach_Power DL_TxPower }</pre>	

ASN.1 Type Definition	
Type Name	DL_DPCHInfo
Comment	Applicable Rel-4 or later for LCR TDD The range for powerOffsetOfTPC_PO2 and powerOffsetOfTFCI_PO1 is 0 dB to 6 dB, 0,25 dB per step.
Type Definition	
<pre>SEQUENCE { dl_CommonInformation DL_CommonInformation_r4, dl_DPCH_InfoPerRL DL_DPCH_InfoPerRL_r4, powerOffsetOfTFCI_PO1 INTEGER (0..24), powerOffsetOfTPC_PO2 INTEGER (0..24), dl_TxPower DL_TxPower, dl_TxPowerMax DL_TxPower, dl_TxPowerMin DL_TxPower, dl_TimeslotISCPInfoLCR TimeslotListWithISCP }</pre>	

ASN.1 Type Definition	
Type Name	DL_DPCHInfo_r5
Comment	Applicable Rel-4 or later for LCR TDD The range for powerOffsetOfTPC_PO2 and powerOffsetOfTFCI_PO1 is 0 dB to 6 dB, 0,25 dB per step.
Type Definition	
<pre>SEQUENCE { dl_CommonInformation DL_CommonInformation_r5, dl_DPCH_InfoPerRL DL_DPCH_InfoPerRL_r5, powerOffsetOfTFCI_PO1 INTEGER (0..24), powerOffsetOfTPC_PO2 INTEGER (0..24), dl_TxPower DL_TxPower, dl_TxPowerMax DL_TxPower, dl_TxPowerMin DL_TxPower, dl_TimeslotISCPInfoLCR TimeslotListWithISCP }</pre>	

ASN.1 Type Definition	
Type Name	PDSCHInfo
Comment	Applicable Rel-4 or later for LCR TDD
Type Definition	
<pre>SEQUENCE { pdsch_Identity PDSCH_Identity, pdsch_Info PDSCH_Info_r4, pdsch_PowerControlInfo PDSCH_PowerControlInfo OPTIONAL, dl_TxPower DL_TxPower }</pre>	

ASN.1 Type Definition	
Type Name	HS_DSCHMACdFlows
Comment	Applicable Rel-5 or later. Within the ACK/NACK repetition period indicated by ackNackRepetitionFactor the SS shall not transmit MAC-hs PDU's on HS-PDSCH.
Type Definition	
<pre>SEQUENCE { harqInfo HARQ_Info OPTIONAL, addOrReconfMACdFlow SS_AddOrReconfMAC_dFlow OPTIONAL, harqInfo_r7 HARQ_Info_r7 OPTIONAL }</pre>	

ASN.1 Type Definition	
Type Name	CommonOrDedicatedTFS
Comment	Applicable Rel-4 or later for LCR TDD Transport Format Set
Type Definition	
<pre>SEQUENCE { tfsMode CHOICE { dedicatedTransChTFS DedicatedTransChTFS, commonTransChTFS CommonTransChTFS, commonTransChTFS_LCR CommonTransChTFS_LCR } }</pre>	

ASN.1 Type Definition	
Type Name	DL_TxPower_PCCPCH
Comment	Applicable Rel-4 or later for LCR TDD Absolute Tx Power of PCCPCH
Type Definition	
<pre>INTEGER (-60..-30)</pre>	

ASN.1 Type Definition	
Type Name	DPCHInfo
Comment	Applicable Rel-4 or later for LCR TDD
Type Definition	
<pre>SEQUENCE { ul_DPCHInfo UL_DPCHInfo OPTIONAL, dl_DPCHInfo DL_DPCHInfo OPTIONAL }</pre>	

ASN.1 Type Definition	
Type Name	DwPCH_Power
Comment	Applicable Rel-4 or later for LCR TDD DwPCH_power = power * 10 Unit dBm, Range -15dBm .. +40 dBm, Step +0.1dB
Type Definition	
<pre>INTEGER (-150..400)</pre>	

ASN.1 Type Definition	
Type Name	DwPCHInfo
Comment	Applicable Rel-4 or later for LCR TDD
Type Definition	
<pre>SEQUENCE { tstnd_Indicator ENUMERATED {notApplied (0),applied (1)}, dwPCH_Power DwPCH_Power }</pre>	

ASN.1 Type Definition	
Type Name	four_PICH_pl_BitmapInfo
Comment	Applicable Rel-4 or later for LCR TDD
Type Definition	
<pre>CHOICE { e88 BIT STRING (SIZE (88)), e176 BIT STRING (SIZE (176)), e352 BIT STRING (SIZE (352)) }</pre>	

ASN.1 Type Definition	
Type Name	two_PICH_pl_BitmapInfo
Comment	Applicable Rel-4 or later for LCR TDD
Type Definition	
CHOICE {	
e44	BIT STRING (SIZE (44)),
e88	BIT STRING (SIZE (88)),
e176	BIT STRING (SIZE (176))
}	

ASN.1 Type Definition	
Type Name	PDSCHInfo
Comment	Applicable Rel-4 or later for LCR TDD
Type Definition	
SEQUENCE {	
pdsch_Identity	PDSCH_Identity,
pdsch_Info	PDSCH_Info_r4,
pdsch_PowerControlInfo	PDSCH_PowerControlInfo OPTIONAL,
dl_TxPower	DL_TxPower
}	

ASN.1 Type Definition	
Type Name	PICHInfo
Comment	Applicable Rel-4 or later for LCR TDD
Type Definition	
SEQUENCE {	
Pichinfo	PICH_Info_LCR_r4,
dl_TxPower	PICH_PowerOffset,
sccpchId_associated	INTEGER (0..32)
}	

ASN.1 Type Definition	
Type Name	PRACHInfo
Comment	Applicable Rel-4 or later for LCR TDD
Type Definition	
SEQUENCE {	
prach_RACH_Info_LCR_r4	PRACH_RACH_Info_LCR_r4,
accessServiceClass_TDD_LCR	AccessServiceClass_TDD_LCR_r4,
fpach_Power	DL_TxPower
}	

ASN.1 Type Definition	
Type Name	PrimaryCCPCHInfo
Comment	Applicable Rel-4 or later for LCR TDD
Type Definition	
SEQUENCE {	
sctd_Indicator	ENUMERATED {NotApplied(0),Applied(1)},
tstd_Indicator	ENUMERATED {NotApplied(0),Applied(1)},
commonTimeSlotInfo	CommonTimeSlotInfo,
dl_TxPower_PCCPCH	DL_TxPower_PCCPCH
}	

ASN.1 Type Definition	
Type Name	PUSCHInfo
Comment	Applicable Rel-4 or later for LCR TDD
Type Definition	
SEQUENCE {	
pusch_Identity	PUSCH_Identity,
pusch_Info	PUSCH_Info_r4,
pusch_PowerControlInfo	PUSCH_PowerControlInfo_r4 OPTIONAL
}	

ASN.1 Type Definition	
Type Name	RatType
Comment	Applicable Rel-4 or later for LCR TDD To select route between each channels
Type Definition	
<pre> ENUMERATED { fdd(0), tdd128(1) } </pre>	

ASN.1 Type Definition	
Type Name	SecondaryCCPCHInfo
Comment	Applicable Rel-4 or later for LCR TDD
Type Definition	
<pre> SEQUENCE { tstd_Indicator ENUMERATED {NotApplied(0),Applied(1)}, sctd_Indicator ENUMERATED {NotApplied(0),Applied(1)}, dl_TxPower DL_TxPower, commonTimeSlotInfo CommonTimeSlotInfoSCCPCH, channelisationCode SCCPCH_ChannelisationCodeList, individualTimeSlotInfo IndividualTimeSlotInfo_LCR_r4, powerOffsetOfTFCI_PO1 INTEGER (0..24) OPTIONAL } </pre>	

ASN.1 Type Definition	
Type Name	SS_UL_TransportChannelType
Comment	Applicable Rel-4 or later for LCR TDD
Type Definition	
<pre> ENUMERATED { dch(0), rach(1), usch(2), edch(3) -- Rel-6 or later } </pre>	

ASN.1 Type Definition	
Type Name	TimeSlotConfiguration_LCR
Comment	Applicable Rel-4 or later for LCR TDD
Type Definition	
<pre> SEQUENCE { timeSlotLCR TimeslotNumber_LCR_r4, timeSlotStatus ENUMERATED {active(0),notActive(1)}, timeSlotDirection ENUMERATED {downlink(0),uplink(1)} } </pre>	

ASN.1 Type Definition	
Type Name	TimeSlotConfigurationList_LCR
Comment	Applicable Rel-4 or later for LCR TDD
Type Definition	
SEQUENCE (SIZE (1..maxTS LCR)) OF TimeSlotConfiguration LCR	

ASN.1 Type Definition	
Type Name	TimeslotListWithISCP_LCR
Comment	Applicable Rel-4 or later for LCR TDD
Type Definition	
SEQUENCE (SIZE (1..maxTS)) OF TimeslotWithISCP_LCR	

ASN.1 Type Definition	
Type Name	TimeslotWithISCP_LCR
Comment	Applicable Rel-4 or later for LCR TDD
Type Definition	
<pre>SEQUENCE { Timeslot TimeslotNumber_LCR_r4, timeslotISCP TimeslotISCP }</pre>	

ASN.1 Type Definition	
Type Name	UL_DPCHInfo
Comment	Applicable Rel-4 or later for LCR TDD
Type Definition	
<pre>SEQUENCE { uL_DPCH_Info UL_DPCH_Info_r4 }</pre>	

ASN.1 Type Definition	
Type Name	HS_PDSCH_ChannelisationCodeInfo_LCR
Comment	
Type Definition	
<pre>SEQUENCE { timeslotNumber TimeslotNumber_LCR_r4, startCode HS_ChannelisationCode_LCR, stopCode HS_ChannelisationCode_LCR }</pre>	

ASN.1 Type Definition	
Type Name	HS_PDSCHInfo_r5OrLater
Comment	<p>Applicable Rel-5 or later for LCR TDD</p> <p>When CHY_RL_Setup_REQ is called with CHOICE of HS_PDSCHInfo HS_PDSCH and HS-SCCH shall be configured in SS.</p> <p>The following HS-DSCH related parameters are passed to the SS implicitly by HSDSCH_physical_layer_category:</p> <ul style="list-style-type: none"> - Maximum number of HS-DSCH codes can be received by UE, - Minimum inter-TTI interval, - Maximum number of bits of an HS-DSCH transport block within an HS-DSCH TTI - Total number of soft channel bits". <p>HSDSCH_physical_Layer_category is also used for interpretation of the meaning of CQI value.</p> <p>If hs_DPCCHToFollow is FALSE, the hs_DPCCHInd IE shall not be present when ul_DPCHInfo is configured or reconfigured.</p>
Type Definition	
<pre> CHOICE { r5 SEQUENCE { hSDSCHPhysicalLayerCategory HSDSCH_physical_layer_category, h_RNTI H_RNTI, dlHSPDSCHInformation DL_HSPDSCH_Information, sttd_Indicator BOOLEAN, hs_SCCH_TxPower DL_TxPower, -- offset related to pilot bits on DL-DPCCH hs_PDSCHChannelisationCodeInfo SEQUENCE (SIZE (1..maxPDSCHtimeslot)) OF HS_PDSCH_ChannelisationCodeInfo_LCR, hs_DPCCHToFollow BOOLEAN DEFAULT TRUE }, r6 SEQUENCE { hSDSCHPhysicalLayerCategory HSDSCH_physical_layer_category, h_RNTI H_RNTI, dlHSPDSCHInformation DL_HSPDSCH_Information_r6, sttd_Indicator BOOLEAN, hs_SCCH_TxPower DL_TxPower, -- offset related to pilot bits on DL-DPCCH hs_PDSCHChannelisationCodeInfo SEQUENCE (SIZE (1..maxPDSCHtimeslot)) OF HS_PDSCH_ChannelisationCodeInfo_LCR, hs_DPCCHToFollow BOOLEAN DEFAULT TRUE }, r7 HS_PDSCHInfo_r7, r8 HS_PDSCHInfo_r8, r9 HS_PDSCHInfo_r9, spare2 SEQUENCE {} } </pre>	

Type Name	HS_PDSCHInfo_r7
Comment	<p>Rel-7 or later. Choice of hS_PDSCH_Info will be used for configuring HSD-DSCH with 64QAM and/or CPC. Choice of common_HS_PDSCH_Info will be used for Enhanced Cell_FACH. commonOrDedicated_H_RNTI indicates, the H-RNTI that will be used by UE (either dedicated H-RNTI if provided in RRC message, or selected common H-RNTI transmitted in SIB5). The transmission of BCCH on HS-DSCH is performed by using BCCH specific H-RNTI on the first indexed HS-SCCH code indicated in system information broadcast. Presence of ss_DTX_Info makes DL DRX to be enabled. Presence of hs_scch_LessInfo makes HS-SCCH less operation enabled. Presence of mimo_Parameters indicate MIMO is to be started. MIMO and HS-SCCH less operation do not co-exist. MIMO is not applicable for non DCH states. The two IE "hSDSCHPhysicalLayerCategory" and "hdsch_physical_layer_category_ext" are mutually exclusive. One of the IE shall be present in the SS configuration. The IE "hdsch_physical_layer_category_ext" is present when MAC-ehs is configured. If commonOrDedicated_H_RNTI is omitted, HS-SCCHless is to be applied. If hs_DPCCHToFollow is FALSE, the hs_DPCCHInd IE shall not be present when ul_DPCHInfo is configured or reconfigured. In common_HS_PDSCH_Info, hs_DPCCHToFollow is set to FALSE unless HS-DPCCH is required in specific configuration.</p>
Type Definition	
<pre> CHOICE { hS_PDSCH_Info SEQUENCE { hSDSCHPhysicalLayerCategory HSDSCH_physical_layer_category OPTIONAL, hdsch_physical_layer_category_ext HSDSCH_physical_layer_category_ext OPTIONAL, h_RNTI H_RNTI, dlHSPDSCHInformation DL_HSPDSCH_Information_r7, sttd_Indicator BOOLEAN, hs_SCCH_TxPower DL_TxPower, -- offset related to CPICH hs_PDSCHChannelisationCodeInfo SEQUENCE (SIZE (1..maxPDSCHtimeslot)) OF HS_PDSCH_ChannelisationCodeInfo_LCR, ss_DTX_Info DRX_Info OPTIONAL, mimo_Parameters MIMO_Parameters_r7 OPTIONAL, hs_DPCCHToFollow BOOLEAN DEFAULT TRUE }, common_HS_PDSCH_Info SEQUENCE { hdsch_physical_layer_category_ext HSDSCH_physical_layer_category_ext, commonOrDedicated_H_RNTI H_RNTI OPTIONAL, bcchSpecific_H_RNTI H_RNTI, hs_scch_SystemInfo HS_SCCH_SystemInfo, hs_dsch_PagingSystemInformation HS_DSCH_PagingSystemInformation OPTIONAL, sttd_Indicator BOOLEAN, hs_SCCH_TxPower DL_TxPower, -- offset related to CPICH hs_DPCCHToFollow BOOLEAN DEFAULT TRUE }, spare2 SEQUENCE {}, spare3 SEQUENCE {} } </pre>	

ASN.1 Type Definition	
Type Name	HS_PDSCHInfo_r8
Comment	<p>Applicable Rel-8 or later.</p> <p>Choice of hs_PDSCH_Info will be used for configuring HSD-DSCH with 64QAM and/or CPC.</p> <p>Choice of common_HS_PDSCH_Info will be used for Enhanced Cell_FACH. commonOrDedicated_H_RNTI indicates, the H-RNTI that will be used by UE (either dedicated H-RNTI if provided in RRC message, or selected common H-RNTI transmitted in SIB5).</p> <p>The transmission of BCCH on HS-DSCH is performed by using BCCH specific H-RNTI on the first indexed HS-SCCH code indicated in system information broadcast.</p> <p>Presence of controlChannelDRXInfo_TDD128 makes DL DRX to be enabled.</p> <p>Presence of sps_Information_TDD128 makes SPS operation enabled.</p> <p>Presence of mimo_Parameters indicate MIMO is to be started.</p> <p>MIMO and HS-SCCH less operation do not co-exist. MIMO is not applicable for non DCH states.</p> <p>The three IE "hSDSCHPhysicalLayerCategory", "hdsch_physical_layer_category_ext" and "hdsch_physical_layer_category_ext2" are mutually exclusive. One of the IE shall be present in the SS configuration. The IE</p> <p>If hs_DPCCHToFollow is FALSE, the hs_DPCCHInd IE shall not be present when ul_DPCHInfo is configured or reconfigured.</p> <p>Presence of ss_HS_DSCH_DtxCellFach makes HS-DSCH DRX operation enabled and SS shall transmit any requested HS-SCCH and HS-DSCH only in occasions when UE will be listening.</p> <p>hs_PDSCHChannelisationCodeInfo present in TDD configurations.</p>
Type Definition	
	<pre> CHOICE { hs_PDSCH_Info SEQUENCE { hSDSCHPhysicalLayerCategory HSDSCH_physical_layer_category OPTIONAL, hdsch_physical_layer_category_ext HSDSCH_physical_layer_category_ext OPTIONAL, multiCarrier_physical_layer_category MultiCarrier_HSDSCH_physical_layer_category OPTIONAL, multiCarrier_physical_layer_category_extension MultiCarrier_HSDSCH_physical_layer_category_extension OPTIONAL, h_RNTI H_RNTI, dlHSPDSCHInformation DL_HSPDSCH_Information_r8, sttd_Indicator BOOLEAN, hs_SCCH_TxPower DL_TxPower, -- offset related to CPICH mimo_Parameters MIMO_Parameters_r8 OPTIONAL, hs_PDSCHChannelisationCodeInfo SEQUENCE (SIZE (1..maxPDSCHtimeslot)) OF HS_PDSCH_ChannelisationCodeInfo_LCR OPTIONAL, hs_DPCCHToFollow BOOLEAN DEFAULT TRUE, controlChannelDRXInfo_TDD128 ControlChannelDRXInfo_TDD128_r8 OPTIONAL, sps_Information_TDD128 SPS_Information_TDD128_r8 OPTIONAL }, common_HS_PDSCH_Info SEQUENCE { hdsch_physical_layer_category_ext HSDSCH_physical_layer_category_ext, commonOrDedicated_H_RNTI H_RNTI OPTIONAL, bcchSpecific_H_RNTI H_RNTI, hs_scch_SystemInfo_tdd128 HS_SCCH_SystemInfo_TDD128 OPTIONAL,, hs_pdsch_MidambleConfiguration HS_PDSCH_Midamble_Configuration_TDD128 OPTIONAL, hs_dsch_PagingSystemInformation_tdd128 HS_DSCH_PagingSystemInformation_TDD128 OPTIONAL, sttd_Indicator BOOLEAN, hs_SCCH_TxPower DL_TxPower, -- offset related to CPICH hs_DPCCHToFollow BOOLEAN DEFAULT TRUE, ss_HS_DSCH_DtxCellFach HS_DSCH_DrxCellfach_info_TDD128 OPTIONAL }, spare2 SEQUENCE {}, spare3 SEQUENCE {} } </pre>

ASN.1 Type Definition	
Type Name	HS_PDSCHInfo_r9
Comment	<p>Applicable Rel-9 or later.</p> <p>Choice of hS_PDSCH_Info will be used for configuring HSD-DSCH with 64QAM and/or CPC.</p> <p>Choice of common_HS_PDSCH_Info will be used for Enhanced Cell_FACH. commonOrDedicated_H_RNTI indicates, the H-RNTI that will be used by UE (either dedicated H-RNTI if provided in RRC message, or selected common H-RNTI transmitted in SIB5).</p> <p>The transmission of BCCH on HS-DSCH is performed by using BCCH specific H-RNTI on the first indexed HS-SCCH code indicated in system information broadcast.</p> <p>Presence of controlChannelDRXInfo_TDD128 makes DL DRX to be enabled.</p> <p>Presence of sps_Information_TDD128 makes SPS operation enabled.</p> <p>Presence of mimo_Parameters indicate MIMO is to be started.</p> <p>The IEs "hSDSCHPhysicalLayerCategory", "hdsch_physical_layer_category_ext", are mutually exclusive. One of the IE shall be present in the SS configuration. The IE If commonOrDedicated_H_RNTI is omitted, HS-SCCHless is to be applied.</p> <p>If hs_DPCCHToFollow is FALSE, the hs_DPCCHInd IE shall not be present when ul_DPCHInfo is configured or reconfigured.</p> <p>Presence of ss_HS_DSCH_DtxCellFach makes HS-DSCH DRX operation enabled and SS shall transmit any requested HS-SCCH and HS-DSCH only in occasions when UE will be listening.</p> <p>hs_PDSCHChannelisationCodeInfo present in TDD configurations.</p>
Type Definition	
<pre> CHOICE { hs_PDSCH_Info SEQUENCE { hSDSCHPhysicalLayerCategory HSDSCH_physical_layer_category OPTIONAL, hdsch_physical_layer_category_ext HSDSCH_physical_layer_category_ext OPTIONAL, multiCarrier_physical_layer_category MultiCarrier_HSDSCH_physical_layer_category OPTIONAL, multiCarrier_physical_layer_category_extension MultiCarrier_HSDSCH_physical_layer_category_extension OPTIONAL, h_RNTI H_RNTI, dlHSPDSCHInformation DL_HSPDSCH_Information_r9, sttd_Indicator BOOLEAN, hs_SCCH_TxPower DL_TxPower, -- offset related to CPICH mimo_Parameters MIMO_Parameters_r9 OPTIONAL, hs_PDSCHChannelisationCodeInfo SEQUENCE (SIZE (1..maxPDSCHtimeslot)) OF HS_PDSCH_ChannelisationCodeInfo_LCR OPTIONAL, hs_DPCCHToFollow BOOLEAN DEFAULT TRUE, controlChannelDRXInfo_TDD128 ControlChannelDRXInfo_TDD128_r8 OPTIONAL, sps_Information_TDD128 SPS_Information_TDD128_r8 OPTIONAL }, common_HS_PDSCH_Info SEQUENCE { hdsch_physical_layer_category_ext HSDSCH_physical_layer_category_ext, commonOrDedicated_H_RNTI H_RNTI OPTIONAL, bcchSpecific_H_RNTI H_RNTI, hs_scch_SystemInfo_tdd128 HS_SCCH_SystemInfo_TDD128 OPTIONAL,, hs_pdsch_MidambleConfiguration HS_PDSCH_Midamble_Configuration_TDD128 OPTIONAL, hs_dsch_PagingSystemInformation_tdd128 HS_DSCH_PagingSystemInformation_TDD128 OPTIONAL, sttd_Indicator BOOLEAN, hs_SCCH_TxPower DL_TxPower, -- offset related to CPICH hs_DPCCHToFollow BOOLEAN DEFAULT TRUE, ss_HS_DSCH_DtxCellFach HS_DSCH_DrxCellfach_info_TDD128 OPTIONAL }, spare2 SEQUENCE {}, spare3 SEQUENCE {} } </pre>	

ASN.1 Type Definition	
Type Name	SS_E_DCH_Info_r7
Comment	Applicable Rel-7 or later for LCR TDD
Type Definition	
<pre> SEQUENCE { e_RUCCH_Info E_RUCCH_Info OPTIONAL, e_PUCH_Info SS_E_PUCH_Info OPTIONAL } </pre>	

ASN.1 Type Definition	
Type Name	SS_E_AGCH_Info
Comment	Applicable Rel-7 or later for LCR TDD
Type Definition	
<pre> CHOICE { r7 SEQUENCE { e_AGCH_ID_TDD INTEGER (0..255), e_AGCHInfo E_AGCH_Information_r7, e_AGCH_PowerOffset INTEGER (0..255), -- Range and Step are FFS (25.433, 9.2.2.13If) -- Offset relative to P-CPICH maximum_E_AGCH_Power INTEGER (-350..150), carrier_Frequency UARFCN OPTIONAL, e_RNTI E_RNTI OPTIONAL, ss_DTX_Info DRX_Info OPTIONAL }, r8 SEQUENCE { -- Rel-8 or later e_AGCH_ID_TDD INTEGER (0..255), e_AGCHInfo E_AGCH_Information_r8, e_AGCH_PowerOffset INTEGER (0..255), -- Range and Step are FFS (25.433, 9.2.2.13If) -- Offset relative to P-CPICH maximum_E_AGCH_Power INTEGER (-350..150), carrier_Frequency UARFCN OPTIONAL, e_RNTI E_RNTI OPTIONAL, ss_E_AGCH_Drx_Info E_AGCH_DRX_Info_TDD128 OPTIONAL }, spare1 SEQUENCE {}, spare2 SEQUENCE {} } </pre>	

ASN.1 Type Definition	
Type Name	SS_E_HICH_Info
Comment	Applicable Rel-7 or later for LCR TDD
Type Definition	
<pre> SEQUENCE { n_E_HICH INTEGER (4..15), maximum_E_HICH_Power INTEGER (-350..150), e_HICHInfoList SS_E_HICH_Info_List } </pre>	

ASN.1 Type Definition	
Type Name	E_DCHMACdFlows
Comment	Applicable Rel-7 or later for LCR TDD
Type Definition	
<pre> SEQUENCE { harq_Info ENUMERATED {rv0 (0), rvtable (1)}, addReconf_MAC_d_FlowList_r7 E_DCH_AddReconf_MAC_d_FlowList_r7 OPTIONAL -- Rel-7 or later } </pre>	

ASN.1 Type Definition	
Type Name	MACeConfig
Comment	<p>Applicable Rel-7 or later for LCR TDD</p> <p>If the macHeaderManipulation field is 'NormalMacHeader' in ddiMappingList, then data received on the E-DCH (MAC_e PDU) shall have it's MAC header inspected to de-multiplex and to determine the appropriate routing, and the MACes PDU shall be passed to the MAC_es together with the relevant DDI, N, CFN and subframe number.</p> <p>If the macHeaderManipulation field field is 'OmitMacHeader', then data received on the E-DCH (MAC_e PDU) shall have it's MAC header inspected to de-multiplex and to determine the appropriate routing, then the MAC_e layer shall delivery the MAC-es PDU, SI and the related CFN, subframe number to the MAC_es entity.</p>
Type Definition	
<pre> SEQUENCE { activationTime SS_ActivationTime, ddiMappinglist DDI_MappingList OPTIONAL, e_DCHMacdFlows E_DCHMACdFlows OPTIONAL } </pre>	

ASN.1 Type Definition	
Type Name	MACiConfig
Comment	<p>If the macHeaderManipulation field is 'NormalMacHeader' in ICH_Mappinglist, then data received on the E-DCH (MAC_i PDU) shall have it's MAC header inspected to de-multiplex and to determine the appropriate routing, and the MACis PDU shall be passed to the MAC_is together with the relevant LCH_ID, length, F, CFN and subframe number.</p> <p>If the macHeaderManipulation field field is 'OmitMacHeader', then data received on the E-DCH (MAC-i PDU) shall have it's MAC header inspected to de-multiplex and to determine the appropriate routing, then the MAC-i layer shall deliver the MAC-is PDU, SI and the related CFN, subframe number to the MAC-is entity.</p> <p>connectedToMAC_is field is used to provide the possibility that the E-DCH-MACdFlows from only one MAC-i entity are connected to the MAC_is entity in the inter node B soft handover test cases. When MAC-i is configured in enhanced FACH UL using commonMac_i_r8, the MAC-i entity is always connected to MAC-is.</p> <p>The IEs ICH_Mappinglist and e_DCHMacdFlows can be OMITted when changing the serving cell MAC-i without modification of MAC-i configurations. It will be applied in EDCH SHO.</p> <p>ss_DRX_MAC_Info presence indicates UL DRX shall be applied.</p>
Type Definition	
<pre>CHOICE { mac_i_r8 SEQUENCE { -- Rel-8 or later activationTime SS_ActivationTime, lch_Mappinglist LCH_MappingList OPTIONAL, e_DCHMacdFlows E_DCHMACdFlows OPTIONAL, connectedToMAC_is BOOLEAN DEFAULT TRUE -- can be set to FALSE in inter nodeB SHO }, commonMac_i_r8 SEQUENCE { activationTime SS_ActivationTime, lch_Mappinglist LCH_MappingList OPTIONAL, e_DCHMacdFlows CommonE_DCHMACdFlows OPTIONAL }, spare1 NULL }</pre>	

ASN.1 Type Definition	
Type Name	SS_E_PUCH_Info
Comment	Applicable Rel-7 or later for LCR TDD
Type Definition	
<pre>SEQUENCE { LTGI_Presence BOOLEAN, e_TFCS_Info E_TFCS_Info, snpl_ReportType ENUMERATED {type1(0), type2(1)}, prxBASEdes INTEGER (-112..-50), beaconPLEst BOOLEAN OPTIONAL, tpc_StepSize TPC_StepSizeTDD, pebase_PowerControlGAP PowerControlGAP OPTIONAL, ul_SynchronisationParameters UL_SynchronisationParameters_r4 OPTIONAL, minimum_Allowed_Code_Rate INTEGER (0..63), maximum_Allowed_Code_Rate INTEGER (0..63), maximumNumOfRetransSchedInfo INTEGER (0..15), retransTimerForSchedInfo ENUMERATED {ms10(0), ms15(1), ms20(2), ms25(3), ms30(4), ms35(5), ms40(6), ms45(7), ms50(8), ms55(9), ms60(10), ms65(11), ms70(12), ms75(13), ms80(14), ms85(15), ms90(16), ms95(17), ms100(18), ms110(19), ms120(20), ms140(21), ms160(22), ms200(23), ms240(24), ms280(25), ms320(26), ms400(27), ms480(28), ms560(29)}, powerOffsetForSchedInfo INTEGER (0..6) OPTIONAL, e_DCH_phyLayCategory INTEGER (1..6) OPTIONAL, e_PUCH_TS_Information_per_UARFCN SEQUENCE (SIZE (1..maxTS_LCR_1)) OF SS_E_PUCH_Timeslot_Info, carrier_Frequency UARFCN OPTIONAL }</pre>	

ASN.1 Type Definition	
Type Name	SS_E_PUCH_Timeslot_Info
Comment	Applicable Rel-7 or later for LCR TDD
Type Definition	
<pre>SEQUENCE { timeslotNumber TimeslotNumber_LCR_r4, midambleAllocationMode CHOICE { defaultMidamble NULL, ueSpecificMidamble INTEGER (0..15) }, midambleConfiguration INTEGER (1..8), channelisation_Code UL_TS_ChannelisationCode }</pre>	

ASN.1 Type Definition	
Type Name	SS_Non_ScheduledTransGrantInfoTDD
Comment	Applicable Rel-7 or later for LCR TDD
Type Definition	
<pre>CHOICE { tdd384_768 SEQUENCE { timeslotResourceRelatedInfo BIT STRING (SIZE (13)), powerResourceRelatedInfo INTEGER (1..32), activationTime ActivationTime, repetitionPeriodAndLength RepetitionPeriodAndLength OPTIONAL, codeResourceInfo UL_TS_ChannelisationCode }, tdd128 SEQUENCE { n_E_UCCH INTEGER (1..8) OPTIONAL, n_E_HICH INTEGER (4..15) OPTIONAL, timeslotResourceRelatedInfo BIT STRING (SIZE (5)), powerResourceRelatedInfo INTEGER (1..32), activationTime ActivationTime, sfnNum INTEGER (0..1), repetitionPeriodAndLength RepetitionPeriodAndLength OPTIONAL, codeResourceInfo UL_TS_ChannelisationCode, e_HICH_Info SEQUENCE { e_HICH_ID_TDD INTEGER (0..255), signature_Sequence_Group_Index INTEGER (0..19) } } }</pre>	

ASN.1 Type Definition	
Type Name	SS_E_HICH_Info_LCR
Comment	Applicable Rel-7 or later for LCR TDD
Type Definition	
<pre>SEQUENCE { e_HICH_ID_TDD INTEGER (0..255), e_HICH_Type ENUMERATED {scheduled (0), non_scheduled(1)}, e_HICHInfo E_HICH_Information_LCR, carrier_Frequency UARFCN OPTIONAL, e_HICH_PowerOffset INTEGER (0..255) -- PowerOffset = -32 + offset * 0.25 -- Unit dB, Range -32dB .. +31.75dB, Step +0.25dB -- (25.433, 9.2.2.13Id), offset relative to P-CPICH }</pre>	

ASN.1 Type Definition	
Type Name	SS_E_HICH_Info_List
Comment	Applicable Rel-7 or later for LCR TDD
Type Definition	
<pre>SEQUENCE (SIZE (1..maxNumE_HICH)) OF SS_E_HICH_Info_LCR</pre>	

ASN.1 Type Definition	
Type Name	E_TFCS_Restriction
Comment	Applicable Rel-7 or later for LCR TDD The E_TFCS restriction is a list of E-TFCIs, and can be used to verify that the UE has used a specific TFC. Any data received by the SS using a forbidden TFCI shall be discarded.
Type Definition	
SEQUENCE OF INTEGER (0..63)	

ASN.1 Type Definition	
Type Name	SS_RLC_Info
Comment	Applicable to Rel-4, Rel-5, Rel-6, Rel-7 for LCR TDD. UL and DL have been swapped intentionally in this type definition. This is to maximize re-use of the type definitions in 3GPP TS 25.331 [21] which are intended to configure a UE, where UL is transmission, and DL is reception. For the SS, UL is reception, and DL is transmission. For example, consider configuring a DL AM RLC entity (transmitter) in the SS. The transmission parameters to be configured include PollingInformation, Transmission-RLC-Discard etc. If the DL-AM-RLC-Mode type definition is used to configure this entity, it is only possible to configure reception parameters such as StatusInformation, and receiving window size. By swapping UL and DL, it is possible to configure the DL AM RLC entity using the existing type definition UL-AM-RLC-Info, which contains all of the required transmission parameters. When uM_SN_DeliveryMode is set to configured, the RLC entity does not concatenate nor segment RLC SDUs (see 3GPP TS 25.322 [18], subclause 8.2). If the IE useSpecialValueOfHEField is set to true, the last octet of the PDU is the last octet of an SDU and there is no SDU concatenation inside the PDU. sS_ul_PayloadSize is applied to RB0 RLC UL configuration; if it is omitted in the configuration the dl_PayloadSize is applied to UL RLC entity.
Type Definition	
<pre>SEQUENCE { sS_ul_RLC_Mode DL_RLC_Mode OPTIONAL, sS_ul_PayloadSize PayloadSize OPTIONAL, sS_dl_RLC_Mode SS_DL_RLC_Mode OPTIONAL, rlc_OneSidedReEst BOOLEAN DEFAULT FALSE, altE_bitInterpretation ENUMERATED {false (0), true (1)} DEFAULT false, -- applicable only for UM RLC mode of Rel-7 or later useSpecialValueOfHEField ENUMERATED {false (0), true (1)} DEFAULT false, -- applicable only for AM RLC mode of Rel-7 or later uM_SN_DeliveryMode ENUMERATED { nonConfigured(0), configured(1)} DEFAULT nonConfigured -- applicable for UM RLC mode of Rel-7 or later }</pre>	

ASN.1 Type Definition	
Type Name	CmacPagingConfigReq
Comment	
Type Definition	
<pre>SEQUENCE { pI_BitmapInfo CHOICE { two_PICH_frame two_PICH_pI_BitmapInfo, four_PICH_frame four_PICH_pI_BitmapInfo }, drX_CycleLength INTEGER (3..9), iMSI IMSI_GSM_MAP, t_pich_T_sccpch BOOLEAN -- T_pich > T_sccpch then FALSE }</pre>	

ASN.1 Type Definition	
Type Name	CommonE_DCHMACdFlows
Comment	Rel-7 or later
Type Definition	
<pre>SEQUENCE { harq_Info ENUMERATED {rv0 (0), rvtable (1)}, addReconfMAC_d_FlowList Common_E_DCH_MAC_d_FlowsList }</pre>	

ASN.1 Type Definition	
Type Name	PRACH_MeasurementReport
Comment	sfn is included if reportSFN is TRUE in CPHY_PRACH_Measurement_REQ.
Type Definition	
<pre>SEQUENCE { sync_UL_Code BIT STRING (SIZE (8)), sfn INTEGER (0..4095) OPTIONAL -- Rel-8 or later }</pre>	

ASN.1 Type Definition	
Type Name	SecondaryFrequencyInfo
Comment	
Type Definition	
<pre>SEQUENCE { frequencyInfo UARFCN, dLTxAttenuationLevel INTEGER (0..30) }</pre>	

ASN.1 Type Definition	
Type Name	SecondaryFrequencyInfoList
Comment	
Type Definition	
<pre>SEQUENCE (SIZE (1..maxNumOfSecondFrequency)) OF SecondaryFrequencyInfo</pre>	

ASN.1 Type Definition	
Type Name	RL_Information
Comment	<p>The range for powerOffsetOfTPC_PO2 and powerOffsetOfTFCI_PO1 and powerOffsetOfPILOT_PO3 is 0 dB to 6 dB, 0,25 dB per step.</p> <p>The IE cfnTgtSfnFrameOffset is applied when adding another RL or moving the UE to another cell in DCH state in the timing-maintained hard handover or in the soft handover. The cfnTgtSfnFrameOffset is defined as being the time difference between the CFN and the SFN of the cell in which the RL is to be added.</p> <p>The use of cfnTgtSfnFrameOffset and DOFF (Default DPCH Offset Value) is mutually exclusive. The IE cfnTgtSfnFrameOffset is omitted when configuring the 1st RL, or configuring the RL in the timing re-initialized hard handover where the required synchronization information is provided in defaultDPCH_offsetValue in DL_CommonInformation.</p> <p>In addition, TmTgt value is provided to dpch_FrameOffset in DL_DPCH_InfoPerRL_r5 or DL_DPCH_InfoPerRL_r6 as CFNchipOffset_Tgt. TmTgt can be observed by the UE, or calculated by the TTCN. If it is calculated,</p> $TmTgt = (DOFF * 512 + 38400 + TCell_Ref - TCell_Tgt) \text{ Mod } 38400.$ <p>dL_TimeslotISCPInfoLCR present in TDD configuration.</p>
Type Definition	
<pre>SEQUENCE { powerOffsetOfTFCI_PO1 INTEGER (0..24), powerOffsetOfTPC_PO2 INTEGER (0..24), powerOffsetOfPILOT_PO3 INTEGER (0..24), dl_TxPower DL_TxPower, dl_TxPowerMax DL_TxPower, dl_TxPowerMin DL_TxPower, cfnTgtSfnFrameOffset CfnTgtSfnFrameOffset OPTIONAL, dL_TimeslotISCPInfoLCR TimeslotListWithISCP OPTIONAL }</pre>	

7.3.3 TTCN primitives

7.3.3.1 UTRAN TTCN primitives

The tables below show the primitives that are used for RLC, BMC, RB and PDCP tests, these primitives are defined in TTCN tabular form.

ASP Name	RLC_TR_TestDataReq	
PCO Type	DSAP	
Comments	To request the transmission of unstructured data using transparent mode in the downlink direction. TTCN writer is requires to send data according to the transport block size allowed.	
Parameter Name	Parameter Type	Comments
cellId	INTEGER	
rB_Id	SS_RB_Identity	RB identity (RB3 or RB4)
data	PDU	
Detailed Comments		

ASP Name	RLC_TR_TestDataInd	
PCO Type	DSAP	
Comments	To indicate the reception of unstructured data using transparent mode in the uplink direction	
Parameter Name	Parameter Type	Comments
cellId	INTEGER	
rB_Id	SS_RB_Identity	RB identity (RB3 or RB4)
data	PDU	
Detailed Comments		

ASP Name	RLC_UM_TestDataReq	
PCO Type	DSAP	
Comments	To request the transmission of unstructured data using unacknowledged mode in the downlink direction	
Parameter Name	Parameter Type	Comments
cellId	INTEGER	
rB_Id	SS_RB_Identity	RB identity (RB3 or RB4)
data	PDU	
Detailed Comments		

ASP Name	RLC_UM_TestDataInd	
PCO Type	DSAP	
Comments	To indicate the reception of unstructured data using unacknowledged mode in the uplink direction	
Parameter Name	Parameter Type	Comments
cellId	INTEGER	
rB_Id	SS_RB_Identity	RB identity (RB3 or RB4)
data	PDU	
Detailed Comments		

ASP Name	RLC_UM_ScheduledDataReq	
PCO Type	DSAP	
Comments	The ASP is used to request the transmission of unstructured data using unacknowledged mode in the downlink direction. The CFN/Subframe indicates the CFN and sub-frame values on which the Data is transmitted.	
Parameter Name	Parameter Type	Comments
cellId	INTEGER	
rB_Id	SS_RB_Identity	RB identity (RB3 or RB4)
cFN	ActivationTime	
subframe	Subframe_Type	
data	PDU	
Detailed Comments		

ASP Name	RLC_UM_ScheduledDataInd	
PCO Type	DSAP	
Comments	The ASP is used to indicate the reception of unstructured data using unacknowledged mode in the uplink direction. The CFN/Subframe indicates the CFN and sub-frame values on which the Data is received. If an SDU is segmented into multiple PDUs, the CFN/Subframe of the last PDU is to be reported.	
Parameter Name	Parameter Type	Comments
cellId	INTEGER	
rB_Id	SS_RB_Identity	RB identity (RB3 or RB4)
cFN	ActivationTime	
subframe	Subframe_Type	
data	PDU	
Detailed Comments		

ASP Name	RLC_AM_TestDataReq	
PCO Type	DSAP	
Comments	To request the transmission of unstructured data using acknowledged mode in the downlink direction	
Parameter Name	Parameter Type	Comments
cellId	INTEGER	
rB_Id	SS_RB_Identity	RB identity (RB3 or RB4)
data	PDU	
Detailed Comments		

ASP Name	RLC_AM_TestDataInd	
PCO Type	DSAP	
Comments	To indicate the reception of unstructured data using acknowledged mode in the uplink direction	
Parameter Name	Parameter Type	Comments
cellId	INTEGER	
rB_Id	SS_RB_Identity	RB identity (RB3 or RB4)
data	PDU	
Detailed Comments		

ASP Name	BMC_DataReq	
PCO Type	BSAP	
Comments	The ASP is used to request the transmission of unstructured BMC data or scheduling message, using unacknowledged mode and the BMC PCO in the downlink direction.	
Parameter Name	Parameter Type	Comments
cellId	INTEGER	
routingInfo	RoutingInfo	
data	PDU	
Detailed Comments		

ASP Name	BMC_DataCnf	
PCO Type	BSAP	
Comments	The ASP is used to confirm the previous reception of BMC_DataReq	
Parameter Name	Parameter Type	Comments
cellId	INTEGER	
routingInfo	RoutingInfo	
Detailed Comments		

ASP Name	RLC_HandoverReq	
PCO Type	DSAP	
Comments	<p>The ASP is used to request the transmission of the HandoverFromUTRANCommand_GSM message using acknowledged operation (AM). The Meta PDU in turn consists of 2 components.</p> <ol style="list-style-type: none"> 1) The ASN.1 PER encoded HandoverFromUTRANCommand, without any 1 bit to 7 bits of padding. 2) The GSM Handover command. <p>The SS shall take care of inserting the MAC and RLC sequence number of Integrity check info, as in the case of other RRC DL PDU's</p>	
Parameter Name	Parameter Type	Comments
cellId	INTEGER	
rB_Id	SS_RB_Identity	RB Identity
msg	PDU	HandoverFromUTRANCommandGSM message
Detailed Comments	This ASP is sent to RRC integrity emulation for generation of the correct IntegrityCheckInfo value.	

ASP Name	DEC_BitstringToStructure_REQ	
PCO Type	ExternalStructureCodec	
Comments	<p>To request the decoding of the BITSTRING received from UE in receivedBITSTRING with the structure type specified in containingType:</p> <ol style="list-style-type: none"> 0: classmark2 1: classmark3 2: mSRadioAccessCapability 3: geranlu 	
Parameter Name	Parameter Type	Comments
receivedBITSTRING	BITSTRING	
containingStructureType	INTEGER	0: classmark2 1: classmark3 2: mSRadioAccessCapability 3: geranlu
Detailed Comments		

ASP Name	DEC_BitstringToStructure_CNF	
PCO Type	ExternalStructureCodec	
Comments		
Parameter Name	Parameter Type	Comments
classmark2	MS_Clsmk2	
classmark3	MSCLSMK3	
msRadioAccessCap	MS_RadioAccessCapList	
gGERANlu_RadioAccessCap	GERANlu_RadioAccessCap	
Detailed Comments		

The TTCN tabular format applies to the primitive definitions.

7.3.4 GERAN PCO and ASP definitions

7.3.4.1 PCO Type definitions

7.3.4.1.1 PCO type for data transmission and reception in GERAN

Table 7.3.4.1.1: Declaration of the G_DSAP PCO Type

PCO Type Definition	
PCO Type	G_DSAP
Role	LT
Comment	DATA transmission and reception

7.3.4.1.2 PCO type for configuration and control in GERAN

Table 7.3.4.1.2: Declaration of the G_CSAP PCO Type

PCO Type Definition	
PCO Type	G_CSAP
Role	LT
Comment	Transmission and reception of control primitives

7.3.4.2 PCO definitions

7.3.4.2.1 PCOs for data transmission and reception in GERAN

7.3.4.2.1.1 PCO for data transmission and reception through GERAN L2

Table 7.3.4.2.1.1: Declaration of G_L2 PCO

PCO Type Definition	
PCO Name	G_L2
PCO Type	G_DSAP
Role	LT
Comment	Control and observation point of GERAN L3 messages and user data

7.3.4.2.1.2 PCO for data transmission and reception through GPRS RLC

Table 7.3.4.2.1.2: Declaration of G_RLC PCO

PCO Type Definition	
PCO Name	G_RLC
PCO Type	G_DSAP
Role	LT
Comment	Control and observation point of GPRS GRR signalling messages

7.3.4.2.1.3 PCO for data transmission and reception through GPRS LLC

Table 7.3.4.2.1.3: Declaration of LLC PCO

PCO Type Definition	
PCO Name	G_LLC
PCO Type	G_DSAP
Role	LT
Comment	Control and observation point of GPRS GMM signalling messages

7.3.4.2.1.4 Void

7.3.4.2.2 PCOs for control primitives transmission and reception in GERAN

7.3.4.2.2.1 PCO for GERAN L1 control primitives transmission and reception

Table 7.3.4.2.2.1: Declaration of G_CL1 PCO

PCO Type Definition	
PCO Name	G_CL1
PCO Type	G_CSAP
Role	LT
Comment	Control GERAN Physical Layer (L1)

7.3.4.2.2.2 PCO for GERAN L2 control primitives transmission and reception

Table 7.3.4.2.2.2: Declaration of G_CL2 PCO

PCO Type Definition	
PCO Name	G_CL2
PCO Type	G_CSAP
Role	LT
Comment	Control GERAN L2

7.3.4.2.2.3 PCO for GPRS RLC control primitives transmission and reception

Table 7.3.4.2.2.3: Declaration of G_CRLC PCO

PCO Type Definition	
PCO Name	G_CRLC
PCO Type	G_CSAP
Role	LT
Comment	Control GPRS RLC/MAC layer

7.3.4.2.2.4 PCO for GPRS LLC control primitives transmission and reception

Table 7.3.4.2.2.4: Declaration of G_CLLC PCO

PCO Type Definition	
PCO Name	G_CLLC
PCO Type	G_CSAP
Role	LT
Comment	Control GPRS LLC layer

7.3.4.2.2.5 Void

7.3.4.3 GERAN ASP Definitions

7.3.4.3.1 ASPs for data transmission and reception in GERAN

7.3.4.3.1.1 ASPs for data transmission and reception through GERAN L2

ASP Name	G_L2_DATA_REQ	
PCO Type	G_DSAP	
Comments	The ASP is used to send L3 signalling message on the signalling channels or user data on the traffic channels to the UE/MS in acknowledged mode.	
Parameter Name	Parameter Type	Comments
cellId	CellId	
sAPI	SAPI	0 or 3
physicalChId	PhysicalChId	Channel identifier
g_LogicChType	G_LogicChType	
subChannel	SubChannelNumber	Valid only for logical channel types: TCH/H, FACCH/H, SACCH/TH, SDCCH/8, SACCH/C8, SDCCH/4, and SACCH/C4. For TCH/H, FACCH/H and SACCH/TH value is (0..1); For SDCCH/8 and SACCH/C8 value is (0..7); for SDCCH/4 and SACCH/C4 value is (0..3). This field is not applicable and the SS shall ignore it if this field is coded as 15.
rfn	RFN	The reduced frame number of the first frame on which this message is sent. This field is not applicable and the SS shall ignore it if the field t2 of rfn is coded as '11111'B.
msg	PDU	Signalling message or user data to be sent
Detailed Comments	Parameter rfn is only used in the test cases that require L3 message to be sent on specified frame number.	

ASP Name	G_L2_DATA_IND	
PCO Type	G_DSAP	
Comments	The ASP is used to receive a L3 signalling message on the signalling channels or user data on the traffic channels from the UE/MS in acknowledged mode.	
Parameter Name	Parameter Type	Comments
cellId	CellId	
sAPI	SAPI	0 or 3
physicalChId	PhysicalChId	Channel identifier
g_LogicChType	G_LogicChType	
subChannel	SubChannelNumber	Valid only for logical channel types: TCH/H, FACCH/H, SACCH/TH, SDCCH/8, SACCH/C8, SDCCH/4, and SACCH/C4. For TCH/H, FACCH/H and SACCH/TH value is (0..1); For SDCCH/8 and SACCH/C8 value is (0..7); for SDCCH/4 and SACCH/C4 value is (0..3). This field is not applicable and the SS shall ignore it if this field is coded as 15.
rfn	RFN	The reduced frame number of the first frame carrying the message
msg	PDU	Signalling message or user data received
Detailed Comments		

ASP Name	G_L2_L2Estab_IND	
PCO Type	G_DSAP	
Comments	The ASP is used to receive an indication of that L2 multiple frame operation on the specified channel has been established.	
Parameter Name	Parameter Type	Comments
cellId	CellId	
physicalChId	PhysicalChId	Channel identifier
g_LogicChType	G_LogicChType	
subChannel	SubChannelNumber	Valid only for logical channel types: FACCH/H, SDCCH/8 and SDCCH/4, This field shall be coded as 15 if it is not applicable.
sAPI	SAPI	0,3
establish_mode	OCTETSTRING[1]	
rfrn	RFN	The reduced frame number of the first frame carries the L2 SABM frame
msg	PDU	this field is present only when the establish mode is CoRes (collision resolution)
Detailed Comments	see 3GPP TS 44.006 [42], clauses 7.1.1 and 7.1.3	

ASP Name	G_L2_UNITDATA_REQ	
PCO Type	G_DSAP	
Comments	The ASP is used to send L3 signalling message on the signalling channels or send user data on the traffic channels to the UE/MS in unacknowledged mode.	
Parameter Name	Parameter Type	Comments
cellId	CellId	
sAPI	SAPI	0 or 3
physicalChId	PhysicalChId	Channel identifier
g_LogicChType	G_LogicChType	
subChannel	SubChannelNumber	Valid only for logical channel types: TCH/H, FACCH/H, SACCH/TH, SDCCH/8, SACCH/C8, SDCCH/4, and SACCH/C4. For TCH/H, FACCH/H and SACCH/TH value is (0..1); For SDCCH/8 and SACCH/C8 value is (0..7); for SDCCH/4 and SACCH/C4 value is (0..3). This field is not applicable and the SS shall ignore it if this field is coded as 15.
rfrn	RFN	The reduced frame number of the first frame on which this message is sent. This field is not applicable and the SS shall ignore it if the field t2 of rfrn is coded as '11111'B.
msg	PDU	Signalling message or user data to be sent
Detailed Comments	Parameter fn is only used in the test cases that require specific L3 message to be sent on specified frame number.	

ASP Name	G_L2_UNITDATA_IND	
PCO Type	G_DSAP	
Comments	The ASP is used to receive a L3 signalling message on the signalling channels or user data on the traffic channels from the UE/MS in unacknowledged mode.	
Parameter Name	Parameter Type	Comments
cellId	CellId	
sAPI	SAPI	0 or 3
physicalChId	PhysicalChId	Channel identifier
g_LogicChType	G_LogicChType	
subChannel	SubChannelNumber	Valid only for logical channel types: TCH/H, FACCH/H, SACCH/TH, SDCCH/8, SACCH/C8, SDCCH/4, and SACCH/C4. For TCH/H, FACCH/H and SACCH/TH value is (0..1); For SDCCH/8 and SACCH/C8 value is (0..7); for SDCCH/4 and SACCH/C4 value is (0..3). This field is not applicable and the SS shall ignore it if this field is coded as 15.
rfrn	RFN	The reduced frame number of the first frame carrying the message
msg	PDU	Signalling message or user data received
Detailed Comments		

ASP Name	G_L2_ACCESS_IND	
PCO Type	G_DSAP	
Comments	The ASP is used to receive a random access or handover access burst on the specified channel.	
Parameter Name	Parameter Type	Comments
cellId	CellId	
physicalChId	PhysicalChId	Channel identifier
g_LogicChType	G_LogicChType	RACH, FACCH, SDCCH/8, SDCCH/4. RACH is used for random access burst; others are used for handover access burst
subChannel	SubChannelNumber	Valid only for logical channel types: FACCH/H, SDCCH/8, SDCCH/4. This field is not applicable and the SS shall ignore it if this field is coded as 15.
rfrn	RFN	The reduced frame number of the first frame carrying the burst
burst	PDU	Random access burst or handover access burst
Detailed Comments		

ASP Name	G_L2_Paging_REQ	
PCO Type	G_DSAP	
Comments	The ASP is used to send a paging message on the specified paging group of the specified paging channel to the UE/MS, when the UE/MS is in idle mode or the UE/MS not supporting SPLIT_PG_CYCLE on CCCH is in GPRS attached mode.	
Parameter Name	Parameter Type	Comments
cellId	CellId	
sAPI	SAPI	0
physicalChId	PhysicalChId	Channel identifier of the right CCCH_GROUP
g_LogicChType	G_LogicChType	PCH
pagingGroup	PAGING_GROUP	
pagingMode	PagingMode	0-normal paging; 1-extended paging; 2-paging reorganization.
msg	PDU	Paging message
Detailed Comments	<p>The SS is required to send valid layer 3 messages continuously on all paging subchannels on CCCH where paging can appear.</p> <p>For "normal paging" the SS send the paging message in the specified pagingGroup;</p> <p>For "extended paging" " the SS send the paging message in the specified pagingGroup and in the "next but one" position on the PCH, following the block corresponding to pagingGroup;</p> <p>For "paging reorganization" the SS send the paging message in all paging subchannels.</p> <p>The required 51-multiframe occurs when:</p> $\text{pagingGroup div (N div BS_PA_MFRMS)} = (\text{FN div 51}) \bmod (\text{BS_PA_MFRMS})$ <p>The index to the required paging block in the 51-multiframe determined above:</p> $\text{Paging block index} = \text{pagingGroup} \bmod (\text{N div BS_PA_MFRMS})$ <p>N = (9-BS_AG_BLKES_RES) * BS_PA_MFRMS CCCH not combined or N = (3-BS_AG_BLKES_RES) * BS_PA_MFRMS CCCH + SDCCH combined</p>	

ASP Name	G_L2_PagingGPRS_REQ	
PCO Type	G_DSAP	
Comments	The ASP is used to send a paging message on the specified paging group of the specified paging channel to the UE/MS, when the UE/MS supporting SPLIT_PG_CYCLE on CCCH is in GPRS attached mode.	
Parameter Name	Parameter Type	Comments
cellId	CellId	
sAPI	SAPI	0
physicalChId	PhysicalChId	Channel identifier of the right CCCH_GROUP
g_LogicChType	G_LogicChType	PCH
pagingGroup	PAGING_GROUP	
pagingMode	PagingMode	0-normal paging; 1-extended paging; 2-paging reorganization.
splitPGcycleCode	INTEGER	0 -- No Split Paging, 1..32 -- Split Paging
msg	PDU	Paging message
Detailed Comments	<p>The SS is required to send valid layer 3 messages continuously on all paging subchannels on CCCH where paging can appear.</p> <p>For "normal paging" the SS send the paging message in the specified pagingGroup;</p> <p>For "extended paging" " the SS send the paging message in the specified pagingGroup and in the "next but one" position on the PCH, following the block corresponding to pagingGroup;</p> <p>For "paging reorganization" the SS send the paging message in all paging subchannels.</p> <p>The required 51-multiframe occurs when:</p> $\text{pagingGroup div (M div 64)} = (\text{FN div 51}) \bmod 64$ <p>The index to the required paging block in the 51-multiframe determined above:</p> $\text{Paging block index} = \text{pagingGroup} \bmod (\text{M div 64})$ <p>M = (9-BS_AG_BLKES_RES) x 64 CCCH not combined or M = (3-BS_AG_BLKES_RES) x 64 CCCH + SDCCH combined</p>	
NOTE:	This ASP may not be implemented if the MS/UE does not support SPLIT_PG_CYCLE on CCCH.	

Type Name	CellId
Type Definition	INTEGER
Type Encoding	
Comments	

Type Name	SAPI
Type Definition	INTEGER
Type Encoding	
Comments	Service access point identifier for GERAN L2 and LLC

Type Name	PhysicalChId
Type Definition	INTEGER(0..31)
Type Encoding	
Comments	Physical channel identifier in GERAN

Type Name	G_LogicChType
Type Definition	INTEGER
Type Encoding	
Comments	GERAN logical channel type: 0-BCCH; 1-RACH; 2-PCH; 3-AGCH; 4-SDCCH/4; 5-SACCH/C4; 6-SDCCH/8; 7-SACCH/C8; 8-TCH/F; 9-FACCH/F; 10-SACCH/TF; 11-TCH/H; 12-FACCH/H; 13-SACCH/TH; 14-Void; 15-PRACH; 16-PPCH; 17-PAGCH; 18-PDTCH/F; 19-PACCH/F; 20-PTCCH/F; 21-E-TCH/F; 22-E-IACCH/F; 23-E-FACCH/F; 24-SACCH/M; 25-SACCH/MD

Type Name	SubChannelNumber
Type Definition	INTEGER
Type Encoding	
Comments	Subchannel number for TCH/H, FACCH/H, SACCH/TH, SDCCH/4, SDCCH/C4, SDCCH/8 and SDCCH/C8. For TCH/H, FACCH/H and SACCH/TH value is (0..1); For SDCCH/8 and SACCH/C8 value is (0..7); For SDCCH/4 and SACCH/C4 value is (0..3).

Type Name	PAGING_GROUP
Type Definition	INTEGER
Type Encoding	
Comments	3GPP TS 05.02 or 3GPP TS 45.002 [31], clauses 6.5.2 and 6.5.6

Type Name	PagingMode
Type Definition	INTEGER
Type Encoding	
Comments	0 - normal paging; 1 - extended paging; 2 - paging reorganization.

Type Name	RFN		
Encoding Variation			
Comments	The reduced frame number, its range is 0 -- 42431 (FN modulo 42432) about 195.8 s		
Element Name	Type Definition	Field Encoding	Comments
t1_	BITSTRING[5]		(FN div 1326) mod 32
t3	BITSTRING[6]		FN mod 51
t2	BITSTRING[5]		FN mod 26
Detailed Comments	see 3GPP TS 04.18 or 3GPP TS 44.018 [43], clause 10.5.2.38. The reduced frame number, FN modulo 42432 can be calculated in the following formula: $51 \times ((t3 - t2) \bmod 26) + t3 + 1326 \times t1_$ RFN is used for starting time and TBF starting time.		

ASP Name	G_L2_Release_CNF		
PCO Type	G_DSAP		
Comments	This ASP from L2, indicates that the multiple frame operation release was successful. This means that the UA message was received in response to L2 DISC command.		
Parameter Name	Parameter Type	Comments	
cellId	CellId		
sAPI	SAPI	0 or 3	
physicalChId	PhysicalChId	Channel identifier	
g_LogicChType	G_LogicChType		
subChannel	SubChannelNumber	For SDCCH/8 and SACCH/C8 value is (0..7); for SDCCH/4 and SACCH/C4 value is (0..3). This field is not applicable and the SS shall ignore it if this field is coded as 15.	
releaseMode	BITSTRING[1]	0 = normal release; 1 = local release.	
Detailed Comments			

ASP Name	G_L2_Release_REQ		
PCO Type	G_DSAP		
Comments	This ASP requests L2 to send Layer 2 DISC command on the indicated SAPI.		
Parameter Name	Parameter Type	Comments	
cellId	CellId		
sAPI	SAPI	0 or 3	
physicalChId	PhysicalChId	Channel identifier	
g_LogicChType	G_LogicChType		
subChannel	SubChannelNumber	For SDCCH/8 and SACCH/C8 value is (0..7); for SDCCH/4 and SACCH/C4 value is (0..3). This field is not applicable and the SS shall ignore it if this field is coded as 15.	
releaseMode	BITSTRING[1]	0 = normal release; 1 = local release.	
Detailed Comments			

ASP Name	G_L2_Release_IND	
PCO Type	G_DSAP	
Comments	The ASP is used to receive an indication of the termination of an established multiple frame operation or an indication of an unsuccessful establishment attempt.	
Parameter Name	Parameter Type	Comments
cellId	CellId	
sAPI	SAPI	0
physicalChId	PhysicalChId	Channel identifier
g_LogicChType	G_LogicChType	
subChannel	SubChannelNumber	Valid only for logical channel types: TCH/H, FACCH/H, SACCH/TH, SDCCH/8, SACCH/C8, SDCCH/4, and SACCH/C4. For TCH/H, FACCH/H and SACCH/TH value is (0..1); for SDCCH/8 and SACCH/C8 value is (0..7); for SDCCH/4 and SACCH/C4 value is (0..3).
releaseMode	BITSTRING[1]	0 = normal release; 1 = local end release
outstanding_Indicator	BOOLEAN	whether or not there are outstanding acknowledgements or unsolved G_L2_DATA_REQ primitives.
Detailed Comments		

ASP Name	G_L2_SYSINFO_REQ	
PCO Type	G_DSAP	
Comments	The ASP is used to send system information messages to the lower layer emulator.	
Parameter Name	Parameter Type	Comments
cellId	CellId	
sAPI	SAPI	0
physicalChId	PhysicalChId	
g_LogicChType	G_LogicChType	BCCH or SACCH
instanceIndex	INTEGER	To indicate the instance of the system information messages. For SYSTEM INFORMATION Type 2ter, 18, 19, 20 the value is (0..7); for type 14, 15 the value is (0..3); for type 2quater the value is (0..15); for all other type the value is 0.
sysInfoType	SysInfoType	SYSTEM INFORMATION Type 5, 5bis, 5ter, and 6 are sent on SACCH, the other SYSTEM INFORMATION 's are sent on BCCH.
BCCHExt	B1	'0' indicates message sent on BCCH Norm, '1' indicates message sent on BCCH Ext. Only valid for SI 2quater, 7, 8, 13, 15, 16, 17. Default value '0'
msg	PDU	This field contains SYSTEM INFORMATION message. See 3GPP TS 44.018 [43], clause 9.1.31 to clause 9.1.43h for SYSTEM INFORMATION message definitions.
Detailed Comments	The lower layer emulator shall store the SYSTEM INFORMATION's, and transmit them periodically according to the rules specified in clause 6.3.1.3 of 3GPP TS 05.02 or 3GPP TS 45.002 [31]. The msg shall override the same type system information message previous stored in the lower layer emulator.	

Type Name	SysInfoType
Type Definition	INTEGER
Type Encoding	
Comments	25--SYSTEM INFORMATION TYPE 1 26--SYSTEM INFORMATION TYPE 2 2 -- SYSTEM INFORMATION TYPE 2bis 3 -- SYSTEM INFORMATION TYPE 2ter 7 -- SYSTEM INFORMATION TYPE 2quater 27--SYSTEM INFORMATION TYPE 3 28--SYSTEM INFORMATION TYPE 4 29--SYSTEM INFORMATION TYPE 5 5 -- SYSTEM INFORMATION TYPE 5bis 6 -- SYSTEM INFORMATION TYPE 5ter 30--SYSTEM INFORMATION TYPE 6 31--SYSTEM INFORMATION TYPE 7 24--SYSTEM INFORMATION TYPE 8 4 -- SYSTEM INFORMATION TYPE 9 0 -- SYSTEM INFORMATION TYPE 13 61--SYSTEM INFORMATION TYPE 16 62--SYSTEM INFORMATION TYPE 17 64--SYSTEM INFORMATION TYPE 18 65--SYSTEM INFORMATION TYPE 19 66--SYSTEM INFORMATION TYPE 20 67—SYSTEM INFORMATION TYPE 15

7.3.4.3.1.2 ASPs for data transmission and reception through GERAN RLC

ASP Name	G_RLC_ControlMsg_REQ	
PCO Type	G_DSAP	
Comments	The ASP is used to transmit a RLC/MAC control message to the UE/MS on the specified channel.	
Parameter Name	Parameter Type	Comments
cellId	CellId	
physicalChId	PhysicalChId	
g_LogicChType	G_LogicChType	PACCH
tBF_Direction	INTEGER	1-downlink TBF; 0-uplink TBF
tFI	TFI	Temporary flow identity
rRBP	RRBP	Relative reserved block period
s_P_Bit	S_P_Bit	Supplementary/polling bit
rfn	RFN	The reduced frame number of the first frame on which this message is sent. This field is not applicable and the SS shall ignore it if the field t2 of rfn is coded as '11111'B.
pagingGroup	PAGING_GROUP	this field shall be omitted
pagingMode	PagingMode	this field shall be omitted
msg	PDU	Down link RLC/MAC control message
Detailed Comments	This ASP provides values for "RRBP" and "S/P" fields in MAC header for TTCN controlling the response from the UE, the value for "PayloadType" and "USF" fields in MAC header shall be filled by the SS. If a RLC/MAC control message can not be fitted into one RLC/MAC control block, the SS RLC/MAC entity shall take the responsibility of segmentation of the message, and set the correct "PayloadType" and optional octet1 (and optional octet2).	

Type Name	RRBP
Type Definition	BITSTRING[2]
Type Encoding	
Comments	3GPP TS 04.60 or 3GPP TS 44.060 [32], clause 10.4.5

Type Name	S_P_Bit
Type Definition	BITSTRING[1]
Type Encoding	
Comments	0 - RRBp field is not valid; 1 - RRBp field is valid.

ASP Name	G_RLC_ControlMsg_IND	
PCO Type	G_DSAP	
Comments	The ASP is used to receive an uplink RLC/MAC control block sent by the UE/MS on the specified channel.	
Parameter Name	Parameter Type	Comments
cellId	CellId	
physicalChId	PhysicalChId	
g_LogicChType	G_LogicChType	PACCH or PDTCH
tBF_Direction	INTEGER	1 - downlink TBF; 0 - uplink TBF
tFI	TFI	Temporary flow identity
rFn	RFN	The reduced frame number of the frame carrying the message
msg	PDU	Uplink RLC/MAC control message
Detailed Comments	Logical channel type PDTCH is valid for PACKET ENHANCED MEASUREMENT REPORT message only.	

7.3.4.3.1.3 ASPs for data transmission and reception through GERAN LLC

ASP Name	G_LLC_UNITDATA_REQ	
PCO Type	G_DSAP	
Comments	The ASP is used to send L3 PDU to the UE/MS in LLC unconfirmed transmission.	
Parameter Name	Parameter Type	Comments
ILMEId	LLMEId	
tLLI	TLLI	
sAPI	SAPI	
protectMode	BITSTRING[1]	0 -- unprotected; 1 -- protected
cipherMode	BITSTRING[1]	0 -sent without encryption; 1 -sent with encryption
msg	PDU	L3 PDU
Detailed Comments	3GPP TS 04.64 or 3GPP TS 44.064 [33], clause 8.4.1 After the ciphering function is started in the SS by G_CLLC_Assign_REQ, the SS shall encrypt the "msg" when cipherMode = '1', and the SS shall not encrypt the "msg" if cipherMode = '0'.	

Type Name	LLMEId
Type Definition	INTEGER
Type Encoding	
Comments	The identifier of the Logical Link Management Entity in SGSN

ASP Name	G_LLC_UNITDATA_IND	
PCO Type	G_DSAP	
Comments	The ASP is used to receive a L3 PDU from the UE/MS in LLC unconfirmed transmission.	
Parameter Name	Parameter Type	Comments
ILMEId	LLMEId	
tLLI	TLLI	
sAPI	SAPI	
msg	PDU	L3 PDU
Detailed Comments	3GPP TS 04.64 or 3GPP TS 44.064 [33], clause 8.4.2	

ASP Name	G_LL_C_XID_RES	
PCO Type	G_DSAP	
Comments	The ASP is used to send to the UE/MS the negotiated XID parameters agreed by the SS.	
	Parameter Name	Parameter Type
ILMEId	LLMEId	
tLLI	TLLI	
sAPI	SAPI	
xID_Info	XID_Info	the negotiated XID parameters agreed by the SS
Detailed Comments		

Type Name	XID_Info
Type Definition	OCTETSTRING
Type Encoding	
Comments	Exchange Identification Information

ASP Name	G_LL_C_XID_IND	
PCO Type	G_DSAP	
Comments	The ASP is used to receive the XID requested by the UE/MS.	
	Parameter Name	Parameter Type
ILMEId	LLMEId	
tLLI	TLLI	
sAPI	SAPI	
xID_Info	XID_Info	the XID parameters requested by the UE/MS
Detailed Comments		

ASP Name	G_LL_C_NULL	
PCO Type	G_DSAP	
Comments	Please refer to TS 36.523-3 [62], clause 6.4.2 for the definition. This ASP is not used in ATs in TTCN2.	

7.3.4.3.1.4 Void

7.3.4.3.1.5 ASPs for data transmission and reception through GERAN DTM

ASP Name	G_L2_GTP_REQ	
PCO Type	G_DSAP	
Comments	The ASP is used for DTM to send an LLC signalling message on the DCCH in acknowledged mode.	
Parameter Name	Parameter Type	Comments
cellId	CellId	
SAPI	SAPI	
physicalChId	PhysicalChId	Channel identifier
g_LogicChType	G_LogicChType	
subChannel	SubChannelNumber	Valid only for logical channel types: TCH/H, FACCH/H, SACCH/TH, SDCCH/8, SACCH/C8, SDCCH/4, and SACCH/C4. For TCH/H, FACCH/H and SACCH/TH value is (0..1); For SDCCH/8 and SACCH/C8 value is (0..7); for SDCCH/4 and SACCH/C4 value is (0..3). This field is not applicable and the SS shall ignore it if this field is coded as 15.
protectMode	BITSTRING[1]	0 -- unprotected; 1 -- protected
cipherMode	BITSTRING[1]	0 - sent without encryption; 1 - sent with encryption
skipIndicator	B4	GTP header, unciphered
GTPProtocolDiscriminator	B4	GTP header, unciphered
msgType	B8	GTP header, unciphered
TLLI	TLLI	GTP header, unciphered
gmmSmPDUlength	Length	GTP header, unciphered
gmmSmPDU	PDU	GMM or SM PDU - ciphered
Detailed Comments	Ciphering must be started in the SS by G_CLLC_Assign_REQ, and also by either G_CL1_CipheringControl_REQ, G_CL1_CipherModeModify_REQ, or G_CL1_CreateBasicPhyCh_REQ. When cipherMode = '1' the SS shall encrypt the "LLCPDU", using the algorithm specified in px_GPRS_CipherAlg, and then encrypt the whole outgoing message using the algorithm specified in px_GSM_CipherAlg. The SS shall not encrypt the message at all if cipherMode = '0'.	

ASP Name	G_L2_GTP_IND	
PCO Type	G_DSAP	
Comments	The ASP is used for DTM to receive an LLC signalling message on DCCH acknowledged mode.	
Parameter Name	Parameter Type	Comments
cellId	CellId	
SAPI	SAPI	
physicalChId	PhysicalChId	Channel identifier
g_LogicChType	G_LogicChType	
subChannel	SubChannelNumber	Valid only for logical channel types: TCH/H, FACCH/H, SACCH/TH, SDCCH/8, SACCH/C8, SDCCH/4, and SACCH/C4. For TCH/H, FACCH/H and SACCH/TH value is (0..1); For SDCCH/8 and SACCH/C8 value is (0..7); for SDCCH/4 and SACCH/C4 value is (0..3). This field is not applicable and the SS shall ignore it if this field is coded as 15.
rfrn	RFN	The reduced frame number of the first frame carrying the message
TLLI	TLLI	
gmmSmPDU	PDU	Deciphered GMM or SM signalling message received
Detailed Comments	If ciphering is used, the SS will take care to ensure the "LLC PDU" is deciphered	

7.3.4.3.2 ASPs for control primitive transmission and reception in GERAN

7.3.4.3.2.1 ASPs for configuration and control of GERAN L1

ASP Name	G_CL1_CreateCell_REQ	
PCO Type	G_CSAP	
Comments	The ASP is used to create a cell in GERAN	
	Parameter Name	Parameter Type
	cellId	CellId
	baseId	BITSTRING[6] base transceiver station identity code = NCC+BCC. see 3GPP TS 23.003 [6]
	timingAdvance	BITSTRING[8] The SS sets the timing of uplink direction in advance of downlink direction timing by this value.
Detailed Comments		

ASP Name	G_CL1_CreateCell_CNF	
PCO Type	G_CSAP	
Comments	The ASP is used to get the confirmation of a G_CL1_CreateCell_REQ	
	Parameter Name	Parameter Type
	cellId	CellId
		The cell created
Detailed Comments		

ASP Name	G_CL1_DeleteCell_REQ	
PCO Type	G_CSAP	
Comments	The ASP is used to delete a cell in GERAN	
	Parameter Name	Parameter Type
	cellId	CellId
		The cell to be deleted
Detailed Comments		

ASP Name	G_CL1_DeleteCell_CNF	
PCO Type	G_CSAP	
Comments	The ASP is used to get the confirmation of a G_CL1_DeleteCell_REQ	
	Parameter Name	Parameter Type
	cellId	CellId
		The cell deleted
Detailed Comments		

ASP Name	G_CL1_CreateBasicPhyCh_REQ	
PCO Type	G_CSAP	
Comments	The ASP is used to create a basic physical channel in GERAN	
Parameter Name	Parameter Type	Comments
cellId	CellId	The cell which the channel to be created belongs to
physicalChId	PhysicalChId	identifier of the physical channel in the SS.
channelCombination	ChannelCombination	Logical channels combined onto the basic physical channel.
frqInfo	FrqInfo	Parameters for Description of the physical channel in frequency domain
timeSlot	TN	The timeslot number of the physical channel
tsc	TSC	Training sequence code. For common control and broadcast channels the value of tsc must be equal to BCC (base station colour code)
channelSpecificInfo	ChannelSpecificInfo	Specific parameters related to individual channel
txPower	TX_Power	The transmission power level in dB μ Vemf()
bandIndicator	BITSTRING[1]	Parameter for DCS or PCS frequency band selection. A value 0 for frqInfo.arfcn interpreted as DCS1800. A value 1 for frqInfo.arfcn interpreted as PCS1900. If omitted, the value in frqInfo.arfcn interpreted as DCS1800.
Detailed Comments	<p>The value of channelCombination permitted currently:</p> <ol style="list-style-type: none"> 1 TCH/F + FACCH/F + SACCH/TF 2 TCH/H(0,1) + FACCH/H(0,1) + SACCH/TH(0,1) 3 TCH/H(0,0) + FACCH/H(0,1) + SACCH/TH(0,1) + TCH/H(1,1) 4 FCCH + SCH + BCCH + CCCH 5 FCCH + SCH + BCCH + CCCH + SDCCH/4(0..3) + SACCH/C4(0..3) 6 BCCH + CCCH 7 SDCCH/8(0..7) + SACCH/C8(0.. 7) 8 TCH/F + FACCH/F + SACCH/M 9 TCH/F + SACCH/M 10 TCH/FD + SACCH/MD 11 Void 12 Void 13 PDTCH/F+PACCH/F+PTCCH/F 18 E-TCH/F + E-IACCH/F + E-FACCH/F + SACCH/TF 19 E-TCH/F + E-IACCH/F + E-FACCH/F + SACCH/M 20 E-TCH/F + E-IACCH/F + SACCH/M 21 E-TCH/FD + E-IACCH/F + SACCH/MD 	

ASP Name	G_CL1_CreateBasicPhyCh_CNF	
PCO Type	G_CSAP	
Comments	The ASP is used to get the confirmation of a G_CL1_CreateBasicPhyCh_REQ	
Parameter Name	Parameter Type	Comments
cellId	CellId	The cell which the created channel belongs to
physicalChId	PhysicalChId	The physical channel created.
Detailed Comments		

Type Name	FrqInfo		
Encoding Variation			
Comments	Parameters for Description of basic physical channel in frequency domain.		
Element Name	Type Definition	Field Encoding	Comments
h	BITSTRING[1]		h=1:hopping channel h=0: non-hopping channel
spr	BITSTRING [3]		'000'B
spr1	BITSTRING [2]		'00'B if h = 0, otherwise OMIT
maio	BITSTRING [6]		mobile allocation index offset if h = 1, otherwise OMIT
hsn	BITSTRING [6]		hopping sequence number if h = 1, otherwise OMIT
arfcn	BITSTRING [10]		absolute RF channel number if h = 0, otherwise OMIT
hoppingFreqList	FrequencyList		hopping frequency list if h = 1, otherwise OMIT. The definition see 3GPP TS 44.018 [43] or 3GPP TS 04.18, clause 10.5.2.13
Detailed Comments			

Type Name	ChannelSpecificInfo		
Encoding Variation			
Comments	Parameters for individual channel		
Element Name	Type Definition	Field Encoding	Comments
dedCH_Info	DedCH_Info		Parameters for dedicated channel. Valid for combination:1, 2, 3, 5, 7, 8, 9, 10
cCCH_Info	CCCH_Info		Parameters for common control channels: PCH, SCH, etc. Valid for combination: 4, 5, 6
Detailed Comments			

Type Name	DedCH_Info		
Encoding Variation			
Comments	Parameters for dedicated channel		
Element Name	Type Definition	Field Encoding	Comments
chMod	ChMode		Definition see 3GPP TS 04.18 or 3GPP TS 44.018 [43], clause 10.5.2.6
cipherMode	CipherModeSetting		Definition see 3GPP TS 04.18 or 3GPP TS 44.018 [43], clause 10.5.2.9
cipherKey	BITSTRING[64]		
powerLevel	BITSTRING[5]		Initial MS uplink transmission power level. This value is used in the L1 header of SACCH.
timingAdvance	BITSTRING[8]		Initial timing advance. This value is used in the L1 header of SACCH. This field shall be set to the same value as in timingAdvance of G_CL1_CreateCell_REQ.
Detailed Comments	In addition to ciphering algorithm the cipherMode specifies the initial ciphering mode of the physical channel in both transmission and receiving direction by startingCiph bit. During ciphering mode setting procedure the ciphering mode of receiving direction can be changed by G_CL1_CipheringControl_REQ.		

Type Name	CCCH_Info		
Encoding Variation			
Comments	Parameters for common control channels		
Element Name	Type Definition	Field Encoding	Comments
bS_PA_MFRMS	BITSTRING[3]		the number of 51-multiframes between transmissions of paging messages. Definition see 3GPP TS 04.18 or 3GPP TS 44.018 [43], clause 10.5.2.11
bS_AG_BLKES_RES	BITSTRING[3]		the number of blocks on each common control channel reserved for access grant messages. Definition see 3GPP TS 04.18 or 3GPP TS 44.018 [43], clause 10.5.2.11
Detailed Comments			

Type Name	MultiSlotAllocation		
Encoding Variation			
Comments	Used in multi-slot configuration		
Element Name	Type Definition	Field Encoding	Comments
tN0	BOOLEAN		TRUE - time slot 0 is allocated; FALSE -- not allocated
channelCombination0	ChannelCombination		Channel combination for time slot 0; not applicable if tN0 = FALSE
tN1	BOOLEAN		TRUE - time slot 1 is allocated; FALSE -- not allocated
channelCombination 1	ChannelCombination		Channel Combination for time slot 1; not applicable if tN1 = FALSE
tN2	BOOLEAN		TRUE - time slot 2 is allocated; FALSE -- not allocated
channelCombination 2	ChannelCombination		Channel Combination for time slot 2; not applicable if tN2 = FALSE
tN3	BOOLEAN		TRUE - time slot 3 is allocated; FALSE -- not allocated
channelCombination 3	ChannelCombination		Channel Combination for time slot 3; not applicable if tN3 = FALSE
tN4	BOOLEAN		TRUE - time slot 4 is allocated; FALSE -- not allocated
channelCombination 4	ChannelCombination		Channel Combination for time slot 4; not applicable if tN4 = FALSE
tN5	BOOLEAN		TRUE - time slot 5 is allocated; FALSE -- not allocated
channelCombination 5	ChannelCombination		Channel Combination for time slot 5; not applicable if tN5 = FALSE
tN6	BOOLEAN		TRUE - time slot 6 is allocated; FALSE -- not allocated
channelCombination 6	ChannelCombination		Channel Combination for time slot 6; not applicable if tN6 = FALSE
tN7	BOOLEAN		TRUE - time slot 7 is allocated; FALSE -- not allocated
channelCombination 7	ChannelCombination		Channel Combination for time slot 7; not applicable if tN7 = FALSE
Detailed Comments	Multislot configuration is referred to 3GPP TS 05.02 or 3GPP TS 45.002 [31], clause 6.4.2. The timeslot for which G_CL1_CreateBasicPhyCh_REQ has set the channel combination shall be set to FALSE.		

ASP Name	G_CL1_CipheringControl_REQ	
PCO Type	G_CSAP	
Comments	The ASP is used to set the ciphering mode of the physical channel in receiving direction, the kc and ciphering algorithm was set by the G_CL1_CreateBasicPhyCh_REQ for the physical channel before calling the ASP.	
Parameter Name	Parameter Type	Comments
cellId	CellId	
physicalChId	PhysicalChId	Channel identifier
rcvCipherMode	BITSTRING[1]	Ciphering Mode in SS receiving direction: 0→ not ciphered 1→ ciphered
Detailed Comments	For GSM dedicated physical channel, the ciphering mode of the SS shall be changed in three steps: (3GPP TS 44.018 [43], clause 3.4.7) Before the SS sending CIPHERING MODE COMMAND the SS is transmitting and receiving in old ciphering mode (for example, not ciphered), after the SS sending CIPHERING MODE COMMAND the SS changes its receiving ciphering mode to new ciphering mode (for example, ciphered) and keeps transmitting in old ciphering mode; then after receiving CIPHERING MODE COMPLETE or any correct L2 frame in new ciphering mode the SS changes the transmitting ciphering mode to the new mode. TTCN writer shall use this ASP before sending the CIPHERING MODE COMMAND to ensure the ciphering mode of the physical channel, in sufficient time, according to the 3 step procedure outlined above.	

ASP Name	G_CL1_CipheringControl_CNF	
PCO Type	G_CSAP	
Comments	The ASP is used to confirm that the G_CL1_CipheringControl_REQ is executed correctly.	
Parameter Name	Parameter Type	Comments
cellId	CellId	
physicalChId	PhysicalChId	Channel identifier
Detailed Comments		

ASP Name	G_CL1_ComingFN_REQ	
PCO Type	G_CSAP	
Comments	The ASP is used to request lower layer return the reduced frame number (FN modulo 42432) which is far enough in the future from current frame number and is able to carry L3 message on the specified channel. The requirement of "far enough" is that there is enough time left for TTCN to prepare a L3 message to send before that frame. The ASP could also be used in the calculation of a value for starting time	
Parameter Name	Parameter Type	Comments
cellId	CellId	
physicalChId	PhysicalChId	Channel identifier
g_LogicChType	G_LogicChType	
subChannel	SubChannelNumber	Valid only for logical channel types: TCH/H, FACCH/H, SACCH/TH, SDCCH/8, SACCH/C8, SDCCH/4, and SACCH/C4. For TCH/H, FACCH/H and SACCH/TH value is (0..1); For SDCCH/8 and SACCH/C8 value is (0..7); for SDCCH/4 and SACCH/C4 value is (0..3). This field is not applicable and the SS shall ignore it if this field is coded as 15.
Detailed Comments		

ASP Name	G_CL1_ComingFN_CNF	
PCO Type	G_CSAP	
Comments	The ASP is used to receive the result of G_CL1_ComingFN_REQ.	
Parameter Name	Parameter Type	Comments
cellId	CellId	
physicalChId	PhysicalChId	Channel identifier
g_LogicChType	G_LogicChType	
subChannel	SubChannelNumber	Valid only for logical channel types: TCH/H, FACCH/H, SACCH/TH, SDCCH/8, SACCH/C8, SDCCH/4, and SACCH/C4. For TCH/H, FACCH/H and SACCH/TH value is (0..1); For SDCCH/8 and SACCH/C8 value is (0..7); for SDCCH/4 and SACCH/C4 value is (0..3). This field is not applicable and the SS shall ignore it if this field is coded as 15.
rfrn	RFRN	the reduced frame number (FN modulo 42432) which is about 0.7 seconds later than current frame number and is able to carry L3 message on the channel specified by "physicalChId"+"G_LogicChType"+"subChannel"
Detailed Comments		

ASP Name	G_CL1_DeleteChannel_REQ	
PCO Type	G_CSAP	
Comments	The ASP is used to delete a basic physical channel or an multi-slot configuration	
Parameter Name	Parameter Type	Comments
cellId	CellId	The identifier of the cell which the channel to be deleted belongs to
physicalChId	PhysicalChId	The physical channel or the multi-slot configuration to be deleted.
Detailed Comments		

ASP Name	G_CL1_DeleteChannel_CNF	
PCO Type	G_CSAP	
Comments	The ASP is used to get the confirmation of a G_CL1_DeleteChannel_REQ	
Parameter Name	Parameter Type	Comments
cellId	CellId	The identifier of the cell which the deleted channel belongs to
physicalChId	PhysicalChId	The physical channel or multi-slot configuration deleted.
Detailed Comments		

ASP Name	G_CL1_CipherModeModify_REQ	
PCO Type	G_CSAP	
Comments	The ASP is used to modify cipher mode of a dedicated channel	
Parameter Name	Parameter Type	Comments
cellId	CellId	The identifier of the cell
physicalChId	PhysicalChId	Channel identifier
g_LogicChType	G_LogicChType	
subChannel	SubChannelNumber	Valid only for logical channel types: TCH/H, FACCH/H, SACCH/TH, SDCCH/8, SACCH/C8, SDCCH/4, and SACCH/C4. For TCH/H, FACCH/H and SACCH/TH value is (0..1); For SDCCH/8 and SACCH/C8 value is (0..7); for SDCCH/4 and SACCH/C4 value is (0..3). This field is not applicable and the SS shall ignore it if this field is coded as 15.
cipherMode	CipherModeSetting	The new cipher mode. Definition see 3GPP TS 04.18 or 3GPP TS 44.018 [43], clause 10.5.2.9
Detailed Comments		

ASP Name	G_CL1_CipherModeModify_CNF	
PCO Type	G_CSAP	
Comments	The ASP is used to get the confirmation of a G_CL1_CipherModeModify_REQ	
Parameter Name	Parameter Type	Comments
cellId	CellId	The identifier of the cell
physicalChId	PhysicalChId	Channel identifier
g_LogicChType	G_LogicChType	
subChannel	SubChannelNumber	Valid only for logical channel types: TCH/H, FACCH/H, SACCH/TH, SDCCH/8, SACCH/C8, SDCCH/4, and SACCH/C4. For TCH/H, FACCH/H and SACCH/TH value is (0..1); For SDCCH/8 and SACCH/C8 value is (0..7); for SDCCH/4 and SACCH/C4 value is (0..3). This field is not applicable and the SS shall ignore it if this field is coded as 15.
Detailed Comments		

ASP Name	G_CL1_ChangePowerLevel_REQ	
PCO Type	G_CSAP	
Comments	The ASP is used to change the transmission power level of a physical channel	
Parameter Name	Parameter Type	Comments
cellId	CellId	The identifier of the cell which the physical channel belongs to
physicalChId	PhysicalChId	Channel using the new transmission power level
txPower	TX_Power	The new transmission power level in dB μ Vemf()
Detailed Comments		

ASP Name	G_CL1_ChangePowerLevel_CNF	
PCO Type	G_CSAP	
Comments	The ASP is used to get the confirmation of a G_CL1_ChangePowerLevel_REQ	
Parameter Name	Parameter Type	Comments
cellId	CellId	The identifier of the cell
physicalChId	PhysicalChId	The physical channel which uses the new transmission power level
Detailed Comments		

7.3.4.3.2.2 ASPs for configuration and control of GERAN L2

ASP Name	G_CL2_HoldPhyInfo_REQ	
PCO Type	G_CSAP	
Comments	The ASP commands the SS to hold the PHYSICAL INFORMATION message, which will be sent on PCO G_L2 following the current ASP. The PHYSICAL INFORMATION message shall be sent to the UE/MS within T3124 from the time when the SS has received n handover access bursts.	
Parameter Name	Parameter Type	Comments
cellId	CellId	
physicalChId	PhysicalChId	Channel identifier
g_LogicChType	G_LogicChType	
subChannel	SubChannelNumber	Valid only for logical channel types: FACCH/H, SDCCH/8 and SDCCH/4, This field is not applicable and the SS shall ignore it if this field is coded as 15.
n	INTEGER	The number of handover access bursts to be received
Detailed Comments	T3124 is defined in 3GPP TS 04.18 or 3GPP TS 44.018 [43], clauses 3.4.4.2.2 and 11.1.1	

ASP Name	G_CL2_HoldPhyInfo_CNF	
PCO Type	G_CSAP	
Comments	The ASP is used to get a confirmation of the G_CL2_HoldPhyInfo_REQ.	
Parameter Name	Parameter Type	Comments
cellId	CellId	
physicalChId	PhysicalChId	Channel identifier
g_LogicChType	G_LogicChType	
subChannel	SubChannelNumber	Valid only for logical channel types: FACCH/H, SDCCH/8 and SDCCH/4. This field is not applicable and the SS shall ignore it if this field is coded as 15.
Detailed Comments		

ASP Name	G_CL2_MeasRptControl_REQ	
PCO Type	G_CSAP	
Comments	The ASP is used to enable or disable the reporting of received Measurement Reports to the TTCN	
Parameter Name	Parameter Type	Comments
cellId	CellId	
physicalChId	PhysicalChId	Channel identifier
g_LogicChType	G_LogicChType	Valid only for logical channel types: SACCH/TF, SACCH/TH, SACCH/C8 and SACCH/C4
subChannel	SubChannelNumber	For SACCH/TH value is (0..1); for SACCH/C8 value is (0..7); for SACCH/C4 value is (0..3).
sendMeasRpts	BOOLEAN	Whether or not to report received Measurement Reports to the TTCN.
Detailed Comments	Per default, this will be set to FALSE	

ASP Name	G_CL2_MeasRptControl_CNF	
PCO Type	G_CSAP	
Comments	The ASP is used to confirm that G_CL2_MeasRptControl_REQ was executed correctly	
Parameter Name	Parameter Type	Comments
cellId	CellId	
physicalChId	PhysicalChId	Channel identifier
Detailed Comments		

ASP Name	G_CL2_Release_REQ	
PCO Type	G_CSAP	
Comments	The ASP is used request the SS stop L2 transmission on a channel.	
Parameter Name	Parameter Type	Comments
cellId	CellId	
physicalChId	PhysicalChId	Channel identifier
Detailed Comments		

ASP Name	G_CL2_Release_CNF	
PCO Type	G_CSAP	
Comments	The ASP is used to confirm that the G_CL2_Release_REQ is executed correctly	
Parameter Name	Parameter Type	Comments
cellId	CellId	
physicalChId	PhysicalChId	Channel identifier

7.3.4.3.2.3 ASPs for configuration and control of GERAN RLC/MAC

ASP Name	G_CRLC_CreateRLC_MAC_REQ	
PCO Type	G_CSAP	
Comments	The ASP is used to create a RLC/MAC entity in GERAN RLC/MAC emulation module.	
	Parameter Name	Parameter Type
	cellId	CellId
		The identifier of the cell
Detailed Comments	One RLC/MAC entity per cell can exist, cellId will be used for coupling LLC layer module to the RLC/MAC emulation module.. The packet channel description given in the ChannelSpecificInfo of G_CL1_CreateBasicPhyCh_REQ shall be used to configure this layer. This ASP shall be called after the G_CL1_CreateBasicPhyCh_REQ ASP.	

ASP Name	G_CRLC_CreateRLC_MAC_CNF	
PCO Type	G_CSAP	
Comments	The ASP is used to confirm the G_CRLC_CreateRLC_MAC_REQ	
	Parameter Name	Parameter Type
	cellId	CellId
		The identifier of the cell
Detailed Comments		

ASP Name	G_CRLC_DeleteRLC_MAC_REQ	
PCO Type	G_CSAP	
Comments	The ASP is used to delete a RLC/MAC entity in GERAN emulation module.	
	Parameter Name	Parameter Type
	cellId	CellId
		The identifier of the cell
Detailed Comments	This ASP is used to release any resource used for the RLC/MAC emulation entity in the SS.	

ASP Name	G_CRLC_DeleteRLC_MAC_CNF	
PCO Type	G_CSAP	
Comments	The ASP is used to confirm the G_CRLC_CreateRLC_MAC_REQ	
	Parameter Name	Parameter Type
	cellId	CellId
		The identifier of the cell
Detailed Comments		

ASP Name	G_CRLC_UL_TBF_Config_REQ	
PCO Type	G_CSAP	
Comments	The ASP is used to configure a TBF used for uplink packet data transfer	
Parameter Name	Parameter Type	Comments
cellId	CellId	
tFI	TFI	
tBF_Mode	BITSTRING[1]	0 - GPRS; 1 - EGPRS
channelCoding	ChannelCoding	
tLLI_BlockChannelCoding	BITSTRING[1]	0 - CS-1 or MCS-1(EGPRS); 1 - same as channelCoding
rLC_Mode	BITSTRING[1]	0 - acknowledged mode; 1 - unacknowledged mode
startingTime	RFN	This field is not applicable and the SS shall ignore it if the field t2 of rfn is coded as '11111'B.
uSF_Rate	INTEGER	This parameter controls the speed of the UL TBF transferring data blocks by controlling the USF rate: 1---> implementation dependent. TTCN does not specify the USF generating rate; 2---> 10 USF's per second; 3---> 5 USF's per second; 4---> 1 USF per second; 5---> 1 USF per 2 seconds; 6---> 1 USF per 3 seconds; 7---> 1 USF per 4 seconds.
dynamicAllocation	dynamicAllocation	dynamic allocation and other parameters.
Detailed Comments	For GPRS channel coding can be: CS-1, CS-2, CS-3 and CS-4; For EGPRS channel coding can be : MCS-1, MCS-2, MCS-3, MCS-4, MCS-5, MCS-6, MCS-7, MCS-8, MCS-9, MCS-5-7 and MCS-6-9. Due to one cell currently has only one RLC/MAC emulation module, this ASP does not contain RLC/MAC identity parameter to indicate which RLC/MAC emulation module this TBF is established for, instead, the parameter cellId implicitly indicates the RLC/MAC module, which is created by G_CRLC_CreateRLC_MAC_REQ in the cell. The higher layer (LLC emulation module) uses rLC/MAC_MappingInfo (with type of CellId) to address the RLC/MAC emulation module to which it connects	

ASP Name	G_CRLC_UL_TBF_Config_CNF	
PCO Type	G_CSAP	
Comments	The ASP is used to get the confirmation of a G_CRLC_UL_TBF_Config_REQ	
Parameter Name	Parameter Type	Comments
cellId	CellId	
tFI	TFI	
Detailed Comments		

Type Name	ChannelCoding
Type Definition	INTEGER
Type Encoding	
Comments	1 - CS-1; 2 - CS-2; 3 - CS-3; 4 -- CS-4; 5 - MCS-1; 6 - MCS-2; 7 - MCS-3; 8 - MCS-4; 9 - MCS-5; 10 - MCS-6; 11 - MCS-7; 12 - MCS-8; 13 - MCS-9; 14 - MCS-5-7; 15 - MCS-6-9.

Type Name	DynamicAllocation		
Encoding Variation			
Comments	Used for up link TBF; dynamic allocation or extended dynamic allocation		
Element Name	Type Definition	Field Encoding	Comments
extendedAllocation	BITSTRING[1]		0 - dynamic allocation; 1 - extended dynamic allocation
uSFGranularity	BITSTRING[1]		0 - one block; 1 - four blocks
physicalChId	PhysicalChId		Single PDCH or multislot-configured PDCHs
tN0	BOOLEAN		TRUE - time slot 0 is allocated; FALSE -- not allocated
uSF_TN0	BITSTRING[3]		USF value for slot 0
tN1	BOOLEAN		TRUE - time slot 1 is allocated; FALSE -- not allocated
uSF_TN1	BITSTRING[3]		USF value for slot 1
tN2	BOOLEAN		TRUE - time slot 2 is allocated; FALSE -- not allocated
uSF_TN2	BITSTRING[3]		USF value for slot 2
tN3	BOOLEAN		TRUE - time slot 3 is allocated; FALSE -- not allocated
uSF_TN3	BITSTRING[3]		USF value for slot 3
tN4	BOOLEAN		TRUE - time slot 4 is allocated; FALSE -- not allocated
uSF_TN4	BITSTRING[3]		USF value for slot 4
tN5	BOOLEAN		TRUE - time slot 5 is allocated; FALSE -- not allocated
uSF_TN5	BITSTRING[3]		USF value for slot 5
tN6	BOOLEAN		TRUE - time slot 6 is allocated; FALSE -- not allocated
uSF_TN6	BITSTRING[3]		USF value for slot 6
tN7	BOOLEAN		TRUE - time slot 7 is allocated; FALSE -- not allocated
uSF_TN7	BITSTRING[3]		USF value for slot 7
Detailed Comments	The uSF_TNx field is not applicable when tNx = FALSE.		

ASP Name	G_CRLC_DL_TBF_Config_REQ	
PCO Type	G_CSAP	
Comments	The ASP is used to configure a TBF used for down link packet data transfer	
Parameter Name	Parameter Type	Comments
cellId	CellId	
tFI	TFI	
tBF_Mode	BITSTRING[1]	0 - GPRS; 1 - EGPRS
channelCoding	ChannelCoding	
rLC_Mode	BITSTRING[1]	0 - acknowledged mode; 1 - unacknowledged mode
timeSlotAllocation	TimeSlotAllocation	Downlink TBF time slot allocation
startingTime	RFN	This field is not applicable and the SS shall ignore it if the field t2 of rfn is coded as '11111'B.
dataBlockRate	INTEGER	This parameter controls the speed of the DL TBF sending RLC/MAC data blocks on the assigned PDCH's: 1---> implementation dependent. TTCN does not specify the data block rate; 2---> 10 data blocks per second; 3---> 5 data blocks per second; 4---> 1 data block per second; 5---> 1 data block per 2 seconds; 6---> 1 data block per 3 seconds; 7---> 1 data block per 4 seconds.
Detailed Comments	For GPRS channel coding can be: CS-1, CS-2, CS-3 and CS-4; For EGPRS channel coding can be : MCS-1, MCS-2, MCS-3, MCS-4, MCS-5, MCS-6, MCS-7, MCS-8, MCS-9, MCS-5-7 and MCS-6-9.	

ASP Name	G_CRLC_DL_TBF_Config_CNF	
PCO Type	G_CSAP	
Comments	The ASP is used to get the confirmation of a G_CRLC_DL_TBF_Config_REQ	
Parameter Name	Parameter Type	Comments
cellId	CellId	
tFI	TFI	
Detailed Comments		

Type Name	TimeSlotAllocation		
Encoding Variation			
Comments	Used for downlink and up link TBF		
Element Name	Type Definition	Field Encoding	Comments
physicalChId	PhysicalChId		single PDCH or multislot-configured PDCHs
tN0	BOOLEAN		Timeslot 0; TRUE - allocated; FALSE - not allocated.
tN1	BOOLEAN		Timeslot 1; TRUE - allocated; FALSE - not allocated.
tN2	BOOLEAN		Timeslot 2; TRUE - allocated; FALSE - not allocated.
tN3	BOOLEAN		Timeslot 3; TRUE - allocated; FALSE - not allocated.
tN4	BOOLEAN		Timeslot 4; TRUE - allocated; FALSE - not allocated.
tN5	BOOLEAN		Timeslot 5; TRUE - allocated; FALSE - not allocated.
tN6	BOOLEAN		Timeslot 6; TRUE - allocated; FALSE - not allocated.
tN7	BOOLEAN		Timeslot 7; TRUE - allocated; FALSE - not allocated.
Detailed Comments			

7.3.4.3.2.4 ASPs for configuration and control of GERAN LLC

ASP Name	G_CLLC_CreateLLE_REQ	
PCO Type	G_CSAP	
Comments	The ASP is used to create an LLE (LLC Entity) in GERAN emulation part of the SS and connects the created LLE to the RLC/MAC emulation module pointed by rLC/MAC_MappingInfo..	
Parameter Name	Parameter Type	Comments
ILMEId	LLMEId	Logical Layer Management Entity Id
rLC/MAC_MappingInfo	CellId	This parameter indicates the RLC/MAC emulation module in the cell, not the cell itself.
Detailed Comments	The RLC/MAC emulation module needs to be created prior to this ASP by G_CRLC_CreateRLC_MAC_REQ ASP.	

ASP Name	G_CLLC_CreateLLE_CNF	
PCO Type	G_CSAP	
Comments	The ASP is used to confirm the G_CLLC_CreateLLE_REQ	
Parameter Name	Parameter Type	Comments
ILMEId	LLMEId	The identifier of the cell Logical Layer Management Entity Id
Detailed Comments		

ASP Name	G_CLLC_DeleteLLE_REQ	
PCO Type	G_CSAP	
Comments	The ASP is used to delete an LLE (LLC Entity) in GERAN LLC emulation module.	
Parameter Name	Parameter Type	Comments
ILMEId	LLMEId	Logical Layer Management Entity Id
Detailed Comments		

ASP Name	G_CLLC_DeleteLLE_CNF	
PCO Type	G_CSAP	
Comments	The ASP is used to confirm the G_CLLC_DeleteLLE_REQ	
Parameter Name	Parameter Type	Comments
ILMEId	LLMEId	Logical Layer Management Entity Id
Detailed Comments		

ASP Name	G_CLLC_Assign_REQ	
PCO Type	G_CSAP	
Comments	The ASP is used to assign, change, or unassign the TLLI, the ciphering key (Kc) and the ciphering algorithm of GERAN LLC emulation module.	
Parameter Name	Parameter Type	Comments
ILMEId	LLMEId	Logical Layer Management Entity Id
oldTLLI	TLLI	OCTETSTRING[4]
newTLLI	TLLI	
cipherKey	BITSTRING[64]	
cipherAlgorithm	GPRS_CipherAlg	BITSTRING[3], see 3GPP TS 24.008 [9], clause 10.5.5.3
Detailed Comments	<p>This ASP is used to assign, change, or unassign the TLLI, the ciphering key (Kc) and the ciphering algorithm.</p> <ol style="list-style-type: none"> The oldTLLI and newTLLI parameters shall be interpreted as follows: <ul style="list-style-type: none"> If oldTLLI = all 1's and newTLLI ≠ all 1's then newTLLI is assigned and used when (re-)transmitting LLC frames. If an oldTLLI ≠ all 1's was assigned to the LLME, then oldTLLI is unassigned. Only newTLLI is accepted when received from the peer. It shall be treated as a TLLI change. If oldTLLI = all 1's was assigned to the LLME, then this shall be treated as a TLLI assignment, and this ASP shall be the first ASP sent to the SS in order to enable LLC to process requests from layer 3. If oldTLLI ≠ all 1's and newTLLI ≠ all 1's then oldTLLI and newTLLI are assigned, and newTLLI shall be used when (re-)transmitting LLC frames. Both oldTLLI and newTLLI shall be accepted when received from the peer. It shall be treated as a TLLI change. If oldTLLI ≠ all 1's and newTLLI = all 1's then oldTLLI shall be unassigned. It shall be treated as a TLLI unassignment, and this ASP shall be the last ASP sent to the SS in order to disable LLC to not process requests from layer 3 any longer. Kc and Ciphering Algorithm are associated with newTLLI (and with oldTLLI if assigned): <ul style="list-style-type: none"> If Ciphering Algorithm indicates no ciphering, then the ciphering function shall be disabled. Otherwise, the ciphering function shall be enabled. If a Ciphering Algorithm was already associated with newTLLI or oldTLLI, then the new Kc shall replace the previous Kc, and Ciphering Algorithm shall replace the previous algorithm selection. All I frames, and UI frames with the E bit set to 1, shall use the new Kc and algorithm for ciphering. All unacknowledged I frames shall be ciphered using the new Kc and algorithm before retransmission. As an implementation option, the previous Kc and algorithm may be used to decipher received frames. 	

ASP Name	G_CLLC_Assign_CNF	
PCO Type	G_CSAP	
Comments	the ASP is used to get confirmation of G_CLLC_Assign_REQ	
Parameter Name	Parameter Type	Comments
ILMEId	LLMEId	Logical Layer Management Entity Id
Detailed Comments		

7.3.4.3.2.5 Void

7.3.5 A-GPS Upper tester, PCO and ASP definitions

This clause is for A-GPS test model in Release 99, the A-GNSS test model is referred to 3GPP TS 36.571-4 [56].

7.3.5.1 Upper tester

In order to perform A-GPS test, an Upper Tester is defined to have two basic functional unites:

- Satellite simulator generating and broadcasting satellite signals;
- Assistance data source storing the data simulating a number of pre-defined GPS test scenarios.

Under the TTCN command, the upper tester loads a pre-defined or re-loads another pre-defined GPS test scenario to the satellite simulator. The generated satellite signals shall simulate a sufficient number satellites. The signal shall be sufficiently strong, in order to enable the UE to do the positioning measurement.

The SS also sends the GPS assistance data to the UE through RRC signalling to facilitate the UE acquiring and tracking satellites. Such assistance data shall be consistent to within ± 2 seconds with the satellite signals generated.

The assistance data source shall provide the assistance data consistent to $\pm 1/0$ second with the GPS test scenario currently running in the satellite simulator (i.e. the data shall be up to 1 second in advance of the scenario); this allows for a further 2 seconds of latency in the SS.

7.3.5.2 SV PCO

The upper tester has an ASP interface through a PCO in type of SatS PCO defined in the table.

PCO Type Declarations	
PCO Type	SatS
Role	UT
Comments	PCO type used for the Satellite Simulator and the assistance data source in the upper tester

PCO Declarations	
PCO Name	SV
PCO Type	SatS
Role	UT
Comments	Carry control, configuration and GPS assistance data to/from satellite simulator and assistance data source in the upper tester

7.3.5.3 A-GPS Primitives

The primitives at SV PCO are used to

- load a pre-defined test scenario into the satellite simulator;
- start or stop generating and broadcasting satellite signals from the satellite simulator;
- retrieve the GPS assistance data from assistance data source, the table below is the summary of these primitives.

Primitive	Parameters	Use
Satellite_StartStop_REQ	Mode: start or stop	Start or stop generating satellite signals in the satellite simulator.
Satellite_StartStop_CNF	Null	Confirm the Satellite_StartStop_Req.
Load_GPS_Scenario_REQ	GPS test scenario number	Requests to load a pre-defined test scenario into the satellite simulator
Load_GPS_Scenario_CNF	Null	Confirm the load_GPS_Scenario_Req
Retri_GPS_AssistanceData_REQ	Indication of which assistance data elements to be retrieved	Request the assistance data source to provide the next (in time) valid GPS assistance data elements.
Retri_GPS_AssistanceData_CNF	GPS assistance data elements	Return the GPS assistance data retrieved

7.3.5.3.1 Control ASP Type Definition

ASN.1 ASP Type Definition	
Type Name	Satellite_StartStop_CNF
PCO Type	SatS
Comment	To confirm successful of Satellite_StartStop_REQ
Type Definition	
SEQUENCE	{ confirm NULL }

ASN.1 ASP Type Definition	
Type Name	Satellite_StartStop_REQ
PCO Type	SatS
Comment	To start or stop generating satellite signals in the satellite simulator "start" starts broadcasting satellite signals; "stop" stops broadcasting satellite signals If used for start (0), this ASP shall be called 2 s. after the ASP Load_GPS_Scenario_REQ for loading or reloading a pre-defined GPS test scenario.
Type Definition	
SEQUENCE	{ satelliteSignals ENUMERATED {startSatSignal (0), stopSatSignal (1)} }

7.3.5.3.2 Data ASP Type Definition

ASN.1 ASP Type Definition	
Type Name	Load_GPS_Scenario_CNF
PCO Type	SatS
Comment	To confirm the Load_GPS_Scenario_REQ
Type Definition	
SEQUENCE	{ dummy NULL }

ASN.1 ASP Type Definition	
Type Name	Load_GPS_Scenario_REQ
PCO Type	SatS
Comment	To request the upper tester to load the required pre-defined GPS test scenario.
Type Definition	
SEQUENCE	{ gps_Scenario INTEGER(0..31) }

ASN.1 ASP Type Definition	
Type Name	Retri_GPS_AssistanceData_CNF
PCO Type	SatS
Comment	To return the next valid GPS assistance data elements as requested in the Retri_GPS_AssistanceData_REQ. The returned GPS assistance data (all or part) will be used as assistance data sent to UE in RRC messages for A-GPS positioning. The returned Almanac information is split into two fields: - Almanac for satellites 1 to 12: in 'assistanceData' together with other information; - Almanac for satellites 13 to 24: in 'almanacSat13To24'
Type Definition	
SEQUENCE	{ assistanceData UE_Positioning_GPS_AssistanceData, almanacSat13To24 AlmanacSatInfoList OPTIONAL }

ASN.1 ASP Type Definition	
Type Name	Retri_GPS_AssistanceData_REQ
PCO Type	SatS
Comment	To request the GPS assistance data source to provide the next valid GPS assistance data elements, consistent with the running GPS test scenario. The parameter navModelAddDataRequest in the assistanceDataReq shall be omitted. Another three parameters, utcModelRequest, dgpsCorrectionsRequest and realTimeIntegrityRequest in the assistanceDataReq are not applicable and shall be set to "FALSE".
Type Definition	
SEQUENCE	{ assistanceDataReq UE_Positioning_GPS_AdditionalAssistanceDataRequest }

7.3.6 ROHC test model and ASP

7.3.6.1 ROHC test method

The ROHC test architecture illustrates the relationship between various compressor and de-compressor entities. No de-compressor is implemented in PDCP on the uplink direction in the SS.

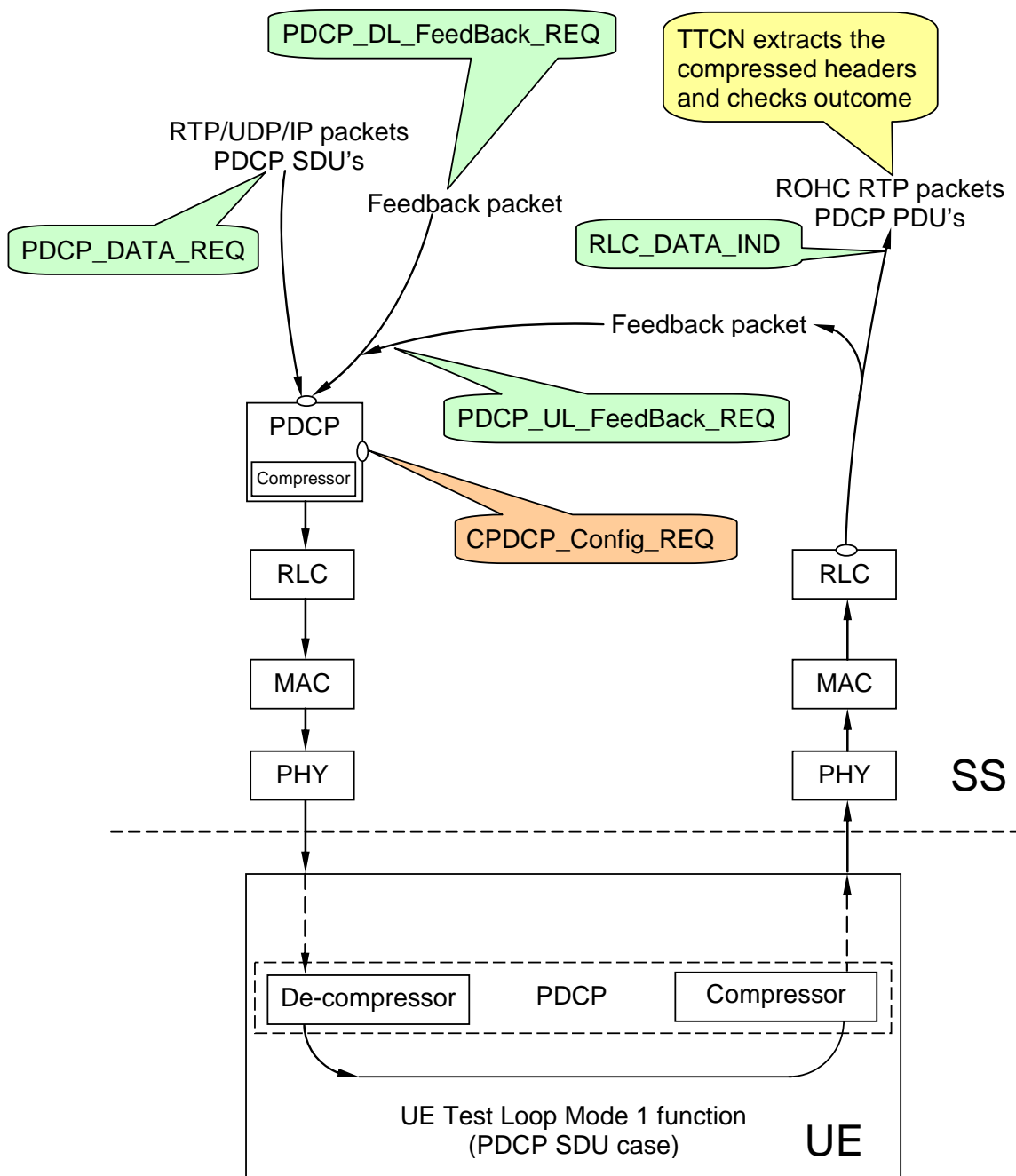

Figure 7.3.6.1: ROHC testing architecture

7.3.6.2 ASP and PCO for control primitives transmission and reception

7.3.6.2.1 PCO definition

Table 7.3.6.2.1: PCO CPDCCP declaration

PCO Definition	
PCO Name	CPDCCP
PCO Type	CSAP
Role	LT
Comment	Provide PDCP Layer configuration service

7.3.6.2.2 CPDCP_Config

ASN.1 ASP Type Definition	
Type Name	CPDCP_Config_CNF
PCO Type	CSAP
Comment	For PDCP emulator to report that a previous attempt to setup, reconfigure or release a logical channel is successful.
Type Definition	
SEQUENCE	{ cellId INTEGER(-1..63), routingInfo RoutingInfo }

ASN.1 ASP Type Definition	
Type Name	CPDCP_Config_REQ
PCO Type	CSAP
Comment	To request to configure PDCP entity. Setup is used for creation of the PDCP instances or the PDCP resources. Release is used for free the all PDCP resources. The reconfiguration is to change the PDCP parameters. PDCP entity does not belong to a particular cell, the cellId shall assign the value -1. the routingInfo is RB identity which is used to connect this PDCP entity to the RLC entity with the same RB identity and it is also used for PDCP_DATA_REQ ASP to transmit data through this PDCP entity.
Type Definition	
SEQUENCE	{ cellId INTEGER(-1..63), routingInfo RoutingInfo, ratType RatType, configMessage CHOICE { setup SS_PDCP_Info, reconfigure SS_PDCP_InfoReconfig, release NULL } }

ASN.1 Type Definition	
Type Name	SS_PDCP_Info
Comment	When configuring downlink direction of the SS, the UL_RFC3095-r4 shall be used; when configuring uplink direction of the SS the DL_RFC3095-r4 shall be used.
Type Definition	
SEQUENCE	{ pDCP_ROHC_TargetMode PDCP_ROHC_TargetMode OPTIONAL, pDCP_Info PDCP_Info_r4, cSVoHS_Info CS_HSPA_Information OPTIONAL -- Rel-7 or later }

ASN.1 Type Definition	
Type Name	SS_PDCP_InfoReconfig
Comment	When configuring downlink direction of the SS, the UL_RFC3095-r4 shall be used; when configuring uplink direction of the SS the DL_RFC3095-r4 shall be used.
Type Definition	
SEQUENCE	{ pDCP_ROHC_TargetMode PDCP_ROHC_TargetMode OPTIONAL, pDCP_Info PDCP_InfoReconfig_r4, cSVoHS_Info CS_HSPA_Information OPTIONAL -- Rel_7 or later }

7.3.6.2.3 CPDCP_ComProtocolControl

ASN.1 ASP Type Definition	
Type Name	CPDCP_ComProtocolControl_CNF
PCO Type	CSAP
Comment	For PDCP emulator to report that a previous attempt to control the compression protocol is successful.
Type Definition	
SEQUENCE	{ cellId INTEGER (-1..63), routingInfo RoutingInfo }

ASN.1 ASP Type Definition	
Type Name	CPDCP_ComProtocolControl_REQ
PCO Type	CSAP
Comment	To request to reinitialize/context-relocate the compression protocol. PDCP entity does not belong to a particular cell; the cellId shall assign the value -1. The routingInfo is RB identity which is used to connect this PDCP entity to the RLC entity with the same RB identity and it is also used for PDCP_DATA_REQ ASP to transmit data through this PDCP entity. For reinitialization: - Configured compression parameters remain valid. - All compression state information is initialized. - The PDCP sequence numbers are not changed. - Actions specified in section 6.3.1 of RFC 3095 [54]. For contextRelocation: - initialize the context with the parameter in the ASP - valid for RFC3095 compression only
Type Definition	
SEQUENCE	{ cellId INTEGER (-1..63), routingInfo RoutingInfo, ratType RatType, controlMessage CHOICE { reinitialisation NULL, contextRelocation Context } }

ASN.1 Type Definition	
Type Name	Context
Comment	Adapted from ASN1 type: RFC3095_Context_List
Type Definition	
SEQUENCE	(SIZE (1..maxRFC3095_CID)) OF SEQUENCE { dl_RFC3095_Context DL_RFC3095_Context OPTIONAL, ul_RFC3095_Context UL_RFC3095_Context OPTIONAL }

ASN.1 Type Definition	
Type Name	DL_RFC3095_Context
Comment	For the compressor in the SS
Type Definition	
SEQUENCE	{ rfc3095_Context_Identity INTEGER (0..16383), dl_mode ENUMERATED {u, o, r}, dl_ref_ir OCTET STRING (SIZE (1..3000)), dl_ref_time INTEGER (0..4294967295) OPTIONAL, dl_curr_time INTEGER (0..4294967295) OPTIONAL, dl_syn_offset_id INTEGER (0..65535) OPTIONAL, dl_syn_slope_ts INTEGER (0..4294967295) OPTIONAL, dl_dyn_changed BOOLEAN }

ASN.1 Type Definition	
Type Name	UL_RFC3095_Context
Comment	For the de-compressor in the SS
Type Definition	
SEQUENCE {	
rfc3095_Context_Identity	INTEGER (0..16383),
ul_mode	ENUMERATED {u, o, r},
ul_ref_ir	OCTET STRING (SIZE (1..3000)),
ul_ref_time	INTEGER (0..4294967295) OPTIONAL,
ul_curr_time	INTEGER (0..4294967295) OPTIONAL,
ul_syn_offset_id	INTEGER (0..65535) OPTIONAL,
ul_syn_slope_ts	INTEGER (0..4294967295) OPTIONAL,
ul_ref_sn_1	INTEGER (0..65535) OPTIONAL
}	

7.3.6.3 ASP and PCO for data transmission and reception

7.3.6.3.1 PCO definition

Table 7.3.6.3.1: PCO PDCP declaration

PCO Type Definition	
PCO Name	PDCP
PCO Type	DSAP
Role	LT
Comment	Provide PDCP data transfer service

7.3.6.3.2 PDCP_DATA

ASP Name	PDCP_DATA_REQ	
PCO Type	DSAP	
Comments	To request to transmit data (PDCP SDU)	
Parameter Name	Parameter Type	Comments
cellId	CellId	
rB_Id	SS_RB_Identity	Radio bearer identifier
pDCP_SDU	PDU	IPv4/UDP/RTP or IPv6/UDP/RTP PDUs
Detailed Comments		

ASP Name	PDCP_DATA_IND	
PCO Type	DSAP	
Comments	To indicate to receive data (PDCP SDU)	
Parameter Name	Parameter Type	Comments
cellId	CellId	
rB_Id	SS_RB_Identity	Radio bearer identifier
pDCP_SDU	PDU	IPv4/UDP/RTP or IPv6/UDP/RTP PDUs
Detailed Comments		

7.3.6.3.3 PDCP_DL_FeedBack

ASP Name	PDCP_DL_FeedBack_CNF	
PCO Type	DSAP	
Comments	For the SS to confirm a previous PDCP_DL_FeedBack_REQ.	
Parameter Name	Parameter Type	Comments
cellId	CellId	
rB_Id	SS_RB_Identity	Radio bearer identifier
Detailed Comments		

ASP Name	PDCP_DL_FeedBack_REQ	
PCO Type	DSAP	
Comments	To request the SS to send a feedback packet to the compressor in the UE.	
Parameter Name	Parameter Type	Comments
cellId	CellId	
rB_Id	SS_RB_Identity	Radio bearer identifier
feedBackPacket1	FeedBackPacket1	either of feedBackPacket1 or feedBackPacket2 is presented
feedBackPacket2	FeedBackPacket2	
Detailed Comments		

ASP Name	PDCP_UL_FeedBack_CNF	
PCO Type	DSAP	
Comments	For the SS to confirm a previous PDCP_UL_FeedBack_REQ.	
Parameter Name	Parameter Type	Comments
cellId	CellId	
rB_Id	SS_RB_Identity	Radio bearer identifier
Detailed Comments		

ASP Name	PDCP_UL_FeedBack_REQ	
PCO Type	DSAP	
Comments	To request the SS to pass a feedback packet received on uplink to the compressor in the SS. When a feedback packet is received at the uplink direction, TTCN uses this ASP to pass the received feedback packet to the downlink compressor of the SS	
Parameter Name	Parameter Type	Comments
cellId	CellId	
rB_Id	SS_RB_Identity	Radio bearer identifier
feedBackPacket1	FeedBackPacket1	either of feedBackPacket1 or feedBackPacket2 is presented
feedBackPacket2	FeedBackPacket2	
Detailed Comments		

Type Name	FeedBackPacket1		
Encoding Variation			
Comments	For ROHC RTP		
Element Name	Type Definition	Field Encoding	Comments
feedBackType	BITSTRING[5]		'11110'B
code	BITSTRING[3]		
size	OCTETSTRING[1]		Present if code = 0
addCIDpart1	BITSTRING[4]		Present if small CID and CID <>0; this shall be "1110"
addCIDpart2	BITSTRING[4]		Present if small CID and CID <>0; This is the CID value
largeCID	OCTETSTRING[1..2]		Present if large CID
sequenceNumber	BITSTRING[8]		
Detailed Comments			

Type Name	FeedBackPacket2		
Encoding Variation			
Comments	For ROHC RTP		
Element Name	Type Definition	Field Encoding	Comments
feedBackType	BITSTRING[5]		'11110'B
code	BITSTRING[3]		
size	OCTETSTRING[1]		Present if code = 0
addCIDpart1	BITSTRING[4]		Present if small CID and CID <>0; this shall be "1110"
addCIDpart2	BITSTRING[4]		Present if small CID and CID <>0; This is the CID value
largeCID	OCTETSTRING[1..2]		Present if large CID
ackType	BITSTRING[2]		0 = ACK; 1 = NACK; 2 = STATIC-NACK; 3 = reserved
mode	BITSTRING[2]		
sequenceNumber	BITSTRING[12]		
optioncode	BITSTRING[4]		
optionLength	BITSTRING[4]		Only 0 and 1 are valid values
optionData	BITSTRING[8]		Present if optionLength = 1
Detailed Comments	See section 5.7.6.1 of RFC 3095 [54] for the coding of optionalLength and optionalData		

7.3.7 Handling RLP for CS non-transparent data

After the establishment of a CS non-transparent data call during the test, the UE may attempt to initiate a Radio Link Protocol (RLP) connection or start XID exchange before the RLP connection if the UE has an RLP installed. The RLP frames exchanges shall be handled by the SS, in order to carry on the test. Otherwise, the UE may disconnect the CS call.

For the purpose of handling UE originated RLP frames the SS has installed an RLC codec. The RLP codec supports RLP Version 0,1, and 2, detects the version number at the first XID exchange. Without any prior XID exchange, the default version 0 applies. According to the RLP version number, the codec decodes / encodes U, S, I+S frames including header, information and FCS (Frame Check Sequence) fields. The RLP has a fixed bit frame size that is set to 576 bits. The SS RLP codec calculates the FCS value and inserts it in the FCS fields in each DL RLP frames. The FCS values in the UL frames are irrelevant in the TTCN. The I frames are decoded and acknowledged in TTCN, and the other RLP frames are decoded and discarded in the default behaviour trees in TTCN.

7.3.7.1 UTRAN cell

In a UTRAN cell, an RLP codec can be activated on the top of the SS TM RLC entity if the RLP protocol is applied to the UE. In addition of PCO TM, two new PCOs are defined. The PCO CRLP is used for the control and configuration of the RLP codec and the PCO RLP is used for the transferring of the RLP frames. PCO TM is not applied if PCO RLP is used in the test.

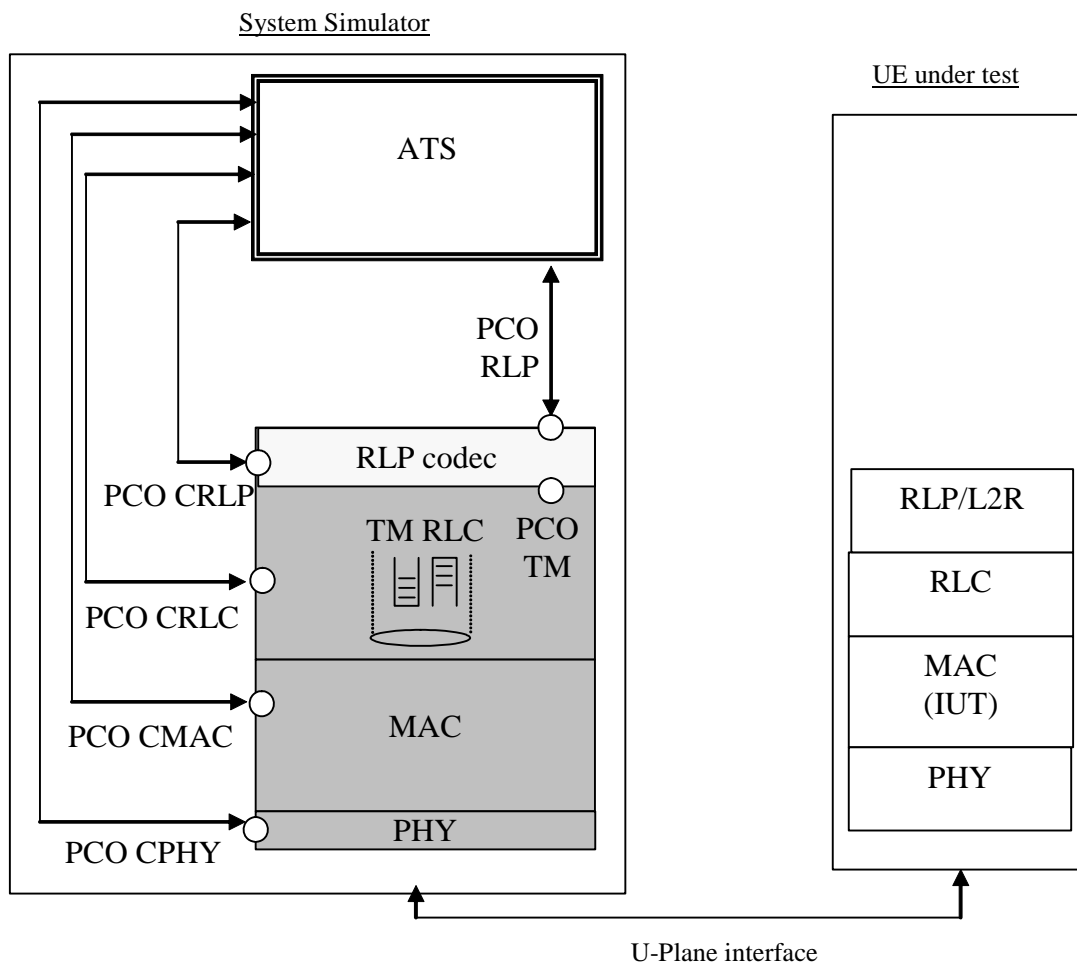

Figure 7.3.7.1: RLP codec model

An activate / deactivate command is required within the CRLP_Config_REQ to configure and activate the RLP codec and RLP PCO. The deactivate command switches off the RLP PCO and the SS discards all received RLP frames.

7.3.7.2 GERAN cell

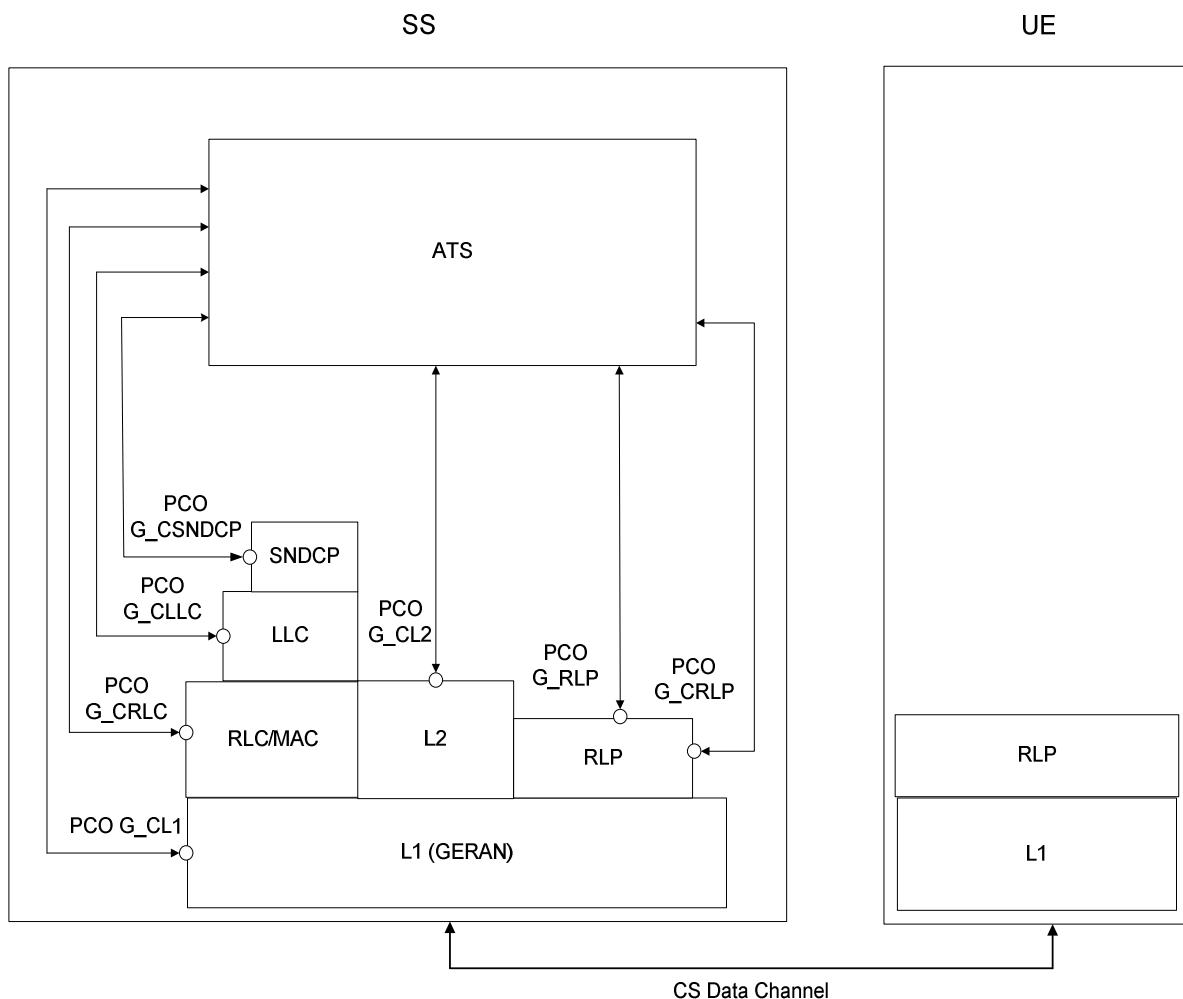

Figure 7.3.7.2: GERAN RLP codec model

After the establishment of a CS non-transparent data call in a GERAN cell during the test, the UE may attempt to initiate a Radio Link Protocol (RLP) connection or start XID exchange before the RLP connection if the UE has an RLP installed. The RLP frame exchanges shall be handled by the SS, in order to carry on the test. Otherwise, the UE may disconnect the CS call.

In a GERAN cell, an RLP codec can be activated on the traffic channel if the RLP protocol is applied to the UE. Two new PCOs are defined: G_CRLP is used for the control and configuration of the RLP codec and G_RLP is used for the transferring of the RLP frames in the GERAN cell.

For the purposes of interRAT handover testing, only the frame length of 576 bits is required. The 240 bits frame length and the REMAP function are not required.

7.3.7.3 ASP and PCO for control primitives

Table 7.3.7.3: PCO CRLP

PCO Definition	
PCO Name	CRLP
PCO Type	CSAP
Role	LT
Comment	Control RLP codec.

ASP Name	CRLP_Config_REQ	
PCO Type	CSAP	
Comments	The ASP is used to activate or deactivate the RLP codec.	
Parameter Name	Parameter Type	Comments
cellId	CellId	The cell which the RB identity belongs to
rB_Identity	SS_RB_Identity	Identifier of the RB identity in the SS
command	INTEGER	0: activate 1: deactivate
Detailed Comments		

ASP Name	CRLP_Config_CNF	
PCO Type	CSAP	
Comments	For RLP codec to confirm that a previous attempt to activate or deactivate has been successful.	
Parameter Name	Parameter Type	Comments
cellId	CellId	The cell which the RB identity belongs to
rB_Identity	SS_RB_Identity	Identifier of the RB identity in the SS
Detailed Comments		

PCO Definition	
PCO Name	G_CRLP
PCO Type	G_CSAP
Role	LT
Comment	Control RLP codec in GERAN cell

ASP Name	G_CRLP_Config_REQ	
PCO Type	G_CSAP	
Comments	The ASP is used to activate or deactivate the RLP agent in the GERAN cell and establish a pipe between the TTCN and the RLP agent on the TCH.	
Parameter Name	Parameter Type	Comments
cellId	CellId	The cell which the RB identity belongs to
channelId	PhysicalChId	Identifier of the TCH in the SS
command	INTEGER	0: activate 1: deactivate
Detailed Comments		

ASP Name	G_CRLP_Config_CNF	
PCO Type	G_CSAP	
Comments	For the RLP agent to confirm that a previous attempt to activate or deactivate has been successful.	
Parameter Name	Parameter Type	Comments
cellId	CellId	The cell which the TCH belongs to
channelId	PhysicalChId	Identifier of the TCH in the SS
Detailed Comments		

7.3.7.4 ASP and PCO for data transmission and reception

Table 7.3.7.4: PCO RLP declaration

PCO Type Definition	
PCO Name	RLP
PCO Type	DSAP
Role	LT
Comment	Carry RLP frame.

ASP Name	RLP_FrameReq	
PCO Type	DSAP	
Comments	The ASP is used to request the transmission of the RLP frame.	
Parameter Name	Parameter Type	Comments
cellId	CellId	
rB_Identity	SS_RB_Identity	Identifier of the RB identity in the SS
data	PDU	Meta type PDU
Detailed Comments		

ASP Name	RLP_FrameInd	
PCO Type	DSAP	
Comments	The ASP is used to indicate the reception of an RLP frame.	
Parameter Name	Parameter Type	Comments
cellId	CellId	
rB_Identity	SS_RB_Identity	Identifier of the RB identity in the SS
data	PDU	Meta type PDU
Detailed Comments		

PCO Type Definition	
PCO Name	G_RLP
PCO Type	G_DSAP
Role	LT
Comment	Carry RLP frame.

ASP Name	G_RLP_FrameReq	
PCO Type	G_DSAP	
Comments	The ASP is used to request the transmission of the RLP frame.	
Parameter Name	Parameter Type	Comments
cellId	CellId	
channelId	PhysicalChId	Identifier of the TCH in the SS
data	PDU	Meta type PDU
Detailed Comments		

ASP Name	G_RLP_FrameInd	
PCO Type	G_DSAP	
Comments	The ASP is used to indicate the reception of an RLP frame.	
Parameter Name	Parameter Type	Comments
cellId	CellId	
channelId	PhysicalChId	Identifier of the TCH in the SS
data	PDU	Meta type PDU
Detailed Comments		

8 Design Considerations

8.1 Channel mapping

Figure 8.1 shows the channel type mapping that is used for the configuration of the SS.

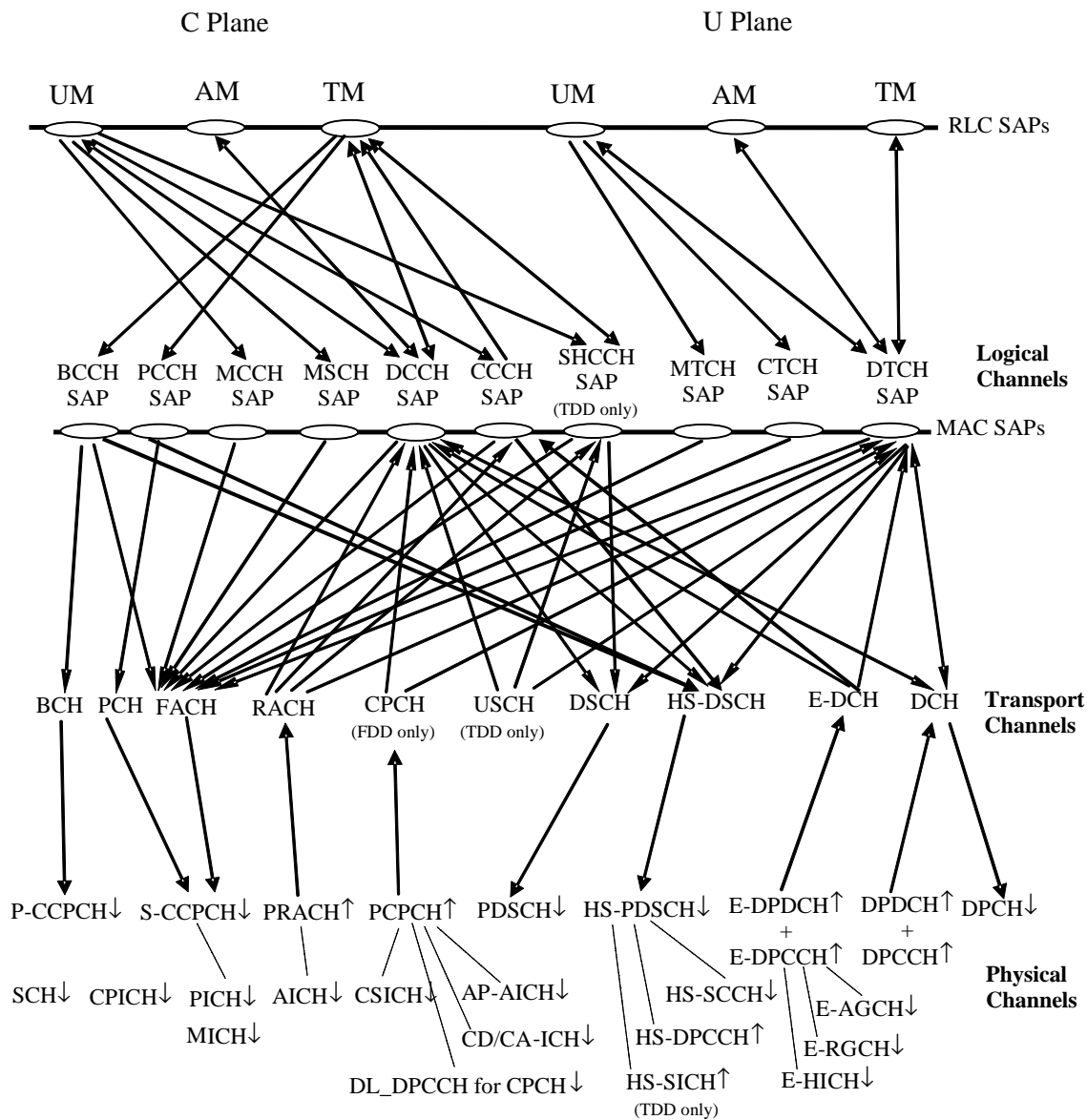

Figure 8.1: Channel mapping in SS-

8.2 Channel and RB identity

The TTCN addresses the TTCN tester by using a channel identifier:

- Either Physical channel identifier (PhyCh id); or
- Transport channel identifier (TrCh id); or
- Radio bearer identifier (RB id).

The selected channel identifier identifies uniquely:

- a channel within a cell;
- a total path of the address in the lower layers concerned.

Having taken out the cell id and PCO id (AM, UM and TM), a complete address, as RoutingInfo in the RRC ASP definition, should have at least five fields, CN domain id, RB id, LogCH id, TrCH id and PhyCH id. For simplified application of CHOICE of the routing information, a TTCN writer must carefully follow a number of rules assigning the channel identifiers.

General requirements:

- a structured scheme of planning all channel identifiers assigned;
- the scheme shall meet the requirements for all test cases in 3GPP TS 34.123-1 [1] including TDD channels;
- the scheme can apply to all radio bearer configurations in 3GPP TS 34.108 [3], clause 6.10;
- a clear multiplex mapping between a PhyCH id to TrCH ids and a TrCH id to LogCH ids, RB ids is needed.

Requirements on identification of RB in a test case:

- unique identification of the individual SRBs;
- unique identification of the individual sub-flows of a RABs in CS and PS domain.;
- an assigned RB id can represent UL and DL.

Requirements on identification of Logical Channel in a test case:

- it is an instance number of the individual logical channel; and
- uniquely identifies among all the Logical Channel mapped onto a Transport Channel.

Requirements on identification of Transport Channel in a test case:

- unique identification of the individual Transport Channel;
- assign different identities for UL and DL of a same Transport Channel type;
- the order of the Transport Channel id assigned in a cell shall follow the TFCS definitions in the 3GPP TS 34.108 [3], clause 6.10.

EXAMPLE: Transport Channel ids are assigned in the ascending order for (RABsubflow#1, RABsubflow#2, RABsubflow#3, 64kRAB, DCCH).

Requirements on identification of Physical Channel in a test case:

- unique identification of the individual Physical Channel;
- assign different identities for UL and DL of a same Physical Channel type;
- each S-CCPCH or PRACH has a unique identifier;
- for 2 Mbps PS data radio link (in case of demux of a Transport Channel), three DPCH are needed for high-speed data. A single Physical Channel id is assigned to a bundle of the three physical channels.

Table 8.2 shows which type of channel identity is chosen for the individual primitives. In table 8.2, the ASN.1 primitives use a CHOICE type for channel identity, while TTCN primitives use an explicit channel identity.

Table 8.2: Primitives and the associated channel identity type

Primitive name	Channel Identity	Releases
ASN.1 Primitives		
CPHY_AICH_AckModeSet_CNF	Physical Channel Identity	
CPHY_AICH_AckModeSet_REQ	Physical Channel Identity	
CPHY_Cell_Config_CNF	No Routing Info Field Present	
CPHY_Cell_Config_REQ	No Routing Info Field Present	
CPHY_Cell_Ini_CNF	No Routing Info Field Present	
CPHY_Cell_Ini_REQ	No Routing Info Field Present	
CPHY_Cell_TxPower_Modify_CNF	No Routing Info Field Present	
CPHY_Cell_TxPower_Modify_REQ	No Routing Info Field Present	
CPHY_Cell_Release_CNF	No Routing Info Field Present	
CPHY_Cell_Release_REQ	No Routing Info Field Present	
CPHY_DetectTFCI_CNF	Physical Channel Identity	
CPHY_DetectTFCI_IND	Physical Channel Identity	
CPHY_DetectTFCI_REQ	Physical Channel Identity	
CPHY_Frame_Number_CNF	Physical Channel Identity	
CPHY_Frame_Number_REQ	Physical Channel Identity	
CPHY_SFN_CNF	Physical Channel Identity	Rel-6 or later
CPHY_SFN_REQ	Physical Channel Identity	Rel-6 or later
CPHY_MBMS_MICH_q_CNF	Physical Channel Identity	Rel-6 or later
CPHY_MBMS_MICH_q_REQ	Physical Channel Identity	Rel-6 or later
CPHY_MBMS_NI_CNF	Physical Channel Identity	Rel-6 or later
CPHY_MBMS_NI_REQ	Physical Channel Identity	Rel-6 or later
CPHY_Out_of_Sync_IND	Physical Channel Identity	
CPHY_PRACH_Measurement_CNF	Physical Channel Identity	
CPHY_PRACH_Measurement_REQ	Physical Channel Identity	
CPHY_PRACH_Measurement_Report_IND	Physical Channel Identity	
CPHY_RL_Modify_CNF	Physical Channel Identity	
CPHY_RL_Modify_REQ	Physical Channel Identity	
CPHY_RL_Release_CNF	Physical Channel Identity	
CPHY_RL_Release_REQ	Physical Channel Identity	
CPHY_RL_Setup_CNF	Physical Channel Identity	
CPHY_RL_Setup_REQ	Physical Channel Identity	
CPHY_Sync_IND	Physical Channel Identity	
CPHY_TrCH_Config_CNF	Physical Channel Identity	
CPHY_TrCH_Config_REQ	Physical Channel Identity	
CPHY_TrCH_Release_CNF	Physical Channel Identity	
CPHY_TrCH_Release_REQ	Physical Channel Identity	
CPHY_HS_DPCCH_AckNack_CNF	No Routing Info Field Present	Rel-5 or later
CPHY_HS_DPCCH_AckNack_REQ	No Routing Info Field Present	Rel-5 or later
CPHY_HS_DPCCH_AckNack_IND	No Routing Info Field Present	Rel-5 or later
CPHY_HS_DPCCH_CQI_CNF	No Routing Info Field Present	Rel-5 or later
CPHY_HS_DPCCH_CQI_REQ	No Routing Info Field Present	Rel-5 or later
CPHY_HS_DPCCH_CQI_IND	No Routing Info Field Present	Rel-5 or later
CPHY_HS_DPCCH_CQI_DC_CNF	No Routing Info Field Present	Rel-8 or later
CPHY_HS_DPCCH_CQI_DC_REQ	No Routing Info Field Present	Rel-8 or later
CPHY_HS_DPCCH_CQI_DC_IND	No Routing Info Field Present	Rel-8 or later
CPHY_HS_DSCH_CRC_Mode_CNF	Physical Channel Identity	Rel-5 or later
CPHY_HS_DSCH_CRC_Mode_REQ	Physical Channel Identity	Rel-5 or later
CPHY_HS_SICH_AckNack_CNF	No Routing Info Field Present	Rel-5 or later (LCR TDD)
CPHY_HS_SICH_AckNack_REQ	No Routing Info Field Present	Rel-5 or later (LCR TDD)
CPHY_HS_SICH_AckNack_IND	No Routing Info Field Present	Rel-5 or later (LCR TDD)
CPHY_HS_SICH_CQI_CNF	No Routing Info Field Present	Rel-5 or later (LCR TDD)
CPHY_HS_SICH_CQI_REQ	No Routing Info Field Present	Rel-5 or later (LCR TDD)
CPHY_HS_SICH_CQI_IND	No Routing Info Field Present	Rel-5 or later (LCR TDD)
CPHY_UL_PowerModify_CNF	Physical Channel Identity	
CPHY_UL_PowerModify_REQ	Physical Channel Identity	
CMAC_BMC_Scheduling_CNF	Physical Channel Identity	

Primitive name	Channel Identity	Releases
CMAC_BMC_Scheduling_REQ	Physical Channel Identity	
CMAC_Ciphering_Activate_CNF	Physical Channel Identity of DPCH	
CMAC_Ciphering_Activate_REQ	Physical Channel Identity of DPCH	
CMAC_Config_CNF	Physical Channel Identity	
CMAC_Config_REQ	Physical Channel Identity	
CMAC_FACH_MeasOccas_CNF	Physical Channel Identity	
CMAC_FACH_MeasOccas_REQ	Physical Channel Identity	
CMAC_PAGING_Config_CNF	Physical Channel Identity	
CMAC_PAGING_Config_REQ	Physical Channel Identity	
CMAC_Restriction_CNF	Physical Channel Identity	
CMAC_Restriction_REQ	Physical Channel Identity	
CMAC_SecurityMode_Config_CNF	No Routing Info Field Present (applies to all RB Ids)	
CMAC_SecurityMode_Config_REQ	No Routing Info Field Present (applies to all RB Ids)	
CMAC_SequenceNumber_CNF	Physical Channel Identity	
CMAC_SequenceNumber_REQ	Physical Channel Identity	
CMAC_SYSINFO_Config_CNF	RB Identity	
CMAC_SYSINFO_Config_REQ	RB Identity	
CMAC_MAChs_MACehs_Reset_CNF	No Routing Info Field Present	Rel-5 or later
CMAC_MAChs_MACehs_Reset_REQ	No Routing Info Field Present	Rel-5 or later
CMAC_MAChs_MACehs_HARQprocAssign_CNF	No Routing Info Field Present	Rel-5 or later
CMAC_MAChs_MACehs_HARQprocAssign_REQ	No Routing Info Field Present	Rel-5 or later
CMAC_MAChs_MACehs_TFRConfigure_CNF	No Routing Info Field Present	Rel-5 or later
CMAC_MAChs_MACehs_TFRConfigure_REQ	No Routing Info Field Present	Rel-5 or later
CMAC_MACehs_HS_SCCH_OrdersCNF	No Routing Info Field Present	Rel-7 or later
CMAC_MACehs_HS_SCCH_OrdersREQ	No Routing Info Field Present	Rel-7 or later
CMAC_MACe_Config_CNF	Node B Identity	Rel-6 or later
CMAC_MACe_Config_REQ	Node B Identity	Rel-6 or later
CMAC_MACe_NodeB_CellMapping_CNF	Node B Identity	Rel-6 or later
CMAC_MACe_NodeB_CellMapping_REQ	Node B Identity	Rel-6 or later
CMAC_MACi_NodeB_CellMapping_CNF	Node B Identity	Rel-8 or later
CMAC_MACi_NodeB_CellMapping_REQ	Node B Identity	Rel-8 or later
CMAC_MACes_Config_CNF	No Routing Info Field Present	Rel-6 or later
CMAC_MACes_Config_REQ	No Routing Info Field Present	Rel-6 or later
CMAC_MACis_Config_CNF	No Routing Info Field Present	Rel-8 or later
CMAC_MACis_Config_REQ	No Routing Info Field Present	Rel-8 or later
CMAC_MACi_Config_CNF	No Routing Info Field Present	Rel-8 or later
CMAC_MACi_Config_REQ	No Routing Info Field Present	Rel-8 or later
CMAC_MACe_AG_CNF	Node B Identity	Rel-6 or later
CMAC_MACe_AG_REQ	Node B Identity	Rel-6 or later
CMAC_MACi_AG_CNF	Node B Identity	Rel-8 or later
CMAC_MACi_AG_REQ	Node B Identity	Rel-8 or later
CMAC_MACe_AckNack_CNF	Node B Identity	Rel-6 or later
CMAC_MACe_AckNack_REQ	Node B Identity	Rel-6 or later
CMAC_MACi_AckNack_CNF	Node B Identity	Rel-8 or later
CMAC_MACi_AckNack_REQ	Node B Identity	Rel-8 or later
CMAC_MACe_RG_CNF	Node B Identity	Rel-6 or later
CMAC_MACe_RG_REQ	Node B Identity	Rel-6 or later
CMAC_MACi_RG_CNF	Node B Identity	Rel-8 or later
CMAC_MACi_RG_REQ	Node B Identity	Rel-8 or later
CMAC_MACe_E_TFC_Restriction_CNF	Node B Identity	Rel-6 or later
CMAC_MACe_E_TFC_Restriction_REQ	Node B Identity	Rel-6 or later
CMAC_MACi_E_TFC_Restriction_CNF	Node B Identity	Rel-8 or later
CMAC_MACi_E_TFC_Restriction_REQ	Node B Identity	Rel-8 or later
CMAC_MACes_SI_IND	No Routing Info Field Present	Rel-6 or later
CMAC_MACes_SI_Config_CNF	No Routing Info Field Present	Rel-6 or later
CMAC_MACis_SI_IND	No Routing Info Field Present	Rel-8 or later
CMAC_MACis_SI_Config_CNF	No Routing Info Field Present	Rel-8 or later
CMAC_MBMS_ConfigInfo_CNF	Physical Channel Identity	Rel-6 or later
CMAC_MBMS_ConfigInfo_REQ	Physical Channel Identity	Rel-6 or later
CRLC_Bind_TestData_TTI_CNF	No Routing Info Field Present	

Primitive name	Channel Identity	Releases
CRLC_Bind_TestData_TTI_REQ	No Routing Info Field Present	
CRLC_Ciphering_Activate_CNF	No Routing Info Field Present (applies to all RB Ids)	
CRLC_Ciphering_Activate_REQ	No Routing Info Field Present (applies to all RB Ids)	
CRLC_MAC_I_Mode_CNF	RB Identity	
CRLC_MAC_I_Mode_REQ	RB Identity	
CRLC_Config_CNF	RB Identity	
CRLC_Config_REQ	RB Identity	
CRLC_Integrity_Activate_CNF	No Routing Info Field Present (applies to all RB Ids)	
CRLC_Integrity_Activate_REQ	No Routing Info Field Present (applies to all RB Ids)	
CRLC_Integrity_Failure_IND	RB Identity	
CRLC_NotAckNxtRxSDU_CNF	RB Identity	
CRLC_NotAckNxtRxSDU_REQ	RB Identity	
CRLC_ProhibitRLC_Ack_CNF	RB Identity	
CRLC_ProhibitRLC_Ack_REQ	RB Identity	
CRLC_Resume_CNF	RB Identity (applies to all suspended RB Ids)	
CRLC_Resume_REQ	RB Identity (applies to all suspended RB Ids)	
CRLC_RRC_MessageSN_CNF	RB Identity	
CRLC_RRC_MessageSN_REQ	RB Identity	
CRLC_SecurityMode_Config_CNF	No Routing Info Field Present (applies to all RB Ids)	
CRLC_SecurityMode_Config_REQ	No Routing Info Field Present (applies to all RB Ids)	
CRLC_SendContinuousData_CNF	No Routing Info Field Present	
CRLC_SendContinuousData_REQ	No Routing Info Field Present	
CRLC_SendTestDataInOneMAC_Hs_PDU_CNF	RB Identity	Rel-5 or later
CRLC_SendTestDataInOneMAC_Hs_PDU_REQ	RB Identity	Rel-5 or later
CRLC_SequenceNumber_CNF	RB Identity	
CRLC_SequenceNumber_REQ	RB Identity	
CRLC_SetRRC_MessageSN_CNF	RB Identity	
CRLC_SetRRC_MessageSN_REQ	RB Identity	
CRLC_Set_Count_I_CNF	RB Identity	
CRLC_Set_Count_I_REQ	RB Identity	
CRLC_Status_Ind	RB Identity	
CRLC_Suspend_CNF	RB Identity	
CRLC_Suspend_REQ	RB Identity	
CRLC_MTCH_Scheduling_REQ	RB Identity	Rel-6 or later
CRLC_MTCH_Scheduling_CNF	RB Identity	Rel-6 or later
CBMC_Config_CNF	RB Identity	
CBMC_Config_REQ	RB Identity	
RLC_AM_DATA_CNF	RB Identity	
RLC_AM_DATA_IND	RB Identity	
RLC_AM_DATA_REQ	RB Identity	
RLC_TR_DATA_IND	RB Identity	
RLC_TR_DATA_REQ	RB Identity	
RLC_UM_ACCESSInfo_REQ	RB Identity	Rel-6 or later
RLC_UM_CriticalMCCHMsg_REQ	RB Identity	Rel-6 or later
RLC_UM_DATA_IND	RB Identity	
RLC_UM_DATA_REQ	RB Identity	
RLC_UM_MSCH_Msg_REQ	RB Identity	Rel-6 or later
RLC_TR_MACesDATA_IND	RB Identity	Rel-6 or later
RLC_TR_MACisDATA_IND	RB Identity	Rel-8 or later
TTCN Primitives		
RLC_AM_TestDataInd	RB Identity	
RLC_AM_TestDataReq	RB Identity	
RLC_TR_TestDataInd	RB Identity	
RLC_TR_TestDataReq	RB Identity	
RLC_UM_TestDataInd	RB Identity	
RLC_UM_TestDataReq	RB Identity	
BMC_DataReq	RB Identity	

8.2.1 Physical channels

Table 8.2.1: Physical channel identities

Type	Min. No.	Current Config.	Identities (value assigned)	Direction	Comment
P-CCPCH	1	1	tsc_P_CCPCH (4)	downlink	Primary Common Control Physical Channel. For Broadcasting System Information messages, using the Primary Scrambling Code for the Cell.
P-CPICH	1	1	tsc_P_CPICH (0)	downlink	Primary Common Pilot Channel using the Primary Scrambling Code for the Cell.
S-CPICH	1	1	tsc_S_CPICH (3)	downlink	Secondary Common Pilot Channel, used as the phase reference for some RF tests.
P-SCH	1	1	tsc_P_SCH (1)	downlink	Primary Synchronization Channel
S-SCH	1	1	tsc_S_SCH (2)	downlink	Secondary Synchronization Channel
S-CCPCH	3	1	tsc_S_CCPCH1 (5) tsc_S_CCPCH2 (10) tsc_S_CCPCH3 (13)	downlink	Secondary Common Control Physical Channel.
PICH	1	1	tsc_PICH1 (6) tsc_PICH2 (11)	downlink	To identify whether the UE should access the PCCH for Paging Messages.
AICH	1	1	tsc_AICH1 (7) tsc_AICH2 (12)	downlink	General Acquisition Indicator Channel, can be used for: <ul style="list-style-type: none"> - Acquisition Indicator Channel, for PRACH - Access Preamble Acquisition Indicator Channel (AP-ICH), for PCPCH - Collision-Detection/Channel-Assignment Indicator Channel (CD/CA-ICH), for PCPCH
DPCH	3	1	tsc_DL_DPCH1 (26) tsc_DL_DPCH2 (27)	downlink	Downlink Physical Data Channel. Layer 1 signalling is transmitted only on the first DPCH. This number is for the First Cell. Additional Cells may define a lower number which should be at least 1.
DPDCH	1	1	tsc_UL_DPCH1 (20) tsc_UL_DPCH2 (21)	uplink	Uplink Dedicated Physical Channel. A single DPCH associated with all the DPDCHs used for Layer 1 signalling.
PRACH	2	1	tsc_PRACH1 (8) tsc_PRACH2 (9)	uplink	Physical Random Access Channel.
PCPCH	1	FFS		uplink	Physical Common Packet Channel.
CSICH	1	FFS		downlink	CPCH Status Indicator Channel
HS-PDSCH	1		tsc_HSPDSCH(18)	downlink	Rel-5 or later High speed physical downlink shared channel
E-AGCH	1		tsc_E_AGCH (14)	downlink	Rel-6 or later E-DCH Absolute Grant Channel
E-HICH	1		tsc_E_HICH (15)	downlink	Rel-6 or later E-DCH HARQ Acknowledgement Indicator Channel
E-RGCH	1		tsc_E_RGCH (16)	downlink	Rel-6 or later E-DCH Relative Grant Channel
E-DPDCH	1		tsc_E_DPCH (22)	uplink	Rel-6 or later Enhanced Dedicated Physical Channel
F-DPCH	1		tsc_F_DPCH (28)	downlink	Rel-6 or later Fractional Dedicated Physical Channel
MICH	1		tsc_MICH (29)	downlink	Rel-6 or later MBMS notification Indicator Channel

The Physical Channel values 20 to 25 are assigned to uplink DPCHs and the values 26 to 31 are assigned to downlink DPCHs/ FDPCHs.

8.2.2 Transport channels

Table 8.2.2: Transport channel identities

Type	Min. No.	Current Config.	Identities (value assigned)	Direction	Comments
BCH	1	1	tsc_BCH1 (11)	downlink	
FACH	1	1	tsc_FACH1 (13) tsc_FACH2 (14) tsc_FACH3 (16) tsc_FACH4 (17) tsc_FACH5 (23)	downlink	
PCH	1	1	tsc_PCH1 (12) tsc_PCH2 (30)	downlink	
DCH	n	4	tsc_UL_DCH1 (1) tsc_UL_DCH2 (2) tsc_UL_DCH3 (3) tsc_UL_DCH4 (4) tsc_UL_DCH5 (5) tsc_UL_DCH6 (21)	uplink	tsc_UL_DCH1 for RAB1-1 or RAB1, tsc_UL_DCH2 for RAB1-2 or RAB2, tsc_UL_DCH3 for RAB1-3, tsc_UL_DCH4 RAB2, tsc_UL_DCH5 for SRB/RAB3, tsc_UL_DCH6 for SRB.
DCH	n	4	tsc_DL_DCH1 (6) tsc_DL_DCH2 (7) tsc_DL_DCH3 (8) tsc_DL_DCH4 (9) tsc_DL_DCH5 (10) tsc_DL_DCH6 (22)	downlink	tsc_DL_DCH1 for RAB1-1 or RAB1, tsc_DL_DCH2 for RAB1-2 or RAB2, tsc_DL_DCH3 for RAB1-3, tsc_DL_DCH4 for RAB2, tsc_DL_DCH5 for SRB, tsc_DL_DCH6 for SRB.
USCH	1	N/A	tsc_USCH1(20)	uplink	TDD only
DSCH	1	N/A	tsc_DSCH (19)	downlink	
RACH	2	1	tsc_RACH1 (15) tsc_RACH2 (31)	uplink	
CPCH	1	N/A	tsc_CPCH1(32)	uplink	
FAUSCH	N/A	N/A	tsc_FAUSCH1(18)	uplink	Not in Release 99
HSDSCH	1	1	N/A	downlink	Rel-5 or later
E-DCH	1	1	N/A	uplink	Rel-6 or later

8.2.2.1 Support of Default Configurations

In test cases using default configurations according to 3GPP TS 25.331 [21], clause 13.7, the configuration of the system simulator follows the same parameter values as defined for the UE side with the following exceptions:

- UL/DL transport channel ids;
- E-DCH MAC-d flow id / HS-DSCH MAC-d flow id.

As the transport channel identities and the MAC-d flow identities have the local significance, the TTCN implementations follow the test model.

8.2.3 Logical Channels

Table 8.2.3 shows the logical channels identities.

Table 8.2.3: Logical channel identities

Type	Min. No.	Current Config.	Identities (value assigned)	Direction	Comments
BCCH_BCH	1	1	tsc_BCCH1 (1)	downlink	
BCCH_FACH	1	1	tsc_BCCH6 (6)	downlink	
CCCH	1	1	tsc_DL_CCCH5 (5)	downlink	
CCCH	1	2	tsc_UL_CCCH5 (5) tsc_UL_CCCH6 (6)	uplink	
DCCH	4	4	tsc_DL_DCCH1 (1) tsc_DL_DCCH2 (2) tsc_DL_DCCH3 (3) tsc_DL_DCCH4 (4) tsc_DL_DCCH5 (5)	downlink	tsc_DL_DCCH1 for SRB1, tsc_DL_DCCH2 for SRB2, tsc_DL_DCCH3 for SRB3, tsc_DL_DCCH4 for SRB4, tsc_DL_DCCH5 for SRB5
DCCH	4	4	tsc_UL_DCCH1 (1) tsc_UL_DCCH2 (2) tsc_UL_DCCH3 (3) tsc_UL_DCCH4 (4)	uplink	tsc_UL_DCCH1 for SRB1, tsc_UL_DCCH2 for SRB2, tsc_UL_DCCH3 for SRB3, tsc_UL_DCCH4 for SRB4
PCCH	1	2	tsc_PCCH1 (1) tsc_PCCH2 (2) tsc_PCCH_FACH (11)	downlink	
DTCH	n	4	tsc_UL_DTCH1 (7) tsc_UL_DTCH2 (8) tsc_UL_DTCH3 (9) tsc_UL_DTCH4 (10) tsc_UL_DTCH5 (13)	uplink	tsc_UL_DTCH1 for RAB1-1 or RAB 1, tsc_UL_DTCH2 for RAB1-2 or RAB 2, tsc_UL_DTCH3 for RAB1-3' tsc_UL_DTCH4 for RAB2, tsc_UL_DTCH5 for RAB3
DTCH	n	4	tsc_DL_DTCH1 (7) tsc_DL_DTCH2 (8) tsc_DL_DTCH3 (9) tsc_DL_DTCH4 (10)	downlink	tsc_DL_DTCH1 for RAB1-1 or RAB 1, tsc_DL_DTCH2 for RAB1-2 or RAB 2, tsc_DL_DTCH3 for RAB-3, tsc_DL_DTCH4 for RAB2
CTCH	1	2	tsc_CTCH1 (11) tsc_CTCH2 (12)	downlink	
MTCH	1	4	tsc_MTCH1(1) tsc_MTCH2(2) tsc_MTCH3(3) tsc_MTCH4(4)	downlink	MBMS_LogicalChIdentity
MCCH	1	1	tsc_MCCH1(1)	downlink	One and only one for each cell
MSCH	0	1	tsc_MSCH1(1)	downlink	

8.2.4 Radio bearers

Table 8.2.4.1: Radio Bearers

Identities (value assigned)	Direction	Type	RLC mode	Service domain	Comments
tsc_RB_BCCH (-1)	downlink		TM	NA	BCCH-BCH
tsc_RB_PCCH (-2)	downlink		TM	NA	PCCH PCH
tsc_RB_BCCH_FACH (-3)	downlink		TM	NA	BCCH FACH
tsc_RB_2ndPCCH (-4)	downlink		TM	NA	Second PCCH PCH SCPCCH
tsc_RB_2ndCCCH (-5)	uplink		TM	NA	Second CCCH RACH PRACH
tsc_RB_MTCH_RLC_TR (-6)	downlink		TM	PS	Rel-6 or later For TM MTCH RLC tests
tsc_RB_UM_7_RLC (-10)	downlink	RAB	TM	CS	For UM RLC tests using 7 bit LIs
tsc_RB_UM_7_RLC (-10)	uplink	RAB	TM	CS	For UM RLC tests using 7 bit LIs
tsc_RB_UM_15_RLC (-11)	downlink	RAB	TM	CS	For UM RLC tests using 15 bit LIs
tsc_RB_UM_15_RLC (-11)	uplink	RAB	TM	CS	For UM RLC tests using 15 bit LIs
tsc_RB_AM_7_RLC (-12)	downlink	RAB	TM	CS	For AM RLC tests using 7 bit LIs
tsc_RB_AM_7_RLC (-12)	uplink	RAB	TM	CS	For AM RLC tests using 7 bit LIs
tsc_RB_AM_15_RLC (-13)	downlink	RAB	TM	CS	For AM RLC tests using 15 bit LIs

Identities (value assigned)	Direction	Type	RLC mode	Service domain	Comments
tsc_RB_AM_15_RLC (-13)	uplink	RAB	TM	CS	For AM RLC tests using 15 bit LIs
tsc_RB_DCCH_FACH_MAC (-14)	downlink	SRB3	TM	CS	For MAC tests using DCCH mapped to FACH
tsc_RB_DCCH_FACH_MAC (-14)	uplink	SRB3	TM	CS	For MAC tests using DCCH mapped to FACH
tsc_RB_DCCH_DCH_MAC (-15)	downlink	SRB3	TM	CS	For MAC tests using DCCH mapped to DCH
tsc_RB_DCCH_FACH_MAC (-15)	uplink	SRB3	TM	CS	For MAC tests using DCCH mapped to DCH
tsc_RB3_DCCH_RRC_(-16)	uplink	SRB3	AM	CS or PS	For RRC test cases to route UL NAS messages
tsc_RB_CCCH_FACH_MAC (-18)	downlink	SRB0	TM	CS or PS	For MAC test using downlink SRB0 on TM
tsc_RB_BCCH_FACH_RAB (-19)	downlink		TM	NA	BCCH FACH
tsc_RB_DTCH_E_DCH_MAC(-20)	uplink	RAB	TM	PS	For MAC_es_e tests
tsc_RB_DTCH_E_DCH_MAC1(-21)	uplink	RAB	TM	PS	For MAC_es_e tests
tsc_RB_DTCH_E_DCH_MAC2(-22)	uplink	RAB	TM	PS	For MAC_es_e tests
tsc_RB_MAC_HS(-25)	uplink	RAB	TM	PS	For MAC_hs/ehs tests
tsc_RB_MAC_HS(-25)	downlink	RAB	TM	PS	For MAC_hs/ehs tests
tsc_RB_MAC_ehs_26 (-26)	uplink	RAB	TM	PS	For MAC_ehs tests
tsc_RB_MAC_ehs_26 (-26)	downlink	RAB	TM	PS	For MAC_ehs tests
tsc_RB_MAC_ehs_27(-27)	uplink	RAB	TM	PS	For MAC_ehs tests
tsc_RB_MAC_ehs_27(-27)	downlink	RAB	TM	PS	For MAC_ehs tests
tsc_RB0 (0)	uplink	SRB0	TM	CS or PS	The service domain for which the most recent security negotiation took place. CCCH
tsc_RB0 (0)	downlink	SRB0	UM	CS or PS	CCCH
tsc_RB1 (1)	uplink	SRB1	UM	CS or PS	DCCH
tsc_RB1 (1)	downlink	SRB1	UM	CS or PS	DCCH
tsc_RB2 (2)	uplink	SRB2	AM	CS or PS	DCCH
tsc_RB2 (2)	downlink	SRB2	AM	CS or PS	DCCH
tsc_RB3 (3)	uplink	SRB3	AM	CS or PS	DCCH
tsc_RB3 (3)	downlink	SRB3	AM	CS or PS	DCCH
tsc_RB4 (4)	uplink	SRB4	AM	CS or PS	DCCH
tsc_RB4 (4)	downlink	SRB4	AM	CS or PS	DCCH
tsc_RB5 (5)	uplink		TM		DCCH
tsc_RB5 (5)	downlink		TM		DCCH
tsc_RB_MCCH(8)	downlink	SRB	UM	PS	Rel-6 or later
tsc_RB_MCCH_RLC_TR(-8)	downlink	SRB	TM	PS	Rel-6 or later
tsc_RB_MSCH(9)	downlink	SRB	UM	PS	Rel-6 or later
tsc_RB10 (10)	uplink	RAB#1-1	TM	CS	or RAB1
tsc_RB10 (10)	downlink	RAB#1-1	TM	CS	or RAB1
tsc_RB11 (11)	uplink	RAB#1-2	TM	CS	or RAB2
tsc_RB11 (11)	downlink	RAB#1-2	TM	CS	or RAB2
tsc_RB12 (12)	uplink	RAB#1-3	TM	CS	
tsc_RB12 (12)	downlink	RAB#1-3	TM	CS	
tsc_RB13 (13)	uplink	RAB#2	TM	CS	
tsc_RB13 (13)	downlink	RAB#2	TM	CS	
tsc_RB_MTCH1(14)	downlink	RAB	UM	PS	Rel-6 or later, media contents
tsc_RB_MTCH2(15)	downlink	RAB	UM	PS	Rel-6 or later, media contents
tsc_RB_MTCH3(16)	downlink	RAB	UM	PS	Rel-6 or later, media contents
tsc_RB17 (17)	uplink	RAB#2	AM	PS	Rel-5 or later, 2nd AM RAB for HS
tsc_RB17 (17)	downlink	RAB#2	AM	PS	Rel-5 or later, 2nd AM RAB for HS
tsc_RB20 (20)	uplink	RAB#1	AM	PS	
tsc_RB20 (20)	downlink	RAB#1	AM	PS	
tsc_RB21 (21)	uplink	RAB#2	UM	PS	
tsc_RB21 (21)	downlink	RAB#2	UM	PS	
tsc_RB22 (22)	uplink	RAB#2	AM	PS	
tsc_RB22 (22)	downlink	RAB#2	AM	PS	
tsc_RB23 (23)	uplink	RAB#2	AM	PS	2nd AM RAB for PS
tsc_RB23 (23)	downlink	RAB#2	AM	PS	2nd AM RAB for PS
tsc_RB24 (24)	uplink	RAB#2	AM	PS	2nd AM RAB for PS
tsc_RB24 (24)	downlink	RAB#2	AM	PS	2nd AM RAB for PS

Identities (value assigned)	Direction	Type	RLC mode	Service domain	Comments
tsc_RB25 (25)	uplink	RAB#1	AM	PS	Rel-5 or later: DTCH on DPCH associated HS- DSCH Rel-6 or later: DTCH on E-DCH
tsc_RB25 (25)	downlink	RAB#1	AM	PS	Rel-5 or later DTCH on HS-DSCH
tsc_RB26 (26)	uplink	RAB#1	UM	PS	Rel-5 or later
tsc_RB26 (26)	downlink	RAB#1	UM	PS	Rel-5 or later
tsc_RB27 (27)	uplink	RAB#2	UM	PS	Rel-5 or later
tsc_RB27 (27)	downlink	RAB#2	UM	PS	Rel-5 or later
tsc_RB28 (28)	uplink	RAB#3	AM	PS	Rel-5 or later
tsc_RB28 (28)	downlink	RAB#3	AM	PS	Rel-5 or later
tsc_RB29 (29)	downlink	SRB0	AM	PS	RB Id for Radio bearer that carries the 2nd CCCH in the DL
tsc_RB30 (30)	downlink		UM		CTCH FACH
tsc_RB31 (31)	downlink		UM		Second CTCH FACH

The RB values 0 to 5 are used for the signalling bearers. The values 10 to 15 are assigned to the CS RAB sub-flows. The values 15 to 29 are assigned to the PS RAB sub-flows. The value 30 is assigned to the CBSMS/BMC service.

Table 8.2.4.2: RB identities mapping between 34.123-1 & 34.123-3

RAB Combinations	34.123-1	34.123-3
Single CS RAB	RB5	tsc_RB10
	RB6	tsc_RB11
	RB7	tsc_RB12
Single PS RAB	RB5	tsc_RB20
	RB7	tsc_RB20
	RB8	tsc_RB20
CS+PS Multi RABs	RB5	tsc_RB10
	RB6	tsc_RB11, tsc_RB20
	RB7	tsc_RB12
	RB8	tsc_RB20
CS+CS Multi RABs	RB9	tsc_RB22
	RB5	tsc_RB10
	RB6	tsc_RB11
	RB7	tsc_RB12
PS+PS Multi RABs	RB8	tsc_RB13
	RB5	tsc_RB20
	RB6	tsc_RB22
	RB7	tsc_RB20
Single PS (HSDPA/HSUPA) RAB	RB8	tsc_RB24
	RB5	tsc_RB25
	RB5	tsc_RB26
	RB6	tsc_RB27
	RB7	tsc_RB25
PS+PS Multi (HSDPA) RABs	RB8	tsc_RB28
	RB9	tsc_RB17
	RB5	tsc_RB25
	RB5	tsc_RB10
	RB6	tsc_RB11, tsc_RB25
CS + PS Multi (HSDPA/HSUPA) RABs	RB7	tsc_RB12
	RB8	tsc_RB25
	RB9	tsc_RB17
	RB5	tsc_RB10
	RB6	tsc_RB11
PS (HSUPA) + Speech Multi RABs	RB7	tsc_RB12
	RB8	tsc_RB25
	RB5	tsc_RB25
	RB6	tsc_RB17
PS AM + PS AM Multi (HSUPA) RABs	RB5	tsc_RB25
	RB6	tsc_RB17
PS UM + PS AM Multi (HSUPA) RABs	RB5	tsc_RB27
	RB6	tsc_RB25

RAB Combinations	34.123-1	34.123-3
PS UM + PS AM + PS AM Multi (HSUPA) RABs	RB5	tsc_RB27
	RB6	tsc_RB25
	RB7	tsc_RB17

8.2.5 Scrambling and channelization codes

Table 8.2.5.1 shows the primary/secondary scrambling codes and the channelization codes for downlink channels.

Table 8.2.5.1: Primary/secondary scrambling codes and channelization codes for downlink channels

Type	Identities (value assigned)	Primary scrambling code	Secondary scrambling code	Channelization Code
P-CCPCH	tsc_P_CCPCH (4)	$(px_PriScrmCode + 50 \times (\text{cell No} - 1)) \bmod 512$, $(px_PriScrmCode + 20 + 50 \times (\text{cell No} - 21)) \bmod 512$ for MBMS testing	NA	tsc_P_CCPCH_ChC (256:1)
P-CPICH	tsc_P_CPICH (0)	$(px_PriScrmCode + 50 \times (\text{cell No} - 1)) \bmod 512$, $(px_PriScrmCode + 20 + 50 \times (\text{cell No} - 21)) \bmod 512$ for MBMS testing	NA	tsc_P_CPICH_ChC (256:0)
S-CPICH	tsc_S_CPICH (3)	$(px_PriScrmCode + 50 \times (\text{cell No} - 1)) \bmod 512$	NA	tsc_S_CPICH_ChC (256:12)
S-CCPCH	tsc_S_CCPCH1 (5)	$(px_PriScrmCode + 50 \times (\text{cell No} - 1)) \bmod 512$, $(px_PriScrmCode + 20 + 50 \times (\text{cell No} - 21)) \bmod 512$ for MBMS testing	NA (carrying PCH)	tsc_S_CCPCH1_ChC (64:1 or 4 or 6 depending on the channels configuration) tsc_S_CCPCH1_ChC_MBMS (64:1) for MBMS testing
	tsc_S_CCPCH2 (10)	$(px_PriScrmCode + 50 \times (\text{cell No} - 1)) \bmod 512$, $(px_PriScrmCode + 20 + 50 \times (\text{cell No} - 21)) \bmod 512$ for MBMS testing	NA (carrying PCH)	tsc_S_CCPCH2_ChC (64:1) tsc_S_CCPCH2_ChC_MBMS (256:9) for MBMS testing
	tsc_S_CCPCH3 (13)	$(px_PriScrmCode + 50 \times (\text{cell No} - 1)) \bmod 512$, $(px_PriScrmCode + 20 + 50 \times (\text{cell No} - 21)) \bmod 512$ for MBMS testing	NA (carrying PCH)	tsc_S_CCPCH3_ChC (64:2) tsc_S_CCPCH3_ChC_MBMS (8:1 or 16:1 or 32:2 depending on the channels configuration) for MBMS testing
PICH	tsc_PICH1 (6)	$(px_PriScrmCode + 50 \times (\text{cell No} - 1)) \bmod 512$, $(px_PriScrmCode + 20 + 50 \times (\text{cell No} - 21)) \bmod 512$ for MBMS testing	NA	tsc_PICH1_ChC (256:2)
	tsc_PICH2 (11)	$(px_PriScrmCode + 50 \times (\text{cell No} - 1)) \bmod 512$, $(px_PriScrmCode + 20 + 50 \times (\text{cell No} - 21)) \bmod 512$ for MBMS testing	NA	tsc_PICH2_ChC (256:12)
AICH	tsc_AICH1 (7)	$(px_PriScrmCode + 50 \times (\text{cell No} - 1)) \bmod 512$, $(px_PriScrmCode + 20 + 50 \times (\text{cell No} - 21)) \bmod 512$ for MBMS testing	NA	tsc_AICH1_ChC (256:3)
	tsc_AICH2 (12)	$(px_PriScrmCode + 50 \times (\text{cell No} - 1)) \bmod 512$, $(px_PriScrmCode + 20 + 50 \times (\text{cell No} - 21)) \bmod 512$ for MBMS testing	NA	tsc_AICH2_ChC (256:13)

Type	Identities (value assigned)	Primary scrambling code	Secondary scrambling code	Channelization Code
DPCH	tsc_DL_DPCH1 (26)	$(px_PriScrmCode + 50 \times (\text{cell No } -1)) \bmod 512,$ $(px_PriScrmCode+20+ 50 \times (\text{cell No } -21)) \bmod 512$ for MBMS testing	tsc_DL_DPCH1_2ndScrC (1) This value is related to the primary scrambling code of the cell	Depending on the configuration: tsc_DL_DPCH1_ChC_SRB (128:9) tsc_DL_DPCH1_ChC_Speech (128:0) tsc_DL_DPCH1_ChC_Streaming (32:0) tsc_DL_DPCH1_ChC_64k_CS (32:0) tsc_DL_DPCH1_ChC_64k_PS (32:0)
	tsc_DL_DPCH2 (27)	$(px_PriScrmCode + 50 \times (\text{cell No } -1)) \bmod 512,$ $(px_PriScrmCode+20+ 50 \times (\text{cell No } -21)) \bmod 512$ for MBMS testing	tsc_DL_DPCH2_2ndScrC (1) This value is related to the primary scrambling code of the cell	Depending on the configuration: tsc_DL_DPCH2_ChC_SRB (256:1) tsc_DL_DPCH2_ChC_Speech (128:1) tsc_DL_DPCH2_ChC_Streaming (32:1) tsc_DL_DPCH2_ChC_64k_CS (32:1) tsc_DL_DPCH2_ChC_64k_PS (32:1)
HS- PDSCH	tsc_HSPDSCH(18)	Same as HS-SCCH	Same as HS-SCCH	Rel-5 or later SF= 16 Number of codes depending on the configuration, at most 15 codes
HS-SCCH	NA	$(px_PriScrmCode + 50 \times (\text{cell No } -1)) \bmod 512,$ $(px_PriScrmCode+20+ 50 \times (\text{cell No } -21)) \bmod 512$ for MBMS testing	-	Rel-5 or later tsc_HS_SCCH_ChC (128:7)
E-AGCH	tsc_E_AGCH (14)	$(px_PriScrmCode + 50 \times (\text{cell No } -1)) \bmod 512,$ $(px_PriScrmCode+20+ 50 \times (\text{cell No } -21)) \bmod 512$ for MBMS testing	NA	Rel-6 or later
E-HICH	tsc_E_HICH (15)	$(px_PriScrmCode + 50 \times (\text{cell No } -1)) \bmod 512,$ $(px_PriScrmCode+20+ 50 \times (\text{cell No } -21)) \bmod 512$ for MBMS testing	NA	Rel-6 or later
E-RGCH	tsc_E_RGCH (16)	$(px_PriScrmCode + 50 \times (\text{cell No } -1)) \bmod 512,$ $(px_PriScrmCode+20+ 50 \times (\text{cell No } -21)) \bmod 512$ for MBMS testing	NA	Rel-6 or later
F-DPCH	tsc_F_DPCH (28)	$(px_PriScrmCode + 50 \times (\text{cell No } -1)) \bmod 512,$ $(px_PriScrmCode+20+ 50 \times (\text{cell No } -21)) \bmod 512$ for MBMS testing	NA	Rel-6 or later
MICH	tsc_MICH (29)	$(px_PriScrmCode+ 50 \times (\text{cell No } -1)) \bmod 512,$ $(px_PriScrmCode+20+ 50 \times (\text{cell No } -21)) \bmod 512$ for MBMS testing	NA	tsc_MICH_ChC (256:8)

Table 8.2.5.2 shows the scrambling codes, the signatures and the spreading factors for uplink channels.

Table 8.2.5.2: Scrambling codes, signatures and spreading factor for uplink channels

Type	Identities (value assigned)	Scrambling code	Signature	Spreading factor
DPDCH	tsc_UL_DPCH1 (20)	$(px_UL_ScramblingCode + 1000 \times (\text{cell No} - 1)) \text{ MOD } 16777216$	NA	If only one DPDCH and depending on the configuration tsc_UL_DPDCH_SF_SRB (64) tsc_UL_DPDCH_SF_Speech (64) tsc_UL_DPDCH_SF_Streaming (16) tsc_UL_DPDCH_SF_64k_CS (16) tsc_UL_DPDCH_SF_64k_PS (16) If more than one DPDCH tsc_UL_DPDCH_SF_4 (4:1)
	tsc_UL_DPCH2 (21)	$(px_UL_ScramblingCode + 1\ 000 \times (\text{cell No} - 1)) \text{ MOD } 16\ 777\ 216$	NA	If only one DPDCH and depending on the configuration tsc_UL_DPDCH_SF_SRB (64) tsc_UL_DPDCH_SF_Speech (64) tsc_UL_DPDCH_SF_Streaming (16) tsc_UL_DPDCH_SF_64k_CS (16) tsc_UL_DPDCH_SF_64k_PS (16) If more than one DPDCH tsc_UL_DPDCH_SF_4 (4:1)
PRACH	tsc_PRACH1 (8)	tsc_PRACH1_ScrC (0)	tsc_PRACH1_Signatures ('0000000011111111'B)	tsc_PRACH1_SF (64)
	tsc_PRACH2 (9)	tsc_PRACH2_ScrC (1)	tsc_PRACH2_Signatures ('0000000011111111'B)	tsc_PRACH2_SF (64)
HS-DPCCH	NA	Same as DPDCH	NA	Rel-5 or later Depending on the number of DPDCHs: If only one DPDCH: $C_{256,64}$; If 2 or 4 or 6 DPDCHs: $C_{256,1}$; If 3 or 5 DPDCHs: $C_{256,32}$.
E-DPCH	tsc_E_DPCH (22)	Same as DPDCH	NA	Rel-6 or later

8.2.6 MAC-d

MAC-d and the served RLC are cell-independent and are configured by using the cell-id = -1. During reconfigurations, cell changes and state transitions, the relevant counters in the RLC and MAC-d are maintained.

For the active set updating, the DL DCH with the same channel Id in the different cells are implicitly connected to form the DL multiple paths.

8.2.6.1 MAC-d configuration examples

The following example shows how the MAC and RLC ASP are used to configure different configurations.

The 1st parameter in ASP represents the cell identity: p_CellId corresponds to the current cell identity, tsc_CellDedicated corresponds to the cell independent (-1). The 2nd parameter represents the channel Id, this parameter is not needed in the CRLC ASP).

1. Cell_DCH_StandAloneSRB: configuration of DL/UL-DPCH1

```
CPHY!CPHY_RL_Setup_REQ      ( p_CellId, tsc_DL_DPCH1)      -- Cell concerned
CPHY?CPHY_RL_Setup_CNF      ( p_CellId, tsc_DL_DPCH1)      -- Cell concerned
CPHY!CPHY_TrCH_Config_REQ   ( p_CellId, tsc_DL_DPCH1)      -- Cell concerned
CPHY?CPHY_TrCH_Config_CNF   ( p_CellId, tsc_DL_DPCH1 )      -- Cell concerned
CMAC ! CMAC_Config_REQ      ( tsc_CellDedicated, tsc_DL_DPCH1) -- Cell independent (-1)
CMAC ? CMAC_Config_CNF      ( tsc_CellDedicated, tsc_DL_DPCH1) -- Cell independent (-1)
CPHY!CPHY_RL_Setup_REQ      ( p_CellId, tsc_UL_DPCH1)      -- Cell concerned
CPHY?CPHY_RL_Setup_CNF      ( p_CellId, tsc_UL_DPCH1)      -- Cell concerned
CPHY!CPHY_TrCH_Config_REQ   ( p_CellId, tsc_UL_DPCH1 )      -- Cell concerned
CPHY?CPHY_TrCH_Config_CNF   ( p_CellId, tsc_UL_DPCH1 )      -- Cell concerned
CMAC ! CMAC_Config_REQ      ( tsc_CellDedicated, tsc_UL_DPCH1) -- Cell independent (-1)
CMAC ? CMAC_Config_CNF      ( tsc_CellDedicated, tsc_UL_DPCH1 ) -- Cell independent (-1)
CRLC ! CRLC_Config_REQ      ( tsc_CellDedicated )      -- Cell independent (-1)
CRLC ? CRLC_Config_CNF      ( tsc_CellDedicated )      -- Cell independent (-1)
```

2. Cell_FACH: configuration of S-CCPCH1

```
CPHY!CPHY_RL_Setup_REQ      ( p_CellId, tsc_S_CCPCH1)      -- Cell concerned
CPHY?CPHY_RL_Setup_CNF      ( p_CellId, tsc_S_CCPCH1)      -- Cell concerned t
CPHY!CPHY_TrCH_Config_REQ   ( p_CellId, tsc_S_CCPCH1)      -- Cell concerned
CPHY ? CPHY_TrCH_Config_CNF ( p_CellId, tsc_S_CCPCH1)      -- Cell concerned
CMAC ! CMAC_Config_REQ      ( p_CellId, tsc_S_CCPCH1) -- Cell concerned
CMAC ? CMAC_Config_CNF      ( p_CellId, tsc_S_CCPCH1 ) -- Cell concerned
CPHY!CPHY_RL_Setup_REQ      ( p_CellId, tsc_PICH1)      -- Cell concerned
CPHY?CPHY_RL_Setup_CNF      ( p_CellId, tsc_PICH1)      -- Cell concerned
CRLC ! CRLC_Config_REQ      ( tsc_CellDedicated )      -- Cell independent (-1)
CRLC ? CRLC_Config_CNF      ( tsc_CellDedicated )      -- Cell independent (-1)
```

3. Cell_FACH: configuration of P-CCPCH

```
CPHY!CPHY_RL_Setup_REQ      ( p_CellId, tsc_P_CPICH )      -- Cell concerned
CPHY?CPHY_RL_Setup_CNF      ( p_CellId, tsc_P_CPICH )      -- Cell concerned
CPHY!CPHY_RL_Setup_REQ      ( p_CellId, tsc_P_SCH)      -- Cell concerned
CPHY?CPHY_RL_Setup_CNF      ( p_CellId, tsc_P_SCH )      -- Cell concerned
CPHY!CPHY_RL_Setup_REQ      ( p_CellId, tsc_P_SCH)      -- Cell concerned
CPHY?CPHY_RL_Setup_CNF      ( p_CellId, tsc_S_SCH )      -- Cell concerned
CPHY!CPHY_RL_Setup_REQ      ( p_CellId, tsc_P_CCPCH)      -- Cell concerned
CPHY?CPHY_RL_Setup_CNF      ( p_CellId, tsc_P_CCPCH )      -- Cell concerned
CPHY!CPHY_TrCH_Config_REQ   ( p_CellId, tsc_P_CCPCH )      -- Cell concerned
CPHY?CPHY_TrCH_Config_CNF   ( p_CellId, tsc_P_CCPCH )      -- Cell concerned
CMAC!CMAC_Config_REQ      ( p_CellId, tsc_P_CCPCH)      -- Cell concerned
CMAC?CMAC_Config_CNF      ( p_CellId, tsc_P_CCPCH )      -- Cell concerned
CRLC! CRLC_Config_REQ      ( p_CellId)      -- Cell concerned
CRLC? CRLC_Config_CNF      ( p_CellId)      -- Cell concerned
```

8.2.7 Configuration of compressed mode

8.2.7.1 UE Side

Two IE are available for the configuration of the compressed mode for the UE.

- a) DPCH_CompressedModeInfo.
- b) DPCH_CompressedModeStatusInfo.

Compressed mode initiation at UE side can be divided into 2 steps:

- a) Downloading compressed mode parameters.
- b) Activating the compressed mode.

Both of them can be done in one shot.

8.2.7.2 SS Side

Compressed mode configuration at SS side shall be maintained the same status as that on the UE side. So there are 3 different types of compressed mode configuration states both on UE and SS side.

- Configuration of compressed mode parameters (Use of DPCH_CompressedModeInfo) without the activation.
- Configuration of compressed mode parameters and simultaneous activation (use of DPCH_CompressedModeInfo).
- Only activation (use of DPCH_CompressedModeStatusInfo).

If compressed mode parameters are to be downloaded to the UE without actually activation, it shall be configured on the SS side by any one of the following two procedures.

- If DPCH channel on which compressed mode is to be downloaded is not already configured, primitive "CPHY_RL_Setup_REQ", with "CphyRISetupReq. PhysicalChannelInfo" which is of choice, chosen to dPCHInfo shall be called. The procedure is used to pre-configure all compressed patterns necessary for test, but deactivate the all patterns configured at the beginning of the test. This procedure has not been implemented in the TTCN.
- If DPCH channel on which compressed mode is to be downloaded is already configured, the primitive "CPHY_RL_Modify_REQ" with "CphyRIModifyReq. PhysicalChannelInfo" which is of choice, chosen to dPCHInfo shall be called. This procedure is generally used in the TTCN.

If compressed mode parameters are to be configured and simultaneously activated, the same procedure as for the configuration of compressed mode without activation shall be used.

Activation of the compressed mode, whose parameters are already configured shall be achieved by the primitive "CPHY_RL_Modify_REQ" with "CphyRIModifyReq. PhysicalChannelInfo" which is of choice, chosen to dpch_CompressedModeStatusInfo.

8.2.8 Use of U-RNTI and C-RNTI

The uRNTI and cRNTI are optional when configuring the MAC (CMAC_Config_REQ). Table 8.2.8.1 gives indication on when uRNTI and cRNTI are needed.

Table 8.2.8.1: cRNTI and uRNTI in CMAC-Config_REQ

	P-CCPCH	S-CCPCH with mapped DL-DCCH/DTCH (UE in cell_FACH)	S-CCPCH without mapped DL-DCCH/DTCH (UE in cell_DCH)	PRACH with mapped DL-DCCH/DTCH (UE in cell_FACH)	PRACH without mapped DL-DCCH/DTCH (UE in cell_DCH)	DPCH
uRNTI	-	Included	-	Omit	-	-
cRNTI	-	Included	-	Included	-	-
CMAC-Config_REQ	OMIT both	Download cRNTI and uRNTI	OMIT both	Download cRNTI	OMIT both	OMIT both

In the case of DL-DCCH/DTCH mapped on S-CCPCH, cRNTI and uRNTI are downloaded to the MAC layer. As default, SS MAC shall use cRNTI as UE id. At the CMAC configuration of the beginning of test cases, the RLC payload size is configured, as default on cRNTI for the MAC header calculation. If uRNTI is to be used the SS RLC payload size shall be reconfigured as cRNTI and uRNTI do not have the same length (16 bits and 32 bits respectively).

CELL UPDATE CONFIRM or URA UPDATE CONFIRM shall be sent on DCCH at the test for the ciphering reason except the periodic update without carrying the UE identity information. In this case the CELL UPDATE CONFIRM or URA UPDATE CONFIRM is sent on CCCH at the test.

Table 8.2.8.2: Relationship between cell update cause, UE state and RLC size reconfiguration

Cell update cause	UE State (before cell update)	CELL UPDATE CONFIRM	CRLC_Reconf RLC_Size Needed	Valid UE ID
Cell reselection	CELL_PCH / CELL_FACH	DCCH	Y	U_RNTI
Periodical cell update	CELL_PCH	DCCH or CCCH	Y (for DCCH)	U_RNTI
Periodical cell update	CELL_FACH	DCCH or CCCH	N	C_RNTI
Uplink data transmission	CELL_PCH / URA_PCH	DCCH	Y	U_RNTI
UTRAN paging response	CELL_PCH / URA_PCH	DCCH	Y	U_RNTI
Re-entered service area	CELL_PCH / URA_PCH	DCCH	Y	U_RNTI
Re-entered service area	CELL_FACH	DCCH	N	C_RNTI
Radio Link failure	CELL_DCH	DCCH	Y	U_RNTI
RLC_unrecoverable error	CELL_DCH / CELL_FACH	DCCH	Y N (selected the same cell in CELL_FACH)	U_RNTI C_RNTI

8.3 Channels configurations

8.3.1 Configuration of Cell_FACH

The configuration is based on 3GPP TS 34.108 [3], clause 6.10.2.4.3.2.1.2 for downlink and 3GPP TS 34.108 [3], clause 6.10.2.4.4.1.1.1 for uplink. The configuration is applied to the RRC tests related in the states CELL_FACH, CELL_PCH and URA_PCH. They need a minimum radio configuration for testing.

Table 8.3.1.1: Uplink configuration of Cell_FACH

RB Identity	tsc_RB20 (20)	tsc_RB0 (0)	tsc_RB1 (1)	tsc_RB2 (2)	tsc_RB3 (3)	tsc_RB4 (4)
LogCh Type	DTCH	CCCH	DCCH	DCCH	DCCH	DCCH
LogCh Identity	Tsc_UL_DTCH1 (7)	tsc_UL_CCCH5 (5)	tsc_UL_DCCH1 (1)	tsc_UL_DCCH2 (2)	tsc_UL_DCCH3 (3)	tsc_UL_DCCH4 (4)
RLC mode	AM	TM	UM	AM	AM	AM
TrCH Type	RACH					
TrCH identity	tsc_RACH1 (15)					
PhyCh Type	PRACH					
PhyCH identity	tsc_PRACH1 (8)					

Table 8.3.1.2: Downlink configuration of Cell_FACH

RB Identity	tsc_RB20 (20)	tsc_RB0 (0)	tsc_RB1 (1)	tsc_RB2 (2)	tsc_RB3 (3)	tsc_RB4 (4)	tsc_RB_BC CH_FACH (-3)	tsc_RB_PC CH (-2)
LogCh Type	DTCH	CCCH	DCCH	DCCH	DCCH	DCCH	BCCH	PCCH
LogCh Identity	tsc_DL_DT CH1 (7)	tsc_DL_CC CH5 (5)	tsc_DL_DC CH1 (1)	tsc_DL_DC CH2 (2)	tsc_DL_DC CH3 (3)	tsc_DL_DC CH4 (4)	tsc_BCCH6 (6)	tsc_PCCH1 (1)
RLC mode	AM	UM	UM	AM	AM	AM	TM	TM
MAC priority	1	1	2	3	4	5	6	1
TrCH Type	FACH	FACH						PCH
TrCH identity	tsc_FACH2 (14)	tsc_FACH1 (13)						tsc_PCH1 (12)
PhyCh Type	Secondary CCPCH							
PhyCH identity	tsc_S_CCPCH1 (5)							

8.3.2 Configuration of Cell_DCH_StandAloneSRB

The configuration is based on 3GPP TS 34.108 [3], clause 6.10.2.4.1. 3. The RB0/UM-CCCH is referred to 3GPP TS 34.108 [3], clause 6.10.2.4.3.2.1.2 and RB0/TM-CCCH is referred to 3GPP TS 34.108 [3], clause 6.10.2.4.4.1.1.1. The configuration is applied to the RRC and NAS signalling tests in the DCH state without RAB.

Table 8.3.2.1: Uplink configuration of Cell_DCH_StandAloneSRB

RB Identity	tsc_RB1 (1)	tsc_RB2 (2)	tsc_RB3 (3)	tsc_RB4 (4)	tsc_RB0 (0)	
LogCh Type	DCCH	DCCH	DCCH	DCCH	CCCH	
LogCh Identity	tsc_UL_DCCH1 (1)	tsc_UL_DCCH2 (2)	tsc_UL_DCCH3 (3)	tsc_UL_DCCH4 (4)	tsc_UL_CCCH5 (5)	
RLC mode	UM	AM	AM	AM	TM	
TrCH Type	DCH				RACH	
TrCH identity	tsc_UL_DCH5 (5)				tsc_RACH1 (15)	
PhyCh Type	DPDCH				PRACH	
PhyCH identity	tsc_UL_DPCH1 (20)				tsc_PRACH1 (8)	

Table 8.3.2.2: Downlink configuration of Cell_DCH_StandAloneSRB

RB Identity	tsc_RB1 (1)	tsc_RB2 (2)	tsc_RB3 (3)	tsc_RB4 (4)	tsc_RB0 (0)	tsc_RB_PCCH (-2)	
LogCh Type	DCCH	DCCH	DCCH	DCCH	CCCH	PCCH	
LogCh Identity	tsc_DL_DCCH1 (1)	tsc_DL_DCCH2 (2)	tsc_DL_DCCH3 (3)	tsc_DL_DCCH4 (4)	tsc_DL_CCCH5 (5)	tsc_PCCH1 (1)	
RLC mode	UM	AM	AM	AM	UM	TM	AM
MAC priority	1	2	3	4	1	1	1
TrCH Type	DCH				FACH	PCH	FACH
TrCH identity	tsc_DL_DCH5 (10)				tsc_FACH1 (13)	tsc_PCH1 (12)	tsc_FACH2 (14)
PhyCh Type	DPCH				Secondary CCPCH		
PhyCH identity	tsc_DL_DPCH1 (26)				tsc_S_CCPCH1 (5)		

8.3.3 Configuration of Cell_DCH_Speech

The configuration is based on 3GPP TS 34.108 [3], clauses 6.10.2.4.1.4 and 6.10.2.4.1.5. The RB0/UM-CCCH is referred to 3GPP TS 34.108 [3], clause 6.10.2.4.3.2.1.2 and RB0/TM-CCCH is referred to 3GPP TS 34.108 [3], clause 6.10.2.4.4.1.1.1. The configuration is applied to those RRC and NAS signalling tests in the DCH state where a CS voice service, such as narrowband speech, emergency speech call or TS 61 for speech, is established.

Table 8.3.3.1: Uplink configuration of Cell_DCH_Speech

RB Identity	tsc_RB10 (10)	tsc_RB11 (11)	tsc_RB12 (12)	Same as uplink configuration of Cell_DCH_StandAloneSRB on DPCH	Same as uplink configuration of Cell_DCH_StandAloneSRB on PRACH	
LogCh Type	DTCH	DTCH	DTCH			
LogCh Identity	tsc_UL_DTCH1 (7)	tsc_UL_DTCH2 (8)	tsc_UL_DTCH3 (9)			
RLC mode	TM	TM	TM			
TrCH Type	DCH	DCH	DCH			
TrCH identity	tsc_UL_DCH1 (1)	tsc_UL_DCH2 (2)	tsc_UL_DCH3 (3)			
PhyCh Type	DPDCH				PRACH	
PhyCH identity	tsc_UL_DPCH1 (20)				tsc_PRACH1 (8)	

Table 8.3.3.2: Downlink configuration of Cell_DCH_Speech

RB Identity	tsc_RB10 (10)	tsc_RB11 (11)	tsc_RB12 (12)	Same as downlink configuration of Cell_DCH_StandAloneSRB on DPCH	Same as downlink configuration of Cell_DCH_StandAloneSRB on sCCPCH	
LogCh Type	DTCH	DTCH	DTCH			
LogCh Identity	tsc_DL_DTCH1 (7)	tsc_DL_DTCH2 (8)	tsc_DL_DTCH3 (9)			
RLC mode	TM	TM	TM			
MAC priority	1	1	1			
TrCH Type	DCH	DCH	DCH			
TrCH identity	tsc_DL_DCH1 (6)	tsc_DL_DCH2 (7)	tsc_DL_DCH3 (8)			
PhyCh Type	DPCH				Secondary CCPCH	
PhyCH identity	tsc_DL_DPCH1 (26)				tsc_S_CCPCH1 (5)	

8.3.4 Configuration of Cell_DCH_64kCS_RAB_SRB

The configuration is based on 3GPP TS 34.108 [3], clause 6.10.2.4.1.13 for the conversational unknown quality class. The RB0/UM-CCCH is referred to 3GPP TS 34.108 [3], clause 6.10.2.4.3.2.1.2 and RB0/TM-CCCH is referred to 3GPP TS 34.108 [3], clause 6.10.2.4.4.1.1.1. The configuration is applied to those RRC and NAS signalling tests in the DCH state where one of the following CS transparent data services is established:

- Multimedia call 28,8 kbit/s, 3,1 kHz Audio;
- Multimedia call 32 kbit/s, UDI;
- Multimedia call 33,6 kbit/s, 3,1 kHz Audio;
- Multimedia call 56 kbit/s, RDI;
- Multimedia call 64 kbit/s, UDI;
- Asynchronous 3,1 kHz Audio 28,8 kbit/s;
- Synchronous 3,1 kHz Audio 28,8 kbit/s;
- Synchronous V.110 UDI up to 56 kbit/s;
- BTM RDI 56 kbit/s;
- BTM UDI 64 bit/s.

Table 8.3.4.1: Uplink configuration of Cell_DCH_64kCS_RAB_SRB

RB Identity	tsc_RB10 (10)	Same as uplink configuration of Cell_DCH_StandAloneSRB on DPCH	Same as uplink configuration of Cell_DCH_StandAloneSRB on PRACH
LogCh Type	DTCH		
LogCh Identity	tsc_UL_DTCH1 (7)		
RLC mode	TM		
TrCH Type	DCH		
TrCH identity	tsc_UL_DCH1 (1)		
PhyCh Type	DPDCH		PRACH
PhyCH identity	tsc_UL_DPCH1 (20)		tsc_PRACH1 (8)

Table 8.3.4.2: Downlink configuration of Cell_DCH_64kCS_RAB_SRB

RB Identity	tsc_RB10 (10)	Same as downlink configuration of Cell_DCH_StandAloneSRB on DPCH	Same as downlink configuration of Cell_DCH_StandAloneSRB on sCCPCH
LogCh Type	DTCH		
LogCh Identity	tsc_DL_DTC H1 (7)		
RLC mode	TM		
MAC priority	1		
TrCH Type	DCH		
TrCH identity	tsc_DL_DCH1 (6)		
PhyCh Type	DPCH		Secondary CCPCH
PhyCH identity	tsc_DL_DPCH1 (26)		tsc_S_CCPCH1 (5)

8.3.5 Configuration of Cell_DCH_57_6kCS_RAB_SRB

The configuration is based on 3GPP TS 34.108 [3], clause 6.10.2.4.1.17 for the streaming unknown quality class. The RB0/UM-CCCH is referred to 3GPP TS 34.108 [3], 6.10.2.4.3.2.1.2 and RB0/TM-CCCH is referred to 3GPP TS 34.108 [3], clause 6.10.2.4.4.1.1.1. The configuration is applied to those RRC and NAS signalling tests in the DCH state where one of the following CS non-transparent data services is established:

- Asynchronous 3,1 kHz Audio up to 19,2 kbit/s;
- Asynchronous 3,1 kHz Audio modem auto-bauding;
- Asynchronous V.110 UDI up to 38,4 kbit/s, except 28,8 kbit/s;
- Asynchronous V.120 up to 56 kbit/s;
- Asynchronous PIAFS up to 64 kbit/s;
- Asynchronous FTM up to 64 kbit/s;
- Synchronous 3,1 kHz Audio up to 19,2 kbit/s;
- Synchronous V.110 UDI up to 56 kbit/s, except 28,8 kbit/s;
- Synchronous X.31 Flags Stuffing UDI up to 56 kbit/s;
- Synchronous V.120 up to 56 kbit/s;
- Synchronous BTM up to 64 kbit/s;
- TS61 FAX.

Table 8.3.5.1: Uplink configuration of Cell_DCH_57_6kCS_RAB_SRB

RB Identity	tsc_RB10 (10)	Same as uplink configuration of Cell_DCH_StandAloneSRB on DPCH	Same as uplink configuration of Cell_DCH_StandAloneSRB on PRACH
LogCh Type	DTCH		
LogCh Identity	tsc_UL_DTCH 1 (7)		
RLC mode	TM		
TrCH Type	DCH		
TrCH identity	tsc_UL_DCH1 (1)		
PhyCh Type	DPDCH		PRACH
PhyCH identity	tsc_UL_DPCH1 (20)		tsc_PRACH1 (8)

Table 8.3.5.2: Downlink configuration of Cell_DCH_57_6kCS_RAB_SRB

RB Identity	tsc_RB10 (10)	Same as downlink configuration of Cell_DCH_StandAloneSRB on DPCH	Same as downlink configuration of Cell_DCH_StandAloneSRB on sCCPCH
LogCh Type	DTCH		
LogCh Identity	tsc_DL_DTCH1 (7)		
RLC mode	TM		
MAC priority	1		
TrCH Type	DCH		
TrCH identity	tsc_DL_DCH1 (6)		
PhyCh Type	DPCH		Secondary CCPCH
PhyCH identity	tsc_DL_DPCH1 (26)		tsc_S_CCPCH1 (5)

8.3.6 Configuration of Cell_RLC_DCH_RAB

The configuration is based on 3GPP TS 34.108 [3], clauses 6.11.1, 6.11.2, 6.11.3, and 6.11.4 for the RLC AM and UM tests with 7 and 15 bit length indicators. The RB0/UM-CCCH is referred to 3GPP TS 34.108 [3], clause 6.10.2.4.3.2.1.2 and RB0/TM-CCCH is referred to 3GPP TS 34.108 [3], clause 6.10.2.4.4.1.1.1.

The RB Ids used for the DTCH depend on the RLC mode and length indicator size being simulated (reference clause 6.5.2, RLC test method). Table 8.3.6.1 shows the test suite constants used for each RLC mode, and length indicator size.

Table 8.3.6.1: RB Ids used for DTCH depending on RLC mode and LI size

RLC mode	LI Size	TSC	RB Id
UM	7	tsc_RB_UM_7_RLC	-10
UM	15	tsc_RB_UM_15_RLC	-11
AM	7	tsc_RB_AM_7_RLC	-12
AM	15	tsc_RB_AM_15_RLC	-13

Table 8.3.6.2: Uplink configuration of Cell_RLC_DCH_RAB

RB Identity	See table 8.3.6.1	Same as uplink configuration of Cell_DCH_StandAloneSRB on DPCH	Same as uplink configuration of Cell_DCH_StandAloneSRB on PRACH
LogCh Type	DTCH		
LogCh Identity	tsc_UL_DTCH1 (7)		
RLC mode	TM		
TrCH Type	DCH		
TrCH identity	tsc_UL_DCH1 (1)		
PhyCh Type		DPDCH	PRACH
PhyCH identity		tsc_UL_DPCH1 (20)	tsc_PRACH1 (8)

Table 8.3.6.3: Downlink configuration of Cell_RLC_DCH_RAB

RB Identity	See table 8.3.6.1	Same as downlink configuration of Cell_DCH_StandAloneSRB on DPCH	Same as downlink configuration of Cell_DCH_StandAloneSRB on sCCPCH
LogCh Type	DTCH		
LogCh Identity	tsc_DL_DTCH1 (7)		
RLC mode	TM		
MAC priority	1		
TrCH Type	DCH		
TrCH identity	tsc_DL_DCH1 (6)		
PhyCh Type		DPCH	Secondary CCPCH
PhyCH identity		tsc_DL_DPCH1 (26)	tsc_S_CCPCH1 (5)

8.3.7 Configuration of Cell_FACH_BMC

The configuration is based on 3GPP TS 34.108 [3], clause 6.10.2.4.3.2.1.2 for downlink and 3GPP TS 34.108 [3], clause 6.10.2.4.4.1.1.1 without RAB/DTCH for uplink. A RB30/CTCH is configured. The configuration is applied to the BMC and CBSMS tests.

The uplink configuration of Cell_FACH_BMC is the same as the uplink configuration of Cell_FACH.

Table 8.3.7.1: Downlink configuration of Cell_FACH_BMC

RB Identity		tsc_RB0 (0)	tsc_RB1 (1)	tsc_RB2 (2)	tsc_RB3 (3)	tsc_RB4 (4)	tsc_RB_BCC H_FACH (-3)	Tsc_RB30 (30)	tsc_RB_PCCH (-2)
LogCh Type		CCCH	DCCH	DCCH	DCCH	DCCH	BCCH	CTCH	PCCH
LogCh Identity		tsc_DL_ CCCH5 (5)	tsc_DL_ DCCH1 (1)	tsc_DL_ DCCH2 (2)	tsc_DL_ DCCH3 (3)	tsc_DL_ DCCH4 (4)	tsc_BCCH6 (6)	Tsc_CTCH (11)	tsc_PCCH1 (1)
RLC mode	AM	UM	UM	AM	AM	AM	TM	UM	TM
MAC priority	1	1	2	3	4	5	6	7	1
TrCH Type	FACH	FACH							PCH
TrCH identity	tsc_FACH2 (14)	tsc_FACH1 (13)							tsc_PCH1 (12)
PhyCh Type	Secondary CCPCH								
PhyCH identity	tsc_S_CCPCH1 (5)								

8.3.8 Configuration of PS Cell_DCH_64kPS_RAB_SRB and Cell_PDCP_AM_RAB

The configuration is based on 3GPP TS 34.108 [3], clause 6.10.2.4.1.26. The RB0/UM-CCCH is referred to 3GPP TS 34.108 [3], clause 6.10.2.4.3.2.1.2 and RB0/TM-CCCH is referred to 3GPP TS 34.108 [3], clause 6.10.2.4.4.1.1.1. The configuration is applied to those RRC and NAS signalling tests in the DCH state where a PS RAB on DTCH is setup for the interactive or background service class. The configuration is applied to PDCP test cases in acknowledge mode.

Table 8.3.8.1: Uplink configuration of PS Cell_DCH_64kPS_RAB_SRB SRB and Cell_PDCP_AM_RAB

RB Identity	tsc_RB20 (20)	Same as uplink configuration of Cell_DCH_StandAloneSRB on DPCH	Same as uplink configuration of Cell_DCH_StandAloneSRB on PRACH
LogCh Type	DTCH		
LogCh Identity	tsc_UL_DTC H1 (7)		
RLC mode	AM		
TrCH Type	DCH		
TrCH identity	tsc_UL_DCH 1 (1)		
PhyCh Type	DPDCH		PRACH
PhyCH identity	tsc_UL_DPCH1 (20)		tsc_PRACH1 (8)

Table 8.3.8.2: Downlink configuration of PS Cell_DCH_64kPS_RAB_SRB SRB and Cell_PDCP_AM_RAB

RB Identity	tsc_RB20 (20)	Same as downlink configuration of Cell_DCH_StandAloneSRB on DPCH	Same as downlink configuration of Cell_DCH_StandAloneSRB on sCCPCH
LogCh Type	DTCH		
LogCh Identity	tsc_DL_DTC H1 (7)		
RLC mode	AM		
MAC priority	1		
TrCH Type	DCH		
TrCH identity	tsc_DL_DCH 1 (6)		
PhyCh Type	DPCH		Secondary CCPCH
PhyCH identity	tsc_DL_DPCH1 (26)		tsc_S_CCPCH1 (5)

8.3.9 Configuration of Cell_Two_DTCH

The configuration is based on 3GPP TS 34.108 [3], clauses 6.10.2.4.1.6 to 6.10.2.4.1.11. The RB0/UM-CCCH is referred to 3GPP TS 34.108 [3], clause 6.10.2.4.3.2.1.2 and RB0/TM-CCCH is referred to 3GPP TS 34.108 [3], clause 6.10.2.4.4.1.1.1. The configuration is applied to RB tests.

Table 8.3.9.1: Uplink configuration of Cell_Two_DTCH

RB Identity	tsc_RB10 (10)	tsc_RB11 (11)	Same as uplink configuration of Cell_DCH_StandAloneSRB on DPCH	Same as uplink configuration of Cell_DCH_StandAloneSRB on PRACH
LogCh Type	DTCH	DTCH		
LogCh Identity	tsc_UL_DTCH 1 (7)	tsc_UL_DTCH 2 (8)		
RLC mode	TM	TM		
TrCH Type	DCH	DCH		
TrCH identity	tsc_UL_DCH1 (1)	tsc_UL_DCH2 (2)		
PhyCh Type	DPCH		PRACH	
PhyCH identity	tsc_UL_DPDCH1 (20)		tsc_PRACH1 (8)	

Table 8.3.9.2: Downlink configuration of Cell_Two_DTCH

RB Identity	tsc_RB10 (10)	tsc_RB11 (11)	Same as downlink configuration of Cell_DCH_StandAloneSRB on DPCH	Same as downlink configuration of Cell_DCH_StandAloneSRB on sCCPCH
LogCh Type	DTCH	DTCH		
LogCh Identity	tsc_DL_DTCH1 (7)	tsc_DL_DTCH2 (8)		
RLC mode	TM	TM		
MAC priority	1	1		
TrCH Type	DCH	DCH		
TrCH identity	tsc_DL_DCH1 (6)	tsc_DL_DCH2 (7)		
PhyCh Type	DPCH		Secondary CCPCH	
PhyCH identity	tsc_DL_DPCH1 (26)		tsc_S_CCPCH1 (5)	

8.3.10 Configuration of Cell_Single_DTCH (CS)

The configuration is based on 3GPP TS 34.108 [3], clauses 6.10.2.4.1.12 to 6.10.2.4.1.22. The RB0/UM-CCCH is referred to 3GPP TS 34.108 [3], clause 6.10.2.4.3.2.1.2 and RB0/TM-CCCH is referred to 3GPP TS 34.108 [3], clause 6.10.2.4.4.1.1.1. The configuration is applied to RB tests.

Table 8.3.10.1: Uplink configuration of Cell_Single_DTCH (CS)

RB Identity	tsc_RB10 (10)	Same as uplink configuration of Cell_DCH_StandAloneSRB on DPCH	Same as uplink configuration of Cell_DCH_StandAloneSRB on PRACH
LogCh Type	DTCH		
LogCh Identity	tsc_UL_DTCH1 (7)		
RLC mode	TM		
TrCH Type	DCH		
TrCH identity	tsc_UL_DCH1 (1)		
PhyCh Type	DPDCH		PRACH
PhyCH identity	tsc_UL_DPCH1 (20)		tsc_PRACH1 (8)

Table 8.3.10.2: Downlink configuration of Cell_Single_DTCH (CS)

RB Identity	tsc_RB10 (10)	Same as downlink configuration of Cell_DCH_StandAloneSRB on DPCH	Same as downlink configuration of Cell_DCH_StandAloneSRB on sCCPCH
LogCh Type	DTCH		
LogCh Identity	tsc_DL_DTCH1 (7)		
RLC mode	TM		
MAC priority	1		
TrCH Type	DCH		
TrCH identity	tsc_DL_DCH1 (6)		
PhyCh Type	DPCH		Secondary CCPCH
PhyCH identity	tsc_DL_DPCH1 (26)		tsc_S_CCPCH1 (5)

8.3.11 Configuration of PS Cell_PDCP_UM_RAB

The configuration is based on 3GPP TS 34.108 [3], clause 6.10.2.4.1.26. The RB0/UM-CCCH is referred to 3GPP TS 34.108 [3], clause 6.10.2.4.3.2.1.2 and RB0/TM-CCCH is referred to 3GPP TS 34.108 [3], clause 6.10.2.4.4.1.1.1. The configuration is applied to PDCP test cases in unacknowledge mode.

Table 8.3.11.1: Uplink configuration of PS Cell_PDCP_UM_RAB

RB Identity	tsc_RB21 (21)	Same as uplink configuration of Cell_DCH_StandAloneSRB on DPCH	Same as uplink configuration of Cell_DCH_StandAloneSRB on PRACH
LogCh Type	DTCH		
LogCh Identity	tsc_UL_DTCH1 (7)		
RLC mode	UM		
TrCH Type	DCH		
TrCH identity	tsc_UL_DCH1 (1)		
PhyCh Type	DPDCH		PRACH
PhyCH identity	tsc_UL_DPCH1 (20)		tsc_PRACH1 (8)

Table 8.3.11.2: Downlink configuration of PS Cell_PDCP_UM_RAB

RB Identity	tsc_RB21 (21)	Same as downlink configuration of Cell_DCH_StandAloneSRB on DPCH	Same as downlink configuration of Cell_DCH_StandAloneSRB on sCCPCH
LogCh Type	DTCH		
LogCh Identity	tsc_DL_DTCH1 (7)		
RLC mode	UM		
MAC priority	1		
TrCH Type	DCH		
TrCH identity	tsc_DL_DCH1 (6)		
PhyCh Type	DPCH		Secondary CCPCH
PhyCH identity	tsc_DL_DPCH1 (26)		tsc_S_CCPCH1 (5)

8.3.12 Configuration of PS Cell_PDCP_AM_UM_RAB

The configuration is based on 3GPP TS 34.108 [3], clause 6.10.2.4.1.26. The RB0/UM-CCCH is referred to 3GPP TS 34.108 [3], clause 6.10.2.4.3.2.1.2 and RB0/TM-CCCH is referred to 3GPP TS 34.108 [3], clause 6.10.2.4.4.1.1.1. The configuration is applied to PDCP test cases using both the acknowledged and unacknowledged mode.

Table 8.3.12.1: Uplink configuration of PS Cell_PDCP_AM_UM_RAB

RB Identity	tsc_RB20 (20)	tsc_RB21 (21)	Same as uplink configuration of Cell_DCH_StandAloneSRB on DPCH	Same as uplink configuration of Cell_DCH_StandAloneSRB on PRACH
LogCh Type	DTCH	DTCH		
LogCh Identity	tsc_UL_DTCH1 (7)	tsc_UL_DTCH2 (8)		
RLC mode	AM	UM		
TrCH Type	DCH			
TrCH identity	tsc_UL_DCH1 (1)			
PhyCh Type	DPDCH			PRACH
PhyCH identity	tsc_UL_DPCH1 (20)			tsc_PRACH1 (8)

Table 8.3.12.2: Downlink configuration of PS Cell_PDCP_AM_UM_RAB

RB Identity	tsc_RB20 (20)	tsc_RB21 (21)	Same as downlink configuration of Cell_DCH_StandAloneSRB on DPCH	Same as downlink configuration of Cell_DCH_StandAloneSRB on sCCPCH
LogCh Type	DTCH	DTCH		
LogCh Identity	tsc_DL_DTCH1 (7)	tsc_DL_DTCH2 (8)		
RLC mode	AM	UM		
MAC priority	1	1		
TrCH Type	DCH			
TrCH identity	tsc_DL_DCH1 (6)			
PhyCh Type	DPCH			Secondary CCPCH
PhyCH identity	tsc_DL_DPCH1 (26)			tsc_S_CCPCH1 (5)

8.3.13 Configuration of Cell_2SCCPCH_BMC

The configuration is based on 3GPP TS 34.108 [3], clause 6.10.2.4.3.2.1.2 for downlink and 3GPP TS 34.108 [3], clause 6.10.2.4.4.1.1.1 without RAB/DTCH for uplink. RB30/CTCH and RB31/CTCH as well as two PCCH are configured. The configuration is applied to the BMC and CBSMS tests.

Table 8.3.13.1: Uplink configuration of Cell_2SCCPCH_BMC

RB Identity	tsc_RB20 (20)	tsc_RB0 (0)	tsc_RB1 (1)	tsc_RB2 (2)	Tsc_RB3 (3)	tsc_RB4 (4)
LogCh Type	DTCH	CCCH	DCCH	DCCH	DCCH	DCCH
LogCh Identity	Tsc_UL_DTCH1 (7)	tsc_UL_CCCH5 (5)	tsc_UL_DCCH1 (1)	tsc_UL_DCCH2 (2)	tsc_UL_DCCH3 (3)	tsc_UL_DCCH4 (4)
RLC mode	AM	TM	UM	AM	AM	AM
TrCH Type	RACH					
TrCH identity	tsc_RACH1 (15)					
PhyCh Type	PRACH					
PhyCH identity	tsc_PRACH1 (8)					

Table 8.3.13.2: Downlink configuration of Cell_2SCCPCH_BMC: second S-CCPCH

RB Identity	Tsc_RB31 (31)	tsc_RB_2ndPCCH (-4)
LogCh Type	CTCH	PCCH
LogCh Identity	Tsc_CTCH2 (12)	tsc_PCCH2 (2)
RLC mode	UM	TM
MAC priority	1	1
TrCH Type	FACH	PCH
TrCH identity	tsc_FACH1 (13)	tsc_PCH2 (30)
PhyCh Type	Secondary CCPCH	
PhyCH identity	tsc_S_CCPCH2 (10)	

Table 8.3.13.3: Downlink configuration of Cell_2SCCPCH_BMC: first S-CCPCH

RB Identity	tsc_RB20 (20)	tsc_RB0 (0)	tsc_RB1 (1)	tsc_RB2 (2)	tsc_RB3 (3)	tsc_RB4 (4)	tsc_RB_BCCH_FACH (-3)	Tsc_RB30 (30)	tsc_RB_PCCH (-2)	
LogCh Type	DTCH	CCCH	DCCH	DCCH	DCCH	DCCH	BCCH	CTCH	PCCH	
LogCh Identity	tsc_DL_DTCH1 (6)	tsc_DL_CCCH5 (5)	tsc_DL_DCCH1 (1)	tsc_DL_DCCH2 (2)	tsc_DL_DCCH3 (3)	tsc_DL_DCCH4 (4)	tsc_BCCH6 (6)	Tsc_CTCH1 (11)	tsc_PCCH1 (1)	
RLC mode	AM	UM	UM	AM	AM	AM	TM	UM	TM	
MAC priority	1	1	2	3	4	5	6	7	1	
TrCH Type	FACH	FACH							PCH	
TrCH identity	Tsc_FACH2 (14)	tsc_FACH1 (13)							tsc_PCH1 (12)	
PhyCh Type	Secondary CCPCH									
PhyCH identity	tsc_S_CCPCH1 (5)									

8.3.14 Configuration of Cell_Four_DTCH_CS_PS, Cell_Four_DTCH_PS_CS

The configuration is based on 3GPP TS 34.108 [3], clauses 6.10.2.4.1.40. The RB0/UM-CCCH is referred to 3GPP TS 34.108 [3], clause 6.10.2.4.3.2.1.2 and RB0/TM-CCCH is referred to 3GPP TS 34.108 [3], clause 6.10.2.4.4.1.1.1. The configuration is applied to RB tests.

Table 8.3.14.1: Uplink configuration of Cell_Four_DTCH_CS_PS

RB Identity	tsc_RB10 (10)	tsc_RB11 (11)	tsc_RB12 (12)	tsc_RB20 (20)	Same as uplink configuration of Cell_DCH_StandAloneSRB on DPCH	Same as uplink configuration of Cell_DCH_StandAloneSRB on PRACH
LogCh Type	DTCH	DTCH	DTCH	DTCH		
LogCh Identity	tsc_UL_DTC H1 (7)	tsc_UL_DTC H2 (8)	tsc_UL_DTC H3 (9)	tsc_UL_DTC H4 (10)		
RLC mode	TM	TM	TM	AM		
MAC priority	1	1	1	1		
TrCH Type	DCH	DCH	DCH	DCH		
TrCH identity	tsc_UL_DCH 1 (1)	tsc_UL_DCH 2 (2)	tsc_UL_DCH 3 (3)	tsc_UL_DCH 4 (4)		
PhyCh Type	DPDCH					PRACH
PhyCH identity	tsc_UL_DPCH1 (20)					tsc_PRACH1 (8)

Table 8.3.14.2: Downlink configuration of Cell_Four_DTCH_CS_PS, Cell_Four_DTCH_PS_CS

RB Identity	tsc_RB10 (10)	tsc_RB11 (11)	tsc_RB12 (12)	tsc_RB20 (20)	Same as downlink configuration of Cell_DCH_StandAloneSRB on DPCH	Same as downlink configuration of Cell_DCH_StandAloneSRB on sCCPCH
LogCh Type	DTCH	DTCH	DTCH	DTCH		
LogCh Identity	tsc_DL_DTC H1 (7)	tsc_DL_DTC H2 (8)	tsc_DL_DTC H3 (9)	tsc_DL_DTC H4 (10)		
RLC mode	TM	TM	TM	AM		
MAC priority	1	1	1	1		
TrCH Type	DCH	DCH	DCH	DCH		
TrCH identity	tsc_DL_DCH 1 (6)	tsc_DL_DCH 2 (7)	tsc_DL_DCH 3 (8)	tsc_DL_DCH 4 (9)		
PhyCh Type	DPCH					Secondary CCPCH
PhyCH identity	tsc_DL_DPCH1 (20)					tsc_S_CCPCH1 (5)

8.3.14a Configuration of Cell_Five_DTCH_CS_PS

The configuration is based on 3GPP TS 34.108 [3], clauses 6.11.5.4.1.67. The RB0/UM-CCCH is referred to 3GPP TS 34.108 [3], clause 6.10.2.4.3.2.1.2 and RB0/TM-CCCH is referred to 3GPP TS 34.108 [3], clause 6.10.2.4.4.1.1.1.

The configuration is applied to LCR TDD RB tests.

Table 8.3.14a.1: Uplink configuration of Cell_Five_DTCH_CS_PS

RB Identity	tsc_RB10 (10)	tsc_RB11 (11)	tsc_RB12 (12)	tsc_RB20 (20)	tsc_RB22 (22)	Same as uplink configuration of Cell_DCH_StandAloneSRB on DPCH	Same as uplink configuration of Cell_DCH_StandAloneSRB on PRACH
LogCh Type	DTCH	DTCH	DTCH	DTCH	DTCH		
LogCh Identity	tsc_UL_DT CH1 (7)	tsc_UL_DT CH2 (8)	tsc_UL_DTC H3 (9)	tsc_UL_DTC H4 (10)	tsc_UL_DTC H5 (13)		
RLC mode	TM	TM	TM	AM	AM		
MAC priority	1	1	1	1	1		
TrCH Type	DCH	DCH	DCH	DCH	DCH		
TrCH identity	tsc_UL_DC H1 (1)	tsc_UL_DC H2 (2)	tsc_UL_DCH 3 (3)	tsc_UL_DCH 4 (4)	tsc_UL_DCH 5 (5)		
PhyCh Type	DPDCH					PRACH	
PhyCH identity	tsc_UL_DPCH1 (20)					tsc_PRACH1 (8)	

Table 8.3.14a.2: Downlink configuration of Cell_Five_DTCH_CS_PS

RB Identity	tsc_RB10 (10)	tsc_RB11 (11)	tsc_RB12 (12)	tsc_RB20 (20)	tsc_RB22 (22)	Same as downlink configuration of Cell_DCH_StandAloneSRB on DPCH	Same as downlink configuration of Cell_DCH_StandAloneSRB on sCCPCH
LogCh Type	DTCH	DTCH	DTCH	DTCH	DTCH		
LogCh Identity	tsc_DL_DTCH1 (7)	tsc_DL_DTCH2 (8)	tsc_DL_DTC H3 (9)	tsc_DL_DTC H4 (10)	tsc_UL_DTC H5 (11)		
RLC mode	TM	TM	TM	AM	AM		
MAC priority	1	1	1	1	1		
TrCH Type	DCH	DCH	DCH	DCH	DCH		
TrCH identity	tsc_DL_DC H1 (6)	tsc_DL_DC H2 (7)	Tsc_DL_DCH 3 (8)	tsc_DL_DCH 4 (9)	tsc_DL_DCH 5 (10)		
PhyCh Type	DPCH						Secondary CCPCH
PhyCH identity	tsc_DL_DPCH1 (20)						tsc_S_CCPCH1 (5)

8.3.15 Configuration of Cell_Two_DTCH_CS_PS, Cell_Two_DTCH_PS_CS

The configuration is based on 3GPP TS 34.108 [3], clauses 6.10.2.4.1.51 and 6.10.2.4.1.53. The RB0/UM-CCCH is referred to 3GPP TS 34.108 [3], clause 6.10.2.4.3.2.1.2 and RB0/TM-CCCH is referred to 3GPP TS 34.108 [3], clause 6.10.2.4.4.1.1.1. The configuration is applied to RB tests.

Table 8.3.15.1: Uplink configuration of Cell_Two_DTCH_CS_PS, Cell_Two_DTCH_PS_CS

RB Identity	tsc_RB10 (10)	tsc_RB20 (20)	Same as uplink configuration of Cell_DCH_StandAloneSRB on DPCH	Same as uplink configuration of Cell_DCH_StandAloneSRB on PRACH
LogCh Type	DTCH	DTCH		
LogCh Identity	tsc_UL_DTCH1 (7)	tsc_UL_DTCH2 (8)		
RLC mode	TM	AM		
TrCH Type	DCH	DCH		
TrCH identity	tsc_UL_DCH1 (1)	tsc_UL_DCH2 (2)		
PhyCh Type	DPDCH			PRACH
PhyCH identity	tsc_UL_DPCH1 (20)			tsc_PRACH1 (8)

Table 8.3.15.2: Downlink configuration of Cell_Two_DTCH_CS_PS

RB Identity	tsc_RB10 (10)	tsc_RB20 (20)	Same as downlink configuration of Cell_DCH_StandAloneSRB on DPCH	Same as downlink configuration of Cell_DCH_StandAloneSRB on sCCPCH
LogCh Type	DTCH	DTCH		
LogCh Identity	tsc_DL_DTCH1 (7)	tsc_DL_DTCH2 (8)		
RLC mode	TM	AM		
MAC priority	1	1		
TrCH Type	DCH	DCH		
TrCH identity	tsc_DL_DCH1 (6)	tsc_DL_DCH2 (7)		
PhyCh Type	DPCH		Secondary CCPCH	
PhyCH identity	tsc_DL_DPCH1 (20)		tsc_S_CCPCH1 (5)	

8.3.16 Configuration of Cell_Four_DTCH_CS

The configuration is based on 3GPP TS 34.108 [3], clauses 6.10.2.4.1.49. The RB0/UM-CCCH is referred to 3GPP TS 34.108 [3], clause 6.10.2.4.3.2.1.2 and RB0/TM-CCCH is referred to 3GPP TS 34.108 [3], clause 6.10.2.4.4.1.1.1. The configuration is applied to RB tests.

Table 8.3.16.1: Uplink configuration of Cell_Four_DTCH_CS

RB Identity	tsc_RB10 (10)	tsc_RB11 (11)	tsc_RB12 (12)	tsc_RB13 (13)	Same as uplink configuration of Cell_DCH_StandAloneSRB on DPCH	Same as uplink configuration of Cell_DCH_StandAloneSRB on PRACH
LogCh Type	DTCH	DTCH	DTCH	DTCH		
LogCh Identity	tsc_UL_DTC H1 (1)	tsc_UL_DTC H2 (2)	tsc_UL_DTC H3 (3)	tsc_UL_DTC H4 (4)		
RLC mode	TM	TM	TM	TM		
MAC priority	1	1	1	1		
TrCH Type	DCH	DCH	DCH	DCH		
TrCH identity	tsc_UL_DCH 1 (6)	tsc_UL_DCH 2 (7)	tsc_UL_DCH 3 (8)	tsc_UL_DCH 4 (9)		
PhyCh Type	DPDCH				PRACH	
PhyCH identity	tsc_UL_DPCH1 (20)				tsc_PRACH1 (8)	

Table 8.3.16.2: Downlink configuration of Cell_Four_DTCH_CS

RB Identity	tsc_RB10 (10)	tsc_RB11 (11)	tsc_RB12 (12)	tsc_RB13 (13)	Same as downlink configuration of Cell_DCH_StandAloneS RB on DPCH	Same as downlink configuration of Cell_DCH_StandAlone SRB on sCCPCH
LogCh Type	DTCH	DTCH	DTCH	DTCH		
LogCh Identity	tsc_DL_DTC H1 (7)	tsc_DL_DTC H2 (8)	tsc_DL_DTC H3 (9)	tsc_DL_DTC H4 (10)		
RLC mode	TM	TM	TM	TM		
MAC priority	1	1	1	1		
TrCH Type	DCH	DCH	DCH	DCH		
TrCH identity	tsc_DL_DCH 1 (6)	tsc_DL_DCH 2 (7)	tsc_DL_DCH 3 (8)	tsc_DL_DCH 4 (9)		
PhyCh Type	DPCH					Secondary CCPCH
PhyCH identity	tsc_DL_DPCH1 (20)					tsc_S_CCPCH1 (5)

8.3.17 Configuration of Cell_DCH_MAC_SRB

The configuration is based on 3GPP TS 34.108 [3], clause 6.10.2.4.1. 3. The RB0/UM-CCCH is referred to 3GPP TS 34.108 [3], clause 6.10.2.4.3.2.1.2 and RB0/TM-CCCH is referred to 3GPP TS 34.108 [3], clause 6.10.2.4.4.1.1.1; except that RB3 is mapped on TM mode.

The configuration is applied to the MAC tests.

Table 8.3.17.1: Uplink configuration of Cell_DCH_MAC_SRB

RB Identity	tsc_RB1 (1)	tsc_RB2 (2)	tsc_RB_DCCH _DCH_MAC (-15)	tsc_RB4 (4)	tsc_RB0 (0)	
LogCh Type	DCCH	DCCH	DCCH	DCCH	CCCH	
LogCh Identity	tsc_UL_DCCH1 (1)	tsc_UL_DCCH2 (2)	tsc_UL_DCCH3 (3)	tsc_UL_DCCH4 (4)	tsc_UL_CCCH5 (5)	
RLC mode	UM	AM	TM	AM	TM	AM
TrCH Type	DCH				RACH	
TrCH identity	tsc_UL_DCH5 (5)				tsc_RACH1 (15)	
PhyCh Type	DPDCH				PRACH	
PhyCH identity	tsc_UL_DPCH1 (20)				tsc_PRACH1 (8)	

Table 8.3.17.2: Downlink configuration of Cell_DCH_MAC_SRB

RB Identity	tsc_RB1 (1)	tsc_RB2 (2)	tsc_RB_DCC H_DCH_MAC (-15)	tsc_RB4 (4)	tsc_RB0 (0)	tsc_RB_PCCH (-2)	
LogCh Type	DCCH	DCCH	DCCH	DCCH	CCCH	PCCH	
LogCh Identity	tsc_DL_DCCH 1 (1)	tsc_DL_DCCH 2 (2)	tsc_DL_DCCH 3 (3)	tsc_DL_DCCH 4 (4)	tsc_DL_CCCH 5 (5)	tsc_PCCH1 (1)	
RLC mode	UM	AM	TM	AM	UM	TM	AM
MAC priority	1	2	3	4	1	1	1
TrCH Type	DCH				FACH	PCH	FACH
TrCH identity	tsc_DL_DCH5 (10)				tsc_FACH1 (13)	tsc_PCH1 (12)	tsc_FACH2 (14)
PhyCh Type	DPCH				Secondary CCPCH		
PhyCH identity	tsc_DL_DPCH1 (26)				tsc_S_CCPCH1 (5)		

8.3.18 Configuration of Cell_FACH_MAC_SRB

The configuration is based on 3GPP TS 34.108 [3], clause 6.10.2.4.3.2.1.2 for downlink and 3GPP TS 34.108 [3], clause 6.10.2.4.4.1.1.1 for uplink; except that RB3 is mapped on TM mode.

The configuration is applied to the MAC tests.

Table 8.3.18.1: Uplink configuration of Cell_FACH_MAC_SRB

RB Identity	tsc_RB20 (20)	tsc_RB0 (0)	tsc_RB1 (1)	tsc_RB2 (2)	tsc_RB_DCCH_FACH_M AC (-14)	tsc_RB4 (4)
LogCh Type	DTCH	CCCH	DCCH	DCCH	DCCH	DCCH
LogCh Identity	Tsc_UL_DTCH 1 (7)	tsc_UL_CCCH 5 (5)	tsc_UL_DCCH 1 (1)	tsc_UL_DCCH 2 (2)	tsc_UL_DCCH3 (3)	tsc_UL_DCCH 4 (4)
RLC mode	AM	TM	UM	AM	TM	AM
TrCH Type	RACH					
TrCH identity	tsc_RACH1 (15)					
PhyCh Type	PRACH					
PhyCH identity	tsc_PRACH1 (8)					

Table 8.3.18.2: Downlink configuration of Cell_FACH_MAC_SRB

RB Identity	tsc_RB20 (20)	tsc_RB0 (0)	tsc_RB1 (1)	tsc_RB2 (2)	tsc_RB_DC CH_FACH_ MAC (-14)	tsc_RB4 (4)	tsc_RB_BC CH_FACH (-3)	tsc_RB_PC CH (-2)
LogCh Type	DTCH	CCCH	DCCH	DCCH	DCCH	DCCH	BCCH	PCCH
LogCh Identity	tsc_DL_DT CH1 (6)	tsc_DL_CC CH5 (5)	tsc_DL_DC CH1 (1)	tsc_DL_DC CH2 (2)	tsc_DL_DC CH3 (3)	tsc_DL_DC CH4 (4)	tsc_BCCH6 (6)	tsc_PCCH1 (1)
RLC mode	AM	UM	UM	AM	TM	AM	TM	TM
MAC priority	1	1	2	3	4	5	6	1
TrCH Type	FACH	FACH						PCH
TrCH identity	tsc_FACH2 (14)	tsc_FACH1 (13)						tsc_PCH1 (12)
PhyCh Type	Secondary CCPCH							
PhyCH identity	tsc_S_CCPCH1 (5)							

8.3.19 Configuration of Cell_FACH_MAC_SRB0

The configuration is based on 3GPP TS 34.108 [3], clause 6.10.2.4.3.2.1.2 for downlink and 3GPP TS 34.108 [3], clause 6.10.2.4.4.1.1.1 for uplink; except that the downlink SRB0 is mapped on TM mode.

The configuration is applied to the MAC tests.

The uplink configuration of Cell_FACH_MAC_SRB0 is the same as the uplink configuration of Cell_FACH.

Table 8.3.19: Downlink configuration of Cell_FACH_MAC_SRB0

RB Identity	tsc_RB20 (20)	tsc_RB_CC CH_FACH_ MAC (-18)	tsc_RB1 (1)	tsc_RB2 (2)	tsc_RB3 (3)	tsc_RB4 (4)	tsc_RB_BC CH_FACH (-3)	tsc_RB_PC CH (-2)
LogCh Type	DTCH	CCCH	DCCH	DCCH	DCCH	DCCH	BCCH	PCCH
LogCh Identity	tsc_DL_DT CH1 (6)	tsc_DL_CC CH5 (5)	tsc_DL_DC CH1 (1)	tsc_DL_DC CH2 (2)	tsc_DL_DC CH3 (3)	tsc_DL_DC CH4 (4)	tsc_BCCH6 (6)	tsc_PCCH1 (1)
RLC mode	AM	TM	UM	AM	AM	AM	TM	TM
MAC priority	1	1	2	3	4	5	6	1
TrCH Type	FACH	FACH						PCH
TrCH identity	tsc_FACH2 (14)	tsc_FACH1 (13)						tsc_PCH1 (12)
PhyCh Type	Secondary CCPCH							
PhyCH identity	tsc_S_CCPCH1 (5)							

8.3.20 Configuration of Cell_FACH_2SCCPCH_StandAlonePCH

The configuration is based on 3GPP TS 34.108 [3], clause 6.10.2.4.3.2.1.2 for downlink and 3GPP TS 34.108 [3] except the mapping of PCH, clause 6.10.2.4.4.1.1.1 for uplink.

The configuration is applied to the RAB tests.

The uplink configuration of Cell_FACH_2SCCPCH_StandAlonePCH is the same as the uplink configuration of Cell_FACH.

Table 8.3.20: Downlink configuration of Cell_FACH_2SCCPCH_StandAlonePCH

RB Identity	tsc_RB20 (20)	tsc_RB0 (0)	tsc_RB1 (1)	tsc_RB2 (2)	tsc_RB3 (3)	tsc_RB4 (4)	tsc_RB_BC CH_FACH (-3)	tsc_RB_PC CH (-2)
LogCh Type	DTCH	CCCH	DCCH	DCCH	DCCH	DCCH	BCCH	PCCH
LogCh Identity	tsc_DL_DT CH1 (6)	tsc_DL_CC CH5 (5)	tsc_DL_DC CH1 (1)	tsc_DL_DC CH2 (2)	tsc_DL_DC CH3 (3)	tsc_DL_DC CH4 (4)	tsc_BCCH6 (6)	tsc_PCCH1 (1)
RLC mode	AM	UM	UM	AM	AM	AM	TM	TM
MAC priority	1	1	2	3	4	5	6	1
TrCH Type	FACH	FACH						PCH
TrCH identity	tsc_FACH2 (14)	tsc_FACH1 (13)						tsc_PCH1 (12)
PhyCh Type	Secondary CCPCH							Secondary CCPCH
PhyCH identity	tsc_S_CCPCH2 (10)							tsc_S_CCP CH1 (5)

8.3.21 Configuration of PS Cell_DCH_2AM_PS

The configuration is based on 3GPP TS 34.108 [3], clauses 6.10.2.4.1.26 and 6.10.2.4.1.57. The RB0/UM-CCCH is referred to 3GPP TS 34.108 [3], clause 6.10.2.4.3.2.1.2 with 2 AM RAB and RB0/TM-CCCH is referred to 3GPP TS 34.108 [3], clause 6.10.2.4.4.1.1.1. The configuration is applied to MAC and RAB test cases.

Table 8.3.21.1: Uplink configuration of Cell_DCH_2AM_PS

RB Identity	tsc_RB20 (20)	tsc_RB22 (22)	Same as uplink configuration of Cell_DCH_StandAloneSRB on DPCH	Same as uplink configuration of Cell_DCH_StandAloneSRB on PRACH
LogCh Type	DTCH	DTCH		
LogCh Identity	tsc_UL_DTCH 1 (7)	tsc_UL_DTCH 2 (8)		
RLC mode	AM	AM		
TrCH Type	DCH			
TrCH identity	tsc_UL_DCH1 (1)			
PhyCh Type	DPDCH		PRACH	
PhyCH identity	tsc_UL_DPCH1 (20)		tsc_PRACH1 (8)	

Table 8.3.21.2: Downlink configuration of Cell_DCH_2AM_PS

RB Identity	tsc_RB20 (20)	tsc_RB22 (22)	Same as downlink configuration of Cell_DCH_StandAloneSRB on DPCH	Same as downlink configuration of Cell_DCH_StandAloneSRB on sCCPCH
LogCh Type	DTCH	DTCH		
LogCh Identity	tsc_DL_DTCH 1 (7)	tsc_DL_DTCH 2 (8)		
RLC mode	AM	AM		
MAC priority	1	1		
TrCH Type	DCH			
TrCH identity	tsc_DL_DCH1 (6)			
PhyCh Type	DPCH		Secondary CCPCH	
PhyCH identity	tsc_DL_DPCH1 (26)		tsc_S_CCPCH1 (5)	

8.3.21a Configuration of Cell_DCH_3AM_PS

The configuration is based on 3GPP TS 34.108 [3], clauses 6.11.5.4.1.70. The RB0/UM-CCCH is referred to 3GPP TS 34.108 [3], clause 6.10.2.4.3.2.1.2 and RB0/TM-CCCH is referred to 3GPP TS 34.108 [3], clause 6.10.2.4.4.1.1.1.

The configuration is applied to LCR TDD RB tests.

Table 8.3.21a.1: Uplink configuration of Cell_DCH_3AM_PS

RB Identity	tsc_RB20 (20)	tsc_RB22 (22)	tsc_RB24 (24)	Same as uplink configuration of Cell_DCH_StandAloneSRB on DPCH	Same as uplink configuration of Cell_DCH_StandAloneSRB on PRACH
LogCh Type	DTCH	DTCH	DTCH		
LogCh Identity	tsc_UL_DTCH 1 (7)	tsc_UL_DTCH 2 (8)	tsc_UL_DTCH 3 (9)		
RLC mode	AM	AM	AM		
TrCH Type	DCH				
TrCH identity	tsc_UL_DCH1 (1)				
PhyCh Type	DPDCH			PRACH	
PhyCH identity	tsc_UL_DPCH1 (20)			tsc_PRACH1 (8)	

Table 8.3.21a.2: Downlink configuration of Cell_DCH_3AM_PS

RB Identity	tsc_RB20 (20)	tsc_RB22 (22)	tsc_RB24 (24)	Same as downlink configuration of Cell_DCH_StandAloneSRB on DPCH	Same as downlink configuration of Cell_DCH_StandAloneSRB on sCCPCH
LogCh Type	DTCH	DTCH	DTCH		
LogCh Identity	tsc_DL_DTCH 1 (7)	tsc_DL_DTCH 2 (8)	tsc_DL_DTCH 3 (9)		
RLC mode	AM	AM	AM		
MAC priority	1	1	1		
TrCH Type	DCH				
TrCH identity	tsc_DL_DCH1 (6)				
PhyCh Type	DPCH			Secondary CCPCH	
PhyCH identity	tsc_DL_DPCH1 (26)			tsc_S_CCPCH1 (5)	

8.3.22 Configuration of PS Cell_DCH_2_PS_Call

The configuration is based on 3GPP TS 34.108 [3], clauses 6.10.2.4.1.56 and 6.10.2.4.1.58. The RB0/UM-CCCH is referred to 3GPP TS 34.108 [3], clause 6.10.2.4.3.2.1.2 and RB0/TM-CCCH is referred to 3GPP TS 34.108 [3], clause 6.10.2.4.4.1.1.1. The configuration is applied to RB tests.

Table 8.3.22.1: Uplink configuration of Cell_DCH_2_PS_Call

RB Identity	tsc_RB20 (20)	tsc_RB22 (22)	Same as uplink configuration of Cell_DCH_StandAloneSRB on DPCH	Same as uplink configuration of Cell_DCH_StandAloneSRB on PRACH
LogCh Type	DTCH	DTCH		
LogCh Identity	tsc_UL_DTCH 1 (7)	tsc_UL_DTCH 2 (8)		
RLC mode	AM	AM		
TrCH Type	DCH	DCH		
TrCH identity	tsc_UL_DCH1 (1)	tsc_UL_DCH2 (2)		
PhyCh Type	DPDCH			PRACH
PhyCH identity	tsc_UL_DPCH1 (20)			tsc_PRACH1 (8)

Table 8.3.22.2: Downlink configuration of Cell_DCH_2_PS_Call

RB Identity	tsc_RB20 (20)	tsc_RB22 (22)	Same as downlink configuration of Cell_DCH_StandAloneSRB on DPCH	Same as downlink configuration of Cell_DCH_StandAloneSRB on sCCPCH
LogCh Type	DTCH	DTCH		
LogCh Identity	tsc_DL_DTCH 1 (7)	tsc_DL_DTCH 2 (8)		
RLC mode	AM	AM		
MAC priority	1	1		
TrCH Type	DCH	DCH		
TrCH identity	tsc_DL_DCH1 (6)	tsc_DL_DCH2 (7)		
PhyCh Type	DPCH			Secondary CCPCH
PhyCH identity	tsc_DL_DPCH1 (26)			tsc_S_CCPCH1 (5)

8.3.23 Configuration of Cell_FACH_3_SCCPCH_4_FACH_Cnfg1

The configuration is based on 3GPP TS 34.108 [3], clause 6.10.2.4.3.2 for downlink and 3GPP TS 34.108 [3], clause 6.10.2.4.4.1.1.1 for uplink. The configuration is applied to the RAB tests.

The uplink configuration of Cell_FACH_3_SCCPCH_4_FACH_Cnfg1 is the same as the uplink configuration of Cell_FACH.

Table 8.3.23.1: Downlink configuration of Cell_FACH_3_SCCPCH_4_FACH_Cnfg1: 1st & 2nd S-CCPCH

RB Identity		tsc_RB0 (0)	tsc_RB_BCCH_ FACH (-3)	tsc_RB_PCCH (-2)
LogCh Type		CCCH	BCCH	PCCH
LogCh Identity		tsc_DL_CCCH 5 (5)	tsc_BCCH6 (6)	tsc_PCCH1 (1)
RLC mode		UM	TM	TM
MAC priority		1	6	1
TrCH Type	FACH	FACH		PCH
TrCH identity	tsc_FACH2 (14)	tsc_FACH1 (13)		tsc_PCH1 (12)
PhyCh Type	Secondary CCPCH			Secondary CCPCH
PhyCH identity	tsc_S_CCPCH2 (10)			tsc_S_CCPCH1 (5)

Table 8.3.23.2: Downlink configuration of Cell_FACH_3_SCCPCH_4_FACH_Cnfg1: 3rd S-CCPCH

RB Identity	tsc_RB20 (20)	tsc_RB29 (29)	tsc_RB1 (1)	tsc_RB2 (2)	tsc_RB3 (3)	tsc_RB4 (4)	tsc_RB_BC CH_FACH_ RAB (-19)
LogCh Type	DTCH	CCCH	DCCH	DCCH	DCCH	DCCH	BCCH
LogCh Identity	tsc_DL_DTC H1 (7)	tsc_DL_C CCH6 (6)	tsc_DL_DC CH1 (1)	tsc_DL_DC CH2 (2)	tsc_DL_DC CH3 (3)	tsc_DL_DC CH4 (4)	tsc_BCCH7 (7)
RLC mode	AM	UM	UM	AM	AM	AM	TM
MAC priority	1	1	2	3	4	5	6
TrCH Type	FACH	FACH					
TrCH identity	tsc_FACH4 (17)	tsc_FACH3 (16)					
PhyCh Type	Secondary CCPCH						
PhyCH identity	tsc_S_CCPCH3 (13)						

8.3.24 Configuration of Cell_FACH_3_SCCPCH_4_FACH_Cnfg2

The configuration is based on 3GPP TS 34.108 [3], clause 6.10.2.4.3.2 for downlink and 3GPP TS 34.108 [3], clause 6.10.2.4.4.1.1.1 for uplink. The configuration is applied to the RAB tests.

The uplink configuration of Cell_FACH_3_SCCPCH_4_FACH_Cnfg2 is the same as the uplink configuration of Cell_FACH.

Table 8.3.24.1: Downlink configuration of Cell_FACH_3_SCCPCH_4_FACH_Cnfg2: 2nd S-CCPCH

RB Identity	tsc_RB20 (20)	tsc_RB29 (29)	tsc_RB1 (1)	tsc_RB2 (2)	tsc_RB3 (3)	tsc_RB4 (4)	tsc_RB_BC CH_FACH_ RAB (-19)
LogCh Type	DTCH	CCCH	DCCH	DCCH	DCCH	DCCH	BCCH
LogCh Identity	tsc_DL_DTC H1 (7)	tsc_DL_C CCH6 (6)	tsc_DL_DC CH1 (1)	tsc_DL_DC CH2 (2)	tsc_DL_DC CH3 (3)	tsc_DL_DC CH4 (4)	tsc_BCCH7 (7)
RLC mode	AM	UM	UM	AM	AM	AM	TM
MAC priority	1	1	2	3	4	5	6
TrCH Type	FACH	FACH					
TrCH identity	tsc_FACH2 (14)	tsc_FACH1 (13)					
PhyCh Type	Secondary CCPCH						
PhyCH identity	tsc_S_CCPCH2 (10)						

Table 8.3.24.2: Downlink configuration of Cell_FACH_3_SCCPCH_4_FACH_Cnfg2: 1st & 3rd S-CCPCH

RB Identity		tsc_RB0 (0)	tsc_RB_BCCH_ FACH (-3)	tsc_RB_PCCH (-2)
LogCh Type		CCCH	BCCH	PCCH
LogCh Identity		tsc_DL_CCCH 5 (5)	tsc_BCCH6 (6)	tsc_PCCH1 (1)
RLC mode		UM	TM	TM
MAC priority		1	6	1
TrCH Type	FACH	FACH		PCH
TrCH identity	tsc_FACH4 (17)	tsc_FACH3 (16)		tsc_PCH1 (12)
PhyCh Type	Secondary CCPCH			Secondary CCPCH
PhyCH identity	tsc_S_CCPCH3 (13)			tsc_S_CCPCH1 (5)

8.3.25 Configuration of Cell_FACH_3_SCCPCH_3_FACH_CTCH

The configuration is based on 3GPP TS 34.108 [3], clause 6.10.2.4.3.2 for downlink and 3GPP TS 34.108 [3], clause 6.10.2.4.4.1.1.1 for uplink. The configuration is applied to the RAB tests.

The uplink configuration of Cell_FACH_3_SCCPCH_3_FACH_CTCH is the same as the uplink configuration of Cell_FACH.

Table 8.3.25.1: Downlink configuration of Cell_FACH_3_SCCPCH_3_FACH_CTCH: 1st & 2nd S-CCPCH

RB Identity	tsc_RB30 (30)	tsc_RB0 (0)	tsc_RB_BCCH_FACH (-3)	tsc_RB_PCCH (-2)
LogCh Type	CTCH	CCCH	BCCH	PCCH
LogCh Identity	tsc_CTCH1 (11)	tsc_DL_CCCH5 (5)	tsc_BCCH6 (6)	tsc_PCCH1 (1)
RLC mode	UM	UM	TM	TM
MAC priority	7	1	6	1
TrCH Type	FACH	FACH		PCH
TrCH identity	tsc_FACH2 (14)	tsc_FACH1 (13)		tsc_PCH1 (12)
PhyCh Type	Secondary CCPCH			Secondary CCPCH
PhyCH identity	tsc_S_CCPCH2 (10)			tsc_S_CCPCH1 (5)

Table 8.3.25.2: Downlink configuration of Cell_FACH_3_SCCPCH_3_FACH_CTCH: 3rd S-CCPCH

RB Identity	tsc_RB20 (20)	tsc_RB29 (29)	tsc_RB1 (1)	tsc_RB2 (2)	tsc_RB3 (3)	tsc_RB4 (4)	tsc_RB_BC CH_FACH_ RAB (-19)
LogCh Type	DTCH	CCCH	DCCH	DCCH	DCCH	DCCH	BCCH
LogCh Identity	tsc_DL_DTC H1 (7)	tsc_DL_CC CH6 (6)	tsc_DL_DC CH1 (1)	tsc_DL_DC CH2 (2)	tsc_DL_DC CH3 (3)	tsc_DL_DC CH4 (5)	tsc_BCCH7 (7)
RLC mode	AM	UM	UM	AM	AM	AM	TM
MAC priority	1	1	2	3	4	5	6
TrCH Type	FACH	FACH					
TrCH identity	tsc_FACH4 (17)	tsc_FACH3 (16)					
PhyCh Type	Secondary CCPCH						
PhyCH identity	tsc_S_CCPCH3 (13)						

8.3.26 Configuration of PS Cell_DCH_DSCH_PS_RAB

The configuration is based on 3GPP TS 34.108 [3], clause 6.10.2.4.2.1. The RB0/UM-CCCH is referred to 3GPP TS 34.108 [3], clause 6.10.2.4.3.2.1.2 and RB0/TM-CCCH is referred to 3GPP TS 34.108 [3], clause 6.10.2.4.4.1.1.1. The configuration is applied to those RAB signalling tests where a PS RAB on DTCH is setup for the interactive or background service class is mapped on to DSCH.

The uplink configuration is same in clause 8.3.8.

Table 8.3.26: Downlink configuration of PS Cell_DCH_DSCH_PS_RAB

RB Identity	tsc_RB20 (20)	Same as downlink configuration of Cell_DCH_StandAloneSRB on DPCH	Same as downlink configuration of Cell_DCH_StandAloneSRB on sCCPCH
LogCh Type	DTCH		
LogCh Identity	tsc_DL_DTCH1 (7)		
RLC mode	AM		
MAC priority	1		
TrCH Type	DSCH		
TrCH identity	tsc_DSCH1 (19)		
PhyCh Type	PDSCH	DPCH	Secondary CCPCH
PhyCH identity	tsc_DL_PDSCH1 (16)	tsc_DL_DPCH1 (26)	tsc_S_CCPCH1 (5)

8.3.27 Configuration of Cell_DCH_DSCH_CS_PS

The configuration is based on 3GPP TS 34.108 [3], clauses 6.10.2.4.2.4. The RB0/UM-CCCH is referred to 3GPP TS 34.108 [3], clause 6.10.2.4.3.2.1.2 and RB0/TM-CCCH is referred to 3GPP TS 34.108 [3], clause 6.10.2.4.4.1.1.1. The configuration is applied to RB tests.

The Uplink configuration is similar to clause 8.3.14.

Table 8.3.27: Downlink configuration of Cell_DCH_DSCH_CS_PS

RB Identity	tsc_RB10 (10)	tsc_RB11 (11)	tsc_RB12 (12)	tsc_RB20 (20)	Same as downlink configuration of Cell_DCH_Stand AloneSRB on DPCH	Same as downlink configuration of Cell_DCH_StandAlone SRB on sCCPCH
LogCh Type	DTCH	DTCH	DTCH	DTCH		
LogCh Identity	tsc_DL_DTCH1 (7)	tsc_DL_DTCH2 (8)	tsc_DL_DTCH3 (9)	tsc_DL_DTCH4 (10)		
RLC mode	TM	TM	TM	AM		
MAC priority	1	1	1	1		
TrCH Type	DCH	DCH	DCH	DSCH		
TrCH identity	tsc_DL_DCH 1 (6)	tsc_DL_DCH 2 (7)	Tsc_DL_DCH 3 (8)	tsc_DL_DSC H1 (19)		
PhyCh Type	DPCH			PDSCH	DPCH	Secondary CCPCH
PhyCH identity	tsc_DL_DPCH1 (20)			tsc_DL_PDS CH1 (16)	tsc_DL_DPCH1 (20)	tsc_S_CCPCH1 (5)

8.3.28 Configuration of Cell_FACH_2SCCPCH_StandAlonePCH_2a

The configuration is based on 3GPP TS 34.108 [3], clause 6.10.2.4.3.2a for downlink and 3GPP TS 34.108 [3] except the mapping of PCH, clause 6.10.2.4.4.2 for uplink. The configuration is applied to the RAB tests.

Table 8.3.28.1: Uplink configuration of Configuration of Configuration of Cell_FACH_2SCCPCH_StandAlonePCH_2a

RB Identity	tsc_RB24 (24)	tsc_RB20 (20)	tsc_RB0 (0)	tsc_RB1 (1)	tsc_RB2 (2)	tsc_RB3 (3)	tsc_RB4 (4)
LogCh Type	DTCH	DTCH	CCCH	DCCH	DCCH	DCCH	DCCH
LogCh Identity	tsc_UL_DTCH4 (10)	tsc_UL_DTCH1 (7)	tsc_UL_CCCH5 (5)	tsc_UL_DCCH1 (1)	tsc_UL_DCCH2 (2)	tsc_UL_DCCH3 (3)	tsc_UL_DCCH4 (4)
RLC mode	AM	AM	TM	UM	AM	AM	AM
TrCH Type	RACH						
TrCH identity	tsc_RACH1 (15)						
PhyCh Type	PRACH						
PhyCH identity	tsc_PRACH1 (8)						

Table 8.3.28.2: Downlink configuration of Cell_FACH_2SCCPCH_StandAlonePCH_2a

RB Identity	tsc_RB20 (20)	tsc_RB24 (24)	tsc_RB0 (0)	tsc_RB1 (1)	tsc_RB2 (2)	tsc_RB3 (3)	tsc_RB4 (4)	tsc_RB_BCCH_FACH (-3)	tsc_RB_2ndPCCH (-4)	
LogCh Type	DTCH	DTCH	CCCH	DCCH	DCCH	DCCH	DCCH	BCCH	PCCH	
LogCh Identity	tsc_DL_DTCH1 (7)	tsc_DL_DTC H4 (10)	tsc_DL_CC CH5 (5)	tsc_DL_DC CH1 (1)	tsc_DL_DC CH2 (2)	tsc_DL_DC CH3 (3)	tsc_DL_DC CH4 (4)	tsc_BCCH6 (6)	tsc_PCCH1 (1)	
RLC mode	AM	AM	UM	UM	AM	AM	AM	TM	TM	
MAC priority	1	1	1	2	3	4	5	6	1	
TrCH Type	FACH	FACH	FACH						PCH	
TrCH identity	tsc_FACH2 (14)		tsc_FACH1(13)						tsc_PCH1 (12)	
PhyCh Type	Secondary CCPCH								Secondary CCPCH	
PhyCH identity	tsc_S_CCPCH2 (10)								tsc_S_CCPCH1 (5)	

8.3.29 Configuration of Cell_FACH_3_SCCPCH_4_FACH_2a_Cnfg1

The configuration is based on 3GPP TS 34.108 [3], clause 6.10.2.4.3.2a for downlink and 3GPP TS 34.108 [3], clause 6.10.2.4.4.2 for uplink. The configuration is applied to the RAB tests.

The uplink configuration of Cell_FACH_3_SCCPCH_4_FACH Cnfg1 is the same as the uplink configuration of Cell_FACH_2_SCCPCH_StandAlonePCH_2a.

**Table 8.3.29.1: Downlink configuration of Cell_FACH_3_SCCPCH_4_FACH_2a_Cnfg1:
1st & 2nd S-CCPCH**

RB Identity			tsc_RB0 (0)	tsc_RB_BCCH_F ACH (-3)	tsc_RB_PCCH (-2)
LogCh Type			CCCH	BCCH	PCCH
LogCh Identity			tsc_DL_CCCH5 (5)	tsc_BCCH6 (6)	tsc_PCCH1 (1)
RLC mode			UM	TM	TM
MAC priority			1	6	1
TrCH Type	FACH	FACH	FACH		PCH
TrCH identity	tsc_FACH2 (14)		tsc_FACH1 (13)		tsc_PCH1 (12)
PhyCh Type	Secondary CCPCH				Secondary CCPCH
PhyCH identity	tsc_S_CCPCH2 (10)				tsc_S_CCPCH1 (5)

**Table 8.3.29.2: Downlink configuration of Cell_FACH_3_SCCPCH_4_FACH_2a_Cnfg1:
3rd S-CCPCH**

RB Identity	tsc_RB24 (24)	tsc_RB2 0 (20)	tsc_RB2 9 (29)	tsc_RB1 (1)	tsc_RB2 (2)	tsc_RB 3 (3)	tsc_RB4 (4)	tsc_RB_BCCH _FACH_RAB (-19)
LogCh Type	DTCH	DTCH	CCCH	DCCH	DCCH	DCCH	DCCH	BCCH
LogCh Identity	tsc_DL_DTC H4 (10)	tsc_DL_ DTCH1 (7)	tsc_DL_ CCCH6 (6)	tsc_DL_ DCCH1 (1)	tsc_DL_ DCCH2 (2)	tsc_DL_ _DCCH 3 (3)	tsc_DL_D CCH4 (4)	tsc_BCCH7 (7)
RLC mode	AM	AM	UM	UM	AM	AM	AM	TM
MAC priority	1	1	1	2	3	4	5	6
TrCH Type	FACH		FACH					
TrCH identity	tsc_FACH4 (17)		tsc_FACH3 (16)					
PhyCh Type	Secondary CCPCH							
PhyCH identity	tsc_S_CCPCH3 (13)							

8.3.30 Configuration of Cell_FACH_3_SCCPCH_4_FACH_2a_Cnfg2

The configuration is based on 3GPP TS 34.108 [3], clause 6.10.2.4.3.2a for downlink and 3GPP TS 34.108 [3], clause 6.10.2.4.4.2 for uplink. The configuration is applied to the RAB tests.

The uplink configuration of Cell_FACH_3_SCCPCH_4_FACH Cnfg2 is the same as the uplink configuration of Cell_FACH_2_SCCPCH_StandAlonePCH_2a.

Table 8.3.30.1: Downlink configuration of Cell_FACH_3_SCCPCH_4_FACH_2a_Cnfg2: 2nd S-CCPCH

RB Identity	tsc_RB21 (24)	tsc_RB2 0 (20)	tsc_RB2 9 (29)	tsc_RB 1 (1)	tsc_RB2 (2)	tsc_RB3 (3)	tsc_RB4 (4)	tsc_RB_ BCCH_F ACH_RA B (-19)
LogCh Type	DTCH	DTCH	CCCH	DCCH	DCCH	DCCH	DCCH	BCCH
LogCh Identity	tsc_DL_D TCH2 (10)	tsc_DL_ DTCH1 (7)	tsc_DL_ CCCH6 (6)	tsc_DL_ _DCCH 1 (1)	tsc_DL_ DCCH2 (2)	tsc_DL_ DCCH3 (3)	tsc_DL_ DCCH4 (4)	tsc_BCC H7 (7)
RLC mode	AM	AM	UM	UM	AM	AM	AM	TM
MAC priority	1	1	1	2	3	4	5	6
TrCH Type	FACH	FACH	FACH					
TrCH identity	tsc_FACH2 (14)		tsc_FACH1 (13)					
PhyCh Type	Secondary CCPCH							
PhyCH identity	tsc_S_CCPCH2 (10)							

**Table 8.3.30.2 Downlink configuration of Cell_FACH_3_SCCPCH_4_FACH_2a_Cnfg2:
1st & 3rd S-CCPCH**

RB Identity			tsc_RB0 (0)	tsc_RB_BCCH_ FACH (-3)	tsc_RB_PCCH (-2)
LogCh Type			CCCH	BCCH	PCCH
LogCh Identity			tsc_DL_CCCH 5 (5)	tsc_BCCH6 (6)	tsc_PCCH1 (1)
RLC mode			UM	TM	TM
MAC priority			1	6	1
TrCH Type	FACH	FACH	FACH		PCH
TrCH identity	tsc_FACH4 (17)		tsc_FACH3 (16)		tsc_PCH1 (12)
PhyCh Type	Secondary CCPCH				Secondary CCPCH
PhyCH identity	tsc_S_CCPCH3 (13)				tsc_S_CCPCH1 (5)

8.3.31 Configuration of Cell_FACH_3_SCCPCH_3_FACH_CTCH_2a

The configuration is based on 3GPP TS 34.108 [3], clause 6.10.2.4.3.2 for downlink and 3GPP TS 34.108 [3], clause 6.10.2.4.4.2 for uplink. The configuration is applied to the RAB tests.

The uplink configuration of Cell_FACH_3_SCCPCH_3_FACH_CTCH_2a is the same as the uplink configuration of Cell_FACH Cell_FACH_3_SCCPCH_4_FACH Cnfg1.

Table 8.3.31.1: Downlink configuration of Cell_FACH_3_SCCPCH_3_FACH_CTCH_2a: 1st & 2nd S-CCPCH

RB Identity	tsc_RB30 (30)	tsc_RB0 (0)	tsc_RB_BCCH_ FACH (-3)	tsc_RB_PCCH (-2)
LogCh Type	CTCH	CCCH	BCCH	PCCH
LogCh Identity	tsc_CTCH1 (11)	tsc_DL_CCCH5 (5)	tsc_BCCH6 (6)	tsc_PCCH1 (1)
RLC mode	UM	UM	TM	TM
MAC priority	7	1	6	1
TrCH Type	FACH	FACH		PCH
TrCH identity	tsc_FACH2 (14)	tsc_FACH1 (13)		tsc_PCH1 (12)
PhyCh Type	Secondary CCPCH			Secondary CCPCH
PhyCH identity	tsc_S_CCPCH2 (10)			tsc_S_CCPCH1 (5)

Table 8.3.31.2 Downlink configuration of Cell_FACH_3_SCCPCH_3_FACH_CTCH_2a: 3rd S-CCPCH

RB Identity	tsc_RB24 (24)	tsc_RB20 (20)	tsc_RB2 9 (29)	tsc_RB1 (1)	tsc_RB2 (2)	tsc_RB3 (3)	tsc_RB4 (4)	tsc_RB_ BCCH_F ACH_RA B (-19)
LogCh Type	DTCH	DTCH	CCCH	DCCH	DCCH	DCCH	DCCH	BCCH
LogCh Identity	tsc_DL_D TCH4(10)	tsc_DL_D TCH1 (7)	tsc_DL_ CCCH6 (6)	tsc_DL_ DCCH1 (1)	tsc_DL_ DCCH2 (2)	tsc_DL_ DCCH3 (3)	tsc_DL_ DCCH4 (5)	tsc_BCC H7 (7)
RLC mode	AM	AM	UM	UM	AM	AM	AM	TM
MAC priority	1	1	1	2	3	4	5	6
TrCH Type	FACH	FACH	FACH					
TrCH identity	tsc_FACH4 (17)		tsc_FACH3 (16)					
PhyCh Type	Secondary CCPCH							
PhyCH identity	tsc_S_CCPCH3 (13)							

8.3.32 Configuration of Cell_DCH_HS_DSCH (Rel-5 or later)

The configuration is based on 3GPP TS 34.108 [3], clause 6.10.2.4.5.1 or 6.10.2.4.5.2. The RB0/UM-CCCH is referred to 3GPP TS 34.108 [3], clause 6.10.2.4.3.2.1.2 and RB0/TM-CCCH is referred to 3GPP TS 34.108 [3], clause 6.10.2.4.4.1.1.1. The configuration is applied to those RRC and NAS signalling tests in the DCH state where a PS RAB on DTCH mapped on HS-DSCH is setup for the interactive or background service class.

Table 8.3.32.1: Uplink configuration of Cell_DCH_HS_DSCH

RB Identity	tsc_RB25 (25)	Same as uplink configuration of Cell_DCH_StandAloneSRB on DPCH	Same as uplink configuration of Cell_DCH_StandAloneSRB on PRACH
LogCh Type	DTCH		
LogCh Identity	tsc_UL_DTCH1 (7)		
RLC mode	AM		
TrCH Type	DCH		
TrCH identity	tsc_UL_DCH1 (1)		
PhyCh Type	DPDCH		PRACH
PhyCH identity	tsc_UL_DPCH1 (20)		tsc_PRACH1 (8)

Table 8.3.32.2: Downlink configuration of Cell_DCH_HS_DSCH

RB Identity	tsc_RB25 (25)	Same as downlink configuration of Cell_DCH_StandAloneSRB on DPCH	Same as downlink configuration of Cell_DCH_StandAloneSRB on sCCPCH
LogCh Type	DTCH		
LogCh Identity	tsc_DL_DTCH1 (7)		
RLC mode	AM		
MAC priority	8		
TrCH Type	HS-DSCH		
TrCH identity /QueueID	0		
PhyCh Type	PDSCH	DPCH	Secondary CCPCH
PhyCH identity	tsc_HSPDSCH (18)	tsc_DL_DPCH1 (26)	tsc_S_CCPCH1 (5)

8.3.32a Configuration of Cell_DCH_E_DPCH_PS

The configuration is based on 3GPP TS 34.108 [3], clauses 6.11.5.4.7.8. The RB0/UM-CCCH is referred to 3GPP TS 34.108 [3], clause 6.10.2.4.3.2.1.2 and RB0/TM-CCCH is referred to 3GPP TS 34.108 [3], clause 6.10.2.4.4.1.1.1.

The configuration is applied to LCR TDD RB tests.

Table 8.3.32a.1: Uplink configuration of Cell_DCH_E_DPCH_PS

RB Identity	tsc_RB25 (25)	Same as uplink configuration of Cell_DCH_StandAloneSRB on DPCH	Same as uplink configuration of Cell_DCH_StandAloneSRB on PRACH
LogCh Type	DTCH		
LogCh Identity	tsc_UL_DTCH1 (7)		
RLC mode	AM		
TrCH Type	E-DCH		
TrCH identity/Mac-d Flow Id	2		
PhyCh Type	E-DPDCH	DPDCH	PRACH
PhyCH identity	tsc_E_DPCH (22)	tsc_UL_DPCH1 (20)	tsc_PRACH1 (8)

Table 8.3.32a.2: Downlink configuration of PS Cell_DCH_E_DPCH_PS

RB Identity	tsc_RB25 (25)	Same as downlink configuration of Cell_DCH_StandAloneSRB on DPCH	Same as downlink configuration of Cell_DCH_StandAloneSRB on sCCPCH
LogCh Type	DTCH		
LogCh Identity	tsc_DL_DTC H1 (7)		
RLC mode	AM		
MAC priority	1		
TrCH Type	DCH		
TrCH identity	tsc_DL_DCH 1 (6)		
PhyCh Type	DPCH		Secondary CCPCH
PhyCH identity	tsc_DL_DPCH1 (26)		tsc_S_CCPCH1 (5)

8.3.33 Configuration of cell_One_DTCH_HS_DSCH_MAC (Rel-5 or later)

The configuration is based on 3GPP TS 34.108 [3], clause 6.10.2.4.5.1. The RB0/UM-CCCH is referred to 3GPP TS 34.108 [3], clause 6.10.2.4.3.2.1.2 and RB0/TM-CCCH is referred to 3GPP TS 34.108 [3], clause 6.10.2.4.4.1.1.1. The configuration is applied to those MAC-hs/MAC-ehs[Rel-7 or later] Signalling tests in the DCH state where a PS RAB on DTCH mapped on HS-DSCH is setup for the interactive or background service class.

Table 8.3.33.1: Uplink configuration of cell_One_DTCH_HS_DSCH_MAC

RB Identity	tsc_RB_MAC_HS (-25)	Same as uplink configuration of Cell_DCH_StandAloneSRB on DPCH	Same as uplink configuration of Cell_DCH_StandAloneSRB on PRACH
LogCh Type	DTCH		
LogCh Identity	tsc_UL_DTCH1 (7)		
RLC mode	TM		
TrCH Type	DCH		
TrCH identity	tsc_UL_DCH1 (1)		
PhyCh Type	DPDCH		PRACH
PhyCH identity	tsc_UL_DPCH1 (20)		tsc_PRACH1 (8)

Table 8.3.33.2: Downlink configuration of Cell_DCH_HS_DSCH

RB Identity	tsc_RB_MAC_HS (- 25)	Same as downlink configuration of Cell_DCH_StandAloneSRB on DPCH	Same as downlink configuration of Cell_DCH_StandAloneSRB on sCCPCH
LogCh Type	DTCH		
LogCh Identity	tsc_DL_DTCH1 (7)		
RLC mode	TM		
MAC priority	8		
TrCH Type	HS-DSCH		
TrCH identity /QueueID	0		
PhyCh Type	PDSCH	DPCH	Secondary CCPCH
PhyCH identity	tsc_HSPDSCH (18)	tsc_DL_DPCH1 (26)	tsc_S_CCPCH1 (5)

8.3.33a Configuration of cell_Three_DTCH_1Q_HS_DSCH_MAC (Rel-7 or later)

The configuration is based on 3GPP TS 34.108 [3], clause 6.11.4f. The RB0/UM-CCCH is referred to 3GPP TS 34.108 [3], clause 6.10.2.4.3.2.1.2 and RB0/TM-CCCH is referred to 3GPP TS 34.108 [3], clause 6.10.2.4.4.1.1.1. The configuration is applied to those MAC-ehs Signalling tests in the DCH state where a 3 PS RAB on DTCH mapped on HS-DSCH [1 MAC-ehs Queue] is setup for the interactive or background service class.

Table 8.3.33a.1: Uplink configuration of cell_Three_DTCH_1Q_HS_DSCH_MAC

RB Identity	tsc_RB_MAC_HS (-25)	tsc_RB_MAC_ehs_26 (-26)	tsc_RB_MAC_ehs_27 (-27)	Same as uplink configuration of Cell_DCH_StandAloneSRB on DPCH	Same as uplink configuration of Cell_DCH_StandAloneSRB on PRACH
LogCh Type	DTCH	DTCH	DTCH		
LogCh Identity	Tsc_UL_DTCH1 (7)	tsc_UL_DTCH2 (8)	tsc_UL_DTCH3 (9)		
RLC mode	TM	TM	TM		
TrCH Type	DCH				
TrCH identity	tsc_UL_DCH1 (1)				
PhyCh Type	DPDCH				PRACH
PhyCH identity	tsc_UL_DPCH1 (20)				tsc_PRACH1 (8)

Table 8.3.33a.2: Downlink configuration of cell_Three_DTCH_1Q_HS_DSCH_MAC

RB Identity	tsc_RB_MAC_HS (-25)	tsc_RB_MAC_ehs_26 (-26)	tsc_RB_MAC_ehs_27 (-27)	Same as downlink configuration of Cell_DCH_StandAloneSRB on DPCH	Same as downlink configuration of Cell_DCH_StandAloneSRB on sCCPCH
LogCh Type	DTCH	DTCH	DTCH		
LogCh Identity	tsc_DL_DTCH1 (7)	tsc_DL_DTCH2 (8)	tsc_DL_DTCH3 (9)		
RLC mode	TM	TM	TM		
MAC priority	8	8	8		
TrCH Type	HS-DSCH				
TrCH identity /QueueID	0				
PhyCh Type	PDSCH			DPCH	Secondary CCPCH
PhyCH identity	tsc_HSPDSCH (18)			tsc_DL_DPCH1 (26)	tsc_S_CCPCH1 (5)

8.3.33b Configuration of cell_Three_DTCH_3Q_HS_DSCH_MAC (Rel-7 or later)

The configuration is based on 3GPP TS 34.108 [3], clause 6.11.4f. The RB0/UM-CCCH is referred to 3GPP TS 34.108 [3], clause 6.10.2.4.3.2.1.2 and RB0/TM-CCCH is referred to 3GPP TS 34.108 [3], clause 6.10.2.4.4.1.1.1. The configuration is applied to those MAC-ehs Signalling tests in the DCH state where a 3 PS RAB on DTCH mapped on HS-DSCH [1 MAC-ehs Queue] is setup for the interactive or background service class.

The uplink configuration of cell_Three_DTCH_3Q_HS_DSCH_MAC is the same as the uplink configuration of cell_Three_DTCH_1Q_HS_DSCH_MAC

Table 8.3.33b: Downlink configuration of cell_Three_DTCH_3Q_HS_DSCH_MAC

RB Identity	Tsc_RB_MAC_HS (-25)	tsc_RB_MAC_ehs_26 (-26)	tsc_RB_MAC_ehs_27 (-27)	Same as downlink configuration of Cell_DCH_StandAloneSRB on DPCH	Same as downlink configuration of Cell_DCH_StandAloneSRB on sCCPCH
LogCh Type	DTCH	DTCH	DTCH		
LogCh Identity	tsc_DL_DTCH1 (7)	tsc_DL_DTCH2 (8)	tsc_DL_DTCH3 (9)		
RLC mode	TM	TM	TM		
MAC priority	8	8	8		
TrCH Type	HS-DSCH	HS-DSCH	HS-DSCH		
TrCH identity /QueueID	0	1	2		
PhyCh Type	PDSCH			DPCH	Secondary CCPCH
PhyCH identity	tsc_HSPDSCH (18)			tsc_DL_DPCH1 (26)	tsc_S_CCPCH1 (5)

8.3.33c Configuration of Cell_E_HS_SRB_MAC_TM_RAB (Rel-7 or later)

The configuration is based on 3GPP TS 34.108 [3], clause 6.10.2.4.6.3, with RAB configured in TM mode on SS side. The RB0/UM-CCCH is referred to 3GPP TS 34.108 [3], clause 6.10.2.4.3.2.1.2 and RB0/TM-CCCH is referred to 3GPP TS 34.108 [3], clause 6.10.2.4.4.1.1.1.

The configuration is applied to RRC signalling tests in the DCH state where a PS RAB is setup for the interactive or background service class (A14):

- PS RAB on DTCH is mapped on E-DCH in uplink and HS-DSCH in downlink.
- Uplink SRBs on DCCH are mapped on E-DCH.
- Downlink SRBs on DCCH are mapped on HS-DSCH.

Table 8.3.33c.1: Uplink configuration of Cell_E_HS_SRB_MAC_TM_RAB

RB Identity	tsc_RB_DTCH_E_DCH_MAC1 (-21)	Same as uplink configuration of Cell_DCH_StandAloneSRB on DPCH	Same as uplink configuration of Cell_DCH_StandAloneSRB on PRACH
LogCh Type	DTCH		
LogCh Identity	tsc_UL_DTCH1 (7)		
RLC mode	TM		
TrCH Type	E-DCH		
TrCH identity/ Mac-d Flow Id	2	1	
PhyCh Type	E-DPDCH		PRACH
PhyCH identity	tsc_E_DPCH (22)		tsc_PRACH1 (8)

Table 8.3.33c.2: Downlink configuration of Cell_E_HS_SRB_MAC_TM_RAB

RB Identity	tsc_RB_DTCH_E_DCH_MAC1 (-21)	Same as downlink configuration of Cell_DCH_StandAloneSRB on DPCH	Same as downlink configuration of Cell_DCH_StandAloneSRB on sCCPCH
LogCh Type	DTCH		
LogCh Identity	tsc_DL_DTCH1 (7)		
RLC mode	TM		
MAC priority	8		
TrCH Type	HS-DSCH		
TrCH identity / Mac-d Flow Id	0	1	
PhyCh Type	PDSCH		Secondary CCPCH
PhyCH identity	tsc_HSPDSCH (18)		tsc_S_CCPCH1 (5)

8.3.34 Configuration of Cell_2UM_3AM_DCH_HS_DSCH (Rel-5 or later)

The configuration is based on 3GPP TS 34.108 [3], clause 6.11.4a The RB0/UM-CCCH is referred to 3GPP TS 34.108 [3], clause 6.10.2.4.3.2.1.2 and RB0/TM-CCCH is referred to 3GPP TS 34.108 [3], clause 6.10.2.4.4.1.1.1. The configuration is applied to MAC test case 7.1.5.2.

Table 8.3.34.1: Uplink configuration of Cell_2UM_3AM_DCH_HS_DSCH

RB Identity	tsc_RB26 (26)	tsc_RB27 (27)	tsc_RB25 (25)	tsc_RB28 (28)	tsc_RB17 (17)	Same as uplink configuration of Cell_DCH_StandAloneSRB on DPCH	Same as uplink configuration of Cell_DCH_StandAloneSRB on PRACH
LogCh Type	DTCH	DTCH	DTCH	DTCH	DTCH		
LogCh Identity	tsc_UL_DTCH1 (7)	tsc_UL_DTCH2 (8)	tsc_UL_DTCH3 (9)	tsc_UL_DTCH4 (10)	tsc_UL_DTCH5 (13)		
RLC mode	UM	UM	AM	AM	AM		
TrCH Type	DCH						
TrCH identity	tsc_UL_DCH1 (1)						
PhyCh Type	DPDCH						PRACH
PhyCH identity	tsc_UL_DPCH1 (20)						tsc_PRACH1 (8)

Table 8.3.34.2: Downlink configuration of Cell_2UM_3AM_DCH_HS_DSCH

RB Identity	tsc_RB26 (26)	tsc_RB27 (27)	tsc_RB25 (25)	tsc_RB28 (28)	tsc_RB17 (17)	Same as downlink configuration of Cell_DCH_StandAloneSRB on DPCH	Same as downlink configuration of Cell_DCH_StandAloneSRB on sCCPCH
LogCh Type	DTCH	DTCH	DTCH	DTCH	DTCH		
LogCh Identity	tsc_DL_DTCH1 (7)	tsc_DL_DTCH2 (8)	tsc_DL_DTCH3 (9)	tsc_DL_DTCH4 (10)	tsc_DL_DTCH5 (11)		
RLC mode	UM	UM	AM	AM	AM		
MAC priority	8	8	8	8	8		
TrCH Type	HS-DSCH						
TrCH identity /QueueID	0		1		2		
PhyCh Type	PDSCH					DPCH	Secondary CCPCH
PhyCH identity	tsc_HSPDSCH (18)					tsc_DL_DPCH1 (26)	tsc_S_CCPCH1 (5)

8.3.35 Configuration of Cell_DCH_Speech_WAMR (Rel-5 or later)

The configuration is based on 3GPP TS 34.108 [3], clauses 6.10.2.4.1.62. The RB0/UM-CCCH is referred to 3GPP TS 34.108 [3], clause 6.10.2.4.3.2.1.2 and RB0/TM-CCCH is referred to 3GPP TS 34.108[3], clause 6.10.2.4.4.1.1.1. The configuration is applied to RAB test 14.2.62.

Table 8.3.35.1: Uplink configuration of Cell_DCH_Speech_WAMR

RB Identity	tsc_RB10 (10)	tsc_RB11 (11)	Same as uplink configuration of Cell_DCH_StandAloneSRB on DPCH	Same as uplink configuration of Cell_DCH_StandAloneSRB on PRACH
LogCh Type	DTCH	DTCH		
LogCh Identity	tsc_UL_DT CH1 (7)	tsc_UL_DTCH 2 (8)		
RLC mode	TM	TM		
TrCH Type	DCH	DCH		
TrCH identity	tsc_UL_D CH1 (1)	tsc_UL_DCH2 (2)		
PhyCh Type	DPDCH		PRACH	
PhyCH identity	tsc_UL_DPCH1 (20)		tsc_PRACH1 (8)	

Table 8.3.35.2: Downlink configuration of Cell_DCH_Speech_WAMR

RB Identity	tsc_RB10 (10)	tsc_RB11 (11)	tsc_RB5 (5)	Same as downlink configuration of Cell_DCH_StandAloneSRB on DPCH	Same as downlink configuration of Cell_DCH_StandAloneSRB on sCCPCH
LogCh Type	DTCH	DTCH	DCCH		
LogCh Identity	tsc_DL_DT CH1 (7)	tsc_DL_DTC H2 (8)	tsc_DL_DC CH5 (5)		
RLC mode	TM	TM	TM		
MAC priority	1	1	5		
TrCH Type	DCH	DCH	DCH		
TrCH identity	tsc_DL_D CH1 (6)	tsc_DL_DC H2 (7)	tsc_DL_DC H6 (22)		
PhyCh Type	DPCH			Secondary CCPCH	
PhyCH identity	tsc_DL_DPCH1 (26)			tsc_S_CCPCH1 (5)	

8.3.36 Configuration of PS Cell_Four_DTCH_HS_CS and Cell_Four_DTCH_CS_HS (Rel-5 or later)

The configuration is based on 3GPP TS 34.108 [3], clause 6.10.2.4.5.3 and 6.10.2.4.5.3a. The RB0/UM-CCCH is referred to 3GPP TS 34.108 [3], clause 6.10.2.4.3.2.1.2 and RB0/TM-CCCH is referred to 3GPP TS 34.108 [3], clause 6.10.2.4.4.1.1.1.

The uplink configuration is same in clause 8.3.14 except a HS-DPCCH shall be included in the UL_DPCH and tsc_RB25 shall be used instead of tsc_RB20.

Table 8.3.36: Downlink configuration of PS Cell_Four_DTCH_HS_CS and Cell_Four_DTCH_CS_HS

RB Identity	tsc_RB25 (25)	tsc_RB10 (10)	tsc_RB11 (11)	tsc_RB12 (12)	Same as downlink configuration of Cell_DCH_StandAloneSRB on DPCH	Same as downlink configuration of Cell_DCH_StandAloneSRB on sCCPCH
LogCh Type	DTCH	DTCH	DTCH	DTCH		
LogCh Identity	tsc_DL_DTCH4 (10)	tsc_DL_DTC H1 (7)	tsc_DL_DTCH 2 (8)	tsc_DL_DTCH3 (9)		
RLC mode	AM	TM	TM	TM		
MAC priority	8	1	1	1		
TrCH Type	HS_DSCH	DCH	DCH	DCH		
TrCH identity	N/A	tsc_DL_DC H1 (6)	tsc_DL_DCH2 (7)	tsc_DL_DCH3 (8)		
PhyCh Type	HS-PDSCH	DPCH			Secondary CCPCH	
PhyCH identity	tsc_HSPDSCH (18)	tsc_DL_DPCH1 (26)			tsc_S_CCPC H1 (5)	

8.3.37 Configuration of PS Cell_Two_DTCH_HS_CS (Rel-5 or later)

The configuration is based on 3GPP TS 34.108 [3], clause 6.10.2.4.5.4 and 6.10.2.4.5.4a. The RB0/UM-CCCH is referred to 3GPP TS 34.108 [3], clause 6.10.2.4.3.2.1.2 and RB0/TM-CCCH is referred to 3GPP TS 34.108 [3], clause 6.10.2.4.4.1.1.1.

The uplink configuration is same in clause 8.3.15 except a HS-DPCCH shall be included in the UL_DPCH and tsc_RB25 shall be used instead of tsc_RB20.

Table 8.3.37: Downlink configuration of PS Cell_Two_DTCH_HS_CS

RB Identity	tsc_RB25 (25)	tsc_RB10 (10)	Same as downlink configuration of Cell_DCH_StandAloneSRB on DPCH	Same as downlink configuration of Cell_DCH_StandAloneSRB on sCCPCH
LogCh Type	DTCH	DTCH		
LogCh Identity	tsc_DL_DTCH4 (10)	tsc_DL_DTCH1 (7)		
RLC mode	AM	TM		
MAC priority	8	1		
TrCH Type	HS_DSCH	DCH		
TrCH identity	N/A	tsc_DL_DCH1 (6)		
PhyCh Type	HS-PDSCH	DPCH		Secondary CCPCH
PhyCH identity	tsc_HSPDSCH (18)	tsc_DL_DPCH1 (20)		tsc_S_CCPC1 (5)

8.3.38 Configuration of PS Cell_DCH_64kPS_RAB_SRB_HS (Rel-5 or later)

The configuration is based on 3GPP TS 34.108 [3], clause 6.10.2.4.1.26. The RB0/UM-CCCH is referred to 3GPP TS 34.108 [3], clause 6.10.2.4.3.2.1.2 and RB0/TM-CCCH is referred to 3GPP TS 34.108 [3], clause 6.10.2.4.4.1.1.1.

Table 8.3.38.1: Uplink configuration of PS Cell_DCH_64kPS_RAB_SRB_HS

RB Identity	tsc_RB25 (25)	Same as uplink configuration of Cell_DCH_StandAloneSRB on DPCH	Same as uplink configuration of Cell_DCH_StandAloneSRB on PRACH
LogCh Type	DTCH		
LogCh Identity	tsc_UL_DTC H1 (7)		
RLC mode	AM		
TrCH Type	DCH		
TrCH identity	tsc_UL_DCH 1 (1)		
PhyCh Type	DPDCH		PRACH
PhyCH identity	tsc_UL_DPCH1 (20)		tsc_PRACH1 (8)

Table 8.3.38.2: Downlink configuration of PS Cell_DCH_64kPS_RAB_SRB SRB

RB Identity	tsc_RB25 (25)	Same as downlink configuration of Cell_DCH_StandAloneSRB on DPCH	Same as downlink configuration of Cell_DCH_StandAloneSRB on sCCPCH
LogCh Type	DTCH		
LogCh Identity	tsc_DL_DTC H1 (7)		
RLC mode	AM		
MAC priority	8		
TrCH Type	DCH		
TrCH identity	tsc_DL_DCH 1 (6)		
PhyCh Type	DPCH		Secondary CCPCH
PhyCH identity	tsc_DL_DPCH1 (26)		tsc_S_CCPCH1 (5)

8.3.39 Configuration of PS Cell_DCH_2AM_HS_DSCH (Rel-5 or later)

The configuration is based on 3GPP TS 34.108 [3], clauses 6.10.2.4.1.26 and 6.10.2.4.1.57. The RB0/UM-CCCH is referred to 3GPP TS 34.108 [3], clause 6.10.2.4.3.2.1.2 with 2 AM RAB and RB0/TM-CCCH is referred to 3GPP TS 34.108 [3], clause 6.10.2.4.4.1.1.1. The configuration is applied to MAC and RAB test cases.

Table 8.3.39.1: Uplink configuration of Cell_DCH_2AM_HS_DSCH

RB Identity	tsc_RB25 (25)	tsc_RB17 (17)	Same as uplink configuration of Cell_DCH_StandAloneSRB on DPCH	Same as uplink configuration of Cell_DCH_StandAloneSRB on PRACH
LogCh Type	DTCH	DTCH		
LogCh Identity	tsc_UL_DTCH1 (7)	tsc_UL_DTCH2 (8)		
RLC mode	AM	AM		
TrCH Type	DCH	DCH		
TrCH identity	tsc_UL_DCH1 (1)	tsc_UL_DCH2 (2)		
PhyCh Type	DPDCH			PRACH
PhyCH identity	tsc_UL_DPCH1 (20)			tsc_PRACH1 (8)

Table 8.3.39.2: Downlink configuration of Cell_DCH_2AM_HS_DSCH

RB Identity	tsc_RB25 (25)	tsc_RB17 (17)	Same as downlink configuration of Cell_DCH_StandAloneSRB on DPCH	Same as downlink configuration of Cell_DCH_StandAloneSRB on sCCPCH
LogCh Type	DTCH	DTCH		
LogCh Identity	tsc_DL_DTCH1 (7)	tsc_DL_DTCH2 (8)		
RLC mode	AM	AM		
MAC priority	8	8		
TrCH Type	HS-DSCH	HS-DSCH		
TrCH identity /QueueID	0	1		
PhyCh Type	PDSCH		DPCH	Secondary CCPCH
PhyCH identity	tsc_HSPDSCH (18)		tsc_DL_DPCH1 (26)	tsc_S_CCPCH1 (5)

8.3.39a Configuration of Cell_DCH_2AM_E_DPCH

The configuration is based on 3GPP TS 34.108 [3], clauses 6.11.5.4.7.12. The RB0/UM-CCCH is referred to 3GPP TS 34.108 [3], clause 6.10.2.4.3.2.1.2 and RB0/TM-CCCH is referred to 3GPP TS 34.108 [3], clause 6.10.2.4.4.1.1.1.

The configuration is applied to LCR TDD RB tests.

Table 8.3.39a.1: Uplink configuration of Cell_DCH_2AM_E_DPCH

RB Identity	tsc_RB25 (25)	tsc_RB17 (17)	Same as uplink configuration of Cell_DCH_StandAloneSRB on DPCH	Same as uplink configuration of Cell_DCH_StandAloneSRB on PRACH
LogCh Type	DTCH	DTCH		
LogCh Identity	tsc_UL_DTCH1 (7)	tsc_UL_DTCH2 (8)		
RLC mode	AM	AM		
TrCH Type	E-DCH			
TrCH identity/Mac-d Flow Id	2	3		
PhyCh Type	E-DPDCH		DPDCH	PRACH
PhyCH identity	tsc_E_DPCH (22)		tsc_UL_DPCH1 (20)	tsc_PRACH1 (8)

Table 8.3.39a.2: Downlink configuration of PS Cell_DCH_2AM_E_DPCH

RB Identity	tsc_RB25 (25)	tsc_RB17 (17)	Same as downlink configuration of Cell_DCH_StandAloneSRB on DPCH	Same as downlink configuration of Cell_DCH_StandAloneSRB on sCCPCH
LogCh Type	DTCH	DTCH		
LogCh Identity	tsc_DL_DT CH1 (7)	tsc_DL_DTC H2 (8)		
RLC mode	AM	AM		
MAC priority	1	1		
TrCH Type	DCH	DCH		
TrCH identity	tsc_DL_DC H1 (6)	tsc_DL_DCH 2 (7)		
PhyCh Type	DPCH		Secondary CCPCH	
PhyCH identity	tsc_DL_DPCH1 (26)		tsc_S_CCPCH1 (5)	

8.3.40 Configuration of Cell_Three_DTCH_5SRB (Rel-5 or later)

The configuration is based on 3GPP TS 34.108 [3], clauses 6.10.2.4.1.62. The RB0/UM-CCCH is referred to 3GPP TS 34.108 [3], clause 6.10.2.4.3.2.1.2 and RB0/TM-CCCH is referred to 3GPP TS 34.108 [3], clause 6.10.2.4.4.1.1.1. The configuration is applied to RB tests.

The uplink configuration is same in clause 8.3.3 Cell_DCH_Speech.

Table 8.3.40: Downlink configuration of Cell_Three_DTCH_5SRB

RB Identity	tsc_RB10 (10)	tsc_RB11 (11)	tsc_RB12 (12)	tsc_RB1 (1)	tsc_RB2 (2)	tsc_RB3 (3)	tsc_RB4 (4)	tsc_RB5 (5)	Same as downlink configuration of Cell_DCH_StandAloneSRB on sCCPCH
LogCh Type	DTCH	DTCH	DTCH	DCCH	DCCH	DCCH	DCCH	DCCH	
LogCh Identity	tsc_DL_DTCH 1 (7)	tsc_DL_DTCH 2 (8)	tsc_DL_DTCH 3 (9)	tsc_DL_DCCH 1 (1)	tsc_DL_DCCH 2 (2)	tsc_DL_DCCH 3 (3)	tsc_DL_DCCH 4 (4)	tsc_DL_DCCH 5 (5)	
RLC mode	TM	TM	TM	UM	AM	AM	AM	TM	
MAC priority	1	1	1	1	2	3	4	5	
TrCH Type	DCH	DCH	DCH	DCH				DCH	
TrCH/ Q-identity	tsc_DL_DCH1 (6)	tsc_DL_DCH2 (7)	tsc_DL_DCH3 (8)	tsc_DL_DCH5 (10)				tsc_DL_DCH6 (22)	
PhyCh Type	DPCH								Secondary CCPCH
PhyCH identity	tsc_DL_DPCH1 (26)								tsc_S_CCPC H1 (5)

8.3.41 Configuration of Cell_Five_DTCH_CS_HS (Rel-5 or later)

The configuration is based on 3GPP TS 34.108 [3], clauses 6.10.2.4.5.7. The RB0/UM-CCCH is referred to 3GPP TS 34.108 [3], clause 6.10.2.4.3.2.1.2 and RB0/TM-CCCH is referred to 3GPP TS 34.108 [3], clause 6.10.2.4.4.1.1.1. The configuration is applied to RB tests.

Table 8.3.41.1: Uplink configuration of Cell_Five_DTCH_CS_HS and Cell_Five_DTCH_CS_HS

RB Identity	tsc_RB10 (10)	tsc_RB11 (11)	tsc_RB12 (12)	tsc_RB25 (25)	tsc_RB17 (17)	Same as uplink configuration of Cell_DCH_StandAloneSRB on DPCH except TrCH Identity is tsc_UL_DCH6 (21)	Same as uplink configuration of Cell_DCH_StandAloneSRB on PRACH
LogCh Type	DTCH	DTCH	DTCH	DTCH	DTCH		
LogCh Identity	tsc_UL_D TCH1 (7)	tsc_UL_D TCH2 (8)	tsc_UL_D TCH3 (9)	tsc_UL_D TCH4 (10)	tsc_UL_D TCH5 (13)		
RLC mode	TM	TM	TM	AM	AM		
MAC priority	1	1	1	1	1		
TrCH Type	DCH	DCH	DCH	DCH	DCH		
TrCH identity	tsc_UL_D CH1 (1)	tsc_UL_D CH2 (2)	tsc_UL_D CH3 (3)	tsc_UL_D CH4 (4)	tsc_UL_D CH5 (5)		
PhyCh Type	DPDCH						PRACH
PhyCH identity	tsc_UL_DPCH1 (20)						tsc_PRACH1 (8)

Table 8.3.41.2: Downlink configuration of PS Cell_Five_DTCH_HS_CS and Cell_Five_DTCH_CS_HS

RB Identity	tsc_RB25 (25)	tsc_RB17 (17)	tsc_RB10 (10)	tsc_RB11 (11)	tsc_RB12 (12)	Same as downlink configuration of Cell_DCH_StandAloneSRB on DPCH	Same as downlink configuration of Cell_DCH_StandAloneSRB on sCCPCH
LogCh Type	DTCH	DTCH	DTCH	DTCH	DTCH		
LogCh Identity	tsc_DL_D TCH4 (10)	tsc_DL_DT CH5 (11)	tsc_DL_DTC H1 (7)	tsc_DL_D TCH2 (8)	tsc_DL_DTC H3 (9)		
RLC mode	AM	AM	TM	TM	TM		
MAC priority	8	8	1	1	1		
TrCH Type	HS_DSCH	HS_DSCH	DCH	DCH	DCH		
TrCH identity	N/A	N/A	tsc_DL_DC H1 (6)	tsc_DL_D CH2 (7)	tsc_DL_DC H3 (8)		
PhyCh Type	HS-PDSCH		DPCH			Secondary CCPCH	
PhyCH identity	tsc_HSPDSCH (18)		tsc_DL_DPCH1 (26)			tsc_S_CCPCH1 (5)	

8.3.41a Configuration of Cell_FiveDTCH_E_DPCH

The configuration is based on 3GPP TS 34.108 [3], clauses 6.11.5.4.7.15. The RB0/UM-CCCH is referred to 3GPP TS 34.108 [3], clause 6.10.2.4.3.2.1.2 and RB0/TM-CCCH is referred to 3GPP TS 34.108 [3], clause 6.10.2.4.4.1.1.1.

The configuration is applied to LCR TDD RB tests.

Table 8.3.41a.1: Uplink configuration of Cell_FiveDTCH_E_DPCH

RB Identity	tsc_RB25 (25)	tsc_RB17 (17)	tsc_RB10 (10)	tsc_RB11 (11)	tsc_RB12 (12)	Same as uplink configuration of Cell_DCH_StandAloneSRB on DPCH	Same as uplink configuration of Cell_DCH_StandAloneSRB on PRACH
LogCh Type	DTCH	DTCH	DTCH	DTCH	DTCH		
LogCh Identity	tsc_UL_DTCH4 (10)	tsc_UL_DTC H5 (13)	tsc_UL_DTC H1 (7)	tsc_UL_DT CH2 (8)	tsc_UL_DT CH3 (9)		
RLC mode	AM	AM	TM	TM	TM		
TrCH Type	E-DCH		DCH	DCH	DCH		
TrCH identity/Mac-d Flow Id	2	3	tsc_UL_DCH 1 (1)	tsc_UL_DC H2 (2)	tsc_UL_DC H3 (3)		
PhyCh Type	E-DPDCH		DPDCH			PRACH	
PhyCH identity	tsc_E_DPCH (22)		tsc_UL_DPCH1 (20)			tsc_PRACH1 (8)	

Table 8.3.41a.2: Downlink configuration of PS Cell_FiveDTCH_E_DPCH

RB Identity	tsc_RB1 0 (10)	tsc_RB11 (11)	tsc_RB12 (12)	tsc_RB25 (25)	tsc_RB17 (17)	Same as downlink configuration of Cell_DCH_StandAloneSRB on DPCH	Same as downlink configuration of Cell_DCH_StandAloneSRB on sCCPCH
LogCh Type	DTCH	DTCH	DTCH	DTCH	DTCH		
LogCh Identity	tsc_DL_DTCH1 (7)	tsc_DL_D TCH2 (8)	tsc_DL_DTC H3 (9)	tsc_DL_DTC H4 (10)	tsc_UL_DTC H5 (13)		
RLC mode	TM	TM	TM	AM	AM		
MAC priority	1	1	1	1	1		
TrCH Type	DCH	DCH	DCH	DCH	DCH		
TrCH identity	tsc_DL_DCH1 (6)	tsc_DL_D CH2 (7)	tsc_DL_DCH 3 (8)	tsc_DL_DCH 4 (9)	tsc_DL_DCH 5 (10)		
PhyCh Type	DPCH					Secondary CCPCH	
PhyCH identity	tsc_DL_DPCH1 (20)					tsc_S_CCPCH1 (5)	

8.3.42 Configuration of Cell_DCH_E_HS (Rel-6 or later)

The configuration is based on 3GPP TS 34.108 [3], clause 6.10.2.4.6.1. The RB0/UM-CCCH is referred to 3GPP TS 34.108 [3], clause 6.10.2.4.3.2.1.2 and RB0/TM-CCCH is referred to 3GPP TS 34.108 [3], clause 6.10.2.4.4.1.1.1.

The configuration is applied to RRC signalling tests in the DCH state where a PS RAB on DTCH mapped on E-DCH in uplink and HS-DSCH in downlink is setup for the streaming or interactive or background service class (A12).

The downlink configuration is same in clause 8.3.32 Cell_DCH_HS_DSCH.

Table 8.3.42: Uplink configuration of Cell_DCH_E_HS

RB Identity	tsc_RB25 (25)	Same as uplink configuration of Cell_DCH_StandAloneSRB on DPCH	Same as uplink configuration of Cell_DCH_StandAloneSRB on PRACH
LogCh Type	DTCH		
LogCh Identity	tsc_UL_DTCH1 (7)		
RLC mode	AM		
TrCH Type	E-DCH		
TrCH identity/Mac-d Flow Id	2	DPDCH	PRACH
PhyCh Type	E-DPDCH		
PhyCH identity	tsc_E_DPCH (22)	tsc_UL_DPCH1 (20)	tsc_PRACH1 (8)

8.3.43 Configuration of Cell_DCH_dISRB_E_HS (Rel-6 or later)

The configuration is based on 3GPP TS 34.108 [3], clause 6.10.2.4.6.2. The RB0/UM-CCCH is referred to 3GPP TS 34.108 [3], clause 6.10.2.4.3.2.1.2 and RB0/TM-CCCH is referred to 3GPP TS 34.108 [3], clause 6.10.2.4.4.1.1.1.

The configuration is applied to RRC signalling tests in the DCH state where a PS RAB is setup for the interactive or background service class (A13):

- PS RAB on DTCH is mapped on E-DCH in uplink and HS-DSCH in downlink.
- Uplink SRBs on DCCH are mapped on E-DCH.
- Downlink SRBs on DCCH are mapped on DCH.

The downlink configuration is same in clause 8.3.32 Cell_DCH_HS_DSCH.

Table 8.3.43: Uplink configuration of Cell_DCH_dISRB_E_HS

RB Identity	tsc_RB25 (25)	Same as uplink configuration of Cell_DCH_StandAloneSRB on DPCH	Same as uplink configuration of Cell_DCH_StandAloneSRB on PRACH
LogCh Type	DTCH		
LogCh Identity	tsc_UL_DTCH1 (7)		
RLC mode	AM		
TrCH Type	E-DCH		
TrCH identity/ Mac-d Flow Id	2	1	
PhyCh Type	E-DPDCH		PRACH
PhyCH identity	tsc_E_DPCH (22)		tsc_PRACH1 (8)

8.3.44 Configuration of Cell_E_HS (Rel-6 or later)

The configuration is based on 3GPP TS 34.108 [3], clause 6.10.2.4.6.3. The RB0/UM-CCCH is referred to 3GPP TS 34.108 [3], clause 6.10.2.4.3.2.1.2 and RB0/TM-CCCH is referred to 3GPP TS 34.108 [3], clause 6.10.2.4.4.1.1.1.

The configuration is applied to RRC signalling tests in the DCH state where a PS RAB is setup for the interactive or background service class (A14):

- PS RAB on DTCH is mapped on E-DCH in uplink and HS-DSCH in downlink.
- Uplink SRBs on DCCH are mapped on E-DCH.
- Downlink SRBs on DCCH are mapped on HS-DSCH.

The uplink configuration is same in clause 8.3.43 Cell_DCH_dISRB_E_HS. In the downlink F-DPCH is configured.

Table 8.3.44: Downlink configuration of Cell_E_HS

RB Identity	tsc_RB25 (25)	Same as downlink configuration of Cell_DCH_StandAloneSRB on DPCH	Same as downlink configuration of Cell_DCH_StandAloneSRB on sCCPCH
LogCh Type	DTCH		
LogCh Identity	tsc_DL_DTCH1 (7)		
RLC mode	AM		
MAC priority	8		
TrCH Type	HS-DSCH		
TrCH identity / Mac-d Flow Id	0	1	
PhyCh Type	PDSCH		Secondary CCPCH
PhyCH identity	tsc_HSPDSCH (18)		tsc_S_CCPCH1 (5)

8.3.45 Configuration of PS Cell_Four_DTCH_E_HS_CS and Cell_Four_DTCH_CS_E_HS (Rel-6 or later)

The configuration is based on 3GPP TS 34.108 [3], clause 6.10.2.4.6.4. The RB0/UM-CCCH is referred to 3GPP TS 34.108 [3], clause 6.10.2.4.3.2.1.2 and RB0/TM-CCCH is referred to 3GPP TS 34.108 [3], clause 6.10.2.4.4.1.1.1.

The configuration is applied to RRC signalling tests in the DCH state where a PS RAB is setup for the interactive or background service class:

- PS RAB on DTCH is mapped on E-DCH in uplink and HS-DSCH in downlink.
- CS RAB on DTCH are mapped on DCH in uplink and downlink.
- Uplink SRBs on DCCH are mapped on DCH.
- Downlink SRBs on DCCH are mapped on DCH.

The downlink configuration is same as in clause 8.3.36 Cell_Four_DTCH_HS_CS and Cell_Four_DTCH_CS_HS.

Table 8.3.45: Uplink configuration of Cell_Four_DTCH_E_HS_CS and Cell_Four_DTCH_CS_E_HS

RB Identity	tsc_RB25 (25)	tsc_RB10 (10)	tsc_RB11 (11)	tsc_RB12 (12)	Same as uplink configuration of Cell_DCH_StandAlone eSRB on DPCH	Same as uplink configuration of Cell_DCH_StandAlone SRB on PRACH
LogCh Type	DTCH	DTCH	DTCH	DTCH		
LogCh Identity	tsc_UL_DTC H4 (10)	tsc_UL_D TCH1 (7)	tsc_UL_D TCH2 (8)	tsc_UL_D TCH3 (9)		
RLC mode	AM	TM	TM	TM		
MAC priority		1	1	1		
TrCH Type	E-DCH	DCH	DCH	DCH		
TrCH identity / Mac-d Flow Id	2	tsc_UL_D CH1 (1)	tsc_UL_D CH2 (2)	tsc_UL_D CH3 (3)		
PhyCh Type	E-DPDCH	DPDCH			PRACH	
PhyCH identity	tsc_E_DPCH (22)	tsc_UL_DPCH1 (20)			tsc_PRACH1 (8)	

8.3.45a Configuration of Cell_FourDTCH_E_DPCH

The configuration is based on 3GPP TS 34.108 [3], clauses 6.11.5.4.7.13. The RB0/UM-CCCH is referred to 3GPP TS 34.108 [3], clause 6.10.2.4.3.2.1.2 and RB0/TM-CCCH is referred to 3GPP TS 34.108 [3], clause 6.10.2.4.4.1.1.1.

The configuration is applied to LCR TDD RB tests.

Table 8.3.45a.1: Uplink configuration of Cell_FourDTCH_E_DPCH

RB Identity	tsc_RB25 (25)	tsc_RB10 (10)	tsc_RB11 (11)	tsc_RB12 (12)	Same as uplink configuration of Cell_DCH_St andAloneSRB on DPCH	Same as uplink configuration of Cell_DCH_St andAloneSRB on PRACH
LogCh Type	DTCH	DTCH	DTCH	DTCH		
LogCh Identity	tsc_UL_DTCH 4 (10)	tsc_UL_DTCH1 (7)	tsc_UL_DTCH2 (8)	tsc_UL_DTCH3 (9)		
RLC mode	AM	TM	TM	TM		
TrCH Type	E-DCH	DCH	DCH	DCH		
TrCH identity/Mac- d Flow Id	2	tsc_UL_DCH1 (1)	tsc_UL_DCH2 (2)	tsc_UL_DCH3 (3)		
PhyCh Type	E-DPDCH	DPDCH			PRACH	
PhyCH identity	tsc_E_DPCH (22)	tsc_UL_DPCH1 (20)			tsc_PRACH1 (8)	

Table 8.3.45a.2: Downlink configuration of PS Cell_FourDTCH_E_DPCH

RB Identity	tsc_RB10 (10)	tsc_RB11 (11)	tsc_RB12 (12)	tsc_RB25 (25)	Same as downlink configuration of Cell_DCH_StandAloneSRB on DPCH	Same as downlink configuration of Cell_DCH_StandAloneSRB on sCCPCH
LogCh Type	DTCH	DTCH	DTCH	DTCH		
LogCh Identity	tsc_DL_DTC H1 (7)	tsc_DL_DTC H2 (8)	tsc_DL_DTC H3 (9)	tsc_DL_DTC H4 (10)		
RLC mode	TM	TM	TM	AM		
MAC priority	1	1	1	1		
TrCH Type	DCH	DCH	DCH	DCH		
TrCH identity	tsc_DL_DCH 1 (6)	tsc_DL_DCH 2 (7)	tsc_DL_DCH 3 (8)	tsc_DL_DCH 4 (9)		
PhyCh Type	DPCH					Secondary CCPCH
PhyCH identity	tsc_DL_DPCH1 (20)					tsc_S_CCPCH1 (5)

8.3.46 Configuration of Cell_2DCH_2AM_dISRB_E_HS (Rel-6 or later)

The configuration is based on 3GPP TS 34.108 [3], clause 6.10.2.4.5.2. The RB0/UM-CCCH is referred to 3GPP TS 34.108 [3], clause 6.10.2.4.3.2.1.2 and RB0/TM-CCCH is referred to 3GPP TS 34.108 [3], clause 6.10.2.4.4.1.1.1.

The configuration is applied to RRC signalling tests in the DCH state where a PS RAB is setup for the interactive or background service class (A15):

- 2 AM PS RAB on DTCH is mapped on E-DCH in uplink and HS-DSCH in downlink.
- Uplink SRBs on DCCH are mapped on E-DCH.
- Downlink SRBs on DCCH are mapped on DCH.

The downlink configuration is same in clause 8.3.39 Cell_2DCH_2AM_HS_DSCH

Table 8.3.46: Uplink configuration of Cell_2DCH_2AM_dISRB_E_HS

RB Identity	tsc_RB25 (25)	tsc_RB17 (17)	Same as uplink configuration of Cell_DCH_StandAloneSRB on DPCH	Same as uplink configuration of Cell_DCH_StandAloneSRB on PRACH
LogCh Type	DTCH	DTCH		
LogCh Identity	tsc_UL_DTCH1 (7)	tsc_UL_DTCH2 (8)		
RLC mode	AM	AM		
TrCH Type	E-DCH			
TrCH identity//Mac-d Flow Id	2	3	1	
PhyCh Type	E-DPDCH			PRACH
PhyCH identity	tsc_E_DPCH (22)			tsc_PRACH1 (8)

8.3.47 Configuration of Cell_E_HS_MAC_TM_RAB (Rel-6 or later)

The configuration is based on 3GPP TS 34.108 [3], clause 6.11.4c, with RAB configured in TM mode on SS side. The RB0/UM-CCCH is referred to 3GPP TS 34.108 [3], clause 6.10.2.4.3.2.1.2 and RB0/TM-CCCH is referred to 3GPP TS 34.108 [3], clause 6.10.2.4.4.1.1.1.

The configuration is applied to MAC(e/es) signalling tests in the DCH state where a PS RAB is setup for the interactive or background service class (A12):

- PS RAB on DTCH is mapped on E-DCH in uplink and HS-DSCH in downlink.
- Uplink SRBs on DCCH are mapped on DCH.
- Downlink SRBs on DCCH are mapped on DCH.

Table 8.3.47.1: Uplink configuration of Cell_E_HS_MAC_TM_RAB

RB Identity	tsc_RB_DTCH_E_DCH_MAC1 (-21)	Same as uplink configuration of Cell_DCH_StandAloneSRB on DPCH	Same as uplink configuration of Cell_DCH_StandAloneSRB on PRACH
LogCh Type	DTCH		
LogCh Identity	tsc_UL_DTCH1 (7)		
RLC mode	TM		
TrCH Type	E-DCH		
TrCH identity/Mac-d Flow Id	2		
PhyCh Type	E-DPDCH	DPDCH	PRACH
PhyCH identity	tsc_E_DPCH (22)	tsc_UL_DPCH1 (20)	tsc_PRACH1 (8)

Table 8.3.47.2: Downlink configuration of Cell_E_HS_MAC_TM_RAB

RB Identity	tsc_RB_DTCH_E_DCH_MAC1 (-21)	Same as downlink configuration of Cell_DCH_StandAloneSRB on DPCH	Same as downlink configuration of Cell_DCH_StandAloneSRB on sCCPCH
LogCh Type	DTCH		
LogCh Identity	tsc_DL_DTCH1 (7)		
RLC mode	TM		
MAC priority	8		
TrCH Type	HS-DSCH		
TrCH identity /QueueID	0		
PhyCh Type	PDSCH	DPCH	Secondary CCPCH
PhyCH identity	tsc_HSPDSCH (18)	tsc_DL_DPCH1 (26)	tsc_S_CCPCH1 (5)

8.3.48 Configuration of Cell_2DCH_MAC_2TM_dISRB_E_HS (Rel-6 or later)

The configuration is based on 3GPP TS 34.108 [3], clause 6.11.4d. The RB0/UM-CCCH is referred to 3GPP TS 34.108 [3], clause 6.10.2.4.3.2.1.2 and RB0/TM-CCCH is referred to 3GPP TS 34.108 [3], clause 6.10.2.4.4.1.1.1. (A13).

The configuration is applied to MAC(e/es) signalling tests in the DCH state where a PS RAB is setup for the interactive or background service class (A15):

- 2 TM PS RAB on DTCH is mapped on E-DCH in uplink and HS-DSCH in downlink.
- Uplink SRBs on DCCH are mapped on E-DCH.
- Downlink SRBs on DCCH are mapped on DCH.

Table 8.3.48.1: Uplink configuration of Cell_2DCH_MAC_2TM_dISRB_E_HS

RB Identity	tsc_RB_DTCH_E_DCH_MAC1 (-21)	tsc_RB_DTCH_E_DCH_MAC2 (-22)	Same as uplink configuration of Cell_DCH_St andAloneSRB on DPCH	Same as uplink configuration of Cell_DCH_StandAloneSRB on PRACH	
LogCh Type	DTCH	DTCH			
LogCh Identity	tsc_UL_DTCH1 (7)	tsc_UL_DTCH2 (8)			
RLC mode	TM	TM			
TrCH Type	E-DCH				
TrCH identity//Mac-d Flow Id	2	3	1		
PhyCh Type	E-DPDCH				PRACH
PhyCH identity	tsc_E_DPCH (22)				tsc_PRACH1 (8)

Table 8.3.48.2: Downlink configuration of Cell_2DCH_MAC_2TM_dISRB_E_HS

RB Identity	tsc_RB_DTCH_E_DCH_MAC1 (-21)	tsc_RB_DTCH_E_DCH_MAC2 (-22)	Same as downlink configuration of Cell_DCH_St andAloneSRB on DPCH	Same as downlink configuration of Cell_DCH_StandAloneSRB on sCCPCH
LogCh Type	DTCH	DTCH		
LogCh Identity	tsc_DL_DTCH1 (7)	tsc_DL_DTCH2 (8)		
RLC mode	TM	TM		
MAC priority	8	8		
TrCH Type	HS-DSCH	HS-DSCH		
TrCH identity /QueueID	0	1		
PhyCh Type	PDSCH		DPCH	Secondary CCPCH
PhyCH identity	tsc_HSPDSCH (18)		tsc_DL_DPC H1 (26)	tsc_S_CCPCH1 (5)

8.3.49 Configuration of Cell_2DCH_1AM_1UM_E_HS (Rel-6 or later)

The configuration is based on 3GPP TS 34.108 [3], clause 6.10.2.4.6.6. The RB0/UM-CCCH is referred to 3GPP TS 34.108 [3], clause 6.10.2.4.3.2.1.2 and RB0/TM-CCCH is referred to 3GPP TS 34.108 [3], clause 6.10.2.4.4.1.1.1.

The configuration is applied to RRC signalling tests in the DCH state where a PS RAB is setup for the streaming or interactive or background service class and another UM PS Bearer is setup for conversational / unknown or speech (A16):

- 1 AM PS RAB and 1 UM PS RAB on DTCH are mapped on E-DCH in uplink and HS-DSCH in downlink.
- Uplink SRBs on DCCH are mapped on E-DCH.
- Downlink SRBs on DCCH are mapped on HS-DSCH.

In the downlink F-DPCH is configured.

Table 8.3.49.1: Uplink configuration of Cell_2DCH_1AM_1UM_E_HS

RB Identity	tsc_RB25 (25)	tsc_RB27 (27)	Same as uplink configuration of Cell_DCH_StandAloneSRB on DPCH	Same as uplink configuration of Cell_DCH_StandAloneSRB on PRACH
LogCh Type	DTCH	DTCH		
LogCh Identity	tsc_UL_DTCH1 (7)	tsc_UL_DTCH3 (9)		
RLC mode	AM	UM		
TrCH Type	E-DCH		1	
TrCH identity//Mac-d Flow Id	2	4		
PhyCh Type	E-DPDCH		PRACH	
PhyCH identity	tsc_E_DPCH (22)		tsc_PRACH1 (8)	

Table 8.3.49.2: Downlink configuration of Cell_2DCH_1AM_1UM_E_HS

RB Identity	tsc_RB25 (25)	tsc_RB27 (27)	Same as downlink configuration of Cell_DCH_StandAloneSRB on DPCH	Same as downlink configuration of Cell_DCH_StandAloneSRB on sCCPCH
LogCh Type	DTCH	DTCH		
LogCh Identity	tsc_DL_DTCH 1 (7)	tsc_DL_DTCH3 (9)		
RLC mode	AM	UM		
MAC priority	8	8	1	
TrCH Type	HS-DSCH			
TrCH identity / Mac-d Flow Id	0	3		
PhyCh Type	PDSCH		Secondary CCPCH	
PhyCH identity	tsc_HSPDSCH (18)		tsc_S_CCPCH1 (5)	

8.3.50 Configuration of Cell_3DCH_2AM_1UM_E_HS (Rel-6 or later)

The configuration is based on 3GPP TS 34.108 [3], clause 6.10.2.4.6.7. The RB0/UM-CCCH is referred to 3GPP TS 34.108 [3], clause 6.10.2.4.3.2.1.2 and RB0/TM-CCCH is referred to 3GPP TS 34.108 [3], clause 6.10.2.4.4.1.1.1.

The configuration is applied to RRC signalling tests in the DCH state where two PS RABs are setup for the streaming or interactive or background service class and another UM PS Bearer is setup for conversational / unknown or speech:

- 2 AM PS RABs and 1 UM PS RAB on DTCH are mapped on E-DCH in uplink and HS-DSCH in downlink.
- Uplink SRBs on DCCH are mapped on E-DCH.
- Downlink SRBs on DCCH are mapped on HS-DSCH.

In the downlink F-DPCH is configured.

Table 8.3.50.1: Uplink configuration of Cell_2DCH_1AM_1UM_E_HS

RB Identity	tsc_RB25 (25)	tsc_RB17 (17)	tsc_RB27 (27)	Same as uplink configuration of Cell_DCH_StandAloneSRB on DPCH	Same as uplink configuration of Cell_DCH_StandAloneSRB on PRACH
LogCh Type	DTCH	DTCH	DTCH		
LogCh Identity	tsc_UL_DTCH1 (7)	tsc_UL_DTCH2 (8)	tsc_UL_DTCH3 (9)		
RLC mode	AM	AM	UM		
TrCH Type	E-DCH			1	
TrCH identity//Mac-d Flow Id	2	3	4		
PhyCh Type	E-DPDCH				PRACH
PhyCH identity	tsc_E_DPCH (22)				tsc_PRACH1 (8)

Table 8.3.50.2: Downlink configuration of Cell_2DCH_1AM_1UM_E_HS

RB Identity	tsc_RB25 (25)	tsc_RB17 (17)	tsc_RB27 (27)	Same as downlink configuration of Cell_DCH_StandAloneSRB on DPCH	Same as downlink configuration of Cell_DCH_StandAloneSRB on sCCPCH
LogCh Type	DTCH	DTCH	DTCH		
LogCh Identity	tsc_DL_DTCH1 (7)	tsc_DL_DTCH2 (8)	tsc_DL_DTCH3 (9)		
RLC mode	AM	AM	UM		
MAC priority	8	8	8		
TrCH Type	HS-DSCH			1	
TrCH identity / Mac-d Flow Id	0	2	3		
PhyCh Type	PDSCH				Secondary CCPCH
PhyCH identity	tsc_HSPDSCH (18)				tsc_S_CCPCH1 (5)

8.3.51 Configuration of Cell_Four_DTCH_CS_E_HS_5SRB (Rel-6 or later)

The configuration is based on 3GPP TS 34.108 [3], clauses 6.10.2.4.6.8. The RB0/UM-CCCH is referred to 3GPP TS 34.108 [3], clause 6.10.2.4.3.2.1.2 and RB0/TM-CCCH is referred to 3GPP TS 34.108 [3], clause 6.10.2.4.4.1.1.1. The configuration is applied to RB tests.

The uplink configuration is same as in clause 8.3.45 Cell_Four_DTCH_E_HS_CS and Cell_Four_DTCH_CS_E_HS.

The downlink configuration is the same as in clause 8.3.52 Cell_Four_DTCH_HS_5SRB.

8.3.52 Configuration of Cell_Four_DTCH_HS_5SRB (Rel-5 or later)

The configuration is based on 3GPP TS 34.108 [3], clauses 6.10.2.4.5.8. The RB0/UM-CCCH is referred to 3GPP TS 34.108 [3], clause 6.10.2.4.3.2.1.2 and RB0/TM-CCCH is referred to 3GPP TS 34.108 [3], clause 6.10.2.4.4.1.1.1. The configuration is applied to RB tests.

The uplink configuration is same in clause 8.3.36 Cell_Four_DTCH_HS_CS and Cell_Four_DTCH_CS_HS.

Table 8.3.52: Downlink configuration of Cell_Four_DTCH_HS_5SRB

RB Identity	tsc_RB25 (25)	tsc_RB10 (10)	tsc_RB11 (11)	tsc_RB12 (12)	tsc_RB1 (1)	tsc_RB2 (2)	tsc_RB3 (3)	tsc_RB4 (4)	tsc_RB5 (5)	Same as downlink configuration of Cell_DCH_StandAloneSRB on sCCPCH
LogCh Type	DTCH	DTCH	DTCH	DTCH	DCCH	DCCH	DCCH	DCCH	DCCH	
LogCh Identity	tsc_DL_DTCH 41 (107)	tsc_DL_DTCH 1 (7)	tsc_DL_DTCH 2 (8)	tsc_DL_DTCH 3 (9)	tsc_DL_DCCH 1 (1)	tsc_DL_DCCH 2 (2)	tsc_DL_DCCH 3 (3)	tsc_DL_DCCH 4 (4)	tsc_DL_DCCH 5 (5)	
RLC mode	AM	TM	TM	TM	UM	AM	AM	AM	TM	
MAC priority	8	1	1	1	1	2	3	4	5	
TrCH Type	HS-DSCH	DCH	DCH	DCH	DCH				DCH	
TrCH/ Q-identity	0	Tsc_DL_DCH 1 (6)	tsc_DL_DCH2 (7)	tsc_DL_DCH3 (8)	tsc_DL_DCH5 (10)				tsc_DL_DCH6 (22)	
PhyCh Type	PDSCH	DPCH								Secondary CCPCH
PhyCH identity	tsc_HSPDSC H (18)	tsc_DL_DPCH1 (26)								tsc_S_CCPC H1 (5)

8.3.53 Configuration of Cell_E_HS_StandAloneSRB/ Cell_E_HS_StandAloneSRB_NoConn (Rel-6 or later)

The configuration is based on 3GPP TS 34.108 [3], clause 6.10.2.4.6.1a. The RB0/UM-CCCH is referred to 3GPP TS 34.108 [3], clause 6.10.2.4.3.2.1.2 and RB0/TM-CCCH is referred to 3GPP TS 34.108 [3], clause 6.10.2.4.4.1.1.1.

The configuration is applied to stand-alone SRB RRC signalling tests in the DCH:

- Uplink SRBs on DCCH are mapped on E-DCH.
- Downlink SRBs on DCCH are mapped on HS-DSCH.

Additionally UL-DPCCH and HS-DPCCH are configured in UL as well as F-DPCH is configured in DL.

**Table 8.3.53.1: Uplink configuration of Cell_E_HS_StandAloneSRB/
Cell_E_HS_StandAloneSRB_NoConn**

RB Identity	tsc_RB1 (1)	tsc_RB2 (2)	tsc_RB3 (3)	tsc_RB4 (4)	Same as uplink configuration of Cell_DCH_StandAloneSRB on PRACH	
LogCh Type	DCCH	DCCH	DCCH	DCCH		
LogCh Identity	tsc_UL_DCCH1 (1)	tsc_UL_DCCH2 (2)	tsc_UL_DCCH3 (3)	tsc_UL_DCCH4 (4)		
RLC mode	UM	AM	AM	AM		
TrCH Type	E-DCH					
TrCH identity / Mac-d Flow Id	tsc_E_DCH_MAC_d_FlowId_DCCH (1)					
PhyCh Type	E-DPDCH					PRACH
PhyCH identity	tsc_E_DPCH (22)					tsc_PRACH1 (8)

**Table 8.3.53.2: Downlink configuration of Cell_E_HS_StandAloneSRB/
Cell_E_HS_StandAloneSRB_NoConn**

RB Identity	tsc_RB1 (1)	tsc_RB2 (2)	tsc_RB3 (3)	tsc_RB4 (4)	Same as downlink configuration of Cell_DCH_StandAloneSRB on sCCPCH
LogCh Type	DCCH	DCCH	DCCH	DCCH	
LogCh Identity	tsc_DL_DCCH 1 (1)	tsc_DL_DCCH 2 (2)	tsc_DL_DCCH 3 (3)	tsc_DL_DCCH4 (4)	
RLC mode	UM	AM	AM	AM	
MAC priority	1	2	3	4	
TrCH Type	HS-DSCH				
TrCH identity / Mac-d Flow Id	tsc_HS_DSCH_MAC_d_FlowId_DCCH (1)				
PhyCh Type	HS-PDSCH				
PhyCH identity	tsc_HSPDSCH (18)				tsc_S_CCPCH1 (5)

8.3.54 MBMS channel configuration (Rel-6 or later)

The MBMS channel configurations are configured in addition to any existing configurations defined in clause 8.3.

8.3.54.1 Configuration cell_MBMS_MCCH (Rel-6 or later)

The configuration is based on 3GPP TS 34.108 [3], clause 6.10.2.4.3.

The configuration is applied to the MBMS tests.

Table 8.3.54.1: cell_MBMS_MCCH

RB Identity	tsc_RB_MCCH (8)
LogCh Type	MCCH
LogCh Identity	tsc_MCCH1 (1)
RLC mode	UM
MAC priority	1
TrCH Type	FACH
TrCH identity	tsc_FACH3 (16)
PhyCh Type	Secondary CCPCH
PhyCH identity	tsc_S_CCPCH2 (10)

8.3.54.2 Configuration cell_MBMS_MCCH_One_MTCH (Rel-6 or later)

The configuration is based on 3GPP TS 34.108 [3], clause 6.10.2.4.3.

The configuration is applied to the MBMS tests.

Table 8.3.54.2: cell_MBMS_MCCH_One_MTCH

RB Identity	tsc_RB_MCCH (8)	tsc_RB_MTCH1 (14)
LogCh Type	MCCH	MTCH
LogCh Identity	tsc_MCCH1 (1)	tsc_MTCH1 (1)
RLC mode	UM	UM
MAC priority	1	1
TrCH Type	FACH	FACH
TrCH identity	tsc_FACH3 (16)	tsc_FACH4 (17)
PhyCh Type	Secondary CCPCH	Secondary CCPCH
PhyCH identity	tsc_S_CCPCH2 (10)	tsc_S_CCPCH3 (13)

8.3.55 Configuration of PS Cell_DCH_64kPS_AM_RAB

The configuration is based on 3GPP TS 34.108 [3], clause 6.10.2.4.1.26. The RB0/UM-CCCH is referred to 3GPP TS 34.108 [3], clause 6.10.2.4.3.2.1.2 and RB0/TM-CCCH is referred to 3GPP TS 34.108 [3], clause 6.10.2.4.4.1.1.1.

The configuration is applied to MBMS tests in the DCH state where a PS RAB on DTCH is setup for the interactive or background service class.

Table 8.3.55.1: Uplink configuration of PS Cell_DCH_64kPS_AM_RAB

RB Identity	tsc_RB22 (22)	Same as uplink configuration of Cell_DCH_StandAloneSRB on DPCH	Same as uplink configuration of Cell_DCH_StandAloneSRB on PRACH
LogCh Type	DTCH		
LogCh Identity	tsc_UL_DTC H2 (8)		
RLC mode	AM		
TrCH Type	DCH		
TrCH identity	tsc_UL_DCH 1 (1)		
PhyCh Type	DPDCH		PRACH
PhyCH identity	tsc_UL_DPCH1 (20)		tsc_PRACH1 (8)

Table 8.3.55.2: Downlink configuration of PS Cell_DCH_64kPS_AM_RAB

RB Identity	tsc_RB22 (22)	Same as downlink configuration of Cell_DCH_StandAloneSRB on DPCH	Same as downlink configuration of Cell_DCH_StandAloneSRB on sCCPCH
LogCh Type	DTCH		
LogCh Identity	tsc_DL_DTC H2 (8)		
RLC mode	AM		
MAC priority	1		
TrCH Type	DCH		
TrCH identity	tsc_DL_DCH 1 (6)		
PhyCh Type	DPCH		Secondary CCPCH
PhyCH identity	tsc_DL_DPCH1 (26)		tsc_S_CCPCH1 (5)

8.3.56 Configuration of PS Cell_MBMS_PTPRB

The configuration is based on, clause 6.10.2.4.1.58. The RB0/UM-CCCH is referred to 3GPP TS 34.108 [3], clause 6.10.2.4.3.2.1.2 and RB0/TM-CCCH is referred to 3GPP TS 34.108 [3], clause 6.10.2.4.4.1.1.1. The configuration is applied to MBMS PTP RB test cases.

The uplink configuration is same in clause 8.3.2 Cell_DCH_StandAloneSRB.

Table 8.3.56: Downlink configuration of Cell_MBMS_PTPRB

RB Identity	tsc_RB21 (21)	Same as downlink configuration of Cell_DCH_StandAloneSRB on DPCH	Same as downlink configuration of Cell_DCH_StandAloneSRB on sCCPCH
LogCh Type	DTCH		
LogCh Identity	tsc_DL_DTCH2 (8)		
RLC mode	UM		
MAC priority	1		
TrCH Type	DCH		
TrCH identity	tsc_DL_DCH2 (7)		
PhyCh Type	DPCH		Secondary CCPCH
PhyCH identity	tsc_DL_DPCH1 (26)		tsc_S_CCPCH1 (5)

8.3.57 Configuration of PS Cell_MBMS_PTPRB_AM

The configuration is based on, clause 6.10.2.4.1.58. The RB0/UM-CCCH is referred to 3GPP TS 34.108 [3], clause 6.10.2.4.3.2.1.2 and RB0/TM-CCCH is referred to 3GPP TS 34.108 [3], clause 6.10.2.4.4.1.1.1. The configuration is applied to MBMS PTP RB test cases, with additional PS RAB established.

The uplink configuration is same in clause 8.3.8 Cell_DCH_64kPS_RAB_SRB and Cell_PDCP_AM_RAB.

Table 8.3.57: Downlink configuration of PS Cell_MBMS_PTPRB_AM

RB Identity	tsc_RB20 (20)	tsc_RB21 (21)	Same as downlink configuration of Cell_DCH_StandAloneSRB on DPCH	Same as downlink configuration of Cell_DCH_StandAloneSRB on sCCPCH
LogCh Type	DTCH	DTCH		
LogCh Identity	tsc_DL_DTCH1 (7)	tsc_DL_DTCH2 (8)		
RLC mode	AM	UM		
MAC priority	1	1		
TrCH Type	DCH	DCH		
TrCH identity	tsc_DL_DCH1 (6)	tsc_DL_DCH2 (7)		
PhyCh Type	DPCH		Secondary CCPCH	
PhyCH identity	tsc_DL_DPCH1 (26)		tsc_S_CCPCH1 (5)	

8.3.58 Configuration of Cell_FACH_MCCH_SRB / Cell_FACH_MCCH_NoDedicated

The configuration is based on 3GPP TS 34.108 [3], clause 6.10.2.4.3.9 for downlink and 3GPP TS 34.108 [3], clause 6.10.2.4.4.1.1.1 for uplink. The configuration is applied to the MBMS tests related in the states CELL_FACH, CELL_PCH and URA_PCH.

The uplink configuration is same in clause 8.3.1 Cell_FACH.

Table 8.3.58: Downlink configuration of Cell_FACH_MCCH_NoConn / Cell_FACH_MCCH_SRB / Cell_FACH_MCCH_NoDedicated

RB Identity	tsc_RB20 (20)	tsc_RB0 (0)	tsc_RB1 (1)	tsc_RB2 (2)	tsc_RB3 (3)	tsc_RB4 (4)	tsc_RB_MCCH (8)	tsc_RB_PCCH (-2)
LogCh Type	DTCH	CCCH	DCCH	DCCH	DCCH	DCCH	MCCH	PCCH
LogCh Identity	tsc_DL_DT CH1 (7)	Tsc_DL_CC CH5 (5)	tsc_DL_DC CH1 (1)	tsc_DL_DC CH2 (2)	tsc_DL_DC CH3 (3)	tsc_DL_DC CH4 (4)	tsc_MCCH1 (1)	tsc_PCCH1 (1)
RLC mode	AM	UM	UM	AM	AM	AM	UM	TM
MAC priority	1	1	2	3	4	5	1	1
TrCH Type	FACH	FACH					FACH	PCH
TrCH identity	tsc_FACH2 (14)	tsc_FACH1 (13)					tsc_FACH3 (16)	tsc_PCH1 (12)
PhyCh Type	Secondary CCPCH							
PhyCH identity	tsc_S_CCPCH1 (5)							

8.3.59 Configuration of Cell_DCH_MCCH_PS

The configuration is based on 3GPP TS 34.108 [3], clause . The RB0/UM-CCCH is referred to 3GPP TS 34.108 [3], clause 6.10.2.4.3.2.1.2 and RB0/TM-CCCH is referred to 3GPP TS 34.108 [3], clause 6.10.2.4.4.1.1.1. The configuration is applied to the MBMS signalling tests in the DCH state.

The uplink configuration is same in clause 8.3.8 Cell_DCH_64kPS_RAB_SRB

Table 8.3.59: Downlink configuration of Cell_DCH_MCCH_PS

RB Identity	tsc_RB1 (1)	tsc_RB2 (2)	tsc_RB3 (3)	tsc_RB4 (4)	tsc_RB20 (20)	tsc_RB0 (0)	tsc_RB_PCCH (-2)	tsc_RB_MCCH (8)	
LogCh Type	DCCH	DCCH	DCCH	DCCH	DTCH	CCCH	PCCH	MCCH	
LogCh Identity	tsc_DL_DCCH1 (1)	tsc_DL_DCCH2 (2)	tsc_DL_DCCH3 (3)	tsc_DL_DCCH4 (4)	tsc_DL_DTCH1 (7)	tsc_DL_CCCH5 (5)	tsc_PCCH1 (1)	tsc_MCCH1 (1)	
RLC mode	UM	AM	AM	AM	AM	UM	TM	UM	AM
MAC priority	1	2	3	4	1	1	1	1	1
TrCH Type	DCH				DCH	FACH	PCH	FACH	FACH
TrCH identity	tsc_DL_DCH5 (10)				tsc_DL_DCH1 (6)	tsc_FACH1 (13)	tsc_PCH1 (12)	tsc_FACH3 (16)	tsc_FACH2 (16)
PhyCh Type	DPCH tsc_DL_DPCH1 (26)					Secondary CCPCH			
PhyCH identity						tsc_S_CCPCH1 (5)			

8.3.60 Configuration of PS Cell_DCH_1AM_2AM_HS_DSCH (Rel-6 or later)

The configuration is based on 3GPP TS 34.108 [3], clauses 6.10.2.4.5.10. The RB0/UM-CCCH is referred to 3GPP TS 34.108 [3], clause 6.10.2.4.3.2.1.2 with 2 AM RAB and RB0/TM-CCCH is referred to 3GPP TS 34.108 [3], clause 6.10.2.4.4.1.1.1. The configuration is applied to RAB test cases.

Table 8.3.60.1: Uplink configuration of Cell_DCH_1AM_2AM_HS_DSCH

RB Identity	tsc_RB25 (25)	tsc_RB17 (17)	tsc_RB28 (28)	Same as uplink configuration of Cell_DCH_StandAloneSRB on DPCH	Same as uplink configuration of Cell_DCH_StandAloneSRB on PRACH
LogCh Type	DTCH	DTCH	DTCH		
LogCh Identity	tsc_UL_DTCH1 (7)	tsc_UL_DTCH2 (8)	tsc_UL_DTCH3 (9)		
RLC mode	AM	AM			
TrCH Type	DCH	DCH			
TrCH identity	tsc_UL_DCH1 (1)	tsc_UL_DCH2 (2)			
PhyCh Type	DPDCH				PRACH
PhyCH identity	tsc_UL_DPCH1 (20)				tsc_PRACH1 (8)

Table 8.3.60.2: Downlink configuration of Cell_DCH_1AM_2AM_HS_DSCH

RB Identity	tsc_RB25 (25)	tsc_RB17 (17)	tsc_RB28 (28)	Same as downlink configuration of Cell_DCH_StandAloneSRB on DPCH	Same as downlink configuration of Cell_DCH_StandAloneSRB on sCCPCH
LogCh Type	DTCH	DTCH	DTCH		
LogCh Identity	tsc_DL_DTCH1 (7)	tsc_DL_DTCH2 (8)	tsc_DL_DTCH3 (9)		
RLC mode	AM	AM	AM		
MAC priority	8	8	8		
TrCH Type	HS-DSCH	HS-DSCH	HS-DSCH		
TrCH identity /QueueID	0	2	3		
PhyCh Type	PDSCH			DPCH	Secondary CCPCH
PhyCH identity	tsc_HSPDSCH (18)			tsc_DL_DPCH1 (26)	tsc_S_CCPCH1 (5)

8.3.61 Configuration of Cell_FACH_enhDL_PCH (Rel-7 or later)

The configuration is based on 3GPP TS 34.108 [3], clause 6.10.2.4.4.3 for downlink and 3GPP TS 34.108 [3], clause 6.10.2.4.4.1.1.1 for uplink. The configuration is applied to the RRC tests related in the states CELL_PCH and URA_PCH. They need a minimum radio configuration for testing.

The configuration is applied to RRC signalling tests in the PCH states where a PS RAB is setup for the interactive or background service class (A):

- PS RAB on DTCH is mapped on S-CCPCH in uplink and HS-DSCH in downlink.
- Downlink SRBs on DCCH are mapped on HS-DSCH;
- Uplink SRBs on DCCH are mapped on PRACH.

Table 8.3.61.1: Uplink configuration of Cell_FACH_enhDL_PCH

RB Identity	tsc_RB25 (25)	tsc_RB0 (0)	tsc_RB1 (1)	tsc_RB2 (2)	tsc_RB3 (3)	tsc_RB4 (4)
LogCh Type	DTCH	CCCH	DCCH	DCCH	DCCH	DCCH
LogCh Identity	Tsc_UL_DTCH1 (7)	tsc_UL_CCCH5 (5)	tsc_UL_DCCH1 (1)	tsc_UL_DCCH2 (2)	tsc_UL_DCCH3 (3)	tsc_UL_DCCH4 (4)
RLC mode	AM	TM	UM	AM	AM	AM
TrCH Type	RACH					
TrCH identity	tsc_RACH1 (15)					
PhyCh Type	PRACH					
PhyCH identity	tsc_PRACH1 (8)					

Table 8.3.61.2: Downlink configuration of Cell_FACH_enhDL_PCH

RB Identity	tsc_RB25 (25)	tsc_RB0 (0)	tsc_RB1 (1)	tsc_RB2 (2)	tsc_RB3 (3)	tsc_RB4 (4)	tsc_RB_BC CH_FACH (-3)	tsc_RB_PC CH (-2)
LogCh Type	DTCH	CCCH	DCCH	DCCH	DCCH	DCCH	BCCH	PCCH
LogCh Identity	tsc_DL_DT CH1 (7)	tsc_DL_CC CH2 (2)	tsc_DL_DC CH1 (1)	tsc_DL_DC CH2 (2)	tsc_DL_DC CH3 (3)	tsc_DL_DC CH4 (4)	tsc_BCCH6 (6)	tsc_PCCH_ FACH (11)
RLC mode	AM	UM	UM	AM	AM	AM	TM	TM
MAC priority	8	1	2	3	4	5	1	1
TrCH Type	HS-DSCH	HS-DSCH	HS-DSCH				HS-DSCH	HS-DSCH
TrCH identity / Mac-d Flow Id	2	0	1				NA	NA
PhyCh Type	PDSCH							
PhyCH identity	tsc_HSPDSCH (18)							

8.3.62 Configuration of Cell_FACH_enhDL_PS (Rel-7 or later)

The configuration is based on 3GPP TS 34.108 [3], clause 6.10.2.4.4.3 for downlink and 3GPP TS 34.108 [3], clause 6.10.2.4.4.1.1.1 for uplink. The configuration is applied to the RRC tests related in the states CELL_FACH. They need a minimum radio configuration for testing.

The configuration is applied to RRC signalling tests in the FACH state where a PS RAB is setup for the interactive or background service class (A):

- PS RAB on DTCH is mapped on PRACH in uplink and HS-DSCH in downlink.
- Uplink SRBs on DCCH and CCCH are mapped on PRACH.
- Downlink SRBs on DCCH are mapped on HS-DSCH.

Table 8.3.62.1: Uplink configuration of Cell_FACH_enhDL_PS

RB Identity	tsc_RB25 (25)	tsc_RB0 (0)	tsc_RB1 (1)	tsc_RB2 (2)	tsc_RB3 (3)	tsc_RB4 (4)
LogCh Type	DTCH	CCCH	DCCH	DCCH	DCCH	DCCH
LogCh Identity	Tsc_UL_DTCH1 (7)	tsc_UL_CCCH5 (5)	tsc_UL_DCCH1 (1)	tsc_UL_DCCH2 (2)	tsc_UL_DCCH3 (3)	tsc_UL_DCCH4 (4)
RLC mode	AM	TM	UM	AM	AM	AM
TrCH Type	RACH					
TrCH identity	tsc_RACH1 (15)					
PhyCh Type	PRACH					
PhyCH identity	tsc_PRACH1 (8)					

Table 8.3.62.2: Downlink configuration of Cell_FACH_enhDL_PS

RB Identity	tsc_RB25 (25)	tsc_RB0 (0)	tsc_RB1 (1)	tsc_RB2 (2)	tsc_RB3 (3)	tsc_RB4 (4)	tsc_RB_BCCH _FACH (-3)
LogCh Type	DTCH	CCCH	DCCH	DCCH	DCCH	DCCH	BCCH
LogCh Identity	tsc_DL_DTC H1 (7)	tsc_DL_CCC H2 (2)	tsc_DL_DC CH1 (1)	tsc_DL_DC CH2 (2)	tsc_DL_DCC H3 (3)	tsc_DL_DC CH4 (4)	tsc_BCCH6 (6)
RLC mode	AM	UM	UM	AM	AM	AM	TM
MAC priority	8	1	2	3	4	5	1
TrCH Type	HS-DSCH	HS-DSCH	HS-DSCH				HS-DSCH
TrCH identity / Mac-d Flow Id	2	0	1				NA
PhyCh Type	PDSCH						
PhyCH identity	tsc_HSPDSCH (18)						

8.3.63 Configuration of Cell_E_HS_UM (Rel-7 or later)

The configuration is based on 3GPP TS 34.108 [3], clauses 6.10.2.4.6.9 and 6.10.2.4.6.10. The RB0/UM-CCCH is referred to 3GPP TS 34.108 [3], clause 6.10.2.4.3.2.1.2 and RB0/TM-CCCH is referred to 3GPP TS 34.108 [3], clause 6.10.2.4.4.1.1.1.

The configuration is applied to signalling tests in the DCH state where a PS RAB is setup for CS voice over HSPA(A23):

- UM PS RAB on DTCH is mapped on E-DCH in uplink and HS-DSCH in downlink.
- SRBs on DCCH are mapped on E-DCH in uplink and HS-DSCH in downlink.

Table 8.3.63.1: Uplink configuration of Cell_E_HS_UM

RB Identity	tsc_RB26 (26)	Same as uplink configuration of Cell_DCH_StandAloneSRB on DPCH	Same as uplink configuration of Cell_DCH_StandAloneSRB on PRACH
LogCh Type	DTCH		
LogCh Identity	tsc_UL_DTCH1 (7)		
RLC mode	UM		
TrCH Type	E-DCH		
TrCH identity/ Mac-d Flow Id	2	1	
PhyCh Type	E-DPDCH		PRACH
PhyCH identity	tsc_E_DPCH (22)		tsc_PRACH1 (8)

Table 8.3.63.2: Downlink configuration of Cell_E_HS_UM

RB Identity	tsc_RB26 (26)	Same as downlink configuration of Cell_DCH_StandAloneSRB on DPCH	Same as downlink configuration of Cell_DCH_StandAloneSRB on sCCPCH
LogCh Type	DTCH		
LogCh Identity	tsc_DL_DTCH1 (7)		
RLC mode	UM		
MAC priority	8		
TrCH Type	HS-DSCH		
TrCH identity / Mac-d Flow Id	0	1	
PhyCh Type	PDSCH		Secondary CCPCH
PhyCH identity	tsc_HSPDSCH (18)		tsc_S_CCPCH1 (5)

8.3.64 Configuration of Cell_FACH_enhDL_SRB (Rel-7 or later)

The configuration is based on 3GPP TS 34.108 [3], clause 6.10.2.4.4.3 for downlink and 3GPP TS 34.108 [3], clause 6.10.2.4.4.1.1.1 for uplink. The configuration is applied to the RRC tests related in the states CELL_FACH. They need a minimum radio configuration for testing.

The configuration is applied to RRC signalling tests in the FACH state with a signalling connection:

- Uplink SRBs on DCCH are mapped on PRACH.
- Downlink SRBs on DCCH are mapped on HS-DSCH.

Table 8.3.64.1: Uplink configuration of Cell_FACH_enhDL_SRB

RB Identity	tsc_RB0 (0)	tsc_RB1 (1)	tsc_RB2 (2)	tsc_RB3 (3)	tsc_RB4 (4)
LogCh Type	CCCH	DCCH	DCCH	DCCH	DCCH
LogCh Identity	tsc_UL_CCCH5 (5)	tsc_UL_DCCH1 (1)	tsc_UL_DCCH2 (2)	tsc_UL_DCCH3 (3)	tsc_UL_DCCH4 (4)
RLC mode	TM	UM	AM	AM	AM
TrCH Type	RACH				
TrCH identity	tsc_RACH1 (15)				
PhyCh Type	PRACH				
PhyCH identity	tsc_PRACH1 (8)				

Table 8.3.64.2: Downlink configuration of Cell_FACH_enhDL_SRB

RB Identity	tsc_RB0 (0)	tsc_RB1 (1)	tsc_RB2 (2)	tsc_RB3 (3)	tsc_RB4 (4)	tsc_RB_BCC H_FACH (-3)
LogCh Type	CCCH	DCCH	DCCH	DCCH	DCCH	BCCH
LogCh Identity	tsc_DL_CCCH 2 (2)	tsc_DL_DCC H1 (1)	tsc_DL_DCC H2 (2)	tsc_DL_DCC H3 (3)	tsc_DL_DCC H4 (4)	tsc_BCCH6 (6)
RLC mode	UM	UM	AM	AM	AM	TM
MAC priority	1	2	3	4	5	1
TrCH Type	HS-DSCH	HS-DSCH				HS-DSCH
TrCH identity / Mac-d Flow Id	0	1				NA
PhyCh Type	PDSCH					
PhyCH identity	tsc_HSPDSCH (18)					

8.3.65 Configuration of Cell_DCH_3TM_dISRB_E_HS (Rel-8 or later)

The configuration is based on 3GPP TS 34.108 [3], clause 6.10.2.4.6.2. The RB0/UM-CCCH is referred to 3GPP TS 34.108 [3], clause 6.10.2.4.3.2.1.2 and RB0/TM-CCCH is referred to 3GPP TS 34.108 [3], clause 6.10.2.4.4.1.1.1.

The configuration is applied to MAC signalling tests in the DCH state where a PS RAB is setup for the interactive or background service class (A26):

- 3 PS UM RAB on DTCH are mapped on E-DCH in uplink and HS-DSCH in downlink.
- Uplink SRBs on DCCH are mapped on E-DCH.
- Downlink SRBs on DCCH are mapped on DCH.

Table 8.3.65.1: Uplink configuration of Cell_DCH_3TM_dISRB_E_HS

RB Identity	tsc_RB_DTCH_ E_DCH_MAC0 (-20)	tsc_RB_DTCH_ _E_DCH_MAC 1 (-21)	tsc_RB_DTCH_ _E_DCH_MAC 2 (-22)	Same as uplink configuration of Cell_DCH_StandAlon eSRB on DPCH	Same as uplink configuration of Cell_DCH_StandAlon eSRB on PRACH
LogCh Type	DTCH	DTCH	DTCH		
LogCh Identity	tsc_UL_DTCH1 (7)	tsc_UL_DTCH 2 (8)	tsc_UL_DTCH3 (9)		
RLC mode	TM	TM	TM		
TrCH Type	E-DCH				
TrCH identity//Mac-d Flow Id	2	3	4	1	
PhyCh Type	E-DPDCH				PRACH
PhyCH identity	tsc_E_DPCH (22)				tsc_PRACH1 (8)

Table 8.3.65.2: Downlink configuration of Cell_DCH_3TM_dISRB_E_HS

RB Identity	tsc_RB_DTCH_E_DCH_MAC0 (-20)	tsc_RB_DTCH_E_DCH_MAC1 (-21)	tsc_RB_DTCH_E_DCH_MAC2 (-22)	Same as downlink configuration of Cell_DCH_StandAloneSRB on DPCH	Same as downlink configuration of Cell_DCH_StandAloneSRB on sCCPCH
LogCh Type	DTCH	DTCH	DTCH		
LogCh Identity	tsc_DL_DTCH1 (7)	tsc_DL_DTCH2 (8)	tsc_DL_DTCH3 (9)		
RLC mode	TM	TM	TM		
MAC priority	8	8	8		
TrCH Type	HS-DSCH				
TrCH identity /QueueID	2	3	4		
PhyCh Type	PDSCH			DPCH	Secondary CCPCH
PhyCH identity	tsc_HSPDSCH (18)			tsc_DL_DPCH1 (26)	tsc_S_CCPCH1 (5)

8.3.66 Configuration of Cell_E_HS_TM (Rel-8 or later)

The configuration is based on 3GPP TS 34.108 [3], clause 6.10.2.4.6.9 and 6.10.2.4.6.10. The RB0/UM-CCCH is referred to 3GPP TS 34.108 [3], clause 6.10.2.4.3.2.1.2 and RB0/TM-CCCH is referred to 3GPP TS 34.108 [3], clause 6.10.2.4.4.1.1.1.

The configuration is applied to MAC(i/is) signalling tests in the DCH state where a PS RAB is setup for the interactive or background service class (A27):

- TM PS RAB on DTCH is mapped on E-DCH in uplink and HS-DSCH in downlink.
- SRBs on DCCH are mapped on E-DCH in uplink and HS-DSCH in downlink.

Table 8.3.66.1: Uplink configuration of Cell_E_HS_TM

RB Identity	tsc_RB_DTCH_E_DCH_MAC1 (-21)	Same as uplink configuration of Cell_DCH_StandAloneSRB on DPCH	Same as uplink configuration of Cell_DCH_StandAloneSRB on PRACH
LogCh Type	DTCH		
LogCh Identity	tsc_UL_DTCH1 (7)		
RLC mode	TM		
TrCH Type	E-DCH		
TrCH identity/ Mac-d Flow Id	2	1	
PhyCh Type	E-DPDCH		PRACH
PhyCH identity	tsc_E_DPCH (22)		tsc_PRACH1 (8)

Table 8.3.66.2: Downlink configuration of Cell_E_HS_TM

RB Identity	tsc_RB_DTCH_E_DCH_MAC1 (-21)	Same as downlink configuration of Cell_DCH_StandAloneSRB on DPCH	Same as downlink configuration of Cell_DCH_StandAloneSRB on sCCPCH
LogCh Type	DTCH		
LogCh Identity	tsc_DL_DTCH1 (7)		
RLC mode	TM		
MAC priority	8		
TrCH Type	HS-DSCH		
TrCH identity / Mac-d Flow Id	0	1	
PhyCh Type	PDSCH		Secondary CCPCH
PhyCH identity	tsc_HSPDSCH (18)		tsc_S_CCPCH1 (5)

8.3.67 Dual cell configurations (Rel-8 or later)

8.3.67.1 Configuration of cell_SecondaryDualCell_SRB (Rel-8 or later)

The configuration is applied the DCH state to the HS-DSCH secondary serving cell where a PS RAB is setup with dual cell activated (A25):

- Downlink PS RAB is mapped on HS-DSCH in downlink.
- Downlink SRBs on DCCH are mapped on HS-DSCH.

There is no uplink configuration. The related HS-DSCH serving cell is configured in cell_E_HS.

Table 8.3.67.1: Downlink cell_SecondaryDualCell_SRB

RB Identity	tsc_RB25 (25)	Same as downlink configuration of Cell_DCH_StandAloneSRB on DPCH
LogCh Type	DTCH	
LogCh Identity	tsc_DL_DTCH1 (7)	
RLC mode	AM	
MAC priority	8	
TrCH Type	HS-DSCH	
TrCH identity / Mac-d Flow Id	0	1
PhyCh Type	PDSCH	
PhyCH identity	tsc_HSPDSCH (18)	

8.3.67.2 Configuration of cell_SecondaryDualCell_RAB (Rel-8 or later)

The configuration is applied the DCH state to the HS-DSCH secondary serving cell where a PS RAB is setup with dual cell activated:

- Downlink PS RAB is mapped on HS-DSCH in downlink.

There is no uplink configuration. The related HS-DSCH serving cell is configured in cell_DCH_HS_DSCH.

Table 8.3.67.2: Downlink cell_SecondaryDualCell_RAB

RB Identity	tsc_RB25 (25)
LogCh Type	DTCH
LogCh Identity	tsc_DL_DTCH1 (7)
RLC mode	AM
MAC priority	8
TrCH Type	HS-DSCH
TrCH identity / Mac-d Flow Id	0
PhyCh Type	PDSCH
PhyCH identity	tsc_HSPDSCH (18)

8.3.67.3 Configuration of cell_SecondaryDualCell_2RAB (Rel-8 or later)

The configuration is applied the DCH state to the HS-DSCH secondary serving cell where 2 PS RAB is setup with dual cell activated:

- 2 Downlink PS AM RABs are mapped on HS-DSCH in downlink.

There is no uplink configuration. The related HS-DSCH serving cell is configured in Cell_DCH_2AM_HS_DSCH.

Table 8.3.67.3: Downlink cell_SecondaryDualCell_2RAB

RB Identity	tsc_RB25 (25)	tsc_RB17 (17)
LogCh Type	DTCH	DTCH
LogCh Identity	tsc_DL_DTCH1 (7)	tsc_DL_DTCH2 (8)
RLC mode	AM	AM
MAC priority	8	8
TrCH Type	HS-DSCH	HS-DSCH
TrCH identity / Mac-d Flow Id	0	1
PhyCh Type	PDSCH	PDSCH
PhyCH identity	tsc_HSPDSCH (18)	tsc_HSPDSCH (18)

8.3.68 Enhanced FACH Uplink configurations (Rel-8 or later)

8.3.68.1 Configuration of Cell_FACH_UL_SRB and Cell_FACH_UL_SRB_NoConn (Rel-8 or later)

The configuration is based on 3GPP TS 34.108 [3], clause 6.10.2.4.7.1 for downlink and 3GPP TS 34.108 [3], clause 6.10.2.4.4.1.1.1 for uplink. The configuration is applied to the RRC tests related in the states CELL_FACH. They need a minimum radio configuration for testing.

The configuration is applied to RRC signalling tests in the FACH state where a PS RAB is setup:

- PS RAB on DTCH is mapped on E-DCH in uplink and HS-DSCH in downlink.
- Uplink SRBs on DCCH and CCCH are mapped on E-DCH.
- Downlink SRBs on DCCH are mapped on HS-DSCH.

The downlink configuration is same as in clause 8.3.64 Cell_FACH_enhDL_SRB

Table 8.3.68.1: Uplink configuration of Cell_FACH_UL_SRB or Cell_FACH_UL_SRB_NoConn

RB Identity	tsc_RB0 (0)	tsc_RB1 (1)	tsc_RB2 (2)	tsc_RB3 (3)	tsc_RB4 (4)
LogCh Type	CCCH	DCCH	DCCH	DCCH	DCCH
LogCh Identity	tsc_UL_CCCH5 (5)	tsc_UL_DCCH1 (1)	tsc_UL_DCCH2 (2)	tsc_UL_DCCH3 (3)	tsc_UL_DCCH4 (4)
RLC mode	TM	UM	AM	AM	AM
TrCH Type	E-DCH				
TrCH identity/ Mac-d Flow Id	7	1			
PhyCh Type	E-DPDCH				
PhyCH identity	tsc_E_DPCH (22)				

8.3.68.2 Configuration of Cell_FACH_UL_PS (Rel-8 or later)

The configuration is based on 3GPP TS 34.108 [3], clause 6.10.2.4.7.1 for downlink and 3GPP TS 34.108 [3], clause 6.10.2.4.4.1.1.1 for uplink. The configuration is applied to the RRC tests related in the states CELL_FACH. They need a minimum radio configuration for testing.

The configuration is applied to RRC signalling tests in the FACH state where a PS RAB is setup:

- PS RAB on DTCH is mapped on E-DCH in uplink and HS-DSCH in downlink.
- Uplink SRBs on DCCH and CCCH are mapped on E-DCH.
- Downlink SRBs on DCCH are mapped on HS-DSCH.

The downlink configuration is same as in clause 8.3.62 Cell_FACH_enhDL_PS.

Table 8.3.68.2: Uplink configuration of Cell_FACH_UL_PS

RB Identity	tsc_RB25 (25)	tsc_RB0 (0)	tsc_RB1 (1)	tsc_RB2 (2)	tsc_RB3 (3)	tsc_RB4 (4)
LogCh Type	DTCH	CCCH	DCCH	DCCH	DCCH	DCCH
LogCh Identity	Tsc_UL_DTCH1 (7)	tsc_UL_CCCH5 (5)	tsc_UL_DCCH1 (1)	tsc_UL_DCCH2 (2)	tsc_UL_DCCH3 (3)	tsc_UL_DCCH4 (4)
RLC mode	AM	TM	UM	AM	AM	AM
TrCH Type	E-DCH					
TrCH identity/ Mac-d Flow Id	0	7	1			
PhyCh Type	E-DPDCH					
PhyCH identity	tsc_E_DPCH (22)					

8.3.68.3 Configuration of Cell_FACH_UL_TM_PS (Rel-8 or later)

The configuration is based on 3GPP TS 34.108 [3], clause 6.10.2.4.7.1 for downlink and 3GPP TS 34.108 [3], clause 6.10.2.4.4.1.1.1 for uplink. The configuration is applied to the RRC tests related in the states CELL_FACH. They need a minimum radio configuration for testing.

The configuration is applied to RRC signalling tests in the FACH state where a PS RAB is setup:

- PS RAB in TM on DTCH is mapped on E-DCH in uplink and HS-DSCH in downlink.
- Uplink SRBs on DCCH and CCCH are mapped on E-DCH.
- Downlink SRBs on DCCH are mapped on HS-DSCH.

Table 8.3.68.3: Uplink configuration of Cell_FACH_UL_TM_PS

RB Identity	tsc_RB_DTCH_E_DCH_MAC1 (-21)	tsc_RB0 (0)	tsc_RB1 (1)	tsc_RB2 (2)	tsc_RB3 (3)	tsc_RB4 (4)
LogCh Type	DTCH	CCCH	DCCH	DCCH	DCCH	DCCH
LogCh Identity	tsc_UL_DTCH1 (7)	tsc_UL_CCCH5 (5)	tsc_UL_DCCH1 (1)	tsc_UL_DCCH2 (2)	tsc_UL_DCCH3 (3)	tsc_UL_DCCH4 (4)
RLC mode	TM	TM	UM	AM	AM	AM
TrCH Type	E-DCH					
TrCH identity/Mac-d Flow Id	0	7	1			
PhyCh Type	E-DPDCH					
PhyCH identity	tsc_E_DPCH (22)					

Table 8.3.68.3: Downlink configuration of Cell_FACH_UL_TM_PS

RB Identity	tsc_RB_DTC H_E_DCH_M AC1 (-21)	tsc_RB0 (0)	tsc_RB1 (1)	tsc_RB2 (2)	tsc_RB3 (3)	tsc_RB4 (4)	tsc_RB_BCCH_FACH (-3)
LogCh Type	DTCH	CCCH	DCCH	DCCH	DCCH	DCCH	BCCH
LogCh Identity	tsc_DL_DTC H1 (7)	tsc_DL_CCC H2 (2)	tsc_DL_DC CH1 (1)	tsc_DL_DC CH2 (2)	tsc_DL_DCC H3 (3)	tsc_DL_DC CH4 (4)	tsc_BCCH6 (6)
RLC mode	TM	UM	UM	AM	AM	AM	TM
MAC priority	8	1	2	3	4	5	1
TrCH Type	HS-DSCH	HS-DSCH	HS-DSCH				HS-DSCH
TrCH identity / Mac-d Flow Id	2	0	1				NA
PhyCh Type	PDSCH						
PhyCH identity	tsc_HSPDSCH (18)						

8.3.69 Configuration of Cell_FACH_2_SCCPCH_CTCHenhDL_PS (Rel-8 or later)

The configuration is based on 3GPP TS 34.108 [3], clause 6.10.2.4.3.2 for downlink and 3GPP TS 34.108 [3], clause 6.10.2.4.4.1.1.1 for uplink. The configuration is applied to the RAB tests.

The uplink configuration of Cell_FACH_2_SCCPCH_CTCH enhDL_PS is the same as the uplink configuration of Cell_FACH_enhDL_PS.

Table 8.3.69.1: Downlink configuration of Cell_FACH_2_SCCPCH_CTCHenhDL_PS: 1st & 2nd S-CCPCH

RB Identity	tsc_RB30 (30)			
LogCh Type	CTCH			
LogCh Identity	tsc_CTCH1 (11)			
RLC mode	UM	UM	TM	TM
MAC priority	7	1	6	1
TrCH Type	FACH	FACH		PCH
TrCH identity	tsc_FACH2 (14)	tsc_FACH1 (13)		tsc_PCH1 (12)
PhyCh Type	Secondary CCPCH			Secondary CCPCH
PhyCH identity	tsc_S_CCPCH2 (10)			tsc_S_CCPCH1 (5)

Table 8.3.69.2: Downlink configuration of Cell_FACH_2_SCCPCH_CTCHenhDL_PS: HS-PDSCH

RB Identity	tsc_RB25 (25)	tsc_RB0 (0)	tsc_RB1 (1)	tsc_RB2 (2)	tsc_RB3 (3)	tsc_RB4 (4)	tsc_RB_BCCH _FACH (-3)
LogCh Type	DTCH	CCCH	DCCH	DCCH	DCCH	DCCH	BCCH
LogCh Identity	tsc_DL_DT CH1 (7)	tsc_DL_CC CH2 (2)	tsc_DL_DC CH1 (1)	tsc_DL_DC CH2 (2)	tsc_DL_DC CH3 (3)	tsc_DL_DC CH4 (4)	tsc_BCCH6 (6)
RLC mode	AM	UM	UM	AM	AM	AM	TM
MAC priority	8	1	2	3	4	5	1
TrCH Type	HS-DSCH	HS-DSCH		HS-DSCH			HS-DSCH
TrCH identity / Mac-d Flow Id	2	0		1			NA
PhyCh Type	PDSCH						
PhyCH identity	tsc_HSPDSCH (18)						

8.3.70 Configuration of Cell_FACH_2_SCCPCH_CTCHenhDL_PCH (Rel-8 or later)

The configuration is based on 3GPP TS 34.108 [3], clause 6.10.2.4.3.2 for downlink and 3GPP TS 34.108 [3], clause 6.10.2.4.4.1.1.1 for uplink. The configuration is applied to the RAB tests.

The uplink configuration of Cell_FACH_2_SCCPCH_CTCH enhDL_PCH is the same as the uplink configuration of Cell_FACH_enhDL_PCH.

Table 8.3.70.1: Downlink configuration of Cell_FACH_2_SCCPCH_CTCHenhDL_PCH: 1st & 2nd S-CCPCH

RB Identity	tsc_RB30 (30)			
LogCh Type	CTCH			
LogCh Identity	tsc_CTCH1 (11)			
RLC mode	UM	UM	TM	TM
MAC priority	7	1	6	1
TrCH Type	FACH	FACH		PCH
TrCH identity	tsc_FACH2 (14)	tsc_FACH1 (13)		tsc_PCH1 (12)
PhyCh Type	Secondary CCPCH			Secondary CCPCH
PhyCH identity	tsc_S_CCPCH2 (10)			tsc_S_CCPCH1 (5)

Table 8.3.70.2: Downlink configuration of Cell_FACH_2_SCCPCH_CTCHenhDL_PCH: HS-PDSCH

RB Identity	tsc_RB25 (25)	tsc_RB0 (0)	tsc_RB1 (1)	tsc_RB2 (2)	tsc_RB3 (3)	tsc_RB4 (4)	tsc_RB_BC CH_FACH (-3)	tsc_RB_PC CH (-2)
LogCh Type	DTCH	CCCH	DCCH	DCCH	DCCH	DCCH	BCCH	PCCH
LogCh Identity	tsc_DL_DT CH1 (7)	tsc_DL_CC CH2 (2)	tsc_DL_DC CH1 (1)	tsc_DL_DC CH2 (2)	tsc_DL_DC CH3 (3)	tsc_DL_DC CH4 (4)	tsc_BCCH6 (6)	tsc_PCCH_ FACH (11)
RLC mode	AM	UM	UM	AM	AM	AM	TM	TM
MAC priority	8	1	2	3	4	5	1	1
TrCH Type	HS-DSCH	HS-DSCH		HS-DSCH			HS-DSCH	HS-DSCH
TrCH identity / Mac-d Flow Id	2	0		1			NA	NA
PhyCh Type	PDSCH							
PhyCH identity	tsc_HSPDSCH (18)							

8.3.71 Configuration of Cell_FACH_HS (rel-7 or later)

The configuration is based on 3GPP TS 34.108 [3], clause 6.10.2.4.3.2.1.2 for downlink and 3GPP TS 34.108 [3], clause 6.10.2.4.4.1.1.1 for uplink. The configuration is applied to the RRC tests related in the states CELL_FACH, CELL_PCH and URA_PCH. They need a minimum radio configuration for testing.

Table 8.3.71.1: Uplink configuration of Cell_FACH_HS

RB Identity	tsc_RB25 (25)	tsc_RB0 (0)	tsc_RB1 (1)	tsc_RB2 (2)	tsc_RB3 (3)	tsc_RB4 (4)
LogCh Type	DTCH	CCCH	DCCH	DCCH	DCCH	DCCH
LogCh Identity	Tsc_UL_DTCH1 (7)	tsc_UL_CCCH5 (5)	tsc_UL_DCCH1 (1)	tsc_UL_DCCH2 (2)	tsc_UL_DCCH3 (3)	tsc_UL_DCCH4 (4)
RLC mode	AM	TM	UM	AM	AM	AM
TrCH Type	RACH					
TrCH identity	tsc_RACH1 (15)					
PhyCh Type	PRACH					
PhyCH identity	tsc_PRACH1 (8)					

Table 8.3.71.2: Downlink configuration of Cell_FACH_HS

RB Identity	tsc_RB25 (25)	tsc_RB0 (0)	tsc_RB1 (1)	tsc_RB2 (2)	tsc_RB3 (3)	tsc_RB4 (4)	tsc_RB_BC CH_FACH (-3)	tsc_RB_PC CH (-2)	
LogCh Type	DTCH	CCCH	DCCH	DCCH	DCCH	DCCH	BCCH	PCCH	
LogCh Identity	tsc_DL_DT CH1 (7)	tsc_DL_CC CH5 (5)	tsc_DL_DC CH1 (1)	tsc_DL_DC CH2 (2)	tsc_DL_DC CH3 (3)	tsc_DL_DC CH4 (4)	tsc_BCCH6 (6)	tsc_PCCH1 (1)	
RLC mode	AM	UM	UM	AM	AM	AM	TM	TM	
MAC priority	1	1	2	3	4	5	6	1	
TrCH Type	FACH	FACH						PCH	
TrCH identity	tsc_FACH2 (14)	tsc_FACH1 (13)						tsc_PCH1 (12)	
PhyCh Type	Secondary CCPCH								
PhyCH identity	tsc_S_CCPCH1 (5)								

8.4 System information blocks scheduling

All SIBs specified in 3GPP TS 34.108 [3] are broadcast for all test cases in the present document. The repeat period of broadcasting of a complete SIB configuration is 64 frames (0,64 s) as the default configuration.

Except MIB and SB1, they have the highest scheduling rates, SIB7 has also a higher scheduling rate.

According to the default SIB contents in 3GPP TS 34.108 [3], SIB11 and SIB12 have 3 segments. SIB5/SIB5bis has 4 segments for FDD and 5 segments for 1.28 Mcps TDD. SIB 6 has 4 segments. MIB, SB1, SIB1, SIB2, SIB3, SIB4, SIB7 and SIB18 are not segmented, i.e. one segment for each. For the PDCP tests, SIB16 has 7 segments.

Use CMAC_SYSINFO_CONFIG_REQ, CMAC_SYSINFO_CONFIG_CNF and RLC_TR_DATA_REQ as interface to SS for broadcasting.

Two TSOs are defined, one for PER encoding function, the other for segmentation function. The TSOs shall be implemented in the tester.

8.4.1 Grouping SIBs for testing

The grouping of SIBs is defined in 3GPP TS 34.108 [3], clause 6.1.0a.1.

8.4.2 SIB configurations

SIB configurations are defined in 3GPP TS 34.108 [3], clause 6.1.0a.2.

8.4.3 Test SIB default schedule

The SIB default schedule is defined in 3GPP TS 34.108 [3], clause 6.1.0a.3.

8.4.3.1 Test SIB schedule for idle mode, measurement and Inter-RAT UTRAN to GERAN test cases

The SIB schedule is defined in 3GPP TS 34.108 [3], clause 6.1.0a.4.2.

8.4.4 Test SIB special schedule

8.4.4.1 Test SIB schedule for two S-CCPCH or two PRACH

The SIB schedule for two S-CCPCH or two PRACH is defined in 3GPP TS 34.108 [3], clause 6.1.0a.4.1.

8.4.4.2 Test SIB schedule for Inter-Rat Handover from GERAN to UTRAN Test

The SIB schedule for Inter-Rat Handover from GERAN to UTRAN Test is defined in 3GPP TS 34.108 [3], clause 6.1.0a.4.3.

8.4.5 Handling the transmission of SIB

According to the SIB repeat periods, SIBs need to be transmitted on a very regular basis during the operation of a test case. This transmission usually has no direct bearing on the operation of the test case, although the carried information ensures the correct configuration and operation of the UE during the test case.

To send this information repeatedly directly from each test case would make the test cases very complex to implement, difficult to understand and place real-time requirements upon them that are beyond the capabilities of most TTCN driven test engines.

Management of scheduling of System Information messages is performed by the system simulator. The SIB contents, usually determined in part by the individual tests, come from the TTCN test cases.

8.4.5.1 Delivery of System Information content

The content of the System Information messages is delivered as a fully encoded bit string to the TM-RLC SAP from the message content defined in the TTCN test case.

The IE 'SFNprime' in the SI messages is set to 0 by the TTCN, and the correct value of 'SFNprime' shall be inserted by the System Simulator prior to transmission of a SI message.

SI messages are ASN.1 packed encoded through a TTCN TSO and segmented another TTCN TSO into SIBs in the TTCN and sent only once to the TM-RLC SAP. Repetition of the SIB is the responsibility of the System Simulator lower layers.

SIBs are considered to be cached. That is, sending a SIB to the TM-RLC SAP will cause a previously sent copy of the SIB to be lost, and all future transmissions of the SIB will be the most recently sent version. This allows for the updating of System Information during the operation of a test case.

8.4.5.2 Scheduling of system Information blocks

The schedule for the transmission of SIBs is provided by the TTCN test case. It is sent using the CMAC_SYSINFO_CONFIG_REQ primitive sent to the CMAC SAP (CMAC_PCO).

Each CMAC_SYSINFO_CONFIG_REQ primitive carries scheduling information for the next SIB sent from the TTCN. Each primitive is followed by an associated SIB. Sending two CMAC_SYSINFO_CONFIG_REQ primitives in succession may cause an unspecified result.

8.4.5.3 Example of usage

The following example shows how the MIB, SB1 and all SIBs in subclause 8.4.3 are sent to the System Simulator lower layers for broadcasting. The 1st parameter in CMAC_SYSINFO_CONFIG_REQ represents the repeat period in power of 2. The 2nd parameter represents the repetition position. Two consecutive frames represent an available repetition position.

```
CMAC_PCO: CMAC_SYSINFO_CONFIG_REQ (3, 0)
TM_PCO: MIB
CMAC_PCO: CMAC_SYSINFO_CONFIG_REQ (4, 1)
TM_PCO: SB1
CMAC_PCO: CMAC_SYSINFO_CONFIG_REQ (6, 2)
```

TM_PCO: SIB7
CMAC_PCO: CMAC_SYSINFO_CONFIG_REQ (6, 3)
TM_PCO: SIB6 (segment 1 of 4)
CMAC_PCO: CMAC_SYSINFO_CONFIG_REQ (6, 5)
TM_PCO: SIB6 (segment 2 of 4)
CMAC_PCO: CMAC_SYSINFO_CONFIG_REQ (6, 6)
TM_PCO: SIB6 (segment 3 of 4)
CMAC_PCO: CMAC_SYSINFO_CONFIG_REQ (6, 7)
TM_PCO: SIB6 (segment 4 of 4)
CMAC_PCO: CMAC_SYSINFO_CONFIG_REQ (6, 10)
TM_PCO: SIB7 + SIB3 (concatenation)
CMAC_PCO: CMAC_SYSINFO_CONFIG_REQ (6, 11)
TM_PCO: SIB1 + SIB2 (concatenation)
CMAC_PCO: CMAC_SYSINFO_CONFIG_REQ (6, 13)
TM_PCO: SIB12 (segment 1 of 3)
CMAC_PCO: CMAC_SYSINFO_CONFIG_REQ (6, 14)
TM_PCO: SIB12 (segment 2 of 3)
CMAC_PCO: CMAC_SYSINFO_CONFIG_REQ (6, 15)
TM_PCO: SIB12 (segment 3 of 3)
CMAC_PCO: CMAC_SYSINFO_CONFIG_REQ (6, 18)
TM_PCO: SIB7 + SIB18 (concatenation)
CMAC_PCO: CMAC_SYSINFO_CONFIG_REQ (6, 19)
TM_PCO: SIB5/SIB5bis (segment 1 of 4)
CMAC_PCO: CMAC_SYSINFO_CONFIG_REQ (6, 21)
TM_PCO: SIB5/SIB5bis (segment 2 of 4)
CMAC_PCO: CMAC_SYSINFO_CONFIG_REQ (6, 22)
TM_PCO: SIB5/SIB5bis (segment 3 of 4)
CMAC_PCO: CMAC_SYSINFO_CONFIG_REQ (6, 23)
TM_PCO: SIB5/SIB5bis (segment 4 of 4)
CMAC_PCO: CMAC_SYSINFO_CONFIG_REQ (6, 26)
TM_PCO: SIB7 + SIB4 (concatenation)
CMAC_PCO: CMAC_SYSINFO_CONFIG_REQ (6, 27)
TM_PCO: No segment
CMAC_PCO: CMAC_SYSINFO_CONFIG_REQ (6, 29)
TM_PCO: SIB11 (segment 1 of 3)
CMAC_PCO: CMAC_SYSINFO_CONFIG_REQ (6, 30)
TM_PCO: SIB11 (segment 3 of 3)
CMAC_PCO: CMAC_SYSINFO_CONFIG_REQ (6, 31)
TM_PCO: SIB11 (segment 3 of 3)

8.5 Security in testing

The security functions at the SS side are implemented in RLC and MAC layers. When the AM or UM RLC entities and a MAC(d) entity are created, the TTCN will download a security context for each CN domain used. The two ASPs CMAC_SecurityMode_Config_REQ and CRLC_SecurityMode_Config_REQ configures the SS security contexts and associate the contexts to the created entities. The SS shall support one activate security contexts and one context pending activation for each CN domain.

A security context at the SS consists of the security parameter START, 20 bits long and a pair of integrity key and a ciphering key, each 128 bits long. All these security parameters belong to a CS or a PS domain. The SS shall have the ability to store these values till the new values are downloaded and activated. $START_{cs}$ is used for initialization of all counters-C and counters-I (32 bits long each) of all DL and UL radio bearers for ciphering and integrity protection in the CS domain. The same is for $START_{ps}$ in the PS domain. The TTCN downloads the new START value whenever it is received from the UE. In the case of a succeeded authentication procedure, the START value is reset to zero by the TTCN.

Once the START is downloaded the SS will, according to the activation time, initialize the 20 most significant bits of the RRC HFN (for integrity protection), the RLC HFN (for ciphering) and the MAC-d HFN (for ciphering) to the START value of the corresponding service domain; the remaining bits are initialized to 0.

Upon the concerned RLC entities and the MAC(d) entity release in the SS, the associated security contexts are no longer used and shall be removed as well. The RLC and the MAC(d) entities are addressed by the TTCN with the cell id = -1.

8.5.1 Authentication

A GMM or MM authentication test step makes use of a number of TSOs to generate an authentication vector:

$$AV := \{RAND, XRES, CK, IK, AUTN\}$$

If the UE has valid authentication parameters (CKSN/KSI), for the respective domain, use of the Authentication procedure after an INITIAL DIRECT TRANSFER message is optional. Authentication in this case will be left to the test case implementation and need not be specified in the prose. However, in the case where the UE does not have valid authentication parameters the Authentication procedure shall be performed.

8.5.2 Ciphering

The ciphering in the SS is activated through the ASP CRLC_Ciphering_Activate_REQ for the AM or UM mode and through CMAC_Ciphering_Activate_REQ for the TM mode.

A PIXIT parameter px_CipheringOnOff indicates whether all the tests are performed under ciphering activated or not. If ciphering should be off at the test execution, the ciphering algorithm in IE ciphering ModeInfo is set to uea0 (no encryption). The UE under test is informed about the SS ciphering capability via IE cipheringAlgorithmCap set to uea0.

Table 8.5.2 gives the mapping of the RB id and the bearer value used in the ciphering calculation at the SS side.

Table 8.5.2: Mapping between RB identity in ASP and BEARER value in the ciphering calculation

RB identity (TTCN constant)	Direction	RLC mode	BEARER value	Type	Comments
-1 (tsc_RB_BCCH)	downlink	TM	N/A		No ciphering applicable
-2 (tsc_RB_PCCH)	downlink	TM	N/A		No ciphering applicable
-3 (tsc_RB_BCCH_FACH)	downlink	TM	N/A		No ciphering applicable
-4 (tsc_RB_2ndPCCH)	downlink	TM	N/A		No ciphering applicable
-5 (tsc_RB_2ndCCCH)	uplink	TM	N/A		No ciphering applicable
-6 (tsc_RB_MTCH_RLC_TR)	downlink	TM	N/A	RAB	For RLC MTCH test, no ciphering applicable
-8 (tsc_RB_MCCH_RLC_TR)	downlink	TM	N/A		No ciphering applicable
-10 (tsc_RB_UM_7_RLC)	downlink	TM	N/A	RAB	For UM RLC tests using 7 bit Lis, no ciphering used
-10 (tsc_RB_UM_7_RLC)	uplink	TM	N/A	RAB	For UM RLC tests using 7 bit Lis, no ciphering used
-11 (tsc_RB_UM_15_RLC)	downlink	TM	N/A	RAB	For UM RLC tests using 15 bit Lis, no ciphering used
-11 (tsc_RB_UM_15_RLC)	uplink	TM	N/A	RAB	For UM RLC tests using 15 bit Lis, no ciphering used
-12 (tsc_RB_AM_7_RLC)	downlink	TM	N/A	RAB	For AM RLC tests using 15 bit Lis, no ciphering used
-12 (tsc_RB_AM_7_RLC)	uplink	TM	N/A	RAB	For AM RLC tests using 7 bit Lis, no ciphering used
-13 (tsc_RB_AM_15_RLC)	downlink	TM	N/A	RAB	For AM RLC tests using 15 bit Lis, no ciphering used
-13 (tsc_RB_AM_15_RLC)	uplink	TM	N/A	RAB	For AM RLC tests using 15 bit Lis, no ciphering used
-14 (tsc_RB_DCCH_FACH_MAC)	downlink	TM	N/A	SRB3	MAC testing no ciphering used
-14 (tsc_RB_DCCH_FACH_MAC)	uplink	TM	N/A	SRB3	MAC testing no ciphering used
-15 (tsc_RB_DCCH_DCH_MAC)	downlink	TM	N/A	SRB3	MAC testing no ciphering used
-15 (tsc_RB_DCCH_FACH_MAC)	uplink	TM	N/A	SRB3	MAC testing no ciphering used
-16 (tsc_RB3_DCCH_RRC)	uplink	AM	2	SRB3	
-18 (tsc_RB_CCCH_FACH_MAC)	downlink	TM	N/A	SRB0	No ciphering applicable
-19 (tsc_RB_BCCH_FACH_RAB)	downlink	TM	N/A	SRB	No ciphering applicable
-20 (tsc_RB_DTCH_E_DCH_MAC)	uplink	TM	N/A	RAB	MAC testing no ciphering used
-21 (tsc_RB_DTCH_E_DCH_MAC1)	uplink	TM	N/A	RAB	MAC testing no ciphering used
-22 (tsc_RB_DTCH_E_DCH_MAC2)	uplink	TM	N/A	RAB	MAC testing no ciphering used
-25 (tsc_RB_MAC_HS)	downlink	TM	N/A	RAB	MAC/RLC testing no ciphering used
-25 (tsc_RB_MAC_HS)	uplink	TM	N/A	RAB	MAC/RLC testing no ciphering used
-26 (tsc_RB_MAC_ehs_26)	downlink	TM	N/A	RAB	MACehs testing no ciphering used
-26 (tsc_RB_MAC_ehs_26)	Uplink	TM	N/A	RAB	MACehs testing no ciphering used
-27 (tsc_RB_MAC_ehs_27)	downlink	TM	N/A	RAB	MACehs testing no ciphering used
-27 (tsc_RB_MAC_ehs_27)	downlink	TM	N/A	RAB	MACehs testing no ciphering used
0 (tsc_RB0)	uplink	TM	N/A	SRB0	No ciphering applicable
0 (tsc_RB0)	downlink	UM	N/A	SRB0	No ciphering applicable
1 (tsc_RB1)	uplink	UM	0	SRB1	
1 (tsc_RB1)	downlink	UM	0	SRB1	
2 (tsc_RB2)	uplink	AM	1	SRB2	
2 (tsc_RB2)	downlink	AM	1	SRB2	
3 (tsc_RB3)	uplink	AM	2	SRB3	
3 (tsc_RB3)	downlink	AM	2	SRB3	
4 (tsc_RB4)	uplink	AM	3	SRB4	
4 (tsc_RB4)	downlink	AM	3	SRB4	
5 (tsc_RB5)	uplink	TM	4	SRB	DCCH
5 (tsc_RB5)	downlink	TM	4	SRB	DCCH
6	uplink		5		Not used currently
6	downlink		5		Not used currently
7	uplink		6		Not used currently
7	downlink		6		Not used currently
8	uplink		7		Not used currently
8 (tsc_RB_MCCH)	downlink	UM	7		No ciphering applicable
9	uplink		8		Not used currently
9 (tsc_RB_MSCH)	downlink		8		No ciphering applicable
10 (tsc_RB10)	uplink	TM	9	RAB#1-1	or RAB1
10 (tsc_RB10)	downlink	TM	9	RAB#1-1	or RAB1
11 (tsc_RB11)	uplink	TM	10	RAB#1-2	or RAB2
11 (tsc_RB11)	downlink	TM	10	RAB#1-2	or RAB2
12 (tsc_RB12)	uplink	TM	11	RAB#1-3	
12 (tsc_RB12)	downlink	TM	11	RAB#1-3	
13 (tsc_RB13)	uplink	TM	12	RAB#2	
13 (tsc_RB13)	downlink	TM	12	RAB#2	
14	uplink		13		Not used currently
14 (tsc_MTCH1)	downlink	UM	13		No ciphering
15	uplink		14		Not used currently
15 (tsc_MTCH2)	downlink	UM	14		No ciphering
16	uplink		15		Not used currently
16 (tsc_MTCH3)	downlink	UM	15		No ciphering
17 (tsc_RB17)	uplink	AM	16	RAB#2	

RB identity (TTCN constant)	Direction	RLC mode	BEARER value	Type	Comments
17 (tsc_RB17)	downlink	AM	16	RAB#2	
20 (tsc_RB20)	uplink	AM	19	RAB#1	
20 (tsc_RB20)	downlink	AM	19	RAB#1	
21 (tsc_RB21)	uplink	UM	20	RAB#2	
21 (tsc_RB21)	downlink	UM	20	RAB#2	
22 (tsc_RB22)	uplink	AM	21	RAB#2	
22 (tsc_RB22)	downlink	AM	21	RAB#2	
23 (tsc_RB23)	uplink	AM	22	RAB#2	
23 (tsc_RB23)	downlink	AM	22	RAB#2	
24 (tsc_RB24)	uplink	AM	23	RAB#2	
24 (tsc_RB24)	downlink	AM	23	RAB#2	
25 (tsc_RB25)	uplink	AM	24	RAB#1	
25 (tsc_RB25)	downlink	AM	24	RAB#1	
26 (tsc_RB26)	uplink	UM	25	RAB#1	MAC testing no ciphering used
26 (tsc_RB26)	downlink	UM	25	RAB#1	MAC testing no ciphering used
27 (tsc_RB27)	uplink	UM	26	RAB#2	MAC testing no ciphering used
27 (tsc_RB27)	downlink	UM	26	RAB#2	MAC testing no ciphering used
28 (tsc_RB28)	uplink	AM	27	RAB#3	MAC testing no ciphering used
28 (tsc_RB28)	downlink	AM	27	RAB#3	MAC testing no ciphering used
29	uplink		28		Not used yet currently
29 (tsc_RB29)	downlink	AM	28	SRB0	No ciphering applicable
30	uplink		29		Not used yet currently
30 (tsc_RB30)	downlink	UM	N/A		CTCH FACH no ciphering used
31	uplink		30		Not used yet currently
31 (tsc_RB31)	downlink	UM	N/A		CTCH FACH no ciphering used
32	uplink		31		Not used yet currently
32	downlink		31		Not used yet currently

8.5.3 Integrity

The integrity protection in the SS is activated through the ASP CRLC_Integrity_Activate_REQ for all SRB.

MAC-I (MessageAuthenticationCode) is calculated by the SS. If the integrity protection is not yet started, the "integrity protection info" IE is omitted in TTCN. If integrity protection is started the TTCN includes the "integrity protection info" IE with all bits set to "0". The SS takes care of all the necessary initialization and calculation on SRBs.

Once integrity is started, the SS initializes and calculates a correct Message Authentication Code, overrides the initial value all bits "0" and inserts a corresponding RRC message sequence number into the IntegrityCheckInfo for all DL DCCH messages. In UL, the SS shall check the received MessageAuthenticationCode. If it is wrong, the ASP CRLC_Integrity_Failure_IND will report having received an UL message with integrity error. If it is correct SS forwards the received messages to the TTCN.

In addition, CRLC_MAC_I_Mode_REQ can be used to force the SS generate wrong DL MAC-I on a specific SRB for the integrity error handling test.

8.5.4 Test security scenarios

Five basic test scenarios are presented in the present document. The corresponding core spec references are found in 3GPP TS 25.331 [21], clauses 8.1.12, 8.2.2.2, 8.5.10.1, 8.5.10.2, 8.6.3.4, 8.6.3.5, 8.6.4.3 and 8.6.4.8.

- Start security;
- RB setup;
- AM RB reconfiguration;
- Security modification;
- SRNS relocation;
- Modification of RLC size of AM RB during RB reconfiguration;
- Cell/URA update;
- InterRAAt HO to UTRAN.

As Default, the 1st three basic scenarios can be subdivided into:

- Start integrity without ciphering start;
- Start integrity and ciphering at the same time.

Regarding the simultaneous SRNS relocation, the security scenarios at the relocation are split into:

- No security configuration modification;
- Modification of integrity (FRESH) without ciphering configuration change;
- Modification integrity FRESH and ciphering algorithm;
- A security modification pending at the SRNS relocation.

This clause shows the procedures how the security ASP applied to the SS configurations at the different security test scenarios.

8.5.4.1 Start security function

CIPHERING_STATUS = NotStarted for the CN domain concerned.

8.5.4.1.1 Start integrity protection without start of ciphering

INTEGRITY_PROTECTION Status = NotStarted.

SECURITY MODE COMMAND with "Integrity protection mode info" IE containing integrityProtectionModeCommand = Start, no "Ciphering mode info" IE

1 Before sending SECURITY MODE COMMAND (SMC)

```
CRLC_SecurityMode_Config_REQ
    startValue = value most recently received or 0 (new key)
    integrityKey = value maintained by TTCN
    cn_DomainIdentity = CS or PS
CRLC_SetRRC_MessageSN_REQ (SN=0)
    -- Downlink RRC message sequence number set to 0
CRLC_Integrity_Activate_REQ (CN domain concerned)
    integrityProtectionModeCommand = startIntegrityProtection (FRESH)
    integrityProtectionAlgorithm = selected value
    -- downlink integrity protection starts immediately
CRLC_Integrity_Activate_REQ (CN domain concerned)
    ul_IntegProtActivationInfo = 0 (RB2 only)
```

2 Send SECURITY MODE COMMAND

3 After receiving SECURITY MODE COMPLETE

```
CRLC_Integrity_Activate_REQ (CN domain concerned)
    ul_IntegProtActivationInfo = value in "Uplink integrity protection activation time"
    (except RB2) received from SECURITY MODE COMPLETE
```

8.5.4.1.2 Start both integrity protection and ciphering

INTEGRITY_PROTECTION Status = NotStarted.

SECURITY MODE COMMAND with "Integrity protection mode info" IE containing integrityProtectionModeCommand = Start, and "Ciphering mode info" IE containing cipheringModeCommand = Start/Restart (algorithm UEA0 or UEA1)

1 Before sending SECURITY MODE COMMAND message

```
CRLC_SecurityMode_Config_REQ
    startValue = value most recently received or 0 (new key)
    cipheringKey = value maintained by TTCN
    integrityKey = value maintained by TTCN
    cn_DomainIdentity = CS or PS
CRLC_SequenceNumber_REQ
    -- Get current RLC SN of all SRB for calculating suitable down link activation time
CRLC_Suspend_REQ
    -- Suspend all signalling radio bearers except RB2. Optionally an SS may start immediate
    suspension of processing of data PDUs in the UL. The UL control PDUs and Piggybacked Status
    may optionally be processed.
CRLC_Ciphering_Activate_REQ (CN domain concerned)
    cipheringModeCommand = Start/Restart (algorithm)
    rb_DL_CiphActivationTimeInfo = calculated activation time
    incHFN = NotInc
CRLC_SetRRC_MessageSN_REQ (SN=0)
    -- Downlink RRC message sequence number set to 0
```

```

CRLC_Integrity_Activate_REQ (CN domain concerned)
    integrityProtectionModeCommand = startIntegrityProtection (FRESH)
    integrityProtectionAlgorithm = selected value
    (downlink integrity protection starts immediate)
CRLC_Integrity_Activate_REQ (CN domain concerned)
    ul_IntegProtActivationInfo = 0 (RB2 only)
CRLC_ProhibitRLC_Ack_REQ
    mode = prohibit (RB3 only)
    -- An SS supporting suspension of UL data PDUs may provide a dummy CRLC_ProhibitRLC_Ack_CNF

```

2 Send SECURITY MODE COMMAND

3 After receiving SECURITY MODE COMPLETE

```

CRLC_Ciphering_Activate_REQ (CN domain concerned)
    rb_UL_CipheringActivationTimeInfo = value received in SECURITY MODE COMPLETE
    incHFN = NotInc
CRLC_Integrity_Activate_REQ (CN domain concerned)
    ul_IntegProtActivationInfo = value in "Uplink integrity protection activation time"
    (except RB2) received from SECURITY MODE COMPLETE
CRLC_ProhibitRLC_Ack_REQ
    mode = continue (RB3 only)
    -- An SS supporting suspension of UL data PDUs may provide a dummy CRLC_ProhibitRLC_Ack_CNF
CRLC_Resume_REQ
    -- If the SS implemented the optional suspension of UL data PDUs, then the processing in the
    UL of data PDUs shall be resumed. Any suspended UL control PDUs and Piggybacked Status shall
    be preceded or resumed.

```

8.5.4.1.3 Void

8.5.4.2 RB setup

INTEGRITY_PROTECTION Status = Started.
 Condition: "RAB information for setup" IE included in RADIO BEARER SETUP

8.5.4.2.1 AM / UM RB

- 1 Sending the RADIO BEARER SETUP message.
- 2 Configuring the RB.
- 3 After receiving RADIO BEARER SETUP COMPLETE.

8.5.4.2.1.1 Ciphering not started

CIPHERING_STATUS = NotStarted for the CN domain concerned

```

CRLC_SecurityMode_Config_REQ
    startValue = value most recently received
    cipheringKey = value maintained by TTCN
    cn_DomainIdentity = CS or PS
CRLC_Ciphering_Activate_REQ (CN domain concerned)
    cipheringModeCommand = NULL (no ciphering)
    rb_DL_CiphActivationTimeInfo = 0 (from the first block)
    incHFN = NotInc
CRLC_Ciphering_Activate_REQ (CN domain concerned)
    rb_UL_CipheringActivationTimeInfo = 0 (from the first block)
    incHFN = NotInc

```

8.5.4.2.1.2 Ciphering started

CIPHERING_STATUS = Started for the CN domain concerned

```
CRLC_SecurityMode_Config_REQ
  startValue = value most recently received
  cipheringKey = value maintained by TTCN
  cn_DomainIdentity = CS or PS
CRLC_Ciphering_Activate_REQ (CN domain concerned)
  cipheringModeCommand = Start/Restart (algorithm)
  rb_DL_CiphActivationTimeInfo = 0 (from the first block)
  incHFN = NotInc
CRLC_Ciphering_Activate_REQ (CN domain concerned)
  rb_UL_CipheringActivationTimeInfo = 0 (from the first block)
  incHFN = NotInc
```

8.5.4.2.2 TM RB

Enter Cell_DCH,
no TM RB established before,
"COUNT-C activation time" IE included in RADIO BEARER SETUP COMPLETE message.

8.5.4.2.2.1 Ciphering not started

CIPHERING_STATUS = NotStarted for the CN domain concerned,

- 1 Send the RADIO BEARER SETUP message**
- 2 Configuring the RB**
- 3 After receiving RADIO BEARER SETUP COMPLETE**

```
CMAC_SecurityMode_Config_REQ
  startValue = value most recently received
  cn_DomainIdentity = CS or PS
CMAC_Ciphering_Activate_REQ (CN domain concerned)
  incHFN = NotInc
  cipheringModeCommand = NULL (no ciphering)
  activationTimeForDPCH = value in "COUNT-C activation time"
```

8.5.4.2.2.2 Ciphering started

CIPHERING_STATUS = Started for the CN domain concerned,

- 1 Sending RADIO BEARER SETUP**
- 2 Configuring the RB**

```
CMAC_SecurityMode_Config_REQ
  startValue = value most recently received
  cipheringKey = value maintained by TTCN
  cn_DomainIdentity = CS or PS
CMAC_Ciphering_Activate_REQ (CN domain concerned)
  incHFN = NotInc
  cipheringModeCommand = Start/Restart (algorithm)
  activationTimeForDPCH = value in "Activation time" of the RB
```

- 3 After receiving RADIO BEARER SETUP COMPLETE message**

```
CMAC_SecurityMode_Config_REQ
  startValue = value received in response message
  cipheringKey = value maintained by TTCN
  cn_DomainIdentity = CS or PS
CMAC_Ciphering_Activate_REQ (CN domain concerned)
  incHFN = IncPerCFN_Cycle
  cipheringModeCommand = Start/Restart (algorithm)
  activationTimeForDPCH = value in "COUNT-C activation time"
```

8.5.4.3 RB Reconfiguration for AM RAB modification of RLC size

CIPHERING_STATUS = Started for the CN domain concerned,
 "RB mapping info" IE, **changing AM RB RLC size**, is included in
 CELL UPDATE CONFIRM,
 RADIO REARER RECONFIGURATION,
 RADIO BEARER RELEASE

8.5.4.3.1 "RB mapping info" in CELL UPDATE CONFIRM

After sending the CELL UPDATE CONFIRM message, re-establish the RB and re-configure the RB with new RLC size and re-initialize COUNT-C for the RB:

```
CRLC_Config_REQ
  Release the concerned RB
CRLC_Config_REQ
  Setup the concerned RB (new RLC size)
CRLC_SecurityMode_Config_REQ
  startValue = value received in the CELL UPDATE message
  integrityKey = value maintained by TTCN
  cn_DomainIdentity = CS or PS
CRLC_Ciphering_Activate_REQ
  cipheringModeCommand = Start/Restart (existing algorithm)
  rb_DL_CiphActivationTimeInfo = now
  incHFN = NotInc
CRLC_Ciphering_Activate_REQ
  rb_UL_CiphActivationTimeInfo = now
  incHFN = NotInc
```

8.5.4.3.2 "RB mapping info" in RB RECONFIGURATION / RELEASE

After receiving the reconfiguration complete message, re-establish the RB and re-configure the RB with new RLC size and re-initialize COUNT-C for the RB:

```
CRLC_Config_REQ
  Release the concerned RB
CRLC_Config_REQ
  Setup the concerned RB (new RLC size)
CRLC_SecurityMode_Config_REQ
  startValue = value received in the reconfiguration complete message
  integrityKey = value maintained by TTCN
  cn_DomainIdentity = CS or PS
CRLC_Ciphering_Activate_REQ
  cipheringModeCommand = Start/Restart (existing algorithm)
  rb_DL_CiphActivationTimeInfo = now
  incHFN = NotInc
CRLC_Ciphering_Activate_REQ
  rb_UL_CiphActivationTimeInfo = now
  incHFN = NotInc
```

8.5.4.4 Security modification

Updating security keys is the scenario in this clause.

INTEGRITY_PROTECTION_STATUS = Started
 SECURITY_MODE_COMMAND contains "Ciphering mode info" IE and/or "Integrity protection mode info" IE

8.5.4.4.1 Integrity started, ciphering not started

CIPHERING_STATUS = NotStarted for the CN domain concerned
 SECURITY MODE COMMAND with "Integrity protection mode info" IE containing
 integrityProtectionModeCommand = modify, but "Ciphering mode info" IE absent the same CN domain as
 in the previous SMC to start integrity protection.

1 Before sending SECURITY MODE COMMAND message

```
CRLC_SecurityMode_Config_REQ
  startValue = 0 (new key)
  integrityKey = new key
  cn_DomainIdentity = CS or PS
CRLC_RRC_MessageSN_REQ
  -- Get current RRC Message SN for calculation of DL activation time
CRLC_Integrity_Activate_REQ (CN domain concerned)
  integrityProtectionModeCommand = modify
  dl_IntegrityProtActivationInfo = now (SRB2), calculated value or a pending activation
  time set by previous security mode control procedure (SRB2 other than SRB2)
CRLC_Integrity_Activate_REQ (CN domain concerned, RB2)
  ul_IntegrityProtActivationInfo = now
```

2 Sending SECURITY MODE COMMAND message

3 After receiving SECURITY MODE COMPLETE

```
CRLC_Integrity_Activate_REQ (CN domain concerned)
  ul_IntegProtActivationInfo = value in "Uplink integrity protection activation time"
  (except RB2)
```

8.5.4.4.2 Integrity and ciphering started

CIPHERING_STATUS = Started for the CN domain concerned
 SECURITY MODE COMMAND contains
 "Integrity protection mode info" IE with integrityProtectionModeCommand = modify,
 "Ciphering mode info" IE with cipheringModeCommand = Start/Restart.

1 Before sending SECURITY MODE COMMAND message

```
CRLC_SecurityMode_Config_REQ
  startValue = 0 (new key)
  integrityKey = new key
  cipheringKey = new key
  cn_DomainIdentity = CS or PS
if TM RB exist
  CMAC_SecurityMode_Config_REQ
    startValue = 0 ( new key)
    cipheringKey = new key
    integrityKey = new key
    cn_DomainIdentity = CS or PS
CRLC_SequenceNumber_REQ
  -- Get current RLC SN for calculating suitable down link activation time
CRLC_Suspend_REQ
  -- Optionally an SS may start immediate suspension of processing of data PDUs in the UL. The
  UL control PDUs and Piggybacked Status may optionally be processed.

CRLC_Ciphering_Activate_REQ (CN domain concerned)
  cipheringModeCommand = Start/Restart (existing algorithm)
  rb_DL_CiphActivationTimeInfo = calculated activation time
  incHFN = NotInc
CRLC_RRC_MessageSN_REQ
  -- Get current RRC message SN for calculating suitable DL activation time
CRLC_Integrity_Activate_REQ (CN domain concerned)
  integrityProtectionModeCommand = modify
  dl_IntegrityProtActivationInfo = now (SRB2), calculated value or a pending activation
  time set by previous security mode control procedure (SRB other than SRB2)
CRLC_Integrity_Activate_REQ (CN domain concerned, RB2)
  ul_IntegrityProtActivationInfo = now
if TM RB exist
  CPHY_Frame_Number_REQ
    --Get current CFN for calculating suitable activation time for TM RB
  CMAC_Ciphering_Activate_REQ (CN domain concerned)
    cipheringModeCommand = Start/Restart (existing algorithm)
    activationTimeForDPCH = calculated activation time
    incHFN = IncPerCFN_Cycle
CRLC_ProhibitRLC_Ack_REQ
```

mode = prohibit (RB3 only)
 -- An SS supporting suspension of UL data PDUs may provide a dummy CRLC_ProhibitRLC_Ack_CNF

2 Sending SECURITY MODE COMMAND message

3 After receiving SECURITY MODE COMPLETE

CRLC_Ciphering_Activate_REQ (CN domain concerned)
 rb_UL_CipheringActivationTimeInfo = value received in SECURITY MODE COMPLETE
 incHFN = NotInc
 CRLC_Integrity_Activate_REQ (CN domain concerned, except RB2)
 ul_IntegProtActivationInfo = value in "Uplink integrity protection activation time"
 CRLC_ProhibitRLC_Ack_REQ
 mode = continue (RB3 only)
 -- An SS supporting suspension of UL data PDUs may provide a dummy CRLC_ProhibitRLC_Ack_CNF
 CRLC_Resume_REQ
 -- If the SS implemented the optional suspension of UL data PDUs, then the processing in the
 UL of data PDUs shall be resumed. Any suspended UL control PDUs and Piggybacked Status shall
 be preceded or resumed.

8.5.4.5 SRNS relocation

Simultaneous SRNS relocation will take place
 either "Downlink count synchronization info" IE is received in
 CELL UPDATE CONFIRM,
 PHYSICAL CHANNEL RECONFIGURATION,
 RADIO BEARER SETUP,
 RADIO BEARER RELEASE,
 TRANSPORT CHANNEL RECONFIGURATION,
 URA UPDATE CONFIRM,
 UTRAN MOBILITY INFORMATION,
 or "new U-RNTI" IE is received in
 RADIO BEARER RECONFIGURATION.

INTEGRITY_PROTECTION Status = Started

8.5.4.5.1 Void

8.5.4.5.2 Presence of "Integrity protection mode info" but absence of "Ciphering mode info"

SRNS relocation related messages listed contains "Integrity protection mode info" but does not have "Ciphering mode info" IE.

SRNS relocation related message with "Integrity protection mode info" IE containing
 integrityProtectionModeCommand = Start, but no "Ciphering mode info" IE (no ciphering configuration
 change).

8.5.4.5.2.1 No security configuration pending

No security configuration pending triggered by previous SECURITY MODE COMMAND.

1 Before sending one of the SRNS relocation related messages

CRLC_SecurityMode_Config_REQ
 startValue = OMIT (no COUNT-I re-initialization)
 integrityKey = OMIT or value maintained by TTCN (no key change)
 cn_DomainIdentity = CS or PS
 CRLC_Integrity_Activate_REQ (CN domain concerned)
 integrityProtectionModeCommand = Start (FRESH)
 integrityProtectionAlgorithm = selected value
 -- downlink integrity protection starts immediately
 CRLC_Integrity_Activate_REQ (CN domain concerned)
 ul_IntegProtActivationInfo = value (now)

2 Sending one of the SRNS relocation related messages

3 Re-establishing RB2 and re-initialize COUNT-C for RB2

```

CRLC_SequenceNumber_REQ
CRLC_SequenceNumber_CNF
    newHFN = MAX(HFN of DL COUNT-C of RB2, HFN of UL COUNT-C of RB2) + 1
CRLC_Config_REQ
    -- Release RB2
CRLC_Config_REQ
    -- Setup RB2
CRLC_SecurityMode_Config_REQ
    startValue = newHFN
    cn_DomainIdentity = CS or PS concerned
CRLC_Ciphering_Activate_REQ (CN domain concerned)
    if CIPHERING_STATUS= NotStarted
        cipheringModeCommand = NULL (no ciphering)
    if CIPHERING_STATUS = Started
        cipheringModeCommand = Start/Restart (existing algorithm)
    rb_DL_CiphActivationTimeInfo = now (RB2 only)
    incHFN = NotInc
CRLC_Ciphering_Activate_REQ (CN domain concerned)
    rb_UL_CipheringActivationTimeInfo = now (RB2 only)
    incHFN = NotInc

```

4 Receiving the response message

5 Re-establishing all RBs and SRBs (except SRB2) and re-initialize COUNT-C for all RBs and SRBs (except SRB2)

```

CRLC_Config_REQ
    -- Release all RBs and all SRBs (except SRB2)
CRLC_Config_REQ
    -- Setup all RB's and all SRB's (except RB2)
CRLC_SecurityMode_Config_REQ
    startValue = value received in the response message
    integrityKey = value maintained by TTCN
    cn_DomainIdentity = CS or PS
CRLC_Ciphering_Activate_REQ
    if CIPHERING_STATUS= NotStarted
        cipheringModeCommand = NULL (no ciphering)
    if CIPHERING_STATUS = Started
        cipheringModeCommand = Start/Restart (existing algorithm)
    rb_DL_CiphActivationTimeInfo = now (except SRB2)
    incHFN = NotInc
CRLC_Ciphering_Activate_REQ
    rb_UL_CiphActivationTimeInfo = now (except SRB2)
    incHFN = NotInc

```

8.5.4.5.2.2 Pending security configuration (new keys)

A pending security configuration is triggered by the previous SECURITY MODE COMMAND (new Key).

1 Before sending one of the SRNS relocation related messages

```

CRLC_SecurityMode_Config_REQ
    startValue = 0 (new key)
    integrityKey = new key
    cn_DomainIdentity = CS or PS
CRLC_Integrity_Activate_REQ
    IntegrityProtectionModeCommand = Start (FRESH)
    IntegrityProtectionAlgorithm = selected value (downlink integrity protection starts
    immediately)
CRLC_Integrity_Activate_REQ
    ul_IntegProtActivationInfo = value (now)

```

2 Send one of the SRNS relocation related messages

3 Re-establish RB2 and re-initialize COUNT-C for RB2

```

CRLC_SequenceNumber_REQ
CRLC_SequenceNumber_CNF
    HFN = MAX(HFN of DL/UL COUNT-C of RB2) + 1
CRLC_Config_REQ
    Release RB2
CRLC_Config_REQ
    Setup RB2

```



```

CRLC_SecurityMode_Config_REQ
  startValue = HFN calculated above
  cipheringKey = new key
  cn_DomainIdentity = CS or PS
CRLC_Ciphering_Activate_REQ
  if CIPHERING_STATUS= NotStarted
    cipheringModeCommand = NULL (no ciphering)
  if CIPHERING_STATUS = Started
    cipheringModeCommand = Start/Restart (existing algorithm)
  rb_DL_CiphActivationTimeInfo = now (RB2 only)
  incHFN = NotInc
CRLC_Ciphering_Activate_REQ
  rb_UL_CipheringActivationTimeInfo = now (RB2 only)
  incHFN = NotInc

```

4 Receive the response message

5 Re-establish all RBs and SRBs (except RB2) and re-initialize COUNT-C for all RBs and SRBs (except RB2)

```

CRLC_Config_REQ
  Release all RB's and SRB's (except RB2)
CRLC_Config_REQ
  Setup all RB's and SRB's (except RB2)
CRLC_SecurityMode_Config_REQ
  startValue = value received in the response message
  integrityKey = new key
  cipheringKey = new key
  cn_DomainIdentity = CS or PS
CRLC_Ciphering_Activate_REQ
  if CIPHERING_STATUS= NotStarted
    cipheringModeCommand = NULL (no ciphering)
  if CIPHERING_STATUS = Started
    cipheringModeCommand = Start/Restart (existing algorithm)
  rb_DL_CiphActivationTimeInfo = now (except RB2)
  incHFN = NotInc
CRLC_Ciphering_Activate_REQ
  rb_UL_CiphActivationTimeInfo = now (except RB2)
  incHFN = NotInc

```

6 Re-initialize COUNT-I for all RB's and SRB's (except RB2)

```

CRLC_SecurityMode_Config_REQ
  startValue = 0 (new key)
  integrityKey = new key
  cn_DomainIdentity = CS or PS
CRLC_Integrity_Activate_REQ
  IntegrityProtectionModeCommand = Start (FRESH)
  IntegrityProtectionAlgorithm = selected value (downlink integrity protection starts
  immediately)
CRLC_Integrity_Activate_REQ
  ul_IntegProtActivationInfo = value (now)

```

8.5.4.5.2.3 Pending security configuration (no new keys)

A pending security configuration is triggered by the previous SECURITY MODE COMMAND (no new keys).

1 Before sending one of the SRNS relocation related messages

```

CRLC_SecurityMode_Config_REQ
  startValue = OMIT (no COUNT-I re-initialization)
  integrityKey = OMIT or value maintained by TTCN (no key change) cn_DomainIdentity = CS
  or PS
CRLC_Integrity_Activate_REQ
  SS_IntegrityProtectionModeCommand = Start (FRESH)
  IntegrityProtectionAlgorithm = selected value (downlink integrity protection starts
  immediately)
CRLC_Integrity_Activate_REQ
  ul_IntegProtActivationInfo = value (now)

```

2 Send one of the SRNS relocation related messages

3 Re-establish RB2 and re-initialize COUNT-C for RB2

```

CRLC_SequenceNumber_REQ
CRLC_SequenceNumber_CNF
    HFN = MAX(HFN of DL/UL COUNT-C of RB2) + 1
CRLC_Config_REQ
    Release RB2
CRLC_Config_REQ
    Setup RB2
CRLC_SecurityMode_Config_REQ
    startValue = HFN calculated above
    cn_DomainIdentity = CS or PS
CRLC_Ciphering_Activate_REQ
    if CIPHERING_STATUS= NotStarted
        cipheringModeCommand = NULL (no ciphering)
    if CIPHERING_STATUS = Started
        cipheringModeCommand = Start/Restart (existing algorithm)
    rb_DL_CiphActivationTimeInfo = now (RB2 only)
    incHFN = NotInc
CRLC_Ciphering_Activate_REQ
    rb_UL_CipheringActivationTimeInfo = now (RB2 only)
    incHFN = NotInc

```

4 Receive the response message**5 Re-establish all RBs and SRBs (except RB2) and re-initialize COUNT-C for all RBs and SRBs (except RB2)**

```

CRLC_Config_REQ
    Release all RB's and SRB's (except RB2)
CRLC_Config_REQ
    Setup all RB's and SRB's (except RB2)
CRLC_SecurityMode_Config_REQ
    startValue = value received in the response message
    integrityKey = value maintained by TTCN
    cn_DomainIdentity = CS or PS
CRLC_Ciphering_Activate_REQ
    if CIPHERING_STATUS= NotStarted
        cipheringModeCommand = NULL (no ciphering)
    if CIPHERING_STATUS = Started
        cipheringModeCommand = Start/Restart (existing algorithm)
    rb_DL_CiphActivationTimeInfo = now (except RB2)
    incHFN = NotInc
CRLC_Ciphering_Activate_REQ
    rb_UL_CiphActivationTimeInfo = now (except RB2)
    incHFN = NotInc

```

6 Re-initialize COUNT-I for all RB's and SRB's (except RB2)

```

CRLC_SecurityMode_Config_REQ
    startValue = value received in the response message
    integrityKey = value maintained by TTCN
    cn_DomainIdentity = CS or PS
CRLC_Integrity_Activate_REQ
    IntegrityProtectionModeCommand = Start (FRESH)
    IntegrityProtectionAlgorithm = selected value (downlink integrity protection starts
    immediately)
CRLC_Integrity_Activate_REQ
    ul_IntegProtActivationInfo = value (now)

```

8.5.4.5.3 Presence of "Integrity protection mode info" and "Ciphering mode info" IE

CIPHERING_STATUS = Started for the CN domain concerned,
SRNS relocation related message with "Integrity protection mode info" IE containing
integrityProtectionModeCommand = Start, and "Ciphering mode info" IE containing cipheringModeCommand
= Start/Restart (change ciphering algorithm, no "Radio bearer downlink ciphering activation time
info")

8.5.4.5.3.1 No security configuration pending

1 Before sending one of the SRNS relocation related messages

```

CRLC_SecurityMode_Config_REQ
    startValue = OMIT (no COUNT-I re-initialization)
    integrityKey = OMIT or value maintained by TTCN (no key change)
    cn_DomainIdentity = CS or PS
CRLC_Integrity_Activate_REQ
    SS_IntegrityProtectionModeCommand = Start (FRESH)
    IntegrityProtectionAlgorithm = selected value (downlink integrity protection starts
    immediately)
CRLC_Integrity_Activate_REQ
    ul_IntegProtActivationInfo = value (now)

```

2 Send one of the SRNS relocation related messages**3 Re-establish RB2 and re-initialize COUNT-C for RB2**

```

CRLC_SequenceNumber_REQ
CRLC_SequenceNumber_CNF
    HFN = MAX(HFN of DL/UL COUNT-C of RB2) + 1
CRLC_Config_REQ
    Release RB2
CRLC_Config_REQ
    Setup RB2
CRLC_SecurityMode_Config_REQ
    startValue = HFN calculated above
    cn_DomainIdentity = CS or PS
CRLC_Ciphering_Activate_REQ
    if CIPHERING_STATUS= NotStarted
        cipheringModeCommand = NULL (no ciphering)
    if CIPHERING_STATUS = Started
        cipheringModeCommand = Start/Restart (existing algorithm)
    rb_DL_CiphActivationTimeInfo = now (RB2 only)
    incHFN = NotInc
CRLC_Ciphering_Activate_REQ
    rb_UL_CiphActivationTimeInfo = now (RB2 only)
    incHFN = NotInc

```

4 Receive the response message**5 Re-establish all RBs and SRBs (except RB2) and re-initialize COUNT-C for all RBs and SRBs (except RB2)**

```

CRLC_Config_REQ
    Release all RB's and SRB's (except RB2)
CRLC_Config_REQ
    Setup all RB's and SRB's (except RB2)
CRLC_SecurityMode_Config_REQ
    startValue = value received in the response message
    integrityKey = value maintained by TTCN
    cn_DomainIdentity = CS or PS
CRLC_Ciphering_Activate_REQ
    cipheringModeCommand = Start/Restart (new algorithm)
    rb_DL_CiphActivationTimeInfo = now (except RB2)
    incHFN = NotInc
CRLC_Ciphering_Activate_REQ
    rb_UL_CiphActivationTimeInfo = now (except RB2)
    incHFN = NotInc

```

8.5.4.5.3.2 Pending security configuration (new keys)

1 Before sending one of the SRNS relocation related messages

```

CRLC_SecurityMode_Config_REQ
    startValue = 0 (new key)
    integrityKey = new key
    cn_DomainIdentity = CS or PS
CRLC_Integrity_Activate_REQ
    SS_IntegrityProtectionModeCommand = Start (FRESH)
    IntegrityProtectionAlgorithm = selected value (downlink integrity protection starts
    immediately)
CRLC_Integrity_Activate_REQ
    ul_IntegProtActivationInfo = value (now)

```

2 Send one of the SRNS relocation related messages**3 Re-establish RB2 and re-initialize COUNT-C for RB2**

```

CRLC_SequenceNumber_REQ
  CRLC_SequenceNumber_CNF
  HFN = MAX(HFN of DL/UL COUNT-C of RB2) + 1
CRLC_Config_REQ
  Release RB2
CRLC_Config_REQ
  Setup RB2
CRLC_SecurityMode_Config_REQ
  startValue = HFN calculated above
  cn_DomainIdentity = CS or PS
CRLC_Ciphering_Activate_REQ
  cipheringModeCommand = NULL (no ciphering status change)
  rb_DL_CiphActivationTimeInfo = now (RB2 only)
  incHFN = NotInc
CRLC_Ciphering_Activate_REQ
  rb_UL_CipheringActivationTimeInfo = now (RB2 only)
  incHFN = NotInc

```

4 Receive the response message**5 Re-establish all RBs and SRBs (except RB2) and re-initialize COUNT-C for all RBs and SRBs (except RB2)**

```

CRLC_Config_REQ
  Release all RB's and SRB's (except RB2)
CRLC_Config_REQ
  Setup all RB's and SRB's (except RB2)
CRLC_SecurityMode_Config_REQ
  startValue = 0
  integrityKey = new key
  cn_DomainIdentity = CS or PS
CRLC_Ciphering_Activate_REQ
  cipheringModeCommand = Start/Restart (new algorithm)
  rb_DL_CiphActivationTimeInfo = now (except RB2)
  incHFN = NotInc
CRLC_Ciphering_Activate_REQ
  rb_UL_CiphActivationTimeInfo = now (except RB2)
  incHFN = NotInc

```

6 Re-initialize COUNT-I for all RBs and SRBs (except RB2)

```

CRLC_SecurityMode_Config_REQ
  startValue = 0 (new key)
  integrityKey = new key
  cn_DomainIdentity = CS or PS
CRLC_Integrity_Activate_REQ
  IntegrityProtectionModeCommand = Start (FRESH)
  IntegrityProtectionAlgorithm = selected value (downlink integrity protection starts
  immediately)
CRLC_Integrity_Activate_REQ
  ul_IntegProtActivationInfo = value (now)

```

8.5.4.5.3.3 Pending security configuration (no new key)**1 Before sending one of the SRNS relocation related messages**

```

CRLC_SecurityMode_Config_REQ
  startValue = OMIT (no COUNT-I re-initialization)
  integrityKey = OMIT or value maintained by TTCN (no key change)
  cn_DomainIdentity = CS or PS
CRLC_Integrity_Activate_REQ
  SS_IntegrityProtectionModeCommand = Start (FRESH)
  IntegrityProtectionAlgorithm = selected value (downlink integrity protection starts
  immediately)
CRLC_Integrity_Activate_REQ
  ul_IntegProtActivationInfo = value (now)

```

2 Send one of the SRNS relocation related messages

3 Re-establish RB2 and re-initialize COUNT-C for RB2

```

CRLC_SequenceNumber_REQ
    CRLC_SequenceNumber_CNF
        HFN = MAX(HFN of DL/UL COUNT-C of RB2) + 1
CRLC_Config_REQ
    Release RB2
CRLC_Config_REQ
    Setup RB2
CRLC_SecurityMode_Config_REQ
    startValue = HFN calculated above
    n_DomainIdentity = CS or PS
CRLC_Ciphering_Activate_REQ
    if CIPHERING_STATUS= NotStarted
        cipheringModeCommand = NULL (no ciphering)
    if CIPHERING_STATUS = Started
        cipheringModeCommand = Start/Restart (existing algorithm)
    rb_DL_CiphActivationTimeInfo = now (RB2 only)
    incHFN = NotInc
CRLC_Ciphering_Activate_REQ
    rb_UL_CipheringActivationTimeInfo = now (RB2 only)
    incHFN = NotInc

```

4 Receive the response message

5 Re-establish all RBs and SRBs (except RB2) and re-initialize COUNT-C for all RBs and SRBs (except RB2)

```

CRLC_Config_REQ
    Release all RB's and SRB's (except RB2)
CRLC_Config_REQ
    Setup all RB's and SRB's (except RB2)
CRLC_SecurityMode_Config_REQ
    startValue = value received in the response message
    integrityKey = value maintained by TTCN
    cn_DomainIdentity = CS or PS
CRLC_Ciphering_Activate_REQ
    cipheringModeCommand = Start/Restart (new algorithm)
    rb_DL_CiphActivationTimeInfo = now (except RB2)
CRLC_Ciphering_Activate_REQ
    rb_UL_CiphActivationTimeInfo = now (except RB2)

```

6 Re-initialize COUNT-I for all RBs and SRBs (except RB2)

```

CRLC_SecurityMode_Config_REQ
    startValue = value received in the response message
    integrityKey = value maintained by TTCN
    cn_DomainIdentity = CS or PS
CRLC_Integrity_Activate_REQ
    IntegrityProtectionModeCommand = Start (FRESH)
    IntegrityProtectionAlgorithm = selected value (downlink integrity protection starts
    immediately)
CRLC_Integrity_Activate_REQ
    ul_IntegProtActivationInfo = value (now)

```

8.5.4.6 CELL/URA update

8.5.4.6.1 RLC re-establish (RB2, RB3, RB4)

"RLC re-establish (RB2, RB3, RB4)" in CELL UPDATE CONFIRM message is set to TRUE CIPHERING_STATUS = Started for the CN domain concerned

1. After sending CELL UPDATE CONFIRM message, re-establish the RB2, RB3 and RB4 (if established)

```

CRLC_SecurityMode_Config_REQ
    startValue = value received from CELL UPDATE message
    cipheringKey = value maintained by TTCN
    cn_DomainIdentity = CS or PS
CRLC_Ciphering_Activate_REQ (CN domain concerned)
    cipheringModeCommand = Start/Restart (existing algorithm)
    rb_DL_CiphActivationTimeInfo = now (RB2, RB3, RB4)
    incHFN = NotInc
CRLC_Ciphering_Activate_REQ (CN domain concerned)
    rb_UL_CipheringActivationTimeInfo = now (RB2, RB3, RB4)
    incHFN = NotInc

```

8.5.4.6.2 RLC re-establish (RAB)

"RLC re-establish (RB5 and upwards)" in CELL UPDATE CONFIRM message is set to TRUE CIPHERING_STATUS = Started for the CN domain concerned

1. After sending CELL UPDATE CONFIRM message, re-establish the RAB

```

CRLC_SecurityMode_Config_REQ
    startValue = value received from CELL UPDATE message
    cipheringKey = value maintained by TTCN
    cn_DomainIdentity = CS or PS
CRLC_Ciphering_Activate_REQ (CN domain concerned)
    cipheringModeCommand = Start/Restart (existing algorithm)
    rb_DL_CiphActivationTimeInfo = now (RB5 and upwards)
    incHFN = NotInc
CRLC_Ciphering_Activate_REQ (CN domain concerned)
    rb_UL_CipheringActivationTimeInfo = now (RB5 and upwards)
    incHFN = NotInc

```

8.5.4.7 Inter RAT handover to UTRAN

8.5.4.7.1 ciphering has not been activated

ciphering has not been started in the radio access technology from which inter RAT handover is performed. TM mode radio bearer will be established in the UTRAN.

1. Sending HANDOVER TO UTRAN COMMAND in a RAT different from UTRAN

2. After receiving HANDOVER TO UTRAN COMPLETE message

```

CMAC_SecurityMode_Config_REQ
    startValue = value received in HANDOVER TO UTRAN COMPLETE message
    cn_DomainIdentity = CS or PS
CMAC_Ciphering_Activate_REQ (CN domain concerned)
    incHFN = NotInc
    cipheringModeCommand = NULL
    activationTimeForDPCH = now
CRLC_SecurityMode_Config_REQ
    startValue = value received in HANDOVER TO UTRAN COMPLETE
    cn_DomainIdentity = CS or PS
CRLC_Ciphering_Activate_REQ (CN domain concerned)
    cipheringModeCommand = NULL
    rb_DL_CiphActivationTimeInfo = now (RB1, RB2, RB3, RB4)
    incHFN = Inc
    CRLC_Ciphering_Activate_REQ (CN domain concerned)
    rb_UL_CipheringActivationTimeInfo = now (RB1, RB2, RB3, RB4)
    incHFN = Inc

```

8.5.4.7.2 ciphering has been activated

ciphering has been started in the radio access technology from which inter RAT handover is performed. TM mode radio bearer will be established in the UTRAN.

1. Before sending HANDOVER TO UTRAN COMMAND

```

CRLC_SecurityMode_Config_REQ
  startValue = "START" value included in the IE "UE security information" in the variable
"INTER_RAT_HANDOVER_INFO_TRANSFERRED"
  cipheringKey = value generated in authentication procedure in GRAN
  cn_DomainIdentity = CS or PS
CRLC_Ciphering_Activate_REQ (CN domain concerned)
  cipheringModeCommand = Start/Restart (algorithm in HANDOVER TO UTRAN COMMAND)
  rb_DL_CiphActivationTimeInfo = now (RB1, RB2, RB3, RB4)
  incHFN = NotInc
CRLC_Ciphering_Activate_REQ (CN domain concerned)
  rb_UL_CipheringActivationTimeInfo = now (RB1, RB2, RB3, RB4)
  incHFN = NotInc
CMAC_SecurityMode_Config_REQ
  startValue = "START" value included in the IE "UE security information" in the variable
"INTER_RAT_HANDOVER_INFO_TRANSFERRED"
  cipheringKey = value generated in authentication procedure in GRAN
  cn_DomainIdentity = CS or PS
CMAC_Ciphering_Activate_REQ (CN domain concerned)
  incHFN = NotInc
  cipheringModeCommand = Start/Restart (algorithm in HANDOVER TO UTRAN COMMAND)
  activationTimeForDPCH = now

```

2. Sending HANDOVER TO UTRAN COMMAND in a RAT different from UTRAN

3. After receiving HANDOVER TO UTRAN COMPLETE message

```

CMAC_SecurityMode_Config_REQ
  startValue = value received in the response message
  cipheringKey = value maintained by TTCN
  cn_DomainIdentity = CS or PS
CMAC_Ciphering_Activate_REQ (CN domain concerned)
  cipheringModeCommand = Start/Restart (algorithm) in HANDOVER TO UTRAN COMMAND)
  activationTimeForDPCH = value in "COUNT-C activation time"
  incHFN = IncByOne_IncPerCFN_Cycle
CRLC_SecurityMode_Config_REQ
  startValue = value received in HANDOVER TO UTRAN COMPLETE
  cipheringKey = value generated in authentication procedure in GRAN
  cn_DomainIdentity = CS or PS
CRLC_Ciphering_Activate_REQ (CN domain concerned)
  cipheringModeCommand = Start/Restart (algorithm in HANDOVER TO UTRAN COMMAND)
  rb_DL_CiphActivationTimeInfo = now (RB1, RB2, RB3, RB4)
  incHFN = Inc
CRLC_Ciphering_Activate_REQ (CN domain concerned)
  rb_UL_CipheringActivationTimeInfo = now (RB1, RB2, RB3, RB4)
  incHFN = Inc

```

8.5.4.8 Hard handover

Ciphering is activated for any TM radio bearer;
 "Downlink DPCH info for all RL" in a message performing timing re-initialized hard handover or;
 "Downlink DPCH info for all RL" in a message other than RADIO BEARER SETUP transferring UE to Cell_DCH from non-Cell_DCH state.

1. Before sending the message

```

CMAC_SecurityMode_Config_REQ
  startValue = value most recently received
  cipheringKey = value maintained by TTCN
  cn_DomainIdentity = CS or PS
CMAC_Ciphering_Activate_REQ (CN domain concerned)
  incHFN = NotInc
  cipheringModeCommand = Start/Restart (existing algorithm)
  activationTimeForDPCH = now

```

2. Send the message for hard HO

3. After receiving the response message

```

CMAC_SecurityMode_Config_REQ
  startValue = value received in the response message
  cipheringKey = value maintained by TTCN
  cn_DomainIdentity = CS or PS
CMAC_Ciphering_Activate_REQ (CN domain concerned)
  cipheringModeCommand = Start/Restart (existing algorithm)
  activationTimeForDPCH = value in "COUNT-C activation time"
  incHFN = IncByOne_IncPerCFN_Cycle

```

8.5.5 Test USIM configurations

The default test USIM is defined in 3GPP TS 34.108 [3]. This clause specifies a number of specific test USIM configurations which are used for the concerned test cases.

8.5.5.1 Test USIM for Idle mode tests

The PLMN 1-12 identities used below have been defined in 3GPP TS 34.123-1 [1], table 6.2. Clause numbers refer to 3GPP TS 34.123-1 [1].

Test USIM is configured as bellow for PLMN selection of RPLMN, HPLMN, UPLMN and OPLMN in tc_6_1_1_1, tc_6_1_1_4, and tc_6_1_1_14.

Table 8.5.5.1.1

USIM field	Priority	PLMN	Access Technology Identifier
EF _{PLMNwAcT}	1 st	PLMN 3	UTRAN
	2 nd	PLMN 4	UTRAN
EF _{OPLMNwAcT}	1 st	PLMN 5	UTRAN
	2 nd	PLMN 6	UTRAN
EF _{FPLMN}	PLMN 3		

Test USIM is configured as bellow for PLMN selection of other PLMN with access technology combinations in tc_6_1_1_2.

Table 8.5.5.1.2

USIM field	Priority	PLMN	Access Technology Identifier
EF _{FPLMN}	PLMN 10		

Test USIM is configured as bellow for manual PLMN selection independent of RF level and preferred PLMN in TC_6_1_1_3.

Table 8.5.5.1.3

USIM field	Priority	PLMN	Access Technology Identifier
EF _{PLMNwAcT}	1 st	PLMN 3	UTRAN

The test USIM is configured as bellow in tc_6_1_1_8.

Table 8.5.5.1.4

USIM field	Priority	PLMN
EF _{PLMNwAcT}	1 st	PLMN 7
EF _{OPLMNwAcT}	1 st	PLMN 5
	2 nd	PLMN 6
EF _{FPLMN}	PLMN 7	

Test USIM is configured as bellow for manual PLMN selection in tc_6_1_1_9.

Table 8.5.5.1.5

USIM field	Priority	PLMN
EF _{PLMNwAcT}	1 st	PLMN 3
EF _{OPLMNwAcT}	1 st	PLMN 4
	2 nd	PLMN 5
EF _{FPLMN}	PLMN 5	

Test USIM is configured as bellow for manual PLMN selection in tc_6_1_1_10.

Table 8.5.5.1.6

USIM field	Priority	PLMN
EF _{PLMNwAcT}	1 st	PLMN 2
EF _{OPLMNwAcT}	1 st	PLMN 5
EF _{FPLMN}	1 st	PLMN 4

The test USIM is configured as bellow in tc_6_1_1_11.

Table 8.5.5.1.7

USIM field	Priority	PLMN
EF _{OPLMNwAcT}	1 st	PLMN 2
	2 nd	PLMN 3
	3 rd	PLMN 4
EF _{FPLMN}	PLMN 2	

Test USIMs are configured as bellow for manual PLMN selection in tc_6_1_1_12. Three test USIMs are needed for the test.

Table 8.5.5.1.8: USIM A

USIM field	Priority	PLMN
EF _{EHPLMN}	1 st	PLMN 4
	2 nd	PLMN 2
	3 rd	PLMN 1
EF _{UST}	Service n°71 Equivalent HPLMN and Service n°73 Equivalent HPLMN Presentation Indication available	
EF _{EHPLMNPI}	'02' - Display all the available EHPLMNs	

Table 8.5.5.1.9: USIM B

USIM field	Priority	PLMN
EF _{EHPLMN}	1 st	PLMN 2
	2 nd	PLMN 3
	3 rd	PLMN 1
EF _{UST}	Service n°71 Equivalent HPLMN and Service n°73 Equivalent HPLMN Presentation Indication available	
EF _{EHPLMNPI}	'01' - Display the highest-priority available EHPLMN only	

Table 8.5.5.1.10: USIM C

USIM field	Priority	PLMN
EF _{EHPLMN}	1 st	PLMN 3
	2 nd	PLMN 4
	3 rd	PLMN 1
EF _{UST}	Service n°71 Equivalent HPLMN available	
EF _{EHPLMNPI}	Not present	

Test USIMs are configured as bellow for manual PLMN selection in tc_6_1_1_13. Two test USIMs are needed for the test.

Table 8.5.5.1.11: USIM A

USIM field	LRPLMNSI
EF _{LRPLMNSI}	01

Table 8.5.5.1.12: USIM B

USIM field	LRPLMNSI
EF _{LRPLMNSI}	00

Table 8.5.5.1.13: Parameters common for USIM A & USIM B

USIM field	Priority	PLMN
EF _{EHPLMN}	1 st	PLMN 5
EF _{EHPLMN}	2 nd	PLMN 4

The test USIM is configured as bellow in tc_6_1_1_15. Two test USIMs are needed for the test.

Table 8.5.5.1.14: USIM A

USIM field	Priority	PLMN
EF _{EHPLMN}	1 st	PLMN 5
EF _{EHPLMN}	2 nd	PLMN 4

Test USIM is configured as below for emergency calls in tc_6_1_2_6.

Table 8.5.5.1.15

USIM field	Priority	PLMN
EF _{FPLMN}	PLMN 3	

The test USIM is configured in tc_6_1_2_9a with "Type A" EF_{ACC}.

The test USIM is configured in tc_6_1_2_9b with "Type B" EF_{ACC}.

Test USIMs are configured as bellow for Selection of the correct PLMN and associated RAT in tc_6_2_1_1. Two test USIMs are needed for the test.

Table 8.5.5.1.16: USIM A

USIM field	Priority	PLMN	Access Technology Identifier
EF _{HPLMNwAcT}	1 st	PLMN1	GSM
EF _{HPLMNwAcT}	2 nd	PLMN1	UTRAN

Table 8.5.5.1.17: USIM B

USIM field	Priority	PLMN	Access Technology Identifier
EF _{HPLMNwAcT}	1 st	PLMN2	UTRAN
	2 nd	PLMN2	GSM

Test USIMs are configured as bellow for Selection of RAT for HPLMN in tc_6_2_1_2. Two test USIMs are needed for the test.

Table 8.5.5.1.18: USIM A

USIM field	Priority	PLMN	Access Technology Identifier
EF _{LOCI}		PLMN 1	
EF _{HPLMNwAcT}	1 st	PLMN2	UTRAN
	2 nd	PLMN2	GSM

Table 8.5.5.1.19: USIM B

USIM field	Priority	PLMN	Access Technology Identifier
EF _{LOCI}		PLMN 1	
EF _{HPLMNwAcT}	1 st	PLMN2	UTRAN
	2 nd	PLMN2	

Test USIMs are configured as bellow for Selection of RAT for HPLMN in tc_6_2_1_6. Two test USIMs are needed for the test.

Table 8.5.5.1.20: USIM A

USIM field	Priority	PLMN	Access Technology Identifier
EF _{HPLMNwAcT}	1 st	PLMN2	UTRAN
	2 nd	PLMN2	GSM
EF _{PLMNwAcT}	1 st	PLMN3	UTRAN

Table 8.5.5.1.21: USIM B

USIM field	Priority	PLMN	Access Technology Identifier
EF _{HPLMNwAcT}	1 st	PLMN2	UTRAN
	2 nd	PLMN2	
EF _{PLMNwAcT}	1 st	PLMN3	UTRAN

Test USIM for Selection of RAT for UPLMN or OPLMN in tc_6_2_1_3, tc_6_2_1_4, tc_6_2_1_7, tc_6_2_1_8 and for Selection of Other PLMN with access technology combinations"; Automatic mode in tc_6_2_1_9.

Table 8.5.5.1.22

USIM field	Priority	PLMN	Access Technology Identifier
EF _{HPLMNwAcT}	1 st	PLMN2	UTRAN
	2 nd	PLMN2	GSM
EF _{PLMNwAcT}	1 st	PLMN 3	UTRAN
	2 nd	PLMN 4	GSM
EF _{OPLMNwAcT}	1 st	PLMN 5	UTRAN
	2 nd	PLMN 6	GSM

Test USIM are configured as bellow for manual selection of other PLMN with access technology combinations in tc_6_2_1_5.

Table 8.5.5.1.23

USIM field	Priority	PLMN	Access Technology Identifier
EF _{LocI}		PLMN 7	
EF _{FPLMN}		PLMN 8	
		PLMN 9	

Test USIM for cell reselection if cell becomes barred or for cell reselection timings requires that the USIM does not contain any preferred RAT. This specific test USIM applies to tc_6_2_2_1, tc_6_2_2_2 and tc_6_2_2_3.

8.6 Downlink power setting in SS

Refer to 3GPP TS 34.108 [3], clause 6.1.5.

8.7 Test suite operation definitions

8.7.1 Test suite operation definitions in the common modules

Table 8.7.1.1: TSO definitions in the common modules

TSO Name	Description
o_AuthRspChk	<p>Type of the result: BOOLEAN</p> <p>Parameters: p_AuthRsp : AuthRsp p_AuthRspExt : AuthRspExt p_K : BITSTRING p_RAND : BITSTRING p_Ext : BOOLEAN</p> <p>Description Checks the input parameter p_AuthRsp and p_AuthRspExt, both received in an Authentication Response, according to the authentication algorithm defined in the following procedure. The extension, p_AuthRspExt, is optional. Its presence is indicated by p_Ext. Returns TRUE if the Authentication Response contained in parameters p_AuthRsp and eventually p_AuthRspExt is correct, FALSE otherwise. The value of tcv_Auth_n indicates whether the AuthRspExt has been provided by the UE or not (n=31, or 31 < n < 128). See 3GPP TS 34.108 [3], clause 8.1.2. If not the parameter p_AuthRspExt is not to be used.</p> <p>Algorithm (without the knowledge of tcv_Auth_n): ===== if NOT p_Ext EvaluateAuthRsp else EvaluateAuthRspAndAuthRspExt EvaluateAuthRsp: ===== resultbitstring = o_BitstringXOR(XRES, AuthRsp) if resultbitstring is all 0s then there is a match. EvaluateAuthRspAndAuthRspExt: ===== XRESHigh = o_BitstringXtract(XRES, 32, 32, 0) /* XRES divides into 2 parts: the higher part of 32 bits related to AuthRsp and the lower part related to AuthRspExt */ /* SourceLength of 32 is only to ensure usage of the procedure */ resultbitstring = o_BitstringXOR(XRESHigh, AuthRsp) if resultbitstring is all 0s then there is a match for the first 32 bits: EvaluateAuthRspExt else Authentication failed. EvaluateAuthRspExt:</p>

TSO Name	Description
	<pre> ===== /* As AuthRespExt may not be octet aligned the last octet indicated in AuthRespExt is not used for checking */ if (AuthRespExt.iel = 1) then Authentication passed /* there was only 1 possibly incomplete octet which is not used */ else { AuthRspExthigh = o_BitstringXtract(AuthRespExt.authRsp, ((AuthRespExt.iel -1)* 8), (AuthRespExt.iel -1)* 8, 0) /* extract (AuthRespExt.iel -1)* 8 bits starting from bit 0 */ XRESlow = o_BitstringXtract(XRES, ((AuthRespExt.iel -1)* 8 + 32), (AuthRespExt.iel -1)* 8, 32) /* extract (AuthRespExt.iel -1)* 8 bits starting from bit 32 */ resultbitstring = o_BitstringXOR(XRESlow, AuthRspExthigh, (AuthRespExt.iel -1)* 8) if resultbitstring is all 0s then there is a match for the bits following the first 32 bits else Authentication failed </pre>
o_BitstringChange	<p>Type of the result: BITSTRING</p> <p>Parameters: P_Str: BITSTRING p_Len: INTEGER p_Offset: INTEGER</p> <p>Description Performs the manipulation of a bitstring by toggling the bit identified by p_Offset. The length of the string to be manipulated is specified in p_Len. This is only provided to help ensure that the p_Offset is less than p_Len. Returns a resulting bitstring of length p_Len. EXAMPLE 1: o_BitstringChange('010101'B, 6, 5) produces '010100'B. EXAMPLE 2: o_BitstringChange('010101'B, 6, 0) produces '110101'B.</p>
o_BitstringConcat	<p>Type of the result: BITSTRING</p> <p>Parameters: P_Str1: BITSTRING p_Str2: BITSTRING p_Len1: INTEGER p_Len2: INTEGER</p> <p>Description Performs the concatenation of 2 bitstrings of possibly different lengths. The bit significance is from left to right, i.e. the MSB is at the left-hand side. Returns a resulting bitstring p_Str1 p_Str2 of length p_Len1 + p_Len2. EXAMPLE: o_BitstringConcat('010101'B,'11'B) produces '01010111'B of length 6 + 2 = 8.</p>
o_BitstringXOR	<p>Type of the result: BITSTRING</p> <p>Parameters: p_Str1: BITSTRING p_Str2: BITSTRING p_Len: INTEGER</p> <p>Description Performs an XOR operation using 2 bitstrings of the same length (p_Len). Returns a resulting Bitstring of length p_Len. EXAMPLE: o_BitstringXOR('0011'B, '0101'B, 4) produces '0110'B.</p>

TSO Name	Description
o_BitstringXtract	<p>Type of the result: BITSTRING</p> <p>Parameters: P_Str: BITSTRING p_SrcLen: INTEGER p_TargetLen: INTEGER p_Offset: INTEGER</p> <p>Description Performs the wrap around extract of a bitstring. The length of the string from which extraction is to be made is specified in p_SrcLen. The length of the bitstring to be extracted is indicated as p_TargetLen, the offset in the original string is indicated in p_Offset. The bit position 0 is at the left side. Returns a resulting bitstring of length p_TargetLen.</p> <p>EXAMPLE 1: o_BitstringXtract('101010'B, 6, 2, 1) produces '01'B. EXAMPLE 2: o_BitstringXtract('101010'B, 6, 4, 3) produces '0101'B, wrapping around. EXAMPLE 3: o_BitstringXtract('111000'B, 6, 4, 3) produces '0111'B, wrapping around.</p>
o_BoolToBit	<p>Type of the result: B1</p> <p>Parameters: p_Boolean : BOOLEAN</p> <p>Description This TSO is used to convert the given BOOLEAN into a single bit. A boolean value of TRUE will give a result '1' and a boolean value of FALSE will give a result '0'.</p>

TSO Name	Description
o_BMC_DrxScheduling	<p>Type of the result: BMC_ResultOfSchedulingLevel2</p> <p>Parameters: p_BMC_CBS_Message1 : BMCCBSMESSAGE p_BMC_CBS_Message2 : BMCCBSMESSAGE p_BMC_CB_RepPeriod : INTEGER p_BMC_NoOfBroadcast_Req : INTEGER p_Offset : BMC_DRX_Offset</p> <p>Description This TSO shall calculate all BMC CBS schedule Messages for the CBS messages as described in 3GPP TS 34.123-1, clause 7.4.3.1. The TSO has to precalculate the CTCH Block SETs needed, i.e. it shall have all necessary knowledge (RLC segmentation, MAC handling, if needed) to predict the CTCH with BMC contents for the given input to be sent.</p> <p>The TSO shall consider the BMC CBS Scheduling Level2 as described in 3GPP TS 25.324 [20], 3GPP TR 25.925 [44] and the description of BMC test architecture and test method in the present document, clause 6.8.</p> <p>The TSO calculates the BMC CBS Schedule messages to predict its next BlockSet to be sent. In addition, a DRX scheduling Bitmap is created for each CTCH allocated TTI aligned to the pre-calculated offset in between 2 CTCH Block Sets.</p> <p>The principle of DRX shall be followed by this TSO. I.e. BMC Messages shall be sent blockwise (CTCH Block Set) with predicted offset in between 2 Block Sets.</p> <p>The TSO shall consider the following aspects to calculate the DRX Selection Bitmap and to create the BMC CBS Schedule messages:</p> <ol style="list-style-type: none"> 1. The first CTCH Block Set consists of the first BMC CBS Schedule message predicting the offset, length and content of the following Block Set where the BMC CBS Message1 shall be send as new message. 2. The BMC CBS Message1 shall be repeated for p_BMC_CB_RepPeriod multiplied by p_BMC_NoOfBroadcast_Req times before the BMC CBS Message2 is broadcasted. 3. The BMC CBS Schedule Messages shall be the last message of a CTCH Block Set, i.e. on the end of a Block Set. 4. If no further repetition of BMC CBS Messages is needed, no further BMC CBS Schedule message shall be created. <p>output parameter: DrxSelectionBitmap: The TSO creates a Bitmap as Octetstring for scheduled CTCH allocated TTI as described in 3GPP TS 34.123-3: clause 6.8.2 BMC test method and architecture.</p> <p>CBS_Schedule_Message01, CBS_Schedule_Message02, CBS_Schedule_Message03: Considering the given BMC PDUs BMC_DRX_Offset and BMCCBSMESSAGE to be sent, the BMC Schedule messages have to be created according the given parameter.</p>
o_CheckStringStartWith	<p>Type of the result: BOOLEAN</p> <p>Parameters: p_SourceString: IA5String p_StartString : IA5String</p> <p>Description o_CheckStringStartWith returns TRUE if the p_sourceString start with the p_StartString. Otherwise it returns FALSE.</p> <p>EXAMPLE: o_CheckStringStartWith ("CLCC:1,0,0,2,0;", "CLCC:1,0,0")=TRUE */.</p>

TSO Name	Description
o_ComputeSM_ContentsSpec	<p>Type of the result: OCTETSTRING</p> <p>Parameters: p_NumOfChars: INTEGER p_Text: IA5String</p> <p>Description This operation provides a short message's contents with a specified number of characters 'p_NumOfChars', each represented by 7 bits. 'p_Text' is used as contents of the short message. If 'p_Text' contains less than 'p_NumOfChars' characters, 'p_Text' is repeated until the short message reaches the 'p_NumOfChars' characters long. The bits are arranged acc. to 3GPP TS 23.038 [34], clause 6.1.2.1.1.</p> <p>max. 160 characters, i.e. 140 octets.</p>
o_ConcatStrg	<p>Type of the result: IA5String</p> <p>Parameters: P_String1: IA5String p_String2: IA5String</p> <p>Description o_ConcatString concatenates 'p_String1' and 'p_String2' and returns the resulting string.</p> <p>EXAMPLE: o_ConcatString ("AT+CBST=0", ";0") = "AT+CBST=0,0"</p>
o_ConvertIMSI	<p>Type of the result: IMSI_GSM_MAP</p> <p>Parameters: P_Imsi : HEXSTRING</p> <p>The input parameter 'p_Imsi' is a BCD string (subset of HEXSTRING), the result is of type IMSI_GSM_MAP.</p>
o_ConvertTMSI	<p>Type of the result: TMSI_GSM_MAP</p> <p>Parameters: p_Tmsi : OCTETSTRING</p> <p>Description The input parameter 'p_Tmsi' is an OCTETSTRING; the result is of type TMSI_GSM_MAP.</p>
o_ConvertPTMSI	<p>Type of the result: P_TMSI_GSM_MAP</p> <p>Parameters: p_PTMSI : OCTETSTRING</p> <p>Description The input parameter 'PTMSI' is a OCTETSTRING, the result is of type P_TMSI_GSM_MAP.</p>
o_ConvtPLMN	<p>Type of the result: TMSI_GSM_MAP</p> <p>Parameters: OCTETSTRING p_MCC, p_MNC : HEXSTRING</p> <p>Description the functions of o_ConvtPLMN are as following:</p> <ol style="list-style-type: none"> 1. The least significant HEX of p_MNC is removed from p_MNC and inserted into p_MCC in the position left to the third HEX to form a new p_MCC of 4 HEXs, then swap the first HEX (left most, most significant Hex) with the second HEX of the new p_MCC. 2. Swap the first Hex with the second HEX of the remaining part of p_MNC and append it to the new p_MCC formed in Step1 above. <p>EXAMPLE 1: o_ConvtPLMN('123'H, '456'H) = '216354'O. EXAMPLE 2: o_ConvtPLMN ('234'H, '01F'H) = '32F410'O.</p>

TSO Name	Description
o_FirstDigit	<p>Type of the result: B4</p> <p>Parameters: p_BCDdigits : HEXSTRING</p> <p>Description The input parameter p_BCDdigits shall be a BCD string (subset of HEXSTRING), the result is a BITSTRING[4] of a binary representation of one BCD digit. The function of the o_FirstDigit is to return the first (most significant) digit of the input parameter 'p_BCDdigits'.</p> <p>EXAMPLE 1: o_FirstDigit('12345') = '0001'B. EXAMPLE 2: o_FirstDigit('012345678') = '0000'B.</p>
o_GetBit	<p>Type of the result: BITSTRING</p> <p>Parameters: p_Source: BITSTRING p_DataLength: INTEGER</p> <p>Description o_GetBit returns the BITSTRING of length p_DataLength extracted from p_Source. The extraction shall start in the bit position 0 (at the left).</p>
o_GetLeastSignificantBits	<p>Type of the result: BITSTRING</p> <p>Parameters: bstring : BITSTRING lg : INTEGER</p> <p>Description o_GetLeastSignificantBits operation returns the `lg` least significant bits of the original `bstring`.</p> <p>for example:</p> <p>o_GetLeastSignificantBits('110011000101010'B, 3) = '010'B, o_GetLeastSignificantBits('110011000101010'B, 6) = '101010'B.</p>
o_GetMostSignificantBits	<p>Type of the result: BITSTRING</p> <p>Parameters: bstring : BITSTRING lg :INTEGER</p> <p>Description o_GetMostSignificantBits operation returns the `lg` most significant bits of the original `bstring`.</p> <p>for example:</p> <p>o_GetMostSignificantBits('110011000101010'B, 3) = '110'B, o_GetMostSignificantBits('110011000101010'B, 6) = '110011'B.</p>
o_GetMostSignificantBits_WrapAround	<p>Type of the result: BITSTRING</p> <p>Parameters: bstring : BITSTRING lg :INTEGER</p> <p>Description o_GetMostSignificantBits operation returns the `lg` most significant bits of the original `bstring`.</p> <p>for example:</p> <p>o_GetMostSignificantBits('110011000101010'B, 3) = '110'B, o_GetMostSignificantBits('110011000101010'B, 6) = '110011'B. If lg is greater than the length of bstring, then a bitsring of size greater than lg is created by concatenating bstring to itself (any number of times till it is size is greater than lg), and then 'lg' most significant bits of concatenated bstring are returned. example o_GetMostSignificantBits('1100'B, 9) = '110011001'B.</p>

TSO Name	Description
o_GetN_OctetsFromPRBS	<p>Type of the result: OCTETSTRING</p> <p>Parameters: p_Start, p_N: INTEGER</p> <p>Description This operation returns N octets from a repeated pseudo random bit sequence, starting with octet position p_Start. The PRBS is the 2047 bit pseudo random test pattern defined in ITU-T Recommendation O.153 [45] for measurements at 64 kbit/s and N x 64 kbit/s o_GetN_OctetsFromPRBS(p_Start, p_N) generates an OCTETSTRING containing p_N octets starting from octet number p_Start in the PRBS.</p> <p>Requirements p_Start ≥ 0 p_N ≥ 1</p> <p>Definition Define the 2 047 bit PRBS sequence b(i) as an m-sequence produced by using the following primitive (over GF(2)) generator polynomial of degree 11: $X^{11} + X^9 + 1$ This sequence is defined recursively as: $b(i) = 1$, i = 0,1,...,10 $b(i) = b(i - 2) + b(i - 11)$ modulo 2, i = 11,16,...,2046 The OCTETSTRING, o(j) generated by the present TSO is produced by extracting p_N octets from the repeated sequence b(i) as follows: $o(j,k) = b((n_Start + j) * 8 + k)$ modulo 2047) where: j = 0,1,...,p_N - 1 k = 0,1,..7 o(j,k) is the kth bit of the jth octet in o(j), o(j,0) is the MSB of the jth octet in o(j), o(j,7) is the LSB of the jth octet in o(j),</p> <p>Example results: o_GetN_OctetsFromPRBS(0, 25) and o_GetN_OctetsFromPRBS(2047, 25) both return: 'FFE665A5C5CA3452085408ABEECE4B0B813FD337873F2CD1E2'O o_GetN_OctetsFromPRBS(255, 25) and o_GetN_OctetsFromPRBS(255 + 2047, 25) both return '01FFCCCB4B8B9468A410A81157DD9C9617027FA66F0E7E59A3'O</p>
o_GetPI	<p>Type of the result: BITSTRING</p> <p>Parameters: p_Imsi : HEXSTRING p_Np: INTEGER</p> <p>Description PI = drx_index mod np</p> <p>The drx_index is calculated as described hereafter: $drx_index = (p_Imsi / 8192)$ This calculation is defined in TS 25.304 clause 8.3.</p> <p>NOTE: the IMSI is passed as HEXSTRING, the relevant conversion shall be done.</p>
o_GetSC_TimeStamp	<p>Type of the result: TP_ServCentreTimeSt</p> <p>Parameters: p_timezone : TZONES</p> <p>This operation provides the hexstring containing the Service Centre Time Stamp (SCTS) according to 3GPP TS 23.040 [35], clauses 9.2.2.1 and 9.2.3.11. The TSO reads the current time of the test systems clock and transforms the time in combination with the input parameter 'timezone' into a service centre time stamp.</p> <p>Example: 2002 April 18, 15:32:46, timezone=4 o_GetSC_TimeStamp returns 20408151236440</p> <p>TPSCTS is HEXSTRING[14]</p>

TSO Name	Description
o_HexToDigitsMCC	<p>Type of the result: MCC</p> <p>Parameters: p_BCDdigits : HEXSTRING</p> <p>Description The input parameter p_BCDdigits shall be a BCD string (subset of HEXSTRING), the result is a SEQUENCE (SIZE(3)) OF digit (MCC).</p> <p>NOTE: The length of p_BCDdigits shall be 3. User shall take the responsibility of fulfilling this requirement.</p> <p>EXAMPLE 1: o_HexToDigitsMCC('111'H) = {1, 1, 1}. EXAMPLE 2: o_HexToDigitsMCC('123'H) = {1, 2, 3}.</p>
o_HexToDigitsMNC	<p>Type of the result: MNC</p> <p>Parameters: p_BCDdigits : HEXSTRING</p> <p>Description The function of this operation is:</p> <ol style="list-style-type: none"> 1. The least significant HEX is removed if it is 'F' and the operation returns SEQUENCE (SIZE(2)) OF Digit. 2. The operation returns SEQUENCE (SIZE(3)) OF Digit if all 3 HEX digits in p_BCDdigits are BCD Digit. <p>EXAMPLE 1: o_HexToDigitsMNC('123'H) = {1, 2, 3}. EXAMPLE 2: o_HexToDigitsMNC('13F'H) = {1, 3}.</p>
o_HexToIA5	<p>Type of the result: IA5String</p> <p>Parameters: p_String: HEXSTRING</p> <p>Description o_HEX_TO_IA5 converts hexadecimal string 'p_String' to an IA5 String</p> <p>EXAMPLE: o_HEX_TO_IA5 ('15A'H) = "15A".</p>
o_IA5_ToOct	<p>Type of the result: OCTETSTRING</p> <p>Parameters: p_String : IA5String</p> <p>Description o_IA5_ToOct converts the string p_String from IA5String type to OCTETSTRING. Each character is mapped onto an octet, and bit 8 is set to 0. This TSO shall be used to convert Access Point Numbers for example. See 3GPP TS 24008, clause 10.5.6.1</p> <p>EXAMPLE: o_IA5_ToOct ("15A") = '313541'O.</p>
o_IA5_BMC_ToOct	<p>Type of the result: OCTETSTRING</p> <p>Parameters: p_String :IA5String_BMC p_DCS: TP_DataCodingScheme</p> <p>Description o_IA5_BMC_ToOct converts the string p_String from IA5String_BMC type to OCTETSTRING. p_DCS determines how this is done (refer to 3GPP TS 23.038 [34] clause 5). If a 7 bit packing is to be applied then proceed as described in 3GPP TS 23.038 [34] clause 6.1.2.2.1 and clause 6.2.1. This is the default case. If 8bit data is to be used then proceed as described in 3GPP TS 23.038 [34] clause 6.2.2. If UCS2is to be used then proceed as described in 3GPP TS 23.038 [34] clause 6.2.3. The type IA5_BMC implies that the length of p_String is restricted to 1..1395 octets. (Refer to 3GPP TS 23.041 [36], 3GPP TS 23.038 [34], 3GPP TS 25.324 [20]) This TSO will always generate a BMC encoded message of 15 page of information. If the input message stream (p_String) is less than the size of required octet, then the input message will be concatenated to generate a string of required length based on p_DCS.</p>

TSO Name	Description
o_IA5_IP_ToOct	<p>Type of the result: OCTETSTRING</p> <p>Parameters: p_String: IA5String p_IP_V4: BOOLEAN</p> <p>Description o_IA5_IP_ToOct converts the string p_String from IA5String type to OCTETSTRING. In case of IPv4, p_String represents an IP address consisting of a number of fields of digits, separated by dots. Each one of the numbers of which the IP address consists is converted into one octet. The dots separating the numbers are ignored. EXAMPLE 1: o_IA5_IP_ToOct ("200.1.1.80", TRUE) = 'C8010150'O. EXAMPLE 2: o_IA5_IP_ToOct ("200.1.1.80.100", TRUE) should result in an appropriate error message. EXAMPLE 3: o_IA5_IP_ToOct ("300.1.1.80", TRUE) should result in an appropriate error message.</p> <p>In case of IPv6, p_String represents an IP address consisting of a number of fields of hexadecimal digits, separated by ":". a) In case of uncompressed IPv6 format each value separated by ";" is converted to 2 octets. The ":" separating the numbers are ignored. EXAMPLE 1: o_IA5_IP_ToOct(FEDC:BA98:7654:3210:FEDC:BA98:7654:3210, FALSE) = 'FEDCBA9876543210FEDCBA9876543210'O EXAMPLE 2: o_IA5_IP_ToOct(FEDC:BA98:7654:3210:FEDC:BA98:7654, FALSE) should result in an appropriate error message. EXAMPLE 3: o_IA5_IP_ToOct(1080:0:0:0:8:800:200C:417A,FALSE) = '10800000000000000000000800200C417A'O EXAMPLE 4: o_IA5_IP_ToOct(1080:0:0:0:8:800:20H:417A,FALSE) should result in an appropriate error message. b) In case of compressed IPv6 format the use of "::" indicates multiple groups of 16-bits of zeros. The "::" can only appear once in an address. EXAMPLE 1: o_IA5_IP_ToOct(FF01::101,FALSE) = 'FF010000000000000000000000000000101'O EXAMPLE 2: o_IA5_IP_ToOct(FEDC::7654:3210:FEDC::BA98:7654:3210, FALSE) should result in an appropriate error message.</p> <p>p_IP_V4 is a BOOLEAN. When TRUE, an IP Version 4 address is to be converted, the maximum length of which is 4 octets, otherwise an IP Version 6 address is to be converted, the maximum length of which is 16 octets. See 3GPP TS 24.008 [9], clause 10.5.6.4.</p>
o_IA5_DigitsToOct	<p>Type of the result: OCTETSTRING</p> <p>Parameters: p_String: IA5String</p> <p>Description o_IA5_DigitsToOct converts the string p_String from IA5String type to OCTETSTRING. Each pair of characters is considered a pair of numbers to be mapped onto 1 octet. Each character of p_String shall represent a digit (0..9). In case the number of characters is odd, then a filler '1111'B is used to fill the last octet required to represent the digits. See 3GPP TS 24.008 [9], clause 10.5.4.7.</p> <p>EXAMPLE 1: o_IA5_DigitsToOct ("0613454120") = '6031541402'O. EXAMPLE 2: o_IA5_DigitsToOct ("06134541209") = '6031541402F9'O. EXAMPLE 3: o_IA5_DigitsToOct ("A6134541209") should result in an appropriate error message.</p>
o_IntToOct	<p>Type of the result: OCTETSTRING</p> <p>Parameters: p_N : INTEGER p_L: INTEGER</p> <p>Description o_IntToOct converts the INTEGER `p_N` into OCTETSTRING with length = `p_L`.</p> <p>EXAMPLE 1: o_IntToOct(14,1) = '0E'O. EXAMPLE 2: o_IntToOct(18,1) = '12'O. EXAMPLE 3: o_IntToOct(18,2) = '0012'O.</p>

TSO Name	Description
o_IntToIA5	<p>Type of the result: IA5String Parameters: p_N : INTEGER; p_L: INTEGER</p> <p>Description o_IntToIA5 converts the INTEGER `p_N` into IA5 String with length = 'p_L'. EXAMPLE 1: o_IntToIA5(160,3) = "160"; EXAMPLE 2: o_IntToIA5(160,4) = " 160"; EXAMPLE 3: o_IntToIA5(160,2) = "60".</p>
o_OctetstringConcat	<p>Type of the result: OCTETSTRING Parameters: p_Str1, p_Str2: OCTETSTRING</p> <p>Description o_OctetstringConcat Performs the concatenation of 2 octetstrings of possibly different lengths. The octet significance is from left to right, i.e. the MSB is at the lefthand side. Returns a resulting octetstring p_Str1 p_Str2. EXAMPLE: o_OctetstringConcat('135'O, '9A38'O) = '1359A38'O.</p>
o_OctToBit	<p>Type of the result: BITSTRING Parameters: p_OctetStr: OCTETSTRING</p> <p>Description Converts an OCTETSTRING into a BITSTRING. The size of the resulting BITSTRING is 8 times the size of the input OCTETSTRING.</p>
o_OctToIA5	<p>Type of the result: IA5String Parameters: p_String : OCTETSTRING</p> <p>Description o_OctToIA5 converts the string p_String from OCTETSTRING type to IA5String. Each octet is mapped onto a pair of characters. Nibbles 0 - F are translated into "0" - "F". For example: o_OctToIA5 ('3BF541'O) = "3BF541"</p>
o_OctToInt	<p>Type of the result: INTEGER Parameters: p_oct : OCTETSTRING</p> <p>Description Transform an OCTETSTRING of length 1 to 4 into an unsigned 32 bits INTEGER value. If the input octet string is larger than 4, then only the first 4 octets shall be considered.</p>
o_OeBit	<p>Type of the result: BITSTRING Parameters: p_BCDdigits: HEXSTRING</p> <p>Description The input parameter 'p_BCDdigits' is a BCD string (subset of HEXSTRING), the result is BITSTRING[1]. The function of the o_OeBit is as the follows:</p> <ol style="list-style-type: none"> 1. It returns '1'B, if the length of the 'p_BCDdigits' is odd. 2. It returns '0'B, if the length of the 'p_BCDdigits' is even. <p>EXAMPLE 1: o_OeBit('12583') = '1'B. EXAMPLE 2: o_OeBit('87259957') = '0'B.</p>

TSO Name	Description
o_OtherDigits	<p>Type of the result: OCTETSTRING</p> <p>Parameters: p_BCDDigits : HEXSTRING</p> <p>Description The input parameter `p_BCDDigits` is a BCD string (subset of HEXSTRING), the result is an even string of BCD digits, with eventually a filler 'F'H used. */</p> <p>The function of the o_OtherDigits is as the follows:</p> <ol style="list-style-type: none"> 1. If the number of the 'p_BCDDigits' is odd, the operation removes the most significant digit, and then reverses the order of each pair of digits. 2. If the number of the 'p_BCDDigits' is even, first the operation suffixes the `bcddigits` with 'F'H, then removes the most significant digit, and then reverses the order of each pair of digits. <p>EXAMPLE 1: o_OtherDigi('12345') = '3254', EXAMPLE 2: o_OtherDigi('12345678') = '325476F8'. See o_FirstDigit for the handling of the first digit.</p>
o_RoutingParameterIMSIResponsePaging	<p>Type of the result: RoutingParameter</p> <p>Parameters: p_IMSI : HEXSTRING</p> <p>Description The input parameter p_Imsi is a BCD string (subset of HEXSTRING), the result is of type RoutingParameter.</p> <p>The tso returns the RoutingParameter, which consists of DecimalToBinary [(IMSI div 10) mod 1000]. The bits of the result are numbered from b0 to b9, with bit b0 being the least significant.</p>

TSO Name	Description
o_SIB_PER_Encoding	<p>Type of the result: BITSTRING</p> <p>Parameters: p_SIB : SIB</p> <p>Description It returns the unaligned PER encoding (BIT STRING) of the input system information block p_SIB (without "Encoder added (1-7) bits padding"). The bits corresponding to the encoding of the CHOICE of the SIB type shall be removed. Example: for the following SIBType1 value:</p> <pre> SysInfoType1 ::= { cn-CommonGSM-MAP-NAS-SysInfo '32F4100001'H, cn-DomainSysInfoList { { cn-DomainIdentity ps-domain, cn-Type gsm-MAP : '0000'H, cn-DRX-CycleLengthCoeff 7 }, { cn-DomainIdentity cs-domain, cn-Type gsm-MAP : '0001'H, cn-DRX-CycleLengthCoeff 7 } }, ue-ConnTimersAndConstants { t-304 ms100, n-304 7, t-308 ms40, t-309 8, t-313 15, n-313 s200, t-314 s20, t-315 s1800, n-315 s1000 }, ue-IdleTimersAndConstants { t-300 ms400, n-300 7, t-312 10, n-312 s200 }, nonCriticalExtensions { } } </pre> <p>The operation returns BITSTRING: "10000110010111101000001000000000000000000101100010000000000000000100 001000000000000000010100001100110000011111000001110011111111111111111111 0101111010011"</p>
o_SIB_Segmentation	<p>Type of the result: SegmentsOfSysInfoBlock</p> <p>Parameters: p_SIBBitString : BITSTRING</p> <p>Description The function of the o_SIB_Segmentation is as following:</p> <ol style="list-style-type: none"> 1. If the p_SIBBitString is less than or equal to 226 bits, the bit string is fit into a complete segment. If the segment is less than 226 bits but more than 214 bits, the segment shall be padded to 226 bits long with padding bits set to '0'B. 2. If the input operand p_SIBBitString is longer than 226 bits it is segmented from left to right into segments, each segment except the last one is 222 bits. The last segment may be 222 bits or shorter. If the length of last segment is greater than 214 bits pad it to 222 bits with padding bits set to '0'B. 3. The number of segments is assigned to recount field of the result. 4. The first segment is assigned to seg1 field of the result, the second segment is assigned to the seg2 field of the result, the third segment is assigned to the seg3 field of the result, and so on till the last segment.

TSO Name	Description
o_SIB_SegmentationFirstSpecial	<p>Type of the result: SegmentsOfSysInfoBlock</p> <p>Parameters: p_SIB_BitString : BITSTRING p_FirstSegLength : INTEGER</p> <p>Description The function of the o_SIB_Segmentation_FirstShort is as following:</p> <ol style="list-style-type: none"> 1. If the p_SIB_BitString is less than or equal to p_FirstSegLength bits, the bit string is fit into one segment. 2. If the input operand p_SIB_BitString is longer than p_FirstSegLength bits it is segmented from left to right into segments, each segment except the first one and the last one is 222 bits . The first one is p_FirstSegLength long. The last segment may be 222 bits or shorter. If the length of last segment is greater than 214 bits pad it to 222 bits with padding bits set to '0'B. 3. The number of segments is assigned to segCount field of the result. 4. The first segment is assigned to seg1 field of the result, the second segment is assigned to the seg2 field of the result, the third segment is assigned to the seg3 field of the result, and so on till the last segment. 5. The value of parameter p_FirstSegLength shall be less than 197.
o_CheckPDUsAcknowledged	<p>Type of the result: BOOLEAN</p> <p>Parameters: p_NackList: NackList Contains a list of integers (possibly empty), each of which corresponds to a PDU SN. Negative acknowledgement is expected for each of these PDUs.</p> <p>p_FSN: INTEGER Contains an integer representing the first SN expected to be acknowledged.</p> <p>p_LSN: INTEGER Contains an integer representing the last SN expected to be acknowledged.</p> <p>p_SUFI_List: SuperFields This parameter contains the received SUFI list to be checked.</p> <p>Description: This TSO is used to check that the given SUFI list contains any combination of SUFIs that fulfils the following requirements:</p> <ol style="list-style-type: none"> 1. Negatively acknowledges all PDUs whose sequence numbers are in p_NackList. Note that the list may be empty. 2. Positively acknowledges all other PDUs with sequence numbers greater than or equal to p_FSN, and less than or equal to p_LSN. <p>Output: This TSO returns a BOOLEAN value of TRUE if the SUFI list meets all of the requirements based on the given parameters. Otherwise the TSO returns FALSE.</p>

8.7.1.1 Specific test suite operation for RLC defined in BasicM

This TSO is defined in BasicM, it is used by RLC and MAC ATSS.

Table 8.7.1.1.1: TSO definitions for RLC SUFI handling

TSO Name	Description
o_SUFI_Handler	<p>Type of the result: ResAndSUFIs</p> <p>Parameters: p_SUFI_Params: SUFI_Params p_SUFI_String: HEXSTRING</p> <p>Conditions: Inputs: p_SUFI_Params: the list of checking criteria to be applied by the TSO p_SUFI_String: the HEXSTRING received containing the SUFIs Outputs: the BOOLEAN result of the TSO: TRUE if all checking and the filling of the SuperFields structure were successful; FALSE otherwise; in this case the TSO shall produce sufficient output to allow problem analysis</p>

Table 8.7.1.1.2: ResAndSUFIs type and Processing of the SUFI parameters input to the TSO

Parameter	Type	Setting	Meaning	Comment
Lower Bound (LB)	BITSTRING [12]	OMIT	Do not use !	
		AnyOrOmit	Do not use !	
		Any	Do not use !	
Upper Bound (UB)	BITSTRING [12]	Value	Use !	
		OMIT	Do not use !	
NackList Element i (Nacki)	BITSTRING [12]	AnyOrOmit	Do not use !	
		Any	Do not use !	
		Value	Use !	Check negative ack
Window Size SUFI presence (WSN_ presence)	BOOLEAN	OMIT	Use !	Check absence
		AnyOrOmit	Do not use !	
		Any	Use !	Check presence
MRW SUFI presence (MRW_ presence)	BOOLEAN	Value	Use !	Check presence
		OMIT	Use !	Check absence
		AnyOrOmit	Do not use !	
		Any	Use !	Check presence
		Value	Use !	Check presence

8.7.1.1.1 Pseudocode in a C like notation

The pseudocode defined below can be written in a more compact fashion. The code hereafter is to allow easy identification of the TSO's tasks. All situations leading to a FALSE result must produce a log. This is not shown in the code hereafter. Possible wrap arounds are not shown in this section. These have to be accounted for at the appropriate places.

```

/* INITIALIZATION */
Initialize_ResAndSUFIs();                               /* RESULT := TRUE, all SUFI fields are AnyOrOmit */

/* EXTRACTION OF SUFIs AND TRANSFER INTO THE TTCN SUFI STRUCTURE */
i = 0;
if (p_SUFI_String == NULL)
{
  RESULT := FALSE;                                     /* No SUFIs -> Result is FALSE */
  RETURN;
}
SUFI := Extract_SUFI(i);                                /* Let n SUFI be numbered from 0 to n-1 */
while (SUFI != NULL)                                   /* TRUE when there is a SUFI */
{

```

```

    Set_SUFI_ListRec(SUFI);                                /* Put the SUFI at the correct place in the
resulting */
/* SUFI structure; overwrite if the SUFI type has */
/* already been extracted except LIST SUFIs which all are to be collected */
    i++;
    SUFI := Extract_SUFI(i);                                /* Get next SUFI */
}

/* FOR ALL SUFI TYPES: IF EXISTING, PERFORM CONSISTENCY CHECK */
if Exists_SUFI (ACK) AND NOT CheckConsistency (ACK)
RESULT := FALSE;                                         /* ACK SUFI inconsistent -> Result is FALSE */
.....
if Exists_SUFI (WINDOW) AND NOT CheckConsistency (WINDOW)
RESULT := FALSE;                                         /* WINDOW SUFI inconsistent -> Result is FALSE */

/* TAKE THE INDIVIDUAL CHECKING PARAMETERS & PERFORM THE EXPECTED CHECKING */
/* PART 1: EXISTENCE CHECKS */
if ((WSN_presence == Any) OR (WSN_presence == TRUE) OR (WSN_presence == FALSE)) AND NOT
Exists_SUFI (WINDOW)
RESULT := FALSE;                                         /* WINDOW not ex. but should -> Result is FALSE */
if ((MRW_presence == Any) OR (MRW_presence == TRUE) OR (MRW_presence == FALSE)) AND NOT
Exists_SUFI (MRW)
RESULT := FALSE;                                         /* MRW not ex. but should -> Result is FALSE */

/* PART 2: RANGE AND NACK CHECKS OF SUFI CONTENTS*/
/* ACK: LB <= LSN received <= UB */
if NOT (LB <= Extract_SUFI_Value(ACK) -1 AND Extract_SUFI_Value(ACK) -1 <= UB)
RESULT := FALSE;                                         /* ACK value not in the expected range */
/* LB: first SN acceptable as LSN received */
/* UB: last SN acceptable as LSN received */
/* LSN received acks SNs upto LSN received -1 */

/* Bitmap */
/* for all SNs between LB and UB */
{
if (ExtractBitmap(FSN extracted, LENGTH extracted, Bitmap extracted, SN) == 1) AND (SN in NackList)
RESULT := FALSE;                                         /* if the bit in the Bitmap is not 0 */
if (ExtractBitmap(FSN extracted, LENGTH extracted, Bitmap extracted, SN) == 0) AND (SN NOT in
NackList)
RESULT := FALSE;                                         /* if the bit in the Bitmap is not 0 */
}

/* LIST */
/* The (SNI,Li) pairs identify AMD PDUs which have not been correctly received. */
/* Therefore the (SNI,Li) pairs have to be consistent with the NackList. */
/* The (SNI,Li) pairs may be contained in multiple LIST SUFIs conveyed in one STATUS PDU */

/* RLIST */

/* The CWs represent the distance between the previous indicated erroneous AMD PDU */
/* up to and including the next erroneous AMD PDU, starting from the FSN contained in the RLIST
SUFI. */
/* Therefore the FSN and the Codewords have to be consistent with the NackList. */
/* Error burst indicator has to be treated as a separate case. May not have to be implemented
currently. */
/* MRW */
/* LENGTH = 0 */
/* 1 SN_MRWi is present and the RLC SDU to be discarded extends above the configured transmission
window in the sender */
/* LENGTH = 1 ... 15 */
/* 1 ...15 SN_MRWi */
/* a) MRW configured -> an SN_MRWi indicates the end of each discarded RLC SDU */
/* n SN_MRWs -> n RLC SDUs discarded */
/* b) MRW not configured -> an SN_MRWi indicates end of last RLC SDU to be discarded */
/* in the receiver */

/* To be implemented as far as required by the RLC ATS */
/* MRW ACK */
/* The SN_ACK must be consistent with the information sent in a previous MRW SUFI upon which the */
/* MRW_ACK represents the answer. */
/* NO MORE */
/* no checking required */
/* SUBFUNCTIONS USED*/
Check_Consistency (SUFI_type)                            /* returns TRUE when the type fulfils the */

```

```

/* requirements of the spec. TS 25.322*/
Exists_SUFI (SUFI_type) /* returns TRUE when the specified */

/* type has been extracted, therefore exists*/
ExtractBitmap(FSN extracted, LENGTH extracted, Bitmap extracted, Criterion)
/* Extract the value in the Bitmap at position Criterion */
/* Calculation based on information received in the */
/* Bitmap SUFI */
Extract_SUFI (Counter) /* returns the SUFI extracted at position counter */

/* from the input p_SUFI_String; */
/* n SUFIs from positions 0 to n-1 */
/* returns NULL if there is no further SUFI */
Extract_SUFI_Value (SUFI_type, field_type) /* extract the value of specific field type */

/* contained in a specific SUFI type */
/* There will be several flavours depending upon the */
/* result (field) type */
Initialize_ResAndSUFIs () /* Initialize RESULT and all SUFI fields */
Set_SUFI_ListRec(SUFI) /* set return values RESULT and */
/* SUFI structure SUFI_ListRec */

```

8.7.2 Specific test suite operation definitions for Multi RAT Handover testing

Table 8.7.2: TSO definitions for Multi RAT handover

TSO Name	Description
OC_LeastBits	<p>Type of the result: BITSTRING</p> <p>Parameters: bstring : BITSTRING lg : INTEGER</p> <p>Description: It returns the `lg` least significant bits of the original `bstring`. for example: OC_LeastBits('110011000101010'B, 3) = '010'B, OC_LeastBits('110011000101010'B, 6) = '101010'B.</p>
OC_MostBits	<p>Type of the result: BITSTRING</p> <p>Parameters: bstring : BITSTRING lg : INTEGER</p> <p>Description: It returns the `lg` most significant bits of the original `bstring`. for example: OC_MostBits ('110011000101010'B, 3) = '010'B, OC_MostBits ('110011000101010'B, 6) = '101010'B.</p>
o_HO_PER_Encoding	<p>Type of the result: BITSTRING</p> <p>Parameters: p_Msg : DL_DCCH_Message</p> <p>Description: It returns the unaligned PER encoding (BIT STRING) of the input downlink DCCH message p_Msg (without "Encoder added (1-7) bits padding").</p>

TSO Name	Description
o_PacketPagingGroupCalculate	<p>Type of the result: INTEGER</p> <p>Parameters: IMSI : HEXSTRING KC_Conf : INTEGER M : INTEGER N : INTEGER SplitPGCycle : B8</p> <p>Description: <i>It returns the calculated Packet Paging Group, according to:</i></p> $\text{PAGING_GROUP} (0 \dots M-1) = (((\text{IMSI mod } 1000) \text{ div } (\text{KC} \cdot \text{N})) \cdot \text{N} + (\text{IMSI mod } 1000) \text{ mod } \text{N} + \text{Max}((m \cdot \text{M}) \text{ div } \text{SPLIT_PG_CYCLE}, m)) \text{ mod } \text{M}$ <p>for $m = 0, \dots, \text{Min}(\text{M}, \text{SPLIT_PG_CYCLE}) - 1$ where KC = number of (P)CCCH in the cell = BS_PCC_CHANS for PCCCH or BS_CC_CHANS for CCCH</p> <p>M = number of paging blocks "available" on one (P)CCCH = (12 - BS_PAG_BLK_RES - BS_PBCCH_BLK) * 64 for PCCCH (9 - BS_AG_BLK_RES) * 64 for CCCH not combined (3 - BS_AG_BLK_RES) * 64 for CCCH + SDCCH combined</p> <p>N=1 for PCCCH (9 - BS_AG_BLK_RES)*BS_PA_MFRMS for CCCH not combined (3 - BS_AG_BLK_RES)*BS_PA_MFRMS for CCCH/SDCCH combined</p> <p>SPLIT_PG_CYCLE is an MS specific parameter negotiated at GPRS attach (see 3GPP TS 04.60) IMSI = International Mobile Subscriber Identity, as defined in 3GPP TS 03.03.</p>
o_PagingGroupCalculate	<p>Type of the result: INTEGER</p> <p>Parameters: p_IMSI : HEXSTRING p_CCCH_Conf : B_3 p_N : INTEGER</p> <p>Description Calculate the PAGING_GROUP (0 .. N-1) = ((IMSI mod 1000) mod (BS_CC_CHANS x N)) mod N where : N = number of paging blocks "available" on one CCCH = (number of paging blocks "available" in a 51-multiframe on one CCCH) x BS_PA_MFRMS. IMSI = International Mobile Subscriber Identity, as defined in 3GPP TS 23.003 [6]. mod = Modulo. div = Integer division.</p>
o_TTCN_HO_CommandToBitstring	<p>Type of the result: BITSTRING</p> <p>Parameters: p_PDU : PDU</p> <p>Description The function of the o_TTCN_HOCommandToBitstring is as the follows: - It returns the bitstring representation of the input HANDOVERCOMMAND p_PDU.</p>
o_BitToOct	<p>Type of the result: OCTETSTRING</p> <p>Parameters: p_Str: BITSTRING</p> <p>Description This TSO is used to convert the given BITSTRING into an OCTETSTRING. If the bitstring length is not a multiple of 8, 1 to 7 padding bits are added at the MSB to fill the final octet.</p>

8.7.3 Specific test suite operation for Multi RAB testing

Table 8.7.3.1: TSO definitions for Multi RAB testing

TSO Name	Description
o_SendContinuousData	<p>Type of the result: BOOLEAN</p> <p>Parameters: p_RAB_Tx_Info : RAB_Tx_Info</p> <p>Conditions: Inputs: p_RAB_Tx_Info: test data, number of RBs, and RB info of each RB (RB id, SDU size and number of SDUs to be transmitted in consecutive TTIs)</p> <p>Outputs: The BOOLEAN result of the TSO: TRUE if system simulator accepts the information sent from TTCN FALSE if system simulator rejects the information sent from TTCN.</p> <p>Description When sending the data through the TSO, after the CMAC_Restriction_REQ, the TFC under test will be one corresponding the maximum CTFC value in the Restricted list, so that SS can select the number of Transport blocks and the size of Transport blocks on individual Transport channels derived from this CTFC. Starting from the beginning of the raw data buffer given in the TSO: Data to be sent on a particular Rbld is the first (number of SDUs * SDU_Size) bits All calls to TSO o_sendContinuousData in a test will always specify the exact same set of Rblds.</p>

Table 8.7.3.2: RAB_Tx_Info type

Structure Type Definition			
Type Name: RAB_Tx_Info			
Encoding Variation:			
Comments: To provide the information to SS to send data in every TTI on each RAB. Number of RBs depends on specific requirement. SS shall take care about all kind of discard info in all RLC modes and final aim is DL TFCs under test shall be selected in downlink for each TTI.			
Element name	Type Definition	Field Encoding	Comments
test data	BITSTRING		The raw test data buffer
no_of_rbs	INTEGER		No of Radio Bearers
rb_tx_info1	RB_Tx_Info		Info about RB id, SDU size and number of SDUs
rb_tx_info2	RB_Tx_Info		Info about RB id, SDU size and number of SDUs
rb_tx_info3	RB_Tx_Info		Info about RB id, SDU size and number of SDUs
rb_tx_info4	RB_Tx_Info		Info about RB id, SDU size and number of SDUs
rb_tx_info5	RB_Tx_Info		Info about RB id, SDU size and number of SDUs
rb_tx_info6	RB_Tx_Info		Info about RB id, SDU size and number of SDUs

Table 8.7.3.3: RB_Tx_Info type

Structure Type Definition			
Type Name: RB_Tx_Info			
Encoding Variation:			
Comments:			
Element name	Type Definition	Field Encoding	Comments
rb_id	INTEGER		
sdu_size	INTEGER		
no_of_sdu	INTEGER		

8.7.4 Specific test suite operation for InterSystem Handover testing

Table 8.7.4: TSO definitions for InterSystem testing

TSO Name	Description
o_LengthofPDU	<p>Type of the result: O1</p> <p>Parameters: p_Msg : PDU</p> <p>Description: The function of the o_LengthofPDU is as the follows: - it returns the no. of octets of the input downlink message p_Msg</p>

8.7.5 Specific test suite operation for RAB_HS testing

Table 8.7.5.1: TSO definitions for RAB_HS testing

TSO Name	Description
o_CalculateTestPoint656	<p>Type of the result: HSDPA_TestPoint</p> <p>Parameters: p_PhyCat:HSDSCH_physical_layer_category p_ModScheme:ModulationScheme p_NumOfPDU: INTEGER</p> <p>Description: TSO implements tables 14.1.3.4.1 for category 1 to 6, 14.1.3.4.2 for category 7 and 8, 14.1.3.4.3 for category 9, 14.1.3.4.4 for Category 10 and 14.1.3.4.5 for category 11 and 12. It accepts UE category(1 to 12), Modulation scheme(qpsk or qam16) and number of MAC-D PDU's(1 to 70) as input. If a test point is not defined for this combination of input, then returns flag = FALSE noOfChannelisationCodes =0 tbSizeIndexOnHS_SCCH =0 If a test point is defined for the combination of inputs, it returns, flag = TRUE noOfChannelisationCodes =value as per relevant table tbSizeIndexOnHS_SCCH =TFRI value as per relevant table</p> <p>example: if input is physical category =1,modScheme=qpsk,Num Of PDU's =5 TSO returns flag = TRUE noOfChannelisationCodes =5 tbSizeIndexOnHS_SCCH =43 If input is category =1,modScheme=qpsk,Num Of PDU's =10 TSO returns flag = FALSE noOfChannelisationCodes =0 tbSizeIndexOnHS_SCCH =0</p>

TSO Name	Description
o_CalculateTestPoint336	<p>Type of the result: HSDPA_TestPoint</p> <p>Parameters: p_PhyCat:HSDSCH_physical_layer_category p_ModScheme:ModulationScheme p_NumOfPDU: INTEGER</p> <p>Description: TSO implements tables 14.1.3.3.1 for category 1 to 6, 14.1.3.3.2 for category 7 and 8, 14.1.3.3.3 for category 9, 14.1.3.3.4 for Category 10 and 14.1.3.3.5 for category 11 and 12. It accepts UE category(1 to 12), Modulation scheme(qpsk or qam16) and number of MAC-D PDU's(1 to 70) as input. If a test point is not defined for this combination of input, then returns flag = FALSE noOfChannelisationCodes =0 tbSizeIndexOnHS_SCCH =0 If a test point is defined for the combination of inputs, it returns, flag = TRUE noOfChannelisationCodes =value as per relevant table tbSizeIndexOnHS_SCCH =TFRI value as per relevant table</p> <p>example: if input is physical category =1,modScheme=qpsk,Num Of PDU's =10 TSO returns flag = TRUE noOfChannelisationCodes =5 tbSizeIndexOnHS_SCCH =45 If input is category =1,modScheme=qpsk,Num Of PDU's =17 TSO returns flag = FALSE noOfChannelisationCodes =0 tbSizeIndexOnHS_SCCH =0</p>

Table 8.7.5.2: HSDPA_TestPoint

Structure Type Definition			
Type Name: HSDPA_TestPoint			
Encoding Variation:			
Comments: To provide the information to SS to send data in every TTI on each RAB. Number of RBs depends on specific requirement. SS shall take care about all kind of discard info in all RLC modes and final aim is DL TFCs under test shall be selected in downlink for each TTI.			
Element name	Type Definition	Field Encoding	Comments
flag	BOOLEAN		TRUE if test point is applicable
noOfChannelisationCodes	INTEGER		Range 1 to 15 Valid value iff flag =TRUE
tbSizeIndexOnHS_SCCH	INTEGER		

8.7.6 Specific test suite operation for Intersystem HS Testing

Table 8.7.6: TSO definitions for ISHO_HS testing

TSO Name	Description
o_TTCN_SysInfoToOctetString	<p>Type of the result: OCTETSTRING</p> <p>Parameters: p_Type: INTEGER p_PDU : PDU</p> <p>Description: The function of the o_TTCN_SysInfoToOctetString is as the follows:</p> <ul style="list-style-type: none">- It returns the octetstring representation of the input System Information message p_PDU.- The parameter p_Type details the type of SI message. Expected values: 1, 3 and 13.

8.7.7 Specific test suite operation for A-GPS testing

Table 8.7.7: TSO definitions in A-GPS

TSO Name	Description
o_PositionEstimateToGeoInfo	<p>Type of the result: Ext_GeographicalInformation</p> <p>Parameters: p_PosEst: PositionEstimate</p> <p>Description: Converts, according to TS 23.032, clause 7, the position estimate sent by the UE in a MEASUREMENT REPORT message from type Position Estimate to type Ext_GeographicalInformation in order to be included in the FACILITY message sent by the SS in MO-LR UE-Based test cases.</p> <p>The definition of the types is the following: PositionEstimate ::= CHOICE</p> <pre>{ ellipsoidPoint EllipsoidPoint, ellipsoidPointUncertCircle EllipsoidPointUncertCircle, ellipsoidPointUncertEllipse EllipsoidPointUncertEllipse, ellipsoidPointAltitude EllipsoidPointAltitude, ellipsoidPointAltitudeEllipse EllipsoidPointAltitudeEllipsoide }</pre> <p>with one of the following options being expected from the UE:</p> <p>EllipsoidPointUncertCircle ::= SEQUENCE</p> <pre>{ latitudeSign ENUMERATED {north(0), south(1)}, latitude INTEGER (0..8388607), longitude INTEGER (-8388608..8388607), uncertaintyCode INTEGER (0..127) }</pre> <p>or</p> <p>EllipsoidPointUncertEllipse ::= SEQUENCE</p> <pre>{ latitudeSign ENUMERATED {north(0), south(1)}, latitude INTEGER (0..8388607), longitude INTEGER (-8388608..8388607), uncertaintySemiMajor INTEGER (0..127), uncertaintySemiMinor INTEGER (0..127), orientationMajorAxis INTEGER (0..89), confidence INTEGER (0..100) }</pre> <p>or</p> <p>EllipsoidPointAltitudeEllipse ::= SEQUENCE</p> <pre>{ latitudeSign ENUMERATED {north(0), south(1)}, latitude INTEGER (0..8388607), longitude INTEGER (-8388608..8388607), altitudeDirection ENUMERATED {height(0), depth(1)}, altitude INTEGER (0..32767), uncertaintySemiMajor INTEGER (0..127), uncertaintySemiMinor INTEGER (0..127), orientationMajorAxis INTEGER (0..89), uncertaintyAltitude INTEGER (0..127), confidence INTEGER (0..100) }</pre>

TSO Name	Description
	<p>The definition of the resulting type is:</p> <pre>Ext-GeographicalInformation ::= OCTET STRING (SIZE (1..maxExt-GeographicalInformation)) maxExt-GeographicalInformation INTEGER ::= 20</pre> <p>For example:</p> <pre>p_PositionEstimate:= ellipsoidPointUncertCircle { latitudeSign north, latitude 123, longitude 4567, uncertaintyCode 8 }</pre> <p>o_PositionEstimateToGeoInfo (p_PositionEstimate) = '10 00 00 7B 00 11 D7 08'O</p>
o_IA5_ToASN1Oct	<p>Type of the result: NameString</p> <p>Parameters: p_String: IA5String</p> <p>Description: Converts the string p_String from IA5String type to NameString according to the Data Coding Scheme '0F'O. This data coding scheme is the only one used in the AGPS ATS. It packs 7bit ASCII onto 8 bit octets.</p> <p>Applicable ASN.1 definitions:</p> <pre>LCSCClientName ::= SEQUENCE { dataCodingScheme [0] IMPLICIT USSD-DataCodingScheme, nameString [2] IMPLICIT NameString }</pre> <p>-- The USSD-DataCodingScheme shall indicate use of the default alphabet through the -- following encoding -- bit 7 6 5 4 3 2 1 0 -- 0 0 0 0 1 1 1 1</p> <pre>NameString ::= USSD-String (SIZE (1..maxNameStringLength)) maxNameStringLength INTEGER ::= 63 USSD-DataCodingScheme ::= OCTET STRING (SIZE (1)) -- The structure of the USSD-DataCodingScheme is defined by -- the Cell Broadcast Data Coding Scheme as described in -- TS 3GPP TS 23.038 [25] USSD-String ::= OCTET STRING (SIZE (1..maxUSSD-StringLength)) -- The structure of the contents of the USSD-String is dependent -- on the USSD-DataCodingScheme as described in TS 3GPP TS 23.038 [25]. maxUSSD-StringLength INTEGER ::= 160</pre> <p>The ATS uses:</p> <pre>IcsClientName { dataCodingScheme '0F'O, -- The USSD-DataCodingScheme shall indicate use of the -- default alphabet through the following encoding -- bit 7 6 5 4 3 2 1 0 -- 0 0 0 0 1 1 1 1</pre> <p>For example: o_IA5_ToASN1Oct ("ERICH") = '4569728804'O</p>

TSO Name	Description
o_ISDN_Address_ToASN1Oct	<p>Type of the result: ISDN_AddressString</p> <p>Parameters: p_TOA: B4 p_NPI: B4 p_String: IA5String</p> <p>Description: Converts p_TOA plus p_NPI, and string p_String to ISDN_AddressString. TOA and NPI are mapped onto the first octet. Each pair of characters of p_String is considered a pair of numbers to be mapped onto 1 octet. Each character of p_String shall represent a digit (0..9). In case the number of characters is odd, then a filler '1111'B is used to fill the last octet required to represent the digits. See 3G TS 24008, clause 10.5.4.7</p> <p>Applicable ASN.1 definitions:</p> <pre> LCSCClientExternalID ::= SEQUENCE { externalAddress [0] IMPLICIT ISDN-AddressString OPTIONAL, extensionContainer [1] IMPLICIT ExtensionContainer OPTIONAL } ISDN-AddressString ::= AddressString (SIZE (1..maxISDN-AddressLength)) -- This type is used to represent ISDN numbers. maxISDN-AddressLength INTEGER ::= 9 AddressString ::= OCTET STRING (SIZE (1..maxAddressLength)) -- This type is used to represent a number for addressing -- purposes. It is composed of -- a) one octet for nature of address, and numbering plan -- indicator. -- b) digits of an address encoded as TBCD-String. -- a) The first octet includes a one bit extension indicator, a -- 3 bits nature of address indicator and a 4 bits numbering -- plan indicator, encoded as follows: -- bit 8: 1 (no extension) -- bits 765: nature of address indicator -- 000 unknown -- 001 international number -- 010 national significant number -- 011 network specific number -- 100 subscriber number -- 101 reserved -- 110 abbreviated number -- 111 reserved for extension -- bits 4321: numbering plan indicator -- 0000 unknown -- 0001 ISDN/Telephony Numbering Plan (Rec ITU-T E.164) -- 0010 spare -- 0011 data numbering plan (ITU-T Rec X.121) -- 0100 telex numbering plan (ITU-T Rec F.69) -- 0101 spare -- 0110 land mobile numbering plan (ITU-T Rec E.212) -- 0111 spare -- 1000 national numbering plan -- 1001 private numbering plan -- 1111 reserved for extension -- all other values are reserved. -- b) The following octets representing digits of an address -- encoded as a TBCD-STRING. </pre>

TSO Name	Description
	<p>maxAddressLength INTEGER ::= 20</p> <p>For example: o_ISDN_Address_ToASN1Oct ('0011','0011','0123456") = '33103254F6'0</p>
o_LengthofComponents	<p>Type of the result: OCTETSTRING</p> <p>Parameters: p_Components: Components</p> <p>Description: The functionality of the o_LengthofComponents is as below: It returns the length (no. of octets) of the input constraint p_Components</p>

8.7.8 Specific test suite operation for E-DCH Testing

Table 8.7.8: TSO definitions in E-DCH

TSO Name	Description
o_CalculateE_DCH_TBSize	<p>Type of the result: INTEGER</p> <p>Parameters: p_tti: E_DCH_TTI p_TableInd: E_TFCI_TableIndex p_TB_Index: INTEGER</p> <p>Description: TSO implements tables defined in 25.321 Annex B.1 (tti 2ms Index 0), Annex B.2 (tti 2ms Index 1), Annex B.3 (tti 10ms Index 0), Annex B.4 (tti 10ms Index 1). It accepts 3 input parameters: p_TTI: the TTI of E-DCH (2ms or 10ms) P_TableInd: the table index (0 or 1) p_TB_Index: the TB index in the table (0..127 for tti 2ms Index 0), (0..125 tti 2ms Index 1), (0..127 tti 10ms Index 0), (0..120 tti 10ms Index 1) The TSO then returns the corresponding TB Size from the appropriate Table and with given table index. The value returned is '0' for any erroneous conditions (e.g. p_TB_Index out of range). Example: p_tti:2ms, p_TableInd:0, p_TB_Index:13 produces the result 185</p>

8.7.9 Specific test suite operation for E-DCH/HS-ENH and MBMS testing

Table 8.7.9: TSO definitions in E-DCH/HS-ENH and MBMS

TSO Name	Description
o_CalculateE_DCH_TBSize_UL16QAM	<p>Type of the result: INTEGER</p> <p>Parameters: p_TableInd: E_TFCI_TableIndex p_TB_Index: INTEGER</p> <p>Description: TSO implements tables defined in 3GPP TS 25.321 [17], clauses B.2a (tti 2ms Index 0) and B.2b (tti 2ms Index 1). It accepts 2 inputs:</p> <p>p_TableInd: the table index (0 or 1) p_TB_Index: the TB index in the table (0..127 for tti 2ms Index 0), (0..124 tti 2ms Index 1) The TSO then returns the corresponding TB Size from the appropriate Table and with given table index. The value returned is '0' for any erroneous conditions (eg. p_TB_Index out of range). Example: p_TableInd: 0, p_TB_Index: 13 produces result 197</p>
o_CalculateTBSize_MAC_ehs_OctetAligned	<p>Type of the result: INTEGER</p> <p>Parameters: p_Kt : INTEGER</p> <p>Description: The TSO calculates the value of TB size L(p_Kt) as given in 3GPP TS 25.321 [17], clause 9.2.3.1, Table 9.2.3.2. Kt valid range is from 1 to 295(both included) If p_Kt < 40 $L(p_Kt) = (14 + p_Kt) * 8$ else $L(p_Kt) = (\text{Floor}(Lmin * (P ** p_Kt)) * 8)$ Lmin = 27 $P = [5274/27]**[1/295]$ end</p> <p>Where * represents multiplication ** represents power</p>
o_CalculateTBSize_MAC_ehs_BitAligned	<p>Type of the result: INTEGER</p> <p>Parameters: p_Kt : INTEGER</p> <p>Description: The TSO calculates the value of TB size L(p_Kt) as given in 3GPP TS 25.321 [17], clause 9.2.3.1, Table 9.2.3.1. Kt valid range is from 1 to 295(both included)</p> <p>If $k_t < 40$ $L(p_Kt) = 125 + 12 * p_Kt$ else $L(p_Kt) = (\text{Floor}(Lmin * (P ** p_Kt)))$ P=2085/2048 Lmin = 296 end</p> <p>Where * represents multiplication ** represents power</p>

TSO Name	Description
o_CalculateTestPoint336_MAC_ehs	<p>Type of the result: HSDPA_TestPoint</p> <p>Parameters: p_PhyCat: HSDSCH_physical_layer_category_ext; p_ModScheme: ModulationScheme; p_NumOfPDU: INTEGER</p> <p>Description: TSO implements tables 14.1.3.4b.1.1 for QPSK, 14.1.3.4b.1.2 for 16QAM and 14.1.3.4b.1.3 for 64QAM.</p> <p>It accepts as input: - UE category (1 to 20), - Modulation scheme (qpsk, qam16 or qam64) and - Number of MAC-d PDU's (1 to 26)</p> <p>If a test point is not defined for this combination of input, then returns flag = FALSE noOfChannelisatonCodes =0 tbSizeIndexOnHS_SCCH =0 If a test point is defined for the combination of inputs, it returns, flag = TRUE noOfChannelisatonCodes =value as per relevant table tbSizeIndexOnHS_SCCH =TFRI value as per relevant table</p> <p>Example: If input is: - physical category = 13, - modScheme = qpsk, - Num Of PDU's = 10 TSO returns: flag = TRUE noOfChannelisatonCodes =11 tbSizeIndexOnHS_SCCH =4</p> <p>If input is: - physical category = 13, - modScheme = qpsk, - Num Of PDU's = 50 TSO returns: flag = FALSE noOfChannelisatonCodes = 0 tbSizeIndexOnHS_SCCH = 0</p>
o_CalculateTestPoint64QM	<p>Type of the result: MIMO_TestPoint</p> <p>Parameters: p_ModScheme:ModulationScheme p_Index: INTEGER</p> <p>Description: TSO implements tables 14.1.3.4b.2.5 (for 64QAM and QPSK) and 14.1.3.4b.2.6 (for 64QAM and 16QAM).</p> <p>It accepts as input: - Modulation scheme (qam64, qam16 or qpsk) and - Test Point Index</p> <p>If a test point is not defined for this combination of input, then returns flag = FALSE noOfChannelisatonCodes =0 tbSizeIndexOnHS_SCCH =0 noOfMAC-dPDUs = 0</p> <p>If a test point is defined for the combination of inputs, it returns, flag = TRUE noOfChannelisatonCodes =value as per relevant table tbSizeIndexOnHS_SCCH =TFRI value as per relevant table noOfMAC-dPDUs = value as per relevant table (0 in the case of index 34 and 35)</p>

TSO Name	Description
	<p>Examples:</p> <p>If input is: - modScheme = qam64, - Index = 10 TSO returns: flag = TRUE noOfChannelisatonCodes =5 tbSizeIndexOnHS_SCCH =9 noOfMAC-dPDUs = 8</p> <p>If input is: - modScheme = qpsk, - Index = 10 TSO returns: flag = TRUE noOfChannelisatonCodes =5 tbSizeIndexOnHS_SCCH =55 noOfMAC-dPDUs = 6</p> <p>If input is: - modScheme = qam16, - Index = 10 TSO returns: flag = TRUE noOfChannelisatonCodes =5 tbSizeIndexOnHS_SCCH =55 noOfMAC-dPDUs = 11</p> <p>If input is: - modScheme = qam16, - Index = 36 TSO returns: flag = FALSE noOfChannelisatonCodes =0 tbSizeIndexOnHS_SCCH =0 noOfMAC-dPDUs = 0</p>
o_CalculateTestPoint656_MAC_ehs	<p>Type of the result: HSDPA_TestPoint</p> <p>Parameters: p_PhyCat: HSDSCH_physical_layer_category_ext; p_ModScheme: ModulationScheme; p_NumOfPDU: INTEGER</p> <p>Description: TSO implements tables 14.1.3.4b.2.1 for QPSK, 14.1.3.4b.2.2 for 16QAM and 14.1.3.4b.2.3 for 64QAM.</p> <p>It accepts as input: - UE category (1 to 20), - Modulation scheme (qpsk, qam16 or qam64) and - Number of MAC-d PDU's (1 to 64) when flexible MAC-d PDU size is configured, this parameter is only used to index the test points. - Number of MAC-d PDU's (1 to 26) when fixed MAC-d PDU is configured</p> <p>If a test point is not defined for this combination of input, then returns flag = FALSE noOfChannelisatonCodes =0 tbSizeIndexOnHS_SCCH =0</p> <p>If a test point is defined for the combination of inputs, it returns, flag = TRUE noOfChannelisatonCodes =value as per relevant table tbSizeIndexOnHS_SCCH =TFRI value as per relevant table</p> <p>Example: If input is: - physical category = 13,</p>

TSO Name	Description
	<p>- modScheme = qpsk, - Num Of PDU's = 10 TSO returns: flag = TRUE noOfChannelisatonCodes =15 tbSizeIndexOnHS_SCCH =22</p> <p>If input is: - physical category = 13, - modScheme = qpsk, - Num Of PDU's = 50 TSO returns: flag = FALSE noOfChannelisatonCodes = 0 tbSizeIndexOnHS_SCCH = 0</p>
o_CalculateTestPoint_TwoFlows	<p>Type of the result: TwoFlows_TestPoint</p> <p>Parameters: p_ModScheme: ModulationScheme p_Index: INTEGER</p> <p>Description: TSO implements table 14.1.3.4b.2.4 for QPSK and 16QAM modulations.</p> <p>It accepts as input: - Modulation scheme (qam16 or qpsk) and - Test Point Index</p> <p>If a test point is not defined for this combination of input, then returns flag = FALSE noOfChannelisatonCodes =0 tbSizeIndexOnHS_SCCH =0 noOfMAC-dPDUs = 0</p> <p>If a test point is defined for the combination of inputs, it returns, flag = TRUE noOfChannelisatonCodes =value as per relevant table tbSizeIndexOnHS_SCCH =TFRI value as per relevant table noOfMAC-dPDUs = value as per relevant table (0 in the case of index 34 and 35)</p> <p>Examples:</p> <p>If input is: - modScheme = qpsk, - Index = 10 TSO returns: flag = TRUE noOfChannelisatonCodes =5 tbSizeIndexOnHS_SCCH =55 noOfMAC-dPDUs = 6</p> <p>If input is: - modScheme = qam16, - Index = 10 TSO returns: flag = TRUE noOfChannelisatonCodes =5 tbSizeIndexOnHS_SCCH =50 noOfMAC-dPDUs = 11</p> <p>If input is: - modScheme = qam16, - Index = 36 TSO returns: flag = FALSE noOfChannelisatonCodes =0 tbSizeIndexOnHS_SCCH =0 noOfMAC-dPDUs = 0</p>

TSO Name	Description
o_CalculateTestPoint_TwoFlows64QAM	<p>Type of the result: TwoFlows_TestPoint</p> <p>Parameters: p_ModScheme: ModulationScheme p_Index: INTEGER</p> <p>Description: TSO implements tables 14.1.3.4b.2.5 (for 64QAM and QPSK) and 14.1.3.4b.2.6 (for 64QAM and 16QAM).</p> <p>It accepts as input: - Modulation scheme (qam64, qam16 or qpsk) and - Test Point Index</p> <p>If a test point is not defined for this combination of input, then returns flag = FALSE noOfChannelisatonCodes =0 tbSizeIndexOnHS_SCCH =0 noOfMAC-dPDUs = 0</p> <p>If a test point is defined for the combination of inputs, it returns, flag = TRUE noOfChannelisatonCodes =value as per relevant table tbSizeIndexOnHS_SCCH =TFRI value as per relevant table noOfMAC-dPDUs = value as per relevant table (0 in the case of index 34 and 35)</p> <p>Examples:</p> <p>If input is: - modScheme = qam64, - Index = 10 TSO returns: flag = TRUE noOfChannelisatonCodes =5 tbSizeIndexOnHS_SCCH =9 noOfMAC-dPDUs = 8</p> <p>If input is: - modScheme = qpsk, - Index = 10 TSO returns: flag = TRUE noOfChannelisatonCodes =5 tbSizeIndexOnHS_SCCH =55 noOfMAC-dPDUs = 6</p> <p>If input is: - modScheme = qam16, - Index = 10 TSO returns: flag = TRUE noOfChannelisatonCodes =5 tbSizeIndexOnHS_SCCH =55 noOfMAC-dPDUs = 11</p> <p>If input is: - modScheme = qam16, - Index = 36 TSO returns: flag = FALSE noOfChannelisatonCodes =0 tbSizeIndexOnHS_SCCH =0 noOfMAC-dPDUs = 0</p>

TSO Name	Description
o_CalculateTestPoint656_MAC_ahs_DC	<p>Type of the result: HSDPA_TestPoint</p> <p>Parameters: p_PhyCat: HSDSCH_physical_layer_category_ext2; p_ModScheme: ModulationScheme; p_NumOfPDU: INTEGER</p> <p>Description: TSO implements tables 14.1.3.4b.2.1 for QPSK, 14.1.3.4b.2.2 for 16QAM and 14.1.3.4b.2.3 for 64QAM.</p> <p>It accepts as input: - UE category (21 to 24), - Modulation scheme (qpsk, qam16 or qam64) and - Number of MAC-d PDU's (1 to 64) when flexible MAC-d PDU size is configured, this parameter is only used to index the test points. - Number of MAC-d PDU's (1 to 26) when fixed MAC-d PDU is configured.</p> <p>If a test point is not defined for this combination of input, then returns flag = FALSE noOfChannelisatonCodes =0 tbSizeIndexOnHS_SCCH =0</p> <p>If a test point is defined for the combination of inputs, it returns, flag = TRUE noOfChannelisatonCodes =value as per relevant table tbSizeIndexOnHS_SCCH =TFRI value as per relevant table</p> <p>Example: If input is: - physical category = 21, - modScheme = qpsk, - Num Of PDU's = 10 TSO returns: flag = TRUE noOfChannelisatonCodes =15 tbSizeIndexOnHS_SCCH =22</p> <p>If input is: - physical category = 21, - modScheme = qpsk, - Num Of PDU's = 50 TSO returns: flag = FALSE noOfChannelisatonCodes = 0 tbSizeIndexOnHS_SCCH = 0</p>

8.8 AT commands

Table 8.8 shows a list of AT commands. By using these commands the ATs communicate with the SS for an automatic execution. The column "ATS" indicates in which ATS the command is used.

Table 8.8: AT commands used in 3GPP ATs

Command	Reference	ATS
+CGACT	3GPP TS 27.007 [23]	BMC, MAC, NAS, RAB, RLC, RRC, PDCP, SMS
+CGATT	3GPP TS 27.007 [23]	BMC, MAC, NAS, RAB, RLC, RRC, PDCP, SMS
+CGCMOD	3GPP TS 27.007 [23]	NAS
+CGDCONT (Note)	3GPP TS 27.007 [23]	BMC, MAC, NAS, RAB, RLC, RRC, PDCP, SMS
+CGDSCONT	3GPP TS 27.007 [23]	NAS
+CGEQREQ	3GPP TS 27.007 [23]	BMC, MAC, NAS, RAB, RLC, RRC, PDCP, SMS
+CLCC	3GPP TS 27.007 [23]	NAS
H	3GPP TS 27.007 [23]	NAS, RAB, RRC, SMS
+CBST	3GPP TS 27.007 [23]	NAS, RAB, RRC, SMS
+CMOD	3GPP TS 27.007 [23]	NAS, RAB, RRC, SMS
A	3GPP TS 27.007 [23]	NAS, RAB, RRC, SMS
D	3GPP TS 27.007 [23]	BMC, MAC, NAS, RAB, RLC, RRC, PDCP, SMS
+CMGD	3GPP TS 27.005 [22]	SMS
+CMGF	3GPP TS 27.005 [22]	SMS
+CMGW	3GPP TS 27.005 [22]	SMS
+CMSS	3GPP TS 27.005 [22]	NAS, RAB, RRC, SMS
+CPMS	3GPP TS 27.005 [22]	SMS
+CSCA	3GPP TS 27.005 [22]	SMS
+CSCS	3GPP TS 27.005 [22]	SMS
+CSMS	3GPP TS 27.005 [22]	SMS
+CVHU	3GPP TS 27.005 [22]	NAS, RAB, RRC, SMS, IR_U, IR_G
+CHUP	3GPP TS 27.005 [22]	NAS, RAB, RRC, SMS, IR_U, IR_G
Note:	The PDP Type in +CGDCONT is per default set to "IP" (IPv4).It can be changed to IPv6 in the specific TCs, for example, for SM NISPC in Rel-7. The setting IPv6 address will require IPv6 handling on the established RAB.	

8.8.1 AT command lists in ATSS

8.8.1.1 AT commands in IR_U ATs:

Command	Syntax in TTCN	Comments
CBST	AT+CBST=[<speed>[,<name>[,<ce>]]]<CR> <speed>=0,7,12,14,15,16,17,39,43,47,48,49,50,51,71,75,79,80, 81,82,83,84,115,116,120,121 <name>=0,1,4,5 <ce>=0,1	Select bearer service type, 3GPP TS 27.007 [23], clause 6.7
CGACT	AT+CGACT=1,1<CR> AT+CGACT=0,1<CR>	PDP context activate or deactivate, 3GPP TS 27.007 [23], clause 10.1.10
CGATT	AT+CGATT=1<CR>	PS attach or detach, 3GPP TS 27.007 [23], clause 10.1.9
CGDSCONT	AT+CGDSCONT= 1,<CR> AT+ CGDSCONT=1 , 1, "IP", 0,0,<CR>	Establish secondary PDP Context, 3GPP TS 27.007 [23], clause 10.1.2
CGEQREQ	AT+CGEQREQ=1,2,64,64,,,0,320,"1E4","1E5",1,,3<CR> AT+CGEQREQ=1,3,64,64,,,0,320,"1E4","1E5",1,,<CR>	Quality of Service Profile (Requested), 3GPP TS 27.007 [23], clause 10.1.4
CHUP	AT+CHUP<CR>	Hang up call, 3GPP TS 27.007 [23], 3GPP TS 27.007 [23], clause 6.5
CMGD	AT+CMGD=001<CR> AT+CMGD=1,4<CR>	Delete Message, 3GPP TS 27.005 [22], clause 3.5.4
CMGF	AT+CMGF=1<CR>	Message Format, 3GPP TS 27.005 [22], clause 3.2.3
CMOD	AT+CMOD=0<CR> AT+CMOD=1<CR>	Call mode, 3GPP TS 27.007 [23], clause 6.4
CMSS	AT+CMSS=000<CR> AT+CMSS=001<CR> AT+CMSS=002<CR>	Send Message from Storage, 3GPP TS 27.005 [22], clause 3.5.2
CPMS	AT+CPMS="SM","SM","MT"<CR> AT+CPMS="CB","CB","CB"<CR>	Preferred Message Storage, 3GPP TS 27.005 [22], clause 3.2.2
CSCS	AT+CSCS="GSM"<CR>	Select TE character set, 3GPP TS 27.007 [23], clause 5.5
CSMS	AT+CSMS=0<CR>	Select Message Service, 3GPP TS 27.005 [22], clause 3.2.1
CVHU	AT+CVHU=0<CR>	Voice Hang up control, 3GPP TS 27.007 [23], clause 6.20

8.8.1.2 AT commands in MAC and RLC ATs:

Command	Syntax in TTCN	Comments
CGATT	AT+CGATT=1<CR>	PS attach or detach, 3GPP TS 27.007 [23], clause 10.1.9

8.8.1.3 AT commands in NAS ATS:

Command	Syntax in TTCN	Comments
CBST	AT+CBST=[<speed>[,<name>[,<ce>]]]<CR> <speed>=0,7,12,14,15,16,17,39,43,47,48,49,50,51,71,75,79,80,81,82,83,84,115,116,120,121 <name>=0,1,4,5 <ce>=0,1	Select bearer service type, 3GPP TS 27.007 [23], clause 6.7
CGACT	AT+CGACT=1,1<CR> AT+CGACT=0,1<CR>	PDP context activate or deactivate, 3GPP TS 27.007 [23], clause 10.1.10
CGATT	AT+CGATT=1<CR> AT+CGATT=0<CR>	PS attach or detach, 3GPP TS 27.007 [23], clause 10.1.9
CGDATA	AT+CGDATA=PPP,1<CR>	Enter data state, 3GPP TS 27.007 [23], clause 10.1.12
CGDCONT	AT+CGDCONT=1,"IP","ABCDEF","200.1.1.80",0,0<CR> AT+CGDCONT=1,"IP","GHIJK","200.1.1.90",0,0<CR>	Define PDP Context, 3GPP TS 27.007 [23], clause 10.1.1
CGDSCONT	AT+CGDSCONT= 1,<CR> AT+ CGDSCONT=1 , 1, "IP", 0,0,<CR>	Establish secondary PDP Context, 3GPP TS 27.007 [23], clause 10.1.2
CGEQMIN	AT+CGEQMIN=1,3,32,32,,,1,320,"1E3","4E3",1,,<CR> AT+CGEQMIN=1,3,64,64,,,1,320,"1E3","4E3",1,,<CR> AT+CGEQMIN=1,2,32, 32, 32, 32, 1, 320, 1E4,6E8,1,,,<CR> AT+CGEQMIN=1,3,32, 32, 32, 32, 1, 320, 1E4,6E8,1,,,<CR> AT+CGEQMIN=1,2,32, 32, 32, 32, 1, 320, 1E3,6E8,1,,,<CR> AT+CGEQMIN=1,3,32, 32, 32, 32, 1, 320, 1E3,6E8,1,,,<CR> AT+CGEQMIN=1,2,64, 64, 64, 64, 1, 320, 1E3,6E8,1,,,<CR> AT+CGEQMIN=1,3,64, 64, 64, 64, 1, 320, 1E3,6E8,1,,,<CR>	Quality of Service Profile (Minimum acceptable), 3GPP TS 27.007 [23], clause 10.1.4
CGEQREQ	AT+CGEQREQ=1,2,64,64,,,0,320,"1E4","1E5",1,,3<CR> AT+CGEQREQ=1,3,64,64,,,0,320,"1E4","1E5",1,,<CR> AT+CGEQREQ=1,2,64, 64, 64, 64, 0, 320, 1E4,6E8,1,,,<CR> AT+CGEQREQ=1,3,64, 64, 64, 64, 0, 320, 1E4,6E8,1,,,<CR>	Quality of Service Profile (Requested), 3GPP TS 27.007 [23], clause 10.1.4
CHUP	AT+CHUP<CR>	Hang up call, 3GPP TS 27.007 [23], clause 6.5
CLCC	AT+CLCC<CR>	List current calls, 3GPP TS 27.007 [23], clause 7.18
CMOD	AT+CMOD=0<CR> AT+CMOD=1<CR>	Call mode, 3GPP TS 27.007 [23], clause 6.4
CMSS	AT+CMSS=000<CR> AT+CMSS=001<CR> AT+CMSS=002<CR>	Send Message from Storage, 3GPP TS 27.005 [22], clause 3.5.2
VTS	AT+VTS=0,100<CR> AT+VTS=1,50<CR> AT+VTS=2,60<CR> AT+VTS=3,40<CR> AT+VTS=4,50<CR> AT+VTS=5,60<CR> AT+VTS=6,70<CR> AT+VTS=7,80<CR> AT+VTS=8,90<CR> AT+VTS=9,100<CR> AT+VTS=#,110<CR> AT+VTS=*,120<CR> AT+VTS=A,130<CR> AT+VTS=B,140<CR> AT+VTS=C,150<CR> AT+VTS=D,200<CR>	DTMF and tone generation, 3GPP TS 27.007 [23], clause C.2.11
CVHU	AT+CVHU=0<CR>	Voice Hang up control, 3GPP TS 27.007 [23], clause 6.20

8.8.1.4 AT commands in RAB ATS:

Command	Syntax in TTCN	Comments
CBST	AT+CBST=[<speed>[,<name>[,<ce>]]]<CR> <speed>=0,7,12,14,15,16,17,39,43,47,48,49,50,51,71,75,79,80,81,82,83,84,115,116,120,121 <name>=0,1,4,5 <ce>=0,1	Select bearer service type, 3GPP TS 27.007 [23], clause 6.7
CGACT	AT+CGACT=1,1<CR> AT+CGACT=0,1<CR>	PDP context activate or deactivate, 3GPP TS 27.007 [23], clause 10.1.10
CGATT	AT+CGATT=1<CR>	PS attach or detach, 3GPP TS 27.007 [23], clause 10.1.9
CGDCONT	AT+CGDCONT=1,"IP","ABCDEF","200.1.1.80",0,0<CR> AT+CGDCONT=1,"IP","GHIJK","200.1.1.90",0,0<CR>	Define PDP Context, 3GPP TS 27.007 [23], clause 10.1.1
CGDSCONT	AT+CGDSCONT= 1,<CR> AT+ CGDSCONT=1 , 1, "IP", 0,0,<CR>	Establish secondary PDP Context, 3GPP TS 27.007 [23], clause 10.1.2
CGEQREQ	AT+CGEQREQ=1,2,64,64,,,0,320,"1E4","1E5",1,,3<CR> AT+CGEQREQ=1,3,64,64,,,0,320,"1E4","1E5",1,,<CR>	Quality of Service Profile (Requested), 3GPP TS 27.007 [23], clause 10.1.4
CHUP	AT+CHUP<CR>	Hang up call, 3GPP TS 27.007 [23] clause 6.5
CMGD	AT+CMGD=001<CR> AT+CMGD=1,4<CR>	Delete Message, 3GPP TS 27.005 [22], clause 3.5.4
CMGF	AT+CMGF=1<CR>	Message Format, 3GPP TS 27.005 [22], clause 3.2.3
CMOD	AT+CMOD=0<CR> AT+CMOD=1<CR>	Call mode, 3GPP TS 27.007 [23], clause 6.4
CMSS	AT+CMSS=000<CR> AT+CMSS=001<CR> AT+CMSS=002<CR>	Send Message from Storage, 3GPP TS 27.005 [22], clause 3.5.2
CPMS	AT+CPMS="SM","SM","MT"<CR> AT+CPMS="CB","CB","CB"<CR>	Preferred Message Storage, 3GPP TS 27.005 [22], clause 3.2.2
CSCS	AT+CSCS="GSM"<CR>	Select TE character set, 3GPP TS 27.007 [23], clause 5.5
CSMS	AT+CSMS=0<CR>	Select Message Service, 3GPP TS 27.005 [22], clause 3.2.1
CVHU	AT+CVHU=0<CR>	Voice Hang up control, 3GPP TS 27.007 [23], clause 6.20

8.8.1.5 AT commands in RRC ATS:

Command	Syntax in TTCN	Comments
ATA	ATA<CR>	Answer a call, 3GPP TS 27.007 [23], clause 6.35
ATD	ATD0123456902;<CR> ATD112;<CR> ATD0123456902<CR>	Originates a call, TS 27.007 clause 6.31
ATH	ATH<CR>	Hang-up a single mode call, 3GPP TS 27.007 [23], clause 6.36
CBST	AT+CBST=[<speed>[,<name>[,<ce>]]]<CR> <speed>=0,7,12,14,15,16,17,39,43,47,48,49,50,51,71,75,79,80,81,82,83,84,115,116,120,121 <name>=0,1,4,5 <ce>=0,1	Select bearer service type, 3GPP TS 27.007 [23], clause 6.7
CGACT	AT+CGACT=1,1<CR> AT+CGACT=0,1<CR>	PDP context activate or deactivate, 3GPP TS 27.007 [23], clause 10.1.10
CGATT	AT+CGATT=1<CR>	PS attach or detach, 3GPP TS 27.007 [23], clause 10.1.9
CGDCONT	AT+CGDCONT=1,"IP","ABCDEF","200.1.1.80",0,0<CR> AT+CGDCONT=1,"IP","GHIJK","200.1.1.90",0,0<CR>	Define PDP Context, 3GPP TS 27.007 [23], clause 10.1.1
CGDSCONT	AT+CGDSCONT= 1,<CR> AT+ CGDSCONT=1 , 1, "IP", 0,0,<CR>	Establish secondary PDP Context, 3GPP TS 27.007 [23], clause 10.1.2
CGEQREQ	AT+CGEQREQ=1,2,64,64,,,0,320,"1E4","1E5",1,,3<CR> AT+CGEQREQ=1,3,64,64,,,0,320,"1E4","1E5",1,,<CR>	Quality of Service Profile (Requested), 3GPP TS 27.007 [23], clause 10.1.4
CHUP	AT+CHUP<CR>	Hang up call, 3GPP TS 27.007 [23], clause 6.5
CMOD	AT+CMOD=0<CR> AT+CMOD=1<CR>	Call mode, 3GPP TS 27.007 [23], clause 6.4
CMSS	AT+CMSS=000<CR> AT+CMSS=001<CR> AT+CMSS=002<CR>	Send Message from Storage, 3GPP TS 27.005 [22], clause 3.5.2
CVHU	AT+CVHU=0<CR>	Voice Hang up control, 3GPP TS 27.007 [23], clause 6.20

8.8.1.6 AT commands SMS ATS:

Command	Syntax in TTCN	Comments
CBST	AT+CBST=[<speed>[,<name>[,<ce>]]]<CR> <speed>=0,7,12,14,15,16,17,39,43,47,48,49,50,51,71,75,79,80,81,82,83,84,115,116,120,121 <name>=0,1,4,5 <ce>=0,1	Select bearer service type, 3GPP TS 27.007 [23], clause 6.7
CGACT	AT+CGACT=1,1<CR> AT+CGACT=0,1<CR>	PDP context activate or deactivate, 3GPP TS 27.007 [23], clause 10.1.10
CGATT	AT+CGATT=1<CR>	PS attach or detach, 3GPP TS 27.007 [23], clause 10.1.9
CGDCONT	AT+CGDCONT=1,"IP","ABCDEF","200.1.1.80",0,0<CR> AT+CGDCONT=1,"IP","GHIJK","200.1.1.90",0,0<CR>	Define PDP Context, 3GPP TS 27.007 [23], clause 10.1.1
CGDSCONT	AT+CGDSCONT= 1,<CR> AT+ CGDSCONT=1 , 1, "IP", 0,0,<CR>	Establish secondary PDP Context, 3GPP TS 27.007 [23], clause 10.1.2
CGEQREQ	AT+CGEQREQ=1,2,64,64,,,0,320,"1E4","1E5",1,,3<CR> AT+CGEQREQ=1,3,64,64,,,0,320,"1E4","1E5",1,,<CR>	Quality of Service Profile (Requested), 3GPP TS 27.007 [23], clause 10.1.4
CGSMS	AT+CGSMS=1<CR> AT+CGSMS=0<CR>	Select service for MO SMS messages, 3GPP TS 27.007 [23], clause 10.1.20
CHUP	AT+CHUP<CR>	Hang up call, 3GPP TS 27.007 [23], clause 6.5
CMGD	AT+CMGD=001<CR> AT+CMGD=1,4<CR>	Delete Message, 3GPP TS 27.005 [22], clause 3.5.4
CMGF	AT+CMGF=1<CR>	Message Format, 3GPP TS 27.005 [22], clause 3.2.3
CMGR	AT+CMGR=001<CR> AT+CMGR=002<CR> AT+CMGR=003<CR> AT+CMGR=004<CR>	Read Message, 3GPP TS 27.005 [22], clause 3.4.3
CMGW	AT+CMGW= "1111111111",129, "The quick brown fox jumps over the lazy dog's back. Kaufen Sie Ihrer Frau vier bequeme Pelze. - 0123456789 - THE QUICK BROWN FOX JUMPS OVER THE LAZY DOG'S BACK."<CR>	Write Message to Memory, 3GPP TS 27.005 [22], clause 3.5.3
CMMS	AT+CMMS=1<CR>	More Messages to Send, 3GPP TS 27.005 [22], clause 3.5.6
CMOD	AT+CMOD=0<CR> AT+CMOD=1<CR>	Call mode, 3GPP TS 27.007 [23], clause 6.4
CMSS	AT+CMSS=000<CR> AT+CMSS=001<CR> AT+CMSS=002<CR>	Send Message from Storage, 3GPP TS 27.005 [22], clause 3.5.2
CPMS	AT+CPMS="SM","SM","MT"<CR> AT+CPMS="CB","CB","CB"<CR>	Preferred Message Storage, 3GPP TS 27.005 [22], clause 3.2.2
CSCA	AT+CSCA="2222222222",129<CR>	Service Centre Address, 3GPP TS 27.005 [22], clause 3.3.1
CSCS	AT+CSCS="GSM"<CR>	Select TE character set, 3GPP TS 27.007 [23], clause 5.5
CSMS	AT+CSMS=0<CR>	Select Message Service, 3GPP TS 27.005 [22], clause 3.2.1
CVHU	AT+CVHU=0<CR>	Voice Hang up control, 3GPP TS 27.007 [23], clause 6.20

8.8.1.7 AT commands in HSDPA ATS (Rel-5 or later):

Command	Syntax in TTCN	Comments
CGEQREQ	AT+CGEQREQ=[<cid> [,<Traffic class> [,<Maximum bitrate UL> [,<Maximum bitrate DL> [,<Guaranteed bitrate UL> [,<Guaranteed bitrate DL> [,<Delivery order> [,<Maximum SDU size> [,<SDU error ratio> [,<Residual bit error ratio> [,<Delivery of erroneous SDUs> [,<Transfer delay> [,<Traffic handling priority>]]]]]]]]]]]] <CR> <cid> =1 <Traffic class> =2, 3 <Maximum bitrate UL> =64, 384 <Maximum bitrate DL> = See clause 8.10.1 <Guaranteed bitrate UL> Not used <Guaranteed bitrate DL> Not used <Delivery order> =0 <Maximum SDU size> =320, 640 <SDU error ratio> = "1E4" <Residual bit error ratio> = "1E5" <Delivery of erroneous SDUs> =1 <Transfer delay> Not used <Traffic handling priority> =3	Quality of Service Profile (Requested), 3GPP TS 27.007 [23], clause 10.1.4
CMGD	AT+CMGD=001<CR> AT+CMGD=1,4<CR>	Delete Message, 3GPP TS 27.005 [22], clause 3.5.4
CMGF	AT+CMGF=1<CR>	Message Format, 3GPP TS 27.005 [22], clause 3.2.3
CPMS	AT+CPMS="SM","SM","MT"<CR> AT+CPMS="CB","CB","CB"<CR>	Preferred Message Storage, 3GPP TS 27.005 [22], clause 3.2.2
CSCS	AT+CSCS="GSM"<CR>	Select TE character set, 3GPP TS 27.007 [23], clause 5.5
CSMS	AT+CSMS=0<CR>	Select Message Service, 3GPP TS 27.005 [22], clause 3.2.1

8.8.1.8 AT commands for E-DCH testing (Rel-6 or later) and HS-ENH testing (Rel-7 or later)

Command	Syntax in TTCN	Comments
CGEQREQ	AT+CGEQREQ=[<cid> [,<Traffic class> [,<Maximum bitrate UL> [,<Maximum bitrate DL> [,<Guaranteed bitrate UL> [,<Guaranteed bitrate DL> [,<Delivery order> [,<Maximum SDU size> [,<SDU error ratio> [,<Residual bit error ratio> [,<Delivery of erroneous SDUs> [,<Transfer delay> [,<Traffic handling priority>]]]]]]]]]]]] <CR> <cid> =1 <Traffic class> =2, 3 <Maximum bitrate UL> = See clause 8.10.2 <Maximum bitrate DL> = See clause 8.10.1 <Guaranteed bitrate UL> Not used <Guaranteed bitrate DL> Not used <Delivery order> =0 <Maximum SDU size> =320, 640 <SDU error ratio> = "1E4" <Residual bit error ratio> ="1E5" <Delivery of erroneous SDUs> =1 <Transfer delay> Not used <Traffic handling priority> =3	Quality of Service Profile (Requested), 3GPP TS 27.007 [23], clause 10.1.4
CMGD	AT+CMGD=001<CR> AT+CMGD=1,4<CR>	Delete Message, 3GPP TS 27.005 [22], clause 3.5.4
CMGF	AT+CMGF=1<CR>	Message Format, 3GPP TS 27.005 [22], clause 3.2.3
CPMS	AT+CPMS="SM","SM","MT"<CR> AT+CPMS="CB","CB","CB"<CR>	Preferred Message Storage, 3GPP TS 27.005 [22], clause 3.2.2
CSCS	AT+CSCS="GSM"<CR>	Select TE character set, 3GPP TS 27.007 [23], clause 5.5
CSMS	AT+CSMS=0<CR>	Select Message Service, 3GPP TS 27.005 [22], clause 3.2.1
COPN	AT+COPN=?<CR>	Read operator names +COPN TS 27.007 clause 7.21

8.8.2 AT Command Handling in TTCN

8.8.2.1 AT Command Interface

The AT Command Interface resides between the UE and the System Simulator (SS). The implementation of AT commands in the UE is optional[3]. It is agreed, however, that it is the responsibility of the SS - not the ATS - to map AT commands onto appropriate MMI commands. This means that the ATSSs issue AT commands which have to be mapped appropriately and forwarded to the UE, and vice versa.

The ATSSs have been implemented in such a way that AT commands are to be answered immediately. This means that the TTCN expects the answers right away and progresses only afterwards. As a consequence only positive AT responses are assumed.

There is only one exception from the rule of immediate answering: the CGACT command. For this command the TTCN does not expect an immediate AT response. Once the CGACT command has been issued a subsequent UE behaviour is expected. The AT response is issued by the UE only after execution of the AT command, and it will only then be accounted for by the ATSSs.

8.8.2.2 AT Command Dialogues

In some cases AT commands trigger a dialogue between the AT command interface and the UE. An example used in the SMS ATS is the CMGW command.

```
EXAMPLE:  AT+CMGW="9501231234" (write message)
          > This is the message body^Z
          +CMGW: 7             (index number in storage returned)
          OK
```

A special character (^Z) marks the end of the dialogue.

The ATs generate information to be sent to the UE as one block. If the command mapping function cannot proceed with the dialogue that way, it has to divide the received block into the appropriate pieces prior to forwarding them.

8.8.2.3 AT Response Types

The term 'response type' shall allow a distinction between different types of contents to answer upon an AT command issued by the TTCN.

8.8.2.3.1 'OK' Response

Most AT commands are to be answered with 'OK'. All exceptions are according to 3GPP TS 27.007 [23], for example +CGDATA is to be answered with 'CONNECT'.

8.8.2.3.2 Name String

There are a number of AT commands which, in the positive case, trigger an answer string from UEs. Such strings start with the command which is being answered.

```
EXAMPLE:  AT+CPMS?                (check memory settings)
          +CPMS: "ME",4,10,"ME",4,10,"ME",4,10
          OK
```

The implementation of this type of AT commands is such that the TTCN expects and checks the beginning of the response string. This would (later) facilitate possible direct connections between SS and UE.

8.8.2.3.3 Error strings

There are situations when the UE cannot react positively upon an AT command. Different types of reactions are foreseen. The strings 'ERROR' or 'CMS ERROR: <err>' may be issued by UEs.

"...subparameter values of a command are not accepted by the TA (or command itself is invalid, or command cannot be performed for some reason), result code <CR><LF>ERROR<CR><LF> is sent to the TE and no subsequent commands in the command line are processed."

"Final result code +CMS ERROR: <err> indicates an error related to mobile equipment or network. The operation is similar to ERROR result code. None of the following commands in the same command line is executed. Neither ERROR nor OK result code shall be returned. ERROR is returned normally when error is related to syntax or invalid parameters."

The chosen way of realization prevents, in general, that error strings generated by the UE are passed to the SS. This holds for both intended and unintended errors (from the tester perspective).

8.8.2.4 AT Command Parameters And Options

Many AT commands take parameters some of which are optional. Thus, there is a degree of freedom left to the UEs. This freedom is widely used in the AT commands used in the SMS ATS. To allow flexible parameterization PIXIT items can be used to set the parameters as understood by the UEs.

An example of such parameters are the preferred memories to be used when testing.

8.9 Bit padding

Three different kinds of bit padding at the RRC layer are defined in 3GPP TS 25.331 [21].

If a bit string is defined in ASN.1 and is an output from a (PER) encoder, it may need the segmentation and padding. One example is that each SIB message is PER-encoded and becomes a (PER) bit-string. A long bit-string is segmented in fixed length, for example with 222 bits. The (1 ... 7) padding bits shall be added at the last segment if it's length is between 215 and 211.

No bit padding shall be generated by the PER encoder. Contrary to ITU-T Recommendation X.691 [28], the unaligned PER encoder shall not generate any padding bit to achieve octet alignment at the end of a PER bit string.

RRC padding. The RRC padding bits shall be generated after PER encoder. If the PER bit strings are exchanged via AM or UM SAP, the (1 ... 7) padding bits shall be added to ensure the octet alignment. If the PER bit strings are exchanged via TR SAP, before the exchanges, RRC shall select the smallest transport format that fits the RRC PDU and shall add the lowest number of padding bits required to fit the size specified for the selected transport format. The RRC padding bits shall be taken into account at the calculation of the integrity checksum.

8.9.1 Requirements for implementation

The different kinds of bit padding occur at the different places in the testing architecture. Care must be taken, in order to ensure the correct implementation.

The bit padding for the embedded bit string in ASN.1 shall be resolved in TTCN. It is under the responsibility of the TTCN writer. Several TSO defined can resolve the necessary bit padding in the downlink direction.

The unaligned PER encoder used for TTCN shall not implement the octet alignment at the end of a PER bit string in the downlink direction.

The RRC padding should be implemented at the SS in the downlink direction both for AM/UM and TR modes according to 3GPP TS 25.331 [21], clause 12.1.3.

The SS PER decoder has no need to distinguish the extension and padding parts in the UL direction, and shall match and accept RRC PDUs with any bit string in the extension and padding parts. The remaining part of the received bit string shall be discarded regardless of the RLC mode.

8.10 Test PDP contexts

Table 8.10.1 defines test PDP contexts used in the generic procedures for the PS establishment and other SM tests. The test PDP contextDch1 is the default Test PDP context used in the test cases where no particular Test PDP contexts are specified and UE is in DCH state. The test PDP contextFach is the default Test PDP context used in the test cases where no particular Test PDP contexts are specified and UE is in FACH state.

Table 8.10.1: Test PDP contexts

	PDP ContextDch	PDP ContextDchForLTE	PDP ContextFach
NSAPI	Selected by UE in Activate PDP Context Request	Selected by UE in Activate PDP Context Request	Selected by UE in Activate PDP Context Request
LLC SAPI	0	0	0
QoS	QoSDch-UL64kAM-DL64kAM	QoSDch-UL128kAM-DL128kAM	QoSFach- UL32kAM-DL32kAM
PDP address	PIXIT	PIXIT	PIXIT
Radio Priority	1	1	1
Access Point Name	tsc_AccessPtNameDCH "ABCDEF"	tsc_AccessPtNameDCH "ABCDEF"	tsc_AccessPtNameFACH "GHIJK"
Protocol configuration options	-	-	-
Packet Flow Identifier	Best Effort	Best Effort	Best Effort

Table 8.10.2: Test QoS

	QoS Dch-UL64kAM-DL64kAM	QoS Dch-UL128kAM-DL128kAM	QoS Facch- UL32kAM-DL32kAM
Reliability class	'011'B Unacknowledged GTP, LLC, and acknowledged RLC; Protected data	'101'B Unacknowledged GTP, LLC, and unacknowledged RLC; Unprotected data	'011'B Unacknowledged GTP, LLC, and acknowledged RLC; Protected data
Delay class	'011'B / '100'B 3 / 4 (Best effort)	'100'B 4 (Best effort)	'011'B / '100'B 3 / 4 (Best effort)
Precedence class	UL:'000'B, Subscribed DL:'011'B Class 3	UL:'000'B, Subscribed DL:'010'B Class 2	UL:'000'B, Subscribed DL:'011'B Class 3
Peak throughput	'0100'B 8 000 Octets/s	'0101'B 16 000 Octets/s	'0011' Up to 4 000 octet/s
Mean throughput	'11111'B Best Effort	'11111'B Best Effort	'11111'B Best Effort
Priority of erroneous SDU	'010' B Erroneous SDUs are delivered ('yes')	'010' B Erroneous SDUs are delivered ('yes')	'010' B Erroneous SDUs are delivered ('yes')
Delivery order	'10'B Without delivery order ('no')	'10'B With delivery order ('no')	'10'B Without delivery order ('no')
Traffic class	'011' B / '100'B Interactive / Background	'100'B Background	'011' B / '100'B Interactive / Background
Maximum SDU size	'20' O 320 bits]	'96' O 1500 octets	'20'O 320 bits
Maximum bit rate for uplink	'40' O 64 kbps	'48' O 128 kbps	'20'O 32 kbps
Maximum bit rate for downlink	'40' O 64 kbps	'48' O 128 kbps	'20'O 32 kbps
Residual BER	'0111' 1X10E-5	'0100' 4X10E-3	'0111' 1X10E-5
SDU error ratio	'0100'B 1X10E-4	'0011'B 1X10E-3	'0100'B 1X10E-4
Traffic Handling priority	UL: '00'B for Interactive, Any for Background DL: '11' B (for Interactive, for Background to be neglected by UE)	Any for Background DL: '00' B (to be neglected by UE)	UL: '00'B for Interactive, Any for Background DL: '11' B (for Interactive, for Background to be neglected by UE)
Transfer delay	UL: Any DL: '111111' B spare (not applicable for Interactive / Background)	UL: Any DL: '111111' B spare (not applicable for Background)	UL: Any DL: '111111' B spare (not applicable for Interactive / Background)
Guaranteed bit rate for uplink	UL: Any DL: '10' O 16 kbps	UL: Any DL: '10' O 16 kbps	UL: Any DL: '10'O 32 kbps
Guaranteed bit rate for downlink	UL: Any DL: '10' O 16 kbps	UL: Any DL: '10' O 16 kbps	UL: Any DL: '10'O 16 kbps

:: Residual BER 1X10E-5 corresponds to CRC 16.

8.10.1 Mapping of Quality of service and AT command for HSPA DL testing

Table 8.10.1.1 defines the encoding of the Maximum bit rate for downlink IE in QoS and the corresponding encoding in the AT command.

Table 8.10.1.1: Test QoS in HSPA DL test cases (Rel-5 or later)

UE HS-DSCH Category	Min inter-TTI interval (TTI=2ms)	Max number of bits of an HS-DSCH TB received within an HS-DSCH TTI (see note 1)	Max number of MAC-d PDUs in a single MAC-hs PDU with RLC payload size 640 bits (see note 2)	Max bit rate (kbps)	Max bit rate for DL QoS (Octetstring)	AT command for Max bit rate of DL QoS (IA5string)
1, 2	3	7298	11	1173	89	1152
3, 4	2	7298	11	1760	92	1728
5, 6	1	7298	11	3520	AE	3520
7, 8	1	14411	21	6720	E0	6720
9	1	20251	30	9600	FE (octet 9) 0A (octet 15)	9600
10	1	27952	42	13440	FE (octet 9) 30 (octet 15)	13400
11	2	3630	5	800	83	768
12	1	3630	5	1600	90	1600
13, 17(64QAM)	1	34800	53	16960	FE (octet 9) 4A (octet 15)	16000
14, 18(64QAM)	1	42196	64	20480	FE (octet 9) 4E (octet 15)	20000
15	1	23370	35	11200	FE (octet 9) 1A (octet 15)	11200
16	1	27952	42	13440	FE (octet 9) 30 (octet 15)	13400
17(MIMO) (see note 3)	1	23370	70	22400	FE (octet 9) 50 (octet 15)	22000
18(MIMO) (see note 3)	1	27952	84	26880	FE (octet 9) 54 (octet 15)	26000
19	1	35280	53	16960	FE (octet 9) 4a (octet 15)	16000
20	1	42192	64	20480	FE (octet 9) 4E (octet 15)	20000
19(MIMO) (see note 3)	1	35280	106	33920	FE (octet 9) 5B (octet 15)	33000
20(MIMO) (see note 3)	1	42192	128	40960	FE (octet 9) 62 (octet 15)	40000
21(DC- HSDPA) (see note 3)	1	23370	70	22400	FE (octet 9) 50 (octet 15)	22000
22(DC- HSDPA) (see note 3)	1	27952	84	26880	FE (octet 9) 54 (octet 15)	26000
23(DC- HSDPA) (see note 3)	1	35280	106	33920	FE (octet 9) 5B (octet 15)	33000
24(DC- HSDPA) (see note 3)	1	42192	128	40960	FE (octet 9) 62 (octet 15)	40000

25 (NOTE 4)	1	23370	140	44800	FE (octet 9) 66 (octet 15)	44000
26 (NOTE 4)	1	27952	168	53760	FE (octet 9) 6F (octet 15)	53000
27 (NOTE 4)	1	35280	212	67840	FE (octet 9) 7D (octet 15)	67000
28 (NOTE 4)	1	42192	256	81920	FE (octet 9) 8B (octet 15)	81000

NOTE 1: Refer to 3GPP TS 25.306 [16a] Table 5.1a.

NOTE 2: The maximum number of single-sized MAC-d PDUs in a single MAC-hs PDU is calculated with the formula:

- **Max number MAC-d PDU = DIV ((MAX TB size - MAC-hs header fixed part), MAC-d PDU size)**
- where MAC-d PDU size = 640 + 16 = 656
- MAC-hs header fixed part = Length of MAC-hs fixed header (VF + Queue Id + TSN) + Length of MAC-hs flexible header (SID + N + F) = 21 bits

Example of calculation for category 1:

Max number MAC-d PDU = DIV((7298-21) , 656) = 11

NOTE 3: Example of calculation for MIMO or DC-HSDPA:

When MIMO or dual cell operation is configured, this parameter defines the maximum number of bits that the UE is capable of receiving per transport block per HS-DSCH.

The maximum number of single-sized MAC-d PDUs in a single MAC-ehs PDU is calculated with the formula:

- **Max number MAC-d PDU = DIV ((MAX TB size - MAC-ehs header fixed part), MAC-d PDU size) * 2**
- where MAC-d PDU size = 640 + 16 = 656
- MAC-ehs header fixed part = Length of one MAC-ehs fixed header (LCH-ID + L + TSN + SI + F) = 24 bits

Example of calculation for category 17:

Max number MAC-d PDU = DIV((23370-24) , 656)*2 = 70

NOTE 4: Example of calculation for combined DC-HSDPA and MIMO:

When DC-HSDPA and MIMO is configured, this parameter defines the maximum number of bits that the UE is capable of receiving per transport block per HS-DSCH.

The maximum number of single-sized MAC-d PDUs in a single MAC-ehs PDU is calculated with the formula:

- **Max number MAC-d PDU = DIV ((MAX TB size - MAC-ehs header fixed part), MAC-d PDU size) * 4**
- where MAC-d PDU size = 640 + 16 = 656
- MAC-ehs header fixed part = Length of one MAC-ehs fixed header (LCH-ID + L + extended TSN + SI + F) = 32 bits

Example of calculation for category 25:

Max number MAC-d PDU = DIV((23370-32) , 656)*4 = 140

8.10.1a Mapping of Quality of service and AT command for LCR TDD HSPA DL testing

Table 8.10.1a defines the encoding of the Maximum bit rate for downlink IE in QoS and the corresponding encoding in the AT command for LCR TDD.

Table 8.10.1a: Test QoS in HSPA DL test cases for LCR TDD (Rel-5 or later)

UE HS-DSCH Category	Max number of bits of an HS-DSCH TB received within an HS-DSCH TTI (see note 1)	Max number of MAC-d PDUs in a single MAC-hs PDU with RLC payload size 640 bits (see note 2)	Max bit rate (kbps)	Max bit rate for DL QoS (Octetstring)	AT command for Max bit rate of DL QoS (IA5string)
1	2788	4	512	78	512
2	2788	4	512	78	512
3	2788	4	512	78	512
4	5600	8	1024	87	1024
5	5600	8	1024	87	1024
6	5600	8	1024	87	1024
7	8416	12	1536	8F	1536
8	8416	12	1536	8F	1536
9	8416	12	1536	8F	1536
10	11226	17	2176	99	2176
11	11226	17	2176	99	2176
12	11226	17	2176	99	2176
13	14043	21	2688	A1	2688

UE HS-DSCH Category	Max number of bits of an HS-DSCH TB received within an HS-DSCH TTI (see note 1)	Max number of MAC-d PDUs in a single MAC-hs PDU with RLC payload size 640 bits (see note 2)	Max bit rate (kbps)	Max bit rate for DL QoS (Octetstring)	AT command for Max bit rate of DL QoS (IA5string)
14	14043	21	2688	A1	2688
15	14043	21	2688	A1	2688
16	12636	19	2432	9D	2432
17	12636	19	2432	9D	2432
18	12636	19	2432	9D	2432
19	16856	25	3200	A9	3200
20	16856	25	3200	A9	3200
21	16856	25	3200	A9	3200
22	21076	32	4096	B7	4096
23	21076	32	4096	B7	4096
24	21076	32	4096	B7	4096
25	12636	19	2432	9D	2432
25(MIMO) (see note 3)	8416	24	3072	A7	3072
26	16856	25	3200	A9	3200
26(MIMO) (see note 3)	11226	34	4352	BB	4352
27	21076	32	4096	B7	4096
27(MIMO) (see note 3)	14043	42	5376	CB	5376
28	12636	19	2432	9D	2432
28(MIMO) (see note 3)	12636	38	4864	C3	4864
29	16856	25	3200	A9	3200
29(MIMO) (see note 3)	16856	50	6400	DB	6400
29	21076	32	4096	B7	4096
30(MIMO) (see note 3)	21076	64	8192	F7	8192

NOTE 1: Refer to 3GPP TS 25.306 [16a], Table 5.1c.

NOTE 2: The maximum number of single-sized MAC-d PDUs in a single MAC-hs PDU is calculated with the formula:
- **Max number MAC-d PDU = DIV ((MAX TB size - MAC-hs header fixed part), MAC-d PDU size),**
where
- MAC-d PDU size = 640 + 16 = 656 bits
- MAC-hs header fixed part = Length of MAC-hs fixed header (VF + Queue Id + TSN) + Length of MAC-hs flexible header (SID + N + F) = 21 bits.
Example of calculation for category 1: Max number MAC-d PDU = DIV((2788-21) , (640+16)) = 4.

NOTE 3: When MIMO operation is configured, the maximum number of single-sized MAC-d PDUs in a single MAC-ehs PDU is calculated with the formula:
- **Max number MAC-d PDU = DIV ((MAX TB size - MAC-ehs header fixed part), MAC-d PDU size) * 2**
where MAC-d PDU size = 640 + 16 = 656
MAC-ehs header fixed part = Length of one MAC-ehs fixed header (LCH-ID + L + TSN + SI + F) = 24 bits
Example calculation for category 30: Max number MAC-d PDU = DIV((21076-24) , 656)*2 = 64.

8.10.2 Mapping of Quality of service and AT command for HSPA UL testing

Table 8.10.2 defines the encoding of the Maximum bit rate for uplink IE in QoS and the corresponding encoding in the AT command.

Table 8.10.2: Test QoS in HSPA UL test cases (Rel-6 or later)

UE E-DCH Category	Max number of bits of an E-DCH TB transmitted within an E-DCH TTI (see note 1)	TTI (see note 3)	Max number of MAC-d PDUs in a single MAC-e/es or MAC-i/is PDU with RLC payload size 320 bits (see note 2)	Max bit rate (kbps)	Max bit rate for UL QoS (Octetstring)	AT command for Max bit rate of UL QoS (IA5string)
1	7110	10 ms	21	672	81	640
2	2798	2 ms	8	1280	8B	1280

2	2798	10 ms	8	256	58	256
3	14484	10 ms	43	1376	8C	1344
4	5772	2 ms	17	2720	A1	2688
4	5772	10 ms	17	544	7C	544
5	20000	10 ms	59	1888	94	1856
6	11484	2 ms	34	5440	CC	5440
6	11484	10 ms	34	1088	88	1088
7	22996	2 ms	68	10880	FE (octet 8) 16 (octet 17)	10800
7	22996	10 ms	68	2176	99	2176
8	11484	2 ms	68 (see note 4)	10880	FE (octet 8) 16 (octet 17)	10800
9	22996	2 ms	136 (see note 4)	21760	FE (octet 8) 4F (octet 17)	21000

NOTE 1: Refer to 3GPP TS 25.306 [16a], Table 5.1g.

NOTE 2: The maximum number of MAC-d PDUs in a single MAC-e PDU containing a single MAC-es PDU is calculated with the formula:

- **Max number MAC-d PDU = DIV ((MAX TB size - Length of MAC-e/es fixed header (DDI+N+TSN)), MAC-d PDU size)**

The maximum number of MAC-d PDUs in a single MAC-i PDU containing a single MAC-is PDU is calculated with the formula:

- **Max number MAC-d PDU = DIV ((MAX TB size - Length of MAC-i/is fixed header (LCH-ID, L, F, SS, TSN)), MAC-d PDU size)**

Example of calculation for category 1 with MAC-e/es:

Max number MAC-d PDU = DIV((7110 - 18), (320+16)) = 21

Example of calculation for category 1 with MAC-i/is:

Max number MAC-d PDU = DIV((7110 - 24), (320+16)) = 21

NOTE 3: TTI=2ms is preferred for the test unless specified differently in 3GPP TS 34.123-1 [1].

NOTE 4: When DC-HSUPA apply the maximum number of MAC-d PDUs in a single MAC-i PDU containing a single MAC-is PDU is calculated with the formula:

- **Max number MAC-d PDU = (DIV ((MAX TB size - Length of MAC-i/is fixed header (LCH-ID, L, F, SS, extended TSN)), MAC-d PDU size))*2**

Example of calculation for category 8:

Max number MAC-d PDU = DIV((7110 - 32), (320+16)) *2= 68

8.10.2a Mapping of Quality of service and AT command for LCR TDD HSPA UL testing

Table 8.10.2a defines the encoding of the Maximum bit rate for uplink IE in QoS and the corresponding encoding in the AT command.

Table 8.10.2a: Test QoS in HSPA UL LCR TDD test cases (Rel-6 or later)

UE E-DCH Category	Max number of bits of an E-DCH TB transmitted within an E-DCH TTI (see note 1)	Max number of MAC-d PDUs in a single MAC-e/es PDU with RLC payload size 320 bits (see note 2)	Max bit rate (kbps)	Max bit rate for UL QoS (Octetstring)	AT command for Max bit rate of UL QoS (IA5string)
1	2754	8	512	78	512
2	4162	12	768	83	768
3	5532	16	1024	87	1024
4	8348	24	1536	8F	1536
5	11160	33	2112	98	2112
6	11160	33	2112	98	2112

NOTE 1: See 3GPP TS 25.306 [16a], Table 5.1m.

NOTE 2: The maximum number of MAC-d PDUs in a single MAC-e PDU containing a single MAC-es PDU is calculated with the formula:

- **Max number MAC-d PDU = DIV ((MAX TB size - Length of MAC-e/es fixed header), MAC-d PDU size)**

where, MAC-d PDU size = 320 + 16 = 336 bits

- Length of MAC-e/es fixed header = DDI+N+TSN = 18 bits

Example of calculation for category 1: Max number MAC-d PDU = DIV((2754 - 18), (336)) = 8.

8.10.3 Peak Throughput Class for HSPA testing

Table 8.10.3 defines the value of the Peak Throughput Class.

Table 8.10.3: Value of the Peak Throughput Class

E-DCH category	1	2	3	4	5	6	7
HS-DSCH category							
1	8	8	8	9	8	9	9
2	8	8	8	9	8	9	9
3	8	8	8	9	8	9	9
4	8	8	8	9	8	9	9
5	9	9	9	9	9	9	9
6	9	9	9	9	9	9	9
7	9	9	9	9	9	9	9
8	9	9	9	9	9	9	9
9	9	9	9	9	9	9	9
10	9	9	9	9	9	9	9
11	7	8	8	9	8	9	9
12	8	8	8	9	8	9	9
13	9	9	9	9	9	9	9
14	9	9	9	9	9	9	9
15	9	9	9	9	9	9	9
16	9	9	9	9	9	9	9
17	9	9	9	9	9	9	9
18	9	9	9	9	9	9	9
19	9	9	9	9	9	9	9
20	9	9	9	9	9	9	9
21	9	9	9	9	9	9	9
22	9	9	9	9	9	9	9
23	9	9	9	9	9	9	9
24	9	9	9	9	9	9	9

8.11 DCH-DSCH Configurations

1. Configure PDSCH physical channel

```
CPHY_RL_Setup_REQ(
    physicalChannelIdentity,
    pDSCHInfo)
```

-- set up the scrambling code and transmission power level for the PDSCH identified by PhysicalChannelIdentity, and establishes the mapping between the spreading factor (and channelization codes) used for the PDSCH and TFCI(field2) transmitted in associated PDCH

2. Configure DSCH transport channels

```
CPHY_TrCH_Config_REQ(
    physicalChannelIdentity,
    dlconnectedTrCHList,
    dlTFCS)
```

-- set up TFS for each of DSCH's carried by the PDSCH defined in step 1 and TFCS (will be presented in TFCI(field2) of PDCH configured in step 5) for the CTrCH consisting of these DSCH's

3. Configure MAC entity for DSCH

```
CMAC_Config_REQ(
    physicalChannelIdentity,
    uE_Info,
    dlconnectedTrCHList,
    dlTFCS)
```

-- set up TFS, DSCH-RNTI and TFCS (which will be presented in TFCI(field2) of PDCH configured in step 5) for DSCH's, and map logical channel to DSCH transport channel

4. Configure RLC entity for DTCHs

```

CRLC_Config_REQ(
    physicalChannelIdentity,
    rBInfo)
-- set up RLC entity on top of DTCH logical channel which is mapped onto DSCH

```

5. Configure DPCH physical channel

```

CPHY_RL_Setup_REQ(
    physicalChannelIdentity,
    dPCHInfo)

```

6. Configure DCH transport channels

```

CPHY_TrCH_Config_REQ(
    physicalChannelIdentity,
    dlconnectedTrCHList,
    dlTFCS)
-- set up TFS for each DCH carried by the DPCH defined in step 5 and TFCS (TFCI(field1 and field2))
for the CCTrCH consisting of all DCH's mapped on the DPCH.

```

7. Configure MAC entity for DCH

```

CMAC_Config_REQ(
    physicalChannelIdentity,
    dlconnectedTrCHList,
    dlTFCS)
-- set up TFS and TFCS (TFCI(field1) for DCH's, and TFCI(field2) for associated DSCH), and map
logical channel to DCH transport channel.

```

8. Configure RLC for DTCH, DCCH

```

CRLC_Config_REQ(
    physicalChannelIdentity,
    rBInfo)
-- set up RLC entity on top of DTCH and DCCH logical channels which are mapped onto DCH

```

8.11a DCH with HS-DSCH Configurations (Rel-5 or later)

1. Configure DPCH physical channel

```

CPHY_RL_Setup_REQ(
    physicalChannelIdentity,
    dPCHInfo_r5 or dPCHInfo_r6 or dPCHInfo_r7 )
-- hs_DPCCHInd is present in the dPCHInfo ( only for HS-DSCH serving cell)
-- set up the DL-DPCH associated with HS-PDSCH
-- set up the HS-DPCCH which is associated with the HS-PDSCH (this is done only for HS-DSCH serving
-- cell).

```

2. Configure DCH transport channels

```

CPHY_TrCH_Config_REQ(
    physicalChannelIdentity,
    dlconnectedTrCHList,
    dlTFCS)
-- set up TFS for each DCH carried by the DPCH defined in step 5 and TFCS for the CCTrCH consisting
of all DCH's mapped on the DPCH.

```

3. Configure MAC entity for DCH

```

CMAC_Config_REQ(
    physicalChannelIdentity,
    dlconnectedTrCHList,
    dlTFCS)
-- set up TFS and TFCS for DCH's, and map logical channel to DCH transport channel.

```

4. Configure RLC for DCCH

```

CRLC_Config_REQ(
    rB_Identity,
    rBInfo)
-- set up RLC entity on top of DCCH logical channels which are mapped onto DCH

```

5. Configure HS-PDSCH physical channel

```

CPHY_RL_Setup_REQ(
    physicalChannelIdentity,
    hs_PDSCHInfo (r5 or r6 or r7[dedicated]))
-- set up the HS-PDSCH identified by PhysicalChannelIdentity
-- for the HS-PDSCH the configurable parameters are: the scrambling code, and
-- set up the HS-SCCH which is associated with the HS-PDSCH without physicalChannelIdentity
-- for the HS-SCCH the configurable parameters are: channelisation code set and H-RNTI
    hSDSCHPhysicalLayerCategory      HSDSCH_physical_layer_category,
hsdsch_physical_layer_category_ext  HSDSCH_physical_layer_category_ext,
-- needed when MAC-ehs is configured
    h_RNTI                            H_RNTI,          dlHSPDSCHInformation
DL_HSPDSCH_Information,
    ackNackRepetitionFactor           ACK_NACK_repetitionFactor,
    sttd_Indicator                    BOOLEAN,
    hs_SCCH_TxPower                   DL_TxPower,
    mimo_Parameters                    MIMO_Parameters
-- optionally present when MIMO is configured.

```

6. Configure HS-DSCH transport channels

6.a Associated with MAC-hs

```

CPHY_TrCH_Config_REQ(
    physicalChannelIdentity,
    hsDSCHMacdFlows)
-- set up the HS-DSCH transport channel which carries MAC_d flows identified by Mac_dFlowId
in the hsDSCHMacdFlows.
-- for each MAC_d flow the number of process queues of the MAC-d flow and their queue identities
are configurable;
-- for each MACHsQueue the configurable parameters are: machsQueueId; priority;
mac_hsPduSizeInfoList; reorderingReleaseTimer, discardTimer and the MAC-dFlow identity to which
this MACHsQueue belongs.
-- mimoStatus is set to TRUE if MIMO is configured.

```

6.b Associated with MAC-ehs [Rel-7 or later]

```

CPHY_TrCH_Config_REQ(
    physicalChannelIdentity,
    ehs_DSCH_Flows])
-- set up the HS-DSCH transport channel MAC-ehs Queues flows identified by mac_ehs_QueueId
in the EHS_DSCH_Flows.
-- for each MAC-ehsQueue the configurable parameters are: mac_ehs_QueueId;
reorderingReleaseTimerT1; mac_ehsWindowSize;
-- the number of harq process is configurable
-- mimoStatus is set to TRUE if MIMO is configured.

```

7. Configure MAC-hs/MAC-ehs entity for HS-DSCH

```

CMAC_MACHs_MACehs_TFRCconfigure_REQ(
    explicit TRFC config mode with:
        modulationScheme,
        channelisationCodeOffset,
        noOfChannelisationCodes,
        tbSizeIndexOnHS_SCCH,
        minimumInterTTIinterval,
        redundancyVersion,
        hs_PDSCH_TxPower)

Or if MIMO is configured :
    explicit_MIMMO mode [ if MIMO is configured] with:
        modulationSchemeAndNumTB,
        channelisationCodeOffset,
        noOfChannelisationCodes,
        precodingWeight2,
        primaryTB_SizeIndexOnHS_SCCH,
        secondaryTB_SizeIndexOnHS_SCCH,
        --present only if second TB is to be tx as per modulationSchemeAndNumTB
        minimumInterTTIinterval ,
        primaryRedundancyVersions,
        secondaryRedundancyVersions,
        --present only if second TB is to be tx as per modulationSchemeAndNumTB
        hs_PDSCH_TxPower
)

```

7.a MAC-hs

```

CMAC_Config_REQ(
    physicalChannelIdentity,
    uE_Info,
    hsDSCHMacdFlows)
-- the hsDSCHMacdFlows shall be same as that used in CPHY_TrCH_Config_REQ.
-- set up MAC_d flows identified by Mac_dFlowId in the hsDSCHMacdFlows.
-- for each MAC_d flow the number of process queues of the MAC-d flow and their queue identities
are configurable;
-- for each MACHsQueue the configurable parameters are: machsQueueId; priority;
mac_hsPduSizeInfoList; reorderingReleaseTimer, discardTimer and the MAC-dFlow identity to which
this MACHsQueue belongs.
-- set up the mapping between each MAC_d flow and the logical channels which mapped on the flow.
-- MAC-hs entity is created per cell. In case of Intra Node B Handover this entity at the UE will
not be reset whereas in the TTCN it will be released in the first cell and setup in the second
cell. As no data is sent on HS-DSCH, this implementation will not affect the signalling, as
signalling is transmitted through the associated DPCH channel.
-- mimoStatus is set to TRUE if MIMO is configured.

```

7.b MAC-ehs [Rel-7 or later]

```

CMAC_Config_REQ(
    physicalChannelIdentity,
    uE_Info,
    ehs_DSCH_Flows)
-- the ehs_DSCH_Flows shall be same as that used in CPHY_TrCH_Config_REQ.
-- set up ehs-DSCH flows identified by mac_ehs_QueueId in the hsDSCHMacdFlows.
-- set up the mapping between each mac-ehs flow and the logical channels which mapped on the flow.
-- MAC-ehs entity is created per cell. In case of Intra Node B Handover this entity at the UE will
not be reset whereas in the TTCN it will be released in the first cell and setup in the second cell.
As no data is sent on HS-DSCH, this implementation will not affect the signalling, as signalling is
transmitted through the associated DPCH channel.
-- mimoStatus is set to TRUE if MIMO is configured.

```

8. Configure RLC entity for DTCHs which is mapped on HS-DSCH

```

CRLC_Config_REQ(
    rB_Identity,
    rBInfo)
-- set up RLC entity on top of DTCH logical channel which is mapped onto MAC_d/MAC-ehs flow

```

9. MAC-hs/MAC-ehs reset, release of SS resources for HSDPA

```

MAC-hs/MAC-ehs reset:
    CMAC_MACHs_MACehs_Reset_REQ(
        cellId)

RL release:
    CPHY_RL_Release_REQ(
        cellId, phyChId)
-- phyChId is the identity of HS-PDSCH physical channel or the associated DPCH channel
-- the HS-SCCH physical channel shall be also released when HS-PDSCH is released
-- the HS-DPCCH physical channel shall be released when the associated DPCH is released

TrCH release:
    CPHY_TrCH_Release_REQ(
        cellId, phyChId)
-- phyChId is the identity of HS-PDSCH physical channel

MAC-hs/MAC-ehs release:
    CMAC_Config_REQ(
        cellId, phyChId)
-- phyChId is the identity of HS-PDSCH physical channel

RLC release:
    CRLC_Config_REQ(
        cellId, rbId)
-- rbId is the identity of the radio bearer providing HSDPA service

```

8.11aa HS-DSCH Configurations without DCH associated (Rel-6 or later)

1. Configure F-DPCH physical channel

```

CPHY_RL_Setup_REQ(

```

```

    physicalChannelIdentity,
    dPCHInfo_r6 or dPCHInfo_r7 )
-- hs_DPCCHInd is present in the dPCHInfo (only for HS-DSCH serving cell)
-- set up the DL-FDPCH associated with HS-PDSCH
-- set up the HS-DPCCH which is associated with the HS-PDSCH (this is done only for HS-DSCH serving
-- cell).

```

2. Configure HS-PDSCH physical channel

```

CPHY_RL_Setup_REQ(
    physicalChannelIdentity,
    hs_PDSCHInfo (r5 or r6 or r7[dedicated]))
-- set up the HS-PDSCH identified by PhysicalChannelIdentity
-- for the HS-PDSCH the configurable parameters are: the scrambling code, and
-- set up the HS-SCCH which is associated with the HS-PDSCH without physicalChannelIdentity
-- for the HS-SCCH the configurable parameters are: channelisation code set and H-RNTI
    hSDSCHPhysicalLayerCategory      HSDSCH_physical_layer_category,
    hsdSCH_physical_layer_category_ext HSDSCH_physical_layer_category_ext,
    -- needed when MAC-ehs is configured
    h_RNTI                            H_RNTI,
    dlHSPDSCHInformation              DL_HSPDSCH_Information,
    ackNackRepetitionFactor           ACK_NACK_repetitionFactor,
    sttd_Indicator                    BOOLEAN,
    hs_SCCH_TxPower                   DL_TxPower,
    hs_scch_LessInfo                  HS_SCCH_LessInfo_r7
    -- if hs-scch less operation[Rel-7] is enabled. Conditional to no DCH configured
    -- in UL as well.
    mimo_Parameters                   MIMO_Parameters_r7
    -- optionally present when MIMO is configured.
    -- mimo and HS-SCCH cannot be simultaneously configured.

```

6. Configure HS-DSCH transport channels

6.a Associated with MAC-hs

```

CPHY_TrCH_Config_REQ(
    physicalChannelIdentity,
    hsDSCHMacdFlows)
-- set up the HS-DSCH transport channel which carries MAC_d flows identified by Mac_dFlowId
-- in the hsDSCHMacdFlows.
-- for each MAC_d flow the number of process queues of the MAC-d flow and their queue identities
-- are configurable;
-- for each MAChsQueue the configurable parameters are: machsQueueId; priority;
-- mac_hsPduSizeInfoList; reorderingReleaseTimer, discardTimer and the MAC-dFlow identity to which
-- this MAChsQueue belongs.
-- mimoStatus is set to TRUE if MIMO is configured.

```

6.b Associated with MAC-ehs [Rel-7 or later]

```

CPHY_TrCH_Config_REQ(
    physicalChannelIdentity,
    ehs_DSCH_Flows)
-- set up the HS-DSCH transport channel MAC-ehs Queues flows identified by mac_ehs_QueueId
-- in the EHS_DSCH_Flows.
-- for each MAC-ehsQueue the configurable parameters are: mac_ehs_QueueId;
-- ReorderingReleaseTimerT1; mac_ehsWindowSize;
-- the number of harq process is configurable
-- mimoStatus is set to TRUE if MIMO is configured.

```

7. Configure MAC-hs/MAC-ehs entity for HS-DSCH

If HS-SCCH less operation is not used:

```

CMAC_MAChs_MACehs_TFRConfigure_REQ(
    explicit TRFC config mode with:
    modulationScheme,
    channelisationCodeOffset,
    noOfChannelisationCodes,
    tbSizeIndexOnHS_SCCH,
    minimumInterTTIInterval,
    redundancyVersion,
    hs_PDSCH_TxPower)

```

Or if MIMO is configured :

```
explicit_MIMMO mode [if MIMO is configured] with:
  modulationSchemeAndNumTB,
  channelisationCodeOffset,
  noOfChannelisationCodes,
  precodingWeight2,
  primaryTB_SizeIndexOnHS_SCCH,
  secondaryTB_SizeIndexOnHS_SCCH,
  --present only if second TB is to be tx as per modulationSchemeAndNumTB
  minimumInterTTIinterval ,
  primaryRedundancyVersions,
  secondaryRedundancyVersions,
  --present only if second TB is to be tx as per modulationSchemeAndNumTB
  hs_PDSCH_TxPower
```

If HS-SCCH less operation is used [Rel-7 or later]:

```
CMAC_MAChs_MAC-ehs_TFRCconfigure_REQ(
  hs_scch_LessInfo mode with:
    modulationScheme,
    channelisationCodeOffset,
    noOfChannelisationCodes,
    tbSizeIndexOnHS_SCCH,
    minimumInterTTIinterval,
    redundancyVersion,
    hs_PDSCH_TxPower)
```

7.a MAC-hs

```
CMAC_Config_REQ(
  physicalChannelIdentity,
  uE_Info,
  hsDSCHMacdFlows)
-- the hsDSCHMacdFlows shall be same as that used in CPHY_TrCH_Config_REQ.
-- set up MAC_d flows identified by Mac_dFlowId in the hsDSCHMacdFlows.
-- for each MAC_d flow the number of process queues of the MAC-d flow and their queue identities
  are configurable;
-- for each MAChsQueue the configurable parameters are: machsQueueId; priority;
  mac_hsPduSizeInfoList; reorderingReleaseTimer, discardTimer and the MAC-dFlow identity to which
  this MAChsQueue belongs.
-- set up the mapping between each MAC_d flow and the logical channels which mapped on the flow.
-- MAC-hs entity is created per cell. In case of Intra Node B Handover this entity at the UE will
  not be reset whereas in the TTCN it will be released in the first cell and setup in the second
  cell. As no data is sent on HS-DSCH, this implementation will not affect the signalling, as
  signalling is transmitted through the associated DPCH channel.
-- mimoStatus is set to TRUE if MIMO is configured.
```

7.b MAC-ehs [Rel-7 or later]

```
CMAC_Config_REQ(
  physicalChannelIdentity,
  uE_Info,
  ehs_DSCH_Flows)
-- the ehs_DSCH_Flows shall be same as that used in CPHY_TrCH_Config_REQ.
-- set up ehs-DSCH flows identified by mac_ehs_QueueId in the hsDSCHMacdFlows.
-- set up the mapping between each mac-ehs flow and the logical channels which mapped on the flow.
-- MAC_ehs entity is created per cell. In case of Intra Node B Handover this entity at the UE will
  not be reset whereas in the TTCN it will be released in the first cell and setup in the second cell.
  As no data is sent on HS-DSCH, this implementation will not affect the signalling, as signalling is
  transmitted through the associated DPCH channel.
-- mimoStatus is set to TRUE if MIMO is configured.
```

8. Configure RLC entity for DTCHs and/or DCCHs (if not already configured) which is mapped on HS-DSCH

```
CRLC_Config_REQ(
  rB_Identity,
  rBInfo)
-- set up RLC entity on top of DTCH/DCCH logical channel which is mapped onto MAC-d/mac-ehsQueue
```

9. MAC-hs/MAC-ehs reset, release of SS resources for HSDPA

```
MAC-hs/MAC-ehs reset:
  CMAC_MAChs_MACehs_Reset_REQ(
    cellId)
```

```

RL release:
    CPHY_RL_Release_REQ(
        cellId, phyChId)
-- phyChId is the identity of HS-PDSCH physical channel or the associated DPCH channel
-- the HS-SCCH physical channel shall be also released when HS-PDSCH is released
-- the HS-DPCCH physical channel shall be released when the associated DPCH is released

TrCH release:
    CPHY_TrCH_Release_REQ(
        cellId, phyChId)
-- phyChId is the identity of HS-PDSCH physical channel

MAC-hs/MAC-ehs release:
    CMAC_Config_REQ(
        cellId, phyChId)
-- phyChId is the identity of HS-PDSCH physical channel

RLC release:
    CRLC_Config_REQ(
        cellId, rbId)
-- rbId is the identity of the radio bearer providing HSDPA service

```

8.11b HS-DSCH Configuration Verification

In most HSDPA test cases although the HSDPA channels (HS-SCCH, HS-PDSCH, HS-DSCH & HS-DPCCH) are set up and reconfigured using RRC peer messages, no data is sent on HS-DSCH and all the signalling is transmitted through the associated DPCH physical channel.

In order to ensure that the HS-DPCCH channel has been configured, the SS shall, upon request, forward one CQI report to the TTCN.

8.11c HS-DSCH Configurations for enhanced Cell FACH (Rel-7 or later) [Mapping CCCH/BCCH/PCCH on HS-DSCH]

1. Configure HS-PDSCH physical channel

```

CPHY_RL_Setup_REQ(
    physicalChannelIdentity,
    Common_HS_PDSCH_Info)
-- set up the HS-PDSCH identified by PhysicalChannelIdentity
-- for the HS-PDSCH the configurable parameters are: the scrambling code, and
-- set up the HS-SCCH which is associated with the HS-PDSCH without physicalChannelIdentity
-- for the HS-SCCH the configurable parameters are: channelisation code set and common/dedicated H-
RNTI selected by/allocated to UE
    hSDSCHPhysicalLayerCategory      HSDSCH_physical_layer_category,
    hs_DSCH_64QAM_Support             BOOLEAN,
    -- needed only if 64QAM[Rel-7] is supported [Cat 13 and 14]
    commonOrDedicated_H_RNTI         H_RNTI,
    bcchSpecific_H_RNTI              H_RNTI,
    hs_scch_SystemInfo               HS_SCCH_SystemInfo,
    hs_dsch_PagingSystemInformation  HS_DSCH_PagingSystemInformation,
    sttd_Indicator                   BOOLEAN,
    hs_scch_TxPower                   DL_TxPower      -- offset related to CPICH
    hs_scch_LessInfo                 HS_SCCH_LessInfo_r7
    -- if hs-scch less operation[Rel-7] is enabled. Conditional to no DCH configured
    in UL as well.
    mimo_Parameters                   MIMO_Parameters
    -- optionally present when MIMO is configured.
    -- mimo and HS-SCCH cannot be simultaneously configured.

```

6. Configure HS-DSCH transport channels

```

CPHY_TrCH_Config_REQ(
    physicalChannelIdentity,
    ehs_DSCH_CommonFlows)
-- set up the HS-DSCH transport channel MAC-ehs common lows identified by mac_ehs_QueueId
in the EHS_DSCH_Flows.
-- for each MAC-ehsQueue the configurable parameters are: mac_ehs_QueueId ;reorderingReleaseTimer
T1; mac_ehsWindowSize;

```

the number of harq processare is configurable

7. Configure MAC-hs/MAC-ehs entity for HS-DSCH

```
CMAC_MAChs_MACehs_TFRCconfigure_REQ(
    explicit TRFC config mode with:
        hs_pdsch_CodeIndex,
        hs_scch_LessTFI,
        hs_scch_LessSecondCodeApplicability,
        hs_PDSCH_TxPower)

CMAC_Config_REQ(
    physicalChannelIdentity,
    uE_Info,
    ehs_DSCH_CommonFlows)
-- the ehs_DSCH_CommonFlows shall be same as that used in CPHY_TrCH_Config_REQ.
-- set up ehs-DSCH flows identified by mac_ehs_QueueId in the hsDSCHMacdFlows.
-- set up the mapping between each ehs_DSCH_CommonFlows and the logical channels which are mapped on
the flow.
-- MAC_ehs entity is created per cell. In case of Intra Node B Handover this entity at the UE will
not be reset whereas in the TTCN it will be released in the first cell and setup in the second cell.
```

8.12 Pre- and postambles for GERAN to UTRAN tests

8.12.1 Preamble for GERAN to UTRAN tests

Before running inter-RAT test cases, radio conditions should be such that the mobile has to select the cell of the intended original RAT. The following steps should be used before running GERAN to UTRAN test cases.

1. UTRAN cell is powered OFF. The default radio conditions for a suitable GERAN cell are used for the serving cell, as defined in 3GPP TS 34.108 [3], clause 6.1.7. This step is performed while the UE is still switched OFF.
2. UE is switched ON and performs registration and attach.
3. The UTRAN cell is powered ON with an RF level such that the cell is a suitable neighbour cell, using the RF conditions defined in 3GPP TS 34.108 [3], clause 6.1.5, so that the UE will not re-select the UTRAN cell.

8.12.2 Postamble for GERAN to UTRAN tests

The following procedure is used after inter-RAT handover or cell change order test cases in case the test needs to be performed multiple times in a loop.

8.12.2.1 GERAN to UTRAN handover in CS

The test cases are defined in 3GPP TS 51.010-1 [26], clause 60.

Expected sequence

Step	Direction		Message	Comments
	UE	SS		
1		<--	SECURITY MODE COMMAND	Integrity protection is activated. UTRAN security keys in CS domain derived from GERAN
2		-->	SECURITY MODE COMPLETE	
3		<--	UTRAN MOBILITY INFORMATION	RRC
4		-->	UTRAN MOBILITY INFORMATION CONFIRM	RRC
5		-->	ROUTING AREA UPDATE REQUEST	GMM - Update type = 'RA updating'. Not performed by CS only mobile.
5a		<--	SECURITY MODE COMMAND	Integrity protection is activated. UTRAN security keys in PS domain derived from GERAN
5b		-->	SECURITY MODE COMPLETE	

6	<--	ROUTING AREA UPDATE ACCEPT	GMM - P-TMSI is included
7	-->	ROUTING AREA UPDATE COMPLETE	
8			The call is terminated. SS releases the RRC connection.
9	-->	RRC CONNECTION REQUEST	RRC - establishment cause = 'registration'
10	<--	RRC CONNECTION SETUP	RRC
11	-->	RRC CONNECTION SETUP COMPLETE	RRC
12	-->	ROUTING AREA UPDATE REQUEST	CS/PS mobiles: GMM - Update type" = 'combined RA/LA updating' or 'combined RA/LA updating with ISMI Attach' Note: CS only mobiles will perform a normal LAU
13	<--	SECURITY MODE COMMAND	Integrity protection is activated.
14	-->	SECURITY MODE COMPLETE	
15	<--	ROUTING AREA UPDATE ACCEPT	P-TMSI is included
16	-->	ROUTING AREA UPDATE COMPLETE	
17			The SS releases the RRC connection.
18			UE is powered OFF

Specific message contents

UTRAN MOBILITY INFORMATION message:

Use the same message sub-type found in TS 34.108, clause 9, with the following exceptions:

Information Element	Value/remark
CN information info	
- PLMN identity	Not present
- CN domain related information	
- CN domain identity	PS
- CN domain specific NAS system information	
- GSM-MAP NAS system information	00 00H
- CN domain specific DRX cycle length coefficient	7

SECURITY MODE COMMAND message:

Use the same message sub-type found in TS 34.108, clause 9, with the following exceptions:

Information Element	Value/remark
Ciphering mode info	Not present

All remaining Specific message contents shall be referred to 34.108 clause 9 "Default Message Contents of Layer3 Messages for Layer 3 Testing".

8.12.2.2 GERAN to UTRAN cell change in PS (in PMM-CONNECTED)

These test cases are defined in 3GPP TS 51.010-1 [26], clause 42.4.7.

Expected sequence

Step	Direction		Message	Comments
	UE	SS		
1	-->		ROUTING AREA UPDATE REQUEST	GMM - Update type = 'Combined RA / LA updating' or 'combined RA/LA updating with ISMI Attach' for CS/PS mobiles, and 'RA updating' for PS only mobiles. Follow-on request is made.
2	<--		SECURITY MODE COMMAND	Integrity protection is activated, UTRAN security keys in PS domain derived from GERAN
3	-->		SECURITY MODE COMPLETE	
4	<--		ROUTING AREA UPDATE ACCEPT	GMM - P-TMSI is included
5	-->		ROUTING AREA UPDATE COMPLETE	
				SS releases the RRC connection
				UE is powered OFF.

8.12.2.3 GERAN to UTRAN DTM test cases

These test cases are defined in 3GPP TS 51.010-1 [26], clauses 41.5.1.1.1.4 and 47.3.4.

Expected sequence

Step	Direction		Message	Comments
	UE	SS		
				The SS releases the RR connection
1	-->		RRC CONNECTION REQUEST	RRC - establishment cause = 'registration'
2	<--		RRC CONNECTION SETUP	RRC
3	-->		RRC CONNECTION SETUP COMPLETE	RRC
A4	-->		ROUTING AREA UPDATE REQUEST	UE behaviour type A, if the UE is still attached: GMM - Update type = 'Combined RA / LA updating' or 'combined RA/LA updating with ISMI Attach'
A5	<--		SECURITY MODE COMMAND	Integrity protection is activated, UTRAN security keys in PS domain derived from GERAN
A6	-->		SECURITY MODE COMPLETE	
A7	<--		ROUTING AREA UPDATE ACCEPT	GMM - P-TMSI is included
A8	-->		ROUTING AREA UPDATE COMPLETE	
B4	-->		LOCATION UPDATING REQUEST	UE behaviour type B, if the UE has already detached
B5			AUTHENTICATION REQUEST	
B6			AUTHENTICATION RESPONSE	
B7	<--		SECURITY MODE COMMAND	Integrity protection is activated, UTRAN security keys in CS domain derived from GERAN
B8	-->		SECURITY MODE COMPLETE	
B8a	<--		LOCATION UPDATING ACCEPT	
B8b	-->		TMSI REALLOCATION COMPLETE	
9				SS releases the RRC connection
10				UE is powered OFF.

8.13 E-DCH configurations (Rel-6 or later)

8.13.1 DPCH (SRB) and E-DCH (RAB) configuration

8.13.1.1 Serving E-DCH cell

1. Configure DPCH physical channel

```
CPHY_RL_Setup_REQ
```

```
(
  cellId_1
  physicalChannelIdentity,
  dPCHInfo_r5OrLater
    r6 (
      ul_DPCH_Info6
    )
)
```

-- set up the UL-DPCH channel. When UL-DPCH is established, E-DPCH shall use the same scrambling code.

2. Configure DCH transport channels

```
CPHY_TrCH_Config_REQ(
```

```
  cellId_1
  physicalChannelIdentity,
  ulconnectedTrCHList,
  ulTFCS)
```

-- set up TFS for each DCH carried by the DPCH defined in step 5 and TFCS for the CCTrCH consisting of all DCH's mapped on the DPCH.

3. Configure MAC entity for DCH

```
CMAC_Config_REQ(
  physicalChannelIdentity,
  ulconnectedTrCHList,
  ulTFCS)
```

-- set up TFS and TFCS for DCH's, and map logical channel to DCH transport channel.
uE_Info

4. Configure RLC for DCCH

```
CRLC_Config_REQ(
  rB_Identity,
  rBInfo)
```

-- set up RLC entity on top of DCCH logical channels which are mapped onto DCH

5. Configure E-DCH DL physical channel CPHY_RL_Setup_REQ

```
(
  physicalChannelIdentity,
  e_AGCHInfo
    (
      e_AGCHInfo
      tti
      e_AGCH_PowerOffset
    )
)
```

-- set up the E-AGCH identified by PhysicalChannelIdentity
 -- E-AGCH channel is configured only in the serving E-DCH cell
 -- for E-AGCH the configurable parameters are

e_AGCHInfo	E_AGCH_Information
e_AGCH_PowerOffset	INTEGER (0..255)
e_RNTI_Primary	E_RNTI
e_RNTI_Secondary	E_RNTI

-- The tti value shall be the same as the associated E-DPCH

```
CPHY_RL_Setup_REQ
```

```
(
  physicalChannelIdentity,
  e_HICHInfo
    (
      e_HICHInfo
      tti
      e_HICH_PowerOffset
    )
)
```

```

    }

-- set up the E-HICH identified by PhysicalChannelIdentity
-- for E-HICH the configurable parameters are
    e_HICHInfo          E_HICH_Information
    e_HICH_PowerOffset  INTEGER (0..255)
-- The tti value shall be the same as the associated E-DPCH
-- As E-HICH is having timing dependencies with DPCH, it is configured last
    CPHY_RL_Setup_REQ
    (
        physicalChannelIdentity,
        e_RGCHInfo
        (
            e_RGCHInfo
            tti
            e_RGCH_PowerOffset
        )
    )
-- set up the E-RGCH identified by PhysicalChannelIdentity
-- for E-RGCH the configurable parameters are
    e_RGCHInfo          E_RGCH_Information
    e_RGCH_PowerOffset  INTEGER (0..255)
-- The tti value shall be the same as the associated E-DPCH

```

6. Configure E-DCH UL physical channel

```

    CPHY_RL_Setup_REQ
    (
        physicalChannelIdentity
        e_DPCHInfo
        (
            e_DPCCH_Info
            e_DPDCH_Info
            scramblingCodeType
            scramblingCode
            tti
            edch_PhysicalLayerCategory
        )
    )
-- set up the E-DCH identified by PhysicalChannelIdentity
-- for E-DPCH the configurable parameters are
    e_DPCCH_Info          E_DPCCH_Info
    e_DPDCH_Info          E_DPDCH_Info
    tti                    E_DCH_TTI
    edch_PhysicalLayerCategory  INTEGER (1..16)
-- The scramblingCodeType and scramblingCode shall be the same as for UL-DPCH

```

7. Configure E-DCH UL transport channels

```

    CPHY_TrCH_Config_REQ (
        physicalChannelIdentity,
        e_DCHMacFlows
    )
-- set up the E-DCH transport channel which carries one or multiple MAC_d flows, one Mac_d flow is
defined as
    {
        tti                    E_DCH_TTI
        harqInfo                ENUMERATED { rv0 (0) }
        addReconf_MAC_d_Flow    E_DCH_AddReconf_MAC_d_Flow
    }
-- the tti parameter is the same for all Mac_d flows
-- each Mac_d flow is identified by mac-d-FlowIdentity defined in the addReconf_MAC_d_Flow
-- for each MAC_d flow the configurable parameters are: mac-d-FlowPowerOffset, mac-d-FlowMaxRetrans,
mac-d-FlowMultiplexingList, transmissionGrantType

```

8. Mapping E-DCH cells in Node B

```

    CMAC_MACe_NodeB_CellMapping_REQ
    (
        nodeB_Id
        celllist
    )
-- set-up the mapping between NodeB-Id and E-DCH cells in celllist
-- a E-DCH cell is mapped to only one NodeB, and the cellId allocation is unique in a test.

```

9. Configure MAC_e entity for E-DCH

```

    CMAC_MACe_Config_REQ
    (
        nodeB_Id
        ddiMappingList
    )

```

```

        e_DCHMacdFlows
        connectedToMAC_es
    )
-- MAC_e entity is created per Node-B
-- the e_DCHMacdFlows shall be same as that used in CPHY_TrCH_Config_REQ
-- the field connectedToMAC_es shall be set to TRUE in serving E-DCH cell
-- the field connectedToMAC_es shall be set to FALSE in inter nodeB SHO
-- ddiMappinglist is defined as
    activationTime                SS_ActivationTime
    macHeaderManipulation         MAC_HeaderManipulation
    logicalChannelIdentity        LogicalChannelIdentity
    e_DCH_MAC_d_FlowIdentity      E_DCH_MAC_d_FlowIdentity
    ddi                            DDI
    rlc_PDU_SizeList              RLC_PDU_SizeList
    mac_LogicalChannelPriority     MAC_LogicalChannelPriority
    logicalChannelType            LogicalChannelType

```

10. Configure MAC_es entity for E-DCH

```

CMAC_MACes_Config_REQ
(
    ddiMappinglist
    macTestMode
)
-- set-up the mapping between the logical channel and the Mac_d flows
-- only one MAC_es entity is created
-- the ddiMappinglist shall be the same as that used in CMAC_MACe_Config_REQ

```

11. Configure RLC entity for DTCHs which is mapped on E-DCH

```

CRLC_Config_REQ
(
    rB_Identity,
    rBInfo
)
-- set up RLC entity on top of DTCH logical channel which is mapped onto MAC_d flow

```

8.13.1.2 SHO - addition of E-DCH RL in a serving RL cell (intra node B)

1. Configure E-DCH physical channel

-- E-DPCH is not configured: the cell is under the control of the same nodeB as the initial RL.
-- E-AGCH channel is not configured, it is configured only in the serving E-DCH cell

```

CPHY_RL_Setup_REQ
(
    physicalChannelIdentity,
    e_HICHInfo
    (
        e_HICHInfo
        tti
        e_HICH_PowerOffset
    )
)
-- set up the E-HICH identified by PhysicalChannelIdentity
-- for E-HICH the configurable parameters are
    e_HICHInfo                E_HICH_Information
    e_HICH_PowerOffset         INTEGER (0..255)
-- The tti value shall be the same as the associated E-DPCH in the serving E-DCH cell

CPHY_RL_Setup_REQ
(
    physicalChannelIdentity,
    e_RGCHInfo
    (
        e_RGCHInfo
        tti
        e_RGCH_PowerOffset
    )
)
-- set up the E-RGCH identified by PhysicalChannelIdentity
-- for E-RGCH the configurable parameters are
    e_RGCHInfo                E_RGCH_Information
    e_RGCH_PowerOffset         INTEGER (0..255)
The tti value shall be the same as the associated E-DPCH in the serving E-DCH cell

```

2. Mapping E-DCH cells in Node B

```

CMAC_MACe_NodeB_CellMapping_REQ
{
    nodeB_Id
    celllist
}
-- set-up the mapping between NodeB-Id and the new E-DCH cell in celllist

```

8.13.1.3 SHO – addition of E-DCH RL in a non-serving RL cell (inter node B)

1. Configure E-DCH DL physical channel

```

CPHY_RL_Setup_REQ
(
    physicalChannelIdentity,
    e_HICHInfo
    (
        e_HICHInfo
        tti
        e_HICH_PowerOffset
    )
)
-- set up the E-HICH identified by PhysicalChannelIdentity
-- for E-HICH the configurable parameters are
    e_HICHInfo          E_HICH_Information
    e_HICH_PowerOffset  INTEGER (0..255)
-- The tti value shall be the same as the associated E-DPCH in the serving E-DCH cell

```

```

CPHY_RL_Setup_REQ
(
    physicalChannelIdentity,
    e_RGCHInfo
    (
        e_RGCHInfo
        tti
        e_RGCH_PowerOffset
    )
)
-- set up the E-RGCH identified by PhysicalChannelIdentity
-- for E-RGCH the configurable parameters are
    e_RGCHInfo          E_RGCH_Information
    e_RGCH_PowerOffset  INTEGER (0..255)
-- The tti value shall be the same as the associated E-DPCH in the serving E-DCH cell

```

2. Configure E-DCH UL physical channel

```

CPHY_RL_Setup_REQ
(
    physicalChannelIdentity,
    e_DPCHInfo
    (
        e_DPCCH_Info
        e_DPDCH_Info
        scramblingCodeType
        scramblingCode
        tti
        edch_PhysicalLayerCategory
    )
)
-- set up the E-DCH identified by PhysicalChannelIdentity, the same as in the serving E-Dch cell
-- for E-DPCH the configurable parameters are
    e_DPCCH_Info          E_DPCCH_Info,
    e_DPDCH_Info          E_DPDCH_Info,
    edch_PhysicalLayerCategory  INTEGER (1..16)
-- The scramblingCodeType and scramblingCode shall be the same as for UL-DPCH
-- The tti value shall be the same as the E-DPCH in the serving E-DCH cell
-- for E-DPCH, the scramblingCodeType and scramblingCode shall be the same as for UL_DPCH
-- E-AGCH channel is not configured

```

3. Configure E-DCH transport channels

```

CPHY_TrCH_Config_REQ
(
    physicalChannelIdentity,
    e_DCHMacdFlows

```

```
)
-- set up the E-DCH transport channel which carries the same MAC_d flows as the initial RL
```

4. Configure MAC_e entity for E-DCH

```
CMAC_MACe_Config_REQ
(
    nodeB_Id
    ddiMappinglist
    e_DCHMacdFlows
    connectedToMAC_es FALSE
)
-- MAC_e entity is created per Node-B
-- the e_DCHMacdFlows shall be same as that used in CPHY_TrCH_Config_REQ
-- the field connectedToMAC_es shall be set to FALSE in inter nodeB SHO
-- ddiMappinglist is defined like in the initial RL
```

5. Mapping E-DCH cells in Node B

```
CMAC_MACe_NodeB_CellMapping_REQ
(
    nodeB_Id
    celllist
)
-- set-up the mapping between the new NodeB-Id and E-DCH in the new cell
```

8.13.2 DPCH/HS-DSCH/E-DCH setup and release order

When setting up an HSUPA RAB, the following order of channel configuration is applied:

DL-DPCH, HS-DSCH, UL-DPCH, E-DCH.

When releasing an HSUPA RAB, the following order of channel release/ modification is applied:

E-DCH, HS-DSCH, UL-DPCH, DL-DPCH.

8.13.3 Serving E-DCH cell with UL DTX Configured [Rel-7]

UL-DRX is always configured when UL-DTX is started.

1. Configure DPCH physical channel

```
CPHY_RL_Setup_REQ
(
    cellId_1
    physicalChannelIdentity,
    dPCHInfo_r5OrLater
    r7 {
        UL_DPCH_Info_r7
        {
            scramblingCodeType,
            scramblingCode,
            dpdchPresence notPresent
        },
        hs_DPCCHInd,
        ss_UL_DPCCH_DRX_Info
    }
)
-- set up the UL-DPCCH, hs-DPCCH channel. When UL-DPCCH is established, E-DPCH shall use the
same scrambling code. UL DPCCH DRX parameters are provided.
```

2. Continue with steps 5 through 11 in clause 8.13.1.1 except for Rel-7 branches if available.

If DL_DRX is enabled IE 'ss_DTX_Info' shall be provided in E_AGCH/E_RGCH/HS_PDSCH configuration.

If DL_DRX is enabled IE 'ss_DTX_Info' shall be provided in:

- CMAC_MACHs_MACehs_TFRCconfigure_REQ when configuring HS_PDSCH.

For F-DPCH configuration 'ss_DTX_Info' shall be provided.

3. Configure MAC_e entity for E-DCH

```

CMAC_MACe_Config_REQ
(
  nodeB_Id
  ddiMappingList
  e_DCHMacdFlows
  connectedToMAC_es
  ss_DRX_MAC_Info
  {
    mac_InactivityThreshold,
    mac_dtx_Cycle_2ms,
    mac_dtx_Cycle_10ms,
    timingInfo
  }
)
-- MAC_e entity is created per Node-B
-- the e_DCHMacdFlows shall be same as that used in CPHY_TrCH_Config_REQ
-- the field connectedToMAC_es shall be set to TRUE in serving E-DCH cell
-- the field connectedToMAC_es shall be set to FALSE in inter nodeB SHO
-- ddiMappingList is defined as
      activationTime                SS_ActivationTime
      macHeaderManipulation         MAC_HeaderManipulation
      logicalChannelIdentity        LogicalChannelIdentity
      e_DCH_MAC_d_FlowIdentity      E_DCH_MAC_d_FlowIdentity
      ddi                           DDI
      rlc_PDU_SizeList              RLC_PDU_SizeList
      mac_LogicalChannelPriority     MAC_LogicalChannelPriority
      logicalChannelType             LogicalChannelType

```

8.14 Guidelines of MBMS implementations

8.14.1 MCCH scheduling implementation

The rules for the transmission of MCCH messages are specified in 3GPP TS 34.108 [3], clause 11.1.2. The current clause provides the implementation guidelines.

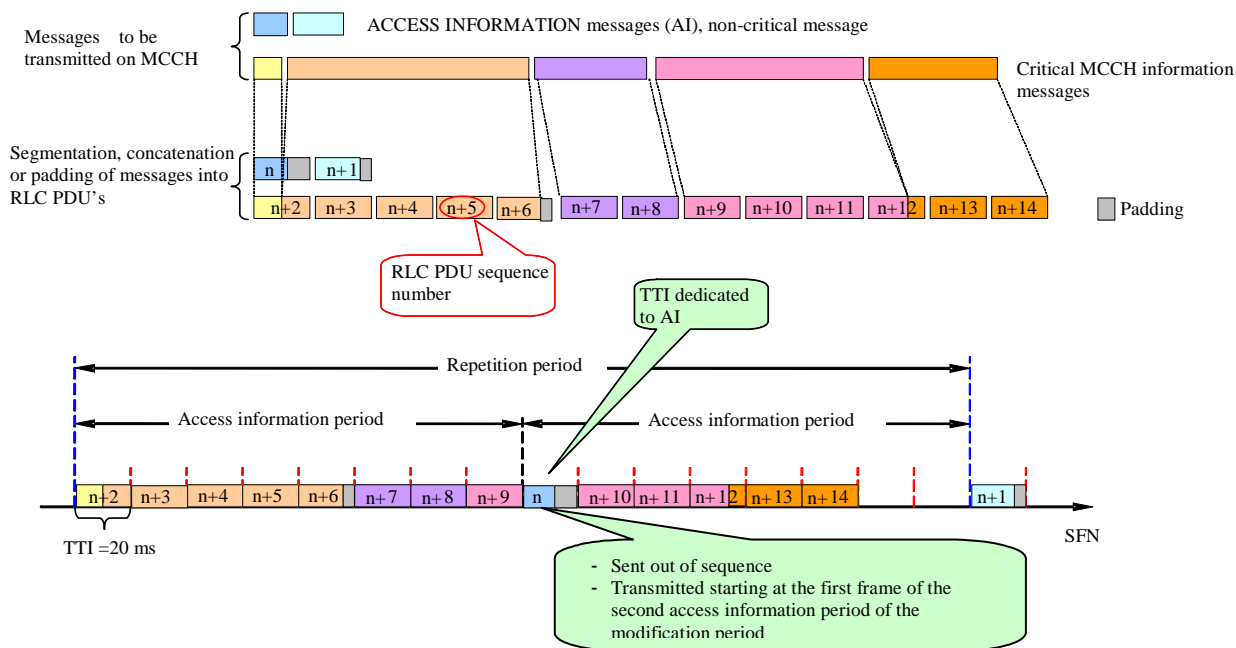

Figure 8.14.1.1: Segmentation and concatenation of MCCH messages into RLC PDU's

If required in the test, all ACCESS INFORMATION messages of a modification period are sent via RLC_UM_ACCESSInfo_REQ. Each ACCESS INFORMATION message corresponds to an access information period in an ordered way. The ACCESS INFORMATION is transmitted on the 1st TTI of the second access information period of the modification period.

All critical MCCH messages of a modification period are sent via RLC_UM_CriticalMCCHMsg_REQ. The sequence of the critical MCCH messages is segmented and concatenated without padding by a UM RLC entity configured specifically for MCCH. RLC_UM_ACCESSInfo_REQ precedes RLC_UM_CriticalMCCHMsg_REQ, or RLC_UM_CriticalMCCHMsg_REQ can be used alone. The scenarios of RLC_UM_ACCESSInfo_REQ used alone or RLC_UM_CriticalMCCHMsg_REQ preceding RLC_UM_ACCESSInfo_REQ are not applied.

The first RLC SN are always allocated consecutively to ACCESS INFORMATION messages, i.e. from $n + 0$ onwards as necessary. Then an RLC SN block is consecutively allocated to the critical MCCH messages, saying the last used SN = $(n + m) \text{MOD } 128$ in the current modification period. Renew n to $(n + m + 1) \text{MOD } 128$ for the next modification period.

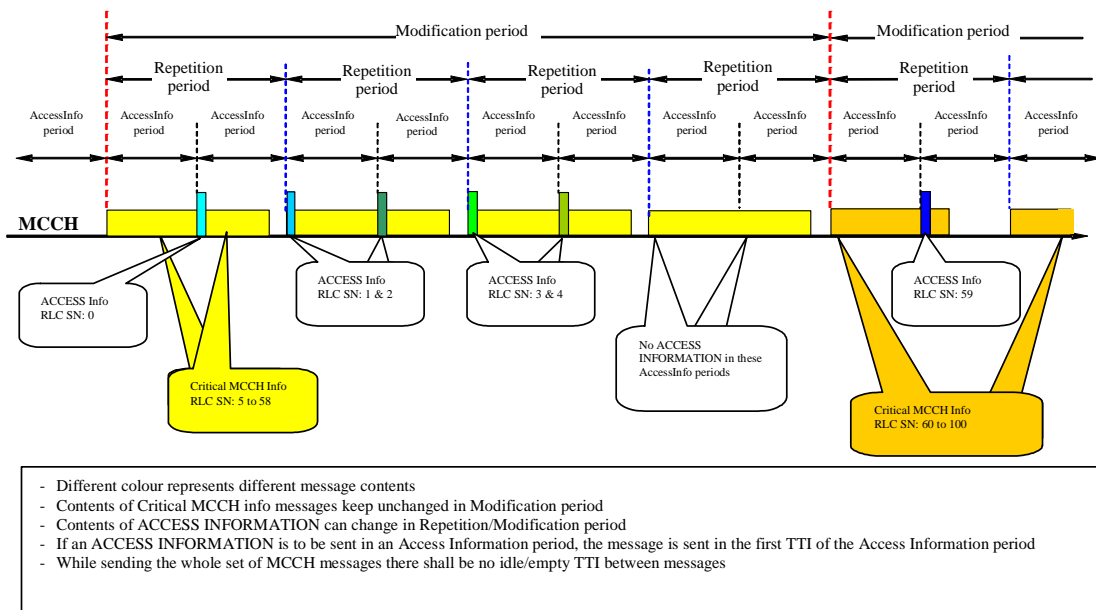

Figure 8.14.1.2: RLC SN allocation in MCCH scheduling

ACCESS INFORMATION messages within a modification period have different RLC SN. The SN = $n + 0$ is allocated to the 1st ACCESS INFORMATION message. The critical MCCH messages to be transmitted in the different repetition periods within a modification period have the same RLC SN. RLC SN are incremented across the boundary of two consecutive modification periods without RLC reestablishment. The different RLC SN are allocated to the two consecutive modification periods.

In order to ensure UE can read the first ACCESS INFORMATION message, the message is sent by the TTCN in the second access information period.

8.14.2 MSCH scheduling and service data on MTCH

Multiple ordered SCHEDULING INFORMATION messages are sent by using RLC_UM_MSCH_Msg_REQ. Each SCHEDULING INFORMATION corresponds to a scheduling period, a 'noSend' MSCH_Message indicates that no MBMS services are scheduled in that scheduling period for all MTCH. The first SCHEDULING INFORMATION message is sent on the scheduledSFN and successively the remaining messages are sent in every scheduling period.

The MBMS service data are fed by RLC_UM_TestDataReq. However the real MBMS service transmissions for multiple scheduling periods on each MTCH are controlled by CRLC_MTCH_Scheduling_REQ. Within each scheduling period the information on the discontinuous service transmissions are conveyed through a list of pairs of (start, duration). The IE noServiceData as NULL being provided for a scheduling period indicates no service transmission on that MTCH.

The simulation of the continuous MBMS services is provided if an empty CRLC_MTCH_Scheduling_REQ is sent without scheduling configuration parameter and scheduling information.

RLC_UM_MSCH_Msg_REQ precedes CRLC_MTCH_Scheduling_REQ and RLC_UM_TestDataReq.

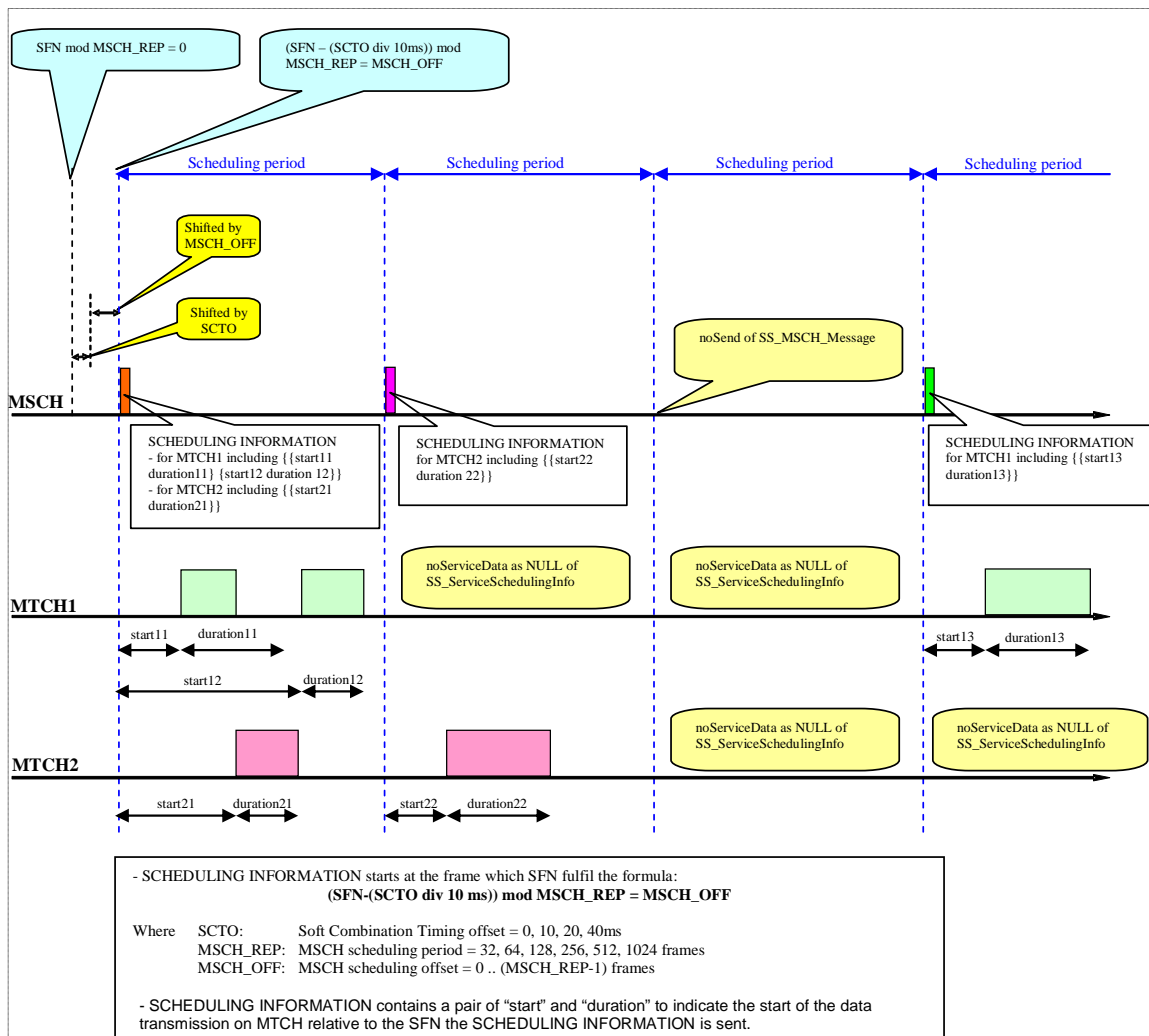

Figure 8.14.2: MSCH scheduling and MTCH data transfer

8.14.2.1 Scheduled service data on MTCH without MSCH configured

The scheduled service is a mechanism for synchronization of the initialization of the MBMS services announced on MCCH and the start of transmission the service data on MTCH. The mechanism can also be used at the SS side when MSCH is not configured.

In a PTM test session two separate sequences of critical MCCH messages are transmitted in an order of C4 - C2 or C5 - C3 in two consecutive modification periods. The MBMS MODIFIED SERVICES INFORMATION message in C4/C5 generally does not contain MBMS p-t-m activation time for the UE immediate reception of MBMS services. However, the SS shall not start test data transmission until on the 1st TTI of the next modification period to ensure that the UE can have a nearly full modification period to obtain critical MCCH messages and to apply the configuration required by the test.

Figure 8.14.2.1 illustrates the relationship of the service scheduling on MTCH and the default1 MCCH information scheduling. The SS waits until the 2nd half of the last repetition period in the modification period when the C4 messages are sent before closing test loop. The test data are transmitted on the 1st TTI of the modification period when the C2 messages are sent. The whole test sequence is:

CPHY_SF_N_REQ, calculating next MICH CFN,

MP n: next MICH CFN set MICH and transmit NI,

MP n+1: next MICH CFN+1 mp set modified services list (C4 or C5), set PTM activation time if necessary,

MP n+2: next MICH CFN+2 mp set unmodified service list and transmit data (C2 or C3).

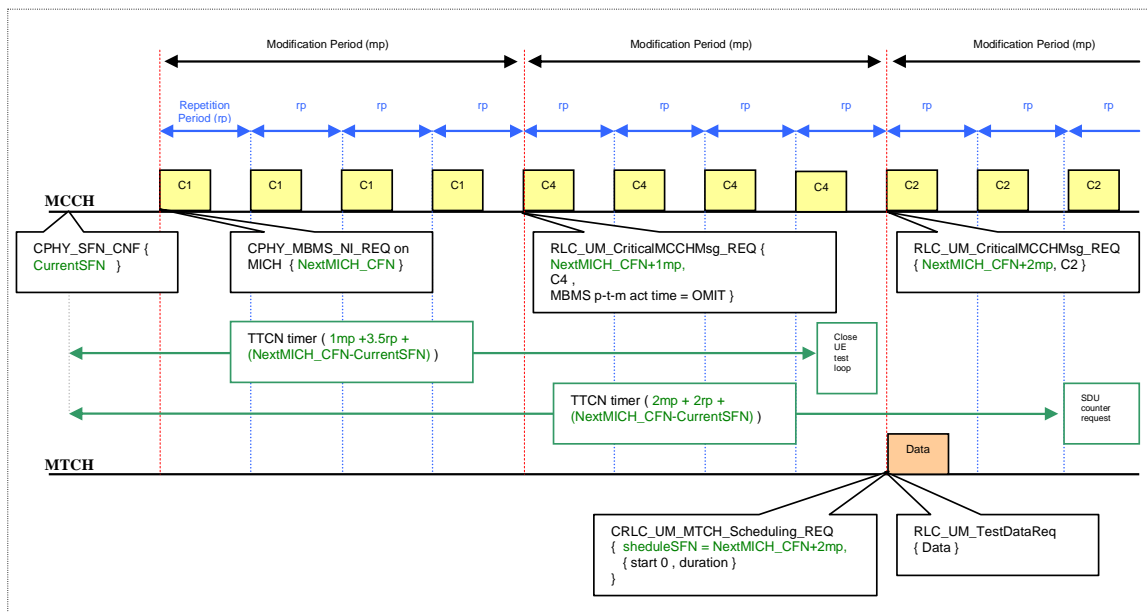

Figure 8.14.2.1: Synchronized MTCH data sending, no MSCH configured

If the test loop is already closed and the service data is to be sent the ASPs follow the order:

CPHY_SF_N_REQ, CRLC_MTCH_Scheduling_REQ and RLC_UM_TestDataReq.

8.15 Cell mapping

Table 8.15 defines the cell identities mapping between 3GPP TS 34.108 [3] and the ATS implementation.

Table 8.15: Cell identities mapping

Cell Number in 34.108	ATS
1	0
2	1
3	2
4	3
5	4
6	5
7	6
8	7
9	1
10	2
11	Not Used
21	20
22	21
23	22
24	23
25	24
26	25
27	26
28	27

8.16 Guidelines for CS voice over HSPA implementation

For PDCP CS voice over HSPA tests, data are scheduled to ensure consistency between CFN and CS counter in downlink and to check CS counter value in uplink. Figure 8.16 provides the ASP sequence, CFN and CS counter handling.

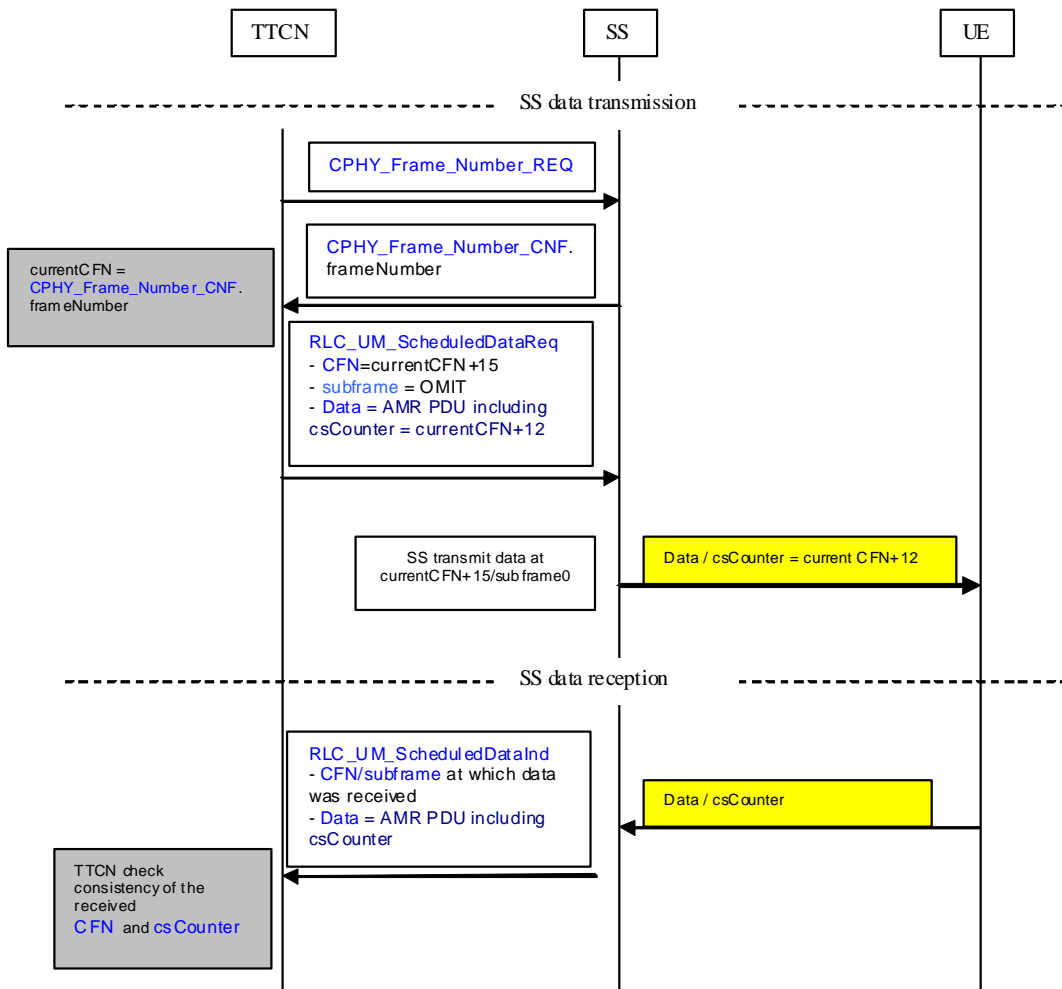

Figure 8.16: ASP sequence for data scheduling in PDCP CS Voice over HSPA tests

Upon reception of data, the ASP `RLC_UM_ScheduledDataInd` includes:

- the CFN on which the data has been received by SS,
- the AMR PDU, including the csCounter in the header

In terms of the CFN and csCounter, the TTCN can check the delay between the received CFN and the csCounter.

Annex A (normative): Abstract Test Suites (ATS)

This annex contains the approved ATSs.

The ATSs have been produced using the Tree and Tabular Combined Notation (TTCN) according to TR 101 666 [27].

The ATSs were developed on a separate TTCN software tool and therefore the TTCN tables are not completely referenced in the table of contents. Each ATS contains a test suite overview part which provides additional information and references.

A.1 Version of specifications

Table A.1 shows the version of the test specifications which the delivered ATSs are referred to.

Table A.1: Versions of the test and Core specifications

Core specifications	3GPP TS 25.331 [21]
Test specifications	3GPP TS 34.123-1 [1]
	3GPP TS 34.123-2 [2]
	3GPP TS 34.108 [3]
	3GPP TS 34.109 [4]

A.2 NAS ATS

The approved NAS test cases are listed. An "X" in columns FDD or LCR TDD indicates the test case approved for the relevant ATS.

Table A.2: NAS TTCN test cases

Test case	Description	FDD	LCR TDD
	MM		
9.1	TMSI reallocation	X	X
9.2.1	Authentication accepted	X	X
9.2.2	Authentication rejected	X	
9.2.3	Authentication rejected by the UE (MAC code failure)	X	X
9.2.4	Authentication rejected by the UE (SQN failure)	X	X
9.3.1	General Identification	X	X
9.4.1	Location updating / accepted	X	X
9.4.2.1	Location updating / rejected / IMSI invalid	X	
9.4.2.2.1	Location updating / rejected / PLMN not allowed/Test 1	X	
9.4.2.2.2	Location updating / rejected / PLMN not allowed / Test 2	X	
9.4.2.3	Location updating / rejected / location area not allowed	X	
9.4.2.4.1	Location updating / rejected / roaming not allowed in this location area / Procedure 1	X	X
9.4.2.4.2	Location updating / rejected / roaming not allowed in this location area / Procedure 2	X	
9.4.2.4.4	Location updating / rejected / roaming not allowed in this location area / Procedure 4	X	
9.4.2.5	Location updating / rejected / No Suitable Cells In Location Area	X	
9.4.3.3	Location updating / abnormal cases / attempt counter equal to 4	X	
9.4.3.5	Location updating / abnormal cases / Failure due to non-integrity protection	X	
9.4.4	Location updating / release / expiry of T3240	X	X
9.4.5.2	Location updating / periodic normal / test 1	X	X
9.4.5.3	Location updating / periodic normal / test 2	X	

Test case	Description	FDD	LCR TDD
9.4.5.4.1	Location updating / periodic search for HPLMN or higher priority PLMN / UE waits time T	X	
9.4.5.4.6	Location updating/periodic search of the higher priority PLMN, VPLMN in a foreign country- List of EPLMN contain HPLMN /UE is in automatic mode	X	
9.4.7	Location Updating / accept with replacement or deletion of Equivalent PLMN list	X	
9.4.8	Location Updating after UE power off	X	
9.4.9	Location Updating / Accept, Interaction between Equivalent PLMNs and Forbidden PLMNs	X	
9.5.2	MM connection / establishment in security mode	X	X
9.5.4	MM connection / establishment rejected	X	X
9.5.5	MM connection / establishment rejected cause 4	X	X
9.5.7.1	MM connection / abortion by the network / cause #6	X	
9.5.7.2	MM connection / abortion by the network / cause not equal to #6	X	
CC			
10.1.2.1.1	Outgoing call / U0 null state / MM connection requested	X	X
10.1.2.2.1	Outgoing call / U0.1 MM connection pending / CM service rejected	X	X
10.1.2.2.2	Outgoing call / U0.1 MM connection pending / CM service accepted	X	X
10.1.2.2.3	Outgoing call / U0.1 MM connection pending / lower layer failure	X	X
10.1.2.3.1	Outgoing call / U1 call initiated / receiving CALL PROCEEDING	X	X
10.1.2.3.2	Outgoing call / U1 call initiated / rejecting with RELEASE COMPLETE	X	X
10.1.2.3.3	Outgoing call / U1 call initiated / T303 expiry	X	X
10.1.2.3.7	Outgoing call / U1 call initiated / unknown message received	X	X
10.1.2.4.3	Outgoing call / U3 Mobile originating call proceeding / PROGRESS received without in band information	X	X
10.1.2.4.4	Outgoing call / U3 Mobile originating call proceeding / PROGRESS with in band information	X	X
10.1.2.4.6	Outgoing call / U3 Mobile originating call proceeding / DISCONNECT without in band tones	X	X
10.1.2.4.7	Outgoing call / U3 Mobile originating call proceeding / RELEASE received	X	X
10.1.2.4.8	Outgoing call / U3 Mobile originating call proceeding / termination requested by the user	X	X
10.1.2.4.9	Outgoing call / U3 Mobile originating call proceeding / traffic channel allocation	X	X
10.1.2.4.10	Outgoing call / U3 Mobile originating call proceeding / timer T310 time-out	X	X
10.1.2.5.1	Outgoing call / U4 call delivered / CONNECT received	X	
10.1.2.5.2	Outgoing call / U4 call delivered / termination requested by the user	X	X
10.1.2.5.5	Outgoing call / U4 call delivered / RELEASE received	X	X
10.1.2.6.2	U10 active / RELEASE received	X	X
10.1.2.6.3	U10 active / DISCONNECT with in band tones	X	X
10.1.2.6.6	U10 active / SETUP received	X	X
10.1.2.7.1	U11 disconnect request / clear collision	X	X
10.1.2.7.2	U11 disconnect request / RELEASE received	X	X
10.1.2.7.3	U11 disconnect request / timer T305 time-out	X	X
10.1.2.9.1	Outgoing call / U19 release request / timer T308 time-out	X	X
10.1.3.3.1	Incoming call / U9 mobile terminating call confirmed / alerting or immediate connecting	X	X
10.1.3.3.2	Incoming call / U9 mobile terminating call confirmed / DTCH assignment	X	X
10.1.3.3.4	Incoming call / U9 mobile terminating call confirmed / DISCONNECT received	X	X
10.1.3.4.1	Incoming call / U7 call received / call accepted	X	X
10.1.3.5.6	Incoming call / U8 connect request / RELEASE received	X	X
Session Management			
11.1.1.1	Attach initiated by context activation/QoS Offered by Network is the QoS Requested	X	X
11.3.1	PDP context deactivation initiated by the UE	X	X
11.3.2	PDP context deactivation initiated by the network	X	X

Test case	Description	FDD	LCR TDD
GPRS Mobility Management			
12.2.1.1	PS attach / accepted	X	X
12.2.1.2	PS attach / rejected / IMSI invalid / illegal UE	X	X
12.2.1.3	PS attach / rejected / IMSI invalid / PS services not allowed	X	X
12.2.1.4 Proc 1	PS attach / rejected / PLMN not allowed / test procedure 1	X	
12.2.1.4 Proc 2	PS attach / rejected / PLMN not allowed / test procedure 2	X	
12.2.1.5a Proc 1	PS attach / rejected / roaming not allowed in this location area / test procedure 1	X	X
12.2.1.5a Proc 2	PS attach / rejected / roaming not allowed in this location area / test procedure 2	X	X
12.2.1.5b	PS attach / rejected / No Suitable Cells In Location Area	X	X
12.2.1.5d	PS attach / rejected / PS services not allowed in this PLMN	X	X
12.2.1.6 Proc 1	PS attach / abnormal cases / access barred due to access class control / tes procedure 1	X	X
12.2.1.6 Proc 2	PS attach / abnormal cases / access barred due to access class control / test procedure 2	X	X
12.2.1.7	PS attach / abnormal cases / change of cell into new routing area	X	X
12.2.1.10	PS attach / abnormal cases / Failure due to non-integrity protection	X	X
12.2.1.11	PS attach / accepted / follow-on request pending indicator set	X	X
12.2.2.1	Combined PS attach / PS and non-PS attach accepted	X	X
12.3.1.1	PS detach / power off / accepted	X	X
12.3.1.2	PS detach / accepted	X	X
12.3.1.5	PS detach / power off / accepted / PS/IMSI detach	X	X
12.3.2.1	PS detach / re-attach not required / accepted	X	X
12.3.2.7	PS detach / rejected / Roaming not allowed in this location area	X	X
12.3.2.8.Proc 1	PS detach / rejected / PS services not allowed in this PLMN/ test1	X	
12.4.1.1a	Routing area updating / accepted	X	X
12.4.1.1b	Routing area updating / accepted / Signalling connection re-establishment	X	X
12.4.1.2	Routing area updating / rejected / IMSI invalid / illegal ME	X	X
12.4.1.3	Routing area updating / rejected / UE identity cannot be derived by the network	X	X
12.4.1.4a	Routing area updating / rejected / location area not allowed	X	
12.4.1.4b	Routing area updating / rejected / No Suitable Cells In Location Area	X	
12.4.1.4c Proc 1	Routing area updating / rejected / PS services not allowed in this PLMN	X	X
12.4.1.4c Proc 2	Routing area updating / rejected / PS services not allowed in this PLMN	X	
12.4.1.4d Proc 1	Routing area updating / rejected / Roaming not allowed in this location area / test 1	X	X
12.4.1.4d Proc 2	Routing area updating / rejected / Roaming not allowed in this location area / test 2	X	
12.4.1.5	Routing area updating / abnormal cases / attempt counter check / miscellaneous reject causes	X	X
12.4.2.1	Combined routing area updating / combined RA/LA accepted	X	X
12.4.2.2	Combined routing area updating / UE in CS operation at change of RA	X	X
12.4.2.4	Combined routing area updating / rejected / PLMN not allowed	X	
12.4.2.5a Proc 1	Combined routing area updating / rejected / roaming not allowed in this location area / test procedure 1	X	
12.4.2.5a.Proc 2	Combined routing area updating / rejected / roaming not allowed in this location area / test procedure 2	X	X
12.4.2.6 Proc 1	Combined routing area updating / abnormal cases / access barred due to access class control / test procedure 1	X	
12.4.2.6.Proc 2	Combined routing area updating / abnormal cases / access barred due to access class control / test procedure 2	X	
12.4.3.1	Periodic routing area updating / accepted	X	X
12.4.3.4	Periodic routing area updating / no cell available	X	X
12.5	P-TMSI reallocation	X	X
12.6.1.1	Authentication accepted	X	X
12.6.1.2	Authentication rejected - by the network	X	X
12.6.1.3.1	GMM cause 'MAC failure'	X	X
12.6.1.3.2	GMM cause 'Synch failure'	X	X
12.6.1.3.3	Authentication rejected by the UE / fraudulent network	X	
12.7.1	General Identification	X	X
12.9.1	Service Request Initiated by UE Procedure	X	X

Test case	Description	FDD	LCR TDD
12.9.2	Service Request Initiated by Network Procedure	X	X
12.9.3	Service Request / rejected / Illegal MS	X	X
12.9.4	Service Request / rejected / PS services not allowed	X	X
12.9.6	Service Request / rejected / PLMN not allowed	X	X
12.9.7a	Service Request / rejected / No PDP context activated	X	X
12.9.7b	Service Request / rejected / No Suitable Cells In Location Area	X	X
12.9.7c	Service Request / rejected / Roaming not allowed in this location area	X	X
12.9.8	Service Request / Abnormal cases / Access barred due to access class control	X	X
12.9.9	Service Request / Abnormal cases / Routing area update procedure is triggered	X	X
12.9.12	Service Request / RAB re-establishment / UE initiated / Single PDP context	X	
12.9.13	Service Request / RAB re-establishment / UE initiated / multiple PDP contexts	X	
12.9.14	Service Request / RAB re-establishment / Network initiated / single PDP context	X	X
General Tests			
13.2.1.1	Emergency call / with USIM / accept case	X	X
13.2.2.1	Emergency call / without USIM / accept case	X	X
13.2.2.2	Emergency call / without USIM / reject case	X	X

A.2.1 Void

A.2.2 The TTCN Machine Processable form (TTCN.MP)

The TTCN.MP representation corresponding to the corresponding FDD or LCR_TDD ATS is contained in an ASCII file (NAS.MP) which accompanies the present document.

A.3 SMS ATS

The approved SMS test cases are listed. An "X" in columns FDD or LCR TDD indicates the test case approved for the relevant ATS.

Table A.3: SMS TTCN test cases

Test case	Description	FDD	LCR TDD
16.1.1	SMS on CS mode / SMS mobile terminated	X	X
16.1.2	SMS on CS mode / SMS mobile originated	X	X
16.1.9.1	SMS on CS mode / Multiple SMS mobile originated / UE in idle mode	X	X
16.1.9.2	SMS on CS mode / Multiple SMS mobile originated / UE in active mode	X	X
16.1.10	SMS on CS mode / Test of capabilities of simultaneously receiving a short message whilst sending a mobile originated short message	X	
16.2.1	SMS on PS mode / SMS mobile terminated	X	X
16.2.2	SMS on PS mode / SMS mobile originated	X	X
16.2.10	SMS on PS mode / Test of capabilities of simultaneously receiving a short message whilst sending a mobile originated short message	X	
16.3	Short message service cell broadcast	X	

A.3.1 Void

A.3.2 The TTCN Machine Processable form (TTCN.MP)

The TTCN.MP representation corresponding to the corresponding FDD or LCR_TDD ATS is contained in an ASCII file (SMS.MP) which accompanies the present document.

A.4 RRC ATS

The approved RRC test cases are listed. An "X" in columns FDD or LCR TDD indicates the test case approved for the relevant ATS.

Table A.4: RRC TTCN test cases

Test case	Description	FDD	LCR TDD
	Single Cell		
6.1.1.4	PLMN selection of RPLMN, HPLMN, UPLMN and OPLMN; Automatic mode	X	
6.1.1.5	PLMN selection of "Other PLMN / access technology combinations"; Automatic mode	X	
6.1.1.7	Cell reselection of ePLMN in manual mode	X	
6.1.2.1	Cell reselection	X	
6.1.2.1a	Cell reselection for inter-band operation	X	
6.1.2.2	Cell reselection using Qhyst, Qoffset and Treselection	X	
6.1.2.3	HCS Cell reselection	X	
6.1.2.4	HCS Cell reselection using reselection timing parameters for the H criterion	X	
6.1.2.5	HCS Cell reselection using reselection timing parameters for the R criterion	X	
6.1.2.6	Emergency calls	X	
6.1.2.8	Cell reselection: Equivalent PLMN	X	
6.1.2.9a	Cell reselection using cell status and cell reservations – Type "A" USIM	X	
6.1.2.9b	Cell reselection using cell status and cell reservations – Type "B" USIM	X	
8.1.1.1	RRC / Paging for Connection in idle mode	X	X
8.1.1.2	RRC / Paging for Connection in connected mode (CELL_PCH)	X	X
8.1.1.3	R RRC / Paging for Connection in connected mode (URA_PCH)	X	X
8.1.1.4	RRC / Paging for notification of BCCH modification in idle mode	X	X
8.1.1.5	RRC / Paging for notification of BCCH modification in connected mode (CELL_PCH)	X	X
8.1.1.6	RRC / Paging for notification of BCCH modification in connected mode (URA_PCH)	X	
8.1.1.7	RRC / Paging for connection in connected mode (CELL_DCH)	X	X
8.1.1.8	RRC / Paging for Connection in connected mode (CELL_FACH)	X	X
8.1.1.9	RRC / Paging for Connection in idle mode (multiple paging records)	X	
8.1.1.10	RRC / Paging for Connection in connected mode (URA_PCH, multiple paging records)	X	
8.1.2.1	RRC / RRC Connection Establishment in CELL_DCH state: Success	X	X
8.1.2.2	RRC / RRC Connection Establishment: Success after T300 timeout	X	
8.1.2.3	RRC / RRC Connection Establishment: Failure (V300 is greater than N300)	X	
8.1.2.4	RRC / RRC Connection Establishment: Reject ("wait time" is not equal to 0)	X	X
8.1.2.7	RRC Connection Establishment in CELL_FACH state: Success	X	X
8.1.2.9	RRC / RRC Connection Establishment: Success after Physical channel failure and Invalid configuration	X	X
8.1.2.10	RRC / Radio Bearer Establishment for transition from CELL_DCH to CELL_FACH (Frequency band modification): Success	X	X
8.1.2.10a	RRC connection establishment in CELL_DCH on another frequency in a different frequency band	X	
8.1.2.11	RRC Connection Establishment in FACH state (Frequency band modification): Success	X	
8.1.2.21	RRC Connection Establishment: Reject with Frequency Info set to the same frequency band – Successful case	X	
8.1.2.21a	RRC Connection Establishment: Reject with Frequency Info set to a different frequency band – Successful case	X	
8.1.2.22	RRC Connection Establishment: Reject with Frequency Info set to the same frequency band – Unsuccessful case	X	
8.1.2.22a	RRC Connection Establishment: Reject with Frequency Info set to a different frequency band – Unsuccessful case	X	
8.1.3.1	RRC / RRC Connection Release in CELL_DCH state: Successful	X	X
8.1.3.3	RRC / RRC Connection Release using on CCCH in CELL_FACH state: Failure	X	X

Test case	Description	FDD	LCR TDD
8.1.3.4	RRC / RRC Connection Release in CELL_FACH state: Failure	X	
8.1.3.5	RRC / RRC Connection Release in CELL_FACH state: Invalid message	X	
8.1.3.9	RRC Connection Release in CELL_DCH state (Network Authentication Failure): Success	X	
8.1.5.1	RRC / UE Capability in CELL_DCH state: Success	X	X
8.1.5.4	RRC / UE Capability in CELL_FACH state: Success	X	X
8.1.6.1	Direct Transfer in CELL_DCH state (invalid message reception and no signalling connection exists)	X	X
8.1.6.3	Measurement Report on INITIAL DIRECT TRANSFER message and UPLINK DIRECT TRANSFER message	X	
8.1.7.1	Security mode command in CELL_DCH state (CS Domain)	X	
8.1.7.1b	Security mode command in CELL_DCH state (PS Domain)	X	
8.1.7.1c	Security mode control in CELL_DCH state (CN Domain switch and new keys at RRC message sequence number wrap around)	X	
8.1.7.1d	Security mode control in CELL_DCH state interrupted by a cell update	X	
8.1.7.2	RRC / Security mode control in CELL_FACH state	X	
8.1.9	RRC / Signalling Connection Release Indication	X	X
8.1.10.1	Dynamic change of segmentation, concatenation & scheduling and handling of unsupported information blocks	X	
8.1.12	RRC / Radio Bearer Establishment for transition from CELL_FACH to CELL_DCH: Failure (Physical channel Failure and successful reversion to old configuration)	X	X
8.2.1.1	Radio Bearer Establishment for transition from CELL_DCH to CELL_DCH: Success	X	X
8.2.1.4	RRC / Radio Bearer Establishment for transition from CELL_DCH to CELL_DCH: Failure (Physical channel Failure and successful reversion to old configuration)	X	X
8.2.1.7	RRC / Radio Bearer Establishment for transition from CELL_DCH to CELL_DCH: Failure (Invalid message reception and invalid configuration)	X	X
8.2.1.8	RRC / Radio Bearer Establishment for transition from CELL_DCH to CELL_FACH: Success	X	X
8.2.1.9	RRC / Radio Bearer Establishment for transition from CELL_DCH to CELL_FACH: Success (Cell re-selection)	X	X
8.2.1.10	RRC / Radio Bearer Establishment for transition from CELL_DCH to CELL_FACH (Frequency band modification): Success	X	X
8.2.1.24	Radio Bearer Establishment for transition from CELL_DCH to CELL_DCH (Frequency band modification): Success	X	X
8.2.1.24a	Radio Bearer Establishment for transition from CELL_DCH to CELL_DCH (Inter band handover): Success	X	
8.2.1.33	Radio Bearer Establishment for transition from CELL_DCH to CELL_DCH: Success (Unsynchronised RL Reconfiguration)	X	
8.2.1.34	Radio Bearer Establishment for transition from CELL_DCH to CELL_DCH: Success (Unsynchronised RL Reconfiguration with frequency modification)	X	
8.2.1.34a	Radio Bearer Establishment for transition from CELL_DCH to CELL_DCH: Success (Unsynchronised RL Reconfiguration with inter band handover)	X	
8.2.2.1	RRC / Radio Bearer Reconfiguration (Hard Handover) from CELL_DCH to CELL_DCH: Success	X	X
8.2.2.4	RRC / Radio Bearer Reconfiguration from CELL_DCH to CELL_DCH: Failure (Physical channel failure and reversion failure)	X	X
8.2.2.7	RRC / Radio Bearer Reconfiguration from CELL_DCH to CELL_DCH: Success (stop and continue)	X	X
8.2.2.8	RRC / Radio Bearer Reconfiguration from CELL_DCH to CELL_FACH: Success	X	X
8.2.2.9	RRC / Radio Bearer Reconfiguration from CELL_DCH to CELL_FACH: Success (Cell re-selection)	X	X
8.2.2.10	RRC / Radio Bearer Reconfiguration from CELL_FACH to CELL_DCH: Success	X	
8.2.2.11	Radio Bearer Reconfiguration from CELL_FACH to CELL_DCH: Failure (Unsupported configuration)	X	X
8.2.2.17	RRC / Radio Bearer Reconfiguration from CELL_FACH to CELL_FACH: Success	X	X
8.2.2.18	RRC / Radio Bearer Reconfiguration from CELL_FACH to CELL_FACH: Success (Cell re-selection)	X	

Test case	Description	FDD	LCR TDD
8.2.2.19	RRC / Radio Bearer Reconfiguration from CELL_DCH to CELL_DCH: Success (Subsequently received)	X	X
8.2.2.23	RRC / Radio Bearer Reconfiguration from CELL_FACH to CELL_PCH: Success	X	X
8.2.2.31	Radio Bearer Reconfiguration for transition from CELL_FACH to CELL_DCH (Frequency band modification): Success	X	
8.2.2.35	Radio Bearer Reconfiguration from CELL_DCH to CELL_FACH: Successful channel switching with multiple PS RABs established	X	
8.2.2.43	Radio Bearer Reconfiguration for transition from CELL_DCH to CELL_DCH: Success (Seamless SRNS relocation, without pending of ciphering, frequency band modification)	X	
8.2.3.1	Radio Bearer Release for transition from CELL_DCH to CELL_DCH: Success	X	X
8.2.3.7	RRC / Radio Bearer Release for transition from CELL_DCH to CELL_FACH: Success	X	X
8.2.3.8	RRC / Radio Bearer Release for transition from CELL_DCH to CELL_FACH: Success (Cell re-selection)	X	
8.2.3.9	RRC / Radio Bearer Release for transition from CELL_FACH to CELL_DCH: Success	X	X
8.2.3.11	RRC / Radio Bearer Release for transition from CELL_FACH to CELL_DCH: Failure (Physical channel failure and successful reversion to old configuration)	X	X
8.2.3.15	RRC / Radio Bearer Release for transition from CELL_FACH to CELL_FACH: Success	X	X
8.2.3.18	RRC / Radio Bearer Release from CELL_DCH to CELL_PCH: Success	X	X
8.2.3.19	RRC / Radio Bearer Release from CELL_DCH to URA_PCH: Success	X	X
8.2.3.29	Radio Bearer Release for transition from CELL_DCH to CELL_DCH: Associated with signalling connection release during multi call for PS and CS services	X	X
8.2.4.1	Transport channel reconfiguration (Timing re- initialised hard handover with transmission rate modification) from CELL_DCH to CELL_DCH: Success	X	
8.2.4.1a	Transport channel reconfiguration (Transmission Rate Modification) from CELL_DCH to CELL_DCH of the same cell: Success	X	
8.2.4.3	RRC / Transport channel reconfiguration from CELL_DCH to CELL_DCH: Failure (Physical channel failure and reversion to old configuration)	X	X
8.2.4.4	Transport channel reconfiguration from CELL_DCH to CELL_DCH: Failure (Physical channel failure and cell reselection)	X	
8.2.4.4a	Transport channel reconfiguration from CELL_DCH to CELL_DCH: Failure (Physical channel failure and cell reselection) (1.28 Mcps TDD Only)		X
8.2.4.10	RRC / Transport channel reconfiguration from CELL_FACH to CELL_DCH: Success	X	
8.2.4.10a	Transport channel reconfiguration from CELL_FACH to CELL_DCH: Success(1.28 Mcps TDD Only)		X
8.2.6.1	RRC / Physical channel reconfiguration for transition from CELL_DCH to CELL_DCH (Hard handover for code modification): Success	X	X
8.2.6.2	RRC / Physical channel reconfiguration for transition from CELL_DCH to CELL_DCH (Hard handover for code modification): Failure (Unsupported configuration)	X	X
8.2.6.7	RRC / Physical channel reconfiguration for transition from CELL_DCH to CELL_FACH: Success	X	X
8.2.6.8	RRC / Physical channel reconfiguration for transition from CELL_DCH to CELL_FACH: Success (Cell re-selection)	X	X
8.2.6.9	RRC / Physical channel reconfiguration for transition from CELL_FACH to CELL_DCH: Success	X	X
8.2.6.11	RRC / Physical channel reconfiguration for transition from CELL_FACH to CELL_DCH: Failure (Physical channel failure and successful reversion to old configuration)	X	X
8.2.6.12	RRC / Physical channel reconfiguration for transition from CELL_FACH to CELL_DCH: Failure (Physical channel failure and cell re-selection)	X	X
8.2.6.19	RRC / Physical channel reconfiguration from CELL_DCH to CELL_PCH: Success	X	X
8.2.6.20	RRC / Physical channel from CELL_DCH to URA_PCH: Success	X	X

Test case	Description	FDD	LCR TDD
8.2.6.37	Physical channel reconfiguration for transition from CELL_DCH to CELL_DCH (Hard handover to another frequency with timing re-initialised)	X	
8.2.6.37b	Physical channel reconfiguration for transition from CELL_DCH to CELL_DCH (Hard handover to another frequency band cell with timing re-initialised)	X	
8.2.6.38	Physical channel reconfiguration for transition from CELL_DCH to CELL_DCH (Hard handover to another frequency with timing re-initialised): Failure (Physical channel failure and reversion to old channel)	X	
8.2.6.39	Physical Channel Reconfiguration for transition from CELL_DCH to CELL_DCH: Success (Seamless SRNS relocation) (without pending of ciphering)	X	
8.2.6.44	Physical Channel Reconfiguration for transition from CELL_DCH to CELL_DCH: Failure (Radio link failure in new configuration)	X	
8.3.1.1	RRC / Cell Update: cell reselection in CELL_FACH	X	
8.3.1.1a	Cell Update: cell reselection in CELL_FACH (Cells belong to different frequency bands)	X	
8.3.1.2	RRC / Cell Update: cell reselection in CELL_PCH	X	X
8.3.1.3	RRC / Cell Update: periodical cell update in CELL_FACH	X	
8.3.1.4	RRC / Cell Update: periodical cell update in CELL_PCH	X	
8.3.1.5	RRC / Cell Update: UL data transmission in URA_PCH	X	X
8.3.1.6	RRC / Cell Update: UL data transmission in CELL_PCH	X	X
8.3.1.9	RRC / Cell Update: re-entering of service area after T305 expiry and being out of service area	X	
8.3.1.10	RRC / Cell Update: expiry of T307 after T305 expiry and being out of service area	X	
8.3.1.11	RRC / Cell Update: Success after T302 time-out	X	
8.3.1.12	RRC / Cell Update: Failure (After Maximum Re-transmissions)	X	
8.3.1.15	RRC / Cell Update: Unrecoverable error in Acknowledged Mode RLC	X	
8.3.1.17	RRC / Cell Update: Failure (UTRAN initiate an RRC connection release procedure on CCCH)	X	X
8.3.1.18	RRC / Cell Update: Radio Link Failure (T314>0, T315=0), CS RAB established	X	
8.3.1.21	Cell Update: Cell reselection to cell of another PLMN belonging to the equivalent PLMN list	X	
8.3.1.22	Cell update: Restricted cell reselection to a cell belonging to forbidden LA list (Cell_FACH)	X	
8.3.1.23	Cell Update: HCS cell reselection in CELL_FACH	X	
8.3.1.24	Cell Update: HCS cell reselection in CELL_PCH	X	
8.3.1.25	CELL UPDATE: Radio Link Failure (T314=0, T315=0)	X	X
8.3.1.30	Cell Update: Radio Link Failure (T314>0, T315>0), PS RAB	X	
8.3.1.31	Cell Update: re-entering of service area from URA_PCH after T316 expiry but before T317 expiry	X	
8.3.2.1	RRC / URA Update: Change of URA	X	X
8.3.2.1a	URA Update: Change of URA (Cells belong to different frequency bands)	X	
8.3.2.2	RRC / URA Update: Periodical URA update and Reception of Invalid message	X	
8.3.2.4	RRC / URA Update: loss of service after expiry of timers T307 after T306	X	
8.3.2.7	RRC / URA Update: Success after T303 timeout	X	
8.3.2.9	RRC / URA Update: Failure (UTRAN initiate an RRC connection release procedure on CCCH)	X	
8.3.2.11	URA Update: Cell reselection to cell of another PLMN belonging to the equivalent PLMN list	X	
8.3.2.12	Restricted cell reselection to a cell belonging to forbidden LA list (URA_PCH)	X	
8.3.2.13	URA Update: Change of URA due to HCS Cell Reselection	X	
8.3.3.1	RRC / UTRAN Mobility Information: Success	X	X
8.3.4.1	RRC / Active set update in soft handover: Radio Link addition	X	
8.3.4.2	RRC / Active set update in soft handover: Radio Link removal	X	
8.3.4.3	RRC / Active set update in soft handover: Combined radio link addition and removal	X	
8.3.4.8	Active set update in soft handover: Radio Link addition in multiple radio link environment	X	

Test case	Description	FDD	LCR TDD
8.4.1.1	Measurement Control and Report: Intra-frequency measurement for transition from idle mode to CELL_DCH state	X	
8.4.1.1a	Measurement Control and Report: Intra-frequency measurement for transition from idle mode to CELL_DCH state (TDD)		X
8.4.1.2	RRC / Measurement Control and Report: Inter-frequency measurement for transition from idle mode to CELL_DCH state	X	
8.4.1.2a	Measurement Control and Report: Inter-frequency measurement for transition from idle mode to CELL_DCH state (TDD)		X
8.4.1.2b	Measurement Control and Report: Inter-band measurement for transition from idle mode to CELL_DCH state (FDD)	X	
8.4.1.3	RRC / Measurement Control and Report: Intra-frequency measurement for transition from idle mode to CELL_FACH state	X	
8.4.1.3a	Measurement Control and Report: Intra-frequency measurement for transition from idle mode to CELL_FACH state (TDD)		X
8.4.1.5	RRC / Measurement Control and Report: Intra-frequency measurement for transition from CELL_DCH to CELL_FACH state	X	
8.4.1.5a	Measurement Control and Report: Intra-frequency measurement for transition from CELL_DCH to CELL_FACH state (TDD)		X
8.4.1.6	RRC / Measurement Control and Report: Inter-frequency measurement for transition from CELL_DCH to CELL_FACH state	X	
8.4.1.6a	Measurement Control and Report: Inter-frequency measurement for transition from CELL_DCH to CELL_FACH state (TDD)		X
8.4.1.7	RRC / Measurement Control and Report: Intra-frequency measurement for transition from CELL_FACH to CELL_DCH state	X	
8.4.1.8	Measurement Control and Report: Inter-frequency measurement for transition from CELL_FACH to CELL_DCH state (FDD)	X	
8.4.1.8a	Measurement Control and Report: Inter-frequency measurement for transition from CELL_FACH to CELL_DCH state (TDD)		X
8.4.1.14	RRC / Measurement Control and Report: Cell forbidden to affect reporting range	X	
8.4.1.16	Measurement Control and Report: Traffic volume measurement for transition from idle mode to CELL_FACH state	X	X
8.4.1.17	RRC / Measurement Control and Report: Traffic volume measurement for transition from idle mode to CELL_DCH state	X	X
8.4.1.18	RRC / Measurement Control and Report: Traffic volume measurement for transition from CELL_FACH state to CELL_DCH state	X	
8.4.1.19	RRC / Measurement Control and Report: Traffic volume measurement for transition from CELL_DCH to CELL_FACH state	X	
8.4.1.23	RRC / Measurement Control and Report: Intra-frequency measurement for events 1C and 1D	X	
8.4.1.24	RRC / Measurement Control and Report: Inter-frequency measurement for event 2A	X	X
8.4.1.24a	Measurement Control and Report: Inter-band measurement for event 2A	X	
8.4.1.25	RRC / Measurement Control and Report: Inter-frequency measurement for events 2B and 2E	X	
8.4.1.25a	Measurement Control and Report: Inter-band measurement for events 2B and 2E	X	
8.4.1.26	RRC / Measurement Control and Report: Inter-frequency measurement for events 2D and 2F	X	
8.4.1.27	RRC / Measurement Control and Report: UE internal measurement for events 6A and 6B	X	
8.4.1.28	Measurement Control and Report: UE internal measurement for events 6F (FDD) and 6G	X	
8.4.1.29	RRC / Measurement Control and Report: Event based Traffic Volume measurement in CELL_FACH state	X	
8.4.1.30	RRC / Measurement Control and Report: Event based Traffic Volume measurement in CELL_DCH state	X	
8.4.1.37	Measurement Control and Report: UE internal measurement, event 6c	X	
8.4.1.38	Measurement Control and Report: UE internal measurement, event 6d	X	
8.4.1.41	Measurement Control and Report: Additional Measurements list	X	
8.4.1.42	Measurement Control and Report: Change of Compressed Mode Method	X	

A.4.1 Void

A.4.2 The TTCN Machine Processable form (TTCN.MP)

The TTCN.MP representation corresponding to the corresponding FDD or LCR_TDD ATS is contained in an ASCII file (RRC.MP) which accompanies the present document.

A.5 RLC ATS

The approved RLC test cases are listed. An "X" in columns FDD or LCR TDD indicates the test case approved for the relevant ATS.

Table A.5: RLC TTCN test cases

Test case	Description	FDD	LCR TDD
7.2.2.3	UM RLC / Segmentation / 7-bit Length Indicators / Padding	X	
7.2.2.4	UM RLC / Segmentation / 7-bit Length Indicators / LI = 0	X	
7.2.2.5	UM RLC / Segmentation / 7-bit Length Indicators / Invalid LI value	X	
7.2.2.6	UM RLC / Segmentation / 7-bit Length Indicators / LI value > PDU	X	
7.2.2.7	UM RLC / Segmentation / 7-bit Length Indicators / First data octet LI	X	
7.2.3.4	AM RLC / Segmentation / 7-bit Length Indicators / LI = 0	X	X
7.2.3.5	AM RLC / Segmentation / 7-bit Length Indicators / Reserved LI value	X	X
7.2.3.6	AM RLC / Segmentation / 7-bit Length Indicators / LI value > PDU	X	X
7.2.3.12	AM RLC / Correct use of Sequence Numbering	X	X
7.2.3.13	AM RLC / Control of Transmit Window	X	X
7.2.3.14	AM RLC / Control of Receive Window	X	
7.2.3.15	AM RLC / Polling for status / Last PU in transmission queue	X	X
7.2.3.16	AM RLC / Polling for status / Last PU in retransmission queue	X	X
7.2.3.17	AM RLC / Polling for status / Poll every Poll_PU PUs	X	X
7.2.3.18	AM RLC / Polling for status / Poll every Poll_SDU SDUs	X	X
7.2.3.19	AM RLC / Polling for status / Timer triggered polling (Timer_Poll_Periodic)	X	
7.2.3.20	AM RLC / Polling for status / Polling on Poll_Window of transmission window	X	X
7.2.3.21	AM RLC / Polling for status / Operation of Timer_Poll timer / Timer expiry	X	
7.2.3.22	AM RLC / Polling for status / Operation of Timer_Poll timer / Stopping Timer_Poll timer	X	X
7.2.3.23	AM RLC / Polling for status / Operation of Timer_Poll timer / Restart of the Timer_Poll timer	X	
7.2.3.24	AM RLC / Polling for status / Operation of timer Timer_Poll_Prohibit	X	
7.2.3.25	AM RLC / Receiver Status Triggers / Detection of missing PUs	X	
7.2.3.26	AM RLC / Receiver Status Triggers / Operation of timer Timer_Status_Periodic	X	X
7.2.3.27	AM RLC / Receiver Status Triggers / Operation of timer Timer_Status_Prohibit	X	
7.2.3.28	AM RLC / Status reporting / Abnormal conditions / Reception of LIST SUFI with Length set to zero	X	X
7.2.3.32	AM RLC / SDU discard after MaxDAT number of retransmissions	X	
7.2.3.33	AM RLC / Operation of the RLC Reset procedure / UE Originated	X	
7.2.3.34	AM RLC / Operation of the RLC Reset procedure / UE Terminated	X	X
7.2.3.35	AM RLC / Reconfiguration of RLC parameters by upper layers	X	

A.5.1 Void

A.5.2 The TTCN Machine Processable form (TTCN.MP)

The TTCN.MP representation corresponding to the corresponding FDD or LCR_TDD ATS is contained in an ASCII file (RLC.MP) which accompanies the present document.

A.6 MAC ATS

The approved MAC test cases are listed. An "X" in columns FDD or LCR TDD indicates the test case approved for the relevant ATS.

Table A.6: MAC TTCN test cases

Test case	Description	FDD	LCR TDD
7.1.1.1	CCCH mapped to RACH/FACH / Invalid TCTF	X	X
7.1.1.2	DTCH or DCCH mapped to RACH/FACH / Invalid TCTF	X	X
7.1.1.3	DTCH or DCCH mapped to RACH/FACH / Invalid C/T Field	X	X
7.1.1.4	DTCH or DCCH mapped to RACH/FACH / Invalid UE ID Type Field	X	X
7.1.1.5	DTCH or DCCH mapped to RACH/FACH / Incorrect UE ID	X	X
7.1.1.8	DTCH or DCCH mapped to DCH / Invalid C/T Field	X	X
7.1.2.3.1	Correct Selection of RACH parameters (FDD)	X	
7.1.2.4a	Access Service class selection for RACH transmission	X	
7.1.3.1	Priority handling between data flows of one UE	X	X
7.1.3.2	TFC Selection	X	

A.6.1 Void

A.6.2 The TTCN Machine Processable form (TTCN.MP)

The TTCN.MP representation corresponding to the corresponding FDD or LCR_TDD ATS is contained in an ASCII file (MAC.MP) which accompanies the present document.

A.7 BMC ATS

Table A.7: BMC TTCN test cases

Test case	Description
-	-

A.7.1 Void

A.7.2 The TTCN Machine Processable form (TTCN.MP)

The TTCN.MP representation corresponding to this ATS is contained in an ASCII file (BMC.MP) which accompanies the present document.

A.8 PDCP ATS

Table A.8: PDCP TTCN test cases

Test case	Description
-	-

A.8.1 Void

A.8.2 The TTCN Machine Processable form (TTCN.MP)

The TTCN.MP representation corresponding to this ATS is contained in an ASCII file (PDCP.MP) which accompanies the present document.

A.9 RAB ATS

The approved RAB test cases are listed. An "X" in columns FDD or LCR TDD indicates the test case approved for the relevant ATS.

Table A.9: RAB TTCN test cases

Test case	Description	FDD	LCR TDD
14.2.4	Conversational / speech / UL:12.2 DL:12.2 kbps / CS RAB + UL:3.4 DL:3.4 kbps SRBs for DCCH	X	
14.2.4a	Conversational / speech / UL:(12.2 7.95 5.9 4.75) DL:(12.2 7.95 5.9 4.75) kbps / CS RAB + UL:3.4 DL:3.4 kbps SRBs for DCCH	X	
14.2.5a	Conversational / speech / UL:(10.2, 6.7, 5.9, 4.75) DL:(10.2, 6.7, 5.9, 4.75) kbps / CS RAB + UL:3.4 DL:3.4 kbps SRBs for DCCH	X	
14.2.7a	Conversational / speech / UL:(7.4, 6.7, 5.9, 4.75) DL:(7.4, 6.7, 5.9, 4.75) kbps / CS RAB + UL:3.4 DL:3.4 kbps SRBs for DCCH	X	
14.2.9	Conversational / speech / UL:5.9 DL:5.9 kbps / CS RAB + UL:3.4 DL:3.4 kbps SRBs for DCCH	X	
14.2.12	Conversational / unknown / UL:28.8 DL:28.8 kbps / CS RAB + UL:3.4 DL:3.4 kbps SRBs for DCCH	X	
14.2.13.1	Conversational / unknown / UL:64 DL:64 kbps / CS RAB + UL:3.4 DL:3.4 kbps SRBs for DCCH / 20 ms TTI	X	
14.2.13.2	Conversational / unknown / UL:64 DL:64 kbps / CS RAB + UL:3.4 DL:3.4 kbps SRBs for DCCH / 40 ms TTI	X	
14.2.14.1	Conversational / unknown / UL:32 DL:32 kbps / CS RAB + UL:3.4 DL:3.4 kbps SRBs for DCCH / 20 ms TTI	X	
14.2.14.2	Conversational / unknown / UL:32 DL:32 kbps / CS RAB + UL:3.4 DL:3.4 kbps SRBs for DCCH / 40 ms TTI	X	
14.2.15	Streaming / unknown / UL:14.4/DL:14.4 kbps / CS RAB + UL:3.4 DL:3.4 kbps SRBs for DCCH	X	
14.2.16	Streaming / unknown / UL:28.8/DL:28.8 kbps / CS RAB + UL:3.4 DL:3.4 kbps SRBs for DCCH	X	
14.2.17	Streaming / unknown / UL:57.6/DL:57.6 kbps / CS RAB + UL:3.4 DL:3.4 kbps SRBs for DCCH	X	
14.2.23a.1	Interactive or background / UL:8 DL:8 kbps / PS RAB + UL:3.4 DL:3.4 kbps SRBs for DCCH	X	
14.2.23a.2	Interactive or background / UL:8 DL:8 kbps / PS RAB + UL:3.4 DL:3.4 kbps SRBs for DCCH / TC	X	
14.2.23b	Interactive or background / UL:16 DL:16 kbps / PS RAB + UL:3.4 DL:3.4 kbps SRBs for DCCH	X	
14.2.23c	Interactive or background / UL:32 DL:32 kbps / PS RAB + UL:3.4 DL:3.4 kbps SRBs for DCCH	X	
14.2.26	Interactive or background / UL:64 DL: 64 kbps / PS RAB + UL:3.4 DL:3.4 kbps SRBs for DCCH	X	

Test case	Description	FDD	LCR TDD
14.2.27	Interactive or background / UL:64 DL:128 kbps / PS RAB + UL:3.4 DL:3.4 kbps SRBs for DCCH	X	
14.2.28	Interactive or background / UL:128 DL:128 kbps / PS RAB + UL:3.4 DL:3.4 kbps SRBs for DCCH	X	
14.2.29	Interactive or background / UL:64 DL:144 kbps / PS RAB + UL:3.4 DL: 3.4 kbps SRBs for DCCH	X	
14.2.31.1	Interactive or background / UL:64 DL:256 kbps / PS RAB + UL:3.4 DL: 3.4 kbps SRBs for DCCH / 10 ms TTI	X	
14.2.32.1	Interactive or background / UL:64 DL:384 kbps / PS RAB + UL:3.4 DL: 3.4 kbps SRBs for DCCH / 10 ms TTI	X	
14.2.32.2	Interactive or background / UL:64 DL:384 kbps / PS RAB + UL:3.4 DL: 3.4 kbps SRBs for DCCH / 20 ms TTI	X	
14.2.34.1	Interactive or background / UL:384 DL:384 kbps / PS RAB + UL:3.4 DL:3.4 kbps SRBs for DCCH / 10 ms TTI	X	
14.2.38a	Conversational / speech / UL:12.2 DL:12.2 kbps / CS RAB + Interactive or background / UL:0 DL:0 kbps / PS RAB + UL:3.4 DL:3.4 kbps SRBs for DCCH	X	
14.2.38b	Conversational / speech / UL:12.2 DL:12.2 kbps / CS RAB + Interactive or background / UL:8 DL:8 kbps / PS RAB + UL:3.4 DL:3.4 kbps SRBs for DCCH	X	
14.2.38c	Conversational / speech / UL:12.2 DL:12.2 kbps / CS RAB + Interactive or background / UL:32 DL:32 kbps / PS RAB + UL:3.4 DL:3.4 kbps SRBs for DCCH	X	
14.2.38e	Conversational / speech / UL:(12.2 7.95 5.9 4.75) DL:(12.2 7.95 5.9 4.75) kbps / CS RAB + Interactive or background / UL:0 DL:0 kbps / PS RAB + UL:3.4 DL:3.4 kbps SRBs for DCCH	X	
14.2.38f	Conversational / speech / UL:(12.2 7.95 5.9 4.75) DL:(12.2 7.95 5.9 4.75) kbps / CS RAB + Interactive or background / UL:8 DL:8 kbps / PS RAB + UL:3.4 DL:3.4 kbps SRBs for DCCH	X	
14.2.40	Conversational / speech / UL:12.2 DL:12.2 kbps / CS RAB + Interactive or background / UL:64 DL:64 kbps / PS RAB+ UL:3.4 DL: 3.4 kbps SRBs for DCCH	X	
14.2.41	Conversational / speech / UL:12.2 DL:12.2 kbps / CS RAB + Interactive or background / UL:64 DL:128 kbps / PS RAB + UL:3.4 DL:3.4 kbps SRBs for DCCH	X	
14.2.43.1	Conversational / speech / UL:12.2 DL:12.2 kbps / CS RAB + Interactive or background / UL:64 DL:384 kbps / PS RAB + UL:3.4 DL:3.4 kbps SRBs for DCCH / 10 ms TTI	X	
14.2.43.2	Conversational / speech / UL:12.2 DL:12.2 kbps / CS RAB + Interactive or background / UL:64 DL:384 kbps / PS RAB + UL:3.4 DL:3.4 kbps SRBs for DCCH / 20 ms TTI	X	
14.2.49.1	Conversational / speech / UL:12.2 DL:12.2 kbps / CS RAB + Conversational / unknown / UL:64 DL:64 kbps / CS RAB + UL:3.4 DL:3.4 kbps SRBs for DCCH / 20 ms TTI	X	
14.2.51.1	Conversational / unknown / UL:64 DL:64 kbps / CS RAB / 20 ms TTI + Interactive or background / UL:64 DL:64 kbps / PS RAB + UL:3.4 DL:3.4 kbps SRBs for DCCH	X	
14.2.51a.1	Conversational / unknown / UL:64 DL:64 kbps / CS RAB / 20 ms TTI + Interactive or background / UL:8 DL:8 kbps / PS RAB	X	
14.2.51b.1	Conversational / unknown / UL:64 DL:64 kbps / CS RAB / 20 ms TTI + Interactive or background / UL:16 DL:64 kbps / PS RAB	X	
14.2.57	Interactive or background / UL:64 DL:64 kbps / PS RAB + Interactive or background / UL:64 DL:64 kbps / PS RAB + UL:3.4 DL:3.4 kbps SRBs for DCCH	X	
14.2.58	Streaming / unknown / UL:16 DL:64 kbps / PS RAB + Interactive or background / UL:8 DL:8 kbps / PS RAB + UL:3.4 DL:3.4 kbps SRBs for DCCH.	X	
14.2.58a	Streaming / unknown / UL:16 DL:128 kbps / PS RAB + Interactive or background / UL:8 DL:8 kbps / PS RAB + UL:3.4 DL:3.4 kbps SRBs for DCCH.	X	
14.4.2.1	One SCCPCH: Interactive/Background 32 kbps PS RAB + SRBs for CCCH + SRB for DCCH + SRB for BCCH	X	
14.4.2.2	Two SCCPCHs: Interactive/Background 32 kbps PS RAB + SRBs for CCCH + SRB for DCCH + SRB for BCCH	X	
14.4.2.3	One SCCPCH/connected mode: Interactive/Background 32 kbps PS RAB + SRBs for CCCH + SRB for DCCH + SRB for BCCH	X	

Test case	Description	FDD	LCR TDD
14.4.2a.1	One SCCPCH: Interactive/Background 32 kbps PS RAB + Interactive/Background 32 kbps PS RAB + SRBs for CCCH + SRB for DCCH + SRB for BCCH	X	
14.4.2a.2	Two SCCPCHs: Interactive/Background 32 kbps PS RAB + Interactive/Background 32 kbps PS RAB + SRBs for CCCH + SRB for DCCH + SRB	X	
14.4.2a.3	One SCCPCH/connected mode: Interactive/Background 32 kbps PS RAB + Interactive/Background 32 kbps PS RAB + SRBs for CCCH + SRB for DCCH + SRB for BCCH	X	
14.4.3	Interactive/Background 32 kbps RAB + SRBs for PCCH + SRB for CCCH + SRB for DCCH + SRB for BCCH	X	
14.4.4	RB for CTCH + SRB for CCCH +SRB for BCCH	X	
18.1.2.4	Conversational / speech / UL:12.2 DL:12.2 kbps / CS RAB + UL:3.4 DL:3.4 kbps SRBs for DCCH		X
18.1.2.6	Conversational / speech / UL:7.95 DL:7.95 kbps / CS RAB + UL:3.4 DL:3.4 kbps SRBs for DCCH		X
18.1.2.7	Conversational / speech / UL:7.4 DL:7.4 kbps / CS RAB+ UL:3.4 DL:3.4 kbps SRBs for DCCH		X
18.1.2.13.1	Conversational / unknown / UL:64 DL:64 kbps / CS RAB / 20 ms TTI		X
18.1.2.13.2	Conversational / unknown / UL:64 DL:64 kbps / CS RAB / 40 ms TTI		X
18.1.2.15	Streaming / unknown / UL:14.4/DL:14.4 kbps / CS RAB + UL:3.4 DL:3.4 kbps SRBs for DCCH		X
18.1.2.26	Interactive or background / UL:64 DL: 64 kbps / PS RAB + UL:3.4 DL:3.4 kbps SRBs for DCCH		X
18.1.2.27	Interactive or background / UL:64 DL:128 kbps / PS RAB + UL:3.4 DL:3.4 kbps SRBs for DCCH		X
18.1.2.32.1	Interactive or background / UL:64 DL:384 kbps / PS RAB / 10 ms TTI		X

A.9.1 Void

A.9.2 The TTCN Machine Processable form (TTCN.MP)

The TTCN.MP representation corresponding to the corresponding FDD or LCR_TDD ATS is contained in an ASCII file (RAB.MP) which accompanies the present document.

A.10 IR_U ATS

The approved IR_U test cases are listed. An "X" in columns FDD or LCR TDD indicates the test case approved for the relevant ATS.

Table A.10: InterRat TTCN test cases

Test case	Description	FDD	LCR_TD D
6.2.1.1	Selection of the correct PLMN and associated RAT	X	
6.2.1.2a	Selection of RAT for HPLMN; Different ITU regions; Manual mode	X	
6.2.1.6	Selection of RAT for HPLMN; Automatic mode	X	
6.2.1.7	Selection of RAT for UPLMN; Automatic mode	X	
6.2.1.8	Selection of RAT for OPLMN; Automatic mode	X	
6.2.1.8a.1	Selection of RAT for OPLMN; Different ITU regions; Automatic mode	X	
6.2.1.8a.2	Selection of RAT for OPLMN; Different ITU regions; Limited service; Automatic mode	X	
6.2.1.8a.3	Selection of RAT for OPLMN; Different ITU regions; No service; Automatic mode	X	
6.2.1.9	Selection of "Other PLMN / access technology combinations"; Automatic mode	X	
6.2.2.1	Cell reselection if cell becomes barred or S<0; UTRAN to GSM	X	
6.2.2.2	Cell reselection if cell becomes barred or C1<0; GSM to; UTRAN	X	
6.2.2.3	Cell reselection timings; GSM to UTRAN	X	
8.1.2.12	RRC Connection Establishment: Reject with interRATInfo is set to GSM	X	
8.1.2.13	RRC Connection Establishment: Reject with InterRATInfo is set to GSM and selection to the designated system fails	X	

Test case	Description	FDD	LCR_TD D
8.3.7.1	Inter system handover from UTRAN/To GSM/Speech/Success	X	
8.3.7.2	Inter system handover from UTRAN/To GSM/Data/Same data rate/Success	X	
8.3.7.3	Inter system handover from UTRAN/To GSM/Data/Data rate down grading/Success	X	
8.3.7.4	Inter system handover from UTRAN/To GSM/Speech/Establishment/Success	X	
8.3.7.5	Inter system handover from UTRAN/To GSM/Speech/Failure	X	
8.3.7.7	Inter system handover from UTRAN/To GSM/Speech/Failure (L1 Synchronization)	X	
8.3.7.9	Inter system handover from UTRAN/To GSM/Speech/Failure (Unsupported configuration)	X	
8.3.7.12	Inter system handover from UTRAN/To GSM/Speech/Failure (Physical channel Failure and Reversion Failure)	X	
8.3.7.13	Inter system handover from UTRAN/To GSM/ success / call under establishment	X	
8.3.7.16	Inter system handover from UTRAN/To GSM/Simultaneous CS and PS domain services/Success/TBF Establishment Success	X	
8.3.7.17	Inter system handover from UTRAN/To GSM/DTM Support/Simultaneous CS and PS domain services/Success	X	
8.3.9.1	Cell reselection if cell becomes barred or $S < 0$; UTRAN to GPRS (CELL_FACH)	X	
8.3.9.3	Cell reselection fails if $S < 0$; UTRAN to GPRS (CELL_FACH)	X	
8.3.9.5	Cell Reselection with RAU - Qoffset value modification; UTRAN to GPRS (CELL_FACH)	X	
8.3.11.1	Cell change order from UTRAN/To GPRS/CELL_DCH/Success	X	
8.3.11.4	Cell change order from UTRAN/To GPRS/CELL_DCH/Failure (Physical channel & Reversion Failure)	X	
8.4.1.31	RRC / Measurement Control and Report: Inter-RAT measurement in CELL_DCH state	X	
8.4.1.33	Measurement Control and Report: Inter-RAT measurement, event 3a	X	
8.4.1.34	Measurement Control and Report: Inter-RAT measurement, event 3b	X	
8.4.1.35	Measurement Control and Report: Inter-RAT measurement, event 3c	X	
8.4.1.36	Measurement Control and Report: Inter-RAT measurement, event 3d	X	
8.4.1.40	Measurement Control and Report: Inter-RAT measurement event 3C in CELL_DCH state using sparse compressed mode pattern	X	
8.4.1.48	Measurement Control and Report: Combined Inter-frequency measurement for event 2b and Inter-RAT measurement, event 3a (FDD)	X	
12.8	GMM READY timer handling	X	

A.10.1 Void

A.10.2 The TTCN Machine Processable form (TTCN.MP)

The TTCN.MP representation corresponding to the corresponding FDD or LCR_TDD ATS is contained in an ASCII file (IR_U.MP) which accompanies the present document.

A.11 AGPS ATS

The approved AGPS test cases are listed. An "X" in columns FDD or LCR TDD indicates the test case approved for the relevant ATS.

Table A.11: AGPS TTCN test cases

Test case		Description	FDD	LCR_TDD
TS 34.123-3	TS 37.571-2			
17.2.2.1	6.1.1.1	LCS Network Induced location request/ UE-Based GPS/ Emergency Call / with USIM	X	
17.2.2.2	6.1.1.2	LCS Network Induced location request/ UE-Based GPS/ Emergency Call / without USIM	X	
17.2.2.3	6.1.1.3	LCS Network induced location request/ UE-Assisted GPS/ Emergency call/ With USIM	X	
17.2.2.4	6.1.1.4	LCS Network induced location request/ UE-Assisted GPS/ Emergency call/ Without USIM	X	
17.2.3.2	6.1.2.1	LCS Mobile originated location request/ UE-Based GPS/ Position estimate request/ Success	X	
17.2.3.9	6.1.2.7	LCS Mobile originated location request/ UE-Based GPS/ Position estimate request/ Failure	X	
17.2.4.1	6.1.3.1	LCS Mobile terminated location request/ UE-Based GPS	X	
17.2.4.2	6.1.3.2	LCS Mobile-terminated location request/UE-Based GPS/ Request for additional assistance data/ Success	X	
17.2.4.3	6.1.3.3	LCS Mobile-terminated location request/UE-Based GPS/ Failure – Not Enough Satellites	X	
17.2.4.4	6.1.3.4	LCS Mobile terminated location request/ UE-Assisted GPS/ Success	X	
17.2.4.5	6.1.3.5	LCS Mobile terminated location request/ UE-Assisted GPS/ Request for additional assistance data/ Success	X	
17.2.4.7	6.1.3.7	LCS Mobile terminated location request/ UE-Based GPS/ Privacy Verification/ Location Not Allowed if No Response	X	

NOTE: Test cases in the ATS are numbered following TS 34.123-1[1]; the prose descriptions can be found in TS 37.571-2 [63] under the indicated test case number.

A.11.1 Void

A.11.2 The TTCN Machine Processable form (TTCN.MP)

The TTCN.MP representation corresponding to the corresponding FDD or LCR_TDD ATS is contained in an ASCII file (AGPS.MP) which accompanies the present document.

A.12 HSD_ENH ATS

The approved HSD_ENH test cases are listed. An "X" in columns FDD or LCR TDD indicates the test case approved for the relevant ATS.

Table A.12: HSDPA and Rel-5 enhancement TTCN test cases

Test case	Description	FDD	LCR_TDD
6.1.2.10	HCS inter-frequency cell reselection	X	
6.1.2.10a	HCS inter-frequency cell reselection for inter-band operation	X	
7.1.5.1	MAC-hs reordering and stall avoidance	X	
7.1.5.2	MAC-hs priority queue handling	X	
7.1.5.3	MAC-hs PDU header handling	X	
7.1.5.4	MAC-hs retransmissions	X	
7.1.5.5	MAC-hs reset	X	
7.1.5.6	MAC-hs transport block size selection	X	

Test case	Description	FDD	LCR_TDD
8.1.1.6a	Paging for notification of synchronised BCCH modification in idle mode using BCCH modification time	X	
8.1.2.14	RRC Connection Establishment using the default configuration for 3.4 kbps signalling bearers	X	
8.1.2.15	RRC Connection Establishment using the default configuration for 13.6 kbps signalling bearers	X	
8.1.6.5	Initial Direct Transfer: Inclusion of establishment cause	X	
8.2.1.27	RRC / Radio Bearer Establishment for transition from CELL_DCH to CELL_DCH: Success (two radio links, start of HS-DSCH reception)	X	
8.2.1.28	RRC/Radio Bearer Establishment for transition from CELL_DCH to CELL_DCH: Success (RB mapping for both DL DCH and HS-DSCH in cell without HS-DSCH support)	X	X
8.2.1.29	Radio Bearer Establishment for transition from CELL_DCH to CELL_DCH: Success (Timing re-initialized hard handover to another frequency, uplink TFCS restriction and start of HS-DSCH reception)	X	X
8.2.1.30	Radio Bearer Establishment for transition from CELL_DCH to CELL_DCH: Success (Timing re-initialised hard handover to another frequency, start of HS-DSCH reception)	X	X
8.2.1.31	Radio Bearer Establishment for transition from CELL_FACH to CELL_DCH: Success (start of HS-DSCH reception)	X	X
8.2.1.32	Radio Bearer Establishment for transition from CELL_FACH to CELL_DCH: Success (start of HS-DSCH reception with frequency modification)	X	X
8.2.2.36	RRC / Radio Bearer Reconfiguration for transition from CELL_DCH to CELL_DCH: Success (Start and stop of HS-DSCH reception)	X	
8.2.2.38	Radio Bearer Reconfiguration from CELL_DCH to CELL_DCH: Success (with active HS-DSCH reception)	X	X
8.2.2.39	Radio Bearer Reconfiguration for transition from CELL_DCH to CELL_DCH: Success (Timing re-initialised hard handover to another frequency, start and stop of HS-DSCH reception)	X	X
8.2.2.40	Radio Bearer Reconfiguration for transition from CELL_DCH to CELL_FACH and from CELL_FACH to CELL_DCH: Success (frequency band modification, start and stop of HS-DSCH reception)	X	X
8.2.2.41	Radio Bearer Reconfiguration for transition from CELL_DCH to CELL_DCH: Success (Start and stop of HS-DSCH reception, during an active CS bearer)	X	X
8.2.2.42	Radio Bearer Reconfiguration for transition from CELL_DCH to CELL_DCH: Success (Timing re-initialised hard handover to another frequency, start and stop of HS-DSCH reception, during an active CS bearer)	X	X
8.2.2.50	Radio Bearer Reconfiguration from CELL_DCH to CELL_DCH: Success (from speech to speech plus PS data with modification of downlink spreading factor)	X	
8.2.3.30	RRC / Radio Bearer Release for transition from CELL_DCH to CELL_DCH: Success (stop of HS-DSCH reception)	X	X
8.2.3.31	Radio Bearer Release for transition from CELL_DCH to CELL_DCH: Success (With active HS-DSCH reception)	X	
8.2.3.32	Radio Bearer Release for transition from CELL_DCH to CELL_DCH: Success (Timing re-initialised hard handover to another frequency, with active HS-DSCH reception)	X	X
8.2.3.33	Radio Bearer Release for transition from CELL_DCH to CELL_DCH: Success (stop of HS-DSCH reception with frequency modification)	X	X
8.2.3.34	Radio Bearer Release for transition from CELL_DCH to CELL_FACH: Success (stop of HS-DSCH reception with frequency modification)	X	X
8.2.3.35	Radio Bearer Release for transition from CELL_DCH to CELL_PCH: Success (stop of HS-DSCH reception)	X	X
8.2.4.36	Transport Channel Reconfiguration from CELL_DCH to CELL_DCH: Success (with active HS-DSCH reception, not changing the value of TTI during UL rate modification)	X	
8.2.6.39a	Physical Channel Reconfiguration for transition from CELL_DCH to CELL_DCH: Success (serving HS-DSCH cell change without MAC-hs reset)	X	
8.2.6.39b	Physical Channel Reconfiguration for transition from CELL_DCH to CELL_DCH: Success (serving HS-DSCH cell change with MAC-hs reset)	X	X
8.2.6.40	Physical Channel Reconfiguration for transition from CELL_DCH to CELL_DCH: Success (Two radio links, change of HS-PDSCH configuration)	X	
8.2.6.40a	Physical Channel Reconfiguration for transition from CELL_DCH to CELL_DCH: Success (change of HS-PDSCH configuration)		X
8.2.6.41	Physical Channel Reconfiguration for transition from CELL_DCH to CELL_DCH: Success (Timing re-initialised hard handover to another frequency, signalling only)	X	

Test case	Description	FDD	LCR_TDD
8.2.6.42	Physical Channel Reconfiguration for transition from CELL_DCH to CELL_DCH: Success (Timing re-initialized hard handover to another frequency, Serving HS-DSCH cell change)	X	X
8.2.6.46	Physical channel reconfiguration for transition from CELL_DCH to CELL_DCH (Hard handover to another frequency with timing re-initialised. Serving HS-DSCH cell change): Failure (Physical channel failure and reversion to old channel)	X	X
8.2.6.48	Physical Channel Reconfiguration for transition from CELL_DCH to CELL_DCH: Success (Timing re-initialized hard handover to another frequency, serving HS-DSCH cell change, compressed mode)	X	
8.2.6.49	Physical Channel Reconfiguration from CELL_DCH to URA_PCH: Success (stop of HS-DSCH reception)	X	X
8.3.1.32	Cell Update: Transition from URA_PCH to CELL_DCH, start of HS-DSCH reception	X	X
8.3.1.33	Cell Update: Transition from CELL_PCH to CELL_DCH, start of HS-DSCH reception, frequency band modification	X	
8.3.1.34	Cell Update: Transition from CELL_DCH to CELL_FACH, stop of HS-DSCH reception	X	X
8.3.1.35	Cell Update: Transition from CELL_DCH to CELL_DCH, with active HS-DSCH reception	X	X
8.3.1.36	Cell Update: Transition from CELL_DCH to CELL_FACH (stop of HS-DSCH reception with frequency modification)	X	X
8.3.1.37	Cell Update: Transition from CELL_DCH to CELL_DCH (with active HS-DSCH reception and frequency modification)	X	X
8.3.1.38	Cell Update: state specific handling of Treselection and Qhyst for cell reselection in CELL_FACH	X	
8.3.1.39	Cell Update: state specific handling of Treselection and Qhyst for cell reselection in CELL_PCH	X	
8.3.1.40	Cell update: Transition from CELL_PCH to CELL_DCH, inclusion of establishment cause	X	
8.3.4.9	Active set update in soft handover: Radio Link removal (stop of HS-PDSCH reception)	X	
8.3.7.14	Inter system handover from UTRAN/To GSM/Speech/Success (stop of HS-DSCH reception)	X	
8.3.11.9	Inter-RAT Cell Change Order from UTRAN to GPRS/CELL_DCH/Success (stop of HS-DSCH reception)	X	
8.3.11.10	Inter-RAT Cell Change Order from UTRAN to GPRS/CELL_DCH/Failure (Physical channel Failure, stop of HS-DSCH reception)	X	
8.3.11.12	Inter-RAT cell change order from UTRAN/To GPRS/CELL_DCH/Network Assisted Cell Change/Success	X	
8.3.11.13	Inter-RAT cell change order from UTRAN/To GPRS/CELL_DCH/Failure (T309 expiry)	X	
8.4.1.47	Measurement Control and Report: Event triggered periodic measurement for event 1B (FDD)	X	
11.1.1.1a	Attach initiated by context activation/QoS Offered by Network is the QoS Requested/Correct handling of QoS extensions for rates above 8640 kbps	X	
14.2.4b	Conversational / speech / UL:(12.2 7.4 5.9 4.75) DL:(12.2 7.4 5.9 4.75) kbps / CS RAB + UL:3.4 DL:3.4 kbps SRBs for DCCH + DL:0.15 kbps SRB#5 for DCCH	X	
14.2.62	Conversational / speech / UL:(12.65 8.85 6.6) DL:(12.65 8.85 6.6) kbps / CS RAB + UL:3.4 DL:3.4 kbps SRBs for DCCH + DL:0.15 kbps SRB#5 for DCCH.	X	
14.6.1	Interactive or background / UL:64 DL: [max bit rate depending on UE category] / PS RAB + UL:3.4 DL:3.4 kbps SRBs for DCCH	X	
14.6.1a	Interactive or background / UL:128 DL: [max bit rate depending on UE category] / PS RAB + UL:3.4 DL:3.4 kbps SRBs for DCCH	X	
14.6.2	Interactive or background / UL:384 DL: [max bit rate depending on UE category] / PS RAB + UL:3.4 DL:3.4 kbps SRBs for DCCH	X	
14.6.3	Conversational / speech / UL:12.2 DL:12.2 kbps / CS RAB + Interactive or background / UL:384 DL:[Bit rate depending on the UE category] / PS RAB + UL:3.4 DL:3.4 kbps SRBs for DCCH	X	
14.6.3a	Conversational / speech / UL:12.2 DL:12.2 kbps / CS RAB + Interactive or background / UL: 64 DL:[Bit rate depending on the UE category] / PS RAB + UL:3.4 DL:3.4 kbps SRBs for DCCH	X	
14.6.4	Conversational / unknown / UL:64 DL:64 kbps / CS RAB + Interactive or background / UL:384 DL:[Bit rate depending on the UE category] / PS RAB + UL:3.4 DL:3.4 kbps SRBs for DCCH	X	

Test case	Description	FDD	LCR_TDD
14.6.4a	Conversational / unknown / UL:64 DL:64 kbps / CS RAB + Interactive or background / UL:64 DL:[Bit rate depending on the UE category] / PS RAB + UL:3.4 DL:3.4 kbps SRBs for DCCH	X	
14.6.5	Interactive or background / UL:384 DL:[Bit rate depending on the UE category] / PS RAB + Interactive or background / UL:384 DL:[Bit rate depending on the UE category] / PS RAB + UL:3.4 DL:3.4 kbps SRBs for DCCH	X	
14.6.5a	Interactive or background / UL:64 DL:[Bit rate depending on the UE category] / PS RAB + Interactive or background / UL:64 DL:[Bit rate depending on the UE category] / PS RAB + UL:3.4 DL:3.4 kbps SRBs for DCCH	X	
14.6.6	Streaming / unknown / UL:128 DL: [min 128, max bit rate depending on UE category] kbps / PS RAB + Interactive or background / UL:128 DL: [max bit rate depending on UE category] / PS RAB + UL:3.4 DL:3.4 kbps SRBs for DCCH	X	
14.6.7	Conversational / speech / UL:12.2 DL:12.2 kbps / CS RAB + Streaming / unknown / UL:128 DL: [guaranteed 128, max bit rate depending on UE category] kbps / PS RAB + Interactive or background / UL:128 DL: [max bit rate depending on UE category] / PS RAB + UL:3.4 DL:3.4 kbps SRBs for DCCH	X	
14.6.8	Conversational / speech / UL:(12.65 8.85 6.6) DL:(12.65 8.85 6.6) kbps / CS RAB + Interactive or Background / UL:384 DL:[Bit rate depending on the UE category] / PS RAB+ UL:3.4 DL:3.4 kbps SRBs for DCCH + DL:0.15 kbps SRB#5 for DCCH	X	

A.12.1 Void

A.12.2 The TTCN Machine Processable form (TTCN.MP)

The TTCN.MP representation corresponding to the corresponding FDD or LCR_TDD ATS is contained in an ASCII file (HSD_ENH.MP) which accompanies the present document.

A.13 HSU_ENH ATS

The approved HSU_ENH test cases are listed. An "X" in columns FDD or LCR TDD indicates the test case approved for the relevant ATS.

Table A.13: EDCH and Rel-6 enhancement TTCN test cases

Test case	Description	FDD	LCR_TDD
6.1.1.8	PLMN selection in shared network environment, Automatic mode	X	
6.1.1.9	PLMN selection in shared network environment, Manual Mode	X	
6.1.2.11	Cell reselection in shared network environment	X	
6.2.1.10	Selection of PLMN and RAT in shared network environment, Automatic mode	X	
6.2.1.11	Selection of PLMN and RAT in shared network environment, Manual Mode	X	
6.2.2.4	Cell reselection in multi-mode shared network environment	X	
6.2.2.5	Cell reselection using SIB18; UTRAN to GSM	X	
7.1.6.1.1	MAC-es/e multiplexing without RRC restrictions	X	
7.1.6.1.2	MAC-es/e multiplexing with RRC restrictions	X	
7.1.6.1.3	Correct settings of MAC-es/e header fields	X	
7.1.6.2.1	Correct settings of MAC-es/e scheduling information	X	
7.1.6.2.2	Happy bit setting	X	
7.1.6.2.3	MAC-es/e non-scheduled transmissions	X	
7.1.6.2.4	MAC-es/e correct handling of scheduled transmissions when absolute grant varies	X	
7.1.6.2.5	MAC-es/e de-activation and re-activation of HARQ processes	X	
7.1.6.2.6	MAC-es/e correct handling of relative grants	X	
7.1.6.2.7	MAC-es/e correct handling of absolute grants on Primary and Secondary E-RNTI	X	
7.1.6.2.8	MAC-es/e combined non-scheduled and scheduled transmissions	X	
7.1.6.2.9	MAC-es/e Correct handling of HARQ profile power offsets	X	
7.1.6.2.10	MAC-es/e Correct handling of minimum set of E-TFCI	X	
7.1.6.3.1	MAC-es/e E-TFC priority	X	

Test case	Description	FDD	LCR_TDD
7.1.6.3.2	MAC-es/e transport block size selection/ UL QPSK	X	
7.1.6.4.1	MAC-es/e process handling	X	
7.1.6.4.2	MAC-es/e maximum number of retransmissions	X	
7.1.6.4.3	MAC-es/e Correct handling of MAC-es/e reset	X	
8.1.1.11	Paging for Connection in idle mode (Shared Network Environment)	X	
8.1.2.16	RRC Connection Establishment / Domain Specific Access Control: Success	X	
8.1.2.17	RRC Connection Establishment for transition from Idle Mode to CELL_DCH: Success (start of E-DCH transmission)	X	
8.1.2.18	RRC Connection Establishment using the default configuration for HS-DSCH / E-DCH signalling bearers	X	
8.2.1.35	Radio Bearer Establishment for transition from CELL_DCH to CELL_DCH: Success (start of E-DCH transmission)	X	
8.2.1.36	Radio Bearer Establishment for transition from CELL_DCH to CELL_DCH: Success (hard handover to another frequency, start of E-DCH transmission)	X	
8.2.1.36a	Radio Bearer Establishment for transition from CELL_DCH to CELL_DCH using F-DPCH: Success (hard handover to another frequency, start of E-DCH transmission, F-DPCH configured)	X	
8.2.2.44	Radio Bearer Reconfiguration from CELL_DCH to CELL_DCH: Success (With active E-DCH transmission)	X	
8.2.2.44a	Radio Bearer Reconfiguration from CELL_DCH to CELL_DCH: Success (With active E-DCH transmission, F-DPCH configured)	X	
8.2.2.45	Radio Bearer Reconfiguration for transition from CELL_FACH to CELL_DCH and CELL_DCH to CELL_FACH: Success (start and stop of E-DCH transmission)	X	
8.2.2.46	Radio Bearer Reconfiguration for transition from CELL_DCH to CELL_DCH: Success (hard handover to another frequency, start and stop of E-DCH transmission)	X	
8.2.2.47	Radio Bearer Reconfiguration for transition from CELL_FACH to CELL_DCH and CELL_DCH to CELL_FACH: Success (frequency modification, start and stop of E-DCH transmission)	X	
8.2.2.47a	Radio Bearer Reconfiguration for transition from CELL_FACH to CELL_DCH and CELL_DCH to CELL_FACH: Success (frequency modification, start and stop of E-DCH transmission, F-DPCH Configured)	X	
8.2.2.48	Radio Bearer Reconfiguration for transition from CELL_DCH to CELL_DCH: Success (Start and stop of E-DCH transmission)	X	
8.2.2.49	Radio Bearer Reconfiguration for transition from CELL_DCH to CELL_PCH: Success (stop of E-DCH transmission)	X	
8.2.3.36	Radio Bearer Release for transition from CELL_DCH to CELL_DCH: Success (frequency modification, stop of E-DCH transmission)	X	
8.2.6.50	Physical Channel Reconfiguration for transition from CELL_DCH to URA_PCH: Success (frequency modification, stop of E-DCH transmission)	X	
8.2.6.51	Physical Channel Reconfiguration for transition from CELL_DCH to CELL_DCH: Success (serving E-DCH cell change)	X	
8.2.6.52	Physical channel reconfiguration for transition from CELL_DCH to CELL_DCH: Success (Timing re-initialized hard handover to another frequency, Serving E-DCH cell change, compressed mode)	X	
8.2.6.54	Physical Channel Reconfiguration for transition from CELL_DCH to CELL_DCH: Failure (Timing re-initialized hard handover, Serving E-DCH cell change, physical channel failure and reversion to old channel)	X	
8.3.1.41	Cell Update: Transition from URA_PCH to CELL_DCH: Success (start of E-DCH transmission)	X	
8.3.1.42	Cell Update: Transition from CELL_PCH to CELL_DCH: Success (frequency modification, start of E-DCH transmission)	X	
8.3.1.42a	Cell Update: Transition from CELL_PCH to CELL_DCH: Success (frequency modification, start of E-DCH transmission, F-DPCH Configured)	X	
8.3.1.43	Cell Update: Radio Link Failure, with active E-DCH transmission	X	
8.3.3.4	UTRAN Mobility Information: Shared Network	X	
8.3.4.10	Active set update in soft handover: Radio Link addition and serving HS-DSCH / E-DCH cell change	X	
8.3.7.1a	Inter system handover from UTRAN/To GSM/Speech/Success with A5/3 ciphering	X	
8.3.11.14	Inter-RAT Cell Change Order from UTRAN to GPRS/CELL_DCH/Success (stop of E-DCH transmission)	X	
8.4.1.49	Measurement Control and Report: Intra-frequency measurement for event 1J	X	
9.4.3.6	Location updating /abnormal cases / CS domain is changed from barred to unbarred because of domain specific access control	X	
9.5.9	MM connection / abnormal cases / CS domain barred because of domain specific access control	X	

Test case	Description	FDD	LCR_TDD
12.2.1.12	PS attach / abnormal cases / access barred due to domain specific access restriction for PS domain	X	
12.4.2.11	Combined routing area updating / abnormal cases / access barred due to domain specific access restriction for CS domain	X	
12.4.2.12	Combined routing area updating / abnormal cases / access barred due to domain specific access restriction for PS domain	X	
12.9.15	Service Request / abnormal cases / access barred due to domain specific access restriction for PS domain	X	
14.7.1	Interactive or background / UL: [max bit rate depending on UE category and TTI] DL: [max bit rate depending on UE category] / PS RAB + UL:3.4 DL:3.4 kbps SRBs for DCCH on DCH	X	
14.7.2	Streaming or interactive or background / UL: [max bit rate depending on UE category and TTI] DL: [max bit rate depending on UE category] / PS RAB + UL:[max bit rate depending on UE category and TTI] DL:3.4 kbps SRBs for DCCH on E-DCH and DL DCH	X	
14.7.3	Streaming or interactive or background / UL: [max bit rate depending on UE category and TTI] DL: [max bit rate depending on UE category] / PS RAB + UL: [max bit rate depending on UE category and TTI] DL: [max bit rate depending on UE category] SRBs for DCCH on E-DCH and HS-DSCH	X	
14.7.4	Conversational / speech / UL:12.2 DL:12.2 kbps / CS RAB + Streaming or interactive or background / UL: [max bit rate depending on UE category and TTI] DL: [max bit rate depending on UE category] / PS RAB + UL:3.4 DL:3.4 kbps SRBs for DCCH	X	
14.7.5	Streaming or interactive or background / UL:[max bit rate depending on UE category and TTI] DL: [max bit rate depending on UE category] kbps / PS RAB + Streaming or interactive or background / UL: [max bit rate depending on UE category and TTI] DL: [max bit rate depending on UE category] / PS RAB + UL:[max bit rate depending on UE category and TTI] DL:3.4 kbps SRBs for DCCH on E-DCH and DL DCH	X	
14.7.6	Conversational / unknown or speech / UL:[max bit rate depending on UE category and TTI] DL: [max bit rate depending on UE category] kbps / PS RAB + Streaming or Interactive or background / UL: [max bit rate depending on UE category and TTI] DL: [max bit rate depending on UE category] / PS RAB + UL:[max bit rate depending on UE category and TTI] DL: [max bit rate depending on UE category] SRBs for DCCH on E-DCH and HS-DSCH	X	
14.7.7	Conversational / unknown or speech / UL:[max bit rate depending on UE category and TTI] DL: [max bit rate depending on UE category] kbps / PS RAB + Streaming or Interactive or background / UL: [max bit rate depending on UE category and TTI] DL: [max bit rate depending on UE category] / PS RAB + Streaming or Interactive or background / UL: [max bit rate depending on UE category and TTI] DL: [max bit rate depending on UE category] / PS RAB + UL:[max bit rate depending on UE category and TTI] DL: [max bit rate depending on UE category] SRBs for DCCH on E-DCH and HS-DSCH	X	
14.7.8	Conversational / speech / UL:(12.65 8.85 6.6) DL:(12.65 8.85 6.6) kbps / CS RAB + Streaming or interactive or background / UL: [max bit rate depending on UE category and TTI] DL: [max bit rate depending on UE category] / PS RAB + UL:3.4 DL:3.4 kbps SRBs for DCCH + DL:0.15 kbps SRB#5 for DCCH	X	

A.13.1 Void

A.13.2 The TTCN Machine Processable form (TTCN.MP)

The TTCN.MP representation corresponding to the corresponding FDD or LCR_TDD ATS is contained in an ASCII file (HSU_ENH.MP) which accompanies the present document.

A.14 MBMS ATS

The approved MBMS test cases are listed. An "X" in columns FDD or LCR TDD indicates the test case approved for the relevant ATS.

Table A.14: MBMS and Rel-6 enhancement TTCN test cases

Test case	Description	FDD	LCR_TDD
7.2.4.2	MTCH duplicate avoidance and reordering / MBMS Broadcast Service	X	
7.2.4.3	MCCH Out Of Sequence Delivery handling / MBMS Broadcast Service	X	
8.5.1.2	MBMS PTP Session Start at MCCH Notification in CELL_PCH / MBMS Selected Service	X	
8.5.1.3	MBMS PTM Session Start at MCCH Acquisition in CELL_FACH state / MBMS Broadcast Service	X	
8.5.1.4	MBMS PTM Session Start at MCCH Notification in CELL_DCH state / MBMS Broadcast Service	X	
8.5.1.5	MBMS PTM Session Start at MCCH Acquisition in CELL_DCH (for a non-MBMS service) when entering into an MBMS cell (UE capable of MBMS p-t-m reception in CELL_DCH) / MBMS Broadcast Service	X	
8.5.1.9	MBMS PTM Session Start at MCCH Notification in Idle Mode / MBMS Broadcast Service	X	
8.5.1.11	MBMS PTP Session Start at MCCH Notification in Idle Mode / MBMS Selected Service	X	
8.5.1.12	MBMS PTP Session Start at MCCH Notification in URA_PCH / MBMS Selected Service	X	
8.5.1.13	MBMS PTP Session Start at MCCH Notification in CELL_FACH / MBMS Selected Service	X	
8.5.2.2	MBMS PTM Session Reconfiguration – Transfer Mode Change to PTP / MBMS Selected Service	X	
8.5.2.3	MBMS PTP Session Reconfiguration - Transfer mode change to PTM / MBMS Selected Service	X	
8.5.2.4	MBMS PTM Session Reconfiguration – MTCH data rate change / MBMS Broadcast Service	X	
8.5.3.1	MBMS Session Start (Frequency Layer Convergence)/Session Stop (Frequency Layer Dispersion) in Idle mode / MBMS Selected Service	X	
8.5.3.2	MBMS Session Start (Frequency Layer Convergence)/Session Stop (Frequency Layer Dispersion) in CELL_PCH / MBMS Broadcast Service	X	
8.5.3.3	MBMS Session Start (Frequency Layer Convergence)/Session Stop (Frequency Layer Dispersion) in CELL_FACH / MBMS Broadcast Service	X	
8.5.4.1	Transmission of the MBMS Selected Services Information when entering RRC connected mode and CELL_DCH state / MBMS Selected Service	X	
8.5.4.2	Modification of the MBMS Selected Services list whilst in URA_PCH & Cell_FACH / MBMS Selected Service	X	
8.5.4.3	Testing of the MBMS Selected Services indication from the network whilst in CELL_DCH / MBMS Selected Service	X	
8.5.5.1	MBMS Counting in Idle Mode / MBMS Selected Service	X	
8.5.5.2	MBMS Counting in CELL_FACH / MBMS Selected Service	X	
8.5.5.3	MBMS No Counting in CELL_DCH / MBMS Selected Service	X	
8.5.5.4	MBMS Counting in CELL_PCH / MBMS Selected Service	X	
8.5.5.7	RRC Connection establishment for MBMS Counting :Success after T318 Timeout/ MBMS Selected Service	X	
8.5.5.8	RRC Connection establishment for MBMS Counting :Success after MAC Layer Failure Indication/ MBMS Selected Service	X	
8.5.6.1	MBMS Controlling Cell Change - Idle mode - Frequency Layer Convergence – HCS Not Used / MBMS Selected Service	X	
11.8.2	MBMS Service Request procedure collision with Routing Area Update/ MBMS Selected Service	X	
12.9.16	MBMS SERVICE REQUEST / counting / MBMS Selected Service	X	
12.9.17	MBMS SERVICE REQUEST / point to point RBs / MBMS Selected Service	X	
14.4.5	64.8kbps RB for MTCH with 80 ms TTI / MBMS Broadcast Service	X	
14.4.6	129.6 kbps RB for MTCH with 80 ms TTI / MBMS Broadcast Service	X	
14.4.7	259.2 kbps RB for MTCH with 40 ms TTI / MBMS Broadcast Service	X	
14.6.9	Streaming MBMS PTP / unknown / UL:16 DL: [max bit rate depending on UE category] kbps / PS RAB + UL:3.4 DL:3.4 kbps SRBs for DCCH / MBMS Selected Service	X	

Test case	Description	FDD	LCR_TDD
14.6.10	Streaming MBMS PTP / unknown / UL:16 DL: [max bit rate depending on UE category] kbps / PS RAB + Interactive or background / UL:64 DL: [max bit rate depending on UE category] / PS RAB + Interactive or background / UL:64 DL: [max bit rate depending on UE category] / PS RAB + UL:3.4 DL:3.4 kbps SRBs for DCCH / MBMS Selected Service	X	

A.14.1 Void

A.14.2 The TTCN Machine Processable form (TTCN.MP)

The TTCN.MP representation corresponding to the corresponding FDD or LCR_TDD ATS is not any more included in the present document.

A.15 HSPA7_ENH ATS

The approved HSPA7_ENH test cases are listed. An "X" in columns FDD or LCR TDD indicates the test case approved for the relevant ATS.

Table A.15: HSPA and Rel-7 enhancement TTCN test cases

Test case	Description	FDD	LCR_TDD
6.1.1.12	Displaying EHPLMNs in manual mode	X	
6.1.1.13	PLMN selection of RPLMN or (E)HPLMN; Automatic mode	X	
6.1.1.14	Network selection mode at switch-on	X	
6.1.1.15	Exception in manual network selection mode when HPLMN is available at power-on	X	
7.1.5a.1	MAC-ehs multiplexing / multiple logical channels on same queue	X	
7.1.5a.2	MAC-ehs multiplexing / multiple logical channels on multiple queues	X	
7.1.5a.3	MAC-ehs segmentation / UE handling of partial and full PDUs	X	
7.1.5a.4	MAC-ehs reordering and stall avoidance	X	
7.1.5a.5.2	MAC-ehs transport block size selection / QPSK and 16QAM	X	
7.1.5a.5.3	MAC-ehs transport block size selection / 64QAM	X	
7.1.5a.6	UE Identification on HS-PDSCH in CELL_FACH	X	
7.1.5a.7	HARQ retransmissions without ACK/NACK signalling in CELL_FACH	X	
7.1.6.3.3	Impact on E-TFCI selection on MAC at UE for UL DRX at Node B/ MAC Inactivity Threshold>1	X	
7.1.6.3.4	Impact on E-TFCI selection on MAC at UE for UL DRX at Node B/ MAC Inactivity Threshold =1	X	
7.2.2.14	Flexible handling of RLC PDU sizes for UM RLC in downlink	X	
7.2.3.36	Flexible handling of RLC PDU sizes for AM RLC	X	
8.1.1.5a	Paging on HS-DSCH for notification of BCCH modification in CELL_PCH	X	
8.1.1.12	Paging for Connection in connected mode (CELL_PCH) without HS-SCCH	X	
8.1.2.19	RRC Connection Establishment for transition from Idle Mode to CELL_DCH: Success (start of E-DCH transmission)	X	
8.1.2.20	RRC Connection Establishment for transition from Idle Mode to CELL_FACH: Success (Start of HS-DSCH Reception)	X	
8.1.7.3	Security mode command in CELL_DCH state (UEA2/UIA2, CS Domain)	X	
8.1.7.3b	Security mode command in CELL_DCH state (UEA2/UIA2, PS Domain)	X	
8.1.7.3c	Security mode control in CELL_DCH state (UEA2/UIA2, CN Domain switch and new keys at RRC message sequence number wrap around)	X	
8.1.7.3d	Security mode control in CELL_DCH state interrupted by a cell update (UEA2/UIA2)	X	
8.1.7.4	Security mode command in CELL_FACH state (UEA2/UIA2)	X	
8.1.10.2	BCCH Mapping on HS-DSCH for Transmitting System Information Change Indication	X	
8.2.1.38	Radio Bearer Establishment for transition from CELL_DCH to CELL_DCH: Success (start of discontinuous uplink transmission)	X	

Test case	Description	FDD	LCR_TDD
8.2.1.39	Radio Bearer Establishment for transition from CELL_DCH to CELL_DCH: Success (start of HS-SCCH less operation)	X	
8.2.1.40	Radio Bearer Establishment for transition from CELL_DCH to CELL_DCH: Success (hard handover to another frequency, start of discontinuous uplink transmission)	X	
8.2.2.43a	Radio Bearer Reconfiguration for transition from CELL_DCH to CELL_DCH: Success (Seamless SRNS relocation, UEA2/UIA2, without pending of ciphering, frequency modification)	X	
8.2.2.43b	Radio Bearer Reconfiguration for transition from CELL_DCH to CELL_DCH: Success (Seamless SRNS relocation, change of ciphering and integrity protection algorithms, frequency modification)	X	
8.2.2.51	Radio Bearer Reconfiguration from CELL_DCH to CELL_DCH: Success (With active discontinuous uplink transmission)	X	
8.2.2.52	Radio Bearer Reconfiguration for transition from CELL_FACH to CELL_DCH and CELL_DCH to CELL_FACH: Success (start and stop of discontinuous uplink transmission)	X	
8.2.2.53	Radio Bearer Reconfiguration for transition from CELL_DCH to CELL_DCH: Success (hard handover to another frequency, start and stop of discontinuous uplink transmission)	X	
8.2.2.54	Radio Bearer Reconfiguration for transition from CELL_FACH to CELL_DCH and CELL_DCH to CELL_FACH: Success (frequency modification, start and stop of discontinuous uplink transmission)	X	
8.2.2.55	Radio Bearer Reconfiguration for transition from CELL_DCH to CELL_DCH: Success (Start and stop of discontinuous uplink transmission)	X	
8.2.2.56	Radio Bearer Reconfiguration for transition from CELL_DCH to CELL_PCH: Success (stop of discontinuous uplink transmission)	X	
8.2.2.57	Radio Bearer Reconfiguration from CELL_DCH to CELL_DCH: Success (Reconfiguration between fixed and flexible AM RLC, Serving HS-DSCH cell change between MAC-hs and MAC-e-hs)	X	
8.2.2.59	Radio Bearer Reconfiguration from Cell FACH (Cell supporting HS-DSCH in Cell FACH) to CELL_FACH(Cell not supporting HS-DSCH in Cell FACH): Success (Cell re-selection)	X	
8.2.2.60	Radio Bearer Reconfiguration for transition from CELL_DCH to CELL_FACH and CELL_FACH to CELL_DCH: Success (with ongoing HS-DSCH reception)	X	
8.2.2.62	Radio Bearer Reconfiguration for transition from CELL_DCH to CELL_DCH: Success (activation and deactivation of MIMO)	X	
8.2.2.63	Radio Bearer Reconfiguration from CELL_DCH to CELL_DCH: Success (activation and de-activation of 64QAM)	X	
8.2.3.37	Radio Bearer Release for transition from CELL_DCH to CELL_DCH: Success (frequency modification, stop of discontinuous uplink transmission)	X	
8.2.6.54a	Physical Channel Reconfiguration for transition from CELL_DCH to CELL_DCH: Failure (Timing re-initialized hard handover, Serving E-DCH and HS-DSCH cell change with MIMO activated, physical channel failure and reversion to old channel)	X	
8.2.6.55	Physical channel reconfiguration for transition from CELL_DCH to CELL_DCH: Success (Start of discontinuous uplink transmission and downlink reception)	X	
8.2.6.56	Physical channel reconfiguration for transition from CELL_DCH to CELL_DCH: Success (Start of HS-SCCH less operation)	X	
8.2.6.57	Physical Channel Reconfiguration for transition from CELL_DCH to URA_PCH: Success (frequency modification, stop of discontinuous uplink transmission)	X	
8.2.6.58	Physical Channel Reconfiguration for transition from CELL_DCH to CELL_DCH: Success (serving E-DCH cell change with discontinuous uplink transmission)	X	
8.2.6.59	Physical channel reconfiguration for transition from CELL_DCH to CELL_DCH: Success (Timing re-initialized hard handover to another frequency, Serving E-DCH cell change with discontinuous uplink transmission)	X	
8.2.6.60	Physical Channel Reconfiguration for transition from CELL_DCH to CELL_DCH: Failure (Timing re-initialised hard handover, Serving E-DCH cell change with discontinuous uplink transmission, physical channel failure and reversion to old channel)	X	
8.2.6.61	Physical channel reconfiguration for transition from CELL_DCH to CELL_DCH: Success (CQI reporting reduction)	X	
8.2.6.62	Physical Channel Reconfiguration from CELL_DCH to CELL_DCH: Success (activation and de-activation of 64QAM)	X	
8.2.6.63	Physical Channel Reconfiguration from CELL_DCH to CELL_DCH: Success (Timing re-initialised hard handover to another frequency, Serving HS-DSCH cell change with MIMO enabled)	X	

Test case	Description	FDD	LCR_TDD
8.3.1.44	Cell Update: Transition from CELL_PCH to CELL_DCH: Success (frequency modification, start of discontinuous uplink transmission)	X	
8.3.1.45	Cell Update: Radio Link Failure, with active discontinuous uplink transmission	X	
8.3.1.46	Cell Update: Transition from URA_PCH to CELL_DCH: Success (start of discontinuous uplink transmission)	X	
8.3.1.47	Cell Update: cell reselection in CELL_FACH (Reselection between cell not supporting HS-PDSCH in CELL_FACH and cell supporting HS-PDSCH is CELL_FACH)	X	
8.3.4.11	Active set update in soft handover: Radio Link addition/removal and serving HS-DSCH / E-DCH cell change, with discontinuous uplink transmission	X	
8.3.4.13	Active set update in soft handover: Radio Link addition/removal and serving HS-DSCH / E-DCH cell change, with activation/deactivation of 64QAM	X	
8.3.7.1b	Inter system handover from UTRAN/To GSM/Speech/Success with UEA2/UIA2 and A5/3 ciphering	X	
8.3.11.1a	Inter-RAT cell change order from UTRAN/To GPRS/CELL_DCH/Success with UEA2/UIA2, GEA2 ciphering	X	
8.3.11.1b	Inter-RAT cell change order from UTRAN/To GPRS/CELL_DCH/Success with UEA2/UIA2 and GEA3 ciphering	X	
8.3.11.15	Inter-RAT Cell Change Order from UTRAN to GPRS/CELL_DCH/Success (stop of discontinuous uplink transmission)	X	
8.4.1.50	Measurement reporting when moving from CELL_PCH to CELL_FACH	X	
14.5.3	Interactive/Background / UL:32 DL: [max bit rate depending on UE category] with fixed RLC and MAC-ehs / PS RAB + SRBs for DCCH on RACH and SRB with fixed RLC and MAC-ehs on HS-DSCH / DL:QPSK	X	
14.6.1b	Interactive or background / UL:64 DL: [max bit rate depending on UE category] with Fixed RLC and MAC-ehs PS RAB + UL:3.4 DL:3.4 kbps SRBs for DCCH / DL: QPSK and 16QAM	X	
14.6.1c	Interactive or background / UL:64 DL: [max bit rate depending on UE category] with Flexible RLC and MAC-ehs PS RAB + UL:3.4 DL:3.4 kbps SRBs for DCCH / DL: 64QAM	X	
14.6.1d	Interactive or background / UL:64 DL: [max bit rate depending on UE category] with Flexible RLC and MAC-ehs PS RAB + UL:3.4 DL:3.4 kbps SRBs for DCCH / DL: QPSK, 16QAM and MIMO	X	
14.6.6a	Streaming / unknown / UL:128 DL: [guaranteed 128, max bit rate depending on UE category] with Fixed RLC and MAC-ehs / PS RAB + Interactive or background / UL:128 DL: [max bit rate depending on UE category] with Flexible RLC and MAC-ehs / PS RAB + UL:3.4 DL:3.4 kbps SRBs for DCCH / DL: QPSK and 16QAM	X	
14.6.6b	Streaming / unknown / UL:128 DL: [guaranteed 128, max bit rate depending on UE category] with Fixed RLC and MAC-ehs / PS RAB + Interactive or background / UL:128 DL: [max bit rate depending on UE category] with Flexible RLC and MAC-ehs / PS RAB + UL:3.4 DL:3.4 kbps SRBs for DCCH / DL: 64QAM	X	
14.6.6c	Streaming / unknown / UL:128 DL: [guaranteed 128, max bit rate depending on UE category] with Fixed RLC and MAC-ehs / PS RAB + Interactive or background / UL:128 DL: [max bit rate depending on UE category] with Flexible RLC and MAC-ehs / PS RAB + UL:3.4 DL:3.4 kbps SRBs for DCCH / DL: QPSK, 16QAM and MIMO	X	
14.7.6b	Conversational / unknown or speech / UL:[max bit rate depending on UE category and TTI] DL: [max bit rate depending on UE category] kbps with Flexible RLC and MAC-ehs / PS RAB + Streaming or Interactive or background / UL: [max bit rate depending on UE category and TTI] DL: [max bit rate depending on UE category] with Fixed RLC and MAC-ehs / PS RAB + UL:[max bit rate depending on UE category and TTI] DL: [max bit rate depending on UE category] SRBs for DCCH on E-DCH and SRBs with Fixed RLC and MAC-ehs on HS-DSCH / UL: QPSK and DL: QPSK	X	

A.15.1 Void

A.15.2 The TTCN Machine Processable form (TTCN.MP)

The TTCN.MP representation corresponding to the corresponding FDD or LCR_TDD ATS is contained in an ASCII file (HSPA7_ENH.MP) which accompanies the present document.

A.16 HSPA8_ENH ATS

The approved HSPA8_ENH test cases are listed. An "X" in columns FDD or LCR TDD indicates the test case approved for the relevant ATS.

Table A.16: HSPA and Rel-8 enhancement TTCN test cases

Test case	Description	FDD	LCR_TDD
7.1.7.1	MAC-i/is multiplexing (multiple PDUs from different LC in one TTI)	X	
7.1.7.3	Correct settings of MAC-i/is header fields	X	
7.3.7.1	PDCP AMR Data PDU testing	X	
7.3.7.2	PDCP Unrecoverable Error Detection	X	
8.1.1.13	ETWS primary and secondary notification without security reception via S-CCPCH in idle mode, URA_PCH and CELL_PCH state / CELL_FACH state	X	
8.1.2.26	RRC Connection Establishment / Paging Permission with Access Control: Success	X	
8.2.2.58	Radio Bearer Reconfiguration for transition from CELL_DCH to CELL_DCH: Success (Reconfigurations between CS voice over DCH and CS voice over HSPA)	X	
8.3.1.48	Cell Update: Radio Link Failure, UM RLC Re-establishment	X	
8.3.4.15	Active set update: Dual Cell (DC) Activation by Serving Cell Change from non DC-HSDPA capable cell to DC-HSDPA capable cell	X	
8.3.4.15a	Active set update: Dual Cell (DC) Activation by Serving Cell Change from non DC-HSDPA capable cell to DC-HSDPA capable cell with SRB mapped on E-DCH/DCH	X	
8.3.4.16	Active set update: Dual Cell (DC) Activation by Serving Cell Change from DC-HSDPA capable cell to non DC-HSDPA capable cell	X	
8.3.4.16a	Active set update: Dual Cell (DC) Activation by Serving Cell Change from DC-HSDPA capable cell to non DC-HSDPA capable cell with SRB mapped on E-DCH/DCH	X	
12.2.2.10	Combined PS attach / abnormal cases / access barred due to paging permission with access control	X	
13.3.1.2	Test Call using eCall capable UE with eCall only subscription	X	
13.3.1.3	Manually initiated eCall using eCall capable UE with "eCall only" subscription on USIM	X	
13.3.1.4	Reconfiguration Call using eCall capable UE with an 'eCall only' subscription on USIM	X	
13.3.1.5	Manually initiated eCall using eCall capable UE with eCall and non eCall subscriptions on USIM	X	
13.3.1.6	eCall Inactivity State after T3242 expires	X	
13.3.1.7	Automatically initiated eCall	X	
13.3.1.10	eCall Inactivity State after T3243 expires	X	
14.6.1e	Interactive or background / UL:64 DL: [max bit rate depending on UE category] with Flexible RLC and MAC-ehs PS RAB + UL:3.4 DL:3.4 kbps SRBs for DCCH / DL: 64QAM and MIMO	X	
14.6.1f	Interactive or background / UL:64 DL: [max bit rate depending on UE category] with Flexible RLC and MAC-ehs PS RAB + UL:3.4 DL:3.4 kbps SRBs for DCCH / DL: QPSK, 16QAM and Dual-Cell	X	
14.6.1g	Interactive or background / UL:64 DL: [max bit rate depending on UE category] with Flexible RLC and MAC-ehs PS RAB + UL:3.4 DL:3.4 kbps SRBs for DCCH / DL: 64QAM and Dual-Cell	X	
14.6.6d	Streaming / unknown / UL:128 DL: [guaranteed 128, max bit rate depending on UE category] with Fixed RLC and MAC-ehs / PS RAB + Interactive or background / UL:128 DL: [max bit rate depending on UE category] with Flexible RLC and MAC-ehs / PS RAB + UL:3.4 DL:3.4 kbps SRBs for DCCH / DL: 64QAM and MIMO	X	
14.6.6e	Streaming / unknown / UL:128 DL: [guaranteed 128, max bit rate depending on UE category] with Fixed RLC and MAC-ehs / PS RAB + Interactive or background / UL:128 DL: [max bit rate depending on UE category] with Flexible RLC and MAC-ehs / PS RAB + UL:3.4 DL:3.4 kbps SRBs for DCCH / DL: QPSK, 16QAM and Dual-Cell	X	
14.6.6f	Streaming / unknown / UL:128 DL: [guaranteed 128, max bit rate depending on UE category] with Fixed RLC and MAC-ehs / PS RAB + Interactive or background / UL:128 DL: [max bit rate depending on UE category] with Flexible RLC and MAC-ehs / PS RAB + UL:3.4 DL:3.4 kbps SRBs for DCCH / DL: 64QAM and Dual-Cell	X	

14.7.3a	Streaming or interactive or background / UL: [max bit rate depending on UE category and TTI] DL: [max bit rate depending on UE category] with Flexible RLC, MAC-ehs and MAC-i/is / PS RAB + UL: [max bit rate depending on UE category and TTI] DL: [max bit rate depending on UE category] SRBs for DCCH on E-DCH and HS-DSCH with MAC-ehs and MAC-i/is	X	
14.7.6c	Conversational / unknown or speech / UL:[max bit rate depending on UE category and TTI] DL: [max bit rate depending on UE category] kbps with Flexible RLC, MAC-ehs and MAC-i/is / PS RAB + Streaming or Interactive or background / UL: [max bit rate depending on UE category and TTI] DL: [max bit rate depending on UE category] with Fixed RLC, MAC-ehs and MAC-i/is / PS RAB + UL:[max bit rate depending on UE category and TTI] DL: :[max bit rate depending on UE category] SRBs for DCCH on E-DCH and HS-DSCH with MAC-ehs and MAC-i/is / UL: QPSK and DL: QPSK	X	
14.7.9	Conversational / speech / UL:(12.2, 7.95, 5.9, 4.75) kbps DL: (12.2, 7.95, 5.9, 4.75) kbps / CS RAB on E-DCH and HS-DSCH + UL: [max bit rate depending on UE category and TTI] DL: [max bit rate depending on UE category] SRBs for DCCH on E-DCH and HS-DSCH	X	
14.7.10	Conversational / speech / UL:(12.65, 8.85, 6.6) kbps DL: (12.65, 8.85, 6.6) kbps / CS RAB on E-DCH and HS-DSCH + UL: [max bit rate depending on UE category and TTI] DL: [max bit rate depending on UE category] SRBs for DCCH on E-DCH and HS-DSCH	X	

A.16.1 Void

A.16.2 The TTCN Machine Processable form (TTCN.MP)

The TTCN.MP representation corresponding to the corresponding FDD or LCR_TDD ATS is contained in an ASCII file (HSPA8_ENH.MP) which accompanies the present document.

A.17 HSPA9_ENH ATS

The approved HSPA9_ENH test cases are listed. An "X" in columns FDD or LCR TDD indicates the test case approved for the relevant ATS.

Table A.17: HSPA and Rel-9 enhancement TTCN test cases

Test case	Description	FDD	LCR_TDD
8.1.5.7	UE Capability Information / Audit of UE Capabilities	X	

A.17.1 Void

A.17.2 The TTCN Machine Processable form (TTCN.MP)

The TTCN.MP representation corresponding to the corresponding FDD or LCR_TDD ATS is contained in an ASCII file (HSPA9_ENH.MP) which accompanies the present document.

Annex B (normative): Partial IXIT proforma

Notwithstanding the provisions of the copyright related to the text of the present document, The Organizational Partners of 3GPP grant that users of the present document may freely reproduce the partial IXIT proforma in this annex so that it can be used for its intended purposes and may further publish the completed partial IXIT.

B.0 Introduction

This partial IXIT proforma contained in the present document is provided for completion, when the related Abstract Test Suite is to be used against the Implementation Under Test (IUT).

Text in *italics* is comments for guidance for the production of a IXIT, and is not to be included in the actual IXIT.

The completed partial IXIT will normally be used in conjunction with the completed ICS, as it adds precision to the information provided by the ICS.

B.1 Parameter values

B.1.1 BasicM test suite parameter declarations

The following parameters are common to all ATSS.

Table B.1.1: BasicM PIXIT

Parameter name	Description	Type	Default value	Supported value
px_AuthAMF	Authentication Management Field (16 bits). The value shall be different from '1111 1111 1111 1111'B (AMFresynch).	BITSTRING	See note 2	
px_AuthK	Authentication Key (128 bits)	BITSTRING	'010111100100101010011001101001000000100101110011001100110011000011000010011010011001'B	
px_AuthN	Value of n to initialize tcv_Auth_n (length of extended response) min 31, max 127 (3GPP TS 34.108 [3], clause 8.1.2)	INTEGER	127	
px_AuthRAND	Random Challenge (128 bits)	BITSTRING	'01010101...01'B	
px_CipherAlg	Cipher algorithm.	B3	Default value: (GEA/1) '001'B	
px_CipheringOnOff	Security mode - TRUE if ciphering is applicable	BOOLEAN	TRUE	
px_CN_DomainTested	CN domain to be tested. This parameter is used in test cases that handle both PS and CS domains.	CN_DomainIdentity	ps_domain	
px_DL_MaxCC_TB_bits	Maximum sum of number of bits of all convolutionally coded transport blocks being received at an arbitrary time instant.	MaxNoBits	b163840	

Parameter name	Description	Type	Default value	Supported value
px_DL_MaxCCTrCH	Maximum number of Simultaneous CCTrCH for downlink	MaxSimultaneousCCTrCH_Count	8	
px_DL_MaxTB_bits	Maximum sum of number of bits of all transport blocks being received at an arbitrary time instant.	MaxNoBits	b163840	
px_DL_MaxTF	Maximum number of TF for downlink	MaxNumberOfTF	tf1024	
px_DL_MaxTFS	Maximum number of TFC in the TFCS for downlink	MaxNumberOfTFC_DL	tf1024	
px_DL_MaxTrCHs	Maximum number of simultaneous transport channels for downlink.	MaxSimultaneousTransChannelsDL	e32	
px_DL_MaxTTI_TB	Maximum total number of transport blocks received within TTIs that end within the same 10 ms interval.	MaxTransportBlocksDL	tb512	
px_FRESH	Value for FRESH	Fresh	See note 1	
px_FDD_OperationBand	Applicable for FDD The operation band under test as defined in 34.108 clause 5.1.1.	INTEGER	1, see note 3	px_UARFCN_D_Mid, px_UARFCN_D_Low and px_UARFCN_D_High shall take the values according to the value of px_FDD_OperationBand.
px_IMSI_Def	Default IMSI value	HEXSTRING	'001010123456063'H	
px_JapanMCC	Japan MCC to be used for Band VI	HEXSTRING	'442'H	
px_PriScrmCode	Applicable for FDD Primary scrambling code	PrimaryScramblingCode	100	
px_MaxAM_EntityNumberRLC_Cap	Maximum AM Entity Number for RLC.	MaximumAM_EntityNumberRLC_Cap	am30	
px_MaxNoDPDCH_BitsTransmitted	Part of UL_PhysChCapabilityFDD	MaxNoDPDCH_BitsTransmitted	b57600	
px_MaxNoDPCH_PDSCH_Codes	Part of DL_PhysChCapabilityFDD. INTEGER (1..8).	INTEGER	8	
px_MaxNoPhysChBitsReceived	Part of DL_PhysChCapabilityFDD.	MaxNoPhysChBitsReceived	b76800	
px_MaxRLC_WindowSize	Maximum RLC window size.	MaximumRLC_WindowSize	mws4095	
px_MS_ClsmkESIND	default Early Sending Indication	B1	'0'B	
px_MS_ClsmkRevLvl	default Revision Level	B2	'10'B	
px_PTMSI_Def	default PTMSI	OCTETSTRING	'C2345678'O	
px_PTMSI_SigDef	default PTMSI signature (3 octets, 3GPP TS 24.008 [9], clause 10.5.5.8).	OCTETSTRING	'AB1234'O	
px_RAT	Applicable for FDD This parameter is used to specify which radio access technology is being used for the current test execution. Valid values: fdd and tdd	RatType	fdd	
px_RRC_CS_ServTested	CS service to be tested for RRC test cases.	RRC_ServTested	Speech	
px_RRC_PS_ServTested	PS service to be tested for RRC test cases.	RRC_ServTested	ps_Interactive	
px_SRNC_Id	SRNC Id	SRNC_Identity	'0000 0000 0001'B	
px_SRNTI	S RNTI	S_RNTI	'0000 0000 0000	

Parameter name	Description	Type	Default value	Supported value
			0000 0001'B	
px_TCellA	TCell value for cell A. Except for the first created cell, the value 0 applied in ts_SS_CellCfg.	Tcell	256	
px_TCellB	TCell value for cell B. Except for the first created cell, the value 0 applied in ts_SS_CellCfg.	Tcell	512	
px_TCellC	TCell value for cell C. Except the first created cell, the value 0 applied in ts_SS_CellCfg.	Tcell	1536	
px_TCellD	TCell value for cell D. Except the first created cell, the value 0 applied in ts_SS_CellCfg.	Tcell	321	
px_TCellE	TCell value for cell E. Except the first created cell, the value 0 applied in ts_SS_CellCfg.	Tcell	833	
px_TCellF	TCell value for cell F. Except the first created cell, the value 0 applied in ts_SS_CellCfg.	Tcell	6577	
px_TCellG	TCell value for cell G. Except the first created cell, the value 0 applied in ts_SS_CellCfg.	Tcell	7253	
px_TCellH	TCell value for cell H. Except the first created cell, the value 0 applied in ts_SS_CellCfg.	Tcell	4351	
px_TimerDequeuePCO	Additional time for dequeuing PCO	INTEGER	5000 (ms)	
px_TMSI_Def	Default TMSI	OCTETSTRING	'12345678'O	
px_TotalRLC_AM_BufferSize	Total RLC AM buffer size for R99. The values are according to TotalRLC-AM-BufferSize defined in 3GPP TS 25.331.	TotalRLC_AM_BufferSize	NA	
px_UARFCN_D_Mid	Applicable for FDD Mid Range downlink UARFCN value	INTEGER	10700	
px_UARFCN_D_Low	Applicable for FDD Low Range downlink UARFCN value	INTEGER	10563	
px_UARFCN_D_High	Applicable for FDD High Range downlink UARFCN value	INTEGER	10837	
px_UE_OpModeDef	Default UE operation mode (either opModeA or opModeC). (For most UEs this corresponds class-A or class-C, and can not be changed by the user)	UE_OperationMode	opModeA	
px_UE_PositioningNetworkAssistedGPS_Sup	UE positioning capability: supports the network assisted GPS	NetworkAssistedGPS_Supported	networkBased	
px_UE_PowerClass	UE_PowerClass value.	UE_PowerClass	1	
px_UL_MaxCC_TB_bits	Maximum sum of number of bits of all convolutionally coded transport blocks being transmitted at an arbitrary time instant.	MaxNoBits	b163840	
px_UL_MaxTB_bits	Maximum sum of number of bits of all transport blocks being transmitted at an arbitrary time instant.	MaxNoBits	b163840	
px_UL_MaxTF	Maximum number of TF for uplink.	MaxNumberOfTF	tf1024	
px_UL_MaxTFS	Maximum number of TFC in the TFCS for uplink.	MaxNumberOfTFC_DL	ffc1024	
px_UL_MaxTrCHs	Maximum number of simultaneous transport channels for uplink.	MaxSimultaneousTransChannelsUL	e32	
px_UL_MaxTTI_TB	Maximum total number of transport blocks transmitted within TTIs that start at the same time.	MaxTransportBlocksUL	tb512	

Parameter name	Description	Type	Default value	Supported value
px_UL_ScramblingCode	Applicable for FDD UL scrambling code value to be used by UE.	UL_ScramblingCode	0	
NOTE 1: No default value can be proposed (Manufacturer defined value).				
NOTE 2: No default value can be proposed, because not enough information is available in 3GPP TS 34.109 [4], clause 8.1.2.				
NOTE 3: This value shall be set in synchronization with the values that are being set for the 3 other pixits viz: px_UARFCN_D_High, px_UARFCN_D_Mid, px_UARFCN_D_Low				

B.1.2 L3M test suite parameters declarations

The following parameters are commonly used in the RRC and NAS ATSSs.

Table B.1.2: L3M PIXIT

Parameter name	Description	Type	Default value	Supported value
px_3G324M_MmediaEnable	For a Multimedia UE: set to TRUE if a multimedia call is enabled; set to FALSE if a speech call is enabled.	BOOLEAN	TRUE	
px_BcapDataCompression	Data compression supported (used in the Bearer Capability)	B1	'0'B	
px_BcapFNUR	Fixed Network User rate supported: '0000'B: Fixed network user rate not applicable '00001'B: FNUR 9.6 kbit/s '00010'B: FNUR 14.4 kbit/s '00011'B: FNUR 19.2 kbit/s '00100'B: FNUR 28.8 kbit/s '00101'B: FNUR 38.4 kbit/s '00110'B: FNUR 48.0 kbit/s '00111'B: FNUR 56.0 kbit/s '01000'B: FNUR 64.0 kbit/s '01001'B: FNUR 33.6 kbit/s '01010'B: FNUR 32.0 kbit/s	B5	'00001'B	
px_BcapITC	Information transfer capability supported (used for the generation of the Bearer Capability) 0 - UDI 1 - RDI 2 - 31 kHz Audio 3 - Other	ItcInt	2	
px_BcapModemType	Modem type supported (used in the Bearer Capability)	B5	'00110'B	
px_BcapNumberDataBits	Number of data bits supported (used in the Bearer Capability)	B1	'1'B	
px_BcapNumberStopBits	Number of Stops bits supported (used in the Bearer Capability)	B1	'1'B	
px_BcapOtherModemType	Other modem type supported (used in the Bearer Capability)	B2	'10'B	
px_BcapParity	Parity supported (used in the Bearer Capability)	B3	'011'B	
px_BcapSACP	Signalling access protocol supported (used in the Bearer Capability)	B3	'001'B	
px_BcapSyncAsync	Synchronous '0'B or Asynchronous '1'B mode supported by IUT	B1	'1'B	

Parameter name	Description	Type	Default value	Supported value
px_3G324M_MmediaEnable	For a Multimedia UE: set to TRUE if a multimedia call is enabled; set to FALSE if a speech call is enabled.	BOOLEAN	TRUE	
px_BcapUeFlowControl	UE flow control. 0-outband, 1-inband, 2-no flow control. 3- X.25 4- X.75 Default: 0, outband flow control	FlowControl	0	
px_CC_CallDiallingDigits	Dialling digits used to initiate a CC MO call (used with the AT dial D command).	IA5String	"0123456902"	
px_CC_Serv	Service selected for Mobile Originated calls and Mobile Terminated calls. The possible values are ("Telephony", "EmergencyCall", "31kHz", "V110", "V120", "PIAFS", "FTM", "X31", "BTM", "3G324M_Call", "Alternate Speech/Facsimile", "3G324M_SpeechPreferred")	Services	"31 kHz"	
px_DeltaSS_DelayTime	Tdelta value (refer to 3GPP TS 34.108 [3], clause 4.2.3) in ms.	INTEGER	55 ms	
px_EmergencyCallNumber	Emergency Number used by UE to initiate an emergency call	EmergencyNumber	"112"	
px_IMEI_Def	Default IMEI value	HEXSTRING	See note	
px_IMEISV_Def	Default IMEISV value	HEXSTRING	See note	
px_IMSI_Diff	Different IMSI from the IMSI stored in the USIM	HEXSTRING	'001010654321063'H	
px_SupportOpModeC	TRUE if UE supports operation mode C, i.e. UE offers PS services only (see 3GPP TS 23.060 [60], clause 4.1 and 3GPP TS 24.008 [9])	BOOLEAN	TRUE	
px_NwOrgPDP_Support	This indicates if the UE implementation supports network originated PDP Context. TRUE indicates, supported FALSE indicate, not supported	BOOLEAN	FALSE	
px_PDP_IP_AddrInfoDCH	A string parameter that identifies the MT in the address space applicable to the PDP for DCH.	IA5String	"200.1.1.80"	
px_PDP_IP_AddrInfoFACH	A string parameter that identifies the MT in the address space applicable to the PDP for FACH.	IA5String	"200.1.1.90"	
px_PTMSI_2	Second PTMSI used for testing.	OCTETSTRING	'C9876543'O	
px_PTMSI_Sig2	Second PTMSI signature used for testing.	OCTETSTRING	'AB1234'O	
px_TMSI_2	Second TMSI value for testing	OCTETSTRING	'09876543'O	
px_SMS_IndexOffset	SMS index offset for the numbering of short messages, value range: (0,1)	INTEGER	0	

NOTE: No default value can be proposed (Manufacturer defined value).

B.1.3 NAS test suite parameters declarations

The following parameters are commonly used in the NAS ATS.

Table B.1.3: NAS PIXIT

Parameter name	Description	Type	Default value	Supported value
px_AuthRAND_2	A second Random Challenge (128 bits)	BITSTRING	'1010101...10'B	
px_PTMSI_Sig3	Second PTMSI signature used for testing	OCTETSTRING	'AB1239'O	

B.1.4 SMS test suite parameters declarations

These parameters are used in the SMS ATS.

Table B.1.4: SMS PIXIT

Parameter name	Description	Type	Default value	Supported value
px_BMC_CB_RepPeriod01	CB repetition period for CB message 1	INTEGER	2	
px_BMC_CB_RepPeriod02	CB repetition period for CB message 2	INTEGER	2	
px_BMC_NoOfBC_Req01	No of broadcasts requested for CB message 1	INTEGER	2	
px_BMC_NoOfBC_Req02	No of broadcasts requested for CB message 2	INTEGER	2	
px_MaxCP_DataRetx	max. number of CP data retransmissions for SMS	INTEGER	3	
px_SMS_CB_Data01	Contents of the first Cell Broadcast Message sent will be converted to an OCTETSTRING	IA5String	"First Cell Broadcast Message"	
px_SMS_CB_Data02	Contents of the second Cell Broadcast Message sent will be converted to an OCTETSTRING	IA5String	"Second Cell Broadcast Message"	
px_SMS_CB_MsgId02	Message Id to be used for the second Cell Broadcast Message sent	HEXSTRING[4]	'0002'H	
px_SMS_PrefMem1	SMS Preferred Memory 1 <mem1> of 3GPP TS 27.005 [22], clause 3.1	IA5String	"SM"	
px_SMS_PrefMem2	SMS Preferred Memory 2 <mem2> of 3GPP TS 27.005 [22], clause 3.1	IA5String	"SM"	
px_SMS_PrefMem3	SMS Preferred Memory 3 <mem3> of 3GPP TS 27.005 [22], clause 3.1	IA5String	"MT"	
px_TC1M	Value for timer TC1M, to be declared by the manufacturer	INTEGER	10000	

B.1.5 RRC_M test suite parameters declarations

These parameters are used in the RRC and RAB ATS.

Table B.1.5: RRC and RAB PIXIT

Parameter name	Description	Type	Default value	Supported value
px_DL_MaxTC_TB_bits	Maximum sum of number of bits of all turbo coded transport blocks being received at an arbitrary time instant.	MaxNoBits	b163840	
px_ExecutePS_Class	Service to be executed in RAB test cases. The allowed values are: 1: Interactive 2: BackGround 3: Streaming 0: All supported classes. Any other value is not defined.	INTEGER	1	
px_MaxHcContextSpace	MaxHcContextSpace if RFC 2507 [30] is supported.	MaxHcContextSpace	by1024	
px_MaxNoSCCPCH_RL	Part of SimultaneousSCCPCH_DPCH_Reception.	MaxNoSCCPCH_RL	r1	
px_PrimaryBand	The primary operation band under test, as defined in 34.108 clause 5.1.1. Value 1 means Band 1, 2 means Band 2, 3 means Band 3, 6 means Band 6.	INTEGER	1	This pixit shall be set in synchronization with the values that are being set to other Pixit: px_UARFCN_D_Mid
px_SecondaryBand	The secondary operation band under test, as defined in 34.108 clause 5.1.1. Value 1 means Band 1, 2 means Band 2, 3 means Band 3, 6 means Band 6.	INTEGER	8	
px_SMS_CB_MsgId01	the operator shall define the CB Message ID for the CB data1 used for transmitting this CB data, different to CB-Data 2 IXIT	HEXSTRING[4]	'0001'H	
px_SMS_CB_Store	TRUE if Broadcast Messages are kept in BM storage	BOOLEAN	TRUE	
px_SMS_MsgFmt	SMS Message Format <mode> of TS 27.005 cl. 3.2.3	IA5String	"1"	Default "Text mode"
px_SMS_PrefMemCB1	SMS Preferred CB Memory 1 <mem1> of 3GPP TS 27.005 [22], clause 3.1	IA5String	"BM"	
px_SMS_PrefMemCB2	SMS Preferred CB Memory 2 <mem2> of 3GPP TS 27.005 [22], clause 3.1	IA5String	"BM"	
px_SMS_PrefMemCB3	SMS Preferred CB Memory 3 <mem3> of 3GPP TS 27.005 [22], clause 3.1	IA5String	"BM"	
px_SMS_Service	SMS Service <service> of 3GPP TS 27.005 [22], clause 3.2.1	IA5String	"0"	
px_UL_MaxTC_TB_bits	Maximum sum of number of bits of all turbo coded transport blocks being transmitted at an arbitrary time instant.	MaxNoBits	b163840	

The px_ExecutePS_Class allows the option 0 to be selected. This has been allowed in order to preserve the changes implemented in TTCN for handling all traffic classes in RAB testcase execution. System simulators are not required to support this execution and also TTCN maintenance of this path should be limited.

B.1.6 PDCP test suite parameters declarations

These parameters are used in the PDCP ATS.

Table B.1.6: PDCP PIXIT

Parameter name	Description	Type	Default value	Supported value
px_PDCP_TcplpCompressedTcpNonDeltaPacket01	IP header compressed packet type (PID=3) of <u>px_PDCP_TcplpUncompressedPacket01</u>	IP_Packet	0000 0000 0000 0a00 0000 0050 1000 0026 3400 006a 6e6e 206a 6e6e 206a 6e6e	
px_PDCP_TcplpCompressedTcpNonDeltaPacket02	IP header compressed packet type (PID=3) of <u>px_PDCP_TcplpUncompressedPacket02</u>	IP_Packet	"Test_PDCP_TCPIP_Packet2_PID_Type3"	
px_PDCP_TcplpCompressedTcpPacket01	IP header compressed packet type (PID=2) of <u>px_PDCP_TcplpUncompressedPacket01</u>	IP_Packet	0028 2634 0a00 0000 6a6e 6e20 6a6e 6e	
px_PDCP_TcplpCompressedTcpPacket02	IP header compressed packet type (PID=2) of <u>px_PDCP_TcplpUncompressedPacket02</u>	IP_Packet	"Test_PDCP_TCPIP_Packet2_PID_Type2"	
px_PDCP_TcplpFullHeaderPacket01	IP header compressed packet type (PID=1) of <u>px_PDCP_TcplpUncompressedPacket01</u>	IP_Packet	c500 0000 0000 0000 4006 7ac6 0000 0000 0000 0000 0000 0000 0000 0000 0000 0000 5010 0000 263e 0000 6a6e 6e20 6a6e 6e	
px_PDCP_TcplpFullHeaderPacket02	IP header compressed packet type (PID=1) of <u>px_PDCP_TcplpUncompressedPacket02</u>	IP_Packet	"Test_PDCP_TCPIP_Packet2_PID_Type1"	
px_PDCP_TcplpUncompressedPacket01	uncompressed TCP/IP Packet01	IP_Packet	4500 0033 0000 0000 4006 7ac6 0000 0000 0000 0000 0000 0000 0000 0000 0000 0000 5010 0000 263e 0000 6a6e 6e20 6a6e 6e	
px_PDCP_TcplpUncompressedPacket02	uncompressed TCP/IP Packet02	IP_Packet	"Test_PDCP_TCPIP_Packet2"	
px_PDCP_UdplpCompressedTcpNonTcpPacket01	IP header compressed packet type (PID=4) of <u>px_PDCP_UdplpUncompressedPacket01</u>	IP_Packet	0001 0000 763c 6a6e 6e20 6a6e 6e20 6a6e 6e	
px_PDCP_UdplpCompressedTcpNonTcpPacket02	IP header compressed packet type (PID=4) of <u>px_PDCP_UdplpUncompressedPacket02</u>	IP_Packet	"Test_PDCP_UDPIP_Packet2_PID_Type4"	
px_PDCP_UdplpFullHeaderPacket01	IP header compressed packet type (PID=1) of <u>px_PDCP_UdplpUncompressedPacket01</u>	IP_Packet	8500 0100 0000 0000 4011 7ac7 0000 0000 0000 0000 0000 0000 0013 763c 6a6e 6e20 6a6e 6e20 6a6e 6e	
px_PDCP_UdplpFullHeaderPacket02	IP header compressed packet type (PID=1) of <u>px_PDCP_UdplpUncompressedPacket02</u>	IP_Packet	"Test_PDCP_UDPIP_Packet2_PID_Type1"	

Parameter name	Description	Type	Default value	Supported value
px_PDCP_UdplpUncompressedPacket01	uncompressed UDP/IP Packet01	IP_Packet	4500 0027 0000 0000 4011 7ac7 0000 0000 0000 0000 0000 0000 0013 763c 6a6e 6e20 6a6e 6e20 6a6e 6e	
px_PDCP_UdplpUncompressedPacket02	uncompressed UDP/IP Packet02	IP_Packet	"Test_PDCP_U DPIP_Packet2"	

B.1.7 BMC test suite parameters declarations

These parameters are used in the BMC ATS.

Table B.1.7: BMC PIXIT

Parameter name	Description	Type	Default value	Supported value
px_CB_Data1	Data to be sent for each PDCP test, except TC 7.4.1.4, 7.4.1.5 and 7.4.1.6	IA5String [1..1246]	"CB Data1"	
px_CB_Data2	Data to be sent in TC 7.4.2.1	IA5String [1..1246]	"CB Data2"	
px_SMS_CB_MsgId01	Data to be sent for each PDCP test, except TC 7.4.1.4, 7.4.1.5 and 7.4.1.6	HEXSTRING[4]	'0000'H	
px_SMS_CB_MsgId02	Data to be sent in TC 7.4.2.1	HEXSTRING[4]	'0000'H	
px_gS01	Data to be sent for each PDCP test, except TC 7.4.1.4, 7.4.1.5 and 7.4.1.6	BITSTRING[2]	"Test_gS1"	
px_ggS02	Data to be sent in TC 7.4.2.1	BITSTRING[2]	"Test_gS2"	
px_MsgCode01	Data to be sent for each PDCP test, except TC 7.4.1.4, 7.4.1.5 and 7.4.1.6	BITSTRING[10]	"Test_msgCode01"	
px_MsgCode02	Data to be sent in TC 7.4.2.1	BITSTRING[10]	"Test_msgCode02"	
px_UpdateNumber01	Data to be sent for each PDCP test, except TC 7.4.1.4, 7.4.1.5 and 7.4.1.6	BITSTRING[4]	"Test_updateNumber01"	
px_UpdateNumber02	Data to be sent in TC 7.4.2.1	BITSTRING[4]	"Test_updateNumber02"	

B.1.8 RRC test suite parameters declarations

These parameters are used in the RRC ATS.

Table B.1.8: RRC PIXIT

Parameter name	Description	Type	Default value	Supported value
-	-	-	-	-

B.1.9 RAB test suite parameters declarations

These parameters are used in the RAB ATS.

Table B.1.9: RAB PIXIT

Parameter Name	Description	Type	Default Value	Supported Value
px_CB_Data1	the operator shall define CBS data as IA5String together with the CB message ID used for transmitting this CB data, which is indicated by the UE after reception in a clear way according to the capabilities stored on the SIM. Furthermore, the operator shall describe the indication on the UE side (e.g. certain CBS traffic information)	IA5String_BMC		the CB data range is 1..1246 Octets which refers to a IA5String of 1..1246
px_DSCH_RNTI	DSCH RNTI	DSCH_RNTI	'0000 0000 0000 0010'B	
px_gS01	used in the Serial No. of the CB_Data01 given as PIXIT, which differentiates between CBS messages from the same source and type	B2	'00'B	
px_MsgCode01	used in the Serial No. of the CB_Data01 given as PIXIT, which is the Geographical Scope indicates the area over which the msg code is unique	MsgCodeType	'0000000000'B	
px_UpdateNumber01	used in the Serial No. of the CB_Data01 given as PIXIT, which indicates a change of the message content of the same CBS message	B4	'0000'B	
px_PowerDSCH	transmission power level of DSCH	DL_TxPower		

B.1.10 RLC and MAC test suite parameters declarations

These parameters are used in the MAC ATS.

Table B.1.10: RLC & MAC PIXIT

Parameter Name	Description	Type	Default Value	Supported Value
px_NumOfSegInPagResOrServReq	This Pixit is used in MAC test cases 7.1.1.2, 7.1.1.3, 7.1.1.4, 7.1.1.5 and 7.1.1.8 This indicates the number of RLC segments the Paging Response (CS Domain) or Service Request (PS domain) will be segmented in.	INTEGER	2	
px_RLC_SDU_buffering	Is used in RLC TC 7.2.3.13, indicating the way to handle RLC SDU data for UL transmission when the transmission window is full	BOOLEAN(TRUE for buffering, FALSE for discard)		

B.1.11 Multi RAT test suite parameters declarations

These parameters are used in the MultiRAT ATS.

Table B.1.11: MultiRAT PIXIT

Parameter name	Description	Type	Default value	Supported value
px_GSM_BandUnderTest	indicates which band is under test	INTEGER		1 -> GSM450; 2 -> GSM480; 3 -> GSM750; 4 -> GSM850; 5 -> GSM-P-900; 6-> GSM-E-900; 7-> DCS1800; 8 -> PCS1900; 9 -> 450 & 900 MultiBand test; 10 -> 450 & 1800 MultiBand test; 11 -> 480 & 900 MultiBand test; 12 -> 480 & 1800 MultiBand test; 13 -> 900 & 1800 MultiBand test; 14-> GSM710; 15->T-GSM810;
px_GSM_CipheringOnOff	GSM Ciphering to be started or not	B1	1	
px_GSM_CipherAlg	GSM Cipher algorithm. <u>Allowed values are:</u> '000'B(A5/1), '010'B(A5/3)	B3_CipherAlg	(A5/1) '000'B	
px_CipherKey	Cipher key (64 bits)	B64	'010111100100101010101100110101100010010001001101110101110100101010'B	
px_MS_TXPWR_MAX_CCH	MS_TXPWR_MAX_CCH	B5	'01010'B	
px_RXLEV_ACCESS_MIN	minimum received signal level at MS	B6	'000000'B	
px_SplitOnCCCH	split paging cycle on CCCH supported indication	B1	'0'B not supported	
px_TSC	Training sequence code for traffic channels	B3	'011'B	
px_PowerLevel	power level value for L1 header	B5		
px_TimingAdvance	Timing advance value for L1 header	B1	'0000000'B	

B.1.12 MMI questions

Table B.1.12 requests additional information needed for the execution of the MMI commands used in the ATs, the column 'ATS' indicates in which ATs the question is used.

Table B.1.12: MMI questions

Required information for MMI question	ATS
Please switch the PLMN selection mode of the UE to automatic selection	RRC, SMS, NAS, RAB, HSD_ENH, IR_U, AGPS, HSU_ENH, HS_ENH
Please switch the PLMN selection mode of the UE to manual selection	RRC, SMS, NAS, RAB, HSD_ENH, IR_U, AGPS, HSU_ENH, HS_ENH
Please select the following PLMN manually: MCC = <p_MCC>, MNC = <p_MNC>	RRC, SMS, NAS, RAB, HSD_ENH, IR_U, AGPS, HSU_ENH, HS_ENH
Please power off the UE	All ATs
Please power on the UE	All ATs
Please switch off the UE	All ATs
Please switch on the UE	All ATs
Please insert the USIM card into the UE	All ATs
Please remove the USIM card into the UE	All ATs
Please check that the DTCH is through connected by generating a noise	RRC, SMS, NAS, RAB, HSD_ENH, IR_U, AGPS, HSU_ENH
Configure UE for an MO Telephony call	RRC, SMS, NAS, RAB, HSD_ENH, IR_U, AGPS, HSU_ENH, HS_ENH
Configure UE for an Emergency call	RRC, SMS, NAS, RAB, HSD_ENH, IR_U, AGPS, HSU_ENH, HS_ENH
Configure UE for an MT telephony call	RRC, SMS, NAS, RAB, HSD_ENH, IR_U, AGPS, HSU_ENH, HS_ENH
Please set UE in operation mode C (PS services only)	RRC, SMS, NAS, RAB, HSD_ENH, IR_U, AGPS, HSU_ENH, HS_ENH
Please set UE in operation mode A (to support simultaneous CS and PS services)	RRC, SMS, NAS, RAB, HSD_ENH, IR_U, AGPS, HSU_ENH, HS_ENH
Please configure UE to use the following emergency number <p_EmergencyNumber>	RRC, SMS, NAS, RAB, HSD_ENH, IR_U, A-GPS, HSU_ENH, HS_ENH
Please initiate a non call related supplementary service which is supported by the UE	NAS
Please insert Test USIM programmed with Access Class: <p_AccessClass>	NAS
Please insert 2nd SIM card with short IMSI	NAS, SMS, AGPS
Please initiate an autocalling call with the number: <p_AutocallingNumber>	NAS
Please initiate an autocalling call with a number that will be put in the blacklisted list. The following number shall not be used: <p_AutocallingNumber>	NAS
Please reset the autocalling list of blacklisted numbers	NAS
Please initiate a DTMF tone with the character <p_Character> and the tone duration <p_ToneDuration>	NAS
Please enable call refusal on the UE	NAS
Please check that the DTMF tone indication has been generated	NAS
Please insert another USIM card as required for test case tc_9_4_5_4_6. The PLMN selector on the USIM card shall contain entries for PLMNs MCC='022'H, MNC='01F'H resp. MCC='022'H , MNC='03F'H. The latter PLMN shall be ranked better than the first one	NAS

Required information for MMI question	ATS
Please trigger UE to initiate a Detach procedure for non-PS services only	NAS
Please check that the mobile indicates the reception of a message with message id: <p_MessageId> and message code: <p_MessageCode>	SMS
Please check the length of the received Short Message: <p_LengthMessage> and the contents of the received Short Message: <p_Message>	SMS
Please send an SMS COMMAND message containing a request to delete the previously submitted Short Message	SMS
Please send an SMS COMMAND message containing an enquiry about the previously submitted Short Message	SMS
Please check that NO recalled Short Message is displayed	SMS
Please check that the reception of a received Short Message is indicated	SMS
Please check that the Mobile does not indicate the reception of a new message with message id: <p_MessageId> and message code: <p_MessageCode>	SMS
Please check that NO reception of a received Short Message of type 0 is indicated	SMS
Please insert the USIM card of type B into the UE	MAC
Please insert the USIM card, with information given in <p_TestCase>	RRC, NAS, IR_U, HSU_ENH, HS_ENH
Please check that the UE display the registered PLMN as PLMN <p_PLMN>	RRC, HSU_ENH, HS_ENH
Please insert the USIM card, with Type A EFACC	RRC
Please insert the USIM card, with Type B EFACC	RRC
Please trigger UE to send three SNDCP PDUs of 500 bytes each on SAPI 11	IR_G
Please trigger PDP Context Activation Type 2 in UE	IR_G
Please trigger MO-LR for position estimate	AGPS
Please trigger MO-LR for assistance data	AGPS
Please trigger MO-LR for transfer to 3rd party	AGPS
Please check that the UE displays the correct information about the LCS client	AGPS
Please accept the location request within 20 s	AGPS
Please deny the location request within 20 s	AGPS
Please do not reply to the location request	AGPS
Please check that the UE notifies the user of the location request	AGPS
If the UE does not support the RESET command defined in 34.109, please ensure that the UE has no assistance data stored before running this test case	AGPS
Please trigger UE to send 10 kbytes of data on SAPI 3	IR_G
Please trigger UE to send 1 kbyte of data on SAPI 3	IR_G
Please check that in the manual PLMN list the UE display: <p_PLMN_List>	HSU_ENH
Please check that UE displays no service or no network available	HSU_ENH, HSPA8_ENH
Please check that in the manual PLMN list the UE displays the PLMN with the following information: - <p_PLMN_List1> offers voice call, SMS and PS data services - <p_PLMN_List2> offers voice call services - <p_PLMN_List3> offers PS data services	HS_ENH
Please check that in the manual PLMN list the UE indicates that: - <p_PLMN1> is present on the the User Controlled PLMN List - <p_PLMN2> is present on the Forbidden list - <p_PLMN3> is present on the Operator Controlled PLMN List	HS_ENH
Please insert the USIM card with an empty CSG allowed list	HSPA8_ENH
Please switch the PLMN selection mode of the UE to manual CSG selection	HSPA8_ENH
Please switch the PLMN selection mode of the UE to automatic CSG selection	HSPA8_ENH
Please select the following CSG manually: MCC = <p_MCC>, MNC = <p_MNC>, CSG = <p_CSG>	HSPA8_ENH
Please check that in the manual CSG list the UE display: <p_CSG1> accessible, <p_CSG2> not accessible	HSPA8_ENH
Please check that the Mobile UE indicates the reception of ETWS data <p_ETWS_Data> and alerts or activate alerting the user.	HSPA8_ENH
Please check that the Mobile UE does NOT indicate the reception of ETWS data <p_ETWS_Data> and not alert, nor activate alerting the user	HSPA8_ENH

B.1.13 A-GPS test suite parameters declarations

These parameters are used in the A-GPS ATS.

Table B.1.13: A-GPS PIXIT

Parameter Name	Description	Type	Default Value	Supported Value
px_GpsScenario	Pre-defined GPS scenario to be loaded by the upper tester in the Satellite Simulator. See 3GPP TS 34.108 [3], clause 10.7. Minimum value:0, Maximum value: 31	GpsScenarioType	0	
px_GeoInfo	Geographical information to be sent as Location Estimate in FACILITY message from the System Simulator.	Ext_Geographical Information	9032B9D66360B600323C3C006544	
px_LcsClientName	LCS Client name	IA5String	OPERATOR	
px_LcsClientAddressTOA	LCS Client external address TOA	B4	'1001'B	
px_LcsClientAddressNPI	LCS Client external address NPI	B4	'0001'B	
px_LcsClientAddressDigits	LCS Client external address Digits	IA5String	0123456	
px_ResetStoredInfo	Support of RESETUEPOSITIONINGSTORE DIFORMATION command as defined in 3GPP TS 34.109 [4], clause 6.10	BOOLEAN	TRUE	
px_UeLcsNotification	Value for UE LCS Notification timeout timer (in seconds)	INTEGER	20	

B.1.14 HSD_ENH test suite parameters declarations

These parameters are used in the HSD_ENH ATS.

Table B.1.14: HSD_ENH PIXIT

Parameter Name	Description	Type	Default Value	Supported Value
----------------	-------------	------	---------------	-----------------

px_GERANlu_RadioAccessCapability	MS GERAN lu mode Radio Access Capability	BITSTRING		
px_RAB_HS_Exec128_384Supp	Execute UL 128 KBPS RAB HS test cases, when UE supports UL384	BOOLEAN	TRUE	
px_RAB_HS_Exec64_384Supp	Set to TRUE if 384kbps is supported and if tests on 64kbps shall be executed	BOOLEAN	TRUE	
px_RAB_HS_Exec64_128Supp	Execute UL 64 KBPS RAB HS test cases, when UE supports UL128	BOOLEAN	TRUE	
px_CMAS_CB_Data01	Contents of the first CMAS Cell Broadcast Message of 90 characters.	IA5String	"First CMAS message: CMAS Presidential Alert. ABCDEFGHIJKLMN OPQRSTUVWXYZ 0123456789 abcdefghijklmnopqrst"	
px_CMAS_CB_Data02	Contents of the second CMAS Cell Broadcast Message of 90 characters.	IA5String	"Second CMAS message: CMAS Imminent Threat Alert – Severity: Extreme, Urgency: Immediate. ABCDEFGHIJ"	
px_CMAS_CB_Data03	Contents of the third CMAS Cell Broadcast Message of 90 characters.	IA5String	"Third CMAS message: CMAS Child Abduction Emergency. ABCDEFGHIJKLMN OPQRSTUVWXYZ 0123456789 abcdefghijklmnopqrst"	

B.1.15 HSU_ENH test suite parameters declarations

These parameters are used in the HSU_ENH ATS.

Table B.1.15: HSU_ENH PIXIT

Parameter Name	Description	Type	Default Value	Supported Value
px_ExecNon_FDPCH_When_FD PCHSupp	To execute Non-FDPCH test case when fully FDPCH is supported	BOOLEAN	TRUE	

B.1.16 HS_ENH test suite parameters declarations

These parameters are used in the HS_ENH ATS.

Table B.1.16: HS_ENH PIXIT

Parameter Name	Description	Type	Default Value	Supported Value
Void				

B.1.17 Audit capabilities test suite parameters declarations

These parameters are used in the audit capabilities test case.

Table B.1.17.1: UTRA audit capabilities PIXIT

Parameter Name	Description	Type	Default Value	Supported Value
px_MaxNumberROHC_ContextSessions	Maximum number of ROHC context sessions, see 3GPP TS 25.331 [21], clause 10.3.3.24	MaxROHC_ContextSessions_r4		
px_ReverseDecompressionDepth	Reverse decompression depth, see 3GPP TS 25.331 [21], clause 10.3.3.24	INTEGER		

Table B.1.17.2: GERAN audit capabilities PIXIT

Parameter Name	Description	Type	Default Value	Supported Value
px_8PSK_PowerCap	Radio Capability used for 8PSK modulation, see 3GPP TS 24.008 [9], clause 10.5.5.12a	B2		
px_Alt_EFTA_MultislotClass	Alternative Enhanced Flexible Timeslot Assignment Multislot Class, see 3GPP TS 24.008 [9], clause 10.5.5.12a	B4		
px_EGPRS_MultislotClass	Integer representation of the multislot class, see 3GPP TS 24.008 [9], clause 10.5.5.12a	INTEGER		
px_GERAN_to_EUTRA_Support	GERAN to E-UTRA support in GERAN packet transfer mode, see 3GPP TS 24.008 [9], clause 10.5.5.12a	B2		
px_GMSK_PowerCap	Power Class used for GMSK with the indicated Access Technology, see 3GPP TS 24.008 [9], clause 10.5.5.12a	B3		
px_GPRS_MultislotClass	Integer representation of the multislot class, see 3GPP TS 24.008 [9], clause 10.5.5.12a	INTEGER		
px_Max_RLC_AM_Entries	Maximum number of RLC entries operating in acknowledged mode, see 3GPP TS 44.118 [61], clause 9.3.46	B3		
px_Max_RLC_UM_Entries	Maximum number of RLC entries operating in unacknowledged mode, see 3GPP TS 44.118 [61], clause 9.3.46	B3		
px_Max_RLC_T_Entries	Maximum Number of RLC entries operating in transparent mode, see 3GPP TS 44.118 [61], clause 9.3.46	B3		
px_Multislot_Capability_Reduction_for_Downlink_Dual_Carrier	Multislot Capability Reduction for Downlink Dual Carrier, see 3GPP TS 24.008 [9], clause 10.5.5.12a	B3		

Table B.1.17.3: E-UTRA audit capabilities PIXIT

Parameter Name	Description	Type	Default Value	Supported Value
px_eMaxNumberROHC_ContextSessions	Maximum number of ROHC context sessions	maxNumberROHC_ContextSessions_Type		
px_InterFreqMeasBandList_eBand1	Indicates need for measurement gaps when operating on the E-UTRA band 1 and measuring other supported E-UTRA bands.	InterFreqBandList		
px_InterFreqMeasBandList_eBand2	Indicates need for measurement gaps when operating on the E-UTRA band 2 and measuring other supported E-UTRA bands.	InterFreqBandList		
px_InterFreqMeasBandList_eBand3	Indicates need for measurement gaps when operating on the E-UTRA band 3 and measuring other supported E-UTRA bands.	InterFreqBandList		
px_InterFreqMeasBandList_eBand4	Indicates need for measurement gaps when operating on the E-UTRA band 4 and measuring other supported E-UTRA bands.	InterFreqBandList		
px_InterFreqMeasBandList_eBand5	Indicates need for measurement gaps when operating on the E-UTRA band 5 and measuring other supported E-UTRA bands.	InterFreqBandList		
px_InterFreqMeasBandList_eBand6	Indicates need for measurement gaps when operating on the E-UTRA band 6 and measuring other supported E-UTRA bands.	InterFreqBandList		
px_InterFreqMeasBandList_eBand7	Indicates need for measurement gaps when operating on the E-UTRA band 7 and measuring other supported E-UTRA bands.	InterFreqBandList		
px_InterFreqMeasBandList_eBand8	Indicates need for measurement gaps when operating on the E-UTRA band 8 and measuring other supported E-UTRA bands.	InterFreqBandList		
px_InterFreqMeasBandList_eBand9	Indicates need for measurement gaps when operating on the E-UTRA band 9 and measuring other supported E-UTRA bands.	InterFreqBandList		
px_InterFreqMeasBandList_eBand10	Indicates need for measurement gaps when operating on the E-UTRA band 10 and measuring other supported E-UTRA bands.	InterFreqBandList		
px_InterFreqMeasBandList_eBand11	Indicates need for measurement gaps when operating on the E-UTRA band 11 and measuring other supported E-UTRA bands.	InterFreqBandList		
px_InterFreqMeasBandList_eBand12	Indicates need for measurement gaps when operating on the E-UTRA band 12 and measuring other supported E-UTRA bands.	InterFreqBandList		
px_InterFreqMeasBandList_eBand13	Indicates need for measurement gaps when	InterFreqBandList		

Parameter Name	Description	Type	Default Value	Supported Value
	operating on the E-UTRA band 13 and measuring other supported E-UTRA bands.			
px_InterFreqMeasBandList_eBand14	Indicates need for measurement gaps when operating on the E-UTRA band 14 and measuring other supported E-UTRA bands.	InterFreqBandList		
px_InterFreqMeasBandList_eBand17	Indicates need for measurement gaps when operating on the E-UTRA band 17 and measuring other supported E-UTRA bands.	InterFreqBandList		
px_InterFreqMeasBandList_eBand18	Indicates need for measurement gaps when operating on the E-UTRA band 18 and measuring other supported E-UTRA bands.	InterFreqBandList		
px_InterFreqMeasBandList_eBand19	Indicates need for measurement gaps when operating on the E-UTRA band 19 and measuring other supported E-UTRA bands.	InterFreqBandList		
px_InterFreqMeasBandList_eBand20	Indicates need for measurement gaps when operating on the E-UTRA band 20 and measuring other supported E-UTRA bands.	InterFreqBandList		
px_InterFreqMeasBandList_eBand21	Indicates need for measurement gaps when operating on the E-UTRA band 21 and measuring other supported E-UTRA bands.	InterFreqBandList		
px_InterRAT_MeasBandList_eBand1	Indicates need for DL measurement gaps when operating on the E-UTRA band 1 and measuring other supported inter-RAT bands	interRAT_BandList		
px_InterRAT_MeasBandList_eBand2	Indicates need for DL measurement gaps when operating on the E-UTRA band 2 and measuring other supported inter-RAT bands	interRAT_BandList		
px_InterRAT_MeasBandList_eBand3	Indicates need for DL measurement gaps when operating on the E-UTRA band 3 and measuring other supported inter-RAT bands	interRAT_BandList		
px_InterRAT_MeasBandList_eBand4	Indicates need for DL measurement gaps when operating on the E-UTRA band 4 and measuring other supported inter-RAT bands	interRAT_BandList		
px_InterRAT_MeasBandList_eBand5	Indicates need for DL measurement gaps when operating on the E-UTRA band 5 and measuring other supported inter-RAT bands	interRAT_BandList		
px_InterRAT_MeasBandList_eBand6	Indicates need for DL measurement gaps when operating on the E-UTRA band 6 and measuring other supported inter-RAT bands	interRAT_BandList		
px_InterRAT_MeasBandList_eBand7	Indicates need for DL measurement gaps when operating on the E-UTRA band 7 and measuring other	interRAT_BandList		

Parameter Name	Description	Type	Default Value	Supported Value
	supported inter-RAT bands			
px_InterRAT_MeasBandList_eBand8	Indicates need for DL measurement gaps when operating on the E-UTRA band 8 and measuring other supported inter-RAT bands	interRAT_Band List		
px_InterRAT_MeasBandList_eBand9	Indicates need for DL measurement gaps when operating on the E-UTRA band 9 and measuring other supported inter-RAT bands	interRAT_Band List		
px_InterRAT_MeasBandList_eBand10	Indicates need for DL measurement gaps when operating on the E-UTRA band 10 and measuring other supported inter-RAT bands	interRAT_Band List		
px_InterRAT_MeasBandList_eBand11	Indicates need for DL measurement gaps when operating on the E-UTRA band 11 and measuring other supported inter-RAT bands	interRAT_Band List		
px_InterRAT_MeasBandList_eBand12	Indicates need for DL measurement gaps when operating on the E-UTRA band 12 and measuring other supported inter-RAT bands	interRAT_Band List		
px_InterRAT_MeasBandList_eBand13	Indicates need for DL measurement gaps when operating on the E-UTRA band 13 and measuring other supported inter-RAT bands	interRAT_Band List		
px_InterRAT_MeasBandList_eBand14	Indicates need for DL measurement gaps when operating on the E-UTRA band 14 and measuring other supported inter-RAT bands	interRAT_Band List		
px_InterRAT_MeasBandList_eBand17	Indicates need for DL measurement gaps when operating on the E-UTRA band 17 and measuring other supported inter-RAT bands	interRAT_Band List		
px_InterRAT_MeasBandList_eBand18	Indicates need for DL measurement gaps when operating on the E-UTRA band 18 and measuring other supported inter-RAT bands	interRAT_Band List		
px_InterRAT_MeasBandList_eBand19	Indicates need for DL measurement gaps when operating on the E-UTRA band 19 and measuring other supported inter-RAT bands	interRAT_Band List		
px_InterRAT_MeasBandList_eBand20	Indicates need for DL measurement gaps when operating on the E-UTRA band 20 and measuring other supported inter-RAT bands	interRAT_Band List		
px_InterRAT_MeasBandList_eBand21	Indicates need for DL measurement gaps when operating on the E-UTRA band 21 and measuring other supported inter-RAT bands	interRAT_Band List		

B.1.18 eCall and HSPA8 test suite parameters declarations

These parameters are used in the eCall and HSPA8 ATS.

Table B.1.18: eCall and HSPA8 PIXIT

Parameter Name	Description	Type	Default Value	Supported Value
px_eCall_TestNumber	Number digits of the test number used in eCall Test Call. Numbers are in the order: Digit 1, Digit 2, Digit 3, etc (see 3GPP TS 24.008 [9], clause 10.5.4.7)	IA5String	"123456"	
px_eCall_ReconfNumber	Number digits of the reconfiguration number used in eCall Reconfiguration Call. Numbers are in the order: Digit 1, Digit 2, Digit 3, etc (see 3GPP TS 24.008 [9], clause 10.5.4.7)	IA5String	"987654"	
px_ETWS_BMC_CB_RepPeriod	CB repetition period for ETWS CB message	INTEGER	2	
px_ETWS_BMC_NoOfBC_Req	No of broadcasts requested for ETWS CB message	INTEGER	2	
px_ETWS_DigitalSignature	ETWS Digital Signature	OCTETSTRING		
px_ETWS_SMS_CB_Data01	Contents of the first ETWS Cell Broadcast Message sent will be converted to an OCTETSTRING	IA5String_BMC	"First ETWS Cell Broadcast Message"	
px_ETWS_SMS_CB_Data02	Contents of the second ETWS Cell Broadcast Message sent will be converted to an OCTETSTRING	IA5String_BMC	"Second ETWS Cell Broadcast Message"	
px_ETWS_SMS_CB_Data03	Contents of the third ETWS Cell Broadcast Message sent will be converted to an OCTETSTRING	IA5String_BMC	"Third ETWS Cell Broadcast Message"	
px_ETWS_SMS_CB_Data04	Contents of the fourth ETWS Cell Broadcast Message sent will be converted to an OCTETSTRING	IA5String_BMC	"Fourth ETWS Cell Broadcast Message"	
px_ETWS_SMS_CB_Data05	Contents of the fifth ETWS Cell Broadcast Message sent will be converted to an OCTETSTRING	IA5String_BMC	"Fifth ETWS Cell Broadcast Message"	
px_ETWS_SMS_CB_Data06	Contents of the sixth ETWS Cell Broadcast Message sent will be converted to an OCTETSTRING	IA5String_BMC	"Sixth ETWS Cell Broadcast Message"	
px_ETWS_TimeZone	Value of the Time Zone in ETWS cell broadcast message	TZONES	0	

B.1.19 IR_U test suite parameters declarations

These parameters are used in the IR_U ATS.

Table B.1.19: IR_U PIXIT

Parameter Name	Description	Type	Default Value	Supported Value
px_ITURegion1_GSM_BandsUnderTest	Indicates the GSM band under test for ITU region 1	ITURegion1_GSM_BandsUnderTest		
px_ITURegion2_GSM_BandsUnderTest	Indicates the GSM band under test for ITU region 2	ITURegion2_GSM_BandsUnderTest		
px_ITURegion1_SecondaryFDD_Band	Indicates the secondary FDD band under test for ITU region 1	ITURegion1_FD D_Band		
px_ITURegion2_SecondaryFDD_Band	Indicates the secondary FDD band under test for ITU region 2	ITURegion2_FD D_Band		

Annex C (informative): Additional information to IXIT

Notwithstanding the provisions of the copyright related to the text of the present document, The Organizational Partners of 3GPP grant that users of the present document may freely reproduce the IXIT proforma in this annex so that it can be used for its intended purposes and may further publish the completed IXIT.

Additional information may be provided when completing the IXIT questions listed in annex A.

C.1 Identification Summary

Table C.1 is completed by the test laboratory. The item "Contract References" is optional.

Table C.1: Identification Summary

IXIT Reference Number	
Test Laboratory Name	
Date of Issue	
Issued to (name of client)	
Contract References	

C.2 Abstract Test Suite Summary

In table C.2 the test laboratory provides the version number of the protocol specification and the version number of ATS which are used in the conformance testing.

Table C.2: ATS Summary

Protocol Specification	3GPP TS 25.331
Version of Protocol Specification	
Test Specification in prose	3GPP TS 34.123-1
Version of TSS & TP Specification	
ATS Specification	3GPP TS 34.123-3
Version of ATS Specification	
Abstract Test Method	Distributed Test Method

C.3 Test Laboratory

C.3.1 Test Laboratory Identification

The test laboratory provides the following information.

Table C.3.1: Test Laboratory Identification

Name of Test Laboratory	
Postal Address	
Office address	
e-mail address	
Telephone Number	
FAX Number	

C.3.2 Accreditation status of the test service

The test laboratory provides the following information.

Table C.3.2: Accreditation status of the test service

Accreditation status	
Accreditation Reference	

C.3.3 Manager of Test Laboratory

The test laboratory provides the information about the manager of test laboratory in table C.3.3.

Table C.3.3: Manager of Test Laboratory

Name of Manager of Test Laboratory	
e-mail address	
Telephone Number	
FAX Number	
E-mail Address	

C.3.4 Contact person of Test Laboratory

The test laboratory provides the information about the contact person of test laboratory in table C.3.4.

Table C.3.4: Contact person of Test Laboratory

Name of Contact of Test Laboratory	
e-mail address	
Telephone Number	
FAX Number	
E-mail Address	

C.3.5 Means of Testing

In table C.3.5, the test laboratory provides a statement of conformance of the Means Of Testing (MOT) to the reference standardized ATS, and identifies all restrictions for the test execution required by the MOT beyond those stated in the reference standardized ATS.

Table C.3.5: Means of Testing

Means of Testing

C.3.6 Instructions for Completion

In table C.3.6, the test laboratory provides any specific instructions necessary for completion and return of the proforma from the client.

Table C.3.6: Instruction for Completion

Instructions for Completion

C.4 Client

C.4.1 Client Identification

The client provides the identification in table C.4.1.

Table C.4.1: Client Identification

Name of Client	
Postal Address	
Office Address	
Telephone Number	
FAX Number	

C.4.2 Client Test Manager

In table C.4.2 the client provides information about the test manager.

Table C.4.2: Client Test Manager

Name of Client Test Manager	
Telephone Number	
FAX Number	
E-mail Address	

C.4.3 Client Contact person

In table C.4.3 the client provides information about the test contact person.

Table C.4.3: Client Contact person

Name of Client contact person	
Telephone Number	
FAX Number	
E-mail Address	

C.4.4 Test Facilities Required

In table C.4.4, the client records the particular facilities required for testing, if a range of facilities is provided by the test laboratory.

Table C.4.4: Test Facilities Required

Test Facilities Required

C.5 System Under Test

C.5.1 SUT Information

The client provides information about the SUT in table C.5.1.

Table C.5.1: SUT Information

System Name	
System Version	
SCS Reference	
Machine Configuration	
Operating System Identification	
IUT Identification	
ICS Reference for the IUT	

C.5.2 Limitations of the SUT

In table C.5.2, the client provides information explaining if any of the abstract tests cannot be executed.

Table C.5.2: Limitation of the SUT

Limitations of the SUT

C.5.3 Environmental Conditions

In table C.5.3 the client provides information about any tighter environmental conditions for the correct operation of the SUT.

Table C.5.3: Environmental Conditions

Environmental Conditions

C.6 Ancillary Protocols

This clause is completed by the client in conjunction with the test laboratory.

In the following tables, the client identifies relevant information concerning each ancillary protocol in the SUT other than the IUT itself. One table for one ancillary protocol.

Based on the MOT the test laboratory should create question proforma for each ancillary protocol in the blank space following each table. The information required is dependent on the MOT and the SUT, and covers all the addressing, parameter values, timer values and facilities (relevant to ENs) as defined by the ICS for the ancillary protocol.

C.6.1 Ancillary Protocols 1

Table C.6.1: Ancillary Protocol 1

Protocol Name	
Version number	
ICS Reference (optional)	
IXIT Reference (optional)	
PCTR Reference (optional)	

C.6.2 Ancillary Protocols 2

Table C.6.2: Ancillary Protocol 2

Protocol Name	
Version number	
ICS Reference (optional)	
IXIT Reference (optional)	
PCTR Reference (optional)	

Annex D (informative): PCTR Proforma

Notwithstanding the provisions of the copyright related to the text of the present document, The Organizational Partners of 3GPP grant that users of the present document may freely reproduce the PCTR proforma in this annex so that it can be used for its intended purposes and may further publish the completed PCTR.

PROTOCOL

Conformance Test Report

(PCTR)

Universal Mobile Telecommunication System, UMTS,
User Equipment-Network Access

Layer 3 Signalling Functions

Test Candidate	
Name:	SUT name
Model:	model
H/W version:	hw
S/W version:	sw
Serial No.:	serienr

Client	
Name:	
Street / No.:	
Postal Code / City:	
Country:	

This Test Report shall not be reproduced except in full without the written permission of TEST LAB REFERENCE, and shall not be quoted out of context.

Annex E (informative): TTCN style guide for 3GPP ATS

E.1 Introduction

This annex provides a set of coding standards and development guidelines for use in the development of TTCN abstract test suites for ensuring that user equipment for the 3GPP standard conforms to the relevant core specifications.

The following items are assumed to exist, but their specification is outside the scope of this annex.

- A complete unambiguous prose detailing all test cases to be implemented.
- A complete unambiguous set of core specifications.
- A complete unambiguous detailed description of all the messages that are to be sent.
- A tool or human process that can convert Test Suite Operation Definitions to physical processes within the test system or unit under test.
- An abstracted or generic application programmers interface to all hardware components in the system.
- A tool for the translation and/or compilation of ISO/IEC 9646 [41] series TTCN to run on a test platform.

It is recognized within the context of the 3GPP User Terminal that some of these items are not yet stabilized.

The structure of the present annex maps directly to the guidelines provided in ETR 141 [37]. Rules are repeated in the present annex for convenience, with additional information specific to 3GPP test suite development provided where relevant. For more detailed information or examples about the rules, see ETR 141 [37].

In the present annex, the terms 'should' and 'shall' are frequently used. For the purpose of this annex, the following definitions apply:

- **Shall** means that the rule must be adhered to for all ATS development. If a rule expressed in terms of 'shall' is not followed, either the ATS must be updated so that the rule is followed, or the rule in the coding conventions must be updated to resolve the difference.
- **Should** means that the rule is a guideline. If a rule expressed in terms of 'should' is broken, a brief comment should be provided describing why the guideline does not apply.

E.2 ETR 141 rules and applicability

RULE 1: Statement of naming conventions
--

Naming conventions should be explicitly stated. Naming conventions should not exist only for a single ATS, and the reader of an ATS should not be forced to "derive" the rules implicitly. The naming conventions should be part of the ATS conventions contained in the ATS specification document.
--

Names used in the present annex are comprised of a prefix part and a name body part. Conventions for deriving prefixes and name bodies are described after Rule 3 in the present annex.

RULE 2: Coverage of naming conventions

Naming conventions stated should, as a minimum, cover the following TTCN objects:

- test suite parameters/constants/variables;
- test case variables;
- formal parameters;
- timers;
- PDU/ASP/structured types;
- PDU/ASP/structured types constraints;
- test suite operations;
- aliases;
- test case/test step identifiers.

RULE 3: General properties of naming conventions

a) Protocol standard aligned

When there is a relationship between objects defined in the ATS and objects defined in the protocol standard, e.g. PDU types, the same names should be used in the ATS if this does not conflict with the character set for TTCN identifiers or with other rules. In case of a conflict, similar names should be used.

b) Distinguishing

The naming conventions should be defined in such a way, that objects of different types appearing in the same context, e.g. as constraint values, can be easily distinguished.

c) Structured

When objects of a given type allow a grouping or structuring into different classes, the names of these objects should reflect the structuring, i.e. the names should be composed of 2 or more parts, indicating the particular structure elements.

d) Self-explaining

The names should be such that the reader can understand the meaning (type/value/contents) of an object in a given context. When suffixes composed of digits are used, it is normally useful to have some rule expressed explaining the meaning of the digits.

e) Consistent

The rules stated should be used consistently throughout the document, there should be no exceptions.

f) Appropriate name length

Following the above rules extensively may occasionally lead to very long names, especially when structuring is used. The names should still be easily readable. When TTCN graphical form (TTCN.GR) is used, very long names are very inconvenient.

NOTE: Also, test tools may not be able to implement very long identifier names, which is an important aspect in this context.

E.2.1 Multiple words are separated by upper case letters at the start of each word

Many names consist of more words, and it shall be easy to distinguish the different words building up the same name. For all TTCN Object classes this is done using the case of the letters.

This rule is mandatory for all names appearing in the body of a dynamic behaviour table, and is recommended for all other TTCN object classes.

Generally every word a name consists of shall start with an upper case letter and the rest of this word shall be in lower case letters.

- E.g.: "channel" + "description" -> "ChannelDescription".

This rule also applies if a word starts after another upper case letter.

- E.g.: "px" + "Cell" + "A" + "Cell" + "Id" -> px_CellACellId.

This rule also applies if the name has a prefix, which is always lower case.

- E.g.: A test case variable "sequence" + "number" -> tcv_SequenceNumber.

This rule does not apply if the word is a unit, in which case the word retains it's original case.

- E.g.: Power level 1.5 dBm ->PowerLvl1_5dBm.

This rule does not apply if the word in the name is an acronym, in which case the word retains it's normal case.

- If an acronym is followed by another word, an underscore shall be used to separate the acronym from the following word. If an acronym is followed by a number in order to represent an identity (e.g. channel or radio bearer identity) then this acronym is not followed by an underscore.
E.g.: "this" + "Is" + "SIM" + "Message" + "With" + "CC" + "And" + "RR" + "Things" + "In" + "It" -> "thisIsSIM_MessageWithCC_AndRR_ThingsInIt".
- An exception to acronyms retaining their case is if the name is a field / element / parameter in a structured type / PDU / ASP, in which case it must start with a lower case letter.
E.g.: "SCH" + "info" + "element" -> "sCH_InfoElement".
- A further exception to acronyms retaining their case is if the name is an ASN.1 constraint, in which case, in which case the first letter is upper case, and the remaining letters are lower case.

For all objects used in the body of dynamic behaviour tables, use of underscores is forbidden, except for the following situations:

- As a replacement for a '!'. E.g. Test case that maps to prose clause 7.2.3.1 -> tc_7_2_3_1.
- To separate prefixes from names.
- To separate acronyms from the following word.
- To separate a number from the following word.
- To replace hyphens when types are re-used / imported from core specifications. This applies to types imported from ASN.1 definitions, and to names derived from table definitions in core specifications.
- To separate an ASP name from the embedded PDU name when the metatype PDU is not used.
E.g. RRC_DataInd_ConnAck for an RRC data indication ASP with an embedded CONNECT ACKNOWLEDGE PDU.

E.2.2 Identifiers shall be protocol standard aligned

To support rule 3(a), the mapping guidelines in table E.2.2 shall be used. This mapping table also supports rule 6.

Table E.2.2: Mapping guidelines between protocol standards and identifiers

Type	Naming rule
Objects of Structured Type	Shall be derived from the name of the Information Element in the standard, if it corresponds to this (use standard acronyms where appropriate). E.g.: "Window Size super-field" -> "WindowSizeSUF1"
Fields in a Structured Type	Shall be derived from the name of the same field in the corresponding Information Element in the standard. (Acronyms for the entire field name shall not be used) E.g.: "Header Extension Type" -> "headerExtensionType" (not "HE")
Objects of ASP type	Shall be derived from the name of the corresponding Service Primitive in the Standard, using any relevant abbreviations from the present annex. The full name as it appears in the core specification shall be included in parentheses after the name. E.g.: "CRLC-SUSPEND-Conf" -> "CRLC_SuspendCnf (CRLC-SUSPEND-Conf)" If the metatype PDU is not used, the ASP name shall reflect both the ASP, and the embedded PDU name, using an underscore to separate the ASP part from the PDU part. E.g.: DataReq_StartDTMF_Ack for an RRC-DATA-Req with an embedded START DTMF ACKNOWLEDGE PDU
Objects of PDU type	Shall have exactly the same name as the Message it corresponds to in the standard. If this Message is named by more words, they shall be joined, leaving the blanks out E.g.: "AMD PDU" -> "AMDPDU".

E.2.3 Identifiers shall be distinguishing (use of prefixes)

To support rules 2, 3(b), 4, and 5, the prefixes shown in table E.2.3.1 shall be used for TTCN objects. Prefixes are separated from the name by an underscore to improve readability by clearly separating the prefix from the name. This convention will also support searching operations. For example, a search for all uses of PIXIT parameters in the test suite is possible by searching for 'px_'.

The optional *<protocol>* part shall be included in the name when the object is closely related to the protocol (e.g. PICS, some PIXIT parameters), it is necessary to be unambiguous or improves comprehension significantly (e.g. no need to think about protocol stacks on all used interfaces during reading). The optional *<protocol>* part shall be used for types defined in common modules.

Table E.2.3.1: Prefixes used for TTCN objects

TTCN object	Case of first character	Prefix	Comment
Test Suite	Upper	-	
TTCN Module	Upper	-	
Simple Type	Upper	[<protocol>_]	Note 8
Structured Type	Upper	[<protocol>_]	Note 8
Element in Structured Type	Lower	-	
ASN.1 Type	Upper	[<protocol>_]	Note 8
Element in ASN.1 Type	Lower	-	
Test Suite Operation	Upper	o_ [<protocol>_]	Notes 1 and 8
TSO Procedural Definition	Upper	o_ [<protocol>_]	Notes 1 and 8
Formal Parameter to TSO or TSOP	Upper	p_	
Test Suite Parameter (PICS)	Upper	pc_ [<protocol>_]	Note 8
Test Suite Parameter (PIXIT)	Upper	px_ [<protocol>_]	Note 8
Test Case Selection Expression	Upper	[<protocol>_]	Note 8
Test Suite Constant	Upper	tsc_ [<protocol>_]	Note 8
Test Suite Variable	Upper	tsv_ [<protocol>_]	Note 8
Test Case Variable	Upper	tcv_ [<protocol>_]	Note 8
PCO Type	Upper	-	
PCO	Upper	-	Note 2
CP	Upper	cp_	Note 2
Timer	Upper	t_ [<protocol>_]	Note 8
Test Component	Upper	mtc_ [<protocol>_] or ptc_ [<protocol>_]	Notes 3 and 8
Test Component Configuration	Upper	-	
ASP Type	Upper	[<protocol>_]	Notes 4 and 8
Parameters within ASP Type	Lower	-	Note 4
PDU Type	Upper	[<protocol>_]	Notes 4 and 8

TTCN object	Case of first character	Prefix	Comment
Fields within PDU Type	Lower	-	Note 4
Encoding Definition	Upper	enc_	
Encoding Variation	Upper	var_	
Invalid Field Encoding Variation	Upper	inv_	
CM Type	Upper	cm_	
Field within CM Type	Lower	-	
Alias	Upper	a_	
ASP constraint	Upper	ca[b d][s r w]_ [<protocol>_]	Notes 5 and 8
PDU constraints	Upper	c[b d][s r w]_ [<protocol> AA 108]	Notes 5, 8 and 10
Constraint (other types)	Upper	c[b d][s r w]_ [<protocol>_]	Notes 5 and 8
Formal Parameter for a Constraint	Upper	p_	
Test Case Group	Upper	<protocol>/	Note 8
Test Step Group	Upper		
Test Case	Upper	tc_	Note 6
Test Step	Upper	(ts_ pr_ po_)<CN domain>_<protocol>_	Notes 7, 8 and 9
Local tree	Upper	lt_	
Defaults	Upper	<protocol>_	Note 8
<p>NOTE 1: Coding rules are not specified for test suite operation procedural definitions at this stage. These rules will be defined when the need arises</p> <p>NOTE 2: A prefix is not used for PCO declarations, but is used for CP declarations. This is because PCOs and CPs will only be used in send and receive statements, and PCOs will be used more frequently than CPs. Since a PCO name or a CP name will be used on most behaviour lines, PCO names should be as short as possible - E.g. 2 to 3 characters.</p> <p>NOTE 3: The prefix is mtc if the component role is MTC, or ptc if the component role is PTC. If multiple PTCs are used, the rest of the identifier will clarify which PTC is being referred to. E.g. ptc_Cell1, ptc_Cell2.</p> <p>NOTE 4: This applies for both tabular and ASN.1 definitions.</p> <p>NOTE 5: Constraint prefixes are built up from the following regular expression. c[a][b d][s r w].</p> <ul style="list-style-type: none"> - 'c' shall always be present to indicate that the object is a constraint. - 'a' shall be present for ASP constraints to distinguish them from PDU constraints. - 'b' shall be present if and only if the constraint is used as a base constraint. (i.e. included in the derivation path of any other constraint). - 'd' shall be present if the constraint is derived from another constraint.(i.e. has an entry in it's derivation path field) - 'b' and 'd' cannot both be used in the same constraint, thereby limiting the derivation path to 1. - For the purpose of the present note, the following definitions are required (see TR 101 666 [27] clause 12.6.2): <ul style="list-style-type: none"> - The term 'field' is used to represent a structured type element, an ASP parameter, or a PDU field. - A 'bound field' is a field that either contains a SpecificValue, or is Omitted (-). - An 'unbound field' is a field that contains any of the following matching mechanisms: Complement, AnyValue (?), AnyOrOmit (*), ValueList, Range, SuperSet, SubSet, AnyOne (?), AnyOrNone (*), Permutation, Length, or IfPresent. - 's' may optionally be present if the constraint is only used in send statements. 's' shall not be present if the constraint contains any unbound fields, or any fields chained to a constraint whose prefix includes 'w' or 'r'. - 'r' may optionally be present if the constraint is only used in receive statements. - 'w' may optionally be present to indicate that the constraint contains fields that are unbound. Before these constraints are used in SEND events, all unbound fields must either be bound by using a derived constraint, or explicitly assigned a value in the SEND event behaviour line. - Either 'w' or 'r' shall be used if any fields in the constraint are unbound or are chained to a constraint whose prefix includes 'w' or 'r'. <p>NOTE 6: Test case names will correspond to the clause in the prose that specifies the test purpose. E.g. tc_7_2_23_2. An additional digit may be specified if more than one test case is used to achieve the test purpose. If an additional digit is required, this probably means that the test prose are not well defined.</p> <p>NOTE 7: Test steps may optionally use the prefixes pr_ or po_ to indicate that the test step is a preamble or postamble respectively.</p>			

TTCN object	Case of first character	Prefix	Comment
NOTE 8: Protocol abbreviations are provided in table E.2.3.2. Protocol abbreviations may optionally be used to clarify the scope of TTCN objects, or to resolve conflicts when the same name is required by multiple protocols within the ATS. The protocol abbreviation indicates that the object is related to a particular procedure (e.g. an MM procedure). This does not prevent the object from being used by an ATS testing a different protocol. If an object is specific to one ATS, this should be indicated in comments, rather than using a protocol abbreviation (e.g. if a timer is only used in RLC tests this should be stated in the comments, rather than using the abbreviation RLC in the timer name). If two different types exist in the ATS that represent the same information (e.g. IMSI) conversion operations shall be used to ensure consistency between the types. Also, conversion operations shall be used to avoid asking the same PIXIT question twice. For example, if a type is defined as an OCTETSTRING[4] for a NAS protocol, and the same type is represented as a BITSTRING[32] for RRC, a single PIXIT question shall be asked, and conversion operations shall be used to ensure that the same value is used for both types.			
NOTE 9: The prefixes CS and PS may optionally be used to indicate that a test step is specific to circuit switched, or packet switched signalling respectively. For test steps specific to the Upper Tester, the prefixes AT or MMI or UT shall be used to indicate that, respectively, AT or MMI or both types of commands are used.			
NOTE 10: The prefix AA shall be used for RRC PDU constraints to indicate that it is defined in 3GPP TS 34.123-1 [1] annex A. The prefix 108 shall be used for RRC PDU constraints to indicate that it is defined in 3GPP TS 34.108 [3] clause 9.			

Table E.2.3.2: Protocol abbreviations for prefixes

Protocol / prefix
BMC
CC
CS
GMM
MAC
MM
PDCP
RLC
RRC
SMS
SS
SUS (Supplementary services)
TC

E.2.4 Identifiers should not be too long (use standard abbreviations)

To assist in keeping TTCN identifiers shorter, table E.2.4 provides a non-exhaustive set of standard abbreviations that shall be used when naming objects that are used in the body of dynamic behaviour tables. Consistent use of abbreviations will improve test suite readability, and assist maintenance.

Table E.2.4: Standard abbreviations

Abbreviations	Meaning
Acs	access
Acp	accept
Ack	acknowledge
act	activation
addr	address
(re)alloc	(re)allocated, (re)allocation
arg	argument
ass	assignment
auth	authentication
ava	avail, available
bCap	bearer capability
cau	cause
clg	calling
ch	channel

Abbreviations	Meaning
chk	check
ciph	cipher, ciphering
cld	called
clsmk	classmark
cmd	command
cmpl	complete
cnf	confirm
cfg	configuration
conn	connect
ctrl	control
def	default
descr	description
disc	disconnect
enq	enquiry
err	error
(re)est	(re)establish
ext	extended
fail	failure
ho	handover
id	identity / identification
ie	information element
iel	information element length
ind	indication
info	information
init	initialize
lvl	level
loc	location
locUpd	location update
max	maximum
mgmt	management
min	minimum
misc	miscellaneous
mod	modification
ms	mobile station
msg	message
mt	mobile terminal
neigh	neighbour
ntw	network
num	number
orig	origin/-al
pag	page/-ing
params	parameters
perm	permission
phy	physical
qual	quality
rand	random
ref	reference
reg	register
rej	reject
rel	release
req	request
rsp	response
rx	receiver
sel	selection
seq	sequence
serv	service
st	state
sysInfo	system information
sync	synchronization
sys	system
tx	transmitter

RULE 4: Specific naming rules for test suite parameters/constants/variables test case variables and formal parameters

- a) The name should reflect the purpose/objective the object is used for.
- b) If the type is not a predefined one, it is useful that the name reflects the type, too.
- c) It could be useful, that the individual naming conventions are not the same for all object classes this rule applies to. e.g. use upper case letters for test suite parameters/constants, and use one of the other possibilities presented in ETR 141 [37] example 1 for other object classes.

See also ETR 141 [37], clauses 5.1 to 5.4 for further discussion on naming test suite parameters.

RULE 5: Specific naming rule for timers

If the timer is not defined in the protocol to be tested, the name should reflect the objective of the timer used for testing.
NOTE: There is no need to indicate the object type "timer" in the name, since timers only occur together with timer operations

RULE 6: Specific naming rule for PDU/ASP/structured types

As far as applicable, derivation rules or mapping tables should be used to relate the names of the types to the corresponding objects in the protocol or service definition.
NOTE: There may be types, e.g. erroneous PDU types, that do not relate to an object in the protocol or service definition.

Whenever names of types are derived from ASN.1 type definitions provided in the core specifications, the names shall remain the same as the ASN.1 specifications, and references shall be provided in the comment fields.

RULE 7: Specific naming rule for PDU/ASP/structured types constraints

Rules should be stated to derive the names from the names of the corresponding type definitions. It is often possible to use the type name plus an appropriate suffix reflecting the specific constraint value. In case of lengthy names, useful abbreviations or a defined numbering scheme can be chosen.

Constraint names begin with the appropriate prefix, followed by the first letter of each word in the type, followed by words describing the peculiarity of the constraint. E.g. Type = RadioBearerSetupPDU, constraint name could be cb_RBSP_GenericUM_DTCH.

RULE 8: Specific naming rule for test suite operations

The name should reflect the operation being performed.
i.e. the name should indicate an activity, not a status. This can be achieved e.g. by using appropriate prefixes like "check", "verify", etc.

RULE 9: Specific naming rule for aliases

The name should reflect that aspect of its expansion, that is important in the situation where the alias is used. Derivation rules should be provided to derive the alias name from its macro expansion or from the name of an embedded ASP / PDU.

See also ETR 141 [37], clauses 6.3.6 and 9 for further guidelines on naming aliases.

RULE 10: Specific naming rule for test steps

The name should reflect the objective of the test step.

RULE 11: Selecting the ASN.1 format for type definitions

- a) If the protocol standard uses ASN.1 to specify the PDUs, the ATS specifier should also use ASN.1.
- b) If the protocol standard does not use ASN.1, check carefully whether features of ASN.1 that the tabular format of type definition does not present are necessary in the ATS, or could ease the design and understanding of the definitions as a whole. Check especially whether fields or parameters have to be specified, the order of appearance of which, in a received ASP/PDU, cannot be predicted. If any of these conditions apply, use ASN.1 for type and ASP/PDU type declarations.
- c) Use the option of "ASN.1 ASP/PDU type Definitions by Reference" whenever applicable.
- d) Example 14 shows a compatibility problem that could occur, when ASN.1 type declarations as well as tabular type declarations are used in an ATS. Use the ATS Conventions to describe how this compatibility problem is handled in the ATS, i.e. whether in expressions and assignments entities defined in ASN.1 are only related to entities defined in ASN.1 or not.

Names of ASN.1 objects shall be kept the same as the core specifications in this case, even where the names are at odds with the naming conventions adopted for other TTCN objects.

RULE 12: Further guidelines on type definitions

- a) Use simple type or ASN.1 type definitions whenever an object of a base type with given characteristics (length, range, etc.) will be referenced more often than once.
- b) Use the optional length indication in the field type or parameter type column of structured type and ASP/PDU type definitions whenever the base standard/profile restricts the length.
NOTE 1: This can often be achieved by references to simple types.
- c) Map the applicable ASPs/PDUs from the service/protocol standard to corresponding ASP/PDU type definitions in the ATS.
NOTE 2: It may happen that not all ASPs/PDUs of a service/protocol standard are applicable to a particular ATS for the related protocol. It may also happen that additional ASP/PDU type declarations are necessary, e.g. to create syntactical errors.
- d) Map the structure of ASPs/PDUs in the service/protocol standard to a corresponding structure in the ATS.
NOTE 3: This mapping is not always one-to-one, e.g. because a field in the PDU definition of the protocol standard is always absent under the specific conditions of an ATS. But it should normally not happen, that a structured element in the protocol standard is expanded using the "<" macro expansion, so that the individual fields are still referenced, but the structure is lost in the ATS.

RULE 13: Specification of test suite operations

- a) Use a test suite operation only if it cannot be substituted by other TTCN constructs.
- b) Write down the rationale/objective of the test suite operation.
Reference standards if applicable.
- c) Classify and simplify algorithm.
Split test suite operation if too complex.
- d) Choose an appropriate specification language depending on the rationale/objective:
 - predicates for Boolean tests;
 - abstract data types for manipulation of ASN.1 objects;
 - programming languages for simple calculation.
- e) Check/proof the test suite operation:
 - is the notation used known/explained;
 - are all alternative paths fully specified;
 - is the test suite operation returning a value in all circumstances;
 - are error situations covered (empty input variables, etc.).
- f) State some evident examples.

E.2.5 Test suite operations must not use global data

All information required by test suite operations must be passed as formal parameters. This includes test suite variables, test case variables, test suite parameters, and constraints.

RULE 14: General aspects of specifying constraints

- a) Develop a design concept for the complete constraints part, particularly with respect to the "conflicting" features as indicated in items i) to iv) and including naming conventions (see ETR 141 [37] clause 6).
- b) Make extensive use of the different optional "Comment" fields in the constraint declaration tables to highlight the peculiarity of each constraint.

RULE 15: Relation between base constraints and modified constraints

- a) Define different base constraints for the send- and receive direction of a PDU (when applicable).
 - b) Use modified constraints preferably when only a small number of fields or parameter values are altered with respect to a given base.
- NOTE 1: For SEND events the creation of a further modified constraint can sometimes be avoided, if an assignment is made in the SEND statement line, thus overwriting a particular constraint value.
- c) Design the relation between base constraints and modified constraints always in connection with parameterization of constraints (see the two subsequent subclauses).
- NOTE 2: Additional parameters in a constraint, introduced to avoid the declaration of further base/modified constraints can reduce the amount of constraints needed in an ATS, but then the constraint reference is getting more and more unreadable.
- d) When modified constraints are used, keep the length of the derivation path small. The length of the derivation path (resulting from the number of dots in it) is a kind of nesting level, and it is known from experience that a length greater than 2 is normally difficult to overview and maintain.

Modified constraints should not have a derivation path longer than 1. A modified constraint should not alter more than 5 values with respect to a given base constraint. If a constraint is used as a base constraint, it must have the prefix 'cb', to warn test suite maintainers / developers that any changes to this constraint may cause side effects.

Note that if an existing constraint without the 'cb' prefix is to be used as a base constraint, either a new, identical constraint with an 'cb' prefix must be created, or the existing constraint must be renamed to include the 'cb' prefix in all places it is referenced in the test suite.

RULE 16: Static and dynamic chaining

- a) Make a careful evaluation of which embedded PDUs are needed in ASPs/PDUs, in which (profile) environment the ATS may operate and which kind of parameterization for other parameters/fields is needed, to find an appropriate balance between the use of static and/or dynamic chaining in a particular ATS.
- b) When the ATS is used in different profile environments and the types and values of embedded PDUs cannot be predicted, dynamic chaining is normally the better choice.
- c) When static chaining is used, choose the name of the ASP/PDU constraint such that it reflects the peculiar value of the embedded PDU (see also the clause on naming conventions in ETR 141 [37]).

RULE 17: Parameterization of constraints

- a) Make a careful overall evaluation of which field/parameter values are needed in ASPs and PDUs to find an appropriate balance between the aim of a comparably small number of constraint declarations and readable and understandable constraint references.
- b) Keep the number of formal parameters small.
Keep in mind, that the number of formal parameters in structured/ASN.1 types Constraints will add up to the total number of ASP/PDU constraints.
A clear border for the number of formal parameters cannot be stated, but it is known from experience that a number bigger than 5 normally cannot be handled very well.

Constraints should not be passed more than five parameters. Instead, more constraints should be defined. Related parameters can be grouped in new structured types to reduce the number of parameters that must be passed to constraints.

NOTE 1: The value five has been selected based on the recommendation in ETR 141 [37] rule 17. If more parameters are required, we can update this rule, or use more than 5 parameters, and provide documentation indicating why more parameters are required.

A constraint should not be passed parameters to that are not processed in that constraint. If for example a parameter is to be passed from a PDU constraint to a structured type constraint then the PDU constraint should be made specific and not have that parameter passed. The reason for this is that no editors as yet can trace through this mechanism and it becomes very difficult in a complex suite to see exactly what is being passed.

For example:

```
PduA ::= SEQUENCE {
  infoElement1 InformationElementType1,
  infoElement2 INTEGER
}

InformationElementType1 ::= SEQUENCE {
  field1 INTEGER,
  field2 INTEGER
}

cb_PATypical( p_Field1: INTEGER; p_Field2: INTEGER ) ::= {
  infoElement1 c_IET1Typical( p_Field1 ),
  infoElement2 p_Field2
}

c_IET1Typical( p_Field1: INTEGER ) ::= {
  field1 p_Field1,
  field2 5
}
```

In the example constraint `cb_PATypical`, passing `p_Field1` through to a nested constraint is not allowed, but the use of `p_Field2` is acceptable.

RULE 18: Constraint values

- | | |
|----|--|
| a) | Use comments to highlight the peculiarity of the value, especially when the value is a literal, whose meaning is not apparent. |
| b) | Use test suite constants instead of literals, when appropriate.
Normally not all literals can be defined as Test Suite Constants, but a rule by thumb is: if a literal value of a given type occurs more than once (as a constraint value or more generally in an expression), then it is useful to define it as a Test Suite Constant, letting the name reflect the value. |
| c) | Use the length attribute when possible and when the length is not implicit in the value itself or given by the type definition (e.g. for strings containing "**"). |

RULE 19: Verdict assignment in relation to the test body

Make sure that verdict assignment within a default tree is in relation to the test body. If an unsuccessful event arising in the test body is handled by the default tree, then assign a preliminary result "(FAIL)" within the corresponding behaviour line of the default tree. If the position of the unsuccessful event is not in the test body, assign a preliminary result "(INCONCLUSIVE)". If the behaviour line handling the unsuccessful event is a leaf of the default tree, assign a final verdict instead.

RULE 20: Test body entry marker

The entry of the test body should be marked.
--

RULE 21: State variable

For realizing test purposes dependent on protocol states, use a variable to reflect the current state of the IUT.

RULE 22: State checking event sequences

Combine event sequences used for checking a state of the IUT within test steps.

RULE 23: Easy adaptation of test steps to test cases

For easy adaptation of a test step to test case needs, parameterize the constraints used within a test step.
--

Test steps may be parameterized, but with no more than five parameters. See also ETR 141 [37] clause 12.2 and rule 28. Related parameters can be grouped in new structured types to reduce the number of parameters that must be passed to constraints.

NOTE 2: Again, the value five has been selected based on the recommendation in ETR 141 [37] rule 17. If more parameters are required, we can update this rule, or use more than 5 parameters, and provide documentation indicating why more parameters are required.

RULE 24: Minimizing complexity of test steps

Minimize the complexity of test steps either by restricting the objective of a test step to atomic confirmed service primitives or by separating event sequences, which build different "logical" units into different test steps.

RULE 25: Nesting level of test steps

Keep the nesting level of test steps to a minimum.

RULE 26: Recursive tree attachment

Avoid recursive tree attachment. Where possible, use loops instead of recursive tree attachments.

RULE 27: Verdict assignment within test steps

If verdicts are assigned within a test step, guarantee at least the partial (i.e. not general) re-use of the test step.

RULE 28: Parameterized test steps

Use parameterized test steps to ensure re-use of test steps within test cases for different needs.

RULE 29: Combining statements in a sequence of alternatives

If there is no Boolean expression included in an alternative sequence, a statement of type UCS (unconditional statement) should never be followed by a statement of type UCS or CS (conditional statement) within a sequence of alternatives.

RULE 30: Using relational expressions as alternatives

- a) A relational expression should never restrict the value range of a preceding relational expression in the same alternative sequence using the same variable.
- b) The value range of a relational expression should be different from the whole value range of all preceding relational expressions in the same alternative sequence using the same variable.

RULE 31: Loop termination

Do not use conditions for terminating loops, which depend only on the behaviour of the IUT.

RULE 32: Avoiding deadlocks

- a) Make sure that each alternative sequence of receive events contains an OTHERWISE statement (without any qualifier) for each PCO.
- b) Make sure that each alternative sequence of receive events contains at least one TIMEOUT event (implying that a corresponding timer was started).

A set of alternatives using qualifiers shall always include an alternative containing the qualifier [TRUE], to provide a default behaviour if none of the qualifiers match.

For example:

```
[ tcv_Value = 1 ]
  AM ! ASP_ForValue1
  ...
[ tcv_Value = 2 ]
  AM ! ASP_ForValue2
  ...
[ TRUE ]
  AM ! ASP_ForOtherValues
  ...
```

RULE 33: Straightforward specification of test cases

- a) Use only event sequences leading to the test body within a preamble.
- b) Handle all event sequences not leading to the test body within the default tree of the test case/step.
- c) If the very same event sequence can be used to transfer the IUT from each possible state to the idle state, then realize this event sequence as a postamble.

RULE 34: Test component configuration declaration

Avoid recursive test component configuration declarations.

RULE 35: Default trees with RETURN statement

Special care should be taken by using a RETURN statement within a default tree in order to avoid an endless loop resulting from the expansion of the default tree.

E.3 3GPP ATS implementation guidelines

This clause provides a set of guidelines that must be followed during ATS development. In general, these guidelines are intended to prevent developers from making common errors, or discuss considerations that must be taken into account before using specific features of the TTCN language.

E.3.1 Test case groups shall reflect the TSS&TP document

Test groups shall be used to organize the test cases in the same way as the test purposes are structured in the prose specification.

The general structure of the test groups should be in the following format.

<protocol>/<group>/<subgroup>

E.g. RLC/UM/Segmentation/LengthIndicator7bit/

E.3.2 Test case names correspond to the clause number in the prose

Test case names are derived directly from the clause number in the prose specification. Decimal points between digits in the clause number are replaced with underscores. E.g. the test case name for the test purpose specified in clause 7.2.3.2 of 3GPP TS 34.123-1 [1] is tc_7_2_3_2. If more than one test case is required to achieve a test purpose, an additional digit may be added. See also ETR 141 [37], clause 6.3.7.

E.3.3 Use standard template for test case and test step header

Table E.3.3.1 illustrates how the Test Case dynamic behaviour header fields should be used.

Table E.3.3.1: Template for TTCN test case table header

Field		Contents			
Test Case Name:		tc_NUMBER_OF_TESTCASE The number of the test case, which is used in the name of the test case, is the number it has in the prose specification. e.g.: "tc_26_13_1_3_1"			
Group:		Is automatically filled and cannot be changed			
Purpose:		This is taken directly from the prose specifications.			
Configuration:		As required if concurrent TTCN is being used.			
Default		The appropriate default			
Comments:		<p>First line contains: Specification: The names and clauses of relevant core specifications.</p> <p>Next line contains: Status: OK / NOT OK (+explanation if not ok) / Version number / Validated / Reviewed, etc. E.g.: Status: OK</p> <p>Rest of lines give comments as: What has to be done before running this test? E.g.: 1. Generic setup procedure must be completed before running this test. Any special information about what might be needed for the testing system, like specific requirements for the testing system, specific hacks, certain settings, etc. This field should be short (if long description is needed it must be put into Detailed Comments)</p>			
Selection Ref:		The appropriate test case selection expression.			
Description:		Optional. Max 4 lines. If available, this should be the title of the prose clause. Note 1			
Nr	Label	Behaviour Description	Constraints Ref	Verdict	Comments
1		Note 3	Note 3		Note 2
Detailed Comments		Contains detailed information about test steps + additional information Note 2			
NOTE 1: The description field in the test case / step header is used to generate the test suite overview, and should only include a brief overview of the test case / step with a maximum of 4 lines. For a more detailed description of the test case / step algorithm / parameters etc, the comments or detailed comments fields should be used.					
NOTE 2: The comments field for each behaviour line should usually consist of a number that is a reference to a specific numbered comment in the detailed comments field. If this extra level of indirection reduces readability, brief comments can be used in the comments field for each behaviour line.					
NOTE 3: If entries in the behaviour description or constraints reference column contain lists with more than one element, carriage returns should be used between list elements to prevent the line from becoming too long.					

Table E.3.3.2 illustrates how the Test Case dynamic behaviour header fields should be used.

Table E.3.3.2: Template for TTCN test step table header

Test Step Name	ts_TestStepName(p_Param1: Param1Type; p_Param2: Param2Type)				
Group	Is automatically filled and cannot be changed				
Objective	The objective of the test case. Provides a brief summary of the functionality of the test step.				
Default	The appropriate default				
Comments	<p>A detailed description of the test step, including the relevant items from the following categories:</p> <p>Algorithm A detailed description of the algorithm / principles used within the test step</p> <p>Parameters: A description of each of the parameters passed to the test step, including the purpose of the parameter, valid values, restrictions etc.</p> <p>Preconditions The required state of the UE and / or SS before using this test step, including test steps that should be executed before using the present test step, and a description of all test case variables that must contain appropriate values before using this test step.</p> <p>Postconditions The expected state of the UE and / or SS after using this test step, including a description of all test case variables that will be modified by this test step.</p> <p>NOTE: It is too difficult to maintain the list of variables required / affected by nested test steps, so it is the users responsibility to check which variables are required / affected by nested test steps.</p>				
Description	Optional. Max 4 lines. Note 1				
Nr	Label	Behaviour Description	Constraints Ref	Verdict	Comments
1		Note 3	Note 3		Note 2
Detailed Comments	Contains detailed information about test steps + additional information Note 2				
<p>NOTE 1: The description field in the test case / step header is used to generate the test suite overview, and should only include a brief overview of the test case / step with a maximum of 4 lines. For a more detailed description of the test case / step algorithm / parameters etc, the comments or detailed comments fields should be used.</p> <p>NOTE 2: The comments field for each behaviour line should usually consist of a number that is a reference to a specific numbered comment in the detailed comments field. If this extra level of indirection reduces readability, brief comments can be used in the comments field for each behaviour line.</p> <p>NOTE 3: If entries in the behaviour description or constraints reference column contain lists with more than one element, carriage returns should be used between list elements to prevent the line from becoming too long.</p>					

E.3.4 Do not use identical tags in nested CHOICE constructions

A nested CHOICE requires tags in the different alternative type lists to differ (see ISO/IEC 8824 [29], clause 24.4, example 3, INCORRECT). "The tag shall be considered to be variable, ... becomes equal to the tag of the "Type" ... from which the value was taken".

EXAMPLE: components are defined in a nested CHOICE construction, but no distinguishing tags are used to make the difference between component types, i.e. tags for different types turn out to be identical.

```

Component ::= CHOICE {
  GSMLocationRegistration_Components  GSMLocationRegistration_Components,
  GSMLocationCancellation_Components  GSMLoactionCancellation_Components,
  ...
}

GSMLocationRegistration_Components ::= CHOICE {
  GSMLocationRegistration_InvokeCpt    [1] IMPLICIT GSMLocationRegistration_InvokeCpt,
  GSMLocationRegistration_RRCpt        [2] IMPLICIT GSMLocationRegistration_RRCpt,
  GSMLocationRegistration_RECpt         [3] IMPLICIT GSMLocationRegistration_RECpt,
  GSMLocationRegistration_RejectCpt     [4] IMPLICIT RejectComponent
}

```

```

GSMLocationCancellation_Components ::= CHOICE {
  gSMLocationCancellation_InvokeCpt [1] IMPLICIT GSMLocationCancellation_InvokeCpt,
  gSMLocationCancellation_RejectCpt [4] IMPLICIT RejectComponent
}

```

gSMLocationRegistrationInvokeCpt and gSMLocationCancellation_InvokeCpt have the same tag and can therefore not distinguished anymore. Note that ITEX 3.5 does not report this error.

E.3.5 Incorrect usage of enumerations

Enumerations may contain distinct integers only (see ISO/IEC 8824 [29], clause 15.1).

EXAMPLE: TypeOfNumber containing a NamedValueList in which there are non-distinct values.

```

TypeOfNumber ::= ENUMERATED {
  .....
  internationalnumber (1),
  level2RegionalNumber (1),
  nationalNumber (2),
  level1RegionalNumber (2),
  .....
}

```

E.3.6 Structured type as OCTETSTRING should not be used

"It is required to declare all fields of the PDUs that are defined in the relevant protocol standard, ..." TR 101 101 [38] TTCN specification clause 11.15.1.

EXAMPLE 1: The ISDN Bearer Capability Information Element (BCAP) contents is defined as OCTETSTRING.

EXAMPLE 2: Usage of data type BITSTRING [7..15] as data type of the Call Reference (= 7 bits or =15 bits, but not 8 bits for example) does not correspond to the specification !!).

E.3.7 Wildcards in PDU constraints for structured types should not be used

Contrary to popular belief, TR 101 666 [27] does not support the use of wildcards for TTCN ASP parameters, or TTCN PDU fields whose type is structured. It is not clearly stated if wildcards are permitted for TTCN structured type elements whose type is structured but it is assumed that they are not permitted because the semantics for this are not clearly specified.

Note that this does not apply to ASN.1 Type definitions, ASPs, or PDUs.

Most tools do support wildcards for TTCN ASP parameters / TTCN PDU fields / TTCN structured type elements whose type is structured, but there is ambiguity between implementations since the semantics are not clearly specified in the core specification.

This feature is commonly used by TTCN developers, and is present in many existing test suites, including the 3GPP test suite, and in constraints that are being re-used from GERAN tests.

One problem with values '?' and '*' in constraints where they are used to indicate values of structured types, is that they would allow any combinations of values - even incorrect ones - which is not admissible according to the specifications. It is to be kept in mind that in tabular form each field is optional! It would be better to create and use an "any"-constraint which would deal with all the fields in detail (mandatory, IF PRESENT, etc.).

For the purpose of the present annex, the following rules shall apply:

1. '?' shall not be used to indicate values of TTCN ASP parameters / TTCN PDU fields / TTCN structured type elements whose type is structured. Known TTCN implementations differ significantly in their implementation of this feature.

- 2. '*' shall not be used for TTCN PDU fields, or TTCN ASP parameters whose type is structured (i.e. at the top level).
 - 2.1 Usage of wildcards should be avoided in structured type identifiers. Only simple type fields should use * or ?
- 3. '*' is permitted but discouraged for structured type elements whose type is structured. Note that this may result in ambiguous behaviour between TTCN implementations because the semantics are not specified in TR 101 666 [27].
- 4. One of the following two options shall be used as an alternative to using a '?' for a TTCN ASP parameter / TTCN PDU field / TTCN structured type element whose type is structured.

4.1 Option 1: Use '*' instead (only applicable to structured type elements due to rules 2 and 3 above).

WARNING: This may result in the situation where a UE omits a mandatory field, but passes the test anyway, and / or different behaviour depending on the TTCN tool used.

4.2 Option 2 (preferred option; supported by TR 101 666 [27]): Use an 'any' constraint, in conjunction with IF PRESENT if appropriate (whole TTCN ASP parameters / TTCN PDU fields / TTCN structured type elements may be omitted according to TR 101 666 [27]). This means that the constraint value specified for the parameter / field / element shall be a reference to another constraint of the appropriate structured type, which may in turn use wildcards for each of it's elements according to the rules specified in the present annex.

- 5. A structured type formal parameter should not be used together with the IF_PRESENT indication inside a structured type constraint. If this is required, then this shall be clearly commented.

E.3.8 TSOs should be passed as many parameters as meaningful to facilitate their implementation

Parameters should be passed to TSOs to facilitate the TSO realization. If a TSO is used in various contexts, this should be reflected in the parameters passed to the TSO. Specifically, TSOs operating on well-defined (parameterized) constraints should take these constraints (including relevant parameters) as parameters if required.

BAD EXAMPLE: In this example, the TSO may be used in many contexts, but no information is passed to the TSO, which makes TSO realization difficult.

		L?SETUPr (... tcv_invokeId := TSO_GET_INVOKEID (), ...)	Sr (SU_GR3(GSM_IncomingCallMMInfo_Inv voke(...)))		
--	--	--	--	--	--

GOOD EXAMPLE: In this case, the TSO is provided with information about the data object from which the invoke Id is to be extracted, and the type of component from which the invoke Id is to be extracted is identified by passing the component constraint.

		L?SETUPr (... tcv_invokeId := TSO_GET_INVOKEID (DL_DataInd_Setup.msg, GSM_IncomingCallMMInfo_Inv oke(...)), ...)	Sr (SU_GR3(GSM_IncomingCallMMInfo_Inv voke(...)))		
--	--	---	--	--	--

To calculate the invocation identification and store the result in variable tcv_invokeId the TSO has to be provided with information about the data object from which the invoke Id is to be extracted. PDU constraint SU_GR3 may contain several components. In the specific situation only one of these components is relevant.

Depending on the nature of the TSO, passing the received value, or a subcomponent of the received value may be more appropriate than passing the constraint.

E.3.9 Specification of Encoding rules and variation should be indicated

TTCN does not mandate encoding rules, although TTCN foresees that applicable encoding rules and encoding variations can be indicated for the data structures used in a test suite.

There are standards defining encoding rules, e.g. the ITU-T Recommendation X.680 [39] series. However, the type of encoding called "Direct Encoding" - a bit-by-bit-mapping from the data definitions onto the data stream to be transmitted - is not defined anywhere. It therefore needs a "home".

TTCN should therefore define which encoding rules may legally be used by TTCN test suite specifiers. All the encoding rules defined in the ITU-T Recommendation X.680 [39] series should be contained in this repertoire. Additionally an encoding rule called Direct Encoding is needed in particular for tabular TTCN.

ITU-T Recommendation X.680 [39] allows to encode data objects using different length forms (short, long, indefinite). These could be used alternatively as encoding variations. Another encoding variation could be the "minimum encoding", accepting any of the length forms in reception, and using the shortest of the available forms in sending. The variation actually used has to be described somewhere (in the ATS).

E.3.10 Use of global data should be limited

The Phase 2 ATS became extremely complex due to the global definition of data. Data should be defined locally where possible if the language allows, alternatively the names of global constraints could be given prefixes to indicate their use.

E.3.11 Limit ATS scope to a single layer / sub-layer

Separate ATSs should be produced to test each Layer and perhaps sub Layer. By doing this preambles and common areas particular to one sub Layer can be confined to one test suite and parallel development of test suites can be facilitated.

E.3.12 Place system information in specially designed data structures

System Information data could be stored in specially defined data structures, use of these structures to build PDUs may help to ensure that a consistent set of data is transmitted in all the channels in a cell.

E.3.13 Place channel configuration in specially designed data structures

Likewise the configuration of a 'channel' could be stored in similar structures. This data can then be used to configure the test system and to build Assignment messages to the UE under test. This may help avoid the situation where the TTCN creates one channel and unintentionally commands the mobile to a different, non-existent, channel.

E.3.14 PICS / PIXIT parameters

It is desirable to limit the scope of PICS / PIXIT parameters.

A default value shall be provided in the PIXIT document for all PIXIT parameters.

PICS / PIXIT parameters shall not include structured types. If a structured parameter is required, several parameters shall be used, one for each simple element within the type, and a constraint shall be created to combine the simple parameters into a structured type.

For example, to use the following structured type as a parameter.

Type Name	LocAreald_v		
Encoding Variation			
Comments	Location Area Identification Value 3GPP TS 24.008 [9] clause 10.5.1.3		
Element Name	Type Definition	Field Encoding	Comments
mcc	HEXSTRING[3]		MCC 3 digits
mnc	HEXSTRING[3]		MNC 3 digits
lac	OCTETSTRING[2]		LAC
Detailed Comments			

The following three PIXIT parameters should be defined: Parameter Name	Type	PICS/PIXIT Ref	Comments
px_LACDef	OCTETSTRING	PIXIT TC	default LAC
px_MCCDef	HEXSTRING	PIXIT TC	default MCC
px_MNCDef	HEXSTRING	PIXIT TC	default MNC

And then the following constraint can be used to combine the simple parameters into a structured parameter.

Constraint Name	cb_LocArealdDef_v		
Structured Type	LocAreald_v		
Derivation Path			
Encoding Variation			
Comments			
Element Name	Element Value	Element Encoding	Comments
mcc	px_MCCDef		
mnc	px_MNCDef		
lac	px_LACDef		
Detailed Comments			

E.3.15 Dynamic vs. static choices

Don't use wildcards for static choice constraints. For example, a type that is similar for FDD and TDD should have 2 type definitions, rather than a single type that uses an ASN.1 choice. Then in the TTCN, the correct type should be selected based on test suite parameters.

E.g.:

```
[ pxUseTddMode ] AM ! TddSpecificAsp
AM ?
...
[ pxUseFddMode ] AM ! FddSpecificAsp
AM ? ...
...
```

E.3.16 Definition of Pre-Ambles and Post Ambles

Test cases should, as far as possible, use one of a set of standard pre-ambles to place the user equipment in its initial conditions. These pre-ambles should align with the generic setup procedures in the conformance specification. All non-standard pre-ambles should be identified and added to the pre-amble library.

With pre-ambles readability is very important so they should not use other test steps to send message sequences, and they should be passed as few parameters as possible. This also makes the results log easier to read.

The prose message sequence charts should be analysed, and a catalogue of common ways in which the test cases can terminate (correctly or incorrectly) created. This catalogue should be used to create a set of post-ambles. All final verdicts should be assigned in the post-ambles.

Wherever possible, a post-amble should return the test system and the User Equipment under test to a known idle state.

E.3.17 Use test steps to encapsulate AT and MMI commands

When the same AT or MMI command is to be used more than once within a test suite, the command should be placed within a test step, to ensure that the same information is provided consistently. The main intention of this guideline is to ensure that MMI commands provided to the user are consistent, and can be changed easily if required.

For example, a test step similar to the one illustrated in table E.3.17 should be created and attached so that the same information is provided to the user each time the test step is used, and the string to be sent only exists in one place within the test suite.

Table E.3.17: Example test step to encapsulate AT / MMI commandsDefault behaviour

Test Step Name		ts_AT_MMI_Example			
Group					
Objective		Send an MMI command instructing the user to insert the USIM card into the UE.			
Default					
Comments		Encapsulate an AT / MMI command within a test step to ensure that the same information is used consistently, and the information only exists in one place within the test suite.			
Description					
Nr	Label	Behaviour Description	Constraints Ref	Verdict	Comments
1		Ut ! MMI_CmdReq	ca_MMICmdReq (" Please insert the USIM card into the UE ")		
2		Ut ? MMI_CmdCnf	ca_MMICmdCnf		

Defaults are test steps that are executed when ever a receive event occurs that is not expected. Not expected means that it does not match any of the defined ASP constraints at that point in the test case. The default behaviour used in test case is defined in the test case declaration. They can be defined to stop the test case by calling a standard post-amble or receive the event as OTHERWISE and RETURN back to step where the unexpected event occurred.

A strategy for dealing with unexpected behaviour involving consistent use of defaults should be developed, and applied to test cases wherever possible.

If during a test case or test step it is necessary to change the default behaviour, the ACTIVATE statement may be used.

E.3.18 Use system failure guard timers

A timer should be set at the beginning of each test case to guard against system failure. Behaviour on expiry of this timer should be consistent for all test cases.

E.3.19 Mapping between prose specification and individual test cases

The ATS should map one-to-one between test cases and tests as described in 3GPP TS 34.123-1 [1]. A method for ensuring that the two specifications track each other needs to be defined.

E.3.20 Verdict assignment

E.3.20.1 General

Final verdicts shall only be used to indicate test case errors, or when unexpected UE behaviour occurs such that it not sensible to continue the test. When a test case reaches a leaf node, the test case ends, and the current preliminary verdict is assigned. At least one preliminary verdict shall be assigned for every test case. If a test case terminates and no final or preliminary verdicts have been assigned, the current value of the predefined variable R will be 'none', and a test case error is recorded instead of a final verdict.

Labels shall be used for every line in which a verdict is posted to improve the traceability of the conformance log produced when the test case is executed. These labels should be kept short, since they appear in the dynamic behaviour tables.

All test suites shall make use of a global boolean variable, defined in the common module, called `tcv_TestBody`. `tcv_TestBody` is updated within each test case to indicate if the test body is currently being executed. `tcv_TestBody` is referenced in defaults and test steps to assign a preliminary inconclusive verdict when unexpected events occur outside of the test body, or a preliminary failure verdict when unexpected events occur within the test body.

The initial value in the declaration of the test case variable `tcv_TestBody` shall be `FALSE`. The variable will be bound to this value when the ATS is initialized, and will be re-bound to this value after termination of each test case, ready for execution of the next test case.

E.3.20.2 Test cases

A line similar to line 3 in table E.3.20.2 shall be used in all test cases to set `tcv_TestBody` to `TRUE`. This line shall have the label TBS to indicate the Test Body Start point.

A line similar to line 6 in table E.3.20.2 shall be used in all test cases to set `tcv_TestBody` to `FALSE`. This line shall have the label TBE[N] to indicate the Test Body End point. A number N (with one or more digits) may optionally be appended to the label to distinguish between multiple test body end points. If the number of possible test sequences makes management of the `tcv_TestBody` variable too difficult, the variable can be set to `TRUE` at the beginning of the test. In this case, a comment shall be added to the test case noting that `tcv_TestBody` is not updated, so verdicts assigned within preambles and postambles will be treated as if they are part of the test body.

Within the test body, preliminary verdicts shall be used to indicate the result of the test purpose. Each behaviour line within the test body containing a preliminary verdict shall have a label of the form TBXN, where X is one of P, F, I for pass, fail, and inconclusive respectively, and N is a number (with one or more digits) used to distinguish multiple TBPs, TBFs, or TBIs in the same test case.

If an unexpected event occurs corresponding to a test case error, a final inconclusive verdict shall be assigned, and the behaviour line shall have a label ERRN, where N is a number used to distinguish multiple ERRs, and ERR indicates that a test case error has occurred. An example of this is provided in the test step clause.

Table E.3.20.2 contains an example test case illustrating these concepts.

In case of a failure event of a time consumed test case (longer than 30 minutes), the test case can be stopped by using a final verdict after the execution of the postamble.

Table E.3.20.2: Example test case illustrating use of verdicts, labels and tcv_TestBody test case variable

Nr	Label	Behaviour Description	Constraints Ref	Verdict	Comments
1		+ts_Preambles			
2	TBS	(tcv_TestBody := TRUE)			1
3		L ! Stimulus	cs_Stimulus1		
4		+lt_Response			
5	TBE	(tcv_TestBody := FALSE)		(P)	2
6		+ts_Postambles			
7		lt_Response			
8	TBP1	L ? Response	cr_ValidResponse1	(P)	3
9	TBP2	L ? Response	cr_ValidResponse2	(P)	3
10	TBF1	L ? Response	cr_InvalidResponse	(F)	4
11	TBI1	L ? Response	cr_OtherResponse	(I)	5
Detailed comments		<ol style="list-style-type: none"> The behaviour line setting tcv_TestBody to TRUE shall have the label TBS. The behaviour line setting tcv_TestBody to FALSE shall have the label TBE, and can optionally be used to assign a verdict indicating that the test purpose has passed or failed (i.e. if the final behaviour statement in the test body is a tree attachment). The label TBPn is used to indicate that the test purpose has been achieved via the Nth possible valid UE behaviour. The label TBFn is used to indicate that the test purpose has not been achieved, due to the Nth possible failure cause. The label TBIn is used to indicate that the test result is inconclusive for the Nth possible unexpected / unknown event. 			

E.3.20.3 Test steps

To promote re-use, test steps shall only assign preliminary verdicts (I) and (F). (P) verdicts shall be managed at the test case level in general, but may be used sparingly within test steps. ETR 141 [37] clause 12.4 recommends that a preliminary pass verdict should be assigned at the leaf of each passing event sequence of the test step. If a test step includes an alternative for unexpected / invalid behaviour, then either a preliminary inconclusive verdict shall be assigned if tcv_TestBody is FALSE, or a preliminary failure verdict shall be assigned if tcv_TestBody is TRUE.

Each behaviour line within the test step containing a preliminary verdict shall have a label of the form TSXN, where X is one of P, F or I for pass, fail, and inconclusive respectively, and N is a number (with one or more digits) used to distinguish multiple TSPs, TSFs, or TSIs in the same test step.

If an unexpected event occurs corresponding to a test case error, a final inconclusive verdict shall be assigned, and the behaviour line shall have a label ERRN, where N is a number used to distinguish multiple ERRs, and ERR indicates that a test case error has occurred.

Table E.3.20.3 contains an example test step illustrating these concepts.

Table E.3.20.3: Example test step illustrating use of verdicts, labels and tcv_TestBody test case variable

Nr	Label	Behaviour Description	Constraints Ref	Verdict	Comments
1		[p_Mode = tsc_Mode1]			
2		L ! Stimulus	cs_Stimulus1		
3		+It_Response			
4		[p_Mode = tsc_Mode2]			
5		L ! Stimulus	cs_Stimulus2		
6		+It_Response			
7	ERR1	[TRUE]		I	1
8		It_Response			
9		L ? Response	cr_ValidResponse1		2
10		L ? Response	cr_InvalidResponse		
11	TSI1	[tcv_TestBody = FALSE]		(I)	3
12	TSF1	[tcv_TestBody = TRUE]		(F)	4
Detailed comments		<ol style="list-style-type: none"> 1. An invalid value for the parameter p_Mode has been passed to this test step, so a final inconclusive verdict is assigned, with a label indicating that a test case error has occurred. 2. If the expected behaviour occurs, then the test step completes at the leaf node, and the current preliminary verdict is not changed. 3. If unexpected / invalid behaviour occurs, and the current test step is being used as a preamble or postamble (tcv_TestBody = FALSE) then a preliminary inconclusive verdict is assigned. 4. If unexpected / invalid behaviour occurs, and the current test step is being used as part of the test purpose(tcv_TestBody = TRUE) then a preliminary failure verdict is assigned. 			

E.3.20.4 Defaults

Each behaviour line within a default behaviour table containing a preliminary verdict shall have a label of the form DFXN, where X is one of F or I for fail, and inconclusive respectively, and N is a number (with one or more digits) used to distinguish multiple DFFs, or DFIs in the same test step.

tcv_TestBody shall be referenced from within default behaviour tables to assign the appropriate verdict when unexpected events occur.

Table E.3.20.4 contains an example default behaviour table illustrating these concepts.

Table E.3.20.4: Example default behaviour table illustrating use of verdicts, labels and tcv_TestBody test case variable

Nr	Label	Behaviour Description	Constraints Ref	Verdict	Comments
1		L ? Response	cr_IgnoredResponse		1
2		RETURN			
3	DFI1	L ? OTHERWISE [tcv_TestBody = FALSE]		(I)	2
4	DFF1	L ? OTHERWISE [tcv_TestBody = TRUE]		(F)	3
Detailed comments		<ol style="list-style-type: none"> 1. Valid events that are to be ignored can be included in the default behaviour, but should have no preliminary verdict assigned. 2. If unexpected data is received in the preambles or postambles, a preliminary inconclusive verdict is assigned, and the test case is terminated. 3. If unexpected data is received in the test body, a preliminary failure verdict is assigned, and the test case is terminated. 			

See also ETR 141 [37], clauses 11.2, 12.4 and 14.3.

E.3.21 Test suite and test case variables

A default value shall be provided for all test suite and test case variables.

E.3.22 Use of macros is forbidden

The use of macros is forbidden, to support migration to TTCN3.

E.3.23 Support for future Radio Access Technologies

To allow existing test cases to be updated in future to support other radio access technologies, test suites shall make use of a PIXIT parameter `px_RAT` of type `RatType` as shown in the following example.

Test Case Name		tc_RAT_Example1			
Nr	Label	Behaviour Description	Constraints Ref	Verdict	Comments
1		START t_Guard(300)			
2		[px_RAT = fdd]			
3		PCO ! FDD_PDU	c_FDD_PDU1		FDD specific behaviour
4	TBP1	PCO ? COMMON_PDU	c_COMMON_PDU1	(P)	
5		[px_RAT = tdd]			
6		PCO ! TDD_PDU	c_TDD_PDU1		TDD specific behaviour
7	TBP2	PCO ? COMMON_PDU	c_COMMON_PDU1	(P)	
8		[px_RAT = other_rat]		I	Tests for this RAT not implemented yet
9	TCE1	[TRUE]		I	Unexpected px_RAT value
Detailed Comments					

In general, alternatives should be used to separate behaviour specific for each RAT, and common behaviour should be re-used as much as possible. A final inconclusive verdict shall be used for any alternatives that have not been implemented yet.

Local trees may be used as shown in the following example to improve re-use of common behaviour.

Test Case Name		tc_RAT_Example2			
Nr	Label	Behaviour Description	Constraints Ref	Verdict	Comments
1		START t_Guard(300)			
2		+lt_RAT_SpecificPart			
3	TBP1	PCO ? COMMON_PDU	c_COMMON_PDU1	(P)	Common behaviour
		lt_RAT_SpecificPart			
4		[px_RAT = fdd]			
5		PCO ! FDD_PDU	c_FDD_PDU1		FDD specific behaviour
6		[px_RAT = tdd]			
7		PCO ! TDD_PDU	c_TDD_PDU1		TDD specific behaviour
8	TCE1	[TRUE]		(I)	Unexpected px_RAT value
Detailed Comments					

E.3.24 Managing multiple representations of the same information

When the same information is represented using multiple types within the same test suite, it is necessary to manage conversions between the types, and ensure that the information remains consistent across all of the representations.

For example, IMSI is represented as 'SEQUENCE (SIZE (6..15)) OF Digit' in the RRC ASN.1 definitions, as a HEXSTRING for input as a PIXIT parameter, and as an information element defined in TTCN tabular format for MM.

E.3.24.1 Predefined types

Conversion operations are not required to convert the following TTCN predefined types to their counterparts in ASN.1.

- a) INTEGER predefined type.
- b) BOOLEAN predefined type.

- c) BITSTRING predefined type.
- d) HEXSTRING predefined type.
- e) OCTETSTRING predefined type.
- f) OBJECTIDENTIFIER predefined type.
- g) R_TYPE predefined type.
- h) CharacterString predefined types.

Therefore it is valid to pass a value of type BIT STRING (ASN.1) as a formal parameter of type BITSTRING (TTCN predefined).

E.3.24.2 Simple types

TR 101 666 [27], clause 11.2.1 states:

- "TTCN is a weakly typed language, in that values of any two types which have the same base type are considered to be type compatible (e.g. for the purposes of performing assignments or parameter passing)".

When simple types have restrictions, it is the TTCN author's responsibility to ensure that the restrictions are compatible. The TTCN compiler provides some assistance with this, but the extent of the checking is compiler specific.

E.3.24.3 Structured types

For conversion between more complex representations, test suite operations will generally be required. If the mapping is simple enough, it may be possible to perform the conversion using a test step, which takes the common representation as a parameter, and stores the required representation in a test case variable. This may avoid the need for an extra test suite operation.

E.3.24.4 Conversion responsibility

Two design approaches are possible for deciding where the responsibility of conversion lies: Calling party conversion and called party conversion.

The appropriate option should be selected on a case-by-case basis with the following restrictions:

- If one representation of the information is a PIXIT parameter, and this information must be passed to a test step, the called party conversion option shall be used, and the formal parameter to the test step shall always have the same type as the PIXIT parameter.
- If a test step provides multiple alternatives for different radio access technologies, which require different representations of the same information, the called party conversion convention shall be used. In this case a technology independent representation of the information shall be passed as a parameter, and the test step shall perform the conversion to the appropriate type depending on which RAT is being used.

E.3.24.5 Option 1: Calling party conversions

For this approach, each test step provides an interface based on its internal representation. It is the responsibility of the test case / step attaching the test step to perform the conversion before the attachment.

E.3.24.5.1 Advantages

- The number of calls to conversion operations is minimized.
- The complexity of the attached test steps is reduced because fewer conversions are required than for the called party conversion approach.

E.3.24.5.2 Disadvantages

- Different types are used to transfer the same information across the test step interfaces.
- The complexity of the attaching test steps / cases may be increased because conversions are required before attaching a test step.
- The attaching test steps / cases are responsible for ensuring that multiple representations contain consistent information.

E.3.24.6 Option 2: Called party conversions

In this case, the same representation is used wherever the information must be used as a formal parameter value to a test step, and it is the responsibility of the test step to perform any conversions required.

E.3.24.6.1 Advantages

- The complexity in the attaching test case / step is reduced, which will often improve readability.
- The test step interfaces are cleaner, because the same representation is always passed as a formal parameter.
- Internal representations may be hidden within test steps so that calling parties do not need to have any knowledge of them.

E.3.24.6.2 Disadvantages

- Conversion operations may be called more times than necessary, for example if the same test step is attached twice within one test case.

E.3.25 Assignment using constraint

According to TR 101 666 [27], the Right Hand Side (RHS) of an assignment shall not contain any unbound variables. The matching symbols, AnyValue or AnyOrOmit, in both tabular and ASN.1 constraints shall not be assigned to a test case variable, independent of the type of the test case variable.

E.3.26 Guidelines for use of timers when tolerances are applicable

Timed events within the test suite should implement the timer tolerances specified in 3GPP TS 34.108 [3], clause 4.2.3. It is the TTCN author's responsibility to ensure that appropriate tolerance checks and tolerance values are being used.

NOTE: Tolerances are not applicable to guard timers as described in clause E.3.18 of the present document.

E.3.26.1 Specific situations

The present clause provides recommendations for how to implement timers with tolerances for the following situations:

- a) The timed event must occur before a given time.
- b) The timed event must occur after a given time.
- c) The timed event must occur between two given times.

NOTE: A specific case of this situation is when the desired event occurs at a specific time, plus or minus a tolerance.

E.3.26.2 Example situations

The examples below assume:

- a) The test case variable `tcv_Duration` contains the timer duration (in terms of the units used in the timer declaration).
- b) The test case variable `tcv_Tolerance` has been initialized using one of the following assignments (it is the TTCN author's responsibility to select the calculation resulting in the greatest value of `tcv_Tolerance`. Reference 3GPP TS 34.108 [3], clause 4.2.3):
 - 1) (`tcv_Tolerance := tcv_Duration / 10`)
 - 2) (`tcv_Tolerance := 2 * tcv_TTI + tsc_T_Delta`)
Where `tcv_TTI` contains the applicable TTI (in ms), and `tsc_T_Delta` is 55 ms.

NOTE: The timer value parameters used when starting the timers in the examples are recommendations only. Other timer value parameter expressions may be used if appropriate.

E.3.26.2.1 Example of situation 1

Test Step Name		ts_TimerSituation1Example			
Purpose		To demonstrate implementation of a timed event that must occur before a given time.			
Nr	Label	Behaviour Description	Constraints Ref	Verdict	Comments
1		START t_UpperBound (tcv_Duration + tcv_Tolerance)			1.
2		+It_TimedEvent			2.
3	TSP1	CANCEL t_UpperBound		(P)	3.
4	TSP1	? TIMEOUT t_UpperBound		(F)	4.
		It_TimedEvent			
5		[TRUE]			2.
Detailed Comments		<ol style="list-style-type: none"> 1. Start the timer, allowing <code>tcv_Tolerance</code> extra units for the timed event to arrive. 2. The timed event is observed. 3. The timed event occurred before the timeout, so cancel the timer, and assign a preliminary pass verdict. 4. The timer expired before the timed event occurred, so assign a preliminary failure verdict. 			

E.3.26.2.2 Example of situation 2

Test Step Name		ts_TimerSituation2Example			
Purpose		To demonstrate implementation of a timed event that must occur after a given time.			
Nr	Label	Behaviour Description	Constraints Ref	Verdict	Comments
1		START t_LowerBound (tcv_Duration - tcv_Tolerance)			1.
2		? TIMEOUT t_LowerBound			2.
3		+It_TimedEvent			3.
4	TSP1	[TRUE]		(P)	3.
5		+It_TimedEvent			4.
6	TSP1	CANCEL t_LowerBound		(F)	4.
		It_TimedEvent			
7		[TRUE]			
Detailed Comments		<ol style="list-style-type: none"> 1. Start the timer, allowing <code>tcv_Tolerance</code> extra units for the timed event to arrive. 2. The timeout is observed before the timed event. 3. The timed event is observed, so assign a preliminary pass verdict. 4. The timed event occurred before the timeout, so cancel the timer, and assign a preliminary failure verdict. 			

E.3.26.2.3 Example of situation 3

Test Step Name		ts_TimerSituation3Example			
Purpose		To demonstrate implementation of a timed event that must occur between two given times.			
Nr	Label	Behaviour Description	Constraints Ref	Verdict	Comments
1		START t_UpperBound (tcv_Duration + tcv_Tolerance), START t_LowerBound (tcv_Duration - tcv_Tolerance)			1.
2		? TIMEOUT t_LowerBound			2.
3		+lt_TimedEvent			3.
4	TSP1	CANCEL t_UpperBound		(P)	3.
5	TSF1	? TIMEOUT t_UpperBound		(F)	4.
6		+lt_TimedEvent			5.
7	TSF2	CANCEL t_LowerBound , CANCEL t_UpperBound		(F)	
		lt_TimedEvent			
8		[TRUE]			
Detailed Comments		<ol style="list-style-type: none"> 1. Start the upper and lower bound timers, allowing tcv_Tolerance extra units each side of the expected time for the timed event to arrive. 2. The lower bound timeout is observed before the timed event. 3. The timed event is observed, so cancel the upper bound timer, and a preliminary pass verdict is assigned. 4. The upper bound timer expired before the timed event occurred, so a preliminary failure verdict is assigned. 5. The timed event occurred before the lower bound timer expired, so a preliminary failure verdict is assigned. 			

Annex F (informative): Void

Void.

Annex G (informative): Recommendation of an unique ICS/IXIT electronic exchange format

With standardization of ICS/IXIT file format, same Test Suite Parameter (TSP) files can be used across different System Simulators. The ICS/PIXIT will be simple ASCII text files. The assumption is that the test suite parameters are of simple type definitions only and do not include structured types (clause E.3.14).

G.1 Syntax

The proposed format of the ICS/IXIT file is as follows:

[<Parameter Name> <Parameter Type> <Value>] [<#Comment>]

- At the most one TSP value can be defined in a line.
- The comment starts with # and ends with new line.
- [...] represent OPTIONAL field(s).
- <..> represent MANDATORY field(s).
- Fields will be separated by one or more space characters.

The syntax for different Parameter Types will be as follows:

- **INTEGER**

<Parameter Name> INTEGER <Integer Value>

- **BOOLEAN**

<Parameter Name> BOOLEAN <Value>

NOTE 1: Here Value will be either 'TRUE' or 'FALSE'.

- **BITSTRING**

<Parameter Name> BITSTRING <Value>

- **HEXSTRING**

<Parameter Name> HEXSTRING <Value>

- **OCTETSTRING**

<Parameter Name> OCTETSTRING <Value>

- **ENUMERATED**

<Parameter Name> ENUMERATED <Integer Value>

- **IA5String**

<Parameter Name> IA5String "<Value>"

NOTE 2: Here Value will be string and is mandatory to put the actual value in double quotes.

G.2 Examples

This clause gives an example of ICS/IXIT file format.

```
# TSP file version 1.0.0
px_CS    BOOLEAN    TRUE # TRUE if Circuit Switched is applicable
px_PTMSI_Def    OCTETSTRING    12345678 #Default PTMSI
px_RAT    ENUMERATED    0    #px_RAT is of Type RatType and is of Type of ENUMERATED
           {fdd(0), tdd(1)}.
px_Region    IA5String    "Europe" #px_Region is of Type Region and is of Type IA5String ("Europe", "Japan").
px_PriScrmCodeA    INTEGER    100    #px_PriScrmCodeA is of Type PrimaryScramblingCode and is of Type
           INTEGER (0..511).
px_SRNC_Id    BITSTRING    000000000001    #px_SRNC_Id is of Type SRNC_Identity and is of Type BIT STRING
           (SIZE(12)).
px_IMSI_Def    HEXSTRING    001010123456063    #Default IMSI
```

Annex H (informative): A-GPS ASN.1 module

```

Lcs-Definitions DEFINITIONS ::=
BEGIN

--*****
-- From ITU-T Rec. X.880 (July/1994)
--*****

Code ::= CHOICE {
    local    INTEGER,
    global   OBJECT IDENTIFIER
}

--*****
-- From 3GPP TS 29.002
--*****

NotificationToMSUser ::= ENUMERATED {
    notifyLocationAllowed (0),
    notifyAndVerify-LocationAllowedIfNoResponse (1),
    notifyAndVerify-LocationNotAllowedIfNoResponse (2),

    locationNotAllowed (3) }
    -- exception handling:
    -- At reception of any other value than the ones listed the receiver shall ignore
    -- NotificationToMSUser.

LocationType ::= SEQUENCE {
    locationEstimateType      [0] IMPLICIT LocationEstimateType,

    deferredLocationEventType [1] IMPLICIT DeferredLocationEventType OPTIONAL }

LocationEstimateType ::= ENUMERATED {
    currentLocation (0),
    currentOrLastKnownLocation (1),
    initialLocation (2),

    activateDeferredLocation (3),
    cancelDeferredLocation (4),
    notificationVerificationOnly (5)
}
    -- exception handling:
    -- a ProvideSubscriberLocation-Arg containing an unrecognized LocationEstimateType
    -- shall be rejected by the receiver with a return error cause of unexpected data value

DeferredLocationEventType ::= BIT STRING {
    msAvailable (0),
    enteringIntoArea (1),
    leavingFromArea (2),
    beingInsideArea (3),
    periodicLDR (4)
} (SIZE (1..16))
    -- beingInsideArea is always treated as oneTimeEvent regardless of the possible value
    -- of occurrenceInfo inside areaEventInfo.
    -- exception handling:
    -- a ProvideSubscriberLocation-Arg containing other values than listed above in
    -- DeferredLocationEventType shall be rejected by the receiver with a return error cause of
    -- unexpected data value.

LCSCClientExternalID ::= SEQUENCE {
    externalAddress [0] IMPLICIT ISDN-AddressString OPTIONAL,
    extensionContainer [1] IMPLICIT ExtensionContainer OPTIONAL,

}

LCSCClientName ::= SEQUENCE {
    dataCodingScheme [0] IMPLICIT USSD-DataCodingScheme,
    nameString [2] IMPLICIT NameString,
    lcs-FormatIndicator [3] IMPLICIT LCS-FormatIndicator OPTIONAL
}

```

```

-- The USSD-DataCodingScheme shall indicate use of the default alphabet through the following
encoding
-- bit 7 6 5 4 3 2 1 0
--      0 0 0 0 1 1 1 1

NameString ::= USSD-String (SIZE (1..maxNameStringLength))

maxNameStringLength INTEGER ::= 63

USSD-DataCodingScheme ::= OCTET STRING (SIZE (1))
-- The structure of the USSD-DataCodingScheme is defined by the Cell
-- Broadcast Data Coding Scheme as described in TS 3GPP TS 23.038 [1]

LCSRequestorID ::= SEQUENCE {
    dataCodingScheme      [0] IMPLICIT USSD-DataCodingScheme,
    requestorIDString     [1] IMPLICIT RequestorIDString,
    lcs-FormatIndicator   [2] IMPLICIT LCS-FormatIndicator OPTIONAL
}

LCS-FormatIndicator ::= ENUMERATED {
    logicalName      (0),
    e-mailAddress   (1),
    msisdn          (2),
    url              (3),
    sipUrl          (4) }

RequestorIDString ::= USSD-String (SIZE (1..maxRequestorIDStringLength))

maxRequestorIDStringLength INTEGER ::= 63

LCSCodeword ::= SEQUENCE {
    dataCodingScheme      [0] IMPLICIT USSD-DataCodingScheme,
    lcsCodewordString    [1] IMPLICIT LCSCodewordString
}

LCSCodewordString ::= USSD-String (SIZE (1..maxLCSCodewordStringLength))

maxLCSCodewordStringLength INTEGER ::= 20

LCSServiceTypeID ::= INTEGER (0..127)
-- the integer values 0-63 are reserved for Standard LCS service types
-- the integer values 64-127 are reserved for Non Standard LCS service types

USSD-String ::= OCTET STRING (SIZE (1..maxUSSD-StringLength))
-- The structure of the contents of the USSD-String is dependent
-- on the USSD-DataCodingScheme as described in TS 3GPP TS 23.038 [25].

maxUSSD-StringLength INTEGER ::= 160

ISDN-AddressString ::= AddressString (SIZE (1..maxISDN-AddressLength))
-- This type is used to represent ISDN numbers.

maxISDN-AddressLength INTEGER ::= 9

AddressString ::= OCTET STRING (SIZE (1..maxAddressLength))
-- This type is used to represent a number for addressing purposes. It is
-- composed of
-- a) one octet for nature of address, and numbering plan indicator.
-- b) digits of an address encoded as TBCD-String.

-- a) The first octet includes a one bit extension indicator, a
-- 3 bits nature of address indicator and a 4 bits numbering
-- plan indicator, encoded as follows:

-- bit 8: 1 (no extension)

-- bits      765: nature of address indicator
--           000 unknown
--           001 international number
--           010 national significant number
--           011 network specific number
--           100 subscriber number
--           101 reserved
--           110 abbreviated number
--           111 reserved for extension

```



```

-- bits      4321: numbering plan indicator
--           0000      unknown
--           0001      ISDN/Telephony Numbering Plan (Rec ITU-T E.164)
--           0010      spare
--           0011      data numbering plan (ITU-T Rec X.121)
--           0100      telex numbering plan (ITU-T Rec F.69)
--           0101      spare
--           0110      land mobile numbering plan (ITU-T Rec E.212)
--           0111      spare
--           1000      national numbering plan
--           1001      private numbering plan
--           1111      reserved for extension

-- all other values are reserved.

-- b) The following octets representing digits of an address
--     encoded as a TBCD-STRING.

```

```
maxAddressLength  INTEGER ::= 20
```

```
LCS-QoS ::= SEQUENCE {
  horizontal-accuracy      [0] IMPLICIT Horizontal-Accuracy      OPTIONAL,
  verticalCoordinateRequest [1] IMPLICIT NULL                    OPTIONAL,
  vertical-accuracy        [2] IMPLICIT Vertical-Accuracy        OPTIONAL,
  responseTime              [3] IMPLICIT ResponseTime            OPTIONAL,
  extensionContainer        [4] IMPLICIT ExtensionContainer       OPTIONAL,
  velocityRequest          [5] IMPLICIT NULL                      OPTIONAL
}

```

```
Horizontal-Accuracy ::= OCTET STRING (SIZE (1))
-- bit 8 = 0
-- bits 7-1 = 7 bit Uncertainty Code defined in 3GPP TS 23.032. The horizontal location
-- error should be less than the error indicated by the uncertainty code with 67%
-- confidence.

```

```
Vertical-Accuracy ::= OCTET STRING (SIZE (1))
-- bit 8 = 0
-- bits 7-1 = 7 bit Vertical Uncertainty Code defined in 3GPP TS 23.032.
-- The vertical location error should be less than the error indicated
-- by the uncertainty code with 67% confidence.

```

```
ResponseTime ::= SEQUENCE {
  responseTimeCategory      ResponseTimeCategory
}
-- note: an expandable SEQUENCE simplifies later addition of a numeric response time.

```

```
ResponseTimeCategory ::= ENUMERATED {
  lowdelay (0),
  delaytolerant (1)
}
-- exception handling:
-- an unrecognized value shall be treated the same as value 1 (delaytolerant)

```

```
SupportedGADShapes ::= BIT STRING {
  ellipsoidPoint (0),
  ellipsoidPointWithUncertaintyCircle (1),
  ellipsoidPointWithUncertaintyEllipse (2),
  polygon (3),
  ellipsoidPointWithAltitude (4),
  ellipsoidPointWithAltitudeAndUncertaintyEllipsoid (5),
  ellipsoidArc (6) } (SIZE (7..16))
-- A node shall mark in the BIT STRING all Shapes defined in 3GPP TS 23.032 it supports.
-- exception handling: bits 7 to 15 shall be ignored if received.

```

```
Ext-GeographicalInformation ::= OCTET STRING (SIZE (1..maxExt-GeographicalInformation))
-- Refers to geographical Information defined in 3GPP TS 23.032.
-- This is composed of 1 or more octets with an internal structure according to
-- 3GPP TS 23.032
-- Octet 1: Type of shape, only the following shapes in 3GPP TS 23.032 are allowed:
-- (a) Ellipsoid point with uncertainty circle
-- (b) Ellipsoid point with uncertainty ellipse
-- (c) Ellipsoid point with altitude and uncertainty ellipsoid
-- (d) Ellipsoid Arc
-- (e) Ellipsoid Point
-- Any other value in octet 1 shall be treated as invalid
-- Octets 2 to 8 for case (a) Ellipsoid point with uncertainty circle
-- Degrees of Latitude      3 octets

```

```

-- Degrees of Longitude 3 octets
-- Uncertainty code 1 octet
-- Octets 2 to 11 for case (b) Ellipsoid point with uncertainty ellipse:
-- Degrees of Latitude 3 octets
-- Degrees of Longitude 3 octets
-- Uncertainty semi-major axis 1 octet
-- Uncertainty semi-minor axis 1 octet
-- Angle of major axis 1 octet
-- Confidence 1 octet
-- Octets 2 to 14 for case (c) Ellipsoid point with altitude and uncertainty ellipsoid
-- Degrees of Latitude 3 octets
-- Degrees of Longitude 3 octets
-- Altitude 2 octets
-- Uncertainty semi-major axis 1 octet
-- Uncertainty semi-minor axis 1 octet
-- Angle of major axis 1 octet
-- Uncertainty altitude 1 octet
-- Confidence 1 octet
-- Octets 2 to 13 for case (d) Ellipsoid Arc
-- Degrees of Latitude 3 octets
-- Degrees of Longitude 3 octets
-- Inner radius 2 octets
-- Uncertainty radius 1 octet
-- Offset angle 1 octet
-- Included angle 1 octet
-- Confidence 1 octet
-- Octets 2 to 7 for case (e) Ellipsoid Point
-- Degrees of Latitude 3 octets
-- Degrees of Longitude 3 octets

--
-- An Ext-GeographicalInformation parameter comprising more than one octet and
-- containing any other shape or an incorrect number of octets or coding according
-- to 3GPP TS 23.032 shall be treated as invalid data by a receiver.
--
-- An Ext-GeographicalInformation parameter comprising one octet shall be discarded
-- by the receiver if an Add-GeographicalInformation parameter is received
-- in the same message.
--
-- An Ext-GeographicalInformation parameter comprising one octet shall be treated as
-- invalid data by the receiver if an Add-GeographicalInformation parameter is not
-- received in the same message.

maxExt-GeographicalInformation INTEGER ::= 20
-- the maximum length allows for further shapes in 3GPP TS 23.032 to be included in later
-- versions of 3GPP TS 29.002

Add-GeographicalInformation ::= OCTET STRING (SIZE (1..maxAdd-GeographicalInformation))
-- Refers to geographical Information defined in 3GPP TS 23.032.
-- This is composed of 1 or more octets with an internal structure according to
-- 3GPP TS 23.032
-- Octet 1: Type of shape, all the shapes defined in 3GPP TS 23.032 are allowed:
-- Octets 2 to n (where n is the total number of octets necessary to encode the shape
-- according to 3GPP TS 23.032) are used to encode the shape itself in accordance with the
-- encoding defined in 3GPP TS 23.032
--
-- An Add-GeographicalInformation parameter, whether valid or invalid, received
-- together with a valid Ext-GeographicalInformation parameter in the same message
-- shall be discarded.
--
-- An Add-GeographicalInformation parameter containing any shape not defined in
-- 3GPP TS 23.032 or an incorrect number of octets or coding according to
-- 3GPP TS 23.032 shall be treated as invalid data by a receiver if not received
-- together with a valid Ext-GeographicalInformation parameter in the same message.

maxAdd-GeographicalInformation INTEGER ::= 91
-- the maximum length allows support for all the shapes currently defined in 3GPP TS 23.032

AgeOfLocationInformation ::= INTEGER (0..32767)
-- the value represents the elapsed time in minutes since the last
-- network contact of the mobile station (i.e. the actuality of the
-- location information).
-- value "0" indicates that the MS is currently in contact with the network
-- "32767" indicates that the location information is at least 32767 minutes old

GSN-Address ::= OCTET STRING (SIZE (5..17))
-- Octets are coded according to TS 3GPP TS 23.003

```

```

LCS-ReferenceNumber ::= OCTET STRING (SIZE(1))

PeriodicLDRInfo ::= SEQUENCE {
    reportingAmount      ReportingAmount-AGPS,
    reportingInterval    ReportingInterval-AGPS
}
-- reportingInterval x reportingAmount shall not exceed 8639999 (99 days, 23 hours,
-- 59 minutes and 59 seconds) for compatibility with OMA MLP and RLP

ReportingAmount-AGPS ::= INTEGER (1..maxReportingAmount)

maxReportingAmount INTEGER ::= 8639999

ReportingInterval-AGPS ::= INTEGER (1..maxReportingInterval)
-- ReportingInterval is in seconds

maxReportingInterval INTEGER ::= 8639999

VelocityEstimate-AGPS ::= OCTET STRING (SIZE (4..7))
-- Refers to Velocity description defined in 3GPP TS 23.032.
-- This is composed of 4 or more octets with an internal structure according to
-- 3GPP TS 23.032
-- Octet 1: Type of velocity, only the following types in 3GPP TS 23.032 are allowed:
-- (a) Horizontal Velocity
-- (b) Horizontal with Vertical Velocity
-- (c) Horizontal Velocity with Uncertainty
-- (d) Horizontal with Vertical Velocity and Uncertainty
-- For types Horizontal with Vertical Velocity and Horizontal with Vertical Velocity
-- and Uncertainty, the direction of the Vertical Speed is also included in Octet 1
-- Any other value in octet 1 shall be treated as invalid
-- Octets 2 to 4 for case (a) Horizontal velocity:
-- Bearing                1 octet
-- Horizontal Speed        2 octets
-- Octets 2 to 5 for case (b) - Horizontal with Vertical Velocity:
-- Bearing                1 octet
-- Horizontal Speed        2 octets
-- Vertical Speed          1 octet
-- Octets 2 to 5 for case (c) - Horizontal velocity with Uncertainty:
-- Bearing                1 octet
-- Horizontal Speed        2 octets
-- Uncertainty Speed       1 octet
-- Octets 2 to 7 for case (d) - Horizontal with Vertical Velocity and Uncertainty:
-- Bearing                1 octet
-- Horizontal Speed        2 octets
-- Vertical Speed          1 octet
-- Horizontal Uncertainty Speed 1 octet
-- Vertical Uncertainty Speed 1 octet

SequenceNumber ::= INTEGER (1..maxReportingAmount)

ReportingPLMNList ::= SEQUENCE {
    plmn-ListPrioritized [0] NULL OPTIONAL,
    plmn-List             [1] PLMNList
}

PLMNList ::= SEQUENCE SIZE (1..maxNumOfReportingPLMN) OF
    ReportingPLMN

maxNumOfReportingPLMN INTEGER ::= 20

ReportingPLMN ::= SEQUENCE {
    plmn-Id [0] PLMN-Id,
    ran-Technology [1] RAN-Technology OPTIONAL,
    ran-PeriodicLocationSupport [2] NULL OPTIONAL
}

RAN-Technology ::= ENUMERATED {
    gsm (0),
    umts (1)
}

PLMN-Id ::= OCTET STRING (SIZE (3))
-- The internal structure is defined as follows:
-- octet 1 bits 4321 Mobile Country Code 1st digit
-- bits 8765 Mobile Country Code 2nd digit
-- octet 2 bits 4321 Mobile Country Code 3rd digit
-- bits 8765 Mobile Network Code 3rd digit
-- or filler (1111) for 2 digit MNCs
-- octet 3 bits 4321 Mobile Network Code 1st digit

```

```

--          bits 8765      Mobile Network Code 2nd digit
--*****
-- Derived from ITU-T Rec. Q.773 (June/1997)
--*****
Component ::= CHOICE {
    invoke                [1] IMPLICIT Invoke,
    returnResultLast     [2] IMPLICIT ReturnResult,
    returnError          [3] IMPLICIT ReturnError,
    reject               [4] IMPLICIT Reject
}
-- The used part of Q.773 is almost the same as the component portion of TC messages. The only
-- difference is that returnResultNotLast is not used. (see 24.080, clause 3.6.1)

Invoke ::= SEQUENCE {
    invokeID              InvokeIdType,
    linkedID              [0] IMPLICIT InvokeIdType OPTIONAL,
    operationCode         Code,
                        -- local:116 for lcsNotification
                        -- local:115 for lcs-MOLR

    parameter             InvokeArgument OPTIONAL
}

ReturnResult ::= SEQUENCE {
    invokeID              InvokeIdType,
    result                SEQUENCE {
        operationCode     Code,
                        -- local:116 for lcsNotification
                        -- local:115 for lcs-MOLR

        parameter         ReturnRes
                        } OPTIONAL
}

ReturnError ::= SEQUENCE {
    invokeID              InvokeIdType,
    errorCode             Code,
                        -- local:34 for SystemFailure
                        -- local:36 for UnexpectedDataValue
                        -- local:35 for DataMissing
                        -- local:21 for FacilityNotSupported
                        -- local:19 for SS-SubscriptionViolation
                        -- local:54 for PositionMethodFailure

    parameter             ReturnErrPara OPTIONAL
}

Reject ::= SEQUENCE {
    invokeID CHOICE {
        derivable          InvokeIdType,
        not-derivable      NULL },
    problem CHOICE {
        generalProblem     [0] IMPLICIT GeneralProblem,
        invokeProblem      [1] IMPLICIT InvokeProblem,
        returnResultProblem [2] IMPLICIT ReturnResultProblem,
        returnErrorProblem [3] IMPLICIT ReturnErrorProblem }
}

InvokeIdType ::= INTEGER (-128..127)

GeneralProblem ::= INTEGER {
    unrecognizedComponent (0),
    mistypedComponent (1),
    badlyStructuredComponent (2) }

InvokeProblem ::= INTEGER {duplicateInvokeID (0),
    unrecognizedOperation (1),
    mistypedParameter (2),
    resourceLimitation (3),
    initiatingRelease (4),
    unrecognizedLinkedID (5),
    linkedResponseUnexpected (6),
    unexpectedLinkedOperation (7) }

ReturnResultProblem ::= INTEGER {unrecognizedInvokeID (0),

```

```

returnResultUnexpected (1),
mistypedParameter (2) }

```

```

ReturnErrorProblem ::= INTEGER { unrecognizedInvokeID (0),
returnErrorUnexpected (1),
unrecognizedError (2),
unexpectedError (3),
mistypedParameter (4) }

```

```

--*****
--Derived from SS-DataTypes in 3GPP TS 24.080 ver.800
--*****

```

```

Components ::= SET OF Component

```

```

InvokeArgument ::= CHOICE {
lcsNotification [0] EXPLICIT LocationNotificationArg,
lcs-MOLR [1] EXPLICIT LCS-MOLRArg
}

```

```

ReturnRes ::= CHOICE {
lcsNotificationRes [0] EXPLICIT LocationNotificationRes,
lcsMOLRRes [1] EXPLICIT LCS-MOLRRes
}

```

```

ReturnErrPara ::= CHOICE {
lcsNotificationErrPara [0] EXPLICIT LcsNotificationErrPara,
lcs-MOLR-ResErrPara [1] EXPLICIT Lcs-MOLR-ErrPara
}

```

```

LocationNotificationArg ::= SEQUENCE {
notificationType [0] IMPLICIT NotificationToMSUser,
locationType [1] IMPLICIT LocationType,
lcsClientExternalID [2] IMPLICIT LCSClientExternalID OPTIONAL,
lcsClientName [3] IMPLICIT LCSClientName OPTIONAL,

lcsRequestorID [4] IMPLICIT LCSRequestorID OPTIONAL,
lcsCodeword [5] IMPLICIT LCSCodeword OPTIONAL,
lcsServiceTypeID [6] IMPLICIT LCSServiceTypeID OPTIONAL
}

```

```

-- The notificationType may only be set to notifyLocationAllowed,
-- notifyAndVerify-LocationAllowedIfNoResponse,
-- or notifyAndVerify-LocationNotAllowedIfNoResponse.
-- The locationEstimateType field of the locationType may only be set to
-- currentLocation, currentOrLastKnownLocation,
-- notificationVerificationOnly, or activateDeferredLocation.
-- The deferredLocationEventType field of the locationType may only be set to
-- enteringIntoArea, and/or leavingFromArea, and/or beingInsideArea,
-- and/or periodicLDR.
-- For LCS location notification of MT-LR for current location, the
-- locationEstimateType field of the locationType shall be set to currentLocation.
-- For LCS location notification of MT-LR for current or last known location, the
-- locationEstimateType field of the locationType shall be set to currentOrLastKnownLocation.
-- For the LCS location notification for the LDR of MS available event,
-- the locationEstimateType field of the locationType shall be set to currentLocation.
-- For LCS location notification for the LDR of change of area event,
-- the locationEstimateType field of the locationType shall be set to
-- activateDeferredLocation, and the deferredLocationEventType shall be
-- set to enteringIntoArea, and/or leavingFromArea, and/or beingInsideArea.
-- For the post positioning LCS location notification, the locationEstimateType
-- field of the locationType shall be set to notificationVerificationOnly.
-- For LCS location notification for the LDR of periodic location event,
-- the locationEstimateType field of the locationType shall be set to
-- activateDeferredLocation, and the
-- deferredLocationEventType shall be set to periodicLDR.

```

```

-- exception handling:
-- At reception of an unrecognised notificationType value the receiver shall reject the
-- operation with a return error cause of unexpected data value.
-- At reception of an unrecognised locationType value the receiver shall reject the
-- operation with a return error cause of unexpected data value.
-- At reception of an unallowed notificationType value the receiver shall either ignore the
-- received operation or reject the operation with a return error cause of unexpected
-- data value.
-- At reception of an unallowed locationType value the receiver shall either ignore the
-- received operation or reject the operation with a return error cause of unexpected
-- data value.

LocationNotificationRes ::= SEQUENCE {
    verificationResponse [0] IMPLICIT VerificationResponse OPTIONAL,
}

VerificationResponse ::= ENUMERATED {
    permissionDenied (0),
    permissionGranted (1)
}
-- exception handling:
-- an unrecognized value shall be treated the same as value 0 (permissionDenied)

LcsNotificationErrPara ::= CHOICE {
    systemFailure [0] EXPLICIT SystemFailureParam,
    unexpectedDataValue [1] EXPLICIT UnexpectedDataParam
}
-- This is derived from information object "lcs-LocationNotification"

LCS-MOLRArg ::= SEQUENCE {
    molr-Type [0] IMPLICIT MOLR-Type,
    locationMethod [1] IMPLICIT LocationMethod OPTIONAL,
    lcs-QoS [2] IMPLICIT LCS-QoS OPTIONAL,
    lcsClientExternalID [3] IMPLICIT LCSClientExternalID OPTIONAL,
    mlc-Number [4] IMPLICIT ISDN-AddressString OPTIONAL,
    gpsAssistanceData [5] IMPLICIT GPSAssistanceData OPTIONAL,

    supportedGADShapes [6] IMPLICIT SupportedGADShapes OPTIONAL,
    lcsServiceTypeID [7] IMPLICIT LCSServiceTypeID OPTIONAL,
    ageOfLocationInfo [8] IMPLICIT AgeOfLocationInformation OPTIONAL,
    locationType [9] IMPLICIT LocationType OPTIONAL,
    pseudonymIndicator [10] IMPLICIT NULL OPTIONAL,
    h-gmlc-address [11] IMPLICIT GSN-Address OPTIONAL,
    locationEstimate [12] IMPLICIT Ext-GeographicalInformation OPTIONAL,
    velocityEstimate [13] IMPLICIT VelocityEstimate-AGPS OPTIONAL,
    referenceNumber [14] IMPLICIT LCS-ReferenceNumber OPTIONAL,
    periodicLDRInfo [15] IMPLICIT PeriodicLDRInfo OPTIONAL,
    locationUpdateRequest [16] IMPLICIT NULL OPTIONAL,
    sequenceNumber [17] IMPLICIT SequenceNumber OPTIONAL,
    terminationCause [18] IMPLICIT TerminationCause OPTIONAL,
    mo-lrShortCircuit [19] IMPLICIT NULL OPTIONAL,
    ganssAssistanceData [20] IMPLICIT GANSSAssistanceData OPTIONAL,
    multiplePositioningProtocolPDUs [21] MultiplePositioningProtocolPDUs OPTIONAL
}
-- The parameter locationMethod shall be included if and only if the
-- molr-Type is set to value deCipheringKeys or assistanceData.
-- The parameter gpsAssistanceData shall be included if and only if the
-- molr-Type is set to value assistanceData and
-- locationMethod is set to value assistedGPS or assistedGPSandGANSS.
-- The parameter ganssAssistanceData shall be included if and only if the molr-Type is set to
value
-- assistanceData and locationMethod is set to value assistedGANSS or assistedGPSandGANSS.
-- supportedGADShapes shall not be included for deferred MO-LR initiation or deferred MO-LR or
MT-LR
-- responses.
-- multiplePositioningProtocolPDUs may only be included for E-UTRAN access.
-- locationMethod shall not be included for E-UTRAN access.
-- gpsAssistanceData shall not be included for E-UTRAN access.
-- h-gmlc-address shall not be included for E-UTRAN access.
-- locationEstimate shall not be included for E-UTRAN access.
-- velocityEstimate shall not be included for E-UTRAN access.
-- referenceNumber shall not be included for E-UTRAN access.
-- periodicLDRInfo shall not be included for E-UTRAN access.
-- locationUpdateRequest shall not be included for E-UTRAN access.
-- sequenceNumber shall not be included for E-UTRAN access.
-- terminationCause shall not be included for E-UTRAN access.

```

```
-- mo-lrShortCircuit shall not be included for E-UTRAN access.
-- ganssAssistanceData shall not be included for E-UTRAN access.
```

```
MOLR-Type ::= ENUMERATED {
  locationEstimate (0),
  assistanceData (1),
  deCipherringKeys (2),

  deferredMo-lrTTTTInitiation (3),
  deferredMo-lrSelfLocationInitiation (4),
  deferredMt-lrOrmo-lrTTTTLocationEstimate (5),
  deferredMt-lrOrmo-lrCancellation (6)
}
-- exception handling:
-- an unrecognized value shall be rejected by the receiver with a return error cause of
-- unexpected data value.
```

```
LocationMethod ::= ENUMERATED {
  msBasedEOTD (0),
  msAssistedEOTD (1),
  assistedGPS (2),

  msBasedOTDOA (3),
  assistedGANSS (4),
  assistedGPSandGANSS (5)
}
-- exception handling:
-- When this parameter is received with value msBasedEOTD or msAssistedEOTD and the MS
-- is camped on an UMTS Service Area then the receiver shall reject it
-- with a return error cause of unexpected data value.
-- When this parameter is received with value msBasedOTDOA and the MS
-- is camped on a GSM Cell then the receiver shall reject it with
-- a return error cause of unexpected data value.
-- an unrecognized value shall be rejected by the receiver with
-- a return error cause of unexpected data value.
```

```
GPSAssistanceData ::= OCTET STRING (SIZE (1..38))
-- Octets 1 to 38 are coded in the same way as the octets 3 to 7+2n
-- of Requested GPS Data IE in 3GPP TS 49.031.
```

```
GANSSAssistanceData ::= OCTET STRING (SIZE (1..40))
-- Octets 1 to 40 are coded in the same way as the octets 3 to 9+2n of Requested GANSS Data IE
-- in 3GPP TS 49.031 [14] .
```

```
TerminationCause ::= ENUMERATED {
  subscriberTermination (0),
  uETermination (1)
}
```

```
MultiplePositioningProtocolPDUs ::= SEQUENCE (SIZE (1..maxNumLPPMsg)) OF PositioningProtocolPDU
```

```
PositioningProtocolPDU ::= OCTET STRING
-- PositioningProtocolPDU contains a LPP message defined in 3GPP TS 36.355 [17].
```

```
maxNumLPPMsg INTEGER ::= 3
```

```
LCS-MOLRRes ::= SEQUENCE {
  locationEstimate [0] IMPLICIT Ext-GeographicalInformation OPTIONAL,
  decipherringKeys [1] IMPLICIT DecipherringKeys OPTIONAL,

  add-LocationEstimate [2] IMPLICIT Add-GeographicalInformation OPTIONAL,
  velocityEstimate [3] IMPLICIT VelocityEstimate-AGPS OPTIONAL,
  referenceNumber [4] IMPLICIT LCS-ReferenceNumber OPTIONAL,
  h-gmlc-address [5] IMPLICIT GSN-Address OPTIONAL,
  mo-lrShortCircuit [6] IMPLICIT NULL OPTIONAL,
  reportingPLMNList [7] IMPLICIT ReportingPLMNList OPTIONAL
}
```

```
-- Parameters locationEstimate or add-LocationEstimate (one but not both)
-- shall be included if and only if the
-- molr-Type in LocationRequestArg was set to value locationEstimate.
-- Parameter add-LocationEstimate shall not be included
-- if the supportedGADShapes parameter was not received in the LCS-MOLRArg.
-- The locationEstimate and the add-locationEstimate parameters shall not be
-- sent if the supportedGADShapes parameter has been received in LCS-MOLRArg
-- and the shape encoded in locationEstimate or add-LocationEstimate
-- is not marked as supported in supportedGADShapes.
-- In such a case LCS-MOLRArg shall be rejected with error
```

```

-- FacilityNotSupported with additional indication
-- shapeOfLocationEstimateNotSupported.
-- Parameter decipheringKeys shall be included if and only if the molr-Type
-- in LocationRequestArg was set to value deCipheringKeys.
-- Parameter velocityEstimate may only be included if the lcs-QoS in LCS-MOLRarg includes
-- velocityRequest

```

```

DecipheringKeys ::= OCTET STRING (SIZE (15))
-- Octets in DecipheringKeys are coded in the same way as the octets 3 to 17
-- of Deciphering Key IE in 3GPP TS 49.031. I.e. these octets contain
-- Current Deciphering Key, Next Deciphering Key and Ciphering Key Flag.

```

```

Lcs-MOLR-ErrPara ::= CHOICE {
  systemFailure           [0] EXPLICIT   SystemFailureParam,
  unexpectedDataValue     [1] EXPLICIT   UnexpectedDataParam,
  dataMissing             [2] EXPLICIT   DataMissingParam,
  facilityNotSupported    [3] EXPLICIT   FacilityNotSupParam,
  ss-SubscriptionViolation [4] EXPLICIT   SS-SubscriptionViolationParam,
  positionMethodFailure   [5] EXPLICIT   PositionMethodFailure-Param,
}
-- This is derived from information object "lcs-MOLR"

```

```

-----
-- Derived from MAP-Errors 3GPP 29.002
-----

```

```

SystemFailureParam ::= CHOICE {
  networkResource           NetworkResource,
  -- networkResource must not be used in version 3
  extensibleSystemFailureParam ExtensibleSystemFailureParam
  -- extensibleSystemFailureParam must not be used in version <3
}

```

```

NetworkResource ::= ENUMERATED {
  plmn (0),
  hlr (1),
  vlr (2),
  pvlr (3),
  controllingMSC (4),
  vmsc (5),
  eir (6),
  rss (7)
}

```

```

ExtensibleSystemFailureParam ::= SEQUENCE {
  networkResource           NetworkResource OPTIONAL,
  extensionContainer        ExtensionContainer OPTIONAL,
  additionalNetworkResource [0] AdditionalNetworkResource OPTIONAL,
  failureCauseParam        [1] FailureCauseParam OPTIONAL
}

```

```

AdditionalNetworkResource ::= ENUMERATED {
  sgsn (0),
  ggsn (1),
  gmlc (2),
  gsmSCF (3),
  nplr (4),
  auc (5),
  ue (6),
  mme (7)
}
-- if unknown value is received in AdditionalNetworkResource
-- it shall be ignored.

```

```

FailureCauseParam ::= ENUMERATED {
  limitReachedOnNumberOfConcurrentLocationRequests (0) }
-- if unknown value is received in FailureCauseParam it shall be ignored

```

```

UnexpectedDataParam ::= SEQUENCE {
  extensionContainer        ExtensionContainer OPTIONAL
}

```

```

DataMissingParam ::= SEQUENCE {
  extensionContainer        ExtensionContainer OPTIONAL
}

```

```

FacilityNotSupParam ::= SEQUENCE {

```



```

extensionContainer                               ExtensionContainer OPTIONAL,

shapeOfLocationEstimateNotSupported             [0] IMPLICIT NULL    OPTIONAL,
neededLcsCapabilityNotSupportedInServingNode    [1] IMPLICIT NULL    OPTIONAL
}

SS-SubscriptionViolationParam ::= SEQUENCE {
    extensionContainer      ExtensionContainer OPTIONAL
}

PositionMethodFailure-Param ::= SEQUENCE {
    positionMethodFailure-Diagnostic [0] IMPLICIT PositionMethodFailure-Diagnostic OPTIONAL,
    extensionContainer             [1] IMPLICIT ExtensionContainer          OPTIONAL,
}

PositionMethodFailure-Diagnostic ::= ENUMERATED {
    congestion (0),
    insufficientResources (1),
    insufficientMeasurementData (2),
    inconsistentMeasurementData (3),
    locationProcedureNotCompleted (4),
    locationProcedureNotSupportedByTargetMS (5),
    qosNotAttainable (6),
    positionMethodNotAvailableInNetwork (7),
    positionMethodNotAvailableInLocationArea (8),
}
-- exception handling:
-- any unrecognized value shall be ignored

ExtensionContainer ::= SEQUENCE {
    privateExtensionList [0] IMPLICIT PrivateExtensionList OPTIONAL,
    pcs-Extensions       [1] IMPLICIT PCS-Extensions      OPTIONAL,
}

PrivateExtensionList ::= SEQUENCE SIZE (1..maxNumOfPrivateExtensions) OF
    PrivateExtension

PrivateExtension ::= SEQUENCE {
    extId      OBJECT IDENTIFIER,
    extType    OCTET STRING    OPTIONAL}

maxNumOfPrivateExtensions INTEGER ::= 10

PCS-Extensions ::= SEQUENCE {...}

END

```

Annex I (informative): Guidance on test execution

This clause provides the guidance on test execution of the different ATSSs.

I.1 Void

I.2 FDD test execution on different frequency bands

I.2.1 FDD Band VI, XIII, IX, XIV

A test case requires more than two radio frequencies shall avoid to execute on FDD Band VI, XIII and XIV. A list is given below.

6.1.1.4, 6.1.1.5, 6.1.1.7, 6.1.1.8, 6.1.1.9, 6.1.1.10, 6.1.1.11, 6.1.1.12, 6.1.1.13, 6.1.1.15, 6.1.2.3, 6.1.2.4, 6.1.2.6, 6.1.2.8, 6.1.2.11, 8.2.6.38, 8.3.1.21, 8.3.2.11, 8.4.1.42, 9.4.2.5, 9.4.5.4.1, 9.4.5.4.6, 9.4.8, 12.4.1.4b, 12.4.2.4.

For interBand test case execution on Band VI and IX, the Mobile Country Code of the two cells is set to the same value according to TS 34.108 clause 5.1.1.6 and 5.1.1.9. The used test USIM follows TS 34.108 clause 8.3.2.2. This is applied to the test cases:

6.1.2.1a, 6.1.2.10a, 8.1.2.10a, 8.2.1.24a, 8.2.1.34a, 8.2.6.37b, 8.3.1.1a, 8.3.2.1a, 8.4.1.2B, 8.4.1.24A, 8.4.1.25A.

I.2.2 FDD Band XII, XIX, XX, XXI

A test case requires more than three radio frequencies shall avoid to execute on FDD Band XII. A list is given below.

6.1.1.4, 6.1.1.8, 6.1.1.9, 6.1.1.10, 6.1.1.12, 6.1.1.13, 6.1.1.15, 9.4.5.4.1.

I.3 Void

I.4 InterRAT test execution

The test purpose and the test method of the test case 8.3.7.1, 8.3.7.1a and 8.3.7.1b are same. The test cases differ from each other in the ciphering algorithms applied in the UTRAN and GERAN cell. The necessary test coverage is achieved by executing once according to the following:

8.3.7.1b for UE in Rel-7 or later,

8.3.7.1a for UE in Rel-6, (for earlier UE if A5/3 is supported),

8.3.7.1 for UE in R99, Rel-4 or Rel-5.

The test purpose and the test method of the test case 8.3.11.1, 8.3.11.1a and 8.3.11.1b are same. The test cases differ from each other in the ciphering algorithms applied in the UTRAN and GPRS cell. The necessary test coverage is achieved by executing once according to the following:

8.3.11.1a and 8.3.11.1b: for UE in Rel-7 or later,

8.3.11.1 for UE in R99, Rel-4, Rel-5 or Rel-6

Annex J (informative): Change history

Meeting	TSG doc	CR	Rev	Subject	Cat	Old vers	New vers	WG doc
TP-18	TP-020301			Approval of the specification		2.0.0	3.0.0	
TP-24	-	-	-	One correction performed in the NAS ATS part (the other ATS parts remain in v.3.6.0)		3.6.0	3.6.1	-
TP-20	-	-	-	Regeneration of RRC and RLC ATS		3.2.0	3.2.1	-
TP-21	TP-030199	-	-	Add new approved TTCN test cases in test case list in Annex A	F	3.2.1	3.3.0	-
TP-23	TP-040044	-	-	Updating Annex A	F	3.4.0	3.5.0	-
TP-23	-	-	-	Editorial clean-up by ETSI		3.5.0	3.5.1	-
TP-23	-	-	-	Sections 8.3.28 - 8.3.31 were misplaced		3.5.1	3.5.2	-
TP-19	TP-030051	001	-	Change to test case 9.2.3 required for approval	F	3.0.0	3.1.0	T1-030120
TP-19	TP-030051	002	-	Change to test case 9.2.4 required for approval	F	3.0.0	3.1.0	T1-030121
TP-19	TP-030051	003	-	Change to test case 10.1.3.4.1 required for approval	F	3.0.0	3.1.0	T1-030122
TP-19	TP-030051	004	-	Inclusion of RLC test case 7.2.2.3 to RLC ATS V3.0.0	F	3.0.0	3.1.0	T1-030123
TP-19	TP-030051	005	-	Inclusion of RLC test case 7.2.2.4 to RLC ATS V3.0.0	F	3.0.0	3.1.0	T1-030124
TP-19	TP-030051	006	-	Inclusion of RLC test case 7.2.2.7 to RLC ATS V3.0.0	F	3.0.0	3.1.0	T1-030125
TP-19	TP-030051	007	-	Inclusion of RLC test case 7.2.3.4 to RLC ATS V3.0.0	F	3.0.0	3.1.0	T1-030126
TP-19	TP-030051	008	-	Inclusion of RLC test case 7.2.3.5 to RLC ATS V3.0.0	F	3.0.0	3.1.0	T1-030127
TP-19	TP-030051	009	-	Changes to TS34.123-3 V200 to introduce TC_8_1_1_4	F	3.0.0	3.1.0	T1-030128
TP-19	TP-030051	010	-	TTCN changes to the approved test cases in V300	F	3.0.0	3.1.0	T1-030129
TP-19	TP-030051	011	1	CR 34.123-3, V300 as T1S030009rev1	F	3.0.0	3.1.0	T1-030260
TP-19	TP-030051	012	-	Introducing Test Case 8.1.2.7	F	3.0.0	3.1.0	T1-030245
TP-19	TP-030051	013	-	Introduction of Test Case 8.2.1.1	F	3.0.0	3.1.0	T1-030246
TP-19	TP-030051	014	-	Introduction of Test Case 8.2.3.1	F	3.0.0	3.1.0	T1-030247
TP-19	TP-030051	015	-	Addition of RRC test case 8.1.9 to RRC ATS V3.0.0 NOTE: There was a missing TTCN fix in TP-030051. In the TTCN line 6 of TC_8_1_2_1, replace +ts_SendDefSysInfo(tsc_CellA) with +ts_SendSysInfoWithSpecialSIB11(tsc_CellA, tcv_SIB11IntraFreqRepQuantiyRACH). Otherwise, a good UE would be failed at the regression test.	F	3.0.0	3.1.0	T1-030248
TP-20	TP-030104	016	-	Test Case 7.1.1.2	F	3.1.0	3.2.0	T1-030397
TP-20	TP-030104	017	-	Test Case 7.1.1.8	F	3.1.0	3.2.0	T1-030399
TP-20	TP-030104	018	-	Test Case 8.1.1.2	F	3.1.0	3.2.0	T1-030401
TP-20	TP-030104	019	-	Test Case 8.1.1.3	F	3.1.0	3.2.0	T1-030403
TP-20	TP-030104	020	-	Test Case 8.1.1.8	F	3.1.0	3.2.0	T1-030411
TP-20	TP-030104	021	-	Test Case 8.2.1.8	F	3.1.0	3.2.0	T1-030413
TP-20	TP-030104	022	-	Test Case 8.2.1.10	F	3.1.0	3.2.0	T1-030415
TP-20	TP-030104	023	-	Test Case 8.1.5.1	F	3.1.0	3.2.0	T1-030425
TP-20	TP-030104	024	-	Test Case 8.1.5.4	F	3.1.0	3.2.0	T1-030427
TP-20	TP-030104	025	-	Test Case 8.2.3.7	F	3.1.0	3.2.0	T1-030429
TP-20	TP-030104	026	-	Addition of RLC test case 7.2.3.6 to RLC ATS V3.1.0	B	3.1.0	3.2.0	T1-030438
TP-20	TP-030104	027	-	Addition of RLC test case 7.2.3.25 to RLC ATS V3.1.0	B	3.1.0	3.2.0	T1-030440
TP-20	TP-030104	028	-	Addition of RLC test case 7.2.3.14 to RLC ATS V3.1.0	B	3.1.0	3.2.0	T1-030442
TP-20	TP-030104	029	-	Addition of RLC test case 7.2.3.15 to RLC ATS V3.1.0	B	3.1.0	3.2.0	T1-030444
TP-20	TP-030104	030	-	Addition of RLC test case 7.2.3.16 to RLC ATS V3.1.0	B	3.1.0	3.2.0	T1-030446
TP-20	TP-030104	031	-	Addition of RLC test case 7.2.3.33 to RLC ATS V3.1.0	B	3.1.0	3.2.0	T1-030448
TP-20	TP-030104	032	-	Addition of NAS test case 10.1.2.5.1 to NAS ATS V3.1.0	B	3.1.0	3.2.0	T1-030450
TP-20	TP-030104	033	-	7.1.1.1	B	3.1.0	3.2.0	T1-030452
TP-20	TP-030104	034	-	7.1.1.3	B	3.1.0	3.2.0	T1-030454
TP-20	TP-030104	035	-	7.1.1.4	B	3.1.0	3.2.0	T1-030456
TP-20	TP-030104	036	-	Introduction of Test Case 7.1.1.5	B	3.1.0	3.2.0	T1-030458
TP-20	TP-030104	037	-	Test Case 8.2.3.15	F	3.1.0	3.2.0	T1-030464
TP-20	TP-030104	038	-	Test Case 8.2.3.18	F	3.1.0	3.2.0	T1-030466
TP-20	TP-030104	039	-	Test Case 8.2.3.19	F	3.1.0	3.2.0	T1-030468
TP-20	TP-030104	040	-	Test Case 12.3.1.2	F	3.1.0	3.2.0	T1-030474

Meet- ing	TSG doc	CR	Rev	Subject	Cat	Old vers	New vers	WG doc
TP-20	TP-030104	041	-	Test Case 8.3.3.1	F	3.1.0	3.2.0	T1-030479
TP-20	TP-030104	042	-	Addition of RLC test case 7.2.3.13 to RLC ATS V3.1.0	B	3.1.0	3.2.0	T1-030484
TP-20	TP-030104	043	-	Addition of RLC test case 7.2.3.18 to RLC ATS V3.1.0	B	3.1.0	3.2.0	T1-030486
TP-20	TP-030104	044	-	Addition of RLC test case 7.2.2.5 to RLC ATS V3.0.0	B	3.1.0	3.2.0	T1-030490
TP-20	TP-030104	045	-	Addition of RLC test case 7.2.2.6 to RLC ATS V3.0.0	B	3.1.0	3.2.0	T1-030492
TP-20	TP-030104	046	-	Addition of RLC test case 7.2.3.17 to RLC ATS V3.0.0	B	3.1.0	3.2.0	T1-030495
TP-20	TP-030104	047	-	Addition of RLC test case 7.2.3.20 to RLC ATS V3.0.0	B	3.1.0	3.2.0	T1-030496
TP-20	TP-030104	048	-	Addition of RLC test case 7.2.3.34 to RLC ATS V3.0.0	B	3.1.0	3.2.0	T1-030498
TP-20	TP-030104	049	-	Addition of SM test case 11.1.1.1 to NAS ATS V3.1.0	B	3.1.0	3.2.0	T1-030500
TP-20	TP-030104	050	-	Addition of RLC test case 7.2.3.23 to RLC ATS V3.1.0	B	3.1.0	3.2.0	T1-030535
TP-20	TP-030104	051	-	Addition of RLC test case 7.2.3.24 to RLC ATS V3.1.0	B	3.1.0	3.2.0	T1-030537
TP-20	TP-030104	052	-	Addition of RLC test case 7.2.3.26 to RLC ATS V3.1.0	B	3.1.0	3.2.0	T1-030539
TP-20	TP-030104	053	-	Addition of RLC test case 7.2.3.27 to RLC ATS V3.1.0	B	3.1.0	3.2.0	T1-030541
TP-20	TP-030104	054	-	Addition of SM test case 11.3.1 to NAS ATS V3.1.0	B	3.1.0	3.2.0	T1-030576
TP-20	TP-030104	055	-	Addition of SM test case 11.3.2 to NAS ATS V3.1.0	B	3.1.0	3.2.0	T1-030577
TP-20	TP-030104	056	-	Addition of GMM test case 12.3.1.5 to NAS ATS V3.1.0	B	3.1.0	3.2.0	T1-030578
TP-20	TP-030104	057	-	Addition of GMM test case 12.7 to NAS ATS V3.1.0	B	3.1.0	3.2.0	T1-030580
TP-20	TP-030104	058	-	Test Case 8.2.1.9	F	3.1.0	3.2.0	T1-030594
TP-20	TP-030104	059	-	Test Case 8.2.3.8	F	3.1.0	3.2.0	T1-030596
TP-20	TP-030104	060	-	Test Case 12.3.1.1	F	3.1.0	3.2.0	T1-030614
TP-20	TP-030104	062	-	Test Case 12.9.2	F	3.1.0	3.2.0	T1-030626
TP-20	TP-030104	063	-	Addition of GMM test case 12.3.2.1 to NAS ATS V3.1.0	B	3.1.0	3.2.0	T1-030638
TP-20	TP-030104	064	-	CR for correction of generic test step in RLC ATS V3.1.0	F	3.1.0	3.2.0	T1-030654
TP-20	TP-030104	065	-	ASP Enhancement	F	3.1.0	3.2.0	T1-030665
TP-20	TP-030104	066	-	Test Case 8.1.2.2	F	3.1.0	3.2.0	T1-030395
TP-20	TP-030104	067	-	Test Case 8.1.2.9	F	3.1.0	3.2.0	T1-030396
TP-20	TP-030110	068	-	Add new approved test cases in test case list in Annex A	F	3.1.0	3.2.0	--
TP-20	TP-030141	069	-	Test Case 8.1.3.3	F	3.1.0	3.2.0	T1-030460
TP-21	TP-030194	070	-	Corrections to Package 1 test cases in RRC ATS v3.2.1 for PS mode	F	3.2.1	3.3.0	T1-031054
TP-21	TP-030194	071	-	Corrections to Package 1 test cases in RRC ATS v3.2.1 for Integrity	F	3.2.1	3.3.0	T1-031055
TP-21	TP-030194	072	-	Corrections to Package 1 test cases in RRC ATS v3.2.1 for configuration of Radio Bearer -3	F	3.2.1	3.3.0	T1-031140
TP-21	TP-030194	073	-	CR to 34.123-3 R99, Moving baseline from March 02 to March 03 and error corrections	F	3.2.1	3.3.0	T1-031242
TP-21	TP-030194	074	-	CR to 34.123-3, R99, Update and remove unnecessary PIXIT parameters, so they are aligned with the 3GPP conformance TTCN	F	3.2.1	3.3.0	T1-031278
TP-21	TP-030194	079	-	Changes to TS34.123-3 V310 to introduce TC_8_1_1_5	F	3.1.0	3.3.0	T1-030405
TP-21	TP-030194	080	-	Changes to TS34.123-3 V310 to introduce TC_8_1_1_6	F	3.1.0	3.3.0	T1-030407
TP-21	TP-030194	084	-	Changes to TS34.123-3 V310 to introduce TC_12_2_1_1	F	3.1.0	3.3.0	T1-030423
TP-21	TP-030194	119	-	Changes to TS34.123-3 V310 to introduce TC_8_3_4_1	F	3.1.0	3.3.0	T1-030602
TP-21	TP-030194	120	-	Changes to TS34.123-3 V310 to introduce TC_8_3_4_2	F	3.1.0	3.3.0	T1-030604
TP-21	TP-030194	121	-	Changes to TS34.123-3 V310 to introduce TC_8_3_4_3	F	3.1.0	3.3.0	T1-030606
TP-21	TP-030194	122	-	Changes to TS34.123-3 V310 to introduce TC_8_4_1_1	F	3.1.0	3.3.0	T1-030608
TP-21	TP-030194	124	-	Changes to TS34.123-3 V310 to introduce TC_12_9_1	F	3.1.0	3.3.0	T1-030624
TP-21	TP-030194	127	-	CR to 34.123-3 V310 to introduce test case 7.2.3.19	B	3.1.0	3.3.0	T1-030657
TP-21	TP-030194	128	-	CR to 34.123-3 V320 to introduce test case 14.2.13.1	B	3.2.0	3.3.0	T1-030877
TP-21	TP-030194	129	-	CR to 34.123-3 V320 to introduce test case 7.2.2.2	B	3.2.0	3.3.0	T1-030879
TP-21	TP-030194	130	-	CR to 34.123-3 V320 to introduce test case 7.2.3.2	B	3.2.0	3.3.0	T1-030881

Meeting	TSG doc	CR	Rev	Subject	Cat	Old vers	New vers	WG doc
TP-21	TP-030194	131	-	Changes to TS34.123-3 V320 to introduce TC_8_2_3_9	B	3.2.0	3.3.0	T1-030896
TP-21	TP-030194	132	-	Changes to TS34.123-3 V320 to introduce TC_7_2_3_21	F	3.2.0	3.3.0	T1-030897
TP-21	TP-030194	133	-	Changes to TS34.123-3 V320 to introduce TC_7_2_3_22	F	3.2.0	3.3.0	T1-030898
TP-21	TP-030194	134	-	CR to 34.123-3 V320 to introduce test case TC_8_2_6_20	F	3.2.1	3.3.0	T1-030928
TP-21	TP-030194	135	-	CR to 34.123-3 V320 to introduce test case TC_9.2.1	B	3.2.1	3.3.0	T1-031016
TP-21	TP-030194	136	-	CR to 34.123-3 V320 to introduce test case TC_9.3.1	B	3.2.1	3.3.0	T1-031018
TP-21	TP-030194	137	-	CR to 34.123-3 V320 to introduce test case TC_9_4_5_2	B	3.2.1	3.3.0	T1-031020
TP-21	TP-030194	138	-	CR to 34.123-3 V320 to introduce test case TC_9.5.2	B	3.2.1	3.3.0	T1-031022
TP-21	TP-030194	139	-	Changes to TS34.123-3 V321 to introduce TC_8_1_1_7	F	3.2.1	3.3.0	T1-031141
TP-21	TP-030208	140	-	Addition of RRC test case 8.2.2.1 to 34.123-3	F	3.2.1	3.3.0	T1-031280
TP-21	TP-030208	141	-	Addition of RRC test case 8.2.2.11 to 34.123-3	F	3.2.1	3.3.0	T1-031281
TP-21	TP-030208	142	-	Addition of RRC test case 8.2.6.1 to 34.123-3	F	3.2.1	3.3.0	T1-031282
TP-22	TP-030284	142	2	ASP changes and MMI string corrections	F	3.3.0	3.4.0	T1-031707
TP-21	TP-030208	143	-	Addition of RRC test case 8.2.2.17 to 34.123-3	F	3.2.1	3.3.0	T1-031283
TP-21	TP-030208	144	-	Addition of RRC test case 8.2.4.10 to 34.123-3	F	3.2.1	3.3.0	T1-031284
TP-21	TP-030208	145	-	Addition of RRC test case 8.2.6.7 to 34.123-3	F	3.2.1	3.3.0	T1-031285
TP-21	TP-030208	146	-	Addition of RRC test case 8.2.2.8 to 34.123-3	F	3.2.1	3.3.0	T1-031286
TP-21	TP-030208	147	-	Addition of RRC test case 8.2.2.10 to 34.123-3	F	3.2.1	3.3.0	T1-031287
TP-21	TP-030208	148	-	Test case 12.5	F	3.2.1	3.3.0	T1-031288
TP-21	TP-030209	149	-	CR to 34.123-3 V321 to introduce test case TC_8_2_2_23	F	3.2.1	3.3.0	T1-031289
TP-23	TP-040042	151	-	GERAN ASP changes	F	3.4.0	3.5.0	T1-040412
TP-23	TP-040043	152		Addition of NAS test case 9.1 to NAS ATS V3.4.0	B	3.3.0	3.5.0	T1-031755
TP-23	TP-040043	153		Addition of NAS test case 9.2.2 to NAS ATS V3.4.0	B	3.3.0	3.5.0	T1-031757
TP-23	TP-040043	154		Addition of NAS test case 9.4.1 to NAS ATS V3.4.0	B	3.3.0	3.5.0	T1-031759
TP-23	TP-040043	155		Addition of NAS test case 9.4.2.1 to NAS ATS V3.4.0	B	3.3.0	3.5.0	T1-031761
TP-21	TP-030209	156	-	CR to 34.123-3 V321 to introduce test case TC_8_2_6_19	F	3.2.1	3.3.0	T1-031296
TP-23	TP-040043	156		Addition of NAS test case 9.4.2.4.1 to NAS ATS V3.4.0	B	3.3.0	3.5.0	T1-031763
TP-21	TP-030209	157	-	CR to 34.123-3 V321 to introduce test case TC_8_2_2_7	F	3.2.1	3.3.0	T1-031297
TP-23	TP-040043	157		Addition of NAS test case 9.4.4 to NAS ATS V3.4.0	B	3.3.0	3.5.0	T1-031765
TP-21	TP-030209	158	-	CR to 34.123-3 V321 to introduce test case TC_8_2_2_9	F	3.2.1	3.3.0	T1-031298
TP-23	TP-040043	158		Addition of NAS test case 9.4.5.3 to NAS ATS V3.4.0	B	3.3.0	3.5.0	T1-031767
TP-21	TP-030209	159	-	CR to 34.123-3 V321 to introduce test case TC_8_3_1_11	F	3.2.1	3.3.0	T1-031299
TP-23	TP-040043	159		Addition of RRC test case 8.3.7.1 to RRC ATS V3.4.0	B	3.3.0	3.5.0	T1-031771
TP-21	TP-030209	160	-	CR to 34.123-3 V321 to introduce test case TC_8_2_6_8	F	3.2.1	3.3.0	T1-031300
TP-23	TP-040043	160		Addition of RRC test case 8.3.7.2 to RRC ATS V3.4.0	F	3.4.0	3.5.0	T1-031918
TP-21	TP-030209	161	-	CR to 34.123-3 V321 to introduce test case TC_8_4_1_16	F	3.2.1	3.3.0	T1-031301
TP-23	TP-040043	161		Addition of RRC test case 8.3.7.4 to RRC ATS V3.4.0	F	3.4.0	3.5.0	T1-031772
TP-23	TP-040043	162		Addition of NAS test case 12.2.1.7 to NAS ATS V3.4.0	B	3.4.0	3.5.0	T1s040029
TP-23	TP-040043	163		Addition of RAB test case 14.2.27 to RAB ATS V3.4.0	B	3.4.0	3.5.0	T1s040033
TP-23	TP-040043	164		Introducing test case 12_6_1_1 to NASv330	B	3.4.0	3.5.0	T1-031745
TP-23	TP-040043	165		Introducing test case 8.2.4.3 to RRCv330	F	3.4.0	3.5.0	T1-031747
TP-23	TP-040043	166		Introducing test case 8.2.4.4 to RRCv330	F	3.3.0	3.5.0	T1-031749
TP-23	TP-040043	167		Introduction of Package 2 test case 8.3.1.21	F	3.4.0	3.5.0	T1s040049
TP-23	TP-040043	168		Addition of NAS test case 9.4.2.2.1 to NAS ATS V3.4.0	B	3.3.0		T1s040025
TP-23	TP-040043	169		Addition of NAS test case 9.4.2.2.2 to NAS ATS V3.4.0	B	3.4.0	3.5.0	T1s040027
TP-23	TP-040043	170		Addition of NAS test case 9.4.9 to NAS ATS V3.4.0	B	3.4.0	3.5.0	T1s040014
TP-23	TP-040043	171		Addition of RAB test case 14.2.26 to RAB ATS V3.4.0	B	3.4.0	3.5.0	T1s040002
TP-23	TP-040043	171		Addition of NAS test case 9.4.2.5 to NAS ATS V3.4.0	B	3.4.0	3.5.0	T1s040082
TP-23	TP-040043	172		Addition of RAB test case 14.2.4 to TS 34.123-3, V3.4.0	B	3.4.0	3.5.0	T1s040004
TP-23	TP-040043	172		Correction to RRC Package 1 TC 8.2.1.8 and 8.2.1.9 for the mismatch between Radio Bearer setup and PDP context Activation Accept message	B	3.4.0	3.5.0	T1s040071
TP-23	TP-040043	173		Incorrect timer poll value used for SS RLC transmit entity in tcs 8.2.1.8, 8.2.1.9 (Revision of T1-031782)	F	3.3.0	3.5.0	T1-031842

Meeting	TSG doc	CR	Rev	Subject	Cat	Old vers	New vers	WG doc
TP-23	TP-040043	174		Correction of Poll bit checking in tc 7.2.3.13 (Revision of T1-031839)	F	3.3.0	3.5.0	T1-031921
TP-23	TP-040043	175		Modification to Radio Bearer Release message in tc 8.2.3.18 and 8.2.3.19	F	3.3.0	3.5.0	T1-031924
TP-23	TP-040043	176		Maximum allowed UL TX power should not be present in tcs 8.2.2.8, 8.2.2.9 and 8.2.2.23	F	3.3.0	3.5.0	T1-031925
TP-23	TP-040043	177		New C-RNTI should not be present in tc 8.2.6.20	F	3.3.0	3.5.0	T1-031787
TP-23	TP-040043	178		Unnecessary waiting time for reconfiguration in tc 8.2.2.23	F	3.3.0	3.5.0	T1-031788
TP-23	TP-040043	179		Modification to validate TI flag and TI value in TCs 11.3.1 and 11.3.2	F	3.3.0	3.5.0	T1-031795
TP-23	TP-040043	180		Change U-RNTI and remove UTRAN DRX cycle length coefficient tc 8.3.3.1	F	3.3.0	3.5.0	T1-031841
TP-23	TP-040043	181		Corrections of Status PDU checking in tc 7.2.3.34	F	3.3.0	3.5.0	T1-031786
TP-23	TP-040043	182		Correction of number of negatively acknowledged PDUs in tc 7.2.3.16	F	3.3.0	3.5.0	T1-031789
TP-23	TP-040043	183		Correction of sequence number checking and Verdict assessments in tc 7.2.3.17	F	3.3.0	3.5.0	T1-031790
TP-23	TP-040043	184		Introducing test case 8.3.1.1 to RRCv340	F	3.3.0	3.5.0	T1-031733
TP-23	TP-040043	184		Poll Bit and Status PDU content checking in tc 7.2.3.14	F	3.3.0	3.5.0	T1-031791
TP-23	TP-040043	185		Additional verdicts assigned in tc 7.2.3.20	F	3.3.0	3.5.0	T1-031792
TP-23	TP-040043	186		SERVICE ACCEPT message NOT to be sent to UE in GMM idle state in tc 11.3.1 and 11.3.2	F	3.3.0	3.5.0	T1-031794
TP-23	TP-040043	187		Change to performing integrity protection in tc 12.2.1.1	F	3.3.0	3.5.0	T1-031778
TP-23	TP-040043	188		Correction of Poll bit checking in tc 7.2.3.18	F	3.3.0	3.5.0	T1-031781
TP-23	TP-040019	189		Addition of RAB test case 14.2.29 to RAB ATS V3.4.0	B	3.4.0	3.5.0	T1s040199
TP-23	TP-040019	190		Addition of RAB test case 14.2.31.1 to RAB ATS V3.4.0	B	3.4.0	3.5.0	T1s040198
TP-23	TP-040019	191		Addition of RAB test case 14.2.32.1 to RAB ATS V3.4.0	B	3.4.0	3.5.0	T1s040197
TP-23	TP-040043	192		Introducing test case 8.3.1.22 to RRCv340	F	3.3.0	3.5.0	T1-031797
TP-23	TP-040019	193		Addition of RAB test case 14.4.3 to RAB ATS V3.4.0	B	3.4.0	3.5.0	T1s040196
TP-23	TP-040043	195		Introducing test case 8.2.2.18 to RRCv340	F	3.4.0	3.5.0	T1-031932
TP-23	TP-040043	205		Addition of RRC test case 8.3.2.1 to RRC ATS V3.4.0	B	3.4.0	3.5.0	T1-031823
TP-23	TP-040043	206		Addition of RRC test case 8.3.2.4 to RRC ATS V3.4.0	B	3.3.0	3.5.0	T1-031825
TP-23	TP-040043	207		Addition of RRC test case 8.3.2.7 to RRC ATS V3.4.0	F	3.4.0	3.5.0	T1-031827
TP-23	TP-040043	210		Addition of NAS test case 12.2.2.1 to NAS ATS V3.4.0	F	3.4.0	3.5.0	T1-031936
TP-23	TP-040043	211		Addition of NAS test case 12.4.3.1 to NAS ATS V3.4.0	B	3.4.0	3.5.0	T1-031937
TP-23	TP-040043	216		Revised CR for Changes to Introducing test case 8.2.6.9 required for approvalto RRCv340	F	3.4.0	3.5.0	T1s040088
TP-23	TP-040043	220		Addition of RRC test case 8.4.1.17 to RRC ATS V3.4.0	B	3.4.0	3.5.0	T1-031940
TP-23	TP-040043	221		Addition of RRC test case 8.2.2.19 to RRC ATS V3.4.0	B	3.4.0	3.5.0	T1-031939
TP-23	TP-040043	222		Addition of NAS test case 12.2.1.3 to NAS ATS V3.4.0	B	3.4.0	3.5.0	T1-031938
TP-23	TP-040043	224		Addition of RRC test case 8.3.1.31 to RRC ATS V3.4.0	B	3.3.0	3.5.0	T1-031909
TP-23	TP-040043	226		Validation of TMSI status in ATTACH REQUEST message for tc 12.3.1.5	F	3.4.0	3.5.0	T1-031913
TP-23	TP-040043	227		Validation of optional old PTMSI signature in ATTACH REQUEST message for tc 12.2.1.1	F	3.3.0	3.5.0	T1-031914
TP-23	TP-040043	230		Validation of CS CKSN in paging response in tc 9.2.1	F	3.3.0	3.5.0	T1-031922
TP-23	TP-040043	232		To add verified GCF package 1 RRC test case 8.3.1.3 to the approved RRC ATS V3.4.0	F	3.4.0	3.5.0	T1-031926
TP-23	TP-040043	233		Introducing test case 8.3.1.4 to RRCv340	F	3.4.0	3.5.0	T1s040087
TP-24	TP-040117	233		Clarification of Section 8.5.1 Authentication: Explicitly stating that Authentication after IDT is an optional/dependent procedure.	F	3.5.2	3.6.0	T1-040761
TP-23	TP-040043	234		Introducing test case 12_4_2_1 to NASv340	F	3.4.0	3.5.0	T1-031930
TP-24	TP-040117	234		GERAN generic procedures and TTCN encoding rules for CSN.1 specific encoding	F	3.5.2	3.6.0	T1-040940
TP-22	TP-030285	251	-	Updating Annex A	F	3.3.0	3.4.0	-
TP-22	TP-030284	252	-	Security ASP changes	F	3.3.0	3.4.0	T1-031732
TP-24	TP-040118	255		Addition of MAC test case 7.1.3.1 to MAC ATS V3.5.1	B	3.5.1	3.6.0	T1s040295
TP-24	TP-040118	256		Addition of RAB test case 14.2.49.1 to RAB ATS V3.5.1	B	3.5.1	3.6.0	T1s040254
TP-24	TP-040118	257		Addition of GCF P1 test case 8.4.1.2 to RRC ATS	B	3.5.1	3.6.0	T1s040252

Meeting	TSG doc	CR	Rev	Subject	Cat	Old vers	New vers	WG doc
				V3.5.1				
TP-24	TP-040118	258		Revised CR for P3 NAS test case 13.2.2.1 to NAS ATS V3.5.1 (revision of T1-040239)	B	3.5.1	3.6.0	T1s040330
TP-24	TP-040118	259		Revised CR for P3 NAS test case 13.2.2.2 to NAS ATS V3.5.1 (revision of T1-040241)	B	3.5.1	3.6.0	T1s040331
TP-24	TP-040118	260		Addition of GCF P3 test case 8.4.1.31 to RRC ATS v3.5.1	B	3.5.1	3.6.0	T1s040285
TP-24	TP-040118	261		Revised CR for addition of GCF P2 test case 12.4.2.2 to NAS ATS V3.5.1	B	3.5.1	3.6.0	T1s040283
TP-24	TP-040118	262		Addition of RRC test case 8.3.2.11 to RRC ATS V3.5.1	B	3.5.1	3.6.0	T1s040262
TP-24	TP-040118	263		Addition of RRC test case 8.4.1.30 to RRC ATS V3.5.1	B	3.5.1	3.6.0	T1s040260
TP-24	TP-040118	264		Addition of RRC test case 8.4.1.29 to RRC ATS V3.5.1	B	3.5.1	3.6.0	T1s040258
TP-24	TP-040118	265		Addition of RAB test case 14.2.7a to RAB ATS V3.5.1	B	3.5.1	3.6.0	T1s040249
TP-24	TP-040118	266		Addition of RAB test case 14.2.5a to RAB ATS V3.5.1	B	3.5.1	3.6.0	T1s040247
TP-24	TP-040118	267		Addition of RAB test case 14.2.4a to RAB ATS V3.5.1	B	3.5.1	3.6.0	T1s040245
TP-24	TP-040118	268		Addition of GCF P1 test case 12.4.1.1a to NAS ATS V3.5.1	B	3.5.1	3.6.0	T1s040266
TP-24	TP-040118	269		Test Case 13.2.1.1	B	3.5.1	3.6.0	T1s040237
TP-24	TP-040118	270		Addition of GCF P3 test case 10.1.2.6.6 to NAS ATS V3.4.0	B	3.4.0	3.6.0	T1s040234
TP-24	TP-040118	271		Addition of GCF P3 test case 10.1.2.7.2 to NAS ATS V3.4.0	B	3.4.0	3.6.0	T1s040233
TP-24	TP-040118	272		Addition of GCF P3 test case 10.1.2.5.5 to NAS ATS V3.4.0	B	3.4.0	3.6.0	T1s040231
TP-24	TP-040118	273		Addition of GCF P3 test case 10.1.2.6.2 to NAS ATS V3.4.0	B	3.4.0	3.6.0	T1s040232
TP-24	TP-040118	274		Addition of GCF P3 test case 10.1.2.4.10 to NAS ATS V3.4.0	B	3.4.0	3.6.0	T1s040230
TP-24	TP-040118	275		Addition of GCF P3 test case 10.1.2.3.3 to NAS ATS V3.4.0	B	3.4.0	3.6.0	T1s040229
TP-24	TP-040118	276		Addition of NAS test case 8.3.1.2 to RRC ATS V3.4.0 (revision of T1-031735)	B	3.4.0	3.6.0	T1s040226
TP-24	TP-040118	277		Addition of NAS test case 8.3.1.5 to RRC ATS V3.4.0 (revision of T1-031807)	B	3.4.0	3.6.0	T1s040227
TP-24	TP-040118	278		Addition of NAS test case 8.3.1.6 to RRC ATS V3.4.0 (revision of T1-031809)	B	3.4.0	3.6.0	T1s040228
TP-24	TP-040118	279		Addition of GCF P3 test case 14.2.12 to RAB ATS V3.4.0	B	3.4.0	3.6.0	T1s040225
TP-24	TP-040118	280		Addition of NAS test case 10.1.3.3.1 to NAS ATS V3.4.0 (Revision of T1s040170)	B	3.4.0	3.6.0	T1s040222
TP-24	TP-040118	281		Addition of RRC test case 8.1.10.1 to RRC ATS V3.4.0	B	3.4.0	3.6.0	T1s040223
TP-24	TP-040118	282		Addition of GCF P2 test case 8.4.1.18 to RRC ATS V3.4.0	B	3.4.0	3.6.0	T1s040215
TP-24	TP-040118	283		Addition of GCF P2 test case 8.4.1.19 to RRC ATS V3.4.0	B	3.4.0	3.6.0	T1s040216
TP-24	TP-040118	284		Addition of NAS test case 10.1.3.5.6 to NAS ATS V3.4.0	B	3.4.0	3.6.0	T1s040213
TP-24	TP-040118	285		Addition of NAS test case 10.1.2.2.2 to NAS ATS V3.4.0	B	3.4.0	3.6.0	T1s040209
TP-24	TP-040118	286		Addition of RRC test case 8.4.1.26 to RRC ATS V3.4.0	B	3.4.0	3.6.0	T1s040207
TP-24	TP-040118	287		Addition of GCF P1 test case 8.4.1.3 to RRC ATS V3.4.0	B	3.4.0	3.6.0	T1s040205
TP-24	TP-040118	288		Addition of RRC test case 8.3.7.3 to RRC ATS V3.4.0	B	3.4.0	3.6.0	T1-040084
TP-24	TP-040118	289		Introducing package 2 test case 8.3.1.10 to RRCv340 (revision of T1-031739)	B	3.4.0	3.6.0	T1s040204
TP-24	TP-040118	290		Introducing package 2 test case 8.3.1.9 to RRCv340 (revision of T1-031737)	B	3.4.0	3.6.0	T1s040203
TP-24	TP-040118	291		Addition of NAS test case 10.1.2.1.1 to NAS ATS V3.4.0	B	3.4.0	3.6.0	T1s040178
TP-24	TP-040118	292		Addition of NAS test case 10.1.3.3.2 to NAS ATS V3.4.0	B	3.4.0	3.6.0	T1s040172
TP-24	TP-040118	293		Addition of NAS test case 10.1.3.3.4 to NAS ATS V3.4.0	B	3.4.0	3.6.0	T1s040174
TP-24	TP-040118	294		Addition of NAS test case 10.1.2.7.3 to NAS ATS V3.4.0	B	3.4.0	3.6.0	T1s040161
TP-24	TP-040118	295		Addition of NAS test case 10.1.2.5.2 to NAS ATS V3.4.0	B	3.4.0	3.6.0	T1s040149
TP-24	TP-040118	296		Addition of RAB test case 14.2.23a.1 to RAB ATS	B	3.4.0	3.6.0	T1s040065

Meeting	TSG doc	CR	Rev	Subject	Cat	Old vers	New vers	WG doc
				V3.4.0				
TP-24	TP-040118	297		Addition of RAB test case 14.2.23b to RAB ATS V3.4.0	B	3.4.0	3.6.0	T1s040067
TP-24	TP-040118	298		Addition of RAB test case 14.2.23c to RAB ATS V3.4.0	B	3.4.0	3.6.0	T1s040069
TP-24	TP-040118	299		Addition of RAB test case 14.2.14.1 to RAB ATS V3.4.0	B	3.4.0	3.6.0	T1s040055
TP-24	TP-040118	300		Addition of RAB test case 14.2.14.2 to RAB ATS V3.4.0	B	3.4.0	3.6.0	T1s040057
TP-24	TP-040118	301		Addition of RAB test case 14.2.15 to RAB ATS V3.4.0	B	3.4.0	3.6.0	T1s040059
TP-24	TP-040118	302		Addition of RAB test case 14.2.16 to RAB ATS V3.4.0	B	3.4.0	3.6.0	T1s040061
TP-24	TP-040118	303		Addition of RAB test case 14.2.17 to RAB ATS V3.4.0	B	3.4.0	3.6.0	T1s040063
TP-24	TP-040118	304		Addition of RAB test case 14.2.13.2 to RAB ATS V3.4.0	B	3.4.0	3.6.0	T1s040053
TP-24	TP-040118	305		Addition of NAS test case 10.1.2.4.9 to NAS ATS V3.4.0	B	3.4.0	3.6.0	T1s040129
TP-24	TP-040118	306		Addition of NAS test case 10.1.2.4.4 to NAS ATS V3.4.0	B	3.4.0	3.6.0	T1s040121
TP-24	TP-040118	307		Addition of NAS test case 10.1.2.4.6 to NAS ATS V3.4.0	B	3.4.0	3.6.0	T1s040123
TP-24	TP-040118	308		Addition of NAS test case 10.1.2.6.3 to NAS ATS V3.4.0	B	3.4.0	3.6.0	T1s040139
TP-24	TP-040118	309		Addition of NAS test case 10.1.2.4.7 to NAS ATS V3.4.0	B	3.4.0	3.6.0	T1s040099
TP-24	TP-040118	310		Addition of NAS test case 10.1.2.4.8 to NAS ATS V3.4.0	B	3.4.0	3.6.0	T1s040101
TP-24	TP-040118	311		Addition of NAS test case 10.1.2.9.1 to NAS ATS V3.4.0	B	3.4.0	3.6.0	T1s040107
TP-24	TP-040118	312		Addition of NAS test case 10.1.2.3.1 to NAS ATS V3.4.0	B	3.4.0	3.6.0	T1s040091
TP-24	TP-040118	313		Addition of NAS test case 10.1.2.4.3 to NAS ATS V3.4.0	B	3.4.0	3.6.0	T1s040093
TP-24	TP-040118	314		Addition of NAS test case 9.4.2.3 to NAS ATS V3.4.0	B	3.4.0	3.6.0	T1s040080
TP-24	TP-040118	315		Addition of NAS test case 9.4.8 to NAS ATS V3.4.0	B	3.4.0	3.6.0	T1s040023
TP-24	TP-040118	316		Addition of NAS test case 12.6.1.2 to NAS ATS V3.4.0	B	3.4.0	3.6.0	T1s040016
TP-24	TP-040119	317		Quality of Service (QoS) initialisation when setting up a PS call	F	3.5.1	3.6.0	T1s040320
TP-24	TP-040119	318		Correction to RRC Package 2 TC 8.3.1.4 to stop the timer t_WaitS after receiving expected UTRAN MOBILITY INFORMATION CONFIRM message from UE.	F	3.5.1	3.6.0	T1s040322
TP-24	TP-040119	319		Corrections to RRC package 1 and 2 test cases from sections 8.1.x, 8.2.x and 8.3.x to add a delay before SS reconfigures MAC according to the new C-RNTI or U-RNTI assigned to UE.	F	3.5.1	3.6.0	T1s040323
TP-24	TP-040119	320		Correction to RRC TC 8.3.1.3 on the contents of CELL UPDATE CONFIRM message	F	3.5.1	3.6.0	T1s040324
TP-24	TP-040119	321		Correction to RRC Package 1 TC 8.1.1.2 and 8.1.1.3 to add delay before switching to CELL_PCH or URA_PCH	F	3.5.1	3.6.0	T1s040321
TP-24	TP-040119	322		Correction to Package 2 GMM test case 12.2.1.3 for supporting USIM removal without power off	F	3.5.2	3.6.0	T1s040289
TP-24	TP-040119	323		Correction to Package 3 NAS CC test cases 10_1_2_5_5, 10_1_2_6_2 and 10_1_2_7_2 to validate the current TI value.	F	3.5.1	3.6.0	T1s040297
TP-24	TP-040119	324		Correction to Package 3 NAS CC test cases 10.1.2.6.6; introducing PIXIT parameter for UE Call waiting support.	F	3.5.1	3.6.0	T1s040298
TP-24	TP-040119	325		Correction to Package 1 SM test case 11.1.1.1 in handling Modify PDP Context procedure.	F	3.5.1	3.6.0	T1s040299
TP-24	TP-040119	326		Correction to Radio Bearer setup message for Package 1 RAB test case 14.2.13.1 and package 2 RAB test case 14.2.15.	F	3.5.1	3.6.0	T1s040300
TP-24	TP-040119	327		Correction to Package 3 RAB test case 14.2.14.1 Radio Bearer setup in the SS.	F	3.5.1	3.6.0	T1s040301
TP-24	TP-040119	328		Correction to RRC TC 8.2.2.18 and 8.2.2.17 on contents of radio bearer reconfiguration message and comments in test steps of TC 8.2.2.18.	F	3.5.1	3.6.0	T1s040302
TP-24	TP-040119	329		Correction to RRC Package 2 TC 8.3.1.3 to delete the Radio Bearer BCCH mapped to FACH(RB_BCCH_FACH) in the old cell before configuring in the new cell.	F	3.5.1	3.6.0	T1s040303

Meeting	TSG doc	CR	Rev	Subject	Cat	Old vers	New vers	WG doc
TP-24	TP-040119	330		Correction to Package 3 NAS MM test case 9.4.2.2.2 to disable cell C ATT flag	F	3.5.1	3.6.0	T1s040304
TP-24	TP-040119	331		Correction to Package 2 NAS MM test case 9.4.9; introducing postamble to remove PLMN2 from USIM forbidden PLMN list.	F	3.5.2	3.6.0	T1s040305
TP-24	TP-040119	332		Modification to RLC 7.2.3.33 TTCN to meet Test Procedure 'f' in Prose 34.123-1-571.	F	3.5.1	3.6.0	T1s040306
TP-24	TP-040119	333		Correction to Package 3 NAS CC test case 10.1.2.7.3 for assigning FAIL verdict on receiving unexpected RELEASE message.	F	3.5.1	3.6.0	T1s040288
TP-24	TP-040119	334		Correction to RRC TC 8.2.2.10 on contents of radio bearer reconfiguration message.	F	3.5.1	3.6.0	T1s040291
TP-24	TP-040119	335		Correction to RRC Package 2 TC 8.4.1.16 and 8.4.1.17 for contents of SIB 11 and Measurement reporting Interval.	F	3.5.1	3.6.0	T1s040292
TP-24	TP-040119	336		Correction to common test step "ts_SS_2_FACH_1_RACH_ModifyDCH_Cfg" of RRC ATS to release unused RLC entity, related to test cases 8.4.1.18 and 8.4.1.19	F	3.5.1	3.6.0	T1s040293
TP-24	TP-040119	337		Correction to Package 1 SM TC 11.1.1.1, 11.3.1 and 11.3.2 to harmonize the timer handling and to account for T1-040514, T1s040243 and T1s040244 concerning RAB release and detaching.	F	3.5.1	3.6.0	T1s040287
TP-24	TP-040119	338		Correction to Approved Package 1 TC 11.1.1.1	F	3.5.0	3.6.0	T1S040284
TP-24	TP-040119	339		Correction to package 2 TC 9.1 to handle PS attach and detach.	F	3.5.2	3.6.0	T1s040282
TP-24	TP-040119	340		Correction to Approved RRC Package 1 TC 8.4.1.1	F	3.5.0	3.6.0	T1s040279
TP-24	TP-040119	341		Changes to the test step ts_CC_InitTCV_MO	F	3.5.1	3.6.0	T1s040277
TP-24	TP-040119	342		Correction to Package 1 GMM test case 12.3.1.2 for P-TMSI signature check at Step 12.	F	3.5.1	3.6.0	T1s040278
TP-24	TP-040119	343		Regression error corrections to wk12 and wk15.	F	3.5.1	3.6.0	T1s040274
TP-24	TP-040119	344		Correction to Package 2 MM TC 9.4.9 to handle situation when pc_PS is TRUE also.	F	3.5.2	3.6.0	T1s040273
TP-24	TP-040119	345		Correction to GFC P1 RAB test case 14.2.4	F	3.5.1	3.6.0	T1s040272
TP-24	TP-040119	346		Correction to GFC P3 RAB test cases 14.2.26 and 14.2.27	F	3.5.1	3.6.0	T1s040251
TP-24	TP-040119	347		Correction to Approved RRC Package 1 TC 8.3.4.2 and 8.3.4.3	F	3.5.0	3.6.0	T1s040235
TP-24	TP-040119	348		Correction to Approved RRC Package 1 TC 8.3.4.1	F	3.5.0	3.6.0	T1s040224
TP-24	TP-040119	349		Correction to RRC Package 2 TC 8.2.2.7 for radio bearer messages with specified IEs and correction of default PS RAB and SRBs RLC configurations in RRC ATS. (Revision of T1s040165).	F	3.4.0	3.6.0	T1s040219
TP-24	TP-040119	350		Correction to NAS Package 1 TC 12.5 for selecting UE operation mode C only when mode A not supported and validating RRC connection establishment cause	F	3.4.0	3.6.0	T1s040220
TP-24	TP-040119	351		Correction to RRC Package 1 TC 8.1.2.1 modification to UE system specific capabilities (Revision of T1s040078).	F	3.4.0	3.6.0	T1s040221
TP-24	TP-040119	352		Error correction lists to iWD-wk04 and iWD-wk07	F	3.4.0	3.6.0	T1s040188
TP-24	TP-040119	353		TTCN corrections to Generic Setup Procedures	F	3.4.0	3.6.0	T1s040189
TP-24	TP-040119	354		General correction to approved GCF P1 (Cell FACH) MAC test cases	F	3.4.0	3.6.0	T1s040185
TP-24	TP-040119	355		Correction to RRC Package 1 TC 8.2.1.8 and 8.2.1.9 for the mismatch between Radio Bearer setup and PDP context Activation Request message (Revision of T1s040071).	F	3.4.0	3.6.0	T1s040163
TP-24	TP-040119	356		Modification to ATT flag usage in TC 12.3.1.5. (Re-submission of T1-031923 on v3.4.0)	F	3.4.0	3.6.0	T1s040164
TP-24	TP-040119	357		Corrections to RRC Package 1 TC 8.1.2.9 to modify timers and RRC Setup Request constraints	F	3.4.0	3.6.0	T1s040077
TP-24	TP-040119	358		Corrections to Package 1 test case tc_8_1_1_1	F	3.4.0	3.6.0	T1s040079
TP-24	TP-040123	359		Updating Annex A	F	3.5.2	3.6.0	-
TP-25	TP-040162	359		ASP updating and other corrections	F	3.6.1	3.7.0	T1-041407
TP-25	TP-040149	360	-	Addition of GCF P3 test case 16.1.1 to SMS ATS V3.5.1	B	3.5.1	3.7.0	T1s040264
TP-25	TP-040149	361	-	Addition of GCF P3 test case 16.1.9.1 to SMS ATS V3.5.1	B	3.5.1	3.7.0	T1s040307
TP-25	TP-040149	362	-	Addition of GCF P3 test case 16.1.9.2 to SMS ATS V3.5.1	B	3.6.1	3.7.0	T1s040309
TP-25	TP-040149	363	-	Addition of GCF P3 test case 16.1.10 to SMS ATS V3.5.1	B	3.6.1	3.7.0	T1s040311

Meeting	TSG doc	CR	Rev	Subject	Cat	Old vers	New vers	WG doc
TP-25	TP-040149	364	-	Addition of GCF P3 test case 16.2.1 to SMS ATS V3.6.1	B	3.5.1	3.7.0	T1s040313
TP-25	TP-040149	365	-	Addition of GCF P3 test case 16.2.2 to SMS ATS V3.5.1	B	3.6.1	3.7.0	T1s040315
TP-25	TP-040149	366	-	Addition of GCF P3 test case 16.2.10 to SMS ATS V3.5.1	B	3.6.0	3.7.0	T1s040317
TP-25	TP-040149	367	-	Addition of P2 NAS test case 9.4.2.4 proc 2 to NAS ATS V3.5.1 (revision of T1-040109)	B	3.6.0	3.7.0	T1s040329
TP-25	TP-040149	368	-	Addition of NAS test case 12.4.2.5a.2 to NAS ATS V3.5.1	B	3.5.1	3.7.0	T1s040337
TP-25	TP-040149	369	-	Revised CR for addition of GCF P3 test case 8.2.4.1a to RRC ATS V3.5.1	B	3.5.1	3.7.0	T1s040339
TP-25	TP-040149	370	-	Revised CR for Addition of P2 test case 6.2.1.1 to IR_U ATS v3.5.1 (Revision of T1s040325)	B	3.6.1	3.7.0	T1s040345
TP-25	TP-040149	371	-	Revised CR for Addition of P2 test case 6.2.1.6 to IR_U ATS v3.5.1 (Revision of T1s040327)	B	3.5.1	3.7.0	T1s040346
TP-25	TP-040149	372	-	Addition of RRC test case 8.4.1.40 to RRC ATS V3.5.1	B	3.5.1	3.7.0	T1s040352
TP-25	TP-040149	373	-	Addition of RRC Package 3 test case 8.4.1.33 to IR_U ATS V3.5.1	B	3.5.1	3.7.0	T1s040358
TP-25	TP-040149	374	-	Revised CR for addition of GCF P3 test case 16.1.2 to SMS ATS V3.5.1	B	3.6.1	3.7.0	T1s040360
TP-25	TP-040149	375	-	Revised CR for the addition of GCF P3 test case 8.4.1.35 to IR_U ATS V3.5.1	B	3.6.1	3.7.0	T1s040361
TP-25	TP-040149	376	-	CR for the addition of GCF P3 test case 8.4.1.36 to IR_U ATS V3.6.1	B	3.6.1	3.7.0	T1s040364
TP-25	TP-040149	377	-	Addition of GCF P3 test case 8.3.2.12 to RRC ATS V3.6.1	B	3.6.1	3.7.0	T1s040385
TP-25	TP-040149	378	-	Addition of RAB Package 3 test case 14.2.57 to RAB ATS V3.6.1	B	3.6.1	3.7.0	T1s040387
TP-25	TP-040149	379	-	Addition of GCF P3 test case 14.2.58 to RAB ATS V3.6.1	B	3.6.1	3.7.0	T1s040395
TP-25	TP-040149	380	-	Addition of GCF P1 test cases 8.1.7.1 to RRC ATS v3.6.1	B	3.6.1	3.7.0	T1s040398
TP-25	TP-040149	381	-	Addition of GCF P1 test case 8.1.7.2 to RRC ATS v3.6.1	B	3.5.1	3.7.0	T1s040400
TP-25	TP-040149	382	-	Addition of RAB Package 2 test case 14.4.2.1 to RAB ATS V3.6.1	B	3.5.1	3.7.0	T1s040430
TP-25	TP-040149	383	-	Addition of RAB Package 3 test case 14.2.38a to RAB ATS V3.6.1	B	3.5.1	3.7.0	T1s040432
TP-25	TP-040149	384	-	Addition of RAB Package 3 test case 14.2.38e to RAB ATS V3.6.1	B	3.5.1	3.7.0	T1s040433
TP-25	TP-040149	385	-	Addition of RAB Package 2 test case 14.4.2.2 to RAB ATS V3.6.1	B	3.5.1	3.7.0	T1s040462
TP-25	TP-040149	386	-	Addition of RAB Package 2 test case 14.4.2.3 to RAB ATS V3.6.1	B	3.6.1	3.7.0	T1s040464
TP-25	TP-040149	387	-	Addition of RAB test case 14.2.51.1 to RAB ATS V3.6.0	B	3.6.0	3.7.0	T1s040466
TP-25	TP-040149	388	-	Addition of RAB test case 14.2.51a.1 to RAB ATS V3.6.0	B	3.6.0	3.7.0	T1s040468
TP-25	TP-040149	389	-	Addition of P3 test case 8.4.1.27 to RRC ATS V3.6.1	B	3.6.1	3.7.0	T1s040470
TP-25	TP-040149	390	-	Revision CR to introduce GCF P3 Test Case 8.4.1.24 to ATS v3.6.0	B	3.5.1	3.7.0	T1s040482
TP-25	TP-040149	391	-	Revision CR to introduce GCF P3 Test Case 8.4.1.25 to ATS v3.6.0	B	3.5.1	3.7.0	T1s040483
TP-25	TP-040149	392	-	Addition of NAS test case 9.4.7 to NAS ATS V3.6.0	B	3.6.1	3.7.0	T1s040513
TP-25	TP-040149	393	-	Addition of GCF P3 test case 8.4.1.34 to IR_U ATS v3.6.1	B	3.6.1	3.7.0	T1s040479
TP-25	TP-040148	394	-	TTCN correction to P2 test case 8.1.10.1	F	3.5.2	3.7.0	T1s040236
TP-25	TP-040148	395	-	Correction to Approved RRC Package 1 TC 8.3.1.1	F	3.5.1	3.7.0	T1s040334
TP-25	TP-040148	396	-	Correction to Package 2 NAS MM test case 9.4.2.2.1 to validate of LOCATION UPDATE REQUEST message and disable ATT flag.	F	3.5.1	3.7.0	T1s040335
TP-25	TP-040148	397	-	Correction to RRC Package 2 TC 8.4.1.18 and TC 8.4.1.19 for inconsistency in System Information Block 12.	F	3.5.1	3.7.0	T1s040336
TP-25	TP-040148	398	-	Correction to Approved Package 1 RRC TC 8.1.2.2	F	3.5.1	3.7.0	T1s040341
TP-25	TP-040148	399	-	Corrections to RRC test case 6.2.1.1	F	3.5.1	3.7.0	T1s040347
TP-25	TP-040148	400	-	Corrections to RRC test case 6.2.1.6	F	3.5.1	3.7.0	T1s040349
TP-25	TP-040148	401	-	Correction to Approved RRC Package 1 TC 8.3.4.2	F	3.5.0	3.7.0	T1s040351
TP-25	TP-040148	402	-	Correction to Approved RRC Package 2 TC 8.2.4.3	F	3.5.0	3.7.0	T1s040363
TP-25	TP-040148	403	-	Correction to Approved RRC Package 1 TC 8.3.4.3	F	3.6.0	3.7.0	T1s040366

Meeting	TSG doc	CR	Rev	Subject	Cat	Old vers	New vers	WG doc
TP-25	TP-040148	404	-	Regression error corrections to wk17, wk20 and wk23.	F	3.6.1	3.7.0	T1s040367
TP-25	TP-040148	405	-	TTCN Correction to GCF P2 IR_U 8.3.7.1 & 8.3.7.4	F	3.6.0	3.7.0	T1s040374
TP-25	TP-040148	406	-	Correction to Package 2 NAS CCMM test cases 9.4.8; for removal of 'USIM removal possible while UE is powered' support.	F	3.6.1	3.7.0	T1s040375
TP-25	TP-040148	407	-	Correction to RRC TC 8.3.2.4 on value of the wait timer started for the UE to enter Idle mode.	F	3.6.1	3.7.0	T1s040376
TP-25	TP-040148	408	-	Correction to RRC Package 2 TC 8.2.1.9 to handle cell update before configuring radio bearer from DCH to FACH.	F	3.6.1	3.7.0	T1s040377
TP-25	TP-040148	409	-	Correction to RRC TC 8.2.6.19 and 8.2.6.20 to add delay before switching to CELL_PCH/URA_PCH	F	3.6.1	3.7.0	T1s040378
TP-25	TP-040148	410	-	Correction to Package 3 RAB test case 14.2.27, 14.2.29, 14.2.31.1 and 14.2.32.1 for the dl_TxPower in DL DPCH Info during Radio Bearer Setup at the SS.	F	3.6.1	3.7.0	T1s040383
TP-25	TP-040148	411	-	Correction to Package 2 RAB test case 14.4.3	F	3.6.1	3.7.0	T1s040384
TP-25	TP-040148	412	-	Correction to test steps "ts_ReceiveFirstSDUs_RB10" and "ts_ReceiveFirstSDUs_RB13" of Package 3 RAB test case 14.2.49.1	F	3.6.1	3.7.0	T1s040389
TP-25	TP-040148	413	-	Correction to GMM Package 2 approved TC 12.6.1.2 in handling Attach procedure.	F	3.6.1	3.7.0	T1s040402
TP-25	TP-040148	414	-	Delay to ensure the proper transmission of Cell Update Confirm in 8.3.4.2.	F	3.6.1	3.7.0	T1s040403
TP-25	TP-040148	415	-	Guard timer setting if registration is made to a PLMN different from the normal one	F	3.6.1	3.7.0	T1s040420
TP-25	TP-040148	416	-	Correction to RRC Package 2 TC 8.3.1.31.	F	3.6.1	3.7.0	T1s040422
TP-25	TP-040148	417	-	Correction to Package 2 RAB test case 14.4.3 to assign tcv_CN_Domain.	F	3.6.1	3.7.0	T1s040423
TP-25	TP-040148	418	-	Addition of a delay after reception of an RRC Connection Release Complete Message	F	3.6.1	3.7.0	T1s040424
TP-25	TP-040148	419	-	General correction for test cases where UE is switched off Cell(s) released and reconfigured	F	3.6.1	3.7.0	T1s040425
TP-25	TP-040148	420	-	Corrections to RRC Package 3 TC 8.4.1.29 and 8.4.1.30.	F	3.6.1	3.7.0	T1s040429
TP-25	TP-040148	421	-	Correction to RRC TC 8.2.3.8 in ts_RRC_ReceiveRB_SetupCmpl.	F	3.6.1	3.7.0	T1s040478
TP-25	TP-040148	422	-	Correction to Approved RRC Package 2 TC 8.3.1.22	F	3.6.0	3.7.0	T1s040426
TP-25	TP-040148	423	-	TTCN Correction to test case 8.4.1.1 to RRC ATS V3.6.0	F	3.6.0	3.7.0	T1s040390
TP-25	TP-040167	424	-	Addition of NAS test case 9.4.3.5 to NAS ATS V3.6.0	B	3.6.0	3.7.0	T1s040460
TP-25	TP-040167	425	-	Addition of GCF P4 test case 10.1.2.2.1 ATS V3.6.0	B	3.6.0	3.7.0	T1s040410
TP-25	TP-040167	426	-	Addition of GCF P4 test case 9.5.5 ATS V3.6.0	B	3.6.0	3.7.0	T1s040408
TP-25	TP-040167	427	-	Addition of NAS test case 12.6.1.3.2 to NAS ATS V3.6.0	B	3.6.0	3.7.0	T1s040456
TP-25	TP-040167	428	-	Addition of NAS test case 12.9.14 to NAS ATS V3.6.0	B	3.6.0	3.7.0	T1s040458
TP-25	TP-040167	429	-	Addition of NAS test case 12.4.1.3 to NAS ATS V3.6.0	B	3.6.0	3.7.0	T1s040452
TP-25	TP-040167	430	-	Addition of NAS test case 12.9.3 to NAS ATS V3.6.0	B	3.6.0	3.7.0	T1s040519
TP-25	TP-040167	431	-	Addition of NAS test case 12.9.4 to NAS ATS V3.6.0	B	3.6.0	3.7.0	T1s040521
TP-25	TP-040167	432	-	Addition of RRC test case 8.2.2.4 to RRC ATS V3.6.0	B	3.6.0	3.7.0	T1s040515
TP-25	TP-040167	433	-	Addition of RRC test case 8.2.6.12 to RRC ATS V3.6.0	B	3.6.0	3.7.0	T1s040517
TP-25	TP-040167	434	-	Addition of RAB test case 14.2.38c to RAB ATS V3.6.0	B	3.6.0	3.7.0	T1s040527
TP-25	TP-040167	435	-	Addition of RAB test case 14.2.38f to RAB ATS V3.6.0	B	3.6.0	3.7.0	T1s040529
TP-25	TP-040167	436	-	Addition of RAB test case 14.2.40 to RAB ATS V3.6.0	B	3.6.0	3.7.0	T1s040523
TP-25	TP-040167	437	-	Addition of RAB test case 14.2.41 to RAB ATS V3.6.0	B	3.6.0	3.7.0	T1s040525
TP-25	TP-040167	438	-	Addition of RRC Package 4 test case 8.1.3.5 to RRC ATS V3.6.1	B	3.6.1	3.7.0	T1s040500
TP-25	TP-040167	439	-	Addition of RRC Package 4 test case 8.2.1.4 to RRC ATS V3.6.1	B	3.6.1	3.7.0	T1s040502
TP-25	TP-040167	440	-	Addition of RRC Package 4 test case 8.2.1.7 to RRC ATS V3.6.1	B	3.6.1	3.7.0	T1s040504
TP-25	TP-040167	441	-	Addition of RRC Package 4 test case 8.1.2.3 to RRC ATS V3.6.1	B	3.6.1	3.7.0	T1s040498
TP-25	TP-040167	442	-	Addition of P4 RRC test case 8.3.2.9	B	3.6.1	3.7.0	T1s040495
TP-25	TP-040167	443	-	Addition of P4 RRC test case 8.2.6.2	B	3.6.1	3.7.0	T1s040573
TP-25	TP-040167	444	-	Addition of P4 RRC test case 8.3.1.17	B	3.6.1	3.7.0	T1s040493
TP-25	TP-040167	445	-	Addition of P4 RRC test case 8.1.6.1	B	3.6.1	3.7.0	T1s040489

Meeting	TSG doc	CR	Rev	Subject	Cat	Old vers	New vers	WG doc
TP-25	TP-040167	446	-	Addition of GCF P4 test case 8.3.1.12 to RRC ATS V3.6.0	B	3.6.0	3.7.0	T1s040446
TP-25	TP-040167	447	-	Addition of GCF P4 test case 8.2.6.11 to RRC ATS V3.6.0	B	3.6.0	3.7.0	T1s040444
TP-25	TP-040167	448	-	Addition of GCF P4 test case 9.5.4 ATS V3.6.0	B	3.6.0	3.7.0	T1s040440
TP-25	TP-040167	449	-	Addition of P3 test case 8.4.1.37 to RRC ATS V3.6.1	B	3.6.1	3.7.0	T1s040474
TP-25	TP-040167	450	-	Addition of P3 test case 8.4.1.38 to RRC ATS V3.6.1	B	3.6.1	3.7.0	T1s040476
TP-25	TP-040167	451	-	Addition of GCF P4 test case 12.2.1.2 ATS V3.6.0	B	3.6.0	3.7.0	T1s040450
TP-25	TP-040167	452	-	Addition of RAB Package 3 test case 14.2.38b to RAB ATS V3.6.1	B	3.6.1	3.7.0	T1s040533
TP-25	TP-040167	453	-	Modification to MAC Package 2 test case 7.1.3.1	F	3.6.1	3.7.0	T1s040531
TP-25	TP-040167	454	-	Correction to NAS test cases 9.4.2.3 (P2), 9.4.2.4 Proc 2 (P2), and 12.4.1.1a (P1)	F	3.6.1	3.7.0	T1s040514
TP-25	TP-040167	455	-	Correction to Package 3 SMS test case 16.2.1.	F	3.6.1	3.7.0	T1s040497
TP-25	TP-040167	456	-	Correction to GCF P1 test case 8.3.1.1	F	3.6.0	3.7.0	T1s040484
TP-25	TP-040193	460	-	Updating Annex A	F	3.6.1	3.7.0	-
TP-26	TP-040237	461	-	ASP update and other corrections	F	3.7.0	3.8.0	T1-041975
TP-26	TP-040237	462	-	Addition of AT command lists used in ATSSs	F	3.7.0	3.8.0	T1-041976
TP-26	TP-040237	463	-	ASP change for Radio Link Modification	F	3.7.0	3.8.0	T1-041694
TP-26	TP-040241	1050	-	Addition of GCF P4 test case 8.2.2.35 to RRC ATS V3.7.0	B	3.7.0	3.8.0	T1s040743
TP-26	TP-040241	1051	-	Addition of RRC test case 8.3.1.18 to RRC ATS V3.7.0	B	3.7.0	3.8.0	T1s040448
TP-26	TP-040241	1052	-	Addition of GCF P1 test case 8.4.1.5 to RRC ATS v3.7.0	B	3.7.0	3.8.0	T1s040739
TP-26	TP-040241	1053	-	Addition of GCF P4 test case 8.1.7.1d to RRC ATS v3.7.0	B	3.7.0	3.8.0	T1s040717
TP-26	TP-040241	1054	-	Addition of RRC Package 3 test case 6.1.1.5 to RRC ATS V3.7.0	B	3.7.0	3.8.0	T1s040698
TP-26	TP-040241	1055	-	Addition of GCF P4 test case 12.2.1.4.1 ATS V3.7.0	B	3.7.0	3.8.0	T1s040690
TP-26	TP-040241	1056	-	Addition of GCF P4 test case 12.4.1.4a ATS V3.7.0	B	3.7.0	3.8.0	T1s040679
TP-26	TP-040241	1057	-	Addition of RRC test case 8.2.3.29 to RRC ATS V3.7.0 (Revision of T1s040688)	B	3.7.0	3.8.0	T1s040703
TP-26	TP-040241	1058	-	Changes to GCF package 2 IR_U test case 12.8 required for approval	B	3.7.0	3.8.0	T1s040615
TP-26	TP-040241	1059	-	Addition of P4 test case 8.3.11.1 to IR_U ATS v3.7.0, (Revision of T1s040633).	B	3.7.0	3.8.0	T1s040684
TP-26	TP-040241	1060	-	Addition of GCF P4 test cases 8.1.7.1c to RRC ATS v3.7.0	B	3.7.0	3.8.0	T1s040677
TP-26	TP-040241	1061	-	Correction to Package 4 test case 12.9.7b ATS V3.7.0	B	3.7.0	3.8.0	T1s040674
TP-26	TP-040241	1062	-	Addition of GCF P4 test case 12.4.1.4b ATS V3.7.0	B	3.7.0	3.8.0	T1s040628
TP-26	TP-040241	1063	-	Correction to Package 4 GMM test case 12.4.1.1b (Revised CR T1s040467)	B	3.7.0	3.8.0	T1s040656
TP-26	TP-040241	1064	-	Addition of RRC test case 8.3.1.24 to RRC ATS V3.7.0	B	3.7.0	3.8.0	T1s040671
TP-26	TP-040241	1065	-	Addition of RRC test case 8.3.2.2 to RRC ATS V3.7.0	B	3.7.0	3.8.0	T1s040669
TP-26	TP-040241	1066	-	Addition of NAS test case 12.4.1.4c2 to NAS ATS V3.7.0	B	3.7.0	3.8.0	T1s040664
TP-26	TP-040241	1067	-	Addition of RRC test case 8.3.1.25 to RRC ATS V3.7.0	B	3.7.0	3.8.0	T1s040658
TP-26	TP-040241	1068	-	Addition of NAS test case 12.6.1.3.3 to NAS ATS V3.7.0	B	3.7.0	3.8.0	T1s040651
TP-26	TP-040241	1069	-	Addition of RRC test case 8.3.2.13 to RRC ATS V3.7.0	B	3.7.0	3.8.0	T1s040653
TP-26	TP-040241	1070	-	Addition of P4 test case 8.1.3.4 to the RRC ATS V3.7.0	B	3.7.0	3.8.0	T1s040649
TP-26	TP-040241	1071	-	Addition of P4 test case 8.3.7.13 to IR_U ATS v3.7.0	B	3.7.0	3.8.0	T1s040638
TP-26	TP-040241	1072	-	Addition of P4 test case 8.3.7.7 to IR_U ATS v3.7.0	B	3.7.0	3.8.0	T1s040640
TP-26	TP-040241	1073	-	Addition of NAS test case 12.9.8 to NAS ATS V3.7.0	B	3.7.0	3.8.0	T1s040613
TP-26	TP-040241	1074	-	Addition of NAS test case 12.4.1.4d1 to NAS ATS V3.7.0	B	3.7.0	3.8.0	T1s040635
TP-26	TP-040241	1075	-	Addition of P2 test case 6.2.1.9 to IR_U ATS v3.7.0	B	3.7.0	3.8.0	T1s040604
TP-26	TP-040241	1076	-	Addition of GCF P4 test case 12.2.1.5b ATS V3.7.0	B	3.7.0	3.8.0	T1s040595
TP-26	TP-040241	1077	-	Addition of GCF P4 test case 12.9.7c ATS V3.7.0	B	3.7.0	3.8.0	T1s040587
TP-26	TP-040241	1078	-	Addition of GCF P4 test case 8.2.2.31 to RRC ATS V3.7.0	B	3.7.0	3.8.0	T1s040485
TP-26	TP-040241	1079	-	Addition of RAB Package 4 test case 14.4.2a.3 to RAB ATS V3.7.0	B	3.7.0	3.8.0	T1s040626
TP-26	TP-040241	1080	-	Addition of RAB Package 4 test case 14.4.2a.2 to RAB ATS V3.7.0	B	3.7.0	3.8.0	T1s040624

Meeting	TSG doc	CR	Rev	Subject	Cat	Old vers	New vers	WG doc
TP-26	TP-040241	1081	-	Addition of RAB Package 4 test case 14.4.2a.1 to RAB ATS V3.7.0	B	3.7.0	3.8.0	T1s040622
TP-26	TP-040241	1082	-	Addition of RRC Package 4 test case 8.2.3.11 to RRC ATS V3.7.0	B	3.7.0	3.8.0	T1s040620
TP-26	TP-040241	1083	-	Addition of NAS test case 12.4.3.4 to NAS ATS V3.7.0	B	3.7.0	3.8.0	T1s040609
TP-26	TP-040241	1084	-	Addition of NAS test case 12.9.6 to NAS ATS V3.7.0	B	3.7.0	3.8.0	T1s040607
TP-26	TP-040241	1085	-	Changes to GCF package 4 IR_U test case 8.3.7.9 required for approval.	B	3.7.0	3.8.0	T1s040552
TP-26	TP-040241	1086	-	Changes to GCF package 4 IR_U test case 8.3.7.5 required for approval.	B	3.7.0	3.8.0	T1s040548
TP-26	TP-040241	1087	-	Addition of GCF P4 test case 12.4.1.2 ATS V3.6.0	B	3.7.0	3.8.0	T1s040585
TP-26	TP-040241	1088	-	Addition of GCF P4 test case 10.1.2.2.3 ATS V3.6.0	B	3.7.0	3.8.0	T1s040412
TP-26	TP-040241	1089	-	Addition of GCF P4 test case 9.5.7.1 ATS V3.6.0	B	3.7.0	3.8.0	T1s040404
TP-26	TP-040241	1090	-	Addition of GCF P4 test cases 8.1.12 to RRC ATS v3.6.1	B	3.7.0	3.8.0	T1s040602
TP-26	TP-040241	1091	-	Addition of GCF P4 test cases 8.1.7.1b to RRC ATS v3.6.1	B	3.7.0	3.8.0	T1s040600
TP-26	TP-040241	1092	-	Addition of GCF P4 test case 12.2.1.6.2 ATS V3.6.0	B	3.7.0	3.8.0	T1s040436
TP-26	TP-040241	1093	-	Addition of GCF P4 test case 12.2.1.5a.1 ATS V3.6.0	B	3.7.0	3.8.0	T1s040434
TP-26	TP-040241	1094	-	Addition of GCF P4 test case 8.3.1.15 to RRC ATS V3.6.0	B	3.7.0	3.8.0	T1s040487
TP-26	TP-040241	1095	-	Addition of GCF P4 test case 8.1.2.4 ATS V3.6.0	B	3.7.0	3.8.0	T1s040442
TP-26	TP-040241	1096	-	Addition of NAS test case 12.4.1.4d2 to NAS ATS V3.6.0	B	3.7.0	3.8.0	T1s040579
TP-26	TP-040241	1097	-	Addition of GCF P3 test case 6.1.1.7 ATS V3.6.0	B	3.7.0	3.8.0	T1s040427
TP-26	TP-040241	1098	-	Addition of GCF P3 test case 12.4.2.5a.1 ATS V3.6.0	B	3.7.0	3.8.0	T1s040472
TP-26	TP-040241	1099	-	Re-submission of GCF package 2 IR_U test case 6.2.2.1 for approval.	B	3.7.0	3.8.0	T1s040534
TP-26	TP-040241	1100	-	Addition of RAB test case 14.2.51b.1 to RAB ATS V3.6.0	B	3.7.0	3.8.0	T1s040570
TP-26	TP-040241	1101	-	Addition of RRC test case 10.1.2.3.7 to RRC ATS V3.6.1	B	3.7.0	3.8.0	T1s040508
TP-26	TP-040241	1102	-	Addition of RRC test case 10.1.2.7.1 to RRC ATS V3.6.1	B	3.7.0	3.8.0	T1s040510
TP-26	TP-040241	1103	-	Addition of RRC test case 10.1.2.3.2 to RRC ATS V3.6.1	B	3.7.0	3.8.0	T1s040506
TP-26	TP-040241	1104	-	Addition of NAS Package 4 test case 12.2.1.6 Proc1 to NAS ATS V3.6.1	B	3.7.0	3.8.0	T1s040565
TP-26	TP-040241	1105	-	Addition of NAS Package 4 test case 12.2.1.4 proc2 to NAS ATS V3.6.1	B	3.7.0	3.8.0	T1s040561
TP-26	TP-040241	1106	-	Addition of NAS Package 4 test case 12.2.1.5a Proc2 to NAS ATS V3.6.1	B	3.7.0	3.8.0	T1s040563
TP-26	TP-040241	1107	-	Addition of NAS Package 4 test case 12.2.1.10 to NAS ATS V3.6.1	B	3.7.0	3.8.0	T1s040559
TP-26	TP-040241	1108	-	Addition of RAB test case 14.2.23a2 to RAB ATS V3.6.0	B	3.7.0	3.8.0	T1s040556
TP-26	TP-040241	1109	-	Addition of NAS test case 12.6.1.3.1 to NAS ATS V3.6.0	B	3.7.0	3.8.0	T1s040454
TP-26	TP-040241	1110	-	Addition of GCF P2 RRC 8.4.1.7 - Revision of T1s040381	B	3.7.0	3.8.0	T1s040766
TP-26	TP-040242	1111	-	Correction to RRC P3 TC 8.4.1.37	F	3.7.0	3.8.0	T1s040735
TP-26	TP-040242	1112	-	Correction to RRC P2 TC 8.3.1.31 for the timer value before step 5.	F	3.7.0	3.8.0	T1s040736
TP-26	TP-040242	1113	-	Correction to approved GCF P4 test cases 8.1.7.1c	F	3.7.0	3.8.0	T1s040734
TP-26	TP-040242	1114	-	Correction to approved package 4 NAS Test case tc_12_6_1_3_2	F	3.7.0	3.8.0	T1s040737
TP-26	TP-040242	1115	-	Corrections to RRC Package 1 TC 8.4.1.1.	F	3.7.0	3.8.0	T1s040738
TP-26	TP-040242	1116	-	Correction to the RRC default message handler on Dc SAP for Deactivate PDP Context Request message in RRC ATS.	F	3.7.0	3.8.0	T1s040731
TP-26	TP-040242	1117	-	Correction to TTCN for MultiRAB test cases.	F	3.7.0	3.8.0	T1s040732
TP-26	TP-040242	1118	-	Correction to approved package 4 NAS Test case tc_12_6_1_3_1	F	3.7.0	3.8.0	T1s040733
TP-26	TP-040242	1119	-	Summary of regression errors in the wk45 ATS.	F	3.7.0	3.8.0	T1s040723
TP-26	TP-040242	1120	-	Correction to RRC P4 TC 8.1.7.1b for comments in test steps.	F	3.7.0	3.8.0	T1s040711
TP-26	TP-040242	1121	-	Correction to GCF P3 NAS test Cases 13.2.1.1, 13.2.2.1 and 13.2.2.2	F	3.7.0	3.8.0	T1s040712
TP-26	TP-040242	1122	-	Correction to GCF P4 NAS test Case 12.2.1.6.2	F	3.7.0	3.8.0	T1s040713
TP-26	TP-040242	1123	-	Correction to RAB test case 14.4.2.3 and 14.4.2a.3.	F	3.7.0	3.8.0	T1s040714
TP-26	TP-040242	1124	-	Correction to RRC Package 2 TC 8.3.1.3.	F	3.7.0	3.8.0	T1s040722

Meeting	TSG doc	CR	Rev	Subject	Cat	Old vers	New vers	WG doc
TP-26	TP-040242	1125	-	Correction to AT Command used for GCF P1 NAS test Case 10.1.2.5.1	F	3.7.0	3.8.0	T1s040724
TP-26	TP-040242	1126	-	Correction in TTCN for execution of Opmode C UE.	F	3.7.0	3.8.0	T1s040725
TP-26	TP-040242	1127	-	Correction to RRC Package 4 TC 8.1.2.3	F	3.7.0	3.8.0	T1s040726
TP-26	TP-040242	1128	-	Correction to RRC test cases 8.1.2.1 and 8.1.2.7	F	3.7.0	3.8.0	T1s040727
TP-26	TP-040242	1130	-	Correction to RRC test cases 8.1.3.1, 8.1.3.3, 8.1.3.4 and 8.1.3.5	F	3.7.0	3.8.0	T1s040729
TP-26	TP-040242	1131	-	Correction to RRC Package 1 TC 8.1.2.9	F	3.7.0	3.8.0	T1s040730
TP-26	TP-040242	1132	-	Correction to Package 2 RRC test case 8.3.1.4	F	3.7.0	3.8.0	T1s040721
TP-26	TP-040242	1133	-	Correction to Package 3 RRC inter-RAT measurement test cases 8.4.1.31 + 8.4.1.33 + 8.4.1.34 + 8.4.1.35 + 8.4.1.36 + 8.4.1.40	F	3.7.0	3.8.0	T1s040715
TP-26	TP-040242	1134	-	Correction to approved NAS test case 12.9.4	F	3.7.0	3.8.0	T1s040716
TP-26	TP-040242	1135	-	Correction to Approved RRC Package 2 TC 8.3.7.2	F	3.7.0	3.8.0	T1s040709
TP-26	TP-040242	1136	-	Correction to Approved RRC Package 3 TC 8.2.4.1a	F	3.7.0	3.8.0	T1s040708
TP-26	TP-040242	1137	-	Correction to Approved RRC Package 3 TC 8.4.1.31	F	3.7.0	3.8.0	T1s040707
TP-26	TP-040242	1138	-	Correction to GCF P2 test cases 6.2.1.1, 6.2.1.6 and 6.2.1.9 to IR_U ATS v3.7.0 to check the displayed PLMN.	F	3.7.0	3.8.0	T1s040693
TP-26	TP-040242	1139	-	Correction to Package 2 RAB test case 14.4.2.2 and 14.4.2.3.	F	3.7.0	3.8.0	T1s040697
TP-26	TP-040242	1140	-	Correction to GCF P4 NAS test Case 12.4.1.2 (Revision of T1-040673)	F	3.7.0	3.8.0	T1s040696
TP-26	TP-040242	1141	-	Correction of GCF P1 test case 7.2.3.23	F	3.7.0	3.8.0	T1s040694
TP-26	TP-040242	1142	-	Global correction of Structured Type Constraints containing wildcards violating coding convention E.3.7	F	3.7.0	3.8.0	T1s040695
TP-26	TP-040242	1143	-	Correction to GCF P4 RRC test Case 8.3.1.15	F	3.7.0	3.8.0	T1s040675
TP-26	TP-040242	1144	-	Extension to Guard Timer for Approved NAS GMM Test Cases	F	3.7.0	3.8.0	T1s040692
TP-26	TP-040242	1145	-	Correction to RRC TC 8.1.12 for handling correct number of RRC Connection Release Complete message based on the value of N308	F	3.7.0	3.8.0	T1s040687
TP-26	TP-040242	1146	-	Corrections Required for the wk42 ATS	F	3.7.0	3.8.0	T1s040682
TP-26	TP-040242	1147	-	Corrections to release of SS resources for a cell during test case execution	F	3.7.0	3.8.0	T1s040681
TP-26	TP-040242	1148	-	Correction to approved RRC Package 1 8.3.1.1	F	3.7.0	3.8.0	T1s040668
TP-26	TP-040242	1149	-	Correction to approved RRC Package 4 TC 8.2.6.11	F	3.7.0	3.8.0	T1s040667
TP-26	TP-040242	1150	-	Regression test error corrections to TTCN deliveries of wk40	F	3.7.0	3.8.0	T1s040666
TP-26	TP-040242	1151	-	Correction of GCF P1 test case 7.2.3.14	F	3.7.0	3.8.0	T1s040660
TP-26	TP-040242	1152	-	Correction of GCF P1 test case 11.1.1.1	F	3.7.0	3.8.0	T1s040661
TP-26	TP-040242	1153	-	Correction of GCF P3 SMS test cases 16.1.1, 16.1.2, 16.1.9.1, 16.1.9.2, 16.1.10, 16.2.1, 16.2.2, 16.2.10	F	3.7.0	3.8.0	T1s040662
TP-26	TP-040242	1154	-	Corrections Required for the wk40 ATS	F	3.7.0	3.8.0	T1s040663
TP-26	TP-040242	1155	-	Correction to Approved RRC Package 2 TC 8.2.4.3	F	3.7.0	3.8.0	T1s040655
TP-26	TP-040242	1156	-	Correction to Package 3 SMS test cases.	F	3.7.0	3.8.0	T1s040637
TP-26	TP-040242	1157	-	Correction to approved package 4 NAS Test case tc_12_4_1_4d2	F	3.7.0	3.8.0	T1s040648
TP-26	TP-040242	1158	-	Correction to Package 4 NAS test case 12.2.1.2 for increasing the guard timer.	F	3.7.0	3.8.0	T1s040630
TP-26	TP-040242	1159	-	Regression error corrections to TTCN deliveries of wk34 and wk37	F	3.7.0	3.8.0	T1s040636
TP-26	TP-040242	1160	-	Summary of regression errors in the wk37 ATS.	F	3.7.0	3.8.0	T1s040617
TP-26	TP-040242	1161	-	Correction to RRC Package 1 test cases 8.1.7.1 and 8.1.7.2 (Revision of T1s040532)	F	3.7.0	3.8.0	T1s040618
TP-26	TP-040242	1162	-	Corrections Required for the wk37 ATS (Revision of T1s040606)	F	3.7.0	3.8.0	T1s040619
TP-26	TP-040242	1163	-	Correction to Package 2 RRC test case 8.3.2.11 to increase the timer while waiting for URA Update.	F	3.7.0	3.8.0	T1s040599
TP-26	TP-040242	1164	-	Correction to Approved RRC Package 1 TC 8.1.2.2	F	3.7.0	3.8.0	T1s040584
TP-26	TP-040242	1165	-	Radiolink removal and subsequent addition to align the TTCN with 34.123-1	F	3.7.0	3.8.0	T1s040583
TP-26	TP-040242	1166	-	TTCN Correction to Test Case 14.2.12 and 14.2.16	F	3.7.0	3.8.0	T1s040581
TP-26	TP-040242	1167	-	Correction to Approved RRC Package 2 TC 8.4.1.2	F	3.7.0	3.8.0	T1s040582
TP-26	TP-040242	1168	-	Corrections to GCF package 2 IR_U test case 6.2.1.1	F	3.7.0	3.8.0	T1s040536
TP-26	TP-040242	1169	-	Corrections to GCF package 2 IR_U test case 6.2.1.6	F	3.7.0	3.8.0	T1s040538
TP-26	TP-040242	1170	-	Correction of GCF package 2 IR_U test case 8.3.7.1.	F	3.7.0	3.8.0	T1s040540
TP-26	TP-040242	1171	-	Correction of GCF package 2 IR_U test case 8.3.7.2.	F	3.7.0	3.8.0	T1s040542
TP-26	TP-040242	1172	-	Correction of GCF package 2 IR_U test case 8.3.7.3.	F	3.7.0	3.8.0	T1s040544
TP-26	TP-040242	1173	-	Correction of GCF package 2 IR_U test case 8.3.7.4.	F	3.7.0	3.8.0	T1s040546
TP-26	TP-040242	1174	-	Correction of GCF package 2 IR_U test case 8.4.1.40.	F	3.7.0	3.8.0	T1s040554

Meeting	TSG doc	CR	Rev	Subject	Cat	Old vers	New vers	WG doc
TP-26	TP-040242	1175	-	TTCN changes to approved package 1 RRC testcase 8.4.1.3	F	3.7.0	3.8.0	T1s040576
TP-26	TP-040242	1176	-	Correction to MultiRAB test cases 14.2.38a, 14.2.38b and 14.2.38e	F	3.7.0	3.8.0	T1s040575
TP-26	TP-040242	1177	-	Correction to Approved RRC Package 2 TC 8.4.1.2	F	3.7.0	3.8.0	T1s040572
TP-26	TP-040242	1178	-	Addition of verdicts in RRC default message handler on Dc SAP for Deactivate PDP Context Request message in RRC ATS.(Revision of T1s040512)	F	3.7.0	3.8.0	T1s040569
TP-26	TP-040242	1179	-	Regression error corrections to TTCN deliveries of wk26 and wk31	F	3.7.0	3.8.0	T1s040558
TP-26	TP-040242	1180	-	Modification to MAC Package 2 test case 7.1.3.1	F	3.7.0	3.8.0	T1s040531
TP-26	TP-040242	1181	-	Correction to NAS test cases 9.4.2.3 (P2), 9.4.2.4 Proc 2 (P2), and 12.4.1.1a (P1)	F	3.7.0	3.8.0	T1s040514
TP-26	TP-040242	1182	-	Correction to Package 3 SMS test case 16.2.1.	F	3.7.0	3.8.0	T1s040497
TP-26	TP-040242	1183	-	Correction to GCF P1 test case 8.3.1.1	F	3.7.0	3.8.0	T1s040484
TP-26	TP-040242	1184	-	Regression test error corrections to TTCN deliveries of wk42	F	3.7.0	3.8.0	T1s040699
TP-26	TP-040238	1185	-	Updating Annex A	F	3.7.0	3.8.0	-
TP-27	TP-050039	1185		RRC Connection Establishment: Reject with InterRATInfo is set to GSM and selection to the designated system fails	B	3.8.0	5.0.0	T1s050056
TP-27	TP-050039	1186		RRC Connection Establishment: Reject with interRATInfo is set to GSM	B	3.8.0	5.0.0	T1s050054
TP-27	TP-050039	1187		MM connection / abortion by the network / cause not equal to #6	B	3.8.0	5.0.0	T1s050044
TP-27	TP-050039	1188		PS detach / rejected / PS services not allowed in this PLMN/ test1	B	3.8.0	5.0.0	T1s050046
TP-27	TP-050039	1189		Routing area updating / abnormal cases / attempt counter check / miscellaneous reject causes	B	3.8.0	5.0.0	T1s050018
TP-27	TP-050039	1190		RRC / Paging for Connection in connected mode (URA_PCH, multiple paging records)	B	3.8.0	5.0.0	T1s050038
TP-27	TP-050039	1191		Combined routing area updating / abnormal cases / access barred due to access class control / test procedure 1	B	3.8.0	5.0.0	T1s050036
TP-27	TP-050039	1192		Combined routing area updating / abnormal cases / access barred due to access class control / test procedure 2	B	3.8.0	5.0.0	T1s050034
TP-27	TP-050039	1193		Interactive or background / UL:64 DL:384 kbps / PS RAB + UL:3.4 DL: 3.4 kbps SRBs for DCCH / 20 ms TTI	B	3.8.0	5.0.0	T1s050025
TP-27	TP-050039	1194		Measurement Report on INITIAL DIRECT TRANSFER message and UPLINK DIRECT TRANSFER message	B	3.8.0	5.0.0	T1s050031
TP-27	TP-050039	1195		Conversational / speech / UL:5.9 DL:5.9 kbps / CS RAB + UL:3.4 DL:3.4 kbps SRBs for DCCH	B	3.8.0	5.0.0	T1s050023
TP-27	TP-050039	1196		Interactive or background / UL:384 DL:384 kbps / PS RAB + UL:3.4 DL:3.4 kbps SRBs for DCCH / 10 ms TTI	B	3.8.0	5.0.0	T1s050010
TP-27	TP-050039	1197		Interactive or background / UL:128 DL:128 kbps / PS RAB + UL:3.4 DL:3.4 kbps SRBs for DCCH	B	3.8.0	5.0.0	T1s050008
TP-27	TP-050039	1198		Cell change order from UTRAN/To GPRS/CELL_DCH/Failure (Physical channel & Reversion Failure)	B	3.8.0	5.0.0	T1s050001
TP-27	TP-050039	1199		RRC Connection Release in CELL_DCH state (Network Authentication Failure): Success	B	3.8.0	5.0.0	T1s050006
TP-27	TP-050039	1200		Inter system handover from UTRAN/To GSM/Speech/Failure (Physical channel Failure and Reversion Failure)	B	3.8.0	5.0.0	T1s040798
TP-27	TP-050039	1201		Cell reselection using cell status and cell reservations	B	3.8.0	5.0.0	T1s040794
TP-27	TP-050039	1202		RRC / Radio Bearer Establishment for transition from CELL_DCH to CELL_FACH (Frequency band modification): Success	B	3.8.0	5.0.0	T1s040796
TP-27	TP-050039	1203		Correct Selection of RACH parameters (FDD)	B	3.8.0	5.0.0	T1s040755
TP-27	TP-050039	1204		Measurement Control and Report: Additional Measurements list	B	3.8.0	5.0.0	T1s040791
TP-27	TP-050039	1205		PS attach / rejected / PS services not allowed in this PLMN	B	3.8.0	5.0.0	T1s040779
TP-27	TP-050039	1206		Access Service class selection for RACH transmission	B	3.8.0	5.0.0	T1s040757
TP-27	TP-050039	1207		Selection of RAT for UPLMN; Automatic mode	B	3.8.0	5.0.0	T1s040746
TP-27	TP-050039	1208		Selection of RAT for OPLMN; Automatic mode	B	3.8.0	5.0.0	T1s040748
TP-27	TP-050039	1209		Cell reselection if cell becomes barred or S<0; UTRAN to GPRS (CELL_FACH)	B	3.8.0	5.0.0	T1s040701

Meeting	TSG doc	CR	Rev	Subject	Cat	Old vers	New vers	WG doc
TP-27	TP-050039	1210		Service Request / RAB re-establishment / UE initiated / multiple PDP contexts	B	3.8.0	5.0.0	T1s040719
TP-27	TP-050040	1211		Summary of regression errors in the wk04 ATS	F	3.8.0	5.0.0	T1s050063
TP-27	TP-050040	1212		Summary of regression errors in the wk04 ATS.	F	3.8.0	5.0.0	T1s050062
TP-27	TP-050040	1213		Correction to RRC P2 TC 8.4.1.7	F	3.8.0	5.0.0	T1s050040
TP-27	TP-050040	1214		Summary of regression errors in the wk04 ATS.	F	3.8.0	5.0.0	T1s050061
TP-27	TP-050040	1215		Summary of regression errors in the wk04 ATS.	F	3.8.0	5.0.0	T1s050058
TP-27	TP-050040	1216		Correction to approved package 4 NAS Test case 12_6_1_3_3	F	3.8.0	5.0.0	T1s050052
TP-27	TP-050040	1217		Correction to Approved RRC Package 3 TC 8.4.1.38	F	3.8.0	5.0.0	T1s050051
TP-27	TP-050040	1218		Correction to Approved NAS Package 3 TC 9.4.7	F	3.8.0	5.0.0	T1s050053
TP-27	TP-050040	1219		Correction to Approved RRC Package 2 TC 8.3.7.2 / 8.3.7.3	F	3.8.0	5.0.0	T1s050050
TP-27	TP-050040	1220		Correction to Approved RRC Package 3 TC 8.4.1.36	F	3.8.0	5.0.0	T1s050048
TP-27	TP-050040	1221		Correction to Approved IR_U Package 2 test case 6.2.2.1	F	3.8.0	5.0.0	T1s050042
TP-27	TP-050040	1222		Correction to Approved IR_U Package 4 Test Case 8.3.7.12	F	3.8.0	5.0.0	T1s050043
TP-27	TP-050040	1223		Correction to test step "ts_AT_TerminateCall".	F	3.8.0	5.0.0	T1s050041
TP-27	TP-050040	1224		Wk51 regression error report on unapproved and approved Idlemode testcases 6.1.2.x	F	3.8.0	5.0.0	T1s050027
TP-27	TP-050040	1225		Correction to approved package 3 NAS Test case 9_4_7	F	3.8.0	5.0.0	T1s050030
TP-27	TP-050040	1226		Summary of regression errors in the wk51 ATS.	F	3.8.0	5.0.0	T1s050028
TP-27	TP-050040	1227		Correction to RRC P1 TC 8.4.1.3	F	3.8.0	5.0.0	T1s050020
TP-27	TP-050040	1228		Correction to RRC P2 TC 8.3.1.22 for removing check of "FOR" field value from ROUTING AREA UPDATING REQUEST message.	F	3.8.0	5.0.0	T1s050021
TP-27	TP-050040	1229		Correction to Package 4 NAS test case 12.9.14	F	3.8.0	5.0.0	T1s050022
TP-27	TP-050040	1230		Summary of regression errors in the wk51 ATS.	F	3.8.0	5.0.0	T1s050033
TP-27	TP-050040	1231		Correction to 34.123-3, section 16, SMS test cases regarding Validity Period Formats	F	3.8.0	5.0.0	T1s050029
TP-27	TP-050040	1232		Additional Corrections required for 14.4.2.2 test cases in the RAB ATS.	F	3.8.0	5.0.0	T1s050017
TP-27	TP-050040	1233		Revised corrections to approved IR_U test cases 6_2_1_1, 6_2_1_7 and 6_2_1_8.	F	3.8.0	5.0.0	T1s050012
TP-27	TP-050040	1234		Corrections required for "Combinations on SCCPCH" test cases in the RAB ATS.	F	3.8.0	5.0.0	T1s040801
TP-27	TP-050040	1235		Correction to RRC P1 TC 8.4.1.5	F	3.8.0	5.0.0	T1s040797
TP-27	TP-050040	1236		Additional Corrections Required for the wk47 ATS	F	3.8.0	5.0.0	T1s040765
TP-27	TP-050040	1237		Correction to Package 4 NAS test case 12.2.1.5a Proc1	F	3.8.0	5.0.0	T1s040773
TP-27	TP-050040	1238		Summary of regression errors in the wk49 ATS.	F	3.8.0	5.0.0	T1s040790
TP-27	TP-050040	1239		Summary of regression errors in wk49 ATS.	F	3.8.0	5.0.0	T1s040789
TP-27	TP-050040	1240		Correction to Approved RRC Package 4 TC 8.3.11.1	F	3.8.0	5.0.0	T1s040788
TP-27	TP-050040	1241		Correction required to Package 4 NAS test case 12.9.13.	F	3.8.0	5.0.0	T1s040787
TP-27	TP-050040	1242		Correction to approved GCF P4 NAS test case 12.9.8: improvement of incomplete implementation of T1-041930	F	3.8.0	5.0.0	T1s040786
TP-27	TP-050040	1243		Correction to SIB1 contents for approved RRC Idle Mode and InterRAT test cases.	F	3.8.0	5.0.0	T1s040774
TP-27	TP-050040	1244		Correction to Package 4 NAS test cases 12.4.3.4.	F	3.8.0	5.0.0	T1s040781
TP-27	TP-050040	1245		Corrections to RRC Package 3 TC 8.4.1.26 to change the Downlink Power level settings of Cell A at Time Instant 'T1'.	F	3.8.0	5.0.0	T1s040782
TP-27	TP-050040	1246		Correction to GMM Test cases for removing check of "FOR" field value from ATTACH REQUEST and ROUTING AREA UPDATING REQUEST messages. (Revision to TTCN CR T1s040763)	F	3.8.0	5.0.0	T1s040783
TP-27	TP-050040	1247		Correction to RRC P1 TC 8.4.1.5 (Revision of T1s040739)	F	3.8.0	5.0.0	T1s040770
TP-27	TP-050040	1248		Corrections required to rlc_SizeIndex in the RAB ATS	F	3.8.0	5.0.0	T1s040772
TP-27	TP-050040	1249		Corrections to RRC 8.3.2.x for Special LI	F	3.8.0	5.0.0	T1s040769
TP-27	TP-050040	1250		Summary of regression errors in the wk47 ATS.	F	3.8.0	5.0.0	T1s040768
TP-27	TP-050040	1251		Summary of regression errors in the wk47 ATS.	F	3.8.0	5.0.0	T1s040760
TP-27	TP-050040	1252		Correction to Package 2 RRC test case 8.3.2.11 to increase the wait time while checking that UE does not send URA Update.	F	3.8.0	5.0.0	T1s040752
TP-27	TP-050040	1253		Correction to RRC Test Case 8.3.1.22.	F	3.8.0	5.0.0	T1s040753

Meet- ing	TSG doc	CR	Rev	Subject	Cat	Old vers	New vers	WG doc
TP-27	TP-050040	1254		Correction to approved package 2 NAS Test case 9.4.2.3	F	3.8.0	5.0.0	T1s040761
TP-27	TP-050040	1255		Corrections to RRC Package 1 TC 8.3.1.1 to add a delay before SS reconfigures MAC according to the new C-RNTI or U-RNTI assigned to UE.	F	3.8.0	5.0.0	T1s040762
TP-27	TP-050040	1256		Summary of regression errors in the wk47 ATS.	F	3.8.0	5.0.0	T1s040750
TP-27	TP-050040	1257		Corrections Required for the wk47 ATS	F	3.8.0	5.0.0	T1s040758
TP-27	TP-050040	1258		Summary of regression errors in IR_U wk47 ATS.	F	3.8.0	5.0.0	T1s040754
TP-27	TP-050040	1259		Correction to package 1 test case 8.3.4.3.	F	3.8.0	5.0.0	T1s040742
TP-27	TP-050040	1260		Correction to approved package 4 NAS Test cases 12.2.1.6 proc1, 12.2.1.6 proc2 and 12.9.8	F	3.8.0	5.0.0	T1s040745
TP-27	TP-050037	1261	-	Add new verified TTCN test cases CR to 34.123-3 (prose) in Annex A	F	3.8.0	5.0.0	-
TP-27	TP-050036	1263	-	Corrections Required for "Combinations on SCCPCH" configurations.	F	3.8.0	5.0.0	T1-050201r3
TP-27	TP-050036	1264	-	Introduce ASP for HSDPA	B	3.8.0	5.0.0	T1-050036
TP-27	TP-050036	1265	-	Introduce ASP for LCR TDD	B	3.8.0	5.0.0	T1-050037
TP-27	TP-050036	1266	-	Replacement of 34.123-3 Release 99 by a pointer to the newly created Release 5 version	F	3.8.0	3.9.0	T1-050250
TP-27	TP-050036	1267	-	Corrections of encoding rules and postambles	F	3.8.0	5.0.0	T1-050282
TP-27	TP-050036	1268	-	Introduce ASP for A-GPS	B	3.8.0	5.0.0	T1-050284
RP-28	RP-050365	1270	-	Addition of NAS WI 12 test case 12.3.2.7 to NAS ATS V5.0.0	B	5.0.0	5.1.0	R5s050128
RP-28	RP-050365	1271	-	Addition of WI-012 NAS test case 12.9.7a to NAS ATS V5.0.0	B	5.0.0	5.1.0	R5s050134
RP-28	RP-050365	1272	-	Addition of NAS WI 12 test case 12.9.9 to NAS ATS V3.8.0	B	5.0.0	5.1.0	R5s050080
RP-28	RP-050365	1273	-	Addition of WI-010 P3 RAB test case 14.2.43.1 to RAB ATS V5.0.0	B	5.0.0	5.1.0	R5s050100
RP-28	RP-050365	1274	-	Addition of WI-012 RAB test case 14.2.43.2 to RAB ATS V5.0.0	B	5.0.0	5.1.0	R5s050098
RP-28	RP-050365	1275	-	Addition of WI-012 RAB test case 14.2.58a to RAB ATS V5.0.0	B	5.0.0	5.1.0	R5s050096
RP-28	RP-050365	1276	-	Addition of WI-012 RLC test case 7.2.3.28 to RLC ATS V3.8.0	B	5.0.0	5.1.0	R5s050066
RP-28	RP-050365	1277	-	Addition of WI-012 RLC test case 7.2.3.32 to RLC ATS V3.8.0	B	5.0.0	5.1.0	R5s050068
RP-28	RP-050365	1278	-	Addition of WI-012 RLC test case 7.2.3.35 to RLC ATS V3.8.0	B	5.0.0	5.1.0	R5s050070
RP-28	RP-050365	1279	-	Addition of WI12 test case 8.1.1.9 to RRC ATS v5.0.0 (Revision of R5s050125)	B	5.0.0	5.1.0	R5s050141
RP-28	RP-050365	1280	-	Addition of WI12 test cases 8.1.2.11 to RRC ATS v3.8.0	B	5.0.0	5.1.0	R5s050074
RP-28	RP-050365	1281	-	Addition of RRC WI-012 test case 8.3.1.30 to RRC ATS V5.0.0	B	5.0.0	5.1.0	R5s050138
RP-28	RP-050365	1282	-	Addition of WI-012 test case 8.3.7.16 to IR_U ATS 3.8.0.	B	5.0.0	5.1.0	R5s050076
RP-28	RP-050365	1283	-	Regression changes on TC 8.3.9.5 - WK09	B	5.0.0	5.1.0	R5s050112
RP-28	RP-050365	1284	-	Addition of RRC WI-012 test case 8.4.1.6 to RRC ATS V5.0.0	B	5.0.0	5.1.0	R5s050132
RP-28	RP-050365	1285	-	Addition of WI-012 NAS test case 9.4.5.4.6 to NAS ATS V5.0.0	B	5.0.0	5.1.0	R5s050136
RP-28	RP-050365	1286	-	Addition of NAS P4 test case 12.4.1.4c Proc1 to NAS ATS V5.0.0	B	5.0.0	5.1.0	R5s050170
RP-28	RP-050365	1287	-	Revision and Addition of WI-10 (P2) test cases 6.2.2.2 to IR_U ATS v5.0.0	B	5.0.0	5.1.0	R5s050173
RP-28	RP-050281	1289	-	Summary of regression errors for IR_U_r3_wk17.	F	5.0.0	5.1.0	R5s050146
RP-28	RP-050281	1290	-	Correction to Approved RRC Package 4 TC 8.4.1.40	F	5.0.0	5.1.0	R5s050169
RP-28	RP-050281	1291	-	Correction of a missing LB entity in LB setup introduced in Rel-5 in the definition of CLOSE UE TEST LOOP	F	5.0.0	5.1.0	R5s050168
RP-28	RP-050281	1292	-	Correction to approved testcase 8.2.2.4 and 8.2.4.4	F	5.0.0	5.1.0	R5s050165
RP-28	RP-050281	1293	-	Summary of additional regression errors in the wk17 ATS.	F	5.0.0	5.1.0	R5s050166
RP-28	RP-050281	1294	-	Correction to approved testcase 8.2.1.9	F	5.0.0	5.1.0	R5s050163
RP-28	RP-050281	1295	-	Correction in TTCN to support Band II UE for UE capability Information	F	5.0.0	5.1.0	R5s050167
RP-28	RP-050281	1296	-	Correction to value of periodic RA update timer IE in Attach Accept message	F	5.0.0	5.1.0	R5s050152
RP-28	RP-050281	1297	-	Correction to Order of AT commands used for initiation of PS call	F	5.0.0	5.1.0	R5s050153
RP-28	RP-050281	1298	-	Correction to approved testcase 8.1.7.1b	F	5.0.0	5.1.0	R5s050154

Meet- ing	TSG doc	CR	Rev	Subject	Cat	Old vers	New vers	WG doc
RP-28	RP-050281	1299	-	Regression Error Report based on wk17ATS	F	5.0.0	5.1.0	R5s050164
RP-28	RP-050281	1300	-	Correction in TTCN to enable ciphering for 3G to 2G handover.	F	5.0.0	5.1.0	R5s050149
RP-28	RP-050281	1301	-	Correction to approved RRC testcases 8.1.3.3 and 8.1.3.4	F	5.0.0	5.1.0	R5s050148
RP-28	RP-050281	1302	-	Correction to GCF WI-10 test case 8.4.1.3	F	5.0.0	5.1.0	R5s050140
RP-28	RP-050281	1303	-	Corrections to WI-010 P3 RAB test cases 14.2.12, 14.2.16 & 14.2.17	F	5.0.0	5.1.0	R5s050127
RP-28	RP-050281	1304	-	Correction required for WI-010 P3 RAB Testcase 14.2.38c.	F	5.0.0	5.1.0	R5s050124
RP-28	RP-050281	1305	-	Correction to GCF Package 3 RRC test case 8.3.1.24	F	5.0.0	5.1.0	R5s050123
RP-28	RP-050281	1306	-	Summary of additional regression errors in the wk09 ATS.	F	5.0.0	5.1.0	R5s050116
RP-28	RP-050281	1307	-	Correction to approved RRC Package 4 TC 8.3.1.18	F	5.0.0	5.1.0	R5s050117
RP-28	RP-050281	1308	-	Correction to WI-12 Test Case 8.3.7.16	F	5.0.0	5.1.0	R5s050115
RP-28	RP-050282	1309	-	Correction to RRC P3 TC 8.3.2.13	F	5.0.0	5.1.0	R5s050113
RP-28	RP-050282	1310	-	Regression Error Report based on wk09 ATS	F	5.0.0	5.1.0	R5s050114
RP-28	RP-050282	1311	-	Summary of regression errors for IR_U_wk09.	F	5.0.0	5.1.0	R5s050110
RP-28	RP-050282	1312	-	Correction to RRC P2 TC 8.3.1.21	F	5.0.0	5.1.0	R5s050111
RP-28	RP-050282	1313	-	Correction to Approved NAS Package 4 TC 12.4.1.4a	F	5.0.0	5.1.0	R5s050109
RP-28	RP-050283	1314	-	Summary of regression errors in the wk09 ATS.	F	5.0.0	5.1.0	R5s050106
RP-28	RP-050282	1315	-	Correction for the MM test step "ts_GMM_RAU_AcceptEPLMN"	F	5.0.0	5.1.0	R5s050105
RP-28	RP-050282	1316	-	Correction to SMS Test Suite for AT Commands	F	5.0.0	5.1.0	R5s050104
RP-28	RP-050282	1317	-	Changes required to support Release 5	F	5.0.0	5.1.0	R5s050095
RP-28	RP-050282	1318	-	Correction to approved package WI-12 NAS Test case 9_5_7_2	F	5.0.0	5.1.0	R5s050103
RP-28	RP-050283	1319	-	Correction to approved testcase 8.1.10.1	F	5.0.0	5.1.0	R5s050102
RP-28	RP-050282	1320	-	Handling of L2 Acknowledgement on GERAN side.	F	5.0.0	5.1.0	R5s050094
RP-28	RP-050282	1321	-	Correction to Approved RRC Package 4 TC 8.3.1.18	F	5.0.0	5.1.0	R5s050093
RP-28	RP-050282	1322	-	Correction to IR_U P4 Approved test case 8.3.11.4	F	5.0.0	5.1.0	R5s050091
RP-28	RP-050282	1323	-	Summary of iWD_07 regression test errors	F	5.0.0	5.1.0	R5s050078
RP-28	RP-050282	1324	-	Corrections to section 16 SMS test cases to improve AT command handling	F	5.0.0	5.1.0	R5s050090
RP-28	RP-050282	1325	-	Correction to approved GCF P4 test cases 8.1.7.1c	F	5.0.0	5.1.0	R5s050086
RP-28	RP-050282	1326	-	Summary of regression errors in the wk07 ATS.	F	5.0.0	5.1.0	R5s050088
RP-28	RP-050282	1327	-	Correction to approved NAS WI 12 test case 12.4.1.5.	F	5.0.0	5.1.0	R5s050083
RP-28	RP-050282	1328	-	Correction to approved GCF P4 test cases 8.1.7.1d	F	5.0.0	5.1.0	R5s050087
RP-28	RP-050282	1329	-	Correction to approved package 2 NAS Test case 9_5_2	F	5.0.0	5.1.0	R5s050082
RP-28	RP-050282	1330	-	Correction to RRC P1 TC 8.4.1.1, 8.4.1.3 and P3 TC 8.4.1.29	F	5.0.0	5.1.0	R5s050065
RP-28	RP-050365	1331	-	Revision of RRC WI-14 test case 8.2.3.30 to RRC ATS v5.0.0	B	5.0.0	5.1.0	R5s050179
RP-28	RP-050365	1332	-	Addition of RRC WI-014 test case 8.2.4.36 to RRC ATS V5.0.0 (Revision of R5s050161)	B	5.0.0	5.1.0	R5s050199
RP-28	RP-050366	1333	1	Add new verified and e-mail approved TTCN test cases in the TC lists in 34.123-3 (prose), Annex A	F	5.0.0	5.1.0	-
RP-28	RP-050278	1334	-	Correction to specification version references	F	5.0.0	5.1.0	R5-050639
RP-29	RP-050527	1334	-	Addition of WI-10 NAS test case 12.4.2.4 to NAS ATS V5.1.0	B	5.1.0	5.2.0	R5s050295
RP-28	RP-050278	1335	-	Modifying AT Commands, ASPs, TSOs and PIXITs	F	5.0.0	5.1.0	R5-050955
RP-29	RP-050527	1335	-	Addition of WI12 test case 8.2.1.24 to RRC ATS V5.1.0	B	5.1.0	5.2.0	R5s050259
RP-28	RP-050278	1336	-	HSDPA ASP Modification	F	5.0.0	5.1.0	R5-050975
RP-29	RP-050527	1336	-	Addition of WI12 test case 8.2.1.34 to RRC ATS V5.1.0	B	5.1.0	5.2.0	R5s050261
RP-28	RP-050278	1337	-	Modifying G_L2_SYSINFO_REQ ASP	F	5.0.0	5.1.0	R5-050980
RP-29	RP-050527	1337	-	Addition of RRC WI-012 test case 8.2.1.33 to RRC ATS V5.1.0	B	5.1.0	5.2.0	R5s050242
RP-28	RP-050278	1338	-	CR to 34.123-3 Rel-5: Addition of a new ASP required for test case tc_8_1_7_1d	F	5.0.0	5.1.0	R5-050983
RP-29	RP-050527	1338	-	Addition of NAS WI-012 test case 12.2.1.11 to NAS ATS V5.0.0	B	5.1.0	5.2.0	R5s050236
RP-29	RP-050527	1339	-	Addition of WI-10 RRC test case 8.4.1.14 to RRC ATS V5.0.0	B	5.1.0	5.2.0	R5s050228
RP-29	RP-050527	1340	-	Addition of RRC WI-14 test case 8.2.6.42 to RRC ATS v5.0.0	B	5.1.0	5.2.0	R5s050225
RP-29	RP-050527	1341	-	Addition of WI-010 (P4) test case 8.3.9.3 to IR_U ATS V5.0.0	B	5.1.0	5.2.0	R5s050219
RP-29	RP-050527	1342	-	Addition of RRC WI-010 (P2) test case 8.2.4.1 to	B	5.1.0	5.2.0	R5s050210

Meeting	TSG doc	CR	Rev	Subject	Cat	Old vers	New vers	WG doc
				RRC ATS V5.0.0				
RP-29	RP-050527	1343	-	Addition of RRC WI-014 test case 8.3.1.32 to RRC ATS V5.0.0	B	5.1.0	5.2.0	R5s050217
RP-29	RP-050527	1344	-	Addition of RRC WI-014 test case 8.2.1.28 to RRC ATS V5.0.0	B	5.1.0	5.2.0	R5s050212
RP-29	RP-050527	1345	-	Addition of RRC WI-14 test case 8.2.1.32 to RRC ATS v5.0.0	B	5.1.0	5.2.0	R5s050206
RP-29	RP-050527	1346	-	Addition of RRC WI-14 test case 8.2.1.31 to RRC ATS v5.0.0	B	5.1.0	5.2.0	R5s050204
RP-29	RP-050527	1347	-	Addition of RRC WI-014 test case 8.2.2.38 to RRC ATS V5.0.0 (Revision of R5s050157)	B	5.1.0	5.2.0	R5s050197
RP-29	RP-050527	1348	-	Addition of WI-010 RRC test case 6.1.2.1 to RRC ATS V5.0.0	B	5.1.0	5.2.0	R5s050189
RP-29	RP-050527	1349	-	Addition of RRC WI-14 test case 8.2.1.30 to RRC ATS v5.0.0	B	5.1.0	5.2.0	R5s050184
RP-29	RP-050527	1350	-	Addition of RRC WI-10 test case 8.3.1.23 to RRC ATS V5.0.0	B	5.1.0	5.2.0	R5s050175
RP-29	RP-050527	1351	-	Addition of RRC WI-14 test case 8.2.1.29 to RRC ATS v5.0.0	B	5.1.0	5.2.0	R5s050182
RP-29	RP-050527	1352	-	Addition of WI-014 test case 8.3.1.34 to HS_ENH ATS V5.1.0	B	5.1.0	5.2.0	R5s050347
RP-29	RP-050527	1353	-	Addition of WI14 test case 8.3.1.35 to HS_ENH ATS V5.1.0	B	5.1.0	5.2.0	R5s050321
RP-29	RP-050528	1354	-	Addition of WI14 test case 8.2.6.40 to HS_ENH ATS V5.1.0	B	5.1.0	5.2.0	R5s050323
RP-29	RP-050528	1355	-	Addition of WI-014 MAC test case 7.1.5.4 to HS_ENH ATS V5.1.0	B	5.1.0	5.2.0	R5s050318
RP-29	RP-050528	1356	-	Addition of WI14 test case 7.1.5.3 to HS_ENH ATS V5.1.0	B	5.1.0	5.2.0	R5s050315
RP-29	RP-050528	1357	-	Revision (of R5s0500248) to introduce test case 8_2_2_40 based on wk31 ATS	B	5.1.0	5.2.0	R5s050339
RP-29	RP-050528	1358	-	Revision (of R5s050253) to introduce test case 8_3_1_33 based on wk31 ATS	B	5.1.0	5.2.0	R5s050341
RP-29	RP-050528	1359	-	Revision (of R5s050250) to introduce test case 14_6_1 based on wk31 ATS	B	5.1.0	5.2.0	R5s050345
RP-29	RP-050528	1360	-	Addition of WI14 test case 7.1.5.5 to HS_ENH ATS V5.1.0 (Revision of R5s050276)	B	5.1.0	5.2.0	R5s050313
RP-29	RP-050528	1361	-	Addition of WI14 test case 7.1.5.1 to HS_ENH ATS V5.1.0 (Revision of R5s050257)	B	5.1.0	5.2.0	R5s050311
RP-29	RP-050528	1362	-	Addition of WI-014 test case 8.2.1.27 to HS_ENH ATS V5.1.0 (Revision of CR R5s050263)	B	5.1.0	5.2.0	R5s050307
RP-29	RP-050528	1363	-	Addition of WI-014 test case 8.2.6.49 to HS_ENH ATS V5.1.0 (Revision of R5s050265)	B	5.1.0	5.2.0	R5s050309
RP-29	RP-050528	1364	-	Re-submission of WI-014 test case 8.3.11.9 to HS_ENH ATS V5.1.0. (Revision of R5s050150).	B	5.1.0	5.2.0	R5s050349
RP-29	RP-050528	1365	-	Addition of WI-014 test case 8.2.2.36 to HS_ENH ATS V5.1.0 (Revision of CR R5s050267)	B	5.1.0	5.2.0	R5s050360
RP-29	RP-050529	1366	-	Correction required in HSDPA constraint cbr_108_RRC_ConnReq_r5	F	5.1.0	5.2.0	R5s050351
RP-29	RP-050529	1367	-	Correction to approved WI-010 MM Test Cases 9_4_2_2_1 and 9_4_2_2_2	F	5.1.0	5.2.0	R5s050337
RP-29	RP-050529	1368	-	Corrections to test step ts_C4_CheckCellPCH and ts_C4_CheckCellPCH_r5	F	5.1.0	5.2.0	R5s050326
RP-29	RP-050529	1369	-	Correction to GCF P1(WI-10) approved RRC test case 8.1.1.2	F	5.1.0	5.2.0	R5s050320
RP-29	RP-050529	1370	-	Correction required in HSDPA step ts_RRC_RAB_EstPS_MO_P25	F	5.1.0	5.2.0	R5s050317
RP-29	RP-050529	1371	-	Upgrade HSENH ATS to full R5	F	5.1.0	5.2.0	R5s050294
RP-29	RP-050529	1372	-	Correction to GCF approved RRC test case 8.3.1.18	F	5.1.0	5.2.0	R5s050293
RP-29	RP-050529	1373	-	Correction asn.1 calculated values.	F	5.1.0	5.2.0	R5s050255
RP-29	RP-050529	1374	-	Corrections to teststep ts_C5_CheckURA_PCH	F	5.1.0	5.2.0	R5s050280
RP-29	RP-050529	1375	-	Correction to approved testcases 8.3.1.5 and 8.3.1.6	F	5.1.0	5.2.0	R5s050287
RP-29	RP-050529	1376	-	Correction to Inter-RAT Test cases	F	5.1.0	5.2.0	R5s050288
RP-29	RP-050529	1377	-	Correction to the SMS Test Case 16.1.10 and 16.2.10	F	5.1.0	5.2.0	R5s050291
RP-29	RP-050529	1378	-	Summary of regression errors in the wk27 ATS.	F	5.1.0	5.2.0	R5s050292
RP-29	RP-050529	1379	-	Correction to test step ts_CRLC_DL_CipherCfgRB	F	5.1.0	5.2.0	R5s050290
RP-29	RP-050529	1380	-	Correction to GCF WI-12 approved NAS test case 9.4.5.4.6	F	5.1.0	5.2.0	R5s050281
RP-29	RP-050529	1381	-	Correction to GCF WI-10 approved IR_U test case 8.4.1.31	F	5.1.0	5.2.0	R5s050289
RP-29	RP-050529	1382	-	Corrections to Approved WI10 test case 9.4.5.2	F	5.1.0	5.2.0	R5s050282
RP-29	RP-050529	1383	-	Correction to GCF WI-10 test case 8.4.1.5	F	5.1.0	5.2.0	R5s050234

Meeting	TSG doc	CR	Rev	Subject	Cat	Old vers	New vers	WG doc
RP-29	RP-050529	1384	-	Correction to the RRC test case 8.4.1.14	F	5.1.0	5.2.0	R5s050278
RP-29	RP-050529	1385	-	Corrections to teststep ts_HO_SS_ReconfDCH_HS_ToFACH used for WI-14 Test Cases	F	5.1.0	5.2.0	R5s050279
RP-29	RP-050530	1386	-	Correction to 8_1_x series approved testcases	F	5.1.0	5.2.0	R5s050271
RP-29	RP-050530	1387	-	Correction to test step ts_RRC_ReceiverB_SetupCmpl to handle IE "Start" for the ciphering path	F	5.1.0	5.2.0	R5s050272
RP-29	RP-050530	1388	-	Correction to approved Inter-RAT IR_U testcase 8.3.7.13	F	5.1.0	5.2.0	R5s050273
RP-29	RP-050530	1389	-	Correction to approved testcase 8.2.4.1	F	5.1.0	5.2.0	R5s050274
RP-29	RP-050530	1390	-	Correction required for WI-010 P4 RRC Testcase 6.1.2.9.	F	5.1.0	5.2.0	R5s050275
RP-29	RP-050530	1391	-	Correction to GCF WI-12 approved RRC test case 8.3.1.30, 8.4.1.6 and NAS test case 12.3.2.7	F	5.1.0	5.2.0	R5s050270
RP-29	RP-050530	1392	-	Correction to Approved RRC Package 4 TC 8.4.1.33	F	5.1.0	5.2.0	R5s050269
RP-29	RP-050530	1393	-	Guard timer setting needs to be longer in test case 9.4.2.4 Procedure 2.	F	5.1.0	5.2.0	R5s050252
RP-29	RP-050530	1394	-	Corrections to WI-012 approved testcases 8.2.2.9 & 8.2.6.12	F	5.1.0	5.2.0	R5s050246
RP-29	RP-050530	1395	-	Corrections to WI-014 approved testcases 8.2.1.28, 8.2.4.36 & 8.2.1.30	F	5.1.0	5.2.0	R5s050247
RP-29	RP-050530	1396	-	Correction in Approved Test Case 12.2.2.1 of NAS_wk07.mp in iWD-TVB2003-03_D05wk07.zip	F	5.1.0	5.2.0	R5s050245
RP-29	RP-050530	1397	-	Correction to GCF WI-12 approved RRC test case 8.1.6.3	F	5.1.0	5.2.0	R5s050233
RP-29	RP-050530	1398	-	Multiple PICs definitions	F	5.1.0	5.2.0	R5s050241
RP-29	RP-050530	1399	-	ASN.1 changes required for introduction of band V & band VI	F	5.1.0	5.2.0	R5s050215
RP-29	RP-050530	1400	-	Summary of regression errors in the wk21 IR_U and IR_G ATS.	F	5.1.0	5.2.0	R5s050240
RP-29	RP-050530	1401	-	Correction to GCF WI-10 and WI-12 IR_U and IR_G test cases	F	5.1.0	5.2.0	R5s050239
RP-29	RP-050530	1402	-	Correction to IdleMode P1 TC 6.1.2.1	F	5.1.0	5.2.0	R5s050238
RP-29	RP-050530	1403	-	Summary of regression errors in the wk21 IR_U ATS.	F	5.1.0	5.2.0	R5s050230
RP-29	RP-050530	1404	-	Correction to GCF WI-10 test case 8.3.1.1	F	5.1.0	5.2.0	R5s050224
RP-29	RP-050530	1405	-	Correction to approved WI-010 RRC Test case 6_1_2_1	F	5.1.0	5.2.0	R5s050221
RP-29	RP-050531	1406	-	Correction to approved WI-010 RRC Test case 6_1_2_9	F	5.1.0	5.2.0	R5s050227
RP-29	RP-050531	1407	-	Correction to GCF WI-10 test case 8.2.1.10, 8.3.4.1, 8.3.4.2, 12.4.2.5a Proc 2	F	5.1.0	5.2.0	R5s050144
RP-29	RP-050531	1408	-	Correction to WI 12 approved testcase 8.3.1.30	F	5.1.0	5.2.0	R5s050222
RP-29	RP-050531	1409	-	Correction to approved testcase 8.2.6.19 and 8.2.6.20	F	5.1.0	5.2.0	R5s050223
RP-29	RP-050531	1410	-	Correction to GCF high priority MAC test case 7.1.2.4a	F	5.1.0	5.2.0	R5s050214
RP-29	RP-050531	1411	-	Correction to approved testcase 14.2.51b.1	F	5.1.0	5.2.0	R5s050209
RP-29	RP-050531	1412	-	Correction to approved testcase 8.3.7.12	F	5.1.0	5.2.0	R5s050203
RP-29	RP-050531	1413	-	Correction to GCF high priority NAS test case 12.4.1.4b	F	5.1.0	5.2.0	R5s050181
RP-29	RP-050531	1414	-	Regression Error Report based on wk19ATS	F	5.1.0	5.2.0	R5s050202
RP-29	RP-050531	1415	-	Summary of regression errors in the wk19 ATS.	F	5.1.0	5.2.0	R5s050196
RP-29	RP-050531	1416	-	Correction to approved testcase 14.2.58	F	5.1.0	5.2.0	R5s050194
RP-29	RP-050531	1417	-	Correction to WI-12 test case 12.9.7a	F	5.1.0	5.2.0	R5s050195
RP-29	RP-050531	1418	-	Summary of regression errors in the wk19 ATS.	F	5.1.0	5.2.0	R5s050186
RP-29	RP-050531	1419	-	Correction to IE "radioPrioTOM8" in Attach Accept message.	F	5.1.0	5.2.0	R5s050193
RP-29	RP-050531	1420	-	Correction to softhandover test cases in RRC ATS v5.0.0	F	5.1.0	5.2.0	R5s050191
RP-29	RP-050531	1421	-	Correction to RRC and RAB ATS v5.0.0 – regression errors	F	5.1.0	5.2.0	R5s050192
RP-29	RP-050531	1422	-	Correction of syntax error in approved test cases	F	5.1.0	5.2.0	R5s050178
RP-29	RP-050531	1423	-	Correction to the approved IR_U test cases 8.4.1.33, 8.4.1.34, 8.4.1.35, 8.4.1.36 and 8.4.1.40.	F	5.1.0	5.2.0	R5s050187
RP-29	RP-050531	1424	-	Correction to RRC Package 2 TC 8.4.1.23	F	5.1.0	5.2.0	R5s050188
RP-29	RP-050531	1425	-	Correction to RRC P4 TC 8.4.1.41	F	5.1.0	5.2.0	R5s050172
RP-29	RP-050532	1426	-	Correction to approved testcase 14.2.38c and 14.2.40	F	5.1.0	5.2.0	R5s050177
RP-29	RP-050532	1427	-	Summary of regression errors in the wk31 ATS.	F	5.1.0	5.2.0	R5s050354
RP-29	RP-050532	1428	-	Corrections to Approved Test case 8_2_1_29 based on wk31 ATS	F	5.1.0	5.2.0	R5s050327
RP-29	RP-050532	1429	-	Corrections to Approved test case 8_2_1_30 based on wk31 ATS	F	5.1.0	5.2.0	R5s050329

Meeting	TSG doc	CR	Rev	Subject	Cat	Old vers	New vers	WG doc
RP-29	RP-050532	1430	-	Corrections to Approved test case 8_2_1_31 based on wk31 ATS	F	5.1.0	5.2.0	R5s050331
RP-29	RP-050532	1431	-	Corrections to Approved test case 8_2_1_32 based on wk31 ATS	F	5.1.0	5.2.0	R5s050333
RP-29	RP-050532	1432	-	Corrections to Approved test case 8_2_6_42 based on wk31 ATS	F	5.1.0	5.2.0	R5s050335
RP-29	RP-050532	1433	-	Corrections to Approved test case 8_2_3_30 based on wk31 ATS	F	5.1.0	5.2.0	R5s050343
RP-29	RP-050532	1434	-	Corrections to Approved Testcase 8_2_1_28 based on wk31 ATS	F	5.1.0	5.2.0	R5s050297
RP-29	RP-050532	1435	-	Corrections to Approved Testcase 8_2_2_38 based on wk31 ATS	F	5.1.0	5.2.0	R5s050299
RP-29	RP-050532	1436	-	Corrections to Approved Testcase 8_2_3_30 based on wk31 ATS	F	5.1.0	5.2.0	R5s050301
RP-29	RP-050532	1437	-	Corrections to Approved Testcase 8_2_4_36 based on wk31 ATS	F	5.1.0	5.2.0	R5s050303
RP-29	RP-050532	1438	-	Corrections to Approved Testcase 8_3_1_32 based on wk31 ATS	F	5.1.0	5.2.0	R5s050305
RP-29	RP-050562	1439	-	Add new verified and e-mail agreed TTCN test cases in the TC lists in 34.123-3 (prose), Annex A.	F	5.1.0	5.2.0	-
RP-29	RP-050526	1440	-	Clarifying L2 Tests - Update TSOs and PIXITs – New configurations for WI-13/14 TCs	F	5.1.0	5.2.0	R5-051510
RP-30	RP-050713	1441	-	CR to 34.123-3: Add new verified and e-mail agreed TTCN test cases in the TC lists in 34.123-3 (prose), Annex A	F	5.2.0	5.3.0	-
RP-30	RP-050766	1442	-	Addition of GCF WI-015 AGPS test case 17.2.4.7 to AGPS ATS V5.2.0	B	5.2.0	5.3.0	R5s050480
RP-30	RP-050766	1443	-	Addition of GCF WI-015 AGPS test case 17.2.4.6 to AGPS ATS V5.2.0	B	5.2.0	5.3.0	R5s050478
RP-30	RP-050766	1444	-	Addition of GCF WI-015 AGPS test case 17.2.4.10 to AGPS ATS V5.2.0	B	5.2.0	5.3.0	R5s050476
RP-30	RP-050766	1445	-	Addition of GCF WI-015 AGPS test case 17.2.4.3 to RLC ATS V5.1.0	B	5.2.0	5.3.0	R5s050419
RP-30	RP-050766	1446	-	Addition of GCF WI-015 AGPS test case 17.2.4.1 to RLC ATS V5.1.0	B	5.2.0	5.3.0	R5s050410
RP-30	RP-050768	1447	-	Addition of GCF WI-14/2 test case 8.2.3.32 to HS_ENH ATS V5.2.0 (Revision of R5s050451)	B	5.2.0	5.3.0	R5s050495
RP-30	RP-050768	1448	-	Addition of GCF WI-14/2 test case 8.2.3.34 to HS_ENH ATS V5.2.0	B	5.2.0	5.3.0	R5s050449
RP-30	RP-050768	1449	-	Addition of GCF WI-014 test case 8.2.2.41 to HS_ENH ATS V5.2.0 (Revision of R5s050455)	B	5.2.0	5.3.0	R5s050466
RP-30	RP-050768	1450	-	Addition of GCF WI-014 RAB test case 14.6.3a to HS_ENH ATS V5.2.0	B	5.2.0	5.3.0	R5s050464
RP-30	RP-050768	1451	-	Addition of GCF WI-014 RAB test case 14.6.3 to HS_ENH ATS V5.2.0	B	5.2.0	5.3.0	R5s050462
RP-30	RP-050768	1452	-	Addition of GCF WI-014 test case 8.3.4.9 to HS_ENH ATS V5.2.0	B	5.2.0	5.3.0	R5s050457
RP-30	RP-050768	1453	-	Addition of GCF WI-014 test case 8.2.3.31 to HS_ENH ATS V5.2.0	B	5.2.0	5.3.0	R5s050444
RP-30	RP-050768	1454	-	Addition of GCF WI-014 RAB test case 14.6.2 to HS_ENH ATS V5.1.0	B	5.2.0	5.3.0	R5s050424
RP-30	RP-050768	1455	-	Additional Changes to GCF WI-014 test case 8.3.1.37	B	5.2.0	5.3.0	R5s050421
RP-30	RP-050768	1456	-	Addition of GCF WI-014 test case 8.3.11.10 to RRC ATS V5.1.0	B	5.2.0	5.3.0	R5s050412
RP-30	RP-050768	1457	-	Addition of GCF WI-014 test case 8.2.3.35 to HS_ENH ATS V5.1.0	B	5.2.0	5.3.0	R5s050407
RP-30	RP-050768	1458	-	Addition of GCF WI-14/2 test case 8.2.6.46 to HS_ENH ATS V5.1.0	B	5.2.0	5.3.0	R5s050405
RP-30	RP-050768	1459	-	Addition of GCF WI-14/2 test case 8.2.6.41 to HS_ENH ATS V5.1.0	B	5.2.0	5.3.0	R5s050403
RP-30	RP-050768	1460	-	Addition of GCF WI-14/2 test case 8.3.1.36 to HS_ENH ATS V5.1.0	B	5.2.0	5.3.0	R5s050385
RP-30	RP-050768	1461	-	Addition of RRC GCF WI-14 test case 7.1.5.6 to RRC ATS v5.1.0	B	5.2.0	5.3.0	R5s050379
RP-30	RP-050775	1462	-	Addition of BMC GCF WI-10/3 test case 14.4.4 to RAB ATS V5.1.0	B	5.2.0	5.3.0	R5s050401
RP-30	RP-050775	1463	-	Revision of R5s050442 - Addition of GCF WI-10 Idle Mode Test Case 6.1.1.4 to RRC ATS 5.2.0	B	5.2.0	5.3.0	R5s050453
RP-30	RP-050775	1464	-	Addition of NAS GCF WI-12 test case 9.4.3.3 to NAS ATS V5.1.0	B	5.2.0	5.3.0	R5s050416
RP-30	RP-050775	1465	-	Addition of Cell Broadcast GCF WI-12 test case 16.3 to SMS ATS V5.1.0	B	5.2.0	5.3.0	R5s050399

Meeting	TSG doc	CR	Rev	Subject	Cat	Old vers	New vers	WG doc
RP-30	RP-050775	1466	-	Addition of NAS GCF WI-10 P4 test case 12.9.12 to NAS ATS V5.1.0	B	5.2.0	5.3.0	R5s050395
RP-30	RP-050775	1467	-	Addition of NAS GCF WI-12 test case 9.4.2.4 proc 4 to NAS ATS V5.1.0	B	5.2.0	5.3.0	R5s050231
RP-30	RP-050778	1468	-	Addition of GCF WI-013 RRC test case 8.1.2.15 to HS_ENH ATS V5.2.0	B	5.2.0	5.3.0	R5s050473
RP-30	RP-050778	1469	-	Addition of GCF WI-013 RRC test case 8.1.2.14 to HS_ENH ATS V5.2.0	B	5.2.0	5.3.0	R5s050471
RP-30	RP-050778	1470	-	Addition of GCF WI-013 test case 8.3.11.13 to HS_ENH_r5 ATS V5.2.0.	B	5.2.0	5.3.0	R5s050437
RP-30	RP-050778	1471	-	Addition of GCF WI-13 RRC test case 8.1.6.5 to HS_ENH ATS V5.2.0	B	5.2.0	5.3.0	R5s050497
RP-30	RP-050778	1472	-	Addition of GCF WI-013 RRC test case 8.3.1.40 to HS_ENH ATS V5.2.0	B	5.2.0	5.3.0	R5s050500
RP-30	RP-050768	1473	-	Removal of use of deprecated alternative value in RRC Connection Release message (Cell DCH) in HS_ENH suite	F	5.2.0	5.3.0	R5s050487
RP-30	RP-050768	1474	-	Removal of use of deprecated alternative value in RRC Connection Setup message (Cell FACH) in HS_ENH suite	F	5.2.0	5.3.0	R5s050489
RP-30	RP-050768	1475	-	Correction to GCF WI-14/2 HSDPA RRC test case 8.3.1.37	F	5.2.0	5.3.0	R5s050492
RP-30	RP-050768	1476	-	Additional changes required for addition of GCF WI-014 test case 8.3.11.10 to RRC ATS V5.2.0.	F	5.2.0	5.3.0	R5s050460
RP-30	RP-050768	1477	-	Correction to GCF WI-14/2 test case 8.3.1.36	F	5.2.0	5.3.0	R5s050439
RP-30	RP-050768	1478	-	Corrections to GCF WI-014/1 test cases 8.3.1.34	F	5.2.0	5.3.0	R5s050427
RP-30	RP-050768	1479	-	Correction to RRC HSDPA test case 8.2.2.40	F	5.2.0	5.3.0	R5s050431
RP-30	RP-050773	1480	-	Removal of use of deprecated alternative value in RRC Connection Release message (Cell DCH) in all GCF WI-10 and WI-12 test suites	F	5.2.0	5.3.0	R5s050488
RP-30	RP-050773	1481	-	Correction to GCF WI-12 RRC test case 8.4.1.6	F	5.2.0	5.3.0	R5s050486
RP-30	RP-050773	1482	-	Corrections to RLC test cases to add check for the PIXIT px_CipheringOnOff	F	5.2.0	5.3.0	R5s050485
RP-30	RP-050773	1483	-	Removal of use of deprecated alternative value in RRC Connection Setup message (Cell FACH) in all GCF WI-10 and WI-12 test suites	F	5.2.0	5.3.0	R5s050490
RP-30	RP-050773	1484	-	Correction to the GCF WI-10 NAS test case 12.2.1.2	F	5.2.0	5.3.0	R5s050491
RP-30	RP-050773	1485	-	Correction to GCF WI-10 MAC test case 7.1.2.3.1	F	5.2.0	5.3.0	R5s050494
RP-30	RP-050773	1486	-	Correction to GCF WI-10 Idle Mode Test Case 6.1.2.1	F	5.2.0	5.3.0	R5s050469
RP-30	RP-050773	1487	-	Corrections required to GCF WI-10 approved test case 8.3.1.18	F	5.2.0	5.3.0	R5s050448
RP-30	RP-050773	1488	-	Corrections required to GCF WI-14 approved HSDPA test cases	F	5.2.0	5.3.0	R5s050435
RP-30	RP-050773	1489	-	TTCN correction to RRC TC 8.2.4.1	F	5.2.0	5.3.0	R5s050436
RP-30	RP-050773	1490	-	Corrections required to GCF W-10 approved test case 8.4.1.40	F	5.2.0	5.3.0	R5s050434
RP-30	RP-050773	1491	-	Correction to the NAS Test Case 12.9.7a	F	5.2.0	5.3.0	R5s050429
RP-30	RP-050773	1492	-	Correction to the IR_U Test Case 8.3.7.3	F	5.2.0	5.3.0	R5s050430
RP-30	RP-050773	1493	-	Correction to MultiRAB Test Cases	F	5.2.0	5.3.0	R5s050432
RP-30	RP-050773	1494	-	Correction to GCF WI-10/2 RRC test case 8.3.1.21	F	5.2.0	5.3.0	R5s050426
RP-30	RP-050773	1495	-	Summary of regression errors in the wk38 ATS	F	5.2.0	5.3.0	R5s050428
RP-30	RP-050773	1496	-	Summary of regression errors in wk38 of RRC ATS	F	5.2.0	5.3.0	R5s050414
RP-30	RP-050773	1497	-	Correction in TTCN for test case 7.2.3.19	F	5.2.0	5.3.0	R5s050415
RP-30	RP-050773	1498	-	Regression Error report based on wk36 ATS	F	5.2.0	5.3.0	R5s050409
RP-30	RP-050773	1499	-	Summary of regression results for wk36 version of IR_U ATS V5.1.0	F	5.2.0	5.3.0	R5s050384
RP-30	RP-050774	1500	-	Corrections required to GCF WI-10 approved test cases 6.2.1.7 and 6.2.1.8	F	5.2.0	5.3.0	R5s050394
RP-30	RP-050774	1501	-	Corrections required to GCF WI-10 approved test cases 8.3.7.5, 8.3.7.7 and 8.3.7.12	F	5.2.0	5.3.0	R5s050397
RP-30	RP-050774	1502	-	Correction to teststep ts_RRC_NAS_SessionActPS_MO_DCH_ToFACH.	F	5.2.0	5.3.0	R5s050390
RP-30	RP-050774	1503	-	Correction to GCF WI-10/4 RRC test case 8.1.3.9	F	5.2.0	5.3.0	R5s050378
RP-30	RP-050774	1504	-	Summary of regression errors in the wk36 ATS	F	5.2.0	5.3.0	R5s050391
RP-30	RP-050774	1505	-	Summary of regression errors in the wk36 IR_U ATS.	F	5.2.0	5.3.0	R5s050392
RP-30	RP-050774	1506	-	Correction to HS_ENH_wk36 – Regression errors	F	5.2.0	5.3.0	R5s050389
RP-30	RP-050774	1507	-	Correction to GCF WI-12 RRC test case 8.4.1.6	F	5.2.0	5.3.0	R5s050376
RP-30	RP-050774	1508	-	Correction to Inter-RAT IR_U test case 8.3.11.4	F	5.2.0	5.3.0	R5s050377
RP-30	RP-050774	1509	-	Correction to generic procedure C.1 (Idle mode check)	F	5.2.0	5.3.0	R5s050375
RP-30	RP-050774	1510	-	Summary of regression errors in the wk31 ATS	F	5.2.0	5.3.0	R5s050367
RP-30	RP-050774	1511	-	Correction to the test case 14.2.43.1	F	5.2.0	5.3.0	R5s050368

Meeting	TSG doc	CR	Rev	Subject	Cat	Old vers	New vers	WG doc
RP-30	RP-050774	1512	-	Correction to the NAS Test Case 12.9.13	F	5.2.0	5.3.0	R5s050374
RP-30	RP-050774	1513	-	Correction to all approved Test Cases using ciphering	F	5.2.0	5.3.0	R5s050373
RP-30	RP-050774	1514	-	Corrections required for approved GCF WI-10 RRC test cases 8.3.1.21 and 8.3.2.11	F	5.2.0	5.3.0	R5s050369
RP-30	RP-050774	1515	-	Corrections required for approved GCF WI-10 NAS test cases 9.4.2.3 and 9.4.2.5	F	5.2.0	5.3.0	R5s050370
RP-30	RP-050774	1516	-	Summary of regression errors in the wk31 ATS Batch 2.	F	5.2.0	5.3.0	R5s050372
RP-30	RP-050774	1517	-	Correction to GCF WI-010 test case 6.1.2.1 for manual attach UE	F	5.2.0	5.3.0	R5s050366
RP-30	RP-050774	1518	-	Correction to agreed testcase 8.2.6.8	F	5.2.0	5.3.0	R5s050357
RP-30	RP-050774	1519	-	Correction to agreed IR_U_wk31 MRAT testcases 8.3.9.1 and 8.3.9.5	F	5.2.0	5.3.0	R5s050358
RP-30	RP-050775	1520	-	Correction to P1 NAS Test Case 11.3.1 for AT command confirmation	F	5.2.0	5.3.0	R5s050359
RP-30	RP-050775	1521	-	Correction of the NAS Test Case 12.9.14	F	5.2.0	5.3.0	R5s050362
RP-30	RP-050775	1522	-	Correction to the test step ts_RRC_ReceiverRB_RelCmpl	F	5.2.0	5.3.0	R5s050363
RP-30	RP-050775	1523	-	Corrections required for QOS constraint in R99 ATS	F	5.2.0	5.3.0	R5s050364
RP-30	RP-050775	1524	-	Corrections required for QOS constraint in HSDPA/Rel-5 enhancement ATS	F	5.2.0	5.3.0	R5s050365
RP-30	RP-050775	1525	-	Summary of regression errors in the wk42 ATS.	F	5.2.0	5.3.0	R5s050499
RP-30	RP-050775	1526	-	Correction to Approved RRC TC 8.3.11.1	F	5.2.0	5.3.0	R5s050459
RP-30	RP-050769	1527	-	Update PIXIT and TSO, clarifications of a TSO and an AT / MMI commands in 34.123-3	F	5.2.0	5.3.0	R5-052110
RP-30	RP-050775	1528	-	Correction to iWD_wk38 IR_U ATS	F	5.2.0	5.3.0	R5s050470
RP-31	RP-060158	1529	-	Addition of GCF WI-015 AGPS test case 17.2.2.1 to AGPS ATS V5.2.0	B	5.3.0	5.4.0	R5s050561
RP-31	RP-060158	1530	-	Addition of GCF WI-015 AGPS test case 17.2.2.2 to AGPS ATS V5.2.0	B	5.3.0	5.4.0	R5s050563
RP-31	RP-060158	1531	-	Addition of GCF WI-015 AGPS test case 17.2.2.3 to AGPS ATS V5.2.0	B	5.3.0	5.4.0	R5s050565
RP-31	RP-060158	1532	-	Addition of GCF WI-015 AGPS test case 17.2.2.4 to AGPS ATS V5.2.0	B	5.3.0	5.4.0	R5s050587
RP-31	RP-060158	1533	-	Addition of GCF WI-015 AGPS test case 17.2.3.2 to AGPS ATS V5.2.0	B	5.3.0	5.4.0	R5s050567
RP-31	RP-060158	1534	-	Addition of GCF WI-015 AGPS test case 17.2.3.3 to AGPS ATS V5.2.0	B	5.3.0	5.4.0	R5s050589
RP-31	RP-060158	1535	-	Addition of GCF WI-015 AGPS test case 17.2.3.4 to AGPS ATS V5.2.0	B	5.3.0	5.4.0	R5s050591
RP-31	RP-060158	1536	-	Addition of GCF WI-015 AGPS test case 17.2.3.8 to AGPS ATS V5.2.0	B	5.3.0	5.4.0	R5s050593
RP-31	RP-060158	1537	-	Addition of GCF WI-015 AGPS test case 17.2.3.9 to AGPS ATS V5.2.0	B	5.3.0	5.4.0	R5s050569
RP-31	RP-060158	1538	-	Addition of GCF WI-015 AGPS test case 17.2.4.2 to AGPS ATS V5.2.0	B	5.3.0	5.4.0	R5s050595
RP-31	RP-060158	1539	-	Addition of GCF WI-015 AGPS test case 17.2.4.4 to AGPS ATS V5.2.0	B	5.3.0	5.4.0	R5s050572
RP-31	RP-060158	1540	-	Addition of GCF WI-015 AGPS test case 17.2.4.5 to AGPS ATS V5.2.0	B	5.3.0	5.4.0	R5s050574
RP-31	RP-060158	1541	-	Addition of GCF WI-015 AGPS test case 17.2.4.8 to AGPS ATS V5.2.0	B	5.3.0	5.4.0	R5s050576
RP-31	RP-060158	1542	-	Addition of GCF WI-015 AGPS test case 17.2.4.9 to AGPS ATS V5.2.0	B	5.3.0	5.4.0	R5s050578
RP-31	RP-060148	1543	-	Addition of GCF WI-014 RAB test case 14.6.4 to HS_ENH ATS V5.3.0	B	5.3.0	5.4.0	R5s050604
RP-31	RP-060148	1544	-	Addition of GCF WI-014 RAB test case 14.6.4a to HS_ENH ATS V5.3.0	B	5.3.0	5.4.0	R5s050606
RP-31	RP-060148	1545	-	Addition of GCF WI-014 RAB test case 14.6.5 to HS_ENH ATS V5.3.0	B	5.3.0	5.4.0	R5s050608
RP-31	RP-060148	1546	-	Addition of GCF WI-014 RAB test case 14.6.5a to HS_ENH ATS V5.3.0	B	5.3.0	5.4.0	R5s050610
RP-31	RP-060148	1547	-	Addition of GCF WI-014/1 test case 7.1.5.2 to HS_ENH ATS V5.2.0	B	5.3.0	5.4.0	R5s050534
RP-31	RP-060148	1548	-	Addition of RRC GCF WI-14 test case 8.2.2.39 to RRC ATS v5.2.0	B	5.3.0	5.4.0	R5s050510
RP-31	RP-060148	1549	-	Addition of GCF WI-014 test case 8.2.2.42 to HS_ENH ATS V5.2.0	B	5.3.0	5.4.0	R5s050536
RP-31	RP-060148	1550	-	Addition of GCF WI-014/2 test case 8.2.3.33 to HS_ENH ATS V5.2.0	B	5.3.0	5.4.0	R5s050540
RP-31	RP-060148	1551	-	Addition of GCF WI-014 RRC test case 8.2.6.39a to HS_ENH ATS V5.2.0	B	5.3.0	5.4.0	R5s050516

Meeting	TSG doc	CR	Rev	Subject	Cat	Old vers	New vers	WG doc
RP-31	RP-060148	1552	-	Addition of GCF WI-014 RRC test case 8.2.6.39b to HS_ENH ATS V5.3.0	B	5.3.0	5.4.0	R5s050598
RP-31	RP-060148	1553	-	Addition of GCF WI 14/2 test case 8.3.7.14 to HS_ENH ATS V5.3.0	B	5.3.0	5.4.0	R5s050618
RP-31	RP-060158	1554	-	Addition of GCF WI-10/1 test case 6.1.2.2 to RRC ATS v5.2.0	B	5.3.0	5.4.0	R5s050556
RP-31	RP-060158	1555	-	Addition of RRC GCF WI-10 test case 6.1.2.3 to RRC ATS v5.3.0	B	5.3.0	5.4.0	R5s050614
RP-31	RP-060158	1556	-	Addition of GCF WI-10 Idle Mode test case 6.1.2.5	B	5.3.0	5.4.0	R5s060017
RP-31	RP-060158	1557	-	Addition of GCF WI-10 RRC test case 6.1.2.6 to RRC ATS V5.2.0	B	5.3.0	5.4.0	R5s050584
RP-31	RP-060158	1558	-	Addition of GCF WI-10/2 RRC test case 6.1.2.8 to RRC ATS V5.2.0	B	5.3.0	5.4.0	R5s050547
RP-31	RP-060158	1559	-	Addition of GCF WI-010/2 test case 6.2.2.3 to IR_U ATS V5.2.0	B	5.3.0	5.4.0	R5s050483
RP-31	RP-060158	1560	-	Addition of GCF WI-12 test case 8.4.1.48	B	5.3.0	5.4.0	R5s050612
RP-31	RP-060165	1561	-	Addition of GCF WI-13 test case 6.1.2.10	B	5.3.0	5.4.0	R5s060013
RP-31	RP-060165	1562	-	Addition of GCF WI-013 RRC test case 8.3.1.38 to HS_ENH ATS V5.3.0	B	5.3.0	5.4.0	R5s050600
RP-31	RP-060165	1563	-	Addition of GCF WI-013 RRC test case 8.3.1.39 to HS_ENH ATS V5.3.0	B	5.3.0	5.4.0	R5s050602
RP-31	RP-060149	1564	-	Summary of regression errors in the wk03 HSD_ENH ATS	F	5.3.0	5.4.0	R5s060011
RP-31	RP-060149	1565	-	Corrections to GCF WI-014 RAB testcases 14.6.4 and 14.6.4a	F	5.3.0	5.4.0	R5s060038
RP-31	RP-060149	1566	-	Corrections to Approved GCF WI-014 RRC testcases 8.2.3.33	F	5.3.0	5.4.0	R5s060035
RP-31	RP-060149	1567	-	Summary of regression errors in wk03 HSDPA ATS.	F	5.3.0	5.4.0	R5s060030
RP-31	RP-060149	1568	-	Wk49 regression errors in HS_ENH ATS	F	5.3.0	5.4.0	R5s050623
RP-31	RP-060149	1569	-	Summary of regression errors in the wk49 HS_ENH ATS	F	5.3.0	5.4.0	R5s050621
RP-31	RP-060149	1570	-	Summary of regression errors in the wk49 HS_ENH ATS	F	5.3.0	5.4.0	R5s050617
RP-31	RP-060149	1571	-	Correction to GCF WI14 test case 8.3.4.9	F	5.3.0	5.4.0	R5s050620
RP-31	RP-060149	1572	-	Summary of regression errors in the wk49 HS_ENH ATS	F	5.3.0	5.4.0	R5s050581
RP-31	RP-060149	1573	-	Correction to GCF WI14 test case 14.6.1 and 14.6.2	F	5.3.0	5.4.0	R5s050560
RP-31	RP-060149	1574	-	Summary of regression errors in the wk47 HS_ENH ATS	F	5.3.0	5.4.0	R5s050532
RP-31	RP-060149	1575	-	Summary of regression errors in the wk47 HSDPA ATS	F	5.3.0	5.4.0	R5s050550
RP-31	RP-060149	1576	-	Summary of regression errors in the HSENH_r5_wk42 ATS.	F	5.3.0	5.4.0	R5s050529
RP-31	RP-060149	1577	-	Correction to GCF WI-014/2 test case 8.2.2.41	F	5.3.0	5.4.0	R5s050525
RP-31	RP-060149	1578	-	Summary of regression errors in the wk42 HS_ENH ATS	F	5.3.0	5.4.0	R5s050513
RP-31	RP-060149	1579	-	Corrections to Testcase 8.3.1.35	F	5.3.0	5.4.0	R5s050518
RP-31	RP-060149	1580	-	Update to HS_ENH_r5 ATS to allow 64k uplink data rate to be tested for RRC Testcases.	F	5.3.0	5.4.0	R5s050519
RP-31	RP-060149	1581	-	Errors identified in RAB HSDPA testcases in wk42 ATS.	F	5.3.0	5.4.0	R5s050520
RP-31	RP-060149	1582	-	Summary of regression errors in the wk42 HSDPA ATS	F	5.3.0	5.4.0	R5s050503
RP-31	RP-060159	1583	-	Correction to GCF WI-10 test case 8.4.1.14	F	5.3.0	5.4.0	R5s050512
RP-31	RP-060159	1584	-	TTCN correction to Approved RRC TCs 8.3.4.1, 8.3.4.2 and 8.3.4.3	F	5.3.0	5.4.0	R5s060044
RP-31	RP-060159	1585	-	Summary of regression errors in wk03 RRC and RAB ATS.	F	5.3.0	5.4.0	R5s060042
RP-31	RP-060159	1586	-	Correction of GCF WI-10 RRC test case 8.4.1.2,8.4.1.24,8.4.1.25	F	5.3.0	5.4.0	R5s060043
RP-31	RP-060159	1587	-	Summary of regression errors in the wk03 GCF WI-10 and GCF WI-12 ATS	F	5.3.0	5.4.0	R5s060010
RP-31	RP-060159	1588	-	Correction to GCF WI-10 RRC Test Case 6.1.1.4	F	5.3.0	5.4.0	R5s060024
RP-31	RP-060159	1589	-	Correction to GCF WI-12 Testcase 9.4.5.4.6	F	5.3.0	5.4.0	R5s060025
RP-31	RP-060159	1590	-	Correction to GCF WI-10 NAS Test Case 12.4.1.4a	F	5.3.0	5.4.0	R5s060040
RP-31	RP-060159	1591	-	Correction of GCF WI-10 RRC test case 8.1.7.1d	F	5.3.0	5.4.0	R5s060039
RP-31	RP-060159	1592	-	Corrections to approved GCF WI-12/1 Inter-RAT test case 8.4.1.48	F	5.3.0	5.4.0	R5s060029
RP-31	RP-060159	1593	-	Corrections to approved GCF WI-10/3 InterRAT test case 8.4.1.31	F	5.3.0	5.4.0	R5s060028
RP-31	RP-060159	1594	-	Corrections to GCF WI-012 GMM testcase 12.9.9	F	5.3.0	5.4.0	R5s060037

Meeting	TSG doc	CR	Rev	Subject	Cat	Old vers	New vers	WG doc
RP-31	RP-060159	1595	-	Corrections to Approved GCF WI-012 RRC testcases 8.2.1.24 & 8.2.1.34	F	5.3.0	5.4.0	R5s060036
RP-31	RP-060159	1596	-	Correction of GCF WI-10 RRC test case 8.4.1.26	F	5.3.0	5.4.0	R5s060033
RP-31	RP-060159	1597	-	Correction of GCF WI-12 MM test case 9.4.3.3	F	5.3.0	5.4.0	R5s060032
RP-31	RP-060159	1598	-	Summary of regression errors in wk49 ATS.	F	5.3.0	5.4.0	R5s060009
RP-31	RP-060159	1599	-	Correction to GCF WI-12 RLC Test Case 7.2.3.35	F	5.3.0	5.4.0	R5s060008
RP-31	RP-060159	1600	-	Correction to GCF WI-10 test case 6.1.2.9	F	5.3.0	5.4.0	R5s060007
RP-31	RP-060159	1601	-	Correction to GCF WI-10 test case 8.1.3.9	F	5.3.0	5.4.0	R5s060003
RP-31	RP-060159	1602	-	Summary of regression errors in the wk49 IR_U ATS.	F	5.3.0	5.4.0	R5s060006
RP-31	RP-060160	1603	-	Summary of regression errors in the wk47 ATS.	F	5.3.0	5.4.0	R5s050551
RP-31	RP-060160	1604	-	TTCN correction to Approved GMM TC 12.4.2.4	F	5.3.0	5.4.0	R5s060004
RP-31	RP-060160	1605	-	Corrections to GCF WI-012 approved testcases 9.4.3.3	F	5.3.0	5.4.0	R5s060002
RP-31	RP-060160	1606	-	Correction to GCF WI-10 RRC Test Case 8.1.7.1c	F	5.3.0	5.4.0	R5s060001
RP-31	RP-060160	1607	-	TTCN Correction for GCF WI-10 RRC test case 6.1.2.8	F	5.3.0	5.4.0	R5s050586
RP-31	RP-060160	1608	-	TTCN correction to Approved IRAT TCs 8.3.7.1, 8.3.7.2, 8.3.7.3, 8.3.7.4, 8.3.7.13, 8.3.7.16 and 8.3.11.1 .	F	5.3.0	5.4.0	R5s050622
RP-31	RP-060160	1609	-	Correction to approved RRC test cases 8.1.6.3, 8.4.1.1, 8.4.1.3 and 8.4.1.29 on Wk49 ATS	F	5.3.0	5.4.0	R5s050571
RP-31	RP-060160	1610	-	Correction to GCF WI 10 RLC testcase 7.2.2.2	F	5.3.0	5.4.0	R5s050583
RP-31	RP-060160	1611	-	Summary of regression errors in the wk49 GCF WI-10 and GCF WI-12 ATS	F	5.3.0	5.4.0	R5s050580
RP-31	RP-060160	1612	-	Corrections to approved GCF WI-010 / GCF WI-012 test cases 14.2.51b.1 and 14.2.58a	F	5.3.0	5.4.0	R5s050597
RP-31	RP-060160	1613	-	TTCN correction to Approved IRAT TC 8.3.7.16	F	5.3.0	5.4.0	R5s050552
RP-31	RP-060160	1614	-	Correction to GCF WI-10 approved RRC Test Case 8.1.7.1d	F	5.3.0	5.4.0	R5s050582
RP-31	RP-060160	1615	-	Correction to GCF Test Case 8.4.1.2, 8.4.1.24, 8.4.1.25, 8.4.1.6, 8.4.1.8 and HSDPA Test Cases	F	5.3.0	5.4.0	R5s050545
RP-31	RP-060160	1616	-	Summary of regression errors in the wk47 GCF WI-10 and GCF WI-12 ATS	F	5.3.0	5.4.0	R5s050533
RP-31	RP-060160	1617	-	Correction to the GCF WI 10 testcase 7.2.3.13	F	5.3.0	5.4.0	R5s050538
RP-31	RP-060160	1618	-	Correction to GCF WI 10 MAC test case 7.1.2.3.1	F	5.3.0	5.4.0	R5s050539
RP-31	RP-060160	1619	-	Correction to IR_U test cases 8.3.7.1, 8.3.7.2, 8.3.7.3, 8.3.7.12 and 8.3.7.16	F	5.3.0	5.4.0	R5s050493
RP-31	RP-060160	1620	-	Correction to GCF WI 10 test case 7.1.2.4a	F	5.3.0	5.4.0	R5s050555
RP-31	RP-060160	1621	-	Corrections to GCF WI-012 approved test case 16.3	F	5.3.0	5.4.0	R5s050554
RP-31	RP-060160	1622	-	Correction to approved GCF WI-010 Test Case 16.1.1	F	5.3.0	5.4.0	R5s050549
RP-31	RP-060161	1623	-	TTCN correction to Approved RRC TC 8.1.2.7	F	5.3.0	5.4.0	R5s050553
RP-31	RP-060161	1624	-	Correction to GCF WI-10 RRC Test Case 8.3.1.18	F	5.3.0	5.4.0	R5s050543
RP-31	RP-060161	1625	-	Correction to GCF WI-10 RRC Test Case 8.1.1.9	F	5.3.0	5.4.0	R5s050544
RP-31	RP-060161	1626	-	Correction to GCF WI-12 test case 8.1.6.3	F	5.3.0	5.4.0	R5s050531
RP-31	RP-060161	1627	-	Summary of regression errors in the wk42 ATS.	F	5.3.0	5.4.0	R5s050528
RP-31	RP-060161	1628	-	Correction to GCF WI-10/3 Testcase 12.4.2.4	F	5.3.0	5.4.0	R5s050505
RP-31	RP-060161	1629	-	Correction to test step ts_Exit_Testcase used in MultiRAB test cases	F	5.3.0	5.4.0	R5s050514
RP-31	RP-060161	1630	-	Correction to GCF WI-010/1 test case 7.1.2.4a	F	5.3.0	5.4.0	R5s050524
RP-31	RP-060161	1631	-	Correction to the GCF WI 12 NAS Test Case 9.4.3.3	F	5.3.0	5.4.0	R5s050515
RP-31	RP-060161	1632	-	Correction to GCF WI 10 and GCF WI 12 ATS to support IPv6 format for PDP Context	F	5.3.0	5.4.0	R5s050521
RP-31	RP-060161	1633	-	Summary of regression errors in the wk42 GCF WI-10 and GCF WI-12 ATS	F	5.3.0	5.4.0	R5s050482
RP-31	RP-060161	1634	-	Correction to GCF WI-13 test case 8.1.2.14	F	5.3.0	5.4.0	R5s050526
RP-31	RP-060161	1635	-	Correction to GCF WI-13 test case 8.1.2.15	F	5.3.0	5.4.0	R5s050527
RP-31	RP-060161	1636	-	Correction to GCF WI-12 test case 9.4.3.3	F	5.3.0	5.4.0	R5s050509
RP-31	RP-060161	1637	-	Correction to GCF WI-10 test case 8.1.3.9	F	5.3.0	5.4.0	R5s050507
RP-31	RP-060161	1638	-	Corrections of TC_16_2_1, TC_16_2_2, TC_16_1_9_1, TC_16_1_9_2	F	5.3.0	5.4.0	R5s050506
RP-31	RP-060161	1639	-	Correction to GCF WI-10 RAB Test Case 14.2.38c	F	5.3.0	5.4.0	R5s050504
RP-31	RP-060165	1640	-	Correction to GCF WI 13/1 RRC testcases 8.3.1.38 and 8.3.1.39	F	5.3.0	5.4.0	R5s060023
RP-31	RP-060165	1641	-	Corrections to Approved GCF WI-013 RRC testcase 8_1_2_14 & WI-014 RRC testcase 8_2_2_42	F	5.3.0	5.4.0	R5s060034
RP-31	RP-060165	1642	-	Summary of regression errors in wk03 HSDPA ATS (GCF WI-13).	F	5.3.0	5.4.0	R5s060031
RP-31	RP-060165	1643	-	Corrections to GCF WI-013 test cases 8.1.6.5 and 8.3.1.40	F	5.3.0	5.4.0	R5s050523
RP-31	RP-060165	1644	-	Correction to Rel-5 (HSENH) ATS to support IPv6 format for PDP Context.	F	5.3.0	5.4.0	R5s050522

Meeting	TSG doc	CR	Rev	Subject	Cat	Old vers	New vers	WG doc
RP-31	RP-060162	1645	-	Add new verified and e-mail agreed TTCN test cases in the TC lists in 34.123-3 (prose), Annex A	F	5.3.0	5.4.0	-
RP-31	RP-060166	1646	-	Introduce ASP for HSUPA in 34.123-3	B	5.3.0	5.4.0	R5-060560
RP-31	RP-060147	1647	-	Introduce ASP for HSDPA of LCR TDD	B	5.3.0	5.4.0	R5-060317
RP-31	RP-060147	1648	-	Updating Information in section 8.2.4 (Table 35)	F	5.3.0	5.4.0	R5-060287
RP-31	RP-060154	1649	-	Correction of default value for IXIT parameter 'px_CipherAlg'.	F	5.3.0	5.4.0	R5-060178
RP-31	RP-060154	1650	-	New ASP for DTM and other corrections in 34.123-3 – Release 99	F	5.3.0	5.4.0	R5-060505
RP-31	RP-060164	1651	-	Update configurations, introduce frequency band indicator for SS in 34.123-3 - Release 5.	F	5.3.0	5.4.0	R5-060316
RP-32	RP-060338	1652	-	Update HSDPA test configuration	F	5.4.0	5.5.0	R5-061004
RP-32	RP-060338	1653	-	Change of ASP and IEs for LCR TDD	F	5.4.0	5.5.0	R5-061300
RP-32	RP-060333	1654	-	Update E-DCH test model and ASP (CR to 34.123-3)	F	5.4.0	5.5.0	R5-061285
RP-32	RP-060324	1655	-	Update PIXIT	F	5.4.0	5.5.0	R5-061003
RP-32	RP-060324	1656	-	Correction to ASP CPHY_TFCI_Detected_IND	F	5.4.0	5.5.0	R5-061377
RP-32	RP-060321	1657	-	CR to 34.123-3: Add new verified and e-mail agreed TTCN test cases in the TC lists in 34.123-3 (prose), Annex A	F	5.4.0	5.5.0	-
RP-32	RP-060339	1658	-	Addition of GCF WI14 test case 8.2.6.48 to HSD_ENH ATS V5.4.0	B	5.4.0	5.5.0	R5s060139
RP-32	RP-060327	1659	-	Addition of GCF WI-12 test case 8.3.4.8	B	5.4.0	5.5.0	R5s060019
RP-32	RP-060327	1660	-	Addition of GCF WI12 RRC test case 8.2.2.43 to RRC ATS v5.3.0	B	5.4.0	5.5.0	R5s060084
RP-32	RP-060327	1661	-	Addition of GCF WI12 RRC test case 8.2.6.39 to RRC ATS v5.4.0 (Revision of R5s060076)	B	5.4.0	5.5.0	R5s060080
RP-32	RP-060327	1662	-	Addition of GCF WI12 RRC test case 8.2.6.44 to RRC ATS v5.4.0 (Revision of R5s060078)	B	5.4.0	5.5.0	R5s060082
RP-32	RP-060327	1663	-	Addition of GCF WI-10 MM test case 9.4.5.4.1	B	5.4.0	5.5.0	R5s060066
RP-32	RP-060330	1664	-	Addition of GCF WI-13 RRC test case 8.4.1.47 to HSD_ENH ATS v5.3.0	B	5.4.0	5.5.0	R5s060070
RP-32	RP-060330	1665	-	Addition of GCF WI13 Inter-RAT cell change order from UTRAN test case 8.3.11.12 to HSD_ENH ATS v5.4.0 (Revision of R5s060092)	B	5.4.0	5.5.0	R5s060094
RP-32	RP-060339	1666	-	Correction to GCF WI14 RAB test case 14_6_1, 14_6_2, 14_6_3, 14_6_3a, 14_6_4, 14_6_4a, 14_6_5, 14_6_5a	F	5.4.0	5.5.0	R5s060059
RP-32	RP-060339	1667	-	Correction to GCF WI14 test case 8_3_1_34 and 8_3_1_36	F	5.4.0	5.5.0	R5s060061
RP-32	RP-060339	1668	-	Change of the relative channel powers for HS-PDSCH and HS-SCCH	F	5.4.0	5.5.0	R5s060074
RP-32	RP-060339	1669	-	Corrections to RAB testcase 14.6.3a	F	5.4.0	5.5.0	R5s060121
RP-32	RP-060339	1670	-	Correction to teststep ts_RRC_MultiCallEstPS_MO_HSDPA, ts_RRC_NAS_SessionActPS_MO_P9_P10_HS	F	5.4.0	5.5.0	R5s060114
RP-32	RP-060339	1671	-	Corrections to GCF WI 14 RRC test case 8.2.3.34	F	5.4.0	5.5.0	R5s060115
RP-32	RP-060330	1672	-	Revised summary of regression errors in IR_U and HSD_ENH_R5 ATS (wk03, 2006)	F	5.4.0	5.5.0	R5s060088
RP-32	RP-060330	1673	-	Correction to GCF WI13 test case 6.1.2.10	F	5.4.0	5.5.0	R5s060075
RP-32	RP-060330	1674	-	Correction to GCF WI-13 Idle Mode test case 6.1.2.10	F	5.4.0	5.5.0	R5s060089
RP-32	RP-060330	1675	-	Corrections to Approved GCF WI-013 RRC testcases 8.4.1.47	F	5.4.0	5.5.0	R5s060135
RP-32	RP-060330	1676	-	Additional CR for agreed TC 8.3.11.12 (8.3.11.13 implicitly affected)	F	5.4.0	5.5.0	R5s060118
RP-32	RP-060325	1677	-	Correction to GCF WI-10 RRC Test Case 6.2.2.2	F	5.4.0	5.5.0	R5s060050
RP-32	RP-060325	1678	-	Correction of GCF WI-10 test case 8.4.1.5	F	5.4.0	5.5.0	R5s060049
RP-32	RP-060325	1679	-	Summary of regression errors in the wk06 ATS.	F	5.4.0	5.5.0	R5s060056
RP-32	RP-060325	1680	-	Corrections to Security procedure to make UL SRB3 ciphering preconfiguration optional	F	5.4.0	5.5.0	R5s060057
RP-32	RP-060325	1681	-	Summary of regression errors in the wk06 GCF WI-10 and GCF WI-12 ATS	F	5.4.0	5.5.0	R5s060047
RP-32	RP-060325	1682	-	Correction to the test step ts_DownlinkTBFEstablishment	F	5.4.0	5.5.0	R5s060060
RP-32	RP-060325	1683	-	Change to expected value of Qos "DeliveryOrder" IE.	F	5.4.0	5.5.0	R5s060058
RP-32	RP-060325	1684	-	Clarification of the usage of 4 PICS parameters	F	5.4.0	5.5.0	R5s060053
RP-32	RP-060325	1685	-	Correction to approved GCF WI-10/2 InterRAT test case 6.2.2.2	F	5.4.0	5.5.0	R5s060055
RP-32	RP-060325	1686	-	Correction to approved GCF WI-10/2 InterRAT test case 6.2.2.1	F	5.4.0	5.5.0	R5s060054
RP-32	RP-060325	1687	-	Corrections to IRU Measurement test cases for handling of UL only and DL only compressed mode branches	F	5.4.0	5.5.0	R5s060051

Meeting	TSG doc	CR	Rev	Subject	Cat	Old vers	New vers	WG doc
RP-32	RP-060325	1688	-	Generic correction to test step 'ts_MM_IMSI_Detach'	F	5.4.0	5.5.0	R5s060069
RP-32	RP-060325	1689	-	Correction to GCF WI-12 RAB Test Case 14.2.9	F	5.4.0	5.5.0	R5s060068
RP-32	RP-060325	1690	-	Summary of regression errors in the wk09 GCF WI-10 and GCF WI-12 ATS	F	5.4.0	5.5.0	R5s060073
RP-32	RP-060325	1691	-	Corrections to GCF WI-10 IR_U test case 6.2.1.7 and 6.2.1.8	F	5.4.0	5.5.0	R5s060072
RP-32	RP-060325	1692	-	Correction to RRC test cases 8.1.1.1 and 8.1.1.9	F	5.4.0	5.5.0	R5s060086
RP-32	RP-060325	1693	-	Correction to WI10 Idle Mode test case 6.1.2.6	F	5.4.0	5.5.0	R5s060087
RP-32	RP-060325	1694	-	Correction to the IR_U test case 6.2.2.3	F	5.4.0	5.5.0	R5s060091
RP-32	RP-060325	1695	-	Correction to SM GCF WI 10 test case 11.3.1	F	5.4.0	5.5.0	R5s060090
RP-32	RP-060325	1696	-	Correction to GCF WI-12 Testcase 9.4.3.3	F	5.4.0	5.5.0	R5s060101
RP-32	RP-060326	1697	-	Correction to GCF WI-12 Testcase 9.4.5.4.6	F	5.4.0	5.5.0	R5s060102
RP-32	RP-060326	1698	-	Correction to GCF WI-10 Testcase 8.1.7.1c	F	5.4.0	5.5.0	R5s060103
RP-32	RP-060326	1699	-	Correction to GCF WI-15 Test Cases	F	5.4.0	5.5.0	R5s060104
RP-32	RP-060326	1700	-	TTCN correction to Approved RRC TCs 8.3.4.1, 8.3.4.2 and 8.3.4.3	F	5.4.0	5.5.0	R5s060096
RP-32	RP-060326	1701	-	TTCN correction to Approved RRC TC 8.4.1.14	F	5.4.0	5.5.0	R5s060095
RP-32	RP-060326	1702	-	Correction of approved IR_U test case 8.3.11.1.	F	5.4.0	5.5.0	R5s060097
RP-32	RP-060326	1703	-	Correction of approved HSD_ENH_R5 test cases 8.3.11.9, 8.3.11.13 and of 8.3.11.12 (under approval).	F	5.4.0	5.5.0	R5s060098
RP-32	RP-060326	1704	-	Correction to GCF WI-10 GMM test case 12.4.2.4	F	5.4.0	5.5.0	R5s060110
RP-32	RP-060326	1705	-	Correction in TTCN for RLC Test cases 7.2.3.21, 7.2.3.22 and 7.2.3.24	F	5.4.0	5.5.0	R5s060109
RP-32	RP-060326	1706	-	Correction to RRC GCF WI 12 test case 8.3.1.30	F	5.4.0	5.5.0	R5s060106
RP-32	RP-060326	1707	-	Corrections to RAB testcase 14.2.41	F	5.4.0	5.5.0	R5s060120
RP-32	RP-060326	1708	-	Correction to GCF WI-10 RRC Test Case 8.1.1.9	F	5.4.0	5.5.0	R5s060119
RP-32	RP-060326	1709	-	Correction to the constraints used for the Radio Bearer Reconfiguration Message	F	5.4.0	5.5.0	R5s060113
RP-32	RP-060326	1710	-	Correction to RRC test cases 8.3.1.21 and 8.3.2.11	F	5.4.0	5.5.0	R5s060112
RP-32	RP-060326	1711	-	Summary of regression errors in the wk11 ATS.	F	5.4.0	5.5.0	R5s060111
RP-32	RP-060326	1712	-	Corrections to TTCN test cases due to the review of 34.123-2 and, related, the implementation of test case selection expressions in the TTCN.	F	5.4.0	5.5.0	R5s060116
RP-32	RP-060326	1713	-	Empty all PCOs when TC begins	F	5.4.0	5.5.0	R5s060064
RP-32	RP-060326	1714	-	Correction to QOS parameters for UMTS only mobiles	F	5.4.0	5.5.0	R5s060041
RP-32	RP-060326	1715	-	Correction to GCF Test Case 8.4.1.25	F	5.4.0	5.5.0	R5s060141
RP-32	RP-060326	1716	-	Correction to GCF WI-10 Testcase 7.2.3.21	F	5.4.0	5.5.0	R5s060126
RP-32	RP-060327	1717	-	Correction to GCF WI-12 Testcase 9.4.3.3	F	5.4.0	5.5.0	R5s060127
RP-32	RP-060327	1718	-	Correction to GCF WI-10 IR-U Test Case 6.2.2.3	F	5.4.0	5.5.0	R5s060128
RP-32	RP-060327	1719	-	Correction to the RRC test case 6.1.2.8	F	5.4.0	5.5.0	R5s060123
RP-32	RP-060327	1720	-	Correction to GCF WI-12 NAS Test Case 9.4.3.3	F	5.4.0	5.5.0	R5s060122
RP-32	RP-060327	1721	-	Correction to GCF WI-10 SMS Test Case 16.x	F	5.4.0	5.5.0	R5s060136
RP-32	RP-060327	1722	-	Correction to the IR_U test case 8.3.11.1	F	5.4.0	5.5.0	R5s060130
RP-32	RP-060327	1723	-	Correction to the approved IR_U test cases 8.3.7.1 and 8.3.7.3	F	5.4.0	5.5.0	R5s060131
RP-32	RP-060327	1724	-	Correction to the GCF WI-12 test case 8.4.1.48	F	5.4.0	5.5.0	R5s060134
RP-32	RP-060327	1725	-	Correction to the common security teststeps to add the default test step	F	5.4.0	5.5.0	R5s060133
RP-32	RP-060327	1726	-	Correction to Cell Broadcast test case 16.3	F	5.4.0	5.5.0	R5s060125
RP-32	RP-060327	1727	-	Correction to the RRC test case 8.1.1.9	F	5.4.0	5.5.0	R5s060124
RP-32	RP-060327	1728	-	Correction to the RRC compressed mode testcases	F	5.4.0	5.5.0	R5s060132
RP-32	RP-060327	1729	-	Correction of erroneous determination of OP-Mode in multiple ATSS	F	5.4.0	5.5.0	R5s060117
RP-33	RP-060548	1730	-	CR to 34.123-3: Add new verified and e-mail agreed TTCN test cases in the TC lists in 34.123-3 (prose), Annex A	F	5.5.0	5.6.0	-
RP-33	RP-060555	1731	-	Correction to the RRC testcase 8.4.1.23	F	5.5.0	5.6.0	R5s060225
RP-33	RP-060555	1732	-	Correction to the RRC testcase 8.4.1.25	F	5.5.0	5.6.0	R5s060226
RP-33	RP-060555	1733	-	Correction to the GMM test case 12.9.7b	F	5.5.0	5.6.0	R5s060223
RP-33	RP-060555	1734	-	Correction of Inter RAT testcase 12.8	F	5.5.0	5.6.0	R5s060222
RP-33	RP-060555	1735	-	Summary of regression errors in wk29 GCF WI-10 ATS	F	5.5.0	5.6.0	R5s060227
RP-33	RP-060555	1736	-	Correction to GCF WI-010/1 approved test case 7.2.3.27	F	5.5.0	5.6.0	R5s060230
RP-33	RP-060555	1737	-	Correction to GCF WI-12/1 approved test case 8.2.2.43	F	5.5.0	5.6.0	R5s060231
RP-33	RP-060569	1738	-	Correction to test cases 14.6.4	F	5.5.0	5.6.0	R5s060229
RP-33	RP-060555	1739	-	Correction to test cases 8.2.2.35 & tcv_BcapMmedia	F	5.5.0	5.6.0	R5s060232
RP-33	RP-060555	1740	-	Correction to GCF WI10 RRC Test Case 8.4.1.5	F	5.5.0	5.6.0	R5s060218
RP-33	RP-060555	1741	-	Correction to approved GCF WI-12 RAB test case 14.2.58a	F	5.5.0	5.6.0	R5s060221

Meeting	TSG doc	CR	Rev	Subject	Cat	Old vers	New vers	WG doc
RP-33	RP-060555	1742	-	Correction to approved GCF WI-12 RRC test cases 8.2.6.39 and 8.2.6.44	F	5.5.0	5.6.0	R5s060220
RP-33	RP-060555	1743	-	Correction to approved GCF WI-10 RLC test case 7.2.3.17	F	5.5.0	5.6.0	R5s060219
RP-33	RP-060555	1744	-	Summary of Regression Errors in NAS wk29 ATS	F	5.5.0	5.6.0	R5s060217
RP-33	RP-060569	1745	-	Correction GCF WI-14 HSDPA Test Case 8.2.1.27	F	5.5.0	5.6.0	R5s060214
RP-33	RP-060569	1746	-	Correction to test cases 14.6.6	F	5.5.0	5.6.0	R5s060215
RP-33	RP-060555	1747	-	Summary of Regression Errors in WK29 ATS	F	5.5.0	5.6.0	R5s060212
RP-33	RP-060555	1748	-	ASP enhancement for HSUPA testing	F	5.5.0	5.6.0	R5s060196
RP-33	RP-060569	1749	-	Summary of regression errors in the wk27 HSD Suite	F	5.5.0	5.6.0	R5s060209
RP-33	RP-060555	1750	-	Summary of regression errors in the wk27 RLC ATS	F	5.5.0	5.6.0	R5s060210
RP-33	RP-060555	1751	-	Corrections to GCF WI-12/1 approved test case 7.1.3.2	F	5.5.0	5.6.0	R5s060208
RP-33	RP-060554	1752	-	Addition of GCF WI10 RRC test case 8.4.1.8 to RRC ATS v5.5.0	B	5.5.0	5.6.0	R5s060201
RP-33	RP-060555	1753	-	Corrections to GCF WI-12/1 approved test case 12.9.7a.	F	5.5.0	5.6.0	R5s060206
RP-33	RP-060569	1754	-	Summary of Regression Errors in HSDPA ATS	F	5.5.0	5.6.0	R5s060207
RP-33	RP-060555	1755	-	Summary of regression errors in the wk27 GCF WI-10 and GCF WI-12 ATS	F	5.5.0	5.6.0	R5s060205
RP-33	RP-060555	1756	-	Correction to GCF WI-10 Idle Mode test case 6.1.2.5	F	5.5.0	5.6.0	R5s060203
RP-33	RP-060556	1757	-	Correction to GCF WI-10 RRC test case 8.3.4.3	F	5.5.0	5.6.0	R5s060204
RP-33	RP-060556	1758	-	Regression Error report for RRC & MAC ATS	F	5.5.0	5.6.0	R5s060199
RP-33	RP-060559	1759	-	Regression Error report for HSD_ENH_r5 ATS	F	5.5.0	5.6.0	R5s060200
RP-33	RP-060559	1760	-	Correction of CC procedure for multimedia calls	F	5.5.0	5.6.0	R5s060063
RP-33	RP-060556	1761	-	Corrections to GCF WI-10 RRC Test Case 8.4.1.24 and 8.4.1.25	F	5.5.0	5.6.0	R5s060198
RP-33	RP-060554	1762	-	Addition of GCF WI-015 AGPS test case 17.2.3.7 to AGPS ATS V5.5.0	B	5.5.0	5.6.0	R5s060193
RP-33	RP-060554	1763	-	Addition of GCF WI-015 AGPS test case 17.2.3.6 to AGPS ATS V5.5.0	B	5.5.0	5.6.0	R5s060192
RP-33	RP-060556	1764	-	Correction to GCF WI-12 NAS Test Case 12.9.9	F	5.5.0	5.6.0	R5s060197
RP-33	RP-060556	1765	-	Correction to the RRC testcase 8.2.3.8	F	5.5.0	5.6.0	R5s060190
RP-33	RP-060556	1766	-	Correction to the RRC testcase 8.2.4.1	F	5.5.0	5.6.0	R5s060191
RP-33	RP-060556	1767	-	Correction of GCF WI-10 RRC Test Case 8.3.1.10 and 8.3.2.4	F	5.5.0	5.6.0	R5s060186
RP-33	RP-060556	1768	-	Correction to the Security procedure	F	5.5.0	5.6.0	R5s060189
RP-33	RP-060556	1769	-	Correction to GCF WI-10 NAS Test Case 11.1.1.1	F	5.5.0	5.6.0	R5s060178
RP-33	RP-060556	1770	-	Correction to GCF WI-12 RRC Test Case 8.1.1.10	F	5.5.0	5.6.0	R5s060187
RP-33	RP-060556	1771	-	Correction to the test step ts_ToStateMOCCompressMode_CS_6_9_PS_6_10	F	5.5.0	5.6.0	R5s060188
RP-33	RP-060561	1772	-	Moving baseline to the June 06, Rel-6	F	5.5.0	5.6.0	R5s060183
RP-33	RP-060556	1773	-	Corrections to GCF WI-10 SMS Test Cases 16.1.1 and 16.1.2	F	5.5.0	5.6.0	R5s060185
RP-33	RP-060559	1774	-	Corrections to GCF WI-13 Test Case 8.3.11.13	F	5.5.0	5.6.0	R5s060184
RP-33	RP-060556	1775	-	Correction GCF WI-12 Inter-RAT Test Case 8.4.1.48	F	5.5.0	5.6.0	R5s060182
RP-33	RP-060569	1776	-	Corrections to GCF WI 14 test case 14.6.4	F	5.5.0	5.6.0	R5s060181
RP-33	RP-060556	1777	-	Correction of GCF WI-10 Idle Mode Testcase 6.1.2.6	F	5.5.0	5.6.0	R5s060180
RP-33	RP-060556	1778	-	Correction of value for t_IdlePageTimer timer	F	5.5.0	5.6.0	R5s060175
RP-33	RP-060556	1779	-	Correction to GCF WI-12 NAS Test Case 12.9.9	F	5.5.0	5.6.0	R5s060176
RP-33	RP-060556	1780	-	Correction to Approved GCF WI-10 NAS test case 12.9.6	F	5.5.0	5.6.0	R5s060179
RP-33	RP-060556	1781	-	Summary of regression errors in wk23 GCF WI-10 and GCF WI-12 ATS	F	5.5.0	5.6.0	R5s060177
RP-33	RP-060556	1782	-	Correction to the test step ts_U2GCellChange_RAUpdate	F	5.5.0	5.6.0	R5s060174
RP-33	RP-060556	1783	-	Corrections to GCF WI 12/1 IR_U test case 8_4_1_48	F	5.5.0	5.6.0	R5s060173
RP-33	RP-060569	1784	-	Correction to test case 8.2.6.48	F	5.5.0	5.6.0	R5s060170
RP-33	RP-060559	1785	-	Correction to test case 8.1.6.5	F	5.5.0	5.6.0	R5s060171
RP-33	RP-060557	1786	-	Correction to test step ts_SS_Rel	F	5.5.0	5.6.0	R5s060172
RP-33	RP-060557	1787	-	Correction to the GCF WI-12 RRC testcase 8.1.6.3	F	5.5.0	5.6.0	R5s060169
RP-33	RP-060557	1788	-	Correction to the GCF WI-10 NAS test case 12.4.2.4	F	5.5.0	5.6.0	R5s060166
RP-33	RP-060557	1789	-	Correction to the GCF WI-10 RRC test case 8.4.1.2	F	5.5.0	5.6.0	R5s060167
RP-33	RP-060557	1790	-	Summary of regression errors in the wk21 GCF WI-10 and WI-12 ATS	F	5.5.0	5.6.0	R5s060168
RP-33	RP-060569	1791	-	Summary of regression errors in the wk21 HSD_ENH ATS	F	5.5.0	5.6.0	R5s060165
RP-33	RP-060569	1792	-	Correction to GCF WI14 test case 8.2.6.39a and 8.2.6.39b	F	5.5.0	5.6.0	R5s060164
RP-33	RP-060557	1793	-	Correction of GCF WI-12 and 10 NAS Test cases 9.4.5.4.6 and 9.4.5.4.1	F	5.5.0	5.6.0	R5s060163

Meeting	TSG doc	CR	Rev	Subject	Cat	Old vers	New vers	WG doc
RP-33	RP-060554	1794	-	Addition of GCF WI-012 MAC test case 7.1.3.2 to MAC ATS V5.4.0	B	5.5.0	5.6.0	R5s060161
RP-33	RP-060557	1795	-	Correction of GCF WI-10 IR_U Testcase 8.3.11.4	F	5.5.0	5.6.0	R5s060158
RP-33	RP-060569	1796	-	Addition of GCF WI14/3 test case 14.6.6 to HSD_ENH ATS V5.4.0	B	5.5.0	5.6.0	R5s060159
RP-33	RP-060569	1797	-	Correction of GCF WI-14 HSDPA Testcase 8.3.11.10	F	5.5.0	5.6.0	R5s060156
RP-33	RP-060557	1798	-	Correction of GCF WI-12 RRC Testcase 8.3.1.30	F	5.5.0	5.6.0	R5s060157
RP-33	RP-060569	1799	-	Addition of GCF WI14/3 test case 14.6.1a to HSD_ENH ATS V5.4.0	B	5.5.0	5.6.0	R5s060154
RP-33	RP-060557	1800	-	Summary of regression errors in the wk18 GCF WI-10 and GCF WI-12 ATS	F	5.5.0	5.6.0	R5s060148
RP-33	RP-060557	1801	-	Correction to common teststeps ts_RRC_ReceiveUE_CapabilityInfo and ts_Check_UE_Capability	F	5.5.0	5.6.0	R5s060146
RP-33	RP-060557	1802	-	Correction to the constraint cbr_108_RRC_SecModeCmpl in approved teststep ts_RRC_Security	F	5.5.0	5.6.0	R5s060147
RP-33	RP-060569	1803	-	Correction to test step ts_RRC_ConnRel_AfterSwitchOff_r5	F	5.5.0	5.6.0	R5s060153
RP-33	RP-060569	1804	-	Correction of GCF WI-14 HSDPA MAC test case 7.1.5.4	F	5.5.0	5.6.0	R5s060149
RP-33	RP-060557	1805	-	Proposed enhancement for calculation of DPCH Frame Offset	F	5.5.0	5.6.0	R5s060150
RP-33	RP-060557	1806	-	Correction of PLMN presentation in test step ts_MMI_PLMN_SelPerf	F	5.5.0	5.6.0	R5s060152
RP-33	RP-060557	1807	-	Correction to InterRAT Idle Mode frequency lists	F	5.5.0	5.6.0	R5s060151
RP-33	RP-060557	1808	-	Correction to GCF WI-10 Idle Mode test case 6.1.2.3	F	5.5.0	5.6.0	R5s060144
RP-33	RP-060557	1809	-	Correction of integrity error in TC 8.1.7.1d	F	5.5.0	5.6.0	R5s060145
RP-33	RP-060569	1810	-	TTCN correction to MAC-hs testcase 7.1.5.6	F	5.5.0	5.6.0	R5s060143
RP-33	RP-060558	1811	-	Summary of regression errors in wk29 IRAT ATSS.	F	5.5.0	5.6.0	R5s060236
RP-33	RP-060558	1812	-	Correction to Approved GCF WI-10 NAS test case 12.4.1.1a	F	5.5.0	5.6.0	R5s060243
RP-33	RP-060558	1813	-	Summary of Regression Errors in RRC wk34 ATS	F	5.5.0	5.6.0	R5s060248
RP-33	RP-060558	1814	-	Summary of Regression Errors in NAS wk34 ATS	F	5.5.0	5.6.0	R5s060249
RP-33	RP-060558	1815	-	Summary of Regression Errors in SMS wk34 ATS	F	5.5.0	5.6.0	R5s060250
RP-33	RP-060559	1816	-	Summary of Regression Errors in HSD_ENH wk34 ATS	F	5.5.0	5.6.0	R5s060256
RP-33	RP-060558	1817	-	Correction to GCF WI-12 IR_U Test Case 8.4.1.48	F	5.5.0	5.6.0	R5s060253
RP-33	RP-060558	1818	-	Summary of regression errors in wk34 GCF WI-10 and GCF WI-12 ATS	F	5.5.0	5.6.0	R5s060255
RP-33	RP-060558	1819	-	Correction to UE capability constraints	F	5.5.0	5.6.0	R5s060254
RP-33	RP-060558	1820	-	Addition of GCF WI-017 test case 8.3.7.17 to IR_U_r3 ATS V5.5.0.	B	5.5.0	5.6.0	R5s060234
RP-33	RP-060564	1821	-	CR to 34.123-3: ASP changes for EDCH test	F	5.5.0	5.6.0	R5-062325
RP-33	RP-060551	1822	-	New ASP and updated ASP to resolve SRB3 UL ciphering	F	5.5.0	5.6.0	R5-062534
RP-33	RP-060553	1823	-	Production of pointer version 5.6.0 of TS 34.123-3 with no technical contents	F	5.5.0	5.6.0	R5-062535
RP-33	RP-060560	1824	-	Upgrade TS 34.123-3 to version 6.0.0	F	5.5.0	6.0.0	R5-062536
RP-33	RP-060551	1825	-	CR to 34.123-3: Update TSO and PIXIT	F	5.5.0	5.6.0	R5-062395
RP-33	RP-060551	1826	-	CR to 34.123-3: SFN offset issue in the CFN timing-maintained test	F	5.5.0	5.6.0	R5-062046
RP-33	RP-060560	1827	-	CR to 34.123-3: GERAN additional bands for interRAT test	F	5.5.0	5.6.0	R5-062537
RP-34	RP-060744	1828	-	CR to 34.123-3, Corrections of ASP and EDCH configurations	F	6.0.0	6.1.0	R5-063063
RP-34	RP-060734	1829	-	CR to 34.123-3: New PIXIT for band VI test	F	6.0.0	6.1.0	R5-063375
RP-34	RP-060734	1830	-	CR to 34.123-3: New annex guidance to TC executions	F	6.0.0	6.1.0	R5-063546
RP-34	RP-060741	1831	-	CR to 34.123-3: Add new verified and e-mail agreed TTCN test cases in the TC lists in 34.123-3 (prose), Annex A	F	6.0.0	6.1.0	-
RP-34	RP-060745	1832	-	Addition of E-DCH MAC test case 7.1.6.2.3 to HSU_ENH ATS v5.5.0	B	6.0.0	6.1.0	R5s060311
RP-34	RP-060745	1833	-	Addition of EDCH test case 8.2.6.50 to HSU ATS v5.5.0	B	6.0.0	6.1.0	R5s060304
RP-34	RP-060745	1834	-	Addition of E-DCH RRC test case 8.3.1.41 to HSU_ENH ATS v5.5.0	B	6.0.0	6.1.0	R5s060286
RP-34	RP-060745	1835	-	Addition of E-DCH InterRAT test case 8.3.11.14 to HSU_ENH_r6 ATS.	B	6.0.0	6.1.0	R5s060272
RP-34	RP-060745	1836	-	Addition of GCF WI-25 E-DCH test case 14.7.1 to HSU_ENH_r6 ATS.	B	6.0.0	6.1.0	R5s060259

Meeting	TSG doc	CR	Rev	Subject	Cat	Old vers	New vers	WG doc
RP-34	RP-060745	1837	-	Addition of GCF WI-25 E-DCH test case 8.2.1.35 to HSU_ENH_r6 ATS.	B	6.0.0	6.1.0	R5s060270
RP-34	RP-060736	1838	-	Addition of GCF WI10 RRC test case 8.2.6.38 to RRC ATS v6.0.0	B	6.0.0	6.1.0	R5s060295
RP-34	RP-060736	1839	-	Addition of GCF WI10 RRC test case 8.4.1.28 to RRC ATS v6.0.0	B	6.0.0	6.1.0	R5s060265
RP-34	RP-060736	1840	-	Addition of GCF WI10 RRC test case 6.1.2.4 to RRC ATS v6.0.0	B	6.0.0	6.1.0	R5s060257
RP-34	RP-060738	1841	-	Addition of HSDPA RAB test case 14.6.7 to HSD_ENH ATS v5.5.0	B	6.0.0	6.1.0	R5s060313
RP-34	RP-060740	1842	-	Addition of DSAC test case 8.1.2.16 to HSU_ENH_r6 ATS.	B	6.0.0	6.1.0	R5s060288
RP-34	RP-060740	1843	-	Addition of DSAC test case 12.4.2.12 to HSU_ENH_r6 ATS	B	6.0.0	6.1.0	R5s060283
RP-34	RP-060740	1844	-	Addition of DSAC test case 12.4.2.11 to HSU_ENH_r6 ATS.	B	6.0.0	6.1.0	R5s060281
RP-34	RP-060740	1845	-	Addition of GCF WI-24 DSAC test case 12.9.15 to HSU ATS v6.0.0	B	6.0.0	6.1.0	R5s060263
RP-34	RP-060740	1846	-	Addition of DSAC test case 9.4.3.6 to HSU_ENH_ATS V5.5.0	B	6.0.0	6.1.0	R5s060251
RP-34	RP-060740	1847	-	Addition of DSAC test case 12.2.1.12 to HSU_ENH_ATS V6.0.0	B	6.0.0	6.1.0	R5s060246
RP-34	RP-060740	1848	-	Addition of DSAC test case 9.5.9 to HSU_ENH_ATS V6.0.0	B	6.0.0	6.1.0	R5s060244
RP-34	RP-060736	1849	-	Correction to GCF WI-10 IR-U Test Case 8.3.7.1	F	6.0.0	6.1.0	R5s060338
RP-34	RP-060736	1850	-	Summary of regression errors in wk38 GCF WI-10 and WI-12 ATS	F	6.0.0	6.1.0	R5s060337
RP-34	RP-060736	1851	-	Correction to SMS testcase 16.2.1	F	6.0.0	6.1.0	R5s060320
RP-34	RP-060736	1852	-	Correction to the NAS Test Case 12.9.12 and 12.9.13	F	6.0.0	6.1.0	R5s060334
RP-34	RP-060736	1853	-	Corrections to GCF WI-10 Test Cases 8.1.10.1 and 7.1.1.8	F	6.0.0	6.1.0	R5s060332
RP-34	RP-060736	1854	-	Introduction of Band 6 to test cases	F	6.0.0	6.1.0	R5s060324
RP-34	RP-060736	1855	-	Summary of Regression Errors in RLC wk38 ATS	F	6.0.0	6.1.0	R5s060331
RP-34	RP-060736	1856	-	Corrections to GCF WI-12 RRC Test Cases 8.2.6.39 & 8.2.6.44	F	6.0.0	6.1.0	R5s060330
RP-34	RP-060736	1857	-	Correction to GCF WI-10 RRC Test Case 6.1.1.7	F	6.0.0	6.1.0	R5s060325
RP-34	RP-060736	1858	-	Correction to approved GCF WI-12/1 RAB test case 14.2.58a	F	6.0.0	6.1.0	R5s060321
RP-34	RP-060736	1859	-	Summary of regression errors in the wk38 InterRAT ATSS.	F	6.0.0	6.1.0	R5s060315
RP-34	RP-060736	1860	-	Summary of regression errors in wk38 GCF WI-10 and GCF WI-12 ATS	F	6.0.0	6.1.0	R5s060309
RP-34	RP-060736	1861	-	Correction to the RRC test case 8.4.1.8	F	6.0.0	6.1.0	R5s060307
RP-34	RP-060736	1862	-	Corrections to GCF WI-10 RAB testcases 14.4.2.3 and 14.4.2a.3	F	6.0.0	6.1.0	R5s060308
RP-34	RP-060736	1863	-	Correction to IR_U testcase 8.4.1.48	F	6.0.0	6.1.0	R5s060302
RP-34	RP-060736	1864	-	Correction of GCF WI-10 RRC testcase 8.1.10.1	F	6.0.0	6.1.0	R5s060303
RP-34	RP-060736	1865	-	Correction to GCF WI-12 RRC Test Case 8.3.1.30	F	6.0.0	6.1.0	R5s060306
RP-34	RP-060737	1866	-	Correction to IR_U testcases for XID negotiation	F	6.0.0	6.1.0	R5s060298
RP-34	RP-060737	1867	-	Correction to RRC testcase 8.2.2.9	F	6.0.0	6.1.0	R5s060299
RP-34	RP-060737	1868	-	Correction to RRC testcase 8.3.1.30	F	6.0.0	6.1.0	R5s060300
RP-34	RP-060737	1869	-	iWD_wk36 ATS Regression Errors Corrections	F	6.0.0	6.1.0	R5s060294
RP-34	RP-060737	1870	-	Summary of regression errors in the wk36 IR_U_r3 ATS.	F	6.0.0	6.1.0	R5s060290
RP-34	RP-060737	1871	-	TTCN Correction to GCF WI-10 RRC Test Cases 8.1.1.4, 8.1.1.5 and 8.1.1.6	F	6.0.0	6.1.0	R5s060292
RP-34	RP-060737	1872	-	TTCN correction to GCF WI-10 RRC Test Cases 8.1.2.2 and 8.1.2.9	F	6.0.0	6.1.0	R5s060293
RP-34	RP-060737	1873	-	Correction to WI 10/2 RRC testcase 8.4.1.8	F	6.0.0	6.1.0	R5s060285
RP-34	RP-060737	1874	-	Summary of regression errors in wk36 GCF WI-10 and GCF WI-12 ATS	F	6.0.0	6.1.0	R5s060274
RP-34	RP-060737	1875	-	Summary of Regression Errors in wk36 ATS	F	6.0.0	6.1.0	R5s060280
RP-34	RP-060737	1876	-	Correction to approved GCF WI-010 Test Case 16.2.1	F	6.0.0	6.1.0	R5s060278
RP-34	RP-060737	1877	-	Correction to GCF WI-12 RRC Test Case 8.2.2.43	F	6.0.0	6.1.0	R5s060279
RP-34	RP-060737	1878	-	Correction to testcase 14.2.58	F	6.0.0	6.1.0	R5s060267
RP-34	RP-060737	1879	-	TTCN CR to extend Guard Timer for GCF WI-10 and 12 RRC & RAB Test Cases	F	6.0.0	6.1.0	R5s060261
RP-34	RP-060738	1880	-	Correction to testcase 8.2.6.48	F	6.0.0	6.1.0	R5s060335
RP-34	RP-060738	1881	-	Correction of PDP_Context_Status mandatory IE for Rel 5 and above	F	6.0.0	6.1.0	R5s060333
RP-34	RP-060738	1882	-	Corrections to GCF WI-14/1 test case 8.3.11.9	F	6.0.0	6.1.0	R5s060323

Meeting	TSG doc	CR	Rev	Subject	Cat	Old vers	New vers	WG doc
RP-34	RP-060738	1883	-	Corrections to GCF WI 14/1 test case 8.2.3.35	F	6.0.0	6.1.0	R5s060310
RP-34	RP-060738	1884	-	Correction to GCF WI 14 RRC testcases in Non Ciphering path.	F	6.0.0	6.1.0	R5s060301
RP-34	RP-060738	1885	-	Correction to HSDPA MRAT testcase 8.3.7.14	F	6.0.0	6.1.0	R5s060297
RP-34	RP-060738	1886	-	Summary of regression errors in wk36 HSD_ENH ATS	F	6.0.0	6.1.0	R5s060277
RP-34	RP-060738	1887	-	TTCN CR to extend Guard Timer for GCF WI-14 RAB Test Case	F	6.0.0	6.1.0	R5s060262
RP-34	RP-060745	1888	-	Addition of E-DCH MAC test case 7.1.6.2.7 to HSU_ENH ATS v6.0.0	B	6.0.0	6.1.0	R5s060343
RP-34	RP-060745	1889	-	Addition of E-DCH MAC test case 7.1.6.2.4 to HSU_ENH ATS v6.0.0	B	6.0.0	6.1.0	R5s060347
RP-34	RP-060737	1890	-	Correction to approved GCF WI-10/3 RRC test case 6.1.2.6	F	6.0.0	6.1.0	R5s060339
RP-34	RP-060737	1891	-	Correction to GCF WI-10 Idle Mode Test Case 6.1.2.8	F	6.0.0	6.1.0	R5s060340
RP-34	RP-060737	1892	-	Correction to GCF WI-10 RRC Test Case 8.3.1.31	F	6.0.0	6.1.0	R5s060342
RP-34	RP-060737	1896	-	Corrections of approved GCF WI-12 test case 8.2.2.43.	F	6.0.0	6.1.0	R5s060317
RP-34	RP-060737	1897	-	Correction to GCF WI-10 RRC Test Case 8.4.1.8	F	6.0.0	6.1.0	R5s060322
RP-35	RP-070099	1898		Addition of GCF WI-25 HSUPA MAC Test Case 7.1.6.4.3	B	6.1.0	6.2.0	R5s060401
RP-35	RP-070099	1899		Addition of GCF WI-25 RAB Test Case 14.7.4	B	6.1.0	6.2.0	R5s060399
RP-35	RP-070099	1900		Addition of GCF WI-25 HSUPA Test Case 7.1.6.2.10	B	6.1.0	6.2.0	R5s060378
RP-35	RP-070099	1901		Addition of GCF WI-25 HSUPA MAC Test Case 7.1.6.4.2	B	6.1.0	6.2.0	R5s060395
RP-35	RP-070099	1902		Addition of GCF WI-25 HSUPA Test Case 8.2.2.45	B	6.1.0	6.2.0	R5s060384
RP-35	RP-070099	1903		Addition of GCF WI-25 HSUPA MAC Test Case 7.1.6.1.3	B	6.1.0	6.2.0	R5s060380
RP-35	RP-070099	1904		Addition of GCF WI-25 HSUPA MAC Test Case 7.1.6.2.8	B	6.1.0	6.2.0	R5s060376
RP-35	RP-070099	1905		Addition of GCF WI-25 HSUPA Test Case 7.1.6.2.9	B	6.1.0	6.2.0	R5s060381
RP-35	RP-070106	1906		Addition of GCF WI-10 Idle mode test case 6.1.2.9a	B	6.1.0	6.2.0	R5s070027
RP-35	RP-070106	1907		Addition of GCF WI-10 Idle mode test case 6.1.2.9b	B	6.1.0	6.2.0	R5s070029
RP-35	RP-070110	1908		Addition of WB-AMR RAB test case 14.2.4b to HSD_ENH_r5 ATS V6.1.0	B	6.1.0	6.2.0	R5s070033
RP-35	RP-070099	1909		Addition of E-DCH RAB test case 14.7.5 to HSU_ENH_r6 ATS V6.0.0	B	6.1.0	6.2.0	R5s060328
RP-35	RP-070099	1910		Addition of E-DCH RAB test case 14.7.2 to HSU_ENH_r6 ATS V6.0.0	B	6.1.0	6.2.0	R5s060326
RP-35	RP-070099	1911		Addition of E-DCH MAC test case 7.1.6.3.1 to HSU_ENH_r6 ATS V6.0.0	B	6.1.0	6.2.0	R5s060364
RP-35	RP-070099	1912		Addition of E-DCH MAC test case 7.1.6.1.2 to HSU_ENH_r6 ATS V6.0.0	B	6.1.0	6.2.0	R5s060362
RP-35	RP-070099	1913		Addition of E-DCH MAC test case 7.1.6.1.1 to HSU_ENH_r6 ATS V6.0.0	B	6.1.0	6.2.0	R5s060360
RP-35	RP-070099	1914		Correction to GCF WI-025 test case 8.3.1.41	F	6.1.0	6.2.0	R5s060404
RP-35	RP-070099	1915		Correction to GCF WI-25 RAB Test Case 14.7.5	F	6.1.0	6.2.0	R5s060408
RP-35	RP-070106	1916		Summary of Regression Errors in NAS wk49 ATS	F	6.1.0	6.2.0	R5s060406
RP-35	RP-070106	1917		Summary of regression errors in wk49 ATS	F	6.1.0	6.2.0	R5s060405
RP-35	RP-070106	1918		Correction to GCF WI-10 SMS test case 16.3	F	6.1.0	6.2.0	R5s070005
RP-35	RP-070106	1919		Correction to GCF WI-10 SMS test cases 16.1.1 and 16.1.2	F	6.1.0	6.2.0	R5s070006
RP-35	RP-070106	1920		Correction to GCF WI-10 RRC test case 6.1.2.3	F	6.1.0	6.2.0	R5s070007
RP-35	RP-070106	1921		Summary of regression errors in wk49 IRAT ATSSs.	F	6.1.0	6.2.0	R5s070004
RP-35	RP-070106	1922		Correction to GCF WI-10 NAS Test Case 12.9.12	F	6.1.0	6.2.0	R5s070001
RP-35	RP-070106	1923		Correction to GCF WI-10 RRC Test Case 8.4.1.25 and 8.4.1.48	F	6.1.0	6.2.0	R5s070002
RP-35	RP-070106	1924		Correction to GCF WI-10 RAB Test Case 14.2.58	F	6.1.0	6.2.0	R5s070003
RP-35	RP-070099	1925		Correction to GCF WI-025 test case 14.7.4	F	6.1.0	6.2.0	R5s070019
RP-35	RP-070106	1926		Correction to GCF WI-10 RRC Test Case 8.4.1.2	F	6.1.0	6.2.0	R5s070026
RP-35	RP-070106	1927		Correction to GCF WI-10 IR-U Test Case 12.8	F	6.1.0	6.2.0	R5s070025
RP-35	RP-070106	1928		Corrections to GCF WI-17 DTM test case 8.3.7.17	F	6.1.0	6.2.0	R5s070023
RP-35	RP-070106	1929		Correction to approved test case 8.4.1.8	F	6.1.0	6.2.0	R5s070020
RP-35	RP-070106	1930		Correction to approved test case 8.2.6.38	F	6.1.0	6.2.0	R5s070021
RP-35	RP-070106	1931		Correction to the NAS test case 9.2.2	F	6.1.0	6.2.0	R5s070011
RP-35	RP-070106	1932		Correction to NAS test cases 12.4.1.1b and 12.9.9	F	6.1.0	6.2.0	R5s070012
RP-35	RP-070106	1933		Correction to RRC testcase 8.4.1.2	F	6.1.0	6.2.0	R5s070013
RP-35	RP-070106	1934		Correction to DSAC testcases 12.9.15, 12.4.2.11 and 12.4.2.12	F	6.1.0	6.2.0	R5s070014
RP-35	RP-070107	1935		Correction to AGPS ASP Retri_GPS_AssistanceData_CNF	F	6.1.0	6.2.0	R5s070015
RP-35	RP-070107	1936		Correction to the RRC testcase 8.3.4.8	F	6.1.0	6.2.0	R5s070017

Meeting	TSG doc	CR	Rev	Subject	Cat	Old vers	New vers	WG doc
RP-35	RP-070107	1937		Summary of Regression Errors in wk49 ATSS	F	6.1.0	6.2.0	R5s070018
RP-35	RP-070107	1938		Introduction of Band 8	F	6.1.0	6.2.0	R5s070008
RP-35	RP-070107	1939		Correction of CC procedure for multimedia calls	F	6.1.0	6.2.0	R5s070010
RP-35	RP-070110	1940		Correction to RRC TC 8.3.4.9 to avoid possible radio link failure.	F	6.1.0	6.2.0	R5s070022
RP-35	RP-070110	1941		Correction to GCF WI-14 HSDPA Test Case 14.6.4a	F	6.1.0	6.2.0	R5s070024
RP-35	RP-070107	1942		Step enhancement for the introduction of InterBand Test cases	F	6.1.0	6.2.0	R5s070031
RP-35	RP-070107	1943		Correction to GCF WI-10 RRC Test Case 8.3.1.5	F	6.1.0	6.2.0	R5s070039
RP-35	RP-070107	1944		Correction to Inter-RAT testcase 8.3.7.3	F	6.1.0	6.2.0	R5s070038
RP-35	RP-070110	1945		Correction to GCF WI-13 Test Case 8.3.1.40	F	6.1.0	6.2.0	R5s070040
RP-35	RP-070110	1946		Correction to Idle mode testcase 6.1.2.10	F	6.1.0	6.2.0	R5s070036
RP-35	RP-070112	1947		Correction to DSAC RRC testcase 8.1.2.16	F	6.1.0	6.2.0	R5s070037
RP-35	RP-070110	1948		Correction to test case 8.2.6.39b & 8.3.4.9	F	6.1.0	6.2.0	R5s070041
RP-35	RP-070107	1949		Correction to the NAS Test Case 12.3.2.1	F	6.1.0	6.2.0	R5s060352
RP-35	RP-070107	1950		Correction to GCF WI-012 test case 12.3.2.7	F	6.1.0	6.2.0	R5s060351
RP-35	RP-070107	1951		Correction to approved GCF WI-10 test case 8.3.7.1.	F	6.1.0	6.2.0	R5s060345
RP-35	RP-070107	1952		Correction of approved GCF WI-010 test case 8.1.7.1c	F	6.1.0	6.2.0	R5s060316
RP-35	RP-070107	1953		Correction to GCF WI-12 MAC Test Case 7.1.3.2	F	6.1.0	6.2.0	R5s060354
RP-35	RP-070107	1954		Correction to QOS checking for UE not support AT commands to start MO PS call	F	6.1.0	6.2.0	R5s060353
RP-35	RP-070112	1955		Correction to GCF WI-24 DSAC Test Case 12.4.2.11	F	6.1.0	6.2.0	R5s060355
RP-35	RP-070107	1956		Summary of regression errors in wk43 ATS	F	6.1.0	6.2.0	R5s060341
RP-35	RP-070107	1957		Correction to GCF WI 10/2 RRC testcase 8.4.1.8	F	6.1.0	6.2.0	R5s060389
RP-35	RP-070107	1958		TTCN correction to GMM Test Case 12.4.1.4b	F	6.1.0	6.2.0	R5s060357
RP-35	RP-070107	1959		Summary of regression errors in wk47 IRAT ATSS.	F	6.1.0	6.2.0	R5s060372
RP-35	RP-070107	1960		Change of PDU type definition REGISTER used in MM test cases	F	6.1.0	6.2.0	R5s060388
RP-35	RP-070107	1961		Correction to GCF WI-10 RRC Test Case 8.4.1.25	F	6.1.0	6.2.0	R5s060374
RP-35	RP-070108	1962		Summary of Regression Errors in NAS wk47 ATS – Batch2	F	6.1.0	6.2.0	R5s060371
RP-35	RP-070108	1963		Summary of Regression Errors in NAS wk47 ATS	F	6.1.0	6.2.0	R5s060369
RP-35	RP-070108	1964		Summary of Regression Errors in RAB wk47 ATS	F	6.1.0	6.2.0	R5s060370
RP-35	RP-070108	1965		Correction to GCF WI-10 RRC Test Case 8.1.2.4	F	6.1.0	6.2.0	R5s060367
RP-35	RP-070108	1966		Correction to GCF WI-10 RRC Test Case 6.1.2.1	F	6.1.0	6.2.0	R5s060366
RP-35	RP-070110	1967		TTCN correction to GCF WI-014 RRC HSDPA Test Case 8.3.1.35	F	6.1.0	6.2.0	R5s060359
RP-35	RP-070110	1968		Summary of Regression Errors in HSDPA wk47 ATS	F	6.1.0	6.2.0	R5s060368
RP-35	RP-070099	1969		Corrections to E-DCH test case 14.7.1	F	6.1.0	6.2.0	R5s060403
RP-35	RP-070099	1970		Corrections to E-DCH test case 7.1.6.2.3 and 7.1.6.2.7	F	6.1.0	6.2.0	R5s060394
RP-35	RP-070099	1971		Summary of Regression Errors in HSU wk47 ATS	F	6.1.0	6.2.0	R5s060375
RP-35	RP-070108	1972		Correction to approved test case 8.4.1.2, 8.4.1.6, 8.4.1.24	F	6.1.0	6.2.0	R5s060391
RP-35	RP-070110	1973		Summary of regression errors in wk47 ATS	F	6.1.0	6.2.0	R5s060393
RP-35	RP-070110	1974		Correction to approved GCF WI-014 test case 8.2.6.48	F	6.1.0	6.2.0	R5s060392
RP-35	RP-070108	1975		Correction to RRC constraint 'cr_RRC_RrcConnSetupCmplRadioCap_BandList2' for Band VIII	F	6.1.0	6.2.0	R5s070035
RP-35	RP-070108	1976		Addition of GCF WI-010 P4 test case 8.2.6.37 to RRC ATS V6.1.0	B	6.1.0	6.2.0	R5s070050
RP-35	RP-070108	1977		Correction to GCF WI-10 NAS test cases using SETUP ul constraints	F	6.1.0	6.2.0	R5s070043
RP-35	RP-070108	1978		Correction to GCF WI-10 NAS test cases 9.1 and 12.9.7c	F	6.1.0	6.2.0	R5s070044
RP-35	RP-070108	1979		Correction to GCF WI-10 NAS test case 9.4.2.2 Procedure 2	F	6.1.0	6.2.0	R5s070045
RP-35	RP-070100	1981		CR to 34.123-3: Add new verified and e-mail agreed TTCN test cases in the TC lists in 34.123-3 (prose), Annex A	F	6.1.0	6.2.0	-
RP-35	RP-070108	1982		Correction to the MAC suite for Band VI	F	6.1.0	6.2.0	R5s070052
RP-35	RP-070108	1983		Summary of regression errors in 07wk03 ATSS	F	6.1.0	6.2.0	R5s070053
RP-35	RP-070108	1984		Cell setup issue in 15 Idle Mode, RRC and NAS test cases	F	6.1.0	6.2.0	R5s070054
RP-35	RP-070108	1985		Correction to RRC testcase 6.1.2.6	F	6.1.0	6.2.0	R5s070059
RP-35	RP-070108	1986		Correction to constraint cr_UE_CapabilityInfoAM_BandList2 for Band VIII	F	6.1.0	6.2.0	R5s070061
RP-35	RP-070108	1987		Corrections to wk03 AGPS ATS	F	6.1.0	6.2.0	R5s070032
RP-35	RP-070108	1988		Recovering LAI checking in RRC CONNECTION REQUEST in 8.1.2.x. test cases	F	6.1.0	6.2.0	R5s070057

Meeting	TSG doc	CR	Rev	Subject	Cat	Old vers	New vers	WG doc
RP-35	RP-070108	1989		Correction to RRC testcase 8.4.1.2	F	6.1.0	6.2.0	R5s070056
RP-35	RP-070108	1990		Cleaning of UE capability check procedure and band PICS	F	6.1.0	6.2.0	R5s070042
RP-35	RP-070109	1991		Correction to remove dependency on px_CipheringOnOff in L2 test cases	F	6.1.0	6.2.0	R5s070055
RP-35	RP-070110	1992		Correction to HSDPA testcase 8.2.4.36	F	6.1.0	6.2.0	R5s070060
RP-35	RP-070099	1993		Addition of GCF WI 25 RRC test case 8.2.3.36 to HSU_ENH_r6 ATS V6.1.0.	B	6.1.0	6.2.0	R5s070062
RP-35	RP-070099	1994		Addition of GCF WI-25 EDCH RRC test case 8.2.2.46	B	6.1.0	6.2.0	R5s070064
RP-35	RP-070109	1995		Correction to RLC Test case 7.2.3.35	F	6.1.0	6.2.0	R5s070058
RP-35	RP-070098	1996		Activation time in EDCH ASP and ASP order	F	6.1.0	6.2.0	R5-070033
RP-35	RP-070087	1997		MBMS test model and ASP	F	6.1.0	6.2.0	R5-070460
RP-35	RP-070103	1998		Correction of Band VIII test and Max. number of Almanac data	F	6.1.0	6.2.0	R5-070400
RP-35	RP-070105	1999		Documentation of a test configuration and other corrections	F	6.1.0	6.2.0	R5-070401
RP-35	RP-070103	2000		Corrections to AGPS asn.1 module	F	6.1.0	6.2.0	R5-070091
RP-36	RP-070359	2001		Addition of GCF WI 25 test case 8.3.4.10 to HSU_ENH_r6 ATS V6.1.0.	B	6.2.0	6.3.0	R5s070047
RP-36	RP-070359	2002		Addition of RRC test case 8.2.6.54 to HSD_ENH_r5 ATS V6.1.0	B	6.2.0	6.3.0	R5s070112
RP-36	RP-070359	2003		Addition of GCF WI-25 EDCH test case 8.2.2.48	B	6.2.0	6.3.0	R5s070079
RP-36	RP-070359	2004		Addition of GCF WI-25 EDCH test case 8.2.6.51	B	6.2.0	6.3.0	R5s070140
RP-36	RP-070359	2005		Addition of E-DCH test case 7.1.6.2.2 to HSUPA ATS v6.1.0	B	6.2.0	6.3.0	R5s070103
RP-36	RP-070347	2006		Addition of GCF WI-047 test case 8.4.1.25A to RRC ATS.	B	6.2.0	6.3.0	R5s070126
RP-36	RP-070347	2007		Addition of GCF WI-047 test case 8.4.1.2B to RRC ATS.	B	6.2.0	6.3.0	R5s070122
RP-36	RP-070347	2008		Addition of GCF WI-047 test case 8.2.1.34a to RRC ATS.	B	6.2.0	6.3.0	R5s070120
RP-36	RP-070347	2009		Addition of GCF WI-047 test case 8.2.1.24a to RRC ATS.	B	6.2.0	6.3.0	R5s070118
RP-36	RP-070347	2010		Addition of GCF WI-047 test case 6.1.2.10a to HSDPA ATS.	B	6.2.0	6.3.0	R5s070085
RP-36	RP-070347	2011		Addition of GCF WI-047 test case 8.1.2.10a to RRC ATS.	B	6.2.0	6.3.0	R5s070083
RP-36	RP-070347	2012		Addition of GCF WI-047 test case 6.1.2.1a to RRC ATS.	B	6.2.0	6.3.0	R5s070081
RP-36	RP-070347	2013		Addition of GCF WI10 RRC test case 8.4.1.42 to RRC ATS v6.1.0	B	6.2.0	6.3.0	R5s070109
RP-36	RP-070352	2014		Addition of WB-AMR RAB test case 14.6.8 to HSD_ENH_r5 ATS V6.1.0	B	6.2.0	6.3.0	R5s070072
RP-36	RP-070352	2015		Addition of WB-AMR RAB test case 14.2.62 to HSD_ENH_r5 ATS V6.1.0	B	6.2.0	6.3.0	R5s070077
RP-36	RP-070359	2016		Summary of regression errors in 07wk08 HSUPA ATS	F	6.2.0	6.3.0	R5s070069
RP-36	RP-070359	2017		Correction to E-DCH testcases using rv0	F	6.2.0	6.3.0	R5s070071
RP-36	RP-070359	2018		Correction to approved 8.3.1.41 test case	F	6.2.0	6.3.0	R5s070130
RP-36	RP-070359	2019		Correction to test steps ts_InitVariablesHSU & ts_SS_RelDPCH_E_HS	F	6.2.0	6.3.0	R5s070098
RP-36	RP-070359	2020		Correction to E-DCH testcases 7.1.6.4.3	F	6.2.0	6.3.0	R5s070095
RP-36	RP-070359	2021		Correction to GCF WI-25 test case 7.1.6.2.2	F	6.2.0	6.3.0	R5s070138
RP-36	RP-070359	2022		Correction to E-DCH testcases 8.2.2.46 & 8.2.3.36	F	6.2.0	6.3.0	R5s070115
RP-36	RP-070347	2023		Correction to GCF WI-10 NAS Test Case 12.4.1.4a	F	6.2.0	6.3.0	R5s070128
RP-36	RP-070347	2024		Correction to GCF WI-10 Test Cases 9.4.5.4.1, 6.1.2.9a and 6.1.2.9b	F	6.2.0	6.3.0	R5s070129
RP-36	RP-070347	2025		Summary of regression errors in wk11 ATS	F	6.2.0	6.3.0	R5s070111
RP-36	RP-070347	2026		Summary of regression errors in wk08 ATS	F	6.2.0	6.3.0	R5s070090
RP-36	RP-070347	2027		Correction to GCF WI-10 RRC Test Case 12.9.6 , 12.4.2.4 , 12.2.1.4.1	F	6.2.0	6.3.0	R5s070092
RP-36	RP-070347	2028		Summary of Regression Errors in wk08 ATSS	F	6.2.0	6.3.0	R5s070087
RP-36	RP-070347	2029		Improvement on Guard Timer Timeout Handling	F	6.2.0	6.3.0	R5s070093
RP-36	RP-070347	2030		Summary of Regression errors in wk 11 IR_U ATS	F	6.2.0	6.3.0	R5s070134
RP-36	RP-070347	2031		Correction to GCF WI-10 NAS test case 9.4.2.2 Procedure 2	F	6.2.0	6.3.0	R5s070100
RP-36	RP-070347	2032		Correction to RRC testcase 8.4.1.8 & 8.4.1.28	F	6.2.0	6.3.0	R5s070097
RP-36	RP-070348	2033		Correction to RRC testcase 8.4.1.2 & 8.4.1.6	F	6.2.0	6.3.0	R5s070096
RP-36	RP-070348	2034		Removal of pc_MS_ClsmkFreqCap	F	6.2.0	6.3.0	R5s070094
RP-36	RP-070348	2035		Summary of regression errors in 07wk03 IRAT ATSS	F	6.2.0	6.3.0	R5s070049
RP-36	RP-070348	2036		Alignment of TTCN implementation of default radio configurations	F	6.2.0	6.3.0	R5s070135

Meet- ing	TSG doc	CR	Rev	Subject	Cat	Old vers	New vers	WG doc
RP-36	RP-070348	2037		Corrections to AGPS test cases 17.2.x (GCF WI-015)	F	6.2.0	6.3.0	R5s070075
RP-36	RP-070348	2038		Correction to RAB Test cases 14.4.2.1 and 14.4.2a.1	F	6.2.0	6.3.0	R5s070099
RP-36	RP-070348	2039		Correction to MRAT Idle mode testcases 6.2.1.1 and 6.2.1.6	F	6.2.0	6.3.0	R5s070066
RP-36	RP-070348	2040		Further correction to QOS checking for UE not support AT commands to start MO PS call	F	6.2.0	6.3.0	R5s070139
RP-36	RP-070348	2041		Rel-6 baseline upgrade	F	6.2.0	6.3.0	R5s070132
RP-36	RP-070348	2042		Summary of regression errors in wk11 ATS	F	6.2.0	6.3.0	R5s070142
RP-36	RP-070348	2043		Summary of regression errors in the wk08 HSDPA InterRAT ATS	F	6.2.0	6.3.0	R5s070067
RP-36	RP-070348	2044		Correction to GCF WI-10 Idle Mode test case 6.1.1.7	F	6.2.0	6.3.0	R5s070114
RP-36	RP-070348	2045		Correction to GCF WI-10 NAS Test Case 12.2.1.6 Proc 1 and 2	F	6.2.0	6.3.0	R5s070107
RP-36	RP-070348	2046		Correction to GCF WI-10 SMS Test Case 16.2.1	F	6.2.0	6.3.0	R5s070117
RP-36	RP-070348	2047		Corrections to the GCF WI-010 P4 test case 8.2.6.37	F	6.2.0	6.3.0	R5s070074
RP-36	RP-070352	2048		Correction to UM constraints used with type CRLC_Config_Req	F	6.2.0	6.3.0	R5s070070
RP-36	RP-070352	2049		Summary of regression errors in wk-11 MAC ATS	F	6.2.0	6.3.0	R5s070131
RP-36	RP-070352	2050		Correction to approved 8.2.6.39a and 8.2.6.39b test cases	F	6.2.0	6.3.0	R5s070076
RP-36	RP-070352	2051		Correction to WB-AMR RAB test cases 14.2.62, 14.2.4b and 14.6.8	F	6.2.0	6.3.0	R5s070136
RP-36	RP-070352	2052		Correction of approved GCF WI14 test case 8.3.7.14.	F	6.2.0	6.3.0	R5s070105
RP-36	RP-070352	2053		Corrections to WB-AMR RAB test cases 14.2.4b and 14.2.62	F	6.2.0	6.3.0	R5s070108
RP-36	RP-070348	2054		Correction to GCF WI-10 NAS Test Case 12.8	F	6.2.0	6.3.0	R5s070143
RP-36	RP-070348	2055		Correction to GCF WI-10 RRC test case 8.2.6.8	F	6.2.0	6.3.0	R5s070137
RP-36	RP-070359	2056		Correction to GCF WI-25 test case 7.1.6.2.2	F	6.2.0	6.3.0	R5s070144
RP-36	RP-070348	2057		Correction to GCF WI-10 Test Case 8.2.6.37 , 8.2.6.38	F	6.2.0	6.3.0	R5s070145
RP-36	RP-070347	2058		Addition of GCF WI-047 test case 8.4.1.24A to RRC ATS.	B	6.2.0	6.3.0	R5s070124
RP-36	RP-070348	2059		Correction to GCF WI-10 Idle Mode Test Case 6.1.2.6	F	6.2.0	6.3.0	R5s070146
RP-36	RP-070347	2060		Addition of GCF WI-047 test case 8.2.6.37b to RRC ATS	B	6.2.0	6.3.0	R5s070149
RP-36	RP-070359	2061		Correction to approved 7.1.6.4.3 test case	F	6.2.0	6.3.0	R5s070148
RP-36	RP-070352	2062		Corrections to GCF WI-13 and WI-14 WB-AMR Test Cases 14.2.4b, 14.2.62 and 14.6.8	F	6.2.0	6.3.0	R5s070147
RP-36	RP-070355	2063		CR to 34.123-3: Add new verified and e-mail agreed TTCN test cases in the TC lists in 34.123-3 (prose), Annex A	F	6.2.0	6.3.0	-
RP-36	RP-070358	2064		ASP enhancement for configuration of stand-alone UL-DPCH	F	6.2.0	6.3.0	R5-071030
RP-36	RP-070346	2065		Documentation of TSO and recovering erroneously removed IE in ASP	F	6.2.0	6.3.0	R5-071433
RP-36	RP-070354	2066		Editorial corrections in the reference list	F	6.2.0	6.3.0	R5-071445
RP-36	RP-070361	2067		Allocation of channel Id for MBMS test	F	6.2.0	6.3.0	R5-071461
RP-36	RP-070346	2068		Guideline on MCC setting for the Primary band cell	F	6.2.0	6.3.0	R5-071478
RP-37	RP-070605	2069	-	Add a new ASP for MBMS test	F	6.3.0	6.4.0	R5-072050
RP-37	RP-070593	2070	-	RoHC test model and ASP	F	6.3.0	6.4.0	R5-072051
RP-37	RP-070589	2071	-	Addition of ASP for FMO & addition of IE paging cycle splitting	F	6.3.0	6.4.0	R5-072466
RP-37	RP-070593	2072	-	Correction to RB identities mapping	F	6.3.0	6.4.0	R5-072337
RP-37	RP-070598	2073	-	CR to 34.123-3: Add new verified and e-mail agreed TTCN test cases in the TC lists in 34.123-3 (prose), Annex A	F	6.3.0	6.4.0	-
RP-37	RP-070590	2074	-	TTCN Correction in testcases 8.3.7.16, 8.3.7.17	F	6.3.0	6.4.0	R5s070209
RP-37	RP-070590	2075	-	Correction to GCF WI-10 RRC test case 8.4.1.14	F	6.3.0	6.4.0	R5s070199
RP-37	RP-070595	2076	-	Corrections to GCF WI-14 HSD Test Cases 8.3.1.40	F	6.3.0	6.4.0	R5s070179
RP-37	RP-070590	2077	-	TTCN Correction in testcases 8.1.7.1c, 8.2.6.39, 8.2.6.44, 8.3.1.25, 8.3.1.30	F	6.3.0	6.4.0	R5s070187
RP-37	RP-070590	2078	-	Correction to RRC testcase 8.2.6.37 & 8.2.6.38	F	6.3.0	6.4.0	R5s070198
RP-37	RP-070590	2079	-	Correction to IR_U and IR_G test suites to support split paging cycle on CCCH	F	6.3.0	6.4.0	R5s070190
RP-37	RP-070603	2080	-	Correction to GCF WI-25 HSUPA test case 8.2.6.54	F	6.3.0	6.4.0	R5s070173
RP-37	RP-070590	2081	-	Correction to test step "ts_AT_CmdCBST" for setting correct speed in case of 3G324M Call.	F	6.3.0	6.4.0	R5s070200
RP-37	RP-070590	2082	-	Correction to the test cases to enable Fach Measurement Occasion in the SS	F	6.3.0	6.4.0	R5s070189
RP-37	RP-070590	2083	-	Corrections to GCF WI-10 Test Cases 8.4.1.14	F	6.3.0	6.4.0	R5s070172
RP-37	RP-070590	2084	-	Corrections to GCF WI-14 RAB Testcase 14.6.3, 14.6.3a, 14.6.4, 14.6.4a, 14.6.7, 14.6.8	F	6.3.0	6.4.0	R5s070195

Meeting	TSG doc	CR	Rev	Subject	Cat	Old vers	New vers	WG doc
RP-37	RP-070590	2085	-	Correction to PDU loopback control timer used in RAB test cases	F	6.3.0	6.4.0	R5s070197
RP-37	RP-070590	2086	-	TTCN Correction in SMS testcase 16.1.1	F	6.3.0	6.4.0	R5s070188
RP-37	RP-070606	2087	-	Enhancement for new MBMS cells	F	6.3.0	6.4.0	R5s070184
RP-37	RP-070590	2088	-	Correction to GCF WI-15 AGPS test cases (17.2.4.1 to 9)	F	6.3.0	6.4.0	R5s070196
RP-37	RP-070590	2089	-	Corrections to GCF Interband Test Cases 6.1.2.1a and 6.1.2.10a for Band9	F	6.3.0	6.4.0	R5s070191
RP-37	RP-070590	2090	-	Corrections to GCF WI-10 Test Cases 8.4.1.8	F	6.3.0	6.4.0	R5s070180
RP-37	RP-070590	2091	-	Correction to Interband Test Cases 8.4.1.24A	F	6.3.0	6.4.0	R5s070177
RP-37	RP-070590	2092	-	Corrections to GCF WI-12 Test Case 8.2.2.43	F	6.3.0	6.4.0	R5s070192
RP-37	RP-070590	2093	-	Summary of Regression Errors in wk23 ATSS	F	6.3.0	6.4.0	R5s070183
RP-37	RP-070590	2094	-	Summary of regression errors in wk23 ATS	F	6.3.0	6.4.0	R5s070166
RP-37	RP-070590	2095	-	TTCN Correction in testcases 8.2.2.41, 8.2.2.42, 8.2.3.31, 8.2.3.32, 8.2.3.33, 8.2.3.34, 8.2.3.35	F	6.3.0	6.4.0	R5s070175
RP-37	RP-070590	2096	-	Summary of regression errors in the wk23 IR_U ATS.	F	6.3.0	6.4.0	R5s070171
RP-37	RP-070591	2097	-	Correction to MAC testcase 7.1.3.2	F	6.3.0	6.4.0	R5s070167
RP-37	RP-070603	2098	-	Correction to E-DCH RRC testcase 8.3.4.10	F	6.3.0	6.4.0	R5s070170
RP-37	RP-070591	2099	-	Correction to RRC testcase 8.2.6.37, 8.2.6.37b & 8.4.1.14	F	6.3.0	6.4.0	R5s070169
RP-37	RP-070595	2100	-	Correction to RRC testcase 8.4.1.47	F	6.3.0	6.4.0	R5s070168
RP-37	RP-070595	2101	-	Correction to DSAC test cases	F	6.3.0	6.4.0	R5s070165
RP-37	RP-070595	2102	-	Summary of Regression Errors in wk21 ATSS	F	6.3.0	6.4.0	R5s070164
RP-37	RP-070591	2103	-	Summary of regression errors in wk21 ATS	F	6.3.0	6.4.0	R5s070163
RP-37	RP-070591	2104	-	Summary of Regression Errors in wk17 ATSS	F	6.3.0	6.4.0	R5s070157
RP-37	RP-070591	2105	-	Corrections to GCF WI-10 Test Cases 8.4.1.8	F	6.3.0	6.4.0	R5s070161
RP-37	RP-070591	2106	-	Correction of approved GCF WI12 test case 8.2.6.44.	F	6.3.0	6.4.0	R5s070162
RP-37	RP-070603	2107	-	Addition of GCF WI-25 HSUPA test case 7.1.6.2.1 to HSU ATS v6.2.0	B	6.3.0	6.4.0	R5s070158
RP-37	RP-070603	2108	-	Addition of WB-AMR RAB test case 14.7.8 to HSU_ENH_r6 ATS V6.1.0	B	6.3.0	6.4.0	R5s070151
RP-37	RP-070591	2109	-	Summary of regression errors in wk18 ATS	F	6.3.0	6.4.0	R5s070154
RP-37	RP-070591	2110	-	Corrections to GCF WI-10 NAS Test Cases 9.4.8	F	6.3.0	6.4.0	R5s070155
RP-37	RP-070591	2111	-	Correction to BMC Test Cases 16.3 and 14.4.4	F	6.3.0	6.4.0	R5s070156
RP-37	RP-070591	2112	-	Correction of approved GCF WI12 test case 8.1.2.13.	F	6.3.0	6.4.0	R5s070153
RP-37	RP-070591	2113	-	Corrections to GCF WI-10 NAS Test Cases 8.3.9.1	F	6.3.0	6.4.0	R5s070213
RP-37	RP-070591	2114	-	Corrections to GCF WI-10 RRC test case 8.4.1.28	F	6.3.0	6.4.0	R5s070214
RP-37	RP-070591	2115	-	Cell setup issue in 16 Idle Mode, RRC and NAS test cases	F	6.3.0	6.4.0	R5s070210
RP-37	RP-070591	2116	-	Summary of regression errors in wk28 ATS	F	6.3.0	6.4.0	R5s070215
RP-37	RP-070591	2117	-	Addition of GCF WI-047 test case 8.3.1.1a to RRC ATS.	B	6.3.0	6.4.0	R5s070185
RP-37	RP-070591	2118	-	TTCN Correction in testcase 6.2.2.2	F	6.3.0	6.4.0	R5s070216
RP-37	RP-070591	2119	-	Addition of GCF WI-047 test case 8.3.2.1a to RRC ATS.	B	6.3.0	6.4.0	R5s070193
RP-37	RP-070603	2120	-	Addition of GCF WI-25 HSUPA test case 8.4.1.49 to HSU ATS v6.3.0	B	6.3.0	6.4.0	R5s070202
RP-38	RP-070873	2121		Correction of max bit rate in QoS and AT commands for different UE categories and other maintenance	F	6.4.0	6.5.0	R5-073030
RP-38	RP-070873	2122		Application of synchronized data sending on MTCH and other maintenance for MBMS	F	6.4.0	6.5.0	R5-073032
RP-38	RP-070860	2123		Handling RLP XID in CSD call	F	6.4.0	6.5.0	R5-073467
RP-38	RP-070860	2124		R99 routine maintenance for PIXIT etc	F	6.4.0	6.5.0	R5-073435
RP-38	RP-070864	2125		To add new RRC test case 8.2.1.8 to the LCR TDD RRC ATS	B	6.4.0	6.5.0	R5s070283
RP-38	RP-070864	2126		To add new GMM test case 12.7 to the LCR TDD NAS ATS	B	6.4.0	6.5.0	R5s070444
RP-38	RP-070864	2127		To add new RRC test case 8.1.1.1 to the LCR TDD RRC ATS	B	6.4.0	6.5.0	R5s070281
RP-38	RP-070864	2128		To add new GMM test case 12.2.1.1 to the LCR TDD NAS ATS	B	6.4.0	6.5.0	R5s070291
RP-38	RP-070864	2129		To add new test case 16.1.1 to the LCR TDD SMS ATS	B	6.4.0	6.5.0	R5s070293
RP-38	RP-070864	2130		To add new SM test case 11.1.1.1 to the LCR TDD NAS ATS	B	6.4.0	6.5.0	R5s070301
RP-38	RP-070864	2131		To add new test case 18.1.2.6 to the LCR TDD RAB ATS	B	6.4.0	6.5.0	R5s070295
RP-38	RP-070864	2132		To add new test case 7.1.1.1 to the LCR TDD MAC ATS	B	6.4.0	6.5.0	R5s070297
RP-38	RP-070864	2133		To add new test case 7.2.3.12 to the LCR TDD RLC ATS	B	6.4.0	6.5.0	R5s070299
RP-38	RP-070864	2134		To add new test case 13.2.1.1 to the LCR TDD NAS	B	6.4.0	6.5.0	R5s070303

Meeting	TSG doc	CR	Rev	Subject	Cat	Old vers	New vers	WG doc
				ATS				
RP-38	RP-070864	2135		To add new RRC test case 8.1.1.4 to the LCR TDD RRC ATS	B	6.4.0	6.5.0	R5s070309
RP-38	RP-070864	2136		To add new RRC test case 8.1.12 to the LCR TDD RRC ATS	B	6.4.0	6.5.0	R5s070307
RP-38	RP-070864	2137		To add new RRC test case 8.1.5.4 to the LCR TDD RRC ATS	B	6.4.0	6.5.0	R5s070323
RP-38	RP-070864	2138		To add new RRC test case 8.1.9 to the LCR TDD RRC ATS	B	6.4.0	6.5.0	R5s070325
RP-38	RP-070864	2139		To add new RRC test case 8.2.2.11 to the LCR TDD RRC ATS	B	6.4.0	6.5.0	R5s070331
RP-38	RP-070864	2140		To add new RRC test case 8.1.5.1 to the LCR TDD RRC ATS	B	6.4.0	6.5.0	R5s070321
RP-38	RP-070864	2141		To add new RRC test case 8.2.2.9 to the LCR TDD RRC ATS	B	6.4.0	6.5.0	R5s070329
RP-38	RP-070864	2142		To add new RRC test case 8.2.2.8 to the LCR TDD RRC ATS	B	6.4.0	6.5.0	R5s070327
RP-38	RP-070864	2143		To add new RRC test case 8.2.3.7 to the LCR TDD RRC ATS	B	6.4.0	6.5.0	R5s070335
RP-38	RP-070864	2144		To add new RRC test case 8.2.3.11 to the LCR TDD RRC ATS	B	6.4.0	6.5.0	R5s070339
RP-38	RP-070865	2145		To add new RRC test case 8.2.3.9 to the LCR TDD RRC ATS	B	6.4.0	6.5.0	R5s070337
RP-38	RP-070865	2146		To add new RRC test case 8.2.2.17 to the LCR TDD RRC ATS	B	6.4.0	6.5.0	R5s070333
RP-38	RP-070865	2147		To add new RRC test case 8.2.6.7 to the LCR TDD RRC ATS	B	6.4.0	6.5.0	R5s070347
RP-38	RP-070865	2148		To add new RRC test case 8.2.3.29 to the LCR TDD RRC ATS	B	6.4.0	6.5.0	R5s070345
RP-38	RP-070865	2149		To add new RRC test case 8.2.6.11 to the LCR TDD RRC ATS	B	6.4.0	6.5.0	R5s070349
RP-38	RP-070865	2150		To add new RRC test case 8.2.3.15 to the LCR TDD RRC ATS	B	6.4.0	6.5.0	R5s070341
RP-38	RP-070865	2151		To add new RRC test case 8.4.1.17 to the LCR TDD RRC ATS	B	6.4.0	6.5.0	R5s070353
RP-38	RP-070865	2152		To add new MM test case 9.2.1 to the LCR TDD NAS ATS	B	6.4.0	6.5.0	R5s070358
RP-38	RP-070865	2153		To add new RRC test case 8.2.6.20 to the LCR TDD RRC ATS	B	6.4.0	6.5.0	R5s070351
RP-38	RP-070865	2154		To add new RRC test case 8.4.1.24 to the LCR TDD RRC ATS	B	6.4.0	6.5.0	R5s070355
RP-38	RP-070865	2155		To add new MM test case 9.5.2 to the LCR TDD NAS ATS	B	6.4.0	6.5.0	R5s070362
RP-38	RP-070865	2156		To add new MM test case 9.4.4 to the LCR TDD NAS ATS	B	6.4.0	6.5.0	R5s070360
RP-38	RP-070865	2157		To add new CC test case 10.1.2.2.2 to the LCR TDD NAS ATS	B	6.4.0	6.5.0	R5s070368
RP-38	RP-070865	2158		To add new CC test case 10.1.2.2.3 to the LCR TDD NAS ATS	B	6.4.0	6.5.0	R5s070370
RP-38	RP-070865	2159		To add new test case 13.2.2.2 to the LCR TDD NAS ATS	B	6.4.0	6.5.0	R5s070480
RP-38	RP-070865	2160		To add new RRC test case 8.4.1.16 to the LCR TDD RRC ATS	B	6.4.0	6.5.0	R5s070285
RP-38	RP-070865	2161		To add new CC test case 10.1.2.2.1 to the LCR TDD NAS ATS	B	6.4.0	6.5.0	R5s070366
RP-38	RP-070865	2162		To add new CC test case 10.1.2.4.6 to the LCR TDD NAS ATS	B	6.4.0	6.5.0	R5s070384
RP-38	RP-070865	2163		To add new CC test case 10.1.2.7.3 to the LCR TDD NAS ATS	B	6.4.0	6.5.0	R5s070408
RP-38	RP-070865	2164		To add new GMM test case 12.4.3.1 to the LCR TDD NAS ATS	B	6.4.0	6.5.0	R5s070440
RP-38	RP-070866	2165		To add new GMM test case 12.5 to the LCR TDD NAS ATS	B	6.4.0	6.5.0	R5s070442
RP-38	RP-070866	2166		To add new test case 7.1.1.8 to the LCR TDD MAC ATS	B	6.4.0	6.5.0	R5s070470
RP-38	RP-070866	2167		To add new test case 7.2.3.34 to the LCR TDD RLC ATS	B	6.4.0	6.5.0	R5s070474
RP-38	RP-070866	2168		To add new CC test case 10.1.3.3.1 to the LCR TDD NAS ATS	B	6.4.0	6.5.0	R5s070412
RP-38	RP-070866	2169		To add new GMM test case 12.3.1.1 to the LCR TDD NAS ATS	B	6.4.0	6.5.0	R5s070428
RP-38	RP-070866	2170		To add new RRC test case 8.1.1.7 to the LCR TDD RRC ATS	B	6.4.0	6.5.0	R5s070311

Meeting	TSG doc	CR	Rev	Subject	Cat	Old vers	New vers	WG doc
RP-38	RP-070866	2171		To add new MM test case 9.1 to the LCR TDD NAS ATS	B	6.4.0	6.5.0	R5s070287
RP-38	RP-070866	2172		To add new CC test case 10.1.2.4.8 to the LCR TDD NAS ATS	B	6.4.0	6.5.0	R5s070388
RP-38	RP-070866	2173		To add new GMM test case 12.4.1.1b to the LCR TDD NAS ATS	B	6.4.0	6.5.0	R5s070436
RP-38	RP-070866	2174		To add new SM test case 11.3.1 to the LCR TDD NAS ATS	B	6.4.0	6.5.0	R5s070476
RP-38	RP-070866	2175		To add new GMM test case 12.3.1.2 to the LCR TDD NAS ATS	B	6.4.0	6.5.0	R5s070430
RP-38	RP-070866	2176		To add new test case 16.1.9.2 to the LCR TDD SMS ATS	B	6.4.0	6.5.0	R5s070458
RP-38	RP-070866	2177		To add new CC test case 10.1.2.3.3 to the LCR TDD NAS ATS	B	6.4.0	6.5.0	R5s070376
RP-38	RP-070866	2178		To add new CC test case 10.1.2.3.7 to the LCR TDD NAS ATS	B	6.4.0	6.5.0	R5s070378
RP-38	RP-070866	2179		To add new CC test case 10.1.2.3.2 to the LCR TDD NAS ATS	B	6.4.0	6.5.0	R5s070374
RP-38	RP-070866	2180		To add new CC test case 10.1.2.7.2 to the LCR TDD NAS ATS	B	6.4.0	6.5.0	R5s070406
RP-38	RP-070866	2181		To add new GMM test case 12.9.4 to the LCR TDD NAS ATS	B	6.4.0	6.5.0	R5s070452
RP-38	RP-070866	2182		To add new GMM test case 12.9.2 to the LCR TDD NAS ATS	B	6.4.0	6.5.0	R5s070448
RP-38	RP-070866	2183		To add new CC test case 10.1.3.3.4 to the LCR TDD NAS ATS	B	6.4.0	6.5.0	R5s070416
RP-38	RP-070866	2184		To add new RRC test case 8.1.3.3 to the LCR TDD RRC ATS	B	6.4.0	6.5.0	R5s070319
RP-38	RP-070867	2185		To add new CC test case 10.1.3.3.2 to the LCR TDD NAS ATS	B	6.4.0	6.5.0	R5s070414
RP-38	RP-070867	2186		To add new GMM test case 12.4.2.2 to the LCR TDD NAS ATS	B	6.4.0	6.5.0	R5s070438
RP-38	RP-070867	2187		To add new CC test case 10.1.2.4.9 to the LCR TDD NAS ATS	B	6.4.0	6.5.0	R5s070390
RP-38	RP-070867	2188		To add new test case 18.1.2.13.2 to the LCR TDD RAB ATS	B	6.4.0	6.5.0	R5s070462
RP-38	RP-070867	2189		To add new CC test case 10.1.2.4.10 to the LCR TDD NAS ATS	B	6.4.0	6.5.0	R5s070392
RP-38	RP-070867	2190		To add new CC test case 10.1.2.4.7 to the LCR TDD NAS ATS	B	6.4.0	6.5.0	R5s070386
RP-38	RP-070867	2191		To add new RRC test case 8.1.3.1 to the LCR TDD RRC ATS	B	6.4.0	6.5.0	R5s070317
RP-38	RP-070867	2192		To add new CC test case 10.1.2.1.1 to the LCR TDD NAS ATS	B	6.4.0	6.5.0	R5s070289
RP-38	RP-070867	2193		To add new CC test case 10.1.2.4.4 to the LCR TDD NAS ATS	B	6.4.0	6.5.0	R5s070382
RP-38	RP-070867	2194		To add new test case 18.1.2.7 to the LCR TDD RAB ATS	B	6.4.0	6.5.0	R5s070460
RP-38	RP-070867	2195		To add new CC test case 10.1.2.6.2 to the LCR TDD NAS ATS	B	6.4.0	6.5.0	R5s070398
RP-38	RP-070867	2196		To add new GMM test case 12.2.1.3 to the LCR TDD NAS ATS	B	6.4.0	6.5.0	R5s070422
RP-38	RP-070867	2197		To add new GMM test case 12.9.1 to the LCR TDD NAS ATS	B	6.4.0	6.5.0	R5s070446
RP-38	RP-070867	2198		To add new CC test case 10.1.2.5.2 to the LCR TDD NAS ATS	B	6.4.0	6.5.0	R5s070394
RP-38	RP-070867	2199		To add new CC test case 10.1.2.6.3 to the LCR TDD NAS ATS	B	6.4.0	6.5.0	R5s070400
RP-38	RP-070867	2200		To add new CC test case 10.1.2.6.6 to the LCR TDD NAS ATS	B	6.4.0	6.5.0	R5s070402
RP-38	RP-070867	2201		To add new CC test case 10.1.2.9.1 to the LCR TDD NAS ATS	B	6.4.0	6.5.0	R5s070410
RP-38	RP-070867	2202		To add new MM test case 9.5.4 to the LCR TDD NAS ATS	B	6.4.0	6.5.0	R5s070364
RP-38	RP-070867	2203		To add new CC test case 10.1.2.4.3 to the LCR TDD NAS ATS	B	6.4.0	6.5.0	R5s070380
RP-38	RP-070867	2204		To add new CC test case 10.1.2.3.1 to the LCR TDD NAS ATS	B	6.4.0	6.5.0	R5s070372
RP-38	RP-070868	2205		To add new CC test case 10.1.2.5.5 to the LCR TDD NAS ATS	B	6.4.0	6.5.0	R5s070396
RP-38	RP-070868	2206		To add new test case 18.1.2.15 to the LCR TDD RAB ATS	B	6.4.0	6.5.0	R5s070464
RP-38	RP-070868	2207		To add new RRC test case 8.1.1.8 to the LCR TDD	B	6.4.0	6.5.0	R5s070313

Meeting	TSG doc	CR	Rev	Subject	Cat	Old vers	New vers	WG doc
				RRC ATS				
RP-38	RP-070868	2208		To add new GMM test case 12.9.14 to the LCR TDD NAS ATS	B	6.4.0	6.5.0	R5s070454
RP-38	RP-070868	2209		To add new test case 13.2.2.1 to the LCR TDD NAS ATS	B	6.4.0	6.5.0	R5s070478
RP-38	RP-070868	2210		To add new RRC test case 8.2.3.19 to the LCR TDD RRC ATS	B	6.4.0	6.5.0	R5s070343
RP-38	RP-070868	2211		To add new test case 16.1.2 to the LCR TDD SMS ATS	B	6.4.0	6.5.0	R5s070456
RP-38	RP-070868	2212		To add new CC test case 10.1.2.7.1 to the LCR TDD NAS ATS	B	6.4.0	6.5.0	R5s070404
RP-38	RP-070868	2213		To add new GMM test case 12.2.1.7 to the LCR TDD NAS ATS	B	6.4.0	6.5.0	R5s070424
RP-38	RP-070868	2214		To add new test case 18.1.2.26 to the LCR TDD RAB ATS	B	6.4.0	6.5.0	R5s070466
RP-38	RP-070868	2215		To add new CC test case 10.1.3.5.6 to the LCR TDD NAS ATS	B	6.4.0	6.5.0	R5s070420
RP-38	RP-070868	2216		To add new test case 7.1.3.1 to the LCR TDD MAC ATS	B	6.4.0	6.5.0	R5s070472
RP-38	RP-070868	2217		To add new GMM test case 12.9.3 to the LCR TDD NAS ATS	B	6.4.0	6.5.0	R5s070450
RP-38	RP-070868	2218		To add new RRC test case 8.1.2.7 to the LCR TDD RRC ATS	B	6.4.0	6.5.0	R5s070315
RP-38	RP-070868	2219		To add new CC test case 10.1.3.4.1 to the LCR TDD NAS ATS	B	6.4.0	6.5.0	R5s070418
RP-38	RP-070868	2220		To add new GMM test case 12.2.2.1 to the LCR TDD NAS ATS	B	6.4.0	6.5.0	R5s070426
RP-38	RP-070868	2221		To add new test case 7.1.1.2 to the LCR TDD MAC ATS	B	6.4.0	6.5.0	R5s070468
RP-38	RP-070868	2222		To add new GMM test case 12.3.2.1 to the LCR TDD NAS ATS	B	6.4.0	6.5.0	R5s070434
RP-38	RP-070868	2223		To add new GMM test case 12.3.1.5 to the LCR TDD NAS ATS	B	6.4.0	6.5.0	R5s070432
RP-38	RP-070868	2224		To add new NAS test case 9.3.1 to the LCR TDD NAS ATS	B	6.4.0	6.5.0	R5s070217
RP-38	RP-070890	2225		CR to 34.123-3: Add new verified and e-mail agreed TTCN test cases in the TC lists in 34.123-3 (prose), Annex A	F	6.4.0	6.5.0	-
RP-38	RP-070862	2226		Corrections to GCF WI-10 and Interband RRC testcase 8.2.6.37 and 8.2.6.37b	F	6.4.0	6.5.0	R5s070357
RP-38	RP-070861	2227		Correction to testcase 8.4.1.49 & 8.3.4.10	F	6.4.0	6.5.0	R5s070483
RP-38	RP-070861	2228		Correction to GCF WI-010 RRC test case 8.3.1.6	F	6.4.0	6.5.0	R5s070482
RP-38	RP-070861	2229		Handling of A5_1 for UE not supporting GSM.	F	6.4.0	6.5.0	R5s070484
RP-38	RP-070862	2230		TTCN Correction in HSUPA testcases	F	6.4.0	6.5.0	R5s070276
RP-38	RP-070861	2231		Corrections to GCF WI-10 RRC test case 6.1.2.1	F	6.4.0	6.5.0	R5s070225
RP-38	RP-070861	2232		Introduction of wait timer for RRC Connection Request in preamble	F	6.4.0	6.5.0	R5s070221
RP-38	RP-070861	2233		Correction to GCF WI-013 InterRAT test case 8.3.11.13	F	6.4.0	6.5.0	R5s070222
RP-38	RP-070870	2234		Corrections to GCF WI-014 WB-AMR test case 14.6.8	F	6.4.0	6.5.0	R5s070224
RP-38	RP-070861	2235		Corrections to GCF WI-10 IR_U test cases 6.2.1.X, 8.3.7.1, 8.3.7.3	F	6.4.0	6.5.0	R5s070219
RP-38	RP-070861	2236		Correction to AGPS test cases 17.2.3.2, 17.2.3.3, 17.2.3.4, 17.2.3.8, 17.2.3.9	F	6.4.0	6.5.0	R5s070220
RP-38	RP-070861	2237		Correction to the RRC test case 8.2.2.43, 8.2.6.39 and 8.2.6.44	F	6.4.0	6.5.0	R5s070226
RP-38	RP-070875	2238		Addition of GCF WI-25 EDCH RRC test case 8.2.1.36	B	6.4.0	6.5.0	R5s070248
RP-38	RP-070875	2239		Addition of GCF WI-25 HSUPA test case 8.2.2.44 to HSU ATS v6.3.0	B	6.4.0	6.5.0	R5s070245
RP-38	RP-070875	2240		Addition of GCF WI-25 EDCH RRC test case 8.2.2.47	B	6.4.0	6.5.0	R5s070243
RP-38	RP-070861	2241		Wk36 Regression errors in testcase 6.2.1.8	F	6.4.0	6.5.0	R5s070257
RP-38	RP-070861	2242		Summary of regression errors in wk36 ATS	F	6.4.0	6.5.0	R5s070255
RP-38	RP-070875	2243		Modification of UL and DL max bit rate in QoS for HSPA	F	6.4.0	6.5.0	R5s070254
RP-38	RP-070875	2244		Addition of GCF WI-024 test case 6.2.2.4 to HSU_ENH_r6 ATS V6.3.0.	B	6.4.0	6.5.0	R5s070227
RP-38	RP-070875	2245		Modification of Logical Channel Id for RB25 in multical scenario	F	6.4.0	6.5.0	R5s070256
RP-38	RP-070875	2246		Addition of GCF WI-024 test case 6.2.2.5 to HSU_ENH_r6 ATS V6.3.0.	B	6.4.0	6.5.0	R5s070235
RP-38	RP-070861	2247		Addition of RRC test case 8.2.2.50	B	6.4.0	6.5.0	R5s070263
RP-38	RP-070875	2248		Asn.1 6d0 patch for the support of F-DPCH Support	F	6.4.0	6.5.0	R5s070223

Meeting	TSG doc	CR	Rev	Subject	Cat	Old vers	New vers	WG doc
				Indicator				
RP-38	RP-070861	2249		Summary of regression errors in wk38 ATS	F	6.4.0	6.5.0	R5s070258
RP-38	RP-070870	2250		Correction to GCF WI-14 Test Case 8.2.6.48	F	6.4.0	6.5.0	R5s070267
RP-38	RP-070861	2251		Corrections to GCF WI-10 RRC test case 6.1.2.1	F	6.4.0	6.5.0	R5s070266
RP-38	RP-070875	2252		TTCN Correction in GMM testcase 12.9.15	F	6.4.0	6.5.0	R5s070269
RP-38	RP-070861	2253		TTCN Correction in testcases 9.5.4, 9.5.5, 9.5.7.1	F	6.4.0	6.5.0	R5s070268
RP-38	RP-070875	2254		Introduce a more strict detection of the usage of RACH TF2 for UL CCCH transmission	F	6.4.0	6.5.0	R5s070270
RP-38	RP-070875	2255		Correction to GCF WI-25 test cases 8.3.1.41 and 8.2.6.50	F	6.4.0	6.5.0	R5s070272
RP-38	RP-070875	2256		Removal of GSM ciphering algorithm A5/2	F	6.4.0	6.5.0	R5s070275
RP-38	RP-070861	2257		Correction to RRC testcase 8.4.1.42	F	6.4.0	6.5.0	R5s070306
RP-38	RP-070861	2258		Correction to GCF Testcase 8.1.2.1, 8.1.2.7, 8.1.2.11, 8.1.5.1, 8.1.5.4, 8.1.7.1, 8.1.7.1b, 8.1.7.1c, 8.1.7.2, 8.1.12	F	6.4.0	6.5.0	R5s070279
RP-38	RP-070861	2259		Correction to RRC testcase 8.1.10.1	F	6.4.0	6.5.0	R5s070305
RP-38	RP-070861	2260		Summary of regression errors in wk38 ATS	F	6.4.0	6.5.0	R5s070271
RP-38	RP-070861	2261		Correction to the TTCN to Handle optional Packet Resource Request message	F	6.4.0	6.5.0	R5s070277
RP-38	RP-070862	2262		Summary of regression errors in wk38 ATS	F	6.4.0	6.5.0	R5s070278
RP-39	RP-080097	2263		Update RLP and MBMS RLC test models	F	6.5.0	6.6.0	R5-080364
RP-39	RP-080098	2264		Correction to AT commands used in 3GPP ATSS	F	6.5.0	6.6.0	R5-080218
RP-39	RP-080091	2265		Corrections to the PIXIT items	F	6.5.0	6.6.0	R5-080269
RP-39	RP-080098	2266		Removal of PDF version in formal deliveries	F	6.5.0	6.6.0	R5-080566
RP-39	RP-080110	2267		Introducing Rel-7 test model	F	6.5.0	6.6.0	R5-080044r3
RP-39	RP-080090	2269		CR to 34.123-3: Add new verified and e-mail agreed TTCN test cases in the TC lists in 34.123-3 (prose), Annex A	F	6.5.0	6.6.0	-
RP-39	RP-080099	2270		Summary of regression errors in MBMS wk03 ATS	F	6.5.0	6.6.0	R5s080013
RP-39	RP-080092	2271		Correction to GCF WI-010 RRC test case 8.3.3.1	F	6.5.0	6.6.0	R5s080007
RP-39	RP-080094	2272		Correction to testcase 7.1.5.6	F	6.5.0	6.6.0	R5s080005
RP-39	RP-080099	2273		Upgrade RRC asn.1 for tc 8.5.2.1 – UE supporting MBMS service change for a ptp RB	F	6.5.0	6.6.0	R5s080012
RP-39	RP-080092	2274		Summary of regression errors in wk49 ATS	F	6.5.0	6.6.0	R5s080002
RP-39	RP-080092	2275		Correction to PDU definition DTMINFORMATION in IRU ATS	F	6.5.0	6.6.0	R5s080003
RP-39	RP-080099	2276		Correction to SIB5 in MBMS ATS	F	6.5.0	6.6.0	R5s080006
RP-39	RP-080099	2277		Addition of GCF WI 49 MBMS RRC test case 8.5.3.2	B	6.5.0	6.6.0	R5s070571
RP-39	RP-080099	2278		Addition of GCF WI 49 MBMS RRC test case 8.5.5.2	B	6.5.0	6.6.0	R5s070584
RP-39	RP-080099	2279		Addition to MBMS RRC test case 8.5.5.1	B	6.5.0	6.6.0	R5s070596
RP-39	RP-080099	2280		Addition of GCF WI 49 MBMS RRC test case 8.5.5.3	B	6.5.0	6.6.0	R5s070586
RP-39	RP-080099	2281		Corrections to GCF WI-24 Network Sharing test case 6.2.2.4	F	6.5.0	6.6.0	R5s070592
RP-39	RP-080099	2282		Addition of RRC test case 6.1.1.9 to HSU_ENH_r6 ATS V6.4.0	B	6.5.0	6.6.0	R5s070526
RP-39	RP-080092	2283		TTCN Correction in 8.3.1.30	F	6.5.0	6.6.0	R5s070593
RP-39	RP-080099	2284		Addition of RRC test case 6.1.1.8 to HSU_ENH_r6 ATS V6.4.0	B	6.5.0	6.6.0	R5s070524
RP-39	RP-080092	2285		Summary of regression errors in wk49 ATS	F	6.5.0	6.6.0	R5s070562
RP-39	RP-080092	2286		Summary of regression errors in wk49 ATS	F	6.5.0	6.6.0	R5s070600
RP-39	RP-080099	2287		Addition of RRC test case 8.3.3.4 to HSU_ENH_r6 ATS	B	6.5.0	6.6.0	R5s070508
RP-39	RP-080099	2288		Addition of GCF WI-25 EDCH RRC test case 8.2.2.49	B	6.5.0	6.6.0	R5s070504
RP-39	RP-080099	2289		Addition of GCF WI-024 test case 6.2.1.10 to HSU_ENH_r6 ATS V6.5.0.	B	6.5.0	6.6.0	R5s070273
RP-39	RP-080099	2290		Addition to MBMS RRC test case 8.5.5.7	B	6.5.0	6.6.0	R5s070598
RP-39	RP-080099	2291		Addition of GCF WI 49 MBMS RRC test case 8.5.1.12	B	6.5.0	6.6.0	R5s070563
RP-39	RP-080099	2292		Addition of GCF WI 49 MBMS RRC test case 8.5.1.2	B	6.5.0	6.6.0	R5s070569
RP-39	RP-080092	2293		Summary of regression errors in wk49 ATS	F	6.5.0	6.6.0	R5s070591
RP-39	RP-080099	2294		Addition of GCF WI-25 EDCH RRC test case 8.2.1.36a	B	6.5.0	6.6.0	R5s070594
RP-39	RP-080099	2295		Addition of RRC test case 8.1.1.11 to HSU_ENH_r6 ATS	B	6.5.0	6.6.0	R5s070530
RP-39	RP-080099	2296		Addition of GCF WI 49 MBMS NAS test case 12.9.17	B	6.5.0	6.6.0	R5s070528
RP-39	RP-080099	2297		Addition of GCF WI 49 MBMS RRC test case 8.5.4.1	B	6.5.0	6.6.0	R5s070573
RP-39	RP-080100	2298		Addition of GCF WI-25 EDCH RRC test case 8.2.6.52	B	6.5.0	6.6.0	R5s070522
RP-39	RP-080100	2299		Addition of GCF WI 49 MBMS RRC test case 8.5.5.4	B	6.5.0	6.6.0	R5s070588
RP-39	RP-080100	2300		Addition of GCF WI 49 MBMS RRC test case 8.5.1.13	B	6.5.0	6.6.0	R5s070565
RP-39	RP-080100	2301		Addition of GCF WI 49 MBMS RRC test case 8.5.1.9	B	6.5.0	6.6.0	R5s070582
RP-39	RP-080100	2302		Addition of GCF WI-25 EDCH RRC Testcase 8.1.2.18 to HSU_ENH_r6 ATS v6.5.0	B	6.5.0	6.6.0	R5s070575
RP-39	RP-080092	2303		Summary of regression errors in wk47 ATS	F	6.5.0	6.6.0	R5s070520

Meeting	TSG doc	CR	Rev	Subject	Cat	Old vers	New vers	WG doc
RP-39	RP-080100	2304		Addition of GCF WI 49 MBMS RRC test case 8.5.1.11	B	6.5.0	6.6.0	R5s070567
RP-39	RP-080100	2305		Addition of GCF WI 49 MBMS RRC test case 8.5.1.3	B	6.5.0	6.6.0	R5s070516
RP-39	RP-080100	2306		Correction to GCF WI-25 Test Case 8.2.2.47	F	6.5.0	6.6.0	R5s070521
RP-39	RP-080100	2307		Addition of GCF WI 25 EDCH RRC test case 8.3.1.42a	B	6.5.0	6.6.0	R5s070510
RP-39	RP-080100	2308		Addition of GCF WI-25 EDCH RRC test case 8.3.1.43	B	6.5.0	6.6.0	R5s070512
RP-39	RP-080100	2309		Addition of GCF WI 25 EDCH RAB test case 14.7.3	B	6.5.0	6.6.0	R5s070559
RP-39	RP-080100	2310		Addition of GCF WI 25 EDCH RRC test case 8.2.2.47a	B	6.5.0	6.6.0	R5s070557
RP-39	RP-080100	2311		Addition of GCF WI-25 EDCH RRC test case 8.3.1.42	B	6.5.0	6.6.0	R5s070499
RP-39	RP-080094	2312		TTCN Correction in testcase 8.3.1.34	F	6.5.0	6.6.0	R5s070497
RP-39	RP-080100	2313		Addition of GCF WI-25 EDCH RRC Testcase 8.1.2.17 to HSU_ENH_r6 ATS v6.4.0	B	6.5.0	6.6.0	R5s070514
RP-39	RP-080100	2314		Addition of GCF WI 49 MBMS RRC test case 14.4.5	B	6.5.0	6.6.0	R5s070518
RP-39	RP-080100	2315		Addition of GCF WI-24 Network Sharing test case 6.1.2.11 to HSU_ENH_r6 ATS v6.4.0	B	6.5.0	6.6.0	R5s070501
RP-39	RP-080100	2316		Addition of GCF WI-25 EDCH RRC test case 8.2.2.44a	B	6.5.0	6.6.0	R5s070506
RP-39	RP-080100	2317		Summary of regression errors in the wk43 InterRAT ATSS.	F	6.5.0	6.6.0	R5s070486
RP-39	RP-080092	2318		TTCN Correction in testcase 8.4.1.42	F	6.5.0	6.6.0	R5s070498
RP-39	RP-080092	2319		Correction to the TTCN to update ASP G_CL1_ComingFN_REQ	F	6.5.0	6.6.0	R5s070496
RP-39	RP-080092	2320		Summary of regression errors in wk43 ATS	F	6.5.0	6.6.0	R5s070280
RP-39	RP-080100	2321		Corrections to GCF WI-24 Network Sharing test case 6.2.2.4	F	6.5.0	6.6.0	R5s070494
RP-39	RP-080092	2322		Summary of regression errors in wk43 ATS	F	6.5.0	6.6.0	R5s070495
RP-39	RP-080092	2323		Correction to testcase 8.2.6.37, 8.2.6.37b & 8.3.4.3	F	6.5.0	6.6.0	R5s070485
RP-39	RP-080100	2324		Addition of MBMS RAB test case 14.4.7	B	6.5.0	6.6.0	R5s070233
RP-39	RP-080101	2325		Addition of MBMS RAB test case 14.4.6	B	6.5.0	6.6.0	R5s070241
RP-39	RP-080101	2326		Addition of MBMS RRC test case 8.5.1.5	B	6.5.0	6.6.0	R5s070252
RP-39	RP-080101	2327		Addition of MBMS RRC test case 8.5.1.4	B	6.5.0	6.6.0	R5s070250
RP-39	RP-080101	2328		Addition of MBMS RRC test case 8_5_4_3	B	6.5.0	6.6.0	R5s080010
RP-39	RP-080101	2329		Addition of GCF WI 49 RRC MBMS test case 8.5.2.2	B	6.5.0	6.6.0	R5s080008
RP-39	RP-080092	2330		Summary of regression errors in wk03 ATS	F	6.5.0	6.6.0	R5s080035
RP-39	RP-080092	2331		Correction to GCF WI-10 RRC Testcase 8.4.1.42	F	6.5.0	6.6.0	R5s080023
RP-39	RP-080101	2332		Addition of GCF WI 25 HSUPA RAB test case 14.7.7	B	6.5.0	6.6.0	R5s080033
RP-39	RP-080101	2333		Addition of GCF WI 25 HSUPA RAB test case 14.7.6	B	6.5.0	6.6.0	R5s080031
RP-39	RP-080092	2334		TTCN Correction in testcase 8.1.1.9	F	6.5.0	6.6.0	R5s080028
RP-39	RP-080094	2335		TTCN Correction in testcase 8.1.6.5	F	6.5.0	6.6.0	R5s080024
RP-39	RP-080092	2336		Correction to testcase 8.4.1.42	F	6.5.0	6.6.0	R5s080027
RP-39	RP-080092	2337		Correction to testcase 8.3.4.1 & 8.3.4.2	F	6.5.0	6.6.0	R5s080026
RP-39	RP-080092	2338		Correction to Interband Testcase 8.3.1.1a	F	6.5.0	6.6.0	R5s080022
RP-39	RP-080092	2339		Correction to testcase 12.4.1.4c2	F	6.5.0	6.6.0	R5s080025
RP-39	RP-080098	2268		Production of pointer version 6.6.0 of TS 34.123-3 with no technical contents	F	6.5.0	6.6.0	R5-080554
RP-39				Upgraded to Rel-7 without technical change (on request of RAN5)		6.6.0	7.0.0	
RP-40	RP-080430	2381		ASP corrections for Rel-7 test model		7.0.0	7.1.0	R5-081510
RP-40	RP-080429	2382		ASP improvement when configuring MICH and PICH		7.0.0	7.1.0	R5-081523
RP-40	RP-080363	2383		R99 TSO routine maintenance		7.0.0	7.1.0	R5-081058
RP-40	RP-080430	2384		PIXIT for UE LCS Notification timeout timer added		7.0.0	7.1.0	R5-081571
RP-40	RP-080370	2385		Guidance of test execution when Introducing Operating Bands XII, XIII and XIV		7.0.0	7.1.0	R5-081536
RP-40	RP-080366	2340		CR to 34.123-3: Add new verified and e-mail agreed TTCN test cases in the TC lists in 34.123-3 (prose), Annex A		7.0.0	7.1.0	-
RP-40	RP-080367	2341		Addition of GCF WI 49 RRC MBMS test case 8.5.2.3		7.0.0	7.1.0	R5s080016
RP-40	RP-080367	2342		Addition of GCF WI 49 MBMS RRC test case 8.5.5.8		7.0.0	7.1.0	R5s080018
RP-40	RP-080367	2343		Addition of GCF WI 49 MBMS test case 7.2.4.2		7.0.0	7.1.0	R5s080020
RP-40	RP-080367	2344		Addition to MBMS RLC test case 7.2.4.3		7.0.0	7.1.0	R5s080029
RP-40	RP-080367	2345		Addition of GCF WI 49 MBMS RRC test case 8.5.4.2		7.0.0	7.1.0	R5s080038
RP-40	RP-080367	2346		Addition of GCF WI 49 RRC MBMS test case 12.9.16		7.0.0	7.1.0	R5s080041
RP-40	RP-080367	2347		Addition of GCF WI 49 MBMS RRC test case 8.5.3.1		7.0.0	7.1.0	R5s080043
RP-40	RP-080367	2348		Addition of GCF WI 24 RRC test case 8.1.1.6a		7.0.0	7.1.0	R5s080050
RP-40	RP-080367	2349		Addition of InterRAT test case 8.3.7.1a		7.0.0	7.1.0	R5s080053
RP-40	RP-080367	2350		Addition of GCF WI-49-MBMS RRC test case 8.5.6.1		7.0.0	7.1.0	R5s080047
RP-40	RP-080367	2351		Addition of E-DCH MAC test case 7.1.6.4.1 to HSU_ENH_r6 ATS		7.0.0	7.1.0	R5s080060
RP-40	RP-080367	2352		Addition of GCF WI 49 MBMS NAS test case 11.8.2		7.0.0	7.1.0	R5s080065
RP-40	RP-080367	2353		Addition of GCF WI 49 RRC MBMS test case 8.5.3.3		7.0.0	7.1.0	R5s080080
RP-40	RP-080367	2354		Addition of GCF WI 49 MBMS RRC test case 8.5.2.4		7.0.0	7.1.0	R5s080083

Meeting	TSG doc	CR	Rev	Subject	Cat	Old vers	New vers	WG doc
RP-40	RP-080367	2355		Addition of MBMS RAB test case 14.6.10		7.0.0	7.1.0	R5s080088
RP-40	RP-080367	2356		Addition of MBMS RAB test case 14.6.9 and 14.6.10		7.0.0	7.1.0	R5s080086
RP-40	RP-080367	2357		Correction to Selection Expression for test cases 16.1.9.1 and 16.1.9.2		7.0.0	7.1.0	R5s080037
RP-40	RP-080367	2358		Correction to Testcase selection expressions of 8.1.7.1c, 8.2.6.39, 8.2.6.44, 8.3.1.25, 8.3.1.30, 8.2.3.36		7.0.0	7.1.0	R5s080040
RP-40	RP-080367	2359		Correction to GCF WI-14 HSDPA RRC Testcase 8.2.2.42		7.0.0	7.1.0	R5s080045
RP-40	RP-080367	2360		Correction to GCF WI-14 HSDPA RRC Testcase 8.2.3.33		7.0.0	7.1.0	R5s080046
RP-40	RP-080368	2361		TTCN Correction in testcases 8.1.1.7, 8.1.1.8, 8.1.1.10		7.0.0	7.1.0	R5s080049
RP-40	RP-080368	2362		Correction to Rel-5 RAB test cases		7.0.0	7.1.0	R5s080052
RP-40	RP-080368	2363		Summary of regression errors in wk07 ATS		7.0.0	7.1.0	R5s080055
RP-40	RP-080368	2364		Correction to GCF WI-49 MBMS RRC test case 8.5.1.5		7.0.0	7.1.0	R5s080057
RP-40	RP-080368	2365		Summary of regression errors in wk07 MBMS ATS		7.0.0	7.1.0	R5s080058
RP-40	RP-080368	2366		Correction to E-DCH RRC testcase 8.2.6.52		7.0.0	7.1.0	R5s080059
RP-40	RP-080368	2367		Summary of regression errors in MBMS wk10 ATS		7.0.0	7.1.0	R5s080064
RP-40	RP-080368	2368		Summary of regression errors in wk10 ATS		7.0.0	7.1.0	R5s080062
RP-40	RP-080368	2369		Correction of UE radio access capability extension		7.0.0	7.1.0	R5s080070
RP-40	RP-080368	2370		Summary of regression errors in 08wk10 MBMS ATS		7.0.0	7.1.0	R5s080071
RP-40	RP-080368	2371		Correction to Selection Expression for test cases 9.4.5.2, 9.5.2, 9.5.4, 9.5.5 and 9.5.7.1		7.0.0	7.1.0	R5s080075
RP-40	RP-080368	2372		ASP update for Explicit TFC restriction		7.0.0	7.1.0	R5s080068
RP-40	RP-080368	2373		Correction to RAB test cases		7.0.0	7.1.0	R5s080056
RP-40	RP-080368	2374		Correction of handling of Structured Type- and Tabular Pdu types constraints in all 3GPP UMTS ATSS.		7.0.0	7.1.0	R5s080069
RP-40	RP-080368	2375		Configuration of associated physical channels.		7.0.0	7.1.0	R5s080074
RP-40	RP-080368	2376		Correction to MICH configuration.		7.0.0	7.1.0	R5s080076
RP-40	RP-080368	2377		Summary of regression errors in D08wk10 for GCF WI-025		7.0.0	7.1.0	R5s080082
RP-40	RP-080368	2378		Baseline upgrade to March-08 Rel-7		7.0.0	7.1.0	R5s080067
RP-40	RP-080368	2379		Correction to GCF WI-49 MBMS RRC test case 7.2.4.3		7.0.0	7.1.0	R5s080090
RP-40	RP-080368	2380		Correction to SMS test cases 16.2.1 and 16.2.2		7.0.0	7.1.0	R5s080079
RP-41	RP-080613	2386	-	Documentation of TTCN routine maintenance	F	7.1.0	7.2.0	R5-083585
RP-41	RP-080613	2387	-	ASP corrections for Rel-7	F	7.1.0	7.2.0	R5-083637
RP-41	RP-080653	2388		CR to 34.123-3: Add new verified and e-mail agreed TTCN test cases in the TC lists in 34.123-3 (prose), Annex A	F	7.1.0	7.2.0	-
RP-41	RP-080613	2389		Correction to the HSDPA RRC testcase 8.2.1.29, 8.2.1.31 and 8.2.1.32	F	7.1.0	7.2.0	R5s080102
RP-41	RP-080613	2390		Summary of regression errors in wk17 ATS	F	7.1.0	7.2.0	R5s080092
RP-41	RP-080613	2391	-	Correction to Selection Expression for test case 12.3.1.5	F	7.1.0	7.2.0	R5s080103
RP-41	RP-080613	2392	-	Correction to RRC test case 8.3.2.1a	F	7.1.0	7.2.0	R5s080094
RP-41	RP-080613	2393	-	Correction to RAB "Combinations on SCCPCH" Test Cases	F	7.1.0	7.2.0	R5s080099
RP-41	RP-080613	2394	-	Regression CR for Wk16 on IR_U Test cases	F	7.1.0	7.2.0	R5s080091
RP-41	RP-080613	2395	-	Correction to the IR_U test case 6.2.2.3	F	7.1.0	7.2.0	R5s080097
RP-41	RP-080613	2396	-	Correction to the RRC testcase 8.3.1.18	F	7.1.0	7.2.0	R5s080095
RP-41	RP-080613	2397	-	Correction to RLP implementation in wk17 ATS.	F	7.1.0	7.2.0	R5s080098
RP-41	RP-080613	2398	-	Corrections to GCF WI-010 RRC test cases 8_1_7_1	F	7.1.0	7.2.0	R5s080100
RP-41	RP-080613	2399	-	Upgrade RRC asn.1 for Rel-7	F	7.1.0	7.2.0	R5s080093
RP-41	RP-080613	2400	-	Correction to test cases 8.3.1.34, 8.3.1.35, 8.3.1.36 and 8.3.1.37	F	7.1.0	7.2.0	R5s080104
RP-41	RP-080613	2401	-	Correction to GCF testcase 8.4.1.2	F	7.1.0	7.2.0	R5s080072
RP-41	RP-080613	2402	-	Addition of GCF WI-24 Network Sharing test case 6.2.1.11 to HSU_ENH_r6 ATS v7.0.0	F	7.1.0	7.2.0	R5s080077
RP-41	RP-080613	2403	-	TTCN Correction in test cases 8.1.1.7, 8.1.1.8, 8.1.1.10, 8.1.2.16	F	7.1.0	7.2.0	R5s080105
RP-41	RP-080613	2404	-	Correction to HSUPA RRC Test case 8.3.1.42a	F	7.1.0	7.2.0	R5s080108
RP-41	RP-080613	2405	-	Summary of regression errors in wk21 ATS	F	7.1.0	7.2.0	R5s080110
RP-41	RP-080613	2406	-	Addition of GCF WI-025 EDCH MAC test case 7.1.6.2.5 to HSU_ENH_r6 ATS v7.0.0	F	7.1.0	7.2.0	R5s080106
RP-41	RP-080613	2407	-	Renaming of test suite parameter pc_MS_ClsmkA5_3 to pc_MS_ClsmkA5_3_Boot	F	7.1.0	7.2.0	R5s080112
RP-41	RP-080613	2408	-	Correction to E-DCH GCF WI-25 test case 8.2.2.45	F	7.1.0	7.2.0	R5s080113
RP-41	RP-080614	2409	-	Correction to GCF WI-10 RAB test cases	F	7.1.0	7.2.0	R5s080118

Meeting	TSG doc	CR	Rev	Subject	Cat	Old vers	New vers	WG doc
RP-41	RP-080614	2410	-	Correction to common test steps used in HSD ATS	F	7.1.0	7.2.0	R5s080129
RP-41	RP-080614	2411	-	Addition of GCF WI-068 Enhanced Layer2 MAC-ehs test case 7.1.5a.3 to HS_ENH_r7 ATS v7.1.0	F	7.1.0	7.2.0	R5s080126
RP-41	RP-080614	2412	-	Addition of GCF WI-068 Enhanced Layer2 MAC-ehs test case 7.1.5a.2 to HS_ENH_r7 ATS v7.1.0	F	7.1.0	7.2.0	R5s080124
RP-41	RP-080614	2413	-	Addition of GCF WI-068 Enhanced Layer2 MAC-ehs test case 7.1.5a.1 to HS_ENH_r7 ATS v7.1.0	F	7.1.0	7.2.0	R5s080122
RP-41	RP-080614	2414	-	Correction to testcase 8.2.2.18	F	7.1.0	7.2.0	R5s080132
RP-41	RP-080614	2415	-	Correction to RLP handling in default procedures	F	7.1.0	7.2.0	R5s080133
RP-41	RP-080614	2416	-	Corrections to GCF WI-024 Network Sharing test case 6.2.1.11	F	7.1.0	7.2.0	R5s080131
RP-41	RP-080614	2417	-	Correction to the definition of the structure "SI6RO".	F	7.1.0	7.2.0	R5s080128
RP-41	RP-080614	2418	-	ASP update for Rel-7 test model	F	7.1.0	7.2.0	R5s080121
RP-41	RP-080614	2419	-	Correction of Traffic Volume Measurement Procedure for GCF WI-010 RRC TCs	F	7.1.0	7.2.0	R5s080120
RP-41	RP-080614	2420	-	TTCN Correction in test case 8.2.2.43	F	7.1.0	7.2.0	R5s080141
RP-41	RP-080614	2421	-	Correction to Test cases tc_16_1_1,tc_16_1_2,tc_16_1_9_2,tc_9_5_7_2,tc_10_1_2_6_6,tc_10_1_2_7_1,tc_10_1_2_7_2,tc_10_1_2_7_3	F	7.1.0	7.2.0	R5s080136
RP-41	RP-080614	2422	-	TTCN Correction in test case 8.1.1.11	F	7.1.0	7.2.0	R5s080140
RP-41	RP-080614	2423	-	Addition of GCF Enhanced Layer2 MAC-ehs test case 7.1.5a.4 to HS_ENH_r7 ATS v7.1.0	F	7.1.0	7.2.0	R5s080134
RP-41	RP-080614	2424	-	Summary of regression errors in wk27 ATS	F	7.1.0	7.2.0	R5s080142
RP-41	RP-080614	2425	-	Correction to Test cases tc_8_3_7_2 and tc_8_3_7_3	F	7.1.0	7.2.0	R5s080147
RP-41	RP-080614	2426	-	Correction to TTCN for the RRC test cases 8.1.3.9, 8.2.6.37, 8.2.6.37b	F	7.1.0	7.2.0	R5s080149
RP-41	RP-080614	2427	-	Correction to HSUPA test case 14.7.6 and 14.7.7	F	7.1.0	7.2.0	R5s080150
RP-42	RP-080960	2428	-	CR to 34.123-3: Add new verified and e-mail agreed TTCN test cases in the TC lists in 34.123-3 (prose), Annex A	F	7.2.0	7.3.0	-
RP-42	RP-080957	2429	-	Summary of regression errors in MBMS wk21 ATS	F	7.2.0	7.3.0	R5s080111
RP-42	RP-080957	2430	-	Correction to GCF WI 10 and WI 14 RRC test cases	F	7.2.0	7.3.0	R5s080156
RP-42	RP-080957	2431	-	Summary of regression errors in wk27 ATSS	F	7.2.0	7.3.0	R5s080154
RP-42	RP-080957	2432	-	Correction to RRC test case 8.4.1.2	F	7.2.0	7.3.0	R5s080155
RP-42	RP-080957	2433	-	Correction to RAB R5 test cases	F	7.2.0	7.3.0	R5s080153
RP-42	RP-080957	2434	-	Correction to the test step ts_TestPointExecute_Rb25	F	7.2.0	7.3.0	R5s080157
RP-42	RP-080957	2435	-	Correction to Rel-7 MAC test case 7.1.5a.4	F	7.2.0	7.3.0	R5s080159
RP-42	RP-080957	2436	-	Correction to Rel-7 MAC test cases 7.1.5a.1 and 7.1.5a.2	F	7.2.0	7.3.0	R5s080160
RP-42	RP-080957	2437	-	Correction to RAB Test cases	F	7.2.0	7.3.0	R5s080158
RP-42	RP-080957	2438	-	Addition of GCF WI-025 HSUPA testcase 7.1.6.2.6 to HSU_ENH_r6 ATS v7.1.0	B	7.2.0	7.3.0	R5s080161
RP-42	RP-080957	2439	-	Summary of regression errors in wk36 ATS	F	7.2.0	7.3.0	R5s080163
RP-42	RP-080957	2440	-	Correction to testcase 14.7.6 & 14.7.7	F	7.2.0	7.3.0	R5s080166
RP-42	RP-080957	2441	-	Correction to testcase 8.4.1.27	F	7.2.0	7.3.0	R5s080164
RP-42	RP-080957	2442	-	Summary of regression errors in wk36 ATS	F	7.2.0	7.3.0	R5s080173
RP-42	RP-080957	2443	-	TTCN Correction in test cases 8.2.6.39,8.2.6.44,8.3.1.25 and 8.3.1.30	F	7.2.0	7.3.0	R5s080170
RP-42	RP-080957	2444	-	Correction to GCF WI-10 IR_U Testcase 8.3.9.1	F	7.2.0	7.3.0	R5s080172
RP-42	RP-080957	2445	-	Correction to GCF WI 25 HSUPA MAC test case 7.1.6.2.9	F	7.2.0	7.3.0	R5s080169
RP-42	RP-080957	2446	-	Addition of Rel7 CPC RRC testcase 8.2.1.38 to HS_ENH_r6 ATS v7.1.0	B	7.2.0	7.3.0	R5s080174
RP-42	RP-080957	2447	-	Addition of Rel7 CPC RRC testcase 8.1.2.19 to HS_ENH_r7 ATS v7.2.0	B	7.2.0	7.3.0	R5s080178
RP-42	RP-080957	2448	-	Correction to GCF WI 25 HSUPA RRC test cases	F	7.2.0	7.3.0	R5s080181
RP-42	RP-080958	2449	-	Correction to No. of HARQ Process in RAB test cases for HSDPA CAT 10 UE	F	7.2.0	7.3.0	R5s080183
RP-42	RP-080958	2450	-	Correction in the preamble test step ts_GMM_IdleUpdated to include USIM insertion related MMI command.	F	7.2.0	7.3.0	R5s080184
RP-42	RP-080958	2451	-	Correction to RRC test cases for RLP	F	7.2.0	7.3.0	R5s080182
RP-42	RP-080958	2452	-	Addition of Rel7 CPC RRC testcase 8.2.2.56 to HS_ENH_r7 ATS v7.2.0	B	7.2.0	7.3.0	R5s080176
RP-42	RP-080958	2453	-	TTCN Correction to Test case tc_8_4_1_42	F	7.2.0	7.3.0	R5s080185
RP-42	RP-080958	2454	-	TTCN Correction to Test cases tc_8_2_6_39 and tc_8_2_6_44	F	7.2.0	7.3.0	R5s080180
RP-42	RP-080958	2455	-	Correction to the test step used to send CLOSE UE TEST LOOP in MBMS testcases	F	7.2.0	7.3.0	R5s080287
RP-42	RP-080958	2456	-	Correction to GCF WI 14 HSDPA RRC test case 8.3.1.34	F	7.2.0	7.3.0	R5s080290

Meeting	TSG doc	CR	Rev	Subject	Cat	Old vers	New vers	WG doc
RP-42	RP-080958	2457	-	Addition of Rel7 CPC RRC InterRAT testcase 8.3.11.15 to HS_ENH_r7 ATS v7.2.0	B	7.2.0	7.3.0	R5s080291
RP-42	RP-080958	2458	-	Addition of Rel7 CPC RRC testcase 8.2.2.54 to HS_ENH_r7 ATS v7.2.0	B	7.2.0	7.3.0	R5s080295
RP-42	RP-080958	2459	-	Correction to the CPC testcase 8.2.1.38	F	7.2.0	7.3.0	R5s080297
RP-42	RP-080958	2460	-	Correction to the CPC testcase 8.1.2.19	F	7.2.0	7.3.0	R5s080298
RP-42	RP-080958	2461	-	Addition of Rel7 CPC RRC testcase 8.2.2.52 to HS_ENH_r7 ATS v7.2.0	B	7.2.0	7.3.0	R5s080288
RP-42	RP-080958	2462	-	New PIXIT for RAB test cases execution	F	7.2.0	7.3.0	R5-085056
RP-42	RP-080958	2463	-	Rel-7 test model enhancement for LCR TDD	F	7.2.0	7.3.0	R5-085436
RP-42	RP-080958	2464	-	Rel-7 test model routine maintenance	F	7.2.0	7.3.0	R5-085437
RP-42	RP-081067	2465		To add new RAB test case 18.1.2.13.1 to the LCR TDD RAB ATS	B	7.2.0	7.3.0	R5s080232
RP-42	RP-081067	2466		To add new HSD_ENH test case 8.3.1.37 to the LCR TDD HSD_ENH ATS	B	7.2.0	7.3.0	R5s080284
RP-42	RP-081067	2467		To add new HSD_ENH test case 8.3.1.36 to the LCR TDD HSD_ENH ATS	B	7.2.0	7.3.0	R5s080282
RP-42	RP-081067	2468		To add new HSD_ENH test case 8.3.1.35 to the LCR TDD HSD_ENH ATS	B	7.2.0	7.3.0	R5s080280
RP-42	RP-081067	2469		To add new HSD_ENH test case 8.3.1.34 to the LCR TDD HSD_ENH ATS	B	7.2.0	7.3.0	R5s080278
RP-42	RP-081067	2470		To add new HSD_ENH test case 8.3.1.32 to the LCR TDD HSD_ENH ATS	B	7.2.0	7.3.0	R5s080276
RP-42	RP-081067	2471		To add new HSD_ENH test case 8.2.6.49 to the LCR TDD HSD_ENH ATS	B	7.2.0	7.3.0	R5s080274
RP-42	RP-081067	2472		To add new HSD_ENH test case 8.2.6.46 to the LCR TDD HSD_ENH ATS	B	7.2.0	7.3.0	R5s080272
RP-42	RP-081067	2473		To add new HSD_ENH test case 8.2.6.42 to the LCR TDD HSD_ENH ATS	B	7.2.0	7.3.0	R5s080270
RP-42	RP-081067	2474		To add new HSD_ENH test case 8.2.6.40a to the LCR TDD HSD_ENH ATS	B	7.2.0	7.3.0	R5s080268
RP-42	RP-081067	2475		To add new HSD_ENH test case 8.2.6.39b to the LCR TDD HSD_ENH ATS	B	7.2.0	7.3.0	R5s080266
RP-42	RP-081067	2476		To add new HSD_ENH test case 8.2.3.35 to the LCR TDD HSD_ENH ATS	B	7.2.0	7.3.0	R5s080264
RP-42	RP-081067	2477		To add new HSD_ENH test case 8.2.3.34 to the LCR TDD HSD_ENH ATS	B	7.2.0	7.3.0	R5s080262
RP-42	RP-081067	2478		To add new HSD_ENH test case 8.2.3.33 to the LCR TDD HSD_ENH ATS	B	7.2.0	7.3.0	R5s080260
RP-42	RP-081067	2479		To add new HSD_ENH test case 8.2.3.32 to the LCR TDD HSD_ENH ATS	B	7.2.0	7.3.0	R5s080258
RP-42	RP-081067	2480		To add new HSD_ENH test case 8.2.3.30 to the LCR TDD HSD_ENH ATS	B	7.2.0	7.3.0	R5s080256
RP-42	RP-081067	2481		To add new HSD_ENH test case 8.2.2.42 to the LCR TDD HSD_ENH ATS	B	7.2.0	7.3.0	R5s080254
RP-42	RP-081067	2482		To add new HSD_ENH test case 8.2.2.41 to the LCR TDD HSD_ENH ATS	B	7.2.0	7.3.0	R5s080252
RP-42	RP-081067	2483		To add new HSD_ENH test case 8.2.2.40 to the LCR TDD HSD_ENH ATS	B	7.2.0	7.3.0	R5s080250
RP-42	RP-081067	2484		To add new HSD_ENH test case 8.2.2.39 to the LCR TDD HSD_ENH ATS	B	7.2.0	7.3.0	R5s080248
RP-42	RP-081067	2485		To add new HSD_ENH test case 8.2.2.38 to the LCR TDD HSD_ENH ATS	B	7.2.0	7.3.0	R5s080246
RP-42	RP-081067	2486		To add new HSD_ENH test case 8.2.1.32 to the LCR TDD HSD_ENH ATS	B	7.2.0	7.3.0	R5s080244
RP-42	RP-081067	2487		To add new HSD_ENH test case 8.2.1.31 to the LCR TDD HSD_ENH ATS	B	7.2.0	7.3.0	R5s080242
RP-42	RP-081067	2488		To add new HSD_ENH test case 8.2.1.30 to the LCR TDD HSD_ENH ATS	B	7.2.0	7.3.0	R5s080240
RP-42	RP-081067	2489		To add new HSD_ENH test case 8.2.1.29 to the LCR TDD HSD_ENH ATS	B	7.2.0	7.3.0	R5s080238
RP-42	RP-081068	2490		To add new HSD_ENH test case 8.2.1.28 to the LCR TDD HSD_ENH ATS	B	7.2.0	7.3.0	R5s080236
RP-42	RP-081068	2491		To add new RAB test case 18.1.2.27 to the LCR TDD RAB ATS	B	7.2.0	7.3.0	R5s080234
RP-42	RP-081068	2492		To add new NAS test case 12.9.9 to the LCR TDD NAS ATS	B	7.2.0	7.3.0	R5s080230
RP-42	RP-081068	2493		To add new NAS test case 12.9.8 to the LCR TDD NAS ATS	B	7.2.0	7.3.0	R5s080228
RP-42	RP-081068	2494		To add new NAS test case 12.6.1.3.2 to the LCR TDD NAS ATS	B	7.2.0	7.3.0	R5s080226
RP-42	RP-081068	2495		To add new NAS test case 12.6.1.3.1 to the LCR TDD NAS ATS	B	7.2.0	7.3.0	R5s080224

Meeting	TSG doc	CR	Rev	Subject	Cat	Old vers	New vers	WG doc
RP-42	RP-081068	2496		To add new NAS test case 12.6.1.2 to the LCR TDD NAS ATS	B	7.2.0	7.3.0	R5s080222
RP-42	RP-081068	2497		To add new NAS test case 12.6.1.1 to the LCR TDD NAS ATS	B	7.2.0	7.3.0	R5s080220
RP-42	RP-081068	2498		To add new NAS test case 12.2.1.6.2 to the LCR TDD NAS ATS	B	7.2.0	7.3.0	R5s080218
RP-42	RP-081068	2499		To add new NAS test case 12.2.1.6.1 to the LCR TDD NAS ATS	B	7.2.0	7.3.0	R5s080216
RP-42	RP-081068	2500		To add new NAS test case 12.2.1.5a.2 to the LCR TDD NAS ATS	B	7.2.0	7.3.0	R5s080214
RP-42	RP-081068	2501		To add new NAS test case 11.3.2 to the LCR TDD NAS ATS	B	7.2.0	7.3.0	R5s080212
RP-42	RP-081068	2502		To add new NAS test case 9.5.5 to the LCR TDD NAS ATS	B	7.2.0	7.3.0	R5s080210
RP-42	RP-081068	2503		To add new NAS test case 9.2.4 to the LCR TDD NAS ATS	B	7.2.0	7.3.0	R5s080206
RP-42	RP-081068	2504		To add new NAS test case 9.2.3 to the LCR TDD NAS ATS	B	7.2.0	7.3.0	R5s080204
RP-42	RP-081068	2505		To add new RRC test case 8.2.2.7 to the LCR TDD RRC ATS	B	7.2.0	7.3.0	R5s080202
RP-42	RP-081068	2506		To add new RRC test case 8.2.2.4 to the LCR TDD RRC ATS	B	7.2.0	7.3.0	R5s080200
RP-42	RP-081068	2507		To add new RRC test case 8.2.1.24 to the LCR TDD RRC ATS	B	7.2.0	7.3.0	R5s080198
RP-42	RP-081068	2508		To add new RRC test case 8.2.1.10 to the LCR TDD RRC ATS	B	7.2.0	7.3.0	R5s080196
RP-42	RP-081068	2509		To add new RRC test case 8.2.1.7 to the LCR TDD RRC ATS	B	7.2.0	7.3.0	R5s080194
RP-42	RP-081068	2510		To add new RRC test case 8.2.1.4 to the LCR TDD RRC ATS	B	7.2.0	7.3.0	R5s080192
RP-42	RP-081068	2511		To add new RRC test case 8.2.1.1 to the LCR TDD RRC ATS	B	7.2.0	7.3.0	R5s080190
RP-42	RP-081068	2512		To add new RRC test case 8.1.6.1 to the LCR TDD RRC ATS	B	7.2.0	7.3.0	R5s080188
RP-42	RP-081068	2513		To add new RRC test case 8.1.2.9 to the LCR TDD RRC ATS	B	7.2.0	7.3.0	R5s080186
SP-42	-			Update of TS 34.123-3 from Rel-7 to Rel-8		7.3.0	8.0.0	-
RP-43	RP-090205	2514		Update of TS 34.123-3 from Rel-7 to Rel-8	F	8.0.0	8.1.0	R5-090767
RP-43	RP-090206	2515		Correction to Rel-7 CPC test cases 8.3.1.44	F	8.0.0	8.1.0	R5s090016
RP-43	RP-090206	2516		Correction of GCF WI-068 Improved L2 Flexible RLC AM test case 7.2.3.36	F	8.0.0	8.1.0	R5s090008
RP-43	RP-090206	2517		Addition of GCF WI-070 CPC RRC testcase 8.2.6.61 to HS_ENH_r7 ATS v7.2.0	B	8.0.0	8.1.0	R5s090002
RP-43	RP-090206	2518		Correction to the GCF WI 25 HSUPA RRC test case 8.2.6.52	F	8.0.0	8.1.0	R5s090001
RP-43	RP-090206	2519		Correction to RRC test cases 8.2.6.39 and 8.2.6.44	F	8.0.0	8.1.0	R5s090015
RP-43	RP-090206	2520		Addition of GCF WI-068 RAB test case 14.6.1b to HS_ENH_r7 ATS	B	8.0.0	8.1.0	R5s090009
RP-43	RP-090206	2521		Summary of Regressions Error for HS_ENH_r7 wk50	F	8.0.0	8.1.0	R5s090011
RP-43	RP-090206	2522		Addition of GCF WI 70 CPC RRC test case 8.2.6.59	B	8.0.0	8.1.0	R5s090006
RP-43	RP-090206	2523		Correction to Rel-7 CPC testcase 8.3.1.46	F	8.0.0	8.1.0	R5s090013
RP-43	RP-090206	2524		Correction to GCF WI-24 HSU_ENH Testcase 6.2.1.11	F	8.0.0	8.1.0	R5s090012
RP-43	RP-090206	2525		Addition of GCF WI 70 CPC RRC test case 8.3.1.46	B	8.0.0	8.1.0	R5s080328
RP-43	RP-090206	2526		Corrections to HS-ENH-R7 wk48 ATS	F	8.0.0	8.1.0	R5s080323
RP-43	RP-090206	2527		Addition of GCF WI-068 Improved L2 Flexible RLC AM test case 7.2.3.36 to HS_ENH_r7ATS v7.2.0	B	8.0.0	8.1.0	R5s080311
RP-43	RP-090206	2528		Addition of Rel7 Improved L2 Flexible RLC UM testcase 7.2.2.14 to HS_ENH_r7 ATS v7.2.0	B	8.0.0	8.1.0	R5s080309

Meeting	TSG doc	CR	Rev	Subject	Cat	Old vers	New vers	WG doc
RP-43	RP-090206	2529		Correction to the test case 8.3.1.40	F	8.0.0	8.1.0	R5s080325
RP-43	RP-090206	2530		Addition of HSDPA SM test case 11.1.1.1a	B	8.0.0	8.1.0	R5s080326
RP-43	RP-090206	2531		Addition of Rel7 CPC RRC testcase 8.2.6.57 to HS_ENH_r7 ATS v7.2.0	B	8.0.0	8.1.0	R5s080319
RP-43	RP-090206	2532		Addition of GCF WI-070 CPC RRC testcase 8.3.1.44 to HS_ENH_r7 ATS v7.2.0	B	8.0.0	8.1.0	R5s080321
RP-43	RP-090206	2533		Correction to NAS test case 12_4_1_4a	F	8.0.0	8.1.0	R5s080324
RP-43	RP-090206	2534		Summary of Regression Errors in HS_ENH_r7 wk48	F	8.0.0	8.1.0	R5s080318
RP-43	RP-090206	2535		Correction to the Rel-7 CPC testcases	F	8.0.0	8.1.0	R5s080305
RP-43	RP-090206	2536		Addition of Rel7 CPC RRC testcase 8.2.2.51 to HS_ENH_r7 ATS v7.2.0	B	8.0.0	8.1.0	R5s080303
RP-43	RP-090206	2537		Correction to SIB5 and SIB5bis for IE "Frequency Band Indicator" for band VIII and higher	F	8.0.0	8.1.0	R5s080306
RP-43	RP-090206	2538		Correction in the preamble test steps for the automation of the majority of 34.123-1 test cases when the USIM removal without powering down is supported by the UE under test.	F	8.0.0	8.1.0	R5s080308
RP-43	RP-090206	2539		Correction to MBMS test step ts_TriggerRequestPTPRB	F	8.0.0	8.1.0	R5s080301
RP-43	RP-090206	2540		Corrections to HS-ENH-R7 wk43 ATS	F	8.0.0	8.1.0	R5s080302
RP-43	RP-090206	2541		Addition of Rel7 CPC RRC testcase 8.2.6.60 to HS_ENH_r7 ATS v7.2.0	B	8.0.0	8.1.0	R5s080293
RP-43	RP-090206	2542		Correction to NAS test case 12_4_1_4b	F	8.0.0	8.1.0	R5s080300
RP-43	RP-090206	2543		LCR TDD: Addition of new test cases 12.2.1.2 to NAS ATS	B	8.0.0	8.1.0	R5s080450
RP-43	RP-090206	2544		LCR TDD: Addition of new test cases 18.1.2.4 to RAB ATS	B	8.0.0	8.1.0	R5s080448
RP-43	RP-090206	2545		LCR TDD: Addition of new test cases 16.2.2 to SMS ATS	B	8.0.0	8.1.0	R5s080446
RP-43	RP-090206	2546		LCR TDD: Addition of new test cases 16.2.1 to SMS ATS	B	8.0.0	8.1.0	R5s080444
RP-43	RP-090206	2547		LCR TDD: Addition of new test cases 16.1.9.1 to SMS ATS	B	8.0.0	8.1.0	R5s080442
RP-43	RP-090206	2548		LCR TDD: Addition of new test cases 12.9.7c to NAS ATS	B	8.0.0	8.1.0	R5s080440
RP-43	RP-090206	2549		LCR TDD: Addition of new test cases 12.9.7b to NAS ATS	B	8.0.0	8.1.0	R5s080438
RP-43	RP-090206	2550		LCR TDD: Addition of new test cases 12.9.7a to NAS ATS	B	8.0.0	8.1.0	R5s080436
RP-43	RP-090206	2551		LCR TDD: Addition of new test cases 12.9.6 to NAS ATS	B	8.0.0	8.1.0	R5s080434
RP-43	RP-090206	2552		LCR TDD: Addition of new test cases 12.4.3.4 to NAS ATS	B	8.0.0	8.1.0	R5s080432
RP-43	RP-090206	2553		LCR TDD: Addition of new test cases 12.4.2.5a.1 to NAS ATS	B	8.0.0	8.1.0	R5s080430
RP-43	RP-090206	2554		LCR TDD: Addition of new test cases 12.4.2.1 to NAS ATS	B	8.0.0	8.1.0	R5s080428

Meeting	TSG doc	CR	Rev	Subject	Cat	Old vers	New vers	WG doc
RP-43	RP-090206	2555		LCR TDD: Addition of new test cases 12.4.1.4d.1 to NAS ATS	B	8.0.0	8.1.0	R5s080426
RP-43	RP-090206	2556		LCR TDD: Addition of new test cases 12.4.1.4c.1 to NAS ATS	B	8.0.0	8.1.0	R5s080424
RP-43	RP-090206	2557		LCR TDD: Addition of new test cases 12.4.1.3 to NAS ATS	B	8.0.0	8.1.0	R5s080422
RP-43	RP-090206	2558		LCR TDD: Addition of new test cases 12.4.1.2 to NAS ATS	B	8.0.0	8.1.0	R5s080420
RP-43	RP-090206	2559		LCR TDD: Addition of new test cases 12.4.1.1a to NAS ATS	B	8.0.0	8.1.0	R5s080416
RP-43	RP-090206	2560		LCR TDD: Addition of new test cases 12.3.2.7 to NAS ATS	B	8.0.0	8.1.0	R5s080414
RP-43	RP-090206	2561		LCR TDD: Addition of new test cases 12.2.1.11 to NAS ATS	B	8.0.0	8.1.0	R5s080412
RP-43	RP-090206	2562		LCR TDD: Addition of new test cases 12.2.1.10 to NAS ATS	B	8.0.0	8.1.0	R5s080410
RP-43	RP-090206	2563		LCR TDD: Addition of new test cases 12.2.1.5d to NAS ATS	B	8.0.0	8.1.0	R5s080408
RP-43	RP-090206	2564		LCR TDD: Addition of new test cases 12.2.1.5b to NAS ATS	B	8.0.0	8.1.0	R5s080406
RP-43	RP-090206	2565		LCR TDD: Addition of new test cases 12.2.1.5a.1 to NAS ATS	B	8.0.0	8.1.0	R5s080404
RP-43	RP-090206	2566		LCR TDD: Addition of new test cases 9.4.5.2 to NAS ATS	B	8.0.0	8.1.0	R5s080402
RP-43	RP-090206	2567		LCR TDD: Addition of new test cases 9.4.2.4.1 to NAS ATS	B	8.0.0	8.1.0	R5s080400
RP-43	RP-090206	2568		LCR TDD: Addition of new test cases 9.4.1 to NAS ATS	B	8.0.0	8.1.0	R5s080398
RP-43	RP-090206	2569		LCR TDD: Addition of new test cases 8.4.1.8A to RRC ATS	B	8.0.0	8.1.0	R5s080396
RP-43	RP-090206	2570		LCR TDD: Addition of new test cases 8.4.1.6A to RRC ATS	B	8.0.0	8.1.0	R5s080394
RP-43	RP-090206	2571		LCR TDD: Addition of new test cases 8.4.1.5A to RRC ATS	B	8.0.0	8.1.0	R5s080392
RP-43	RP-090206	2572		LCR TDD: Addition of new test cases 8.4.1.3A to RRC ATS	B	8.0.0	8.1.0	R5s080390
RP-43	RP-090206	2573		LCR TDD: Addition of new test cases 8.4.1.2A to RRC ATS	B	8.0.0	8.1.0	R5s080388
RP-43	RP-090206	2574		LCR TDD: Addition of new test cases 8.4.1.1A to RRC ATS	B	8.0.0	8.1.0	R5s080386
RP-43	RP-090206	2575		LCR TDD: Addition of new test cases 8.3.3.1 to RRC ATS	B	8.0.0	8.1.0	R5s080384
RP-43	RP-090206	2576		LCR TDD: Addition of new test cases 8.3.2.1 to RRC ATS	B	8.0.0	8.1.0	R5s080382
RP-43	RP-090206	2577		LCR TDD: Addition of new test cases 8.3.1.25 to RRC ATS	B	8.0.0	8.1.0	R5s080380
RP-43	RP-090206	2578		LCR TDD: Addition of new test cases 8.3.1.17 to RRC ATS	B	8.0.0	8.1.0	R5s080378
RP-43	RP-090206	2579		LCR TDD: Addition of new test cases 8.3.1.6 to RRC	B	8.0.0	8.1.0	R5s080376

Meet- ing	TSG doc	CR	Rev	Subject	Cat	Old vers	New vers	WG doc
				ATS				

Meeting	TSG doc	CR	Rev	Subject	Cat	Old vers	New vers	WG doc
RP-43	RP-090206	2580		LCR TDD: Addition of new test cases 8.3.1.5 to RRC ATS	B	8.0.0	8.1.0	R5s080374
RP-43	RP-090206	2581		LCR TDD: Addition of new test cases 8.3.1.2 to RRC ATS	B	8.0.0	8.1.0	R5s080372
RP-43	RP-090206	2582		LCR TDD: Addition of new test cases 8.2.6.19 to RRC ATS	B	8.0.0	8.1.0	R5s080370
RP-43	RP-090206	2583		LCR TDD: Addition of new test cases 8.2.6.12 to RRC ATS	B	8.0.0	8.1.0	R5s080368
RP-43	RP-090206	2584		LCR TDD: Addition of new test cases 8.2.6.9 to RRC ATS	B	8.0.0	8.1.0	R5s080366
RP-43	RP-090206	2585		LCR TDD: Addition of new test cases 8.2.6.8 to RRC ATS	B	8.0.0	8.1.0	R5s080364
RP-43	RP-090206	2586		LCR TDD: Addition of new test cases 8.2.6.2 to RRC ATS	B	8.0.0	8.1.0	R5s080362
RP-43	RP-090206	2587		LCR TDD: Addition of new test cases 8.2.6.1 to RRC ATS	B	8.0.0	8.1.0	R5s080360
RP-43	RP-090206	2588		LCR TDD: Addition of new test cases 8.2.4.10a to RRC ATS	B	8.0.0	8.1.0	R5s080358
RP-43	RP-090206	2589		LCR TDD: Addition of new test cases 8.2.4.4a to RRC ATS	B	8.0.0	8.1.0	R5s080356
RP-43	RP-090206	2590		LCR TDD: Addition of new test cases 8.2.4.3 to RRC ATS	B	8.0.0	8.1.0	R5s080354
RP-43	RP-090206	2591		LCR TDD: Addition of new test cases 8.2.3.18 to RRC ATS	B	8.0.0	8.1.0	R5s080352
RP-43	RP-090206	2592		LCR TDD: Addition of new test cases 8.2.3.1 to RRC ATS	B	8.0.0	8.1.0	R5s080350
RP-43	RP-090206	2593		LCR TDD: Addition of new test cases 8.2.2.23 to RRC ATS	B	8.0.0	8.1.0	R5s080348
RP-43	RP-090206	2594		LCR TDD: Addition of new test cases 8.2.2.19 to RRC ATS	B	8.0.0	8.1.0	R5s080346
RP-43	RP-090206	2595		LCR TDD: Addition of new test cases 8.2.2.1 to RRC ATS	B	8.0.0	8.1.0	R5s080344
RP-43	RP-090206	2596		LCR TDD: Addition of new test cases 8.2.1.9 to RRC ATS	B	8.0.0	8.1.0	R5s080342
RP-43	RP-090206	2597		LCR TDD: Addition of new test cases 8.1.2.10 to RRC ATS	B	8.0.0	8.1.0	R5s080338
RP-43	RP-090206	2598		LCR TDD: Addition of new test cases 8.1.2.4 to RRC ATS	B	8.0.0	8.1.0	R5s080336
RP-43	RP-090206	2599		LCR TDD: Addition of new test cases 8.1.1.5 to RRC ATS	B	8.0.0	8.1.0	R5s080334
RP-43	RP-090206	2600		LCR TDD: Addition of new test cases 8.1.1.3 to RRC ATS	B	8.0.0	8.1.0	R5s080332
RP-43	RP-090206	2601		LCR TDD: Addition of new test cases 8.1.1.2 to RRC ATS	B	8.0.0	8.1.0	R5s080330
RP-43	RP-090206	2602		TTCN Correction to testcases 8.3.11.9,8.3.11.10,8.3.7.14,8.3.11.14	F	8.0.0	8.1.0	R5s090020
RP-43	RP-090206	2603		Corrections to GCF WI-014 HSD Test Case 8.3.1.34	F	8.0.0	8.1.0	R5s090014
RP-43	RP-090211	2604		CR to 34.123-3: Add new verified and e-mail agreed TTCN test cases in the TC lists in 34.123-3 (prose), Annex A	F	8.0.0	8.1.0	-

Meeting	TSG doc	CR	Rev	Subject	Cat	Old vers	New vers	WG doc
RP-43	RP-090205	2605		Cleanup USIM parameters for Idle mode test	F	8.0.0	8.1.0	R5-090057
RP-43	RP-090205	2608		Test model enhancement for CS Voice over HSPA and Enhanced FACH	F	8.0.0	8.1.0	R5-090752
RP-44	RP-090436	2609		UTRA ASP enhancement for Rel-8	F	8.1.0	8.2.0	R5-092565
RP-44	RP-090436	2610		TTCN correction to the test cases 8.1.7.1d.	F	8.1.0	8.2.0	R5s090062
RP-44	RP-090436	2611		Addition of GCF WI 70 CPC RRC test case 8.3.1.45	B	8.1.0	8.2.0	R5s090058
RP-44	RP-090436	2612		Correction to HSDPA RAB testcases (CAT 1 to 5 & 11)	F	8.1.0	8.2.0	R5s090064
RP-44	RP-090436	2613		Corrections to GCF WI-025 HSUPA TC 7.1.6.2.2	F	8.1.0	8.2.0	R5s090063
RP-44	RP-090436	2614		TTCN Correction to test steps in UE capability testcases which use the constraints cr_UE_CapabilityInfoAM_BandList2_r6 and cr_RRC_RrcConnSetupCmplRadioCap_BandList2_r6	F	8.1.0	8.2.0	R5s090065
RP-44	RP-090436	2615		Summary of regression errors in wk16 ATS	F	8.1.0	8.2.0	R5s090073
RP-44	RP-090436	2616		Correction to HSUPA test case 6.1.2.11	F	8.1.0	8.2.0	R5s090027
RP-44	RP-090436	2617		Correction to RRC test cases 8.1.3.4 and 8.3.1.15	F	8.1.0	8.2.0	R5s090025
RP-44	RP-090436	2618		Corrections to GCF WI-070 CPC Test Cases 8.2.6.69	F	8.1.0	8.2.0	R5s090026
RP-44	RP-090436	2619		Correction to HSD MAC test case 7.1.5.6	F	8.1.0	8.2.0	R5s090024
RP-44	RP-090436	2620		Corrections to GCF WI-010 RLC Test Case 7.2.3.24	F	8.1.0	8.2.0	R5s090034
RP-44	RP-090436	2621		Addition of GCF WI-070 CPC RRC testcase 8.2.6.55 to HS_ENH_r7 ATS v8.0.0	B	8.1.0	8.2.0	R5s090035
RP-44	RP-090436	2622		Correction to GCF WI-010 Test Case 14.2.57	F	8.1.0	8.2.0	R5s090032
RP-44	RP-090436	2623		Correction to RRC test cases 8.2.6.37 and 8.2.6.37b	F	8.1.0	8.2.0	R5s090029
RP-44	RP-090436	2624		Corrections to GCF WI-024 Network Sharing Test Cases 6.1.1.8 and 6.1.1.9	F	8.1.0	8.2.0	R5s090031
RP-44	RP-090436	2625		Corrections to MAC_eHS_PDU & ReorderingPDU definitions	F	8.1.0	8.2.0	R5s090030
RP-44	RP-090436	2626		Correction of GCF WI-068 Improved L2 Flexible RLC UM test case 7.2.2.14	F	8.1.0	8.2.0	R5s090022
RP-44	RP-090436	2627		TTCN Correction in TCs 8.2.6.39, 8.2.6.44	F	8.1.0	8.2.0	R5s090028
RP-44	RP-090436	2628		Correction to the Network Sharing test cases	F	8.1.0	8.2.0	R5s090038
RP-44	RP-090436	2629		Correction to Rel-7 CPC testcase 8.2.6.61	F	8.1.0	8.2.0	R5s090037
RP-44	RP-090436	2630		TTCN Correction to testcase 8.3.1.30	F	8.1.0	8.2.0	R5s090041
RP-44	RP-090436	2631		Addition of GCF WI-070 CPC RRC testcase 8.2.1.40 to HS_ENH_r7 ATS v8.0.0	B	8.1.0	8.2.0	R5s090039
RP-44	RP-090436	2632		Addition of GCF WI-068 MAC test case 7.1.5a.5.2 to HSPA7_ENH ATS	B	8.1.0	8.2.0	R5s090043
RP-44	RP-090436	2633		TTCN Correction to constraint c_DynamicAllocationPRR used to send PACKET UPLINK ASSIGNMENT, in test step ts_LLC_XID.	F	8.1.0	8.2.0	R5s090046
RP-44	RP-090436	2634		TTCN Correction to RLC test cases (7.2.2.3, 7.2.2.4, 7.2.2.5 , 7.2.2.6) for Rel-7 and later UEs.	F	8.1.0	8.2.0	R5s090055
RP-44	RP-090436	2635		Addition of GCF WI-070 CPC RRC testcase 8.2.2.53 to HS_ENH_r7 ATS v8.1.0	B	8.1.0	8.2.0	R5s090056
RP-44	RP-090436	2636		TTCN Correction in test case 12.9.7b	F	8.1.0	8.2.0	R5s090053
RP-44	RP-090436	2637		Baseline upgrade to March-09 Rel-8	F	8.1.0	8.2.0	R5s090045
RP-44	RP-090436	2638		Correction to HSU Network Sharing test cases and some generic changes	F	8.1.0	8.2.0	R5s090052
RP-44	RP-090436	2639		Corrections to GCF WI-070 CPC Test Cases 8.2.6.61	F	8.1.0	8.2.0	R5s090048
RP-44	RP-090436	2640		TTCN correction to the test cases 8.3.7.1a (Support of A5/3 algorithm) for Rel-99 UE	F	8.1.0	8.2.0	R5s090054
RP-44	RP-090436	2641		Correction to the Network Sharing test cases	F	8.1.0	8.2.0	R5s090047
RP-44	RP-090436	2642		Correction to RAB test case variables, "tcv_Background" and "tcv_Streaming"	F	8.1.0	8.2.0	R5s090051
RP-44	RP-090436	2643		Correction to GCF WI 25 HSU test case 8.1.2.18	F	8.1.0	8.2.0	R5s090050
RP-44	RP-090436	2644		Correction to RRC test case 8.3.2.12	F	8.1.0	8.2.0	R5s090049
RP-44	RP-090436	2645		Corrections to handle v7b0NonCriticalExtensions in RRC Connection Req message (Rel-7).	F	8.1.0	8.2.0	R5s090061
RP-44	RP-090436	2646		Corrections to GCF WI-024 Network Sharing Test Cases 6.1.1.8, 6.1.1.9, 6.1.2.11, 6.2.2.4	F	8.1.0	8.2.0	R5s090060
RP-44	RP-090435	2647		CR to 34.123-3: Add new verified and e-mail agreed TTCN test cases in the TC lists in 34.123-3 (prose), Annex A	F	8.1.0	8.2.0	-
RP-45	RP-090796	2648	-	CR to 34.123-3: Add new verified and e-mail agreed TTCN test cases in the TC lists in 34.123-3 (prose), Annex A	F	8.2.0	8.3.0	-
RP-45	RP-090797	2649	-	Addition of GCF WI-069 64 QAM MAC test case 7.1.5a.5.3 to HSPA7_ENH ATS	B	8.2.0	8.3.0	R5s090074
RP-45	RP-090797	2650	-	Corrections to GCF WI-070 CPC Test Cases 8.2.6.61	F	8.2.0	8.3.0	R5s090079
RP-45	RP-090797	2651	-	Correction to GCF WI-012 RRC Testcase 8.3.1.30	F	8.2.0	8.3.0	R5s090078
RP-45	RP-090797	2652	-	Addition of GCF WI-069 64QAM RAB test case	B	8.2.0	8.3.0	R5s090076

Meeting	TSG doc	CR	Rev	Subject	Cat	Old vers	New vers	WG doc
				14.6.1c to HSPA7_ENH ATS				
RP-45	RP-090797	2653	-	Addition of GCF WI-068 Improved L2 RAB testcase 14.7.6b to HS_ENH_r7 ATS v8.1.0	B	8.2.0	8.3.0	R5s090070
RP-45	RP-090797	2654	-	Addition of GCF WI-068 Improved L2 RAB testcase 14.6.6a to HS_ENH_r7 ATS v8.1.0	B	8.2.0	8.3.0	R5s090068
RP-45	RP-090797	2655	-	Correction to GCF WI 70 CPC RRC test cases	F	8.2.0	8.3.0	R5s090080
RP-45	RP-090797	2656	-	Correction to the wk19 TTCN for Packet Uplink Assignment message	F	8.2.0	8.3.0	R5s090081
RP-45	RP-090797	2657	-	TTCN Correction to testcase 9.4.2.2.1.	F	8.2.0	8.3.0	R5s090082
RP-45	RP-090797	2658	-	Addition of GCF WI-070 CPC RRC testcase 8.2.6.58 to HS_ENH_r7 ATS v8.2.0	B	8.2.0	8.3.0	R5s090083
RP-45	RP-090797	2659	-	Improvement of Rel-7 security steps	F	8.2.0	8.3.0	R5s090087
RP-45	RP-090797	2660	-	Correction to Bcap type definition to support 9 speech versions	F	8.2.0	8.3.0	R5s090089
RP-45	RP-090797	2661	-	Correction to the CPC test case 8.2.6.58	F	8.2.0	8.3.0	R5s090093
RP-45	RP-090797	2662	-	Correction to the MRAT test case 8.3.7.14	F	8.2.0	8.3.0	R5s090092
RP-45	RP-090797	2663	-	Addition of CS Voice over HSPA test case 7.3.7.1	B	8.2.0	8.3.0	R5s090090
RP-45	RP-090797	2664	-	Addition of GCF WI-069 64QAM RAB test case 14.6.6b to HSPA7_ENH ATS v8.2.0	B	8.2.0	8.3.0	R5s090085
RP-45	RP-090797	2665	-	Correction to DualCarrierFreqParam Structured Type Definition	F	8.2.0	8.3.0	R5s090102
RP-45	RP-090797	2666	-	Corrections to GCF WI-068 and WI-069 test cases 14.6.1c and 7.1.5a.5.2 and 7.1.5a.5.3.	F	8.2.0	8.3.0	R5s090101
RP-45	RP-090797	2667	-	Correction to GCF WI 24/1 test case 6.1.2.11	F	8.2.0	8.3.0	R5s090100
RP-45	RP-090797	2668	-	Correction to GCF WI-010 IR-U test cases 8.3.9.5	F	8.2.0	8.3.0	R5s090097
RP-45	RP-090797	2669	-	Correction to GCF WI-025 HSUPA TC 7.1.6.2.2	F	8.2.0	8.3.0	R5s090106
RP-45	RP-090797	2670	-	Addition of GCF WI-068 IMPROVED L2 RRC testcase 8.2.2.57 to HS_ENH_r7 ATS v8.2.0	B	8.2.0	8.3.0	R5s090098
RP-45	RP-090797	2671	-	Addition of Rel-8 RRC test case 8.2.2.58	B	8.2.0	8.3.0	R5s090094
RP-45	RP-090797	2672	-	Packet Uplink Assignment should be sent on PACCH instead of PAGCH	F	8.2.0	8.3.0	R5s090103
RP-45	RP-090794	2673	-	Documentation of LCR TDD ASP changes	F	8.2.0	8.3.0	R5-094070
RP-45	RP-090799	2674	-	ASP enhancement for Improved Layer 2 UL and 64QAM+MIMO	F	8.2.0	8.3.0	R5-095029
RP-45	RP-090794	2675	-	ASP corrections for Enhanced FACH DL	F	8.2.0	8.3.0	R5-095190
RP-46	RP-091119	2676	-	Routine maintenance for divergent updates	F	8.3.0	8.4.0	R5-096431
RP-46	RP-091115	2677	-	Removal of GPRS P-channels from GERAN test model and ASPs	F	8.3.0	8.4.0	R5-096432
RP-46	RP-091113	2678	-	CR to 34.123-3: Add new verified and e-mail agreed TTCN test cases in the TC lists in 34.123-3 (prose), Annex A	F	8.3.0	8.4.0	-
RP-46	RP-091114	2679	-	Addition of GCF WI-101 Rel-7 Ciphering test case 8.2.2.43a to HSPA7_ENH ATS	B	8.3.0	8.4.0	R5s090107
RP-46	RP-091114	2680	-	Addition of GCF WI-101 Rel-7 Ciphering test case 8.1.7.4 to HSPA7_ENH ATS	B	8.3.0	8.4.0	R5s090109
RP-46	RP-091114	2681	-	Addition of GCF WI 70 Rel-7 CPC test case 8.2.3.37	B	8.3.0	8.4.0	R5s090104
RP-46	RP-091114	2682	-	Correction to CPC RRC test case 8.2.2.53	F	8.3.0	8.4.0	R5s090111
RP-46	RP-091114	2683	-	Correction to GCF WI 24/1 test case 6.2.1.10	F	8.3.0	8.4.0	R5s090112
RP-46	RP-091114	2684	-	Corrections to CPC testcases	F	8.3.0	8.4.0	R5s090122
RP-46	RP-091114	2685	-	Corrections to RAB Test Cases	F	8.3.0	8.4.0	R5s090126
RP-46	RP-091114	2686	-	Corrections to GCF Rel 99, Rel-5 and Rel-6 test cases	F	8.3.0	8.4.0	R5s090123
RP-46	RP-091114	2687	-	Correction to the test step ts_RRC_receiveConnSetupCmpl_CheckA5_3	F	8.3.0	8.4.0	R5s090119
RP-46	RP-091114	2688	-	Correction to the GCF WI-014 HSDPA TC 8.2.1.27, 8.3.4.9, 8.2.6.40	F	8.3.0	8.4.0	R5s090124
RP-46	RP-091114	2689	-	Addition of GCF WI-101 Rel-7 Ciphering test case 8.1.7.3c to HSPA7_ENH ATS	B	8.3.0	8.4.0	R5s090117
RP-46	RP-091114	2690	-	Addition of GCF WI-101 Rel-7 Ciphering test case 8.1.7.3b to HSPA7_ENH ATS	B	8.3.0	8.4.0	R5s090115
RP-46	RP-091114	2691	-	Addition of GCF WI-101 Rel-7 Ciphering test case 8.1.7.3 to HSPA7_ENH ATS	B	8.3.0	8.4.0	R5s090113
RP-46	RP-091114	2692	-	Correction to GCF WI 24/1 test case 6.1.1.9	F	8.3.0	8.4.0	R5s090120
RP-46	RP-091114	2693	-	Correction to R99 FACH to DCH and DCH to FACH transition RRC test cases	F	8.3.0	8.4.0	R5s090125
RP-46	RP-091114	2694	-	Correction to GCF WI 68 RRC test case 8.2.2.57	F	8.3.0	8.4.0	R5s090121
RP-46	RP-091114	2695	-	Correction to GCF WI-10 IR_U test case 8.4.1.33	F	8.3.0	8.4.0	R5s090129
RP-46	RP-091114	2696	-	Correction to WK37 TTCN	F	8.3.0	8.4.0	R5s090132
RP-46	RP-091114	2697	-	Correction to GCF WI-101 SNOW 3G TC 8.2.2.43a	F	8.3.0	8.4.0	R5s090131
RP-46	RP-091114	2698	-	TTCN Correction in TC 6.1.2.6	F	8.3.0	8.4.0	R5s090130
RP-46	RP-091114	2699	-	Addition of GCF WI-101 Rel-7 SNOW Ciphering test case 8.3.11.1a to HS_ENH_r7 ATS v8.2.0.	B	8.3.0	8.4.0	R5s090127

Meeting	TSG doc	CR	Rev	Subject	Cat	Old vers	New vers	WG doc
RP-46	RP-091114	2700	-	Correction to ts_TransitToURA_PCH_P17_P18 in RRC ATS	F	8.3.0	8.4.0	R5s090136
RP-46	RP-091114	2701	-	Correction to RRC Connection Request test steps to update Release Indication	F	8.3.0	8.4.0	R5s090133
RP-46	RP-091114	2702	-	Correction to HSDPA, HSUPA and HSPA7 DCH to FACH and FACH to DCH transition test cases	F	8.3.0	8.4.0	R5s090147
RP-46	RP-091114	2703	-	Corrections to Rel-6 testcases to make F-DPCH optional	F	8.3.0	8.4.0	R5s090143
RP-46	RP-091114	2704	-	Corrections to Rel-7 testcases to make F-DPCH optional	F	8.3.0	8.4.0	R5s090158
RP-46	RP-091114	2705	-	Correction to Rel-7 Enhanced L2 test case 8.2.2.57	F	8.3.0	8.4.0	R5s090146
RP-46	RP-091114	2706	-	Corrections to Rel-7 64QAM testcase 14.6.6b	F	8.3.0	8.4.0	R5s090159
RP-46	RP-091114	2707	-	Correction to GCF WI-101 Rel-7 Ciphering test case 8.2.2.43a	F	8.3.0	8.4.0	R5s090162
RP-46	RP-091114	2708	-	Addition of GCF WI-101 GCF Rel-7 Ciphering test case 8.2.2.43b to HSPA7_ENH ATS	B	8.3.0	8.4.0	R5s090173
RP-46	RP-091114	2709	-	Addition of GCF WI-101 Rel-7 Ciphering test case 8.1.7.3d to HSPA7_ENH ATS	B	8.3.0	8.4.0	R5s090169
RP-46	RP-091114	2710	-	Addition of CS voice over HSPA RAB test case 14.7.9	B	8.3.0	8.4.0	R5s090134
RP-46	RP-091114	2711	-	Addition of GCF WI 70 Rel-7 CPC MAC test case 7.1.6.3.4	B	8.3.0	8.4.0	R5s090151
RP-46	RP-091114	2712	-	Addition of GCF WI 70 Rel-7 CPC MAC test case 7.1.6.3.3	B	8.3.0	8.4.0	R5s090149
RP-46	RP-091114	2713	-	Addition of RFT067 test case 6.2.1.8a.2	B	8.3.0	8.4.0	R5s090187
RP-46	RP-091114	2714	-	Addition of RFT067 test case 6.2.1.8a.1	B	8.3.0	8.4.0	R5s090185
RP-46	RP-091114	2715	-	Addition of RFT067 test case 6.2.1.2a	B	8.3.0	8.4.0	R5s090183
RP-46	RP-091114	2716	-	Incorrect implementation of CR R5s090082	F	8.3.0	8.4.0	R5s090182
RP-46	RP-091114	2717	-	Addition of GCF WI 101 Rel-7 Snow 3G InterRAT test case 8.3.11.1b	B	8.3.0	8.4.0	R5s090190
RP-46	RP-091114	2718	-	Corrections to test steps and constraints with identical names	F	8.3.0	8.4.0	R5s090206
RP-46	RP-091114	2719	-	Corrections to L2 Enhancement RAB test case 14.7.6b	F	8.3.0	8.4.0	R5s090208
RP-46	RP-091114	2720	-	Addition of GCF WI 101 Rel-7 Snow 3G InterRAT test case 8.3.7.1b	B	8.3.0	8.4.0	R5s090192
RP-47	RP-100144	2721	-	CR to 34.123-3: Add new verified and e-mail agreed TTCN test cases in the TC lists in 34.123-3 (prose), Annex A	F	8.4.0	8.5.0	-
RP-47	RP-100145	2722	-	Correction to HSPA7 Enhanced L2 test case 8.2.2.57	F	8.4.0	8.5.0	R5s090305
RP-47	RP-100145	2723	-	Correction to RRC HSDPA test case 8.3.1.40	F	8.4.0	8.5.0	R5s090308
RP-47	RP-100145	2724	-	Correction to the test cases 8.2.6.55 and 14.7.9	F	8.4.0	8.5.0	R5s090309
RP-47	RP-100145	2725	-	Corrections to GMM test case 12.9.12	F	8.4.0	8.5.0	R5s090207
RP-47	RP-100145	2726	-	Addition of RFT067 test case 6.2.1.8a.3	B	8.4.0	8.5.0	R5s090338
RP-47	RP-100145	2727	-	Addition of RFT080 test case 8.1.2.22a	B	8.4.0	8.5.0	R5s090329
RP-47	RP-100145	2728	-	Addition of RFT080 test case 8.1.2.22	B	8.4.0	8.5.0	R5s090327
RP-47	RP-100145	2729	-	Addition of RFT080 test case 8.1.2.21a	B	8.4.0	8.5.0	R5s090325
RP-47	RP-100145	2730	-	Addition of RFT 80 test case 8.1.2.21	B	8.4.0	8.5.0	R5s090323
RP-47	RP-100145	2731	-	Correction to RRC test case 8.1.7.1, 8.1.7.1b, 8.1.7.1c and 8.1.7.2	F	8.4.0	8.5.0	R5s090372
RP-47	RP-100145	2732	-	Correction to Rel-7 CPC testcase 8.2.2.53	F	8.4.0	8.5.0	R5s090370
RP-47	RP-100145	2733	-	Correction to RRC test cases 8.1.1.1 and 8.1.1.9	F	8.4.0	8.5.0	R5s090374
RP-47	RP-100145	2734	-	Addition of GCF WI 80 Rel-7 CPC RRC test case 8.2.2.55	B	8.4.0	8.5.0	R5s100010
RP-47	RP-100145	2735	-	Correction to the test cases 8.3.1.39 from HSD_ENH_r5 test suite	F	8.4.0	8.5.0	R5s100026
RP-47	RP-100145	2736	-	Corrections to CPC testcases 7.1.6.3.3 & 7.1.6.3.4	F	8.4.0	8.5.0	R5s100023
RP-47	RP-100145	2737	-	TTCN Correction to testcase 7.1.6.2.10	F	8.4.0	8.5.0	R5s100027
RP-47	RP-100145	2738	-	TTCN Correction to test step ts_CC_EnterU10_MO	F	8.4.0	8.5.0	R5s100028
RP-47	RP-100145	2739	-	Correction to R99 testcase 8.2.2.35	F	8.4.0	8.5.0	R5s100036
RP-47	RP-100145	2740	-	Corrections to Rel-7 test step ts_InitVariablesRel7	F	8.4.0	8.5.0	R5s100037
RP-47	RP-100145	2741	-	Corrections to CPC RRC testcase 8.2.2.55	F	8.4.0	8.5.0	R5s100045
RP-47	RP-100145	2742	-	Correction to HSPA7 suite	F	8.4.0	8.5.0	R5s100048
RP-47	RP-100145	2743	-	Corrections to R99 NAS ATS	F	8.4.0	8.5.0	R5s100046
RP-47	RP-100145	2744	-	Correction to CPC test case 8.2.2.55	F	8.4.0	8.5.0	R5s100050
RP-47	RP-100145	2745	-	AGPS baseline upgrade to March 09 in Rel-8	F	8.4.0	8.5.0	R5s090224
RP-47	RP-100145	2746	-	Corrections to GCF WI 25 HSU test case 8.2.6.52	F	8.4.0	8.5.0	R5s090216
RP-47	RP-100145	2747	-	Correction to test cases 8.3.11.1a and 8.3.11.1b	F	8.4.0	8.5.0	R5s090303
RP-47	RP-100145	2748	-	Regression CR on wk46 TTCN	F	8.4.0	8.5.0	R5s090304
RP-47	RP-100145	2749	-	LCR TDD: Addition of NAS test case 12.4.1.5	B	8.4.0	8.5.0	R5s090299
RP-47	RP-100145	2750	-	LCR TDD: Addition of RRC test case 8.1.2.1	B	8.4.0	8.5.0	R5s090297
RP-47	RP-100145	2751	-	LCR TDD: Addition of RLC test case 7.2.3.28	B	8.4.0	8.5.0	R5s090295
RP-47	RP-100145	2752	-	LCR TDD: Addition of RLC test case 7.2.3.17	B	8.4.0	8.5.0	R5s090285

Meeting	TSG doc	CR	Rev	Subject	Cat	Old vers	New vers	WG doc
RP-47	RP-100145	2753	-	LCR TDD: Addition of RAB test case 18.1.2.32.1	B	8.4.0	8.5.0	R5s090301
RP-47	RP-100145	2754	-	LCR TDD: Addition of RLC test case 7.2.3.26	B	8.4.0	8.5.0	R5s090293
RP-47	RP-100145	2755	-	LCR TDD: Addition of RLC test case 7.2.3.22	B	8.4.0	8.5.0	R5s090291
RP-47	RP-100145	2756	-	LCR TDD: Addition of RLC test case 7.2.3.20	B	8.4.0	8.5.0	R5s090289
RP-47	RP-100145	2757	-	LCR TDD: Addition of RLC test case 7.2.3.18	B	8.4.0	8.5.0	R5s090287
RP-47	RP-100145	2758	-	LCR TDD: Addition of RLC test case 7.2.3.16	B	8.4.0	8.5.0	R5s090283
RP-47	RP-100145	2759	-	LCR TDD: Addition of RLC test case 7.2.3.15	B	8.4.0	8.5.0	R5s090281
RP-47	RP-100145	2760	-	LCR TDD: Addition of RLC test case 7.2.3.13	B	8.4.0	8.5.0	R5s090279
RP-47	RP-100145	2761	-	LCR TDD: Addition of RLC test case 7.2.3.6	B	8.4.0	8.5.0	R5s090277
RP-47	RP-100145	2762	-	LCR TDD: Addition of RLC test case 7.2.3.5	B	8.4.0	8.5.0	R5s090275
RP-47	RP-100145	2763	-	LCR TDD: Addition of RLC test case 7.2.3.4	B	8.4.0	8.5.0	R5s090273
RP-47	RP-100145	2764	-	LCR TDD: Addition of MAC test case 7.1.1.5	B	8.4.0	8.5.0	R5s090271
RP-47	RP-100145	2765	-	LCR TDD: Addition of MAC test case 7.1.1.4	B	8.4.0	8.5.0	R5s090269
RP-47	RP-100145	2766	-	LCR TDD: Addition of MAC test case 7.1.1.3	B	8.4.0	8.5.0	R5s090267
RP-47	RP-100145	2767	-	Correction to RRC test cases 6.1.2.2, 8.3.1.24 and 8.3.2.13	F	8.4.0	8.5.0	R5s090371
RP-47	RP-100145	2768	-	Correction to HSD, HSU and HS7 test cases	F	8.4.0	8.5.0	R5s100056
RP-47	RP-100145	2769	-	Addition of CS Over HSPA test case 14.7.10	B	8.4.0	8.5.0	R5s100059
RP-47	RP-100145	2770	-	Addition of GCF WI 25 HSUPA MAC test case 7.1.6.3.2	B	8.4.0	8.5.0	R5s100061
RP-47	RP-100153	2771	-	UTRA LCR TDD ASP enhancement for Rel-8	F	8.4.0	8.5.0	R5-100047
RP-47	RP-100137	2772	-	Routine maintenance for divergent updates	F	8.4.0	8.5.0	R5-101042
RP-47	RP-100149	2773	-	Update ASP for FDD dual cell test	F	8.4.0	8.5.0	R5-101047
RP-47	RP-100150	2774	-	FDD ASP enhancement for the enhanced UL of FACH test	F	8.4.0	8.5.0	R5-101048
RP-48	RP-100512	2775	-	CR to 34.123-3: Add new verified and e-mail agreed TTCN test cases in the TC lists in 34.123-3 (prose), Annex A	F	8.5.0	8.6.0	-
RP-48	RP-100506	2790	-	Routine maintenance of TS 34.123-3	F	8.5.0	8.6.0	R5-103530
RP-48	RP-100519	2791	-	ASP correction for Enhanced FACH uplink	F	8.5.0	8.6.0	R5-103645
RP-48	RP-100517	2792	-	ASP corrections for Dual Cell	F	8.5.0	8.6.0	R5-103863
RP-48	RP-100513	2776	-	Correction to HSU test cases.	F	8.5.0	8.6.0	R5s100064
RP-48	RP-100513	2777	-	Corrections to HSUPA MAC testcase 7.1.6.2.6	F	8.5.0	8.6.0	R5s100069
RP-48	RP-100513	2779	-	Regression CR for UMTS ATS	F	8.5.0	8.6.0	R5s100070
RP-48	RP-100513	2778	-	Corrections to RRC testcase 8.2.6.37 & 8.2.6.37b	F	8.5.0	8.6.0	R5s100071
RP-48	RP-100513	2780	-	Correction to Rel-7 RAB test cases on HARQ number of processes initialization	F	8.5.0	8.6.0	R5s100108
RP-48	RP-100513	2781	-	Regression CR for WK10 TTCN	F	8.5.0	8.6.0	R5s100115
RP-48	RP-100513	2782	-	Correction to WI-101 HS_ENH_r7 test case 8.3.7.1b	F	8.5.0	8.6.0	R5s100121
RP-48	RP-100513	2783	-	Correction to WI-070 CPC test case 8.2.2.53	F	8.5.0	8.6.0	R5s100122
RP-48	RP-100513	2784	-	Addition of GCF WI-114 64 QAM RRC test case 8.2.2.63 to HSPA7_ENH ATS	B	8.5.0	8.6.0	R5s100123
RP-48	RP-100513	2785	-	Addition of GCF WI-114 64 QAM RRC test case 8.2.6.62 to HSPA7_ENH ATS	B	8.5.0	8.6.0	R5s100125
RP-48	RP-100513	2786	-	Correction to testcases 8.3.2.12, 6.2.2.2	F	8.5.0	8.6.0	R5s100164
RP-48	RP-100513	2788	-	Correction to RRC Connection Release test steps in RAB R99 - R8 test cases	F	8.5.0	8.6.0	R5s100165
RP-48	RP-100513	2789	-	Correction to the Out of Service area test cases.	F	8.5.0	8.6.0	R5s100168
RP-48	RP-100513	2787	-	Baseline upgrade of UTRA ATS to March-10 Rel-8	F	8.5.0	8.6.0	R5s100171
RP-49	RP-100985	2793	-	ASP documentation for TDD and maintenance	F	8.6.0	8.7.0	R5-104203
RP-49	RP-100985	2794	-	Routine maintenance of TS 34.123-3	F	8.6.0	8.7.0	R5-105034
RP-49	RP-100985	2795	-	Add new PIXIT related to GERAN UE classmarks	F	8.6.0	8.7.0	R5-105027
RP-49	RP-100824	2796	-	Correction to the GCF WI-24 test case 6.2.1.11	F	8.6.0	8.7.0	R5s100185
RP-49	RP-100824	2797	-	Corrections to Rel-99 NAS testcases	F	8.6.0	8.7.0	R5s100207
RP-49	RP-100824	2798	-	Corrections to Rel-7 testcases	F	8.6.0	8.7.0	R5s100206
RP-49	RP-100824	2799	-	Regression CR on wk16 UMTS ATS	F	8.6.0	8.7.0	R5s100186
RP-49	RP-100824	2800	-	Correction to GCF WI-025 E_DCH Testcase 7.1.6.2.1	F	8.6.0	8.7.0	R5s100255
RP-49	RP-100824	2801	-	Correction to GCF WI 25 HSU test cases 7.1.6.4.2 and 7.1.6.2.1	F	8.6.0	8.7.0	R5s100276
RP-49	RP-100824	2802	-	Corrections to Rel-6 HSUPA MAC test cases	F	8.6.0	8.7.0	R5s100290
RP-49	RP-100824	2803	-	Regression CR on wk21 UMTS ATS	F	8.6.0	8.7.0	R5s100275
RP-49	RP-100824	2804	-	Correction to GCF WI-070 CPC Test Cases 7.1.6.3.3, 7.1.6.3.4	F	8.6.0	8.7.0	R5s100280
RP-49	RP-100824	2805	-	Correction to Rel-99 SMS test case 16.3	F	8.6.0	8.7.0	R5s100297
RP-49	RP-100824	2806	-	Correction to GCF WI 25 HSUPA MAC test case 7.1.6.3.2	F	8.6.0	8.7.0	R5s100328
RP-49	RP-100824	2807	-	Addition of GCF WI 70 Rel-7 CPC test case 8.3.4.11	F	8.6.0	8.7.0	R5s100277
RP-49	RP-100824	2808	-	Correction to GCF WI 25 HSUPA test case 7.1.6.3.2	B	8.6.0	8.7.0	R5s100355
RP-49	RP-100824	2809	-	Correction to GCF WI-070 CPC test case 8.2.3.37	F	8.6.0	8.7.0	R5s100484
RP-49	RP-100824	2810	-	Correction to GCF WI-025 HSUPA test case 7.1.6.3.2	F	8.6.0	8.7.0	R5s100483
RP-49	RP-100824	2811	-	Correction to GCF WI-070 CPC Test Cases 7.1.6.3.3, 7.1.6.3.4	F	8.6.0	8.7.0	R5s100404

Meeting	TSG doc	CR	Rev	Subject	Cat	Old vers	New vers	WG doc
RP-49	RP-100824	2812	-	Correction to GCF WI 10 RRC test case 6.1.2.2.	F	8.6.0	8.7.0	R5s100397
RP-49	RP-100824	2813	-	Correction to GCF WI 10 IR_U test case 8.3.9.5.	F	8.6.0	8.7.0	R5s100396
RP-49	RP-100824	2814	-	Corrections to R7 CPC test cases	F	8.6.0	8.7.0	R5s100482
RP-49	RP-100824	2815	-	Corrections to HSUPA MAC test case 7.1.6.3.2 & 7.1.6.2.6	F	8.6.0	8.7.0	R5s100481
RP-49	RP-100823	2816	-	CR to 34.123-3: Add new verified and e-mail agreed TTCN test cases in the TC lists in 34.123-3 (prose), Annex A	F	8.6.0	8.7.0	-
-	-	-	-	Updated the lists of approved test cases for FDD and LCR TDD in Annex A to align with TTCN.	-	8.6.0	8.7.0	-
RP-50	RP-101148	2819	-	CR to 34.123-3: Add new verified and e-mail agreed TTCN test cases in the TC lists in 34.123-3 (prose), Annex A	F	8.7.0	8.8.0	-
RP-50	RP-101146	2817	-	New channel configurations for LCR TDD RB tests	F	8.7.0	8.8.0	R5-106065
RP-50	RP-101146	2818	-	Routine maintenance	F	8.7.0	8.8.0	R5-106547
RP-50	RP-101149	2822	-	Addition of GCF WI-110 Enhanced Cell FACH DL MAC test case 7.1.5a.6 to HSPA7_ENH ATS	F	8.7.0	8.8.0	R5s100509
RP-50	RP-101149	2821	-	Addition of GCF WI-110 Enhanced Cell FACH DL RRC test case 8.1.2.20 to HSPA7_ENH ATS	F	8.7.0	8.8.0	R5s100511
RP-50	RP-101149	2820	-	Correction to GCF WI 10 SMS test case 16.1.1	F	8.7.0	8.8.0	R5s100514
RP-50	RP-101149	2824	-	Correction to GCF WI-024 network sharing test case 6.2.1.11	F	8.7.0	8.8.0	R5s100518
RP-50	RP-101149	2823	-	Correction for GCF WI-010 NAS test case 12.2.1.11	F	8.7.0	8.8.0	R5s100519
RP-50	RP-101149	2826	-	Regression CR on wk36 UMTS ATS	F	8.7.0	8.8.0	R5s100540
RP-50	RP-101149	2828	-	Corrections to Rel-7 Enhanced Cell-FACH DL test cases	F	8.7.0	8.8.0	R5s100543
RP-50	RP-101149	2827	-	Corrections to Rel-7 L2-Enhancement test case 8.2.2.57	F	8.7.0	8.8.0	R5s100544
RP-50	RP-101149	2825	-	Corrections to Rel-7 CPC test case 8.2.6.58 and Rel-7 L2 Enh test case 8.2.2.57	F	8.7.0	8.8.0	R5s100547
RP-50	RP-101149	2834	-	Correction to GCF WI-025 testcase 7.1.6.3.2	F	8.7.0	8.8.0	R5s100551
RP-50	RP-101149	2833	-	Corrections to Rel-8 CSVoice over HSPA test cases	F	8.7.0	8.8.0	R5s100552
RP-50	RP-101149	2832	-	Corrections to Rel-6 test cases 8.2.1.36 and 8.2.1.36a	F	8.7.0	8.8.0	R5s100553
RP-50	RP-101149	2831	-	Correction to GCF WI-025 testcase 7.1.6.2.10	F	8.7.0	8.8.0	R5s100554
RP-50	RP-101149	2830	-	Addition of GCF WI-067 MiMo RAB test case 14.6.1d to HSPA7_ENH ATS	F	8.7.0	8.8.0	R5s100567
RP-50	RP-101149	2829	-	Addition of GCF WI-067 MiMo RAB test case 14.6.6c to HSPA7_ENH ATS	F	8.7.0	8.8.0	R5s100569
RP-50	RP-101149	2835	-	Correction to UE Network Capability in UMTS	F	8.7.0	8.8.0	R5s100574
RP-50	RP-101149	2836	-	Correction to UMTS Security Capabilities.	F	8.7.0	8.8.0	R5s100578
RP-50	RP-101149	2838	-	Addition of GCF WI-110 Enhanced Cell FACH DL RAB test case 14.5.3 to HSPA7_ENH ATS	F	8.7.0	8.8.0	R5s100599
RP-50	RP-101149	2837	-	Addition of GCF WI-110 Enhanced Cell FACH DL RRC test case 8.1.10.2 to HSPA7_ENH ATS	F	8.7.0	8.8.0	R5s100601
RP-50	RP-101149	2839	-	Corrections to Rel-99 testcases	F	8.7.0	8.8.0	R5s100613
RP-50	RP-101149	2840	-	Correction to the common test steps_RegistrationReject_Idle	F	8.7.0	8.8.0	R5s100677

Meeting	TSG doc	CR	Rev	Subject	Cat	Old vers	New vers	WG doc
RP-50	RP-101149	2842	-	Addition of GCF WI-110 Enhanced Cell FACH DL RRC test case 8.2.2.59 to HSPA7_ENH ATS	F	8.7.0	8.8.0	R5s100716
RP-50	RP-101149	2841	-	Addition of GCF WI-110 Enhanced Cell FACH DL RRC test case 8.2.2.60 to HSPA7_ENH ATS	F	8.7.0	8.8.0	R5s100718
RP-50	RP-101149	2846	-	Correction to MAC testcase 7.1.5a.6	F	8.7.0	8.8.0	R5s100762
RP-50	RP-101149	2845	-	Correction to Rel-7 CPC testcase 8.3.4.11	F	8.7.0	8.8.0	R5s100763
RP-50	RP-101149	2844	-	Correction for GCF WI-010 SMS test case 16.2.2	F	8.7.0	8.8.0	R5s100770
RP-50	RP-101149	2843	-	Correction for GCF WI-012 NAS test case 9.4.3.3	F	8.7.0	8.8.0	R5s100771
RP-51	RP-110167	2850	-	CR to 34.123-3: Add new verified and e-mail agreed TTCN test cases in the TC lists in 34.123-3 (prose), Annex A	F	8.8.0	8.9.0	-
RP-51	RP-110165	2847	-	Routine maintenance for LCR TDD ASP	F	8.8.0	8.9.0	R5-110103
RP-51	RP-110165	2848	-	Routine maintenance of 34123-3	F	8.8.0	8.9.0	R5-110104
RP-51	RP-110165	2849	-	Table and figure renumbering in 34.123-3	F	8.8.0	8.9.0	R5-110365
RP-51	RP-110168	2860	-	Addition of GCF WI-104 Idle Mode test case 6.1.1.14 to HSPA7_ENH ATS	B	8.8.0	8.9.0	R5s100710
RP-51	RP-110168	2865	-	Addition of GCF WI-104 Idle Mode test case 6.1.1.12 to HSPA7_ENH ATS	B	8.8.0	8.9.0	R5s100764
RP-51	RP-110168	2859	-	Correction to GCF WI 10 NAS test case 12.2.1.4.2	F	8.8.0	8.9.0	R5s100786
RP-51	RP-110168	2858	-	Correction for GCF WI-010 SMS test case 16.2.1	F	8.8.0	8.9.0	R5s100791
RP-51	RP-110168	2857	-	Correction to Rel-7 GCF WI-110 testcase 7.1.5a.6	F	8.8.0	8.9.0	R5s100798
RP-51	RP-110168	2863	-	Correction for GCF WI-025 HSUPA test case 8.2.6.51	F	8.8.0	8.9.0	R5s100804
RP-51	RP-110168	2864	-	Correction to RRC test cases 8.2.2.43 and 8.2.2.43a	F	8.8.0	8.9.0	R5s100805
RP-51	RP-110168	2862	-	Correction to Rel-7 MAC test case 7.1.5a.5.2 and 7.1.5a.5.3	F	8.8.0	8.9.0	R5s100807
RP-51	RP-110168	2861	-	Correction to the RFT 67 test cases	F	8.8.0	8.9.0	R5s100808
RP-51	RP-110168	2852	-	Addition of GCF WI-114 64 QAM RRC test case 8.3.4.13 to HSPA7_ENH ATS	B	8.8.0	8.9.0	R5s100809
RP-51	RP-110168	2851	-	Corrections to Rel-7 Enhanced Cell-FACH DL and L2 Enhancement testcases	F	8.8.0	8.9.0	R5s100841
RP-51	RP-110168	2853	-	Addition of GCF WI-110 Enhanced Cell FACH DL RRC test case 8.3.1.47 to HSPA7_ENH ATS	B	8.8.0	8.9.0	R5s110017
RP-51	RP-110168	2856	-	Correction to GCF WI-010 RRC test case 8.3.2.12	F	8.8.0	8.9.0	R5s110048
RP-51	RP-110168	2855	-	Correction to GCF WI-067 HSPA7 MIMO test cases 14.6.1d and 14.6.6c	F	8.8.0	8.9.0	R5s110049
RP-51	RP-110168	2854	-	Correction to GCF WI-010 NAS test case 12.2.1.3	F	8.8.0	8.9.0	R5s110050
RP-51	RP-110168	2866	-	Correction to RFT 67 test cases	F	8.8.0	8.9.0	R5s110066
RP-51	RP-110168	2867	-	Corrections to CPC & CS Voice Over HSPA testcases	F	8.8.0	8.9.0	R5s110072
RP-51	RP-110168	2868	-	Correction to GCF WI 25 HSUPA MAC test case 7.1.6.1.1	F	8.8.0	8.9.0	R5s110083
RP-52	RP-110653	2871	-	CR to 34.123-3: Add new verified and e-mail agreed TTCN test cases in the TC lists in 34.123-3 (prose), Annex A	F	8.9.0	9.0.0	-

Meeting	TSG doc	CR	Rev	Subject	Cat	Old vers	New vers	WG doc
RP-52	RP-110651	2869	-	Removal of technical content in 34.123-3 v8.9.0 and substitution with pointer to the next Release	F	8.9.0	9.0.0	R5-112242
RP-52	RP-110652	2870	-	Routing maintenance	F	8.9.0	9.0.0	R5-112591
RP-52	RP-110654	2873	-	Correction to CS Voice Over HSPA RRC test case 8.2.2.58	F	8.9.0	9.0.0	R5s110059
RP-52	RP-110654	2874	-	Corrections to Rel-7 64QAM test case 8.3.4.13	F	8.9.0	9.0.0	R5s110071
RP-52	RP-110654	2872	-	Correction to GMM test case 12.4.3.4	F	8.9.0	9.0.0	R5s110093
RP-52	RP-110654	2882	-	Addition of GCF WI-104 Idle Mode test case 6.1.1.13 to HSPA7_ENH ATS	B	8.9.0	9.0.0	R5s110102
RP-52	RP-110654	2881	-	Addition of GCF WI-104 Idle Mode test case 6.1.1.15 to HSPA7_ENH ATS	B	8.9.0	9.0.0	R5s110104
RP-52	RP-110654	2880	-	Correction to GCF WI-014 HSDPA test case 7.1.5.6	F	8.9.0	9.0.0	R5s110106
RP-52	RP-110654	2878	-	Corrections to RFT-67 test cases 6.2.1.2a and 6.2.1.8a.2	F	8.9.0	9.0.0	R5s110107
RP-52	RP-110654	2879	-	Correction to GCF WI-010 RLC test case 7.2.3.24	F	8.9.0	9.0.0	R5s110108
RP-52	RP-110654	2877	-	Correction to HSPA7_ENH test suite	F	8.9.0	9.0.0	R5s110111
RP-52	RP-110654	2876	-	Correction to the Rel-7 Enhanced Cell FACH test case 14.5.3 and 8.1.10.2	F	8.9.0	9.0.0	R5s110113
RP-52	RP-110654	2875	-	Correction to the Rel-7 Enhanced Cell FACH test case 8.2.2.59	F	8.9.0	9.0.0	R5s110126
RP-52	RP-110654	2883	-	Regression CR on wk10 UMTS ATS	F	8.9.0	9.0.0	R5s110169
RP-52	RP-110654	2889	-	Baseline upgrade of UTRA ATS to March-11 in Rel-9	F	8.9.0	9.0.0	R5s110175
RP-52	RP-110654	2884	-	Corrections to Rel-7 Enhanced CellFACH testcases (11wk10)	F	8.9.0	9.0.0	R5s110191
RP-52	RP-110654	2886	-	Correction to GCF WI-101 HSPA7 test case 8.1.7.3c	F	8.9.0	9.0.0	R5s110224
RP-52	RP-110654	2887	-	Correction to GCF WI-010 NAS test cases 12.2.1.4.1 and 12.2.1.5a.1	F	8.9.0	9.0.0	R5s110225
RP-52	RP-110654	2885	-	Corrections to UTRA Rel-7 & Rel-8 testcases (11wk10)	F	8.9.0	9.0.0	R5s110229
RP-52	RP-110654	2888	-	Regression CR on wk10 UMTS ATS	F	8.9.0	9.0.0	R5s110231
RP-52	RP-110654	2891	-	Correction to RRC HSDPA test case 8.2.2.42	F	8.9.0	9.0.0	R5s110240
RP-52	RP-110654	2890	-	Correction to the transmission of SI 2Bis for MRAT test cases	F	8.9.0	9.0.0	R5s110241
RP-53	RP-111158	2894	-	CR to 34.123-3: Add new verified and e-mail agreed TTCN test cases in the TC lists in 34.123-3 (prose), Annex A	F	9.0.0	9.1.0	-
RP-53	RP-111142	2892	-	Routine maintenance and updates for LCR TDD	F	9.0.0	9.1.0	R5-113036
RP-53	RP-111143	2893	-	Routine maintenance and updates	F	9.0.0	9.1.0	R5-113653
RP-53	RP-111159	2896	-	Correction to the idle mode test case 6.1.2.3	F	9.0.0	9.1.0	R5s110280
RP-53	RP-111159	2895	-	Correction to AT commands used for PS call activation	F	9.0.0	9.1.0	R5s110281
RP-53	RP-111159	2897	-	Correction to GCF WI 25 HSUPA MAC test case 7.1.6.1.1	F	9.0.0	9.1.0	R5s110284
RP-53	RP-111159	2898	-	Correction to GCF WI-010 test case 12.6.1.3.3	F	9.0.0	9.1.0	R5s110316

Meeting	TSG doc	CR	Rev	Subject	Cat	Old vers	New vers	WG doc
RP-53	RP-111159	2903	-	Addition of GCF WI-110 Enhanced Cell FACH DL RRC test case 8.1.1.5a to HSPA7_ENH ATS	F	9.0.0	9.1.0	R5s110332
RP-53	RP-111159	2902	-	Addition of GCF WI-110 Enhanced Cell FACH DL RRC test case 8.1.1.12 to HSPA7_ENH ATS	F	9.0.0	9.1.0	R5s110334
RP-53	RP-111159	2901	-	Correction to GCF WI-010 Idle mode test case 6.1.2.3	F	9.0.0	9.1.0	R5s110343
RP-53	RP-111159	2900	-	Correction to GCF WI-010 RRC test case 8.3.2.12	F	9.0.0	9.1.0	R5s110344
RP-53	RP-111159	2899	-	Correction to GCF WI-068 RRC test case 8.2.2.57	F	9.0.0	9.1.0	R5s110345
RP-53	RP-111159	2906	-	Adding originating subscribed traffic call in RRC establishment cause	F	9.0.0	9.1.0	R5s110349
RP-53	RP-111159	2905	-	Addition of GCF WI-110 Enhanced Cell FACH DL RRC test case 8.4.1.50 to HSPA7_ENH ATS	F	9.0.0	9.1.0	R5s110366
RP-53	RP-111159	2904	-	Addition of GCF WI-110 Enhanced Cell FACH DL test case 7.1.5a.7 to HSPA7_ENH ATS	F	9.0.0	9.1.0	R5s110380
RP-53	RP-111159	2909	-	Addition of GCF WI-118 MIMO Enhancement test case 8.2.2.62 to HSPA7_ENH ATS	F	9.0.0	9.1.0	R5s110387
RP-53	RP-111159	2908	-	Addition of 3G eCall test case 13.3.1.2 to HSPA8_ENH ATS	F	9.0.0	9.1.0	R5s110390
RP-53	RP-111159	2907	-	Addition of 3G eCall test case 13.3.1.3 to HSPA8_ENH ATS	F	9.0.0	9.1.0	R5s110392
RP-53	RP-111159	2914	-	Corrections to Rel6 RRC and idle mode test cases	F	9.0.0	9.1.0	R5s110434
RP-53	RP-111159	2910	-	Corrections to UTRA 11wk21 ATS	F	9.0.0	9.1.0	R5s110477
RP-53	RP-111159	2913	-	Addition of GCF WI-070 HS SCCH Less test case 8.2.6.56 to HSPA7_ENH ATS	F	9.0.0	9.1.0	R5s110479
RP-53	RP-111159	2912	-	Correction to GCF WI-110 test case 8.4.1.50	F	9.0.0	9.1.0	R5s110490
RP-53	RP-111159	2911	-	Addition of GCF WI-070 HS SCCH Less test case 8.2.1.39 to HSPA7_ENH ATS	F	9.0.0	9.1.0	R5s110501
RP-53	RP-111159	2919	-	Addition of PPAC NAS test case 12.2.2.10 to HSPA8_ENH ATS	F	9.0.0	9.1.0	R5s110503
RP-53	RP-111159	2918	-	Addition of GCF WI-129 DC-HSDPA test case 14.6.1f to HSPA8_ENH ATS	F	9.0.0	9.1.0	R5s110522
RP-53	RP-111159	2917	-	Addition of GCF WI-129 DC-HSDPA test case 14.6.1g to HSPA8_ENH ATS	F	9.0.0	9.1.0	R5s110524
RP-53	RP-111159	2916	-	Addition of GCF WI-129 DC-HSDPA test case 14.6.6e to HSPA8_ENH ATS	F	9.0.0	9.1.0	R5s110536
RP-53	RP-111159	2915	-	Addition of GCF WI-129 DC-HSDPA test case 8.3.4.15 to HSPA8_ENH ATS	F	9.0.0	9.1.0	R5s110538
RP-53	RP-111159	2921	-	Addition of eCall test case 13.3.1.5 to HSPA8_ENH ATS	F	9.0.0	9.1.0	R5s110542
RP-53	RP-111159	2920	-	Addition of eCall test case 13.3.1.7 to HSPA8_ENH ATS	F	9.0.0	9.1.0	R5s110544
RP-54	RP-111583	2922	-	Routine maintenance and updates for UTRA FDD	F	9.1.0	9.2.0	R5-115748
RP-54	RP-111585	2923	-	CR to 34.123-3: Add new verified and e-mail agreed TTCN test cases in the TC lists in 34.123-3 (prose), Annex A	F	9.1.0	9.2.0	-
RP-54	RP-111586	2924	-	Addition of GCF WI-130 Improved L2 UL RAB test case 14.7.3a to HSPA8_ENH ATS	F	9.1.0	9.2.0	R5s110540
RP-54	RP-111586	2925	-	Correction to GCF WI-012 RRC test case 8.3.4.8	F	9.1.0	9.2.0	R5s110606

Meeting	TSG doc	CR	Rev	Subject	Cat	Old vers	New vers	WG doc
RP-54	RP-111586	2926	-	Corrections to 11wk36 ATS for Rel-7/Rel-8 testcases	F	9.1.0	9.2.0	R5s110635
RP-54	RP-111586	2927	-	Addition of GCF WI-118 MIMO test case 8.2.6.63 to HSPA7_ENH ATS	F	9.1.0	9.2.0	R5s110629
RP-54	RP-111586	2928	-	Addition of GCF WI-118 MIMO test case 8.2.6.54a to HSPA7_ENH ATS	F	9.1.0	9.2.0	R5s110627
RP-54	RP-111586	2929	-	Addition of GCF WI-129 DC-HSDPA test case 14.6.6f to HSPA8_ENH ATS	F	9.1.0	9.2.0	R5s110625
RP-54	RP-111586	2930	-	Regression CR for UTRA wk36 ATS	F	9.1.0	9.2.0	R5s110597
RP-54	RP-111586	2931	-	Addition of GCF WI-130 Improved L2 UL RAB test case 14.7.6c to HSPA8_ENH ATS	F	9.1.0	9.2.0	R5s110662
RP-54	RP-111586	2932	-	Addition of PPAC RRC test case 8.1.2.26 to HSPA8_ENH ATS	F	9.1.0	9.2.0	R5s110660
RP-54	RP-111586	2933	-	Correction to GMM test cases 12.4.1.4c2 and 12.4.1.4d1	F	9.1.0	9.2.0	R5s110686
RP-54	RP-111586	2934	-	Changes related to originating subscribed traffic call	F	9.1.0	9.2.0	R5s110689
RP-54	RP-111586	2935	-	Addition of TC 8.1.5.7 to HSPA9 ATS	F	9.1.0	9.2.0	R5s110671
RP-54	RP-111586	2936	-	Correction to GCF WI-068 RAB test case 14.7.6b	F	9.1.0	9.2.0	R5s110716
RP-54	RP-111586	2937	-	Correction to ts_SetMCC_VPLMN_Band6	F	9.1.0	9.2.0	R5s110715
RP-54	RP-111586	2938	-	Correction to GCF WI-010 NAS test case 12.4.1.4a	F	9.1.0	9.2.0	R5s110714
RP-54	RP-111586	2939	-	Corrections to GCF WI-070 CPC test case 8.3.4.11	F	9.1.0	9.2.0	R5s110711
RP-55	RP-120172	2940	-	Routine maintenance and updates for LCR TDD	F	9.2.0	9.3.0	R5-120307
RP-55	RP-120184	2941	-	Routine maintenance and updates	F	9.2.0	9.3.0	R5-120613
RP-55	RP-120185	2942	-	CR to 34.123-3: Add new verified and e-mail agreed TTCN test cases in the TC lists in 34.123-3 (prose), Annex A	F	9.2.0	9.3.0	-
RP-55	RP-120186	2943	-	Addition of Rel-8 64QAM+Mimo RAB test case 14.6.6d to HSPA8_ENH ATS	F	9.2.0	9.3.0	R5s110735
RP-55	RP-120186	2944	-	Addition of Rel-8 64QAM+Mimo RAB test case 14.6.1e to HSPA8_ENH ATS	F	9.2.0	9.3.0	R5s110733
RP-55	RP-120186	2945	-	Regression CR for UTRA wk48 ATS	F	9.2.0	9.3.0	R5s120015
RP-55	RP-120186	2946	-	Correction to GCF WI-110 Enhanced Cell FACH test case 8.3.1.47	F	9.2.0	9.3.0	R5s120005
RP-55	RP-120186	2947	-	Addition of eCall test case 13.3.1.4 to HSPA8_ENH ATS	F	9.2.0	9.3.0	R5s110797
RP-55	RP-120186	2948	-	Addition of GCF WI-130 Improved L2 UL MAC test case 7.1.7.1 to HSPA8_ENH ATS	F	9.2.0	9.3.0	R5s110755
RP-55	RP-120186	2949	-	Corrections to 11wk48 ATS for Rel-7/Rel-8 testcases	F	9.2.0	9.3.0	R5s120047
RP-55	RP-120186	2950	-	Correction to selection expression for GMM TCs 12.9.x	F	9.2.0	9.3.0	R5s120032
RP-55	RP-120186	2951	-	Correction to GCF WI-110 Enhanced Cell FACH test case 7.1.5a.7	F	9.2.0	9.3.0	R5s120004
RP-55	RP-120186	2952	-	Correction to MS Classmark 2 and MS Identity IEs in the NAS Messages	F	9.2.0	9.3.0	R5s120063
RP-55	RP-120186	2953	-	Addition of GCF WI-129 DC test case 8.3.4.16 to HSPA8_ENH ATS	F	9.2.0	9.3.0	R5s120043

Meet- ing	TSG doc	CR	Rev	Subject	Cat	Old vers	New vers	WG doc
RP-55	RP-120186	2954	-	Addition of GCF WI-129 DC test case 8.3.4.16a to HSPA8_ENH ATS	F	9.2.0	9.3.0	R5s120045
RP-55	RP-120186	2955	-	Addition of GCF WI-129 DC test case 8.3.4.15a to HSPA8_ENH ATS	F	9.2.0	9.3.0	R5s120041
RP-55	RP-120186	2956	-	Correction to RRC test case 8.3.2.11	F	9.2.0	9.3.0	R5s120064
RP-55	RP-120186	2957	-	Correction to test case 8.1.5.7	F	9.2.0	9.3.0	R5s120066
RP-56	RP-120650	2959	-	CR to 34.123-3: Add new verified and e-mail agreed TTCN test cases in the TC lists in 34.123-3 (prose), Annex A	F	9.3.0	10.0.0	-
RP-56	RP-120666	2958	-	Routine maintenance and updates	F	9.3.0	10.0.0	R5-121732
RP-56	RP-120654	2977	-	Correction to UTRA test cases	F	9.3.0	10.0.0	R5s120085
RP-56	RP-120654	2976	-	Correction to selection expression of GCF WI-67 test case 14.6.6c	F	9.3.0	10.0.0	R5s120094
RP-56	RP-120654	2975	-	Regression CR for UTRA wk08 ATS	F	9.3.0	10.0.0	R5s120123
RP-56	RP-120654	2972	-	Corrections to VoiceDomainPref IE definition in Attach Request	F	9.3.0	10.0.0	R5s120131
RP-56	RP-120654	2974	-	Correction to the NAS test cases for USIM removal	F	9.3.0	10.0.0	R5s120171
RP-56	RP-120654	2973	-	Correction to GCF WI-010 NAS test case 12.4.1.4a	F	9.3.0	10.0.0	R5s120172
RP-56	RP-120654	2964	-	Baseline upgrade of UTRA ATS to March-12 in Rel-10	F	9.3.0	10.0.0	R5s120177
RP-56	RP-120654	2971	-	Correction to UTRA RRC PPAC test case 8.1.2.26	F	9.3.0	10.0.0	R5s120217
RP-56	RP-120654	2970	-	Addition of 3G eCall test case 13.3.1.6 to HSPA8_ENH ATS	F	9.3.0	10.0.0	R5s120225
RP-56	RP-120654	2969	-	Correction to Rel-99 RRC test case 8.3.1.9	F	9.3.0	10.0.0	R5s120242
RP-56	RP-120654	2966	-	Correction to UTRA Capability testcase 8.1.5.7 (Based on 12wk08 ATS)	F	9.3.0	10.0.0	R5s120267
RP-56	RP-120654	2967	-	Corrections to Rel-8 testcases (12wk08 ATS)	F	9.3.0	10.0.0	R5s120268
RP-56	RP-120654	2968	-	Corrections to NAS testcase 9.4.2.4.1 (12wk08 ATS)	F	9.3.0	10.0.0	R5s120269
RP-56	RP-120654	2965	-	Correction to test step ts_SendSysInfoType2ter	F	9.3.0	10.0.0	R5s120270
RP-56	RP-120654	2963	-	Correction to IRAT test cases in IR_U Test Suite	F	9.3.0	10.0.0	R5s120272
RP-56	RP-120654	2962	-	Addition of 3G eCall test case 13.3.1.10 to HSPA8_ENH ATS	F	9.3.0	10.0.0	R5s120299
RP-56	RP-120654	2961	-	Correction to UTRA test case 8.1.5.7	F	9.3.0	10.0.0	R5s120337
RP-56	RP-120654	2960	-	Correction to UTRA test case 8.4.1.8	F	9.3.0	10.0.0	R5s120343
RP-57	RP-121103	2978	-	34123-3: Routine maintenance and updates	F	10.0.0	10.1.0	R5-123084
RP-57	RP-121103	2979	-	Removal of technical content in 34.123-3 v9.4.0 and substitution with pointer to the next Release	F	10.0.0	10.1.0	R5-123308
RP-57	RP-121105	2980	-	Regression CR for UTRA wk16 ATS	F	10.0.0	10.1.0	R5s120273
RP-57	RP-121105	2981	-	Addition of ETWS test case 8.1.1.13 to HSPA8_ENH ATS	F	10.0.0	10.1.0	R5s120362
RP-57	RP-121105	2982	-	Regression CR for UTRA 12wk16 ATS	F	10.0.0	10.1.0	R5s120376
RP-57	RP-121105	2983	-	Addition of CS Voice over HSPA test case 7.3.7.2 to HSPA8 ATS	F	10.0.0	10.1.0	R5s120384

Meet- ing	TSG doc	CR	Rev	Subject	Cat	Old vers	New vers	WG doc
RP-57	RP-121105	2984	-	Addition of CS Voice over HSPA test case 8.3.1.48 to HSPA8 ATS	F	10.0.0	10.1.0	R5s120444
RP-57	RP-121105	2985	-	Correction to UTRA test case 8.1.5.7	F	10.0.0	10.1.0	R5s120460
RP-57	RP-121105	2986	-	Correction to Ecall testcases.	F	10.0.0	10.1.0	R5s120577
RP-57	RP-121105	2987	-	Correction to Rel-7/Rel-8 testcases based on 12wk23 ATS	F	10.0.0	10.1.0	R5s120578
RP-57	RP-121105	2988	-	Addition of GCF WI-130 Improved L2 UL MAC test case 7.1.7.3 to HSPA8_ENH ATS	F	10.0.0	10.1.0	R5s120598
RP-57	RP-121105	2990	-	Correction to HSUPA UTRA test case 14.7.8	F	10.0.0	10.1.0	R5s120603
RP-57	RP-121104	2989	-	CR to 34.123-3: Add new verified and e-mail agreed TTCN test cases in the TC lists in 34.123-3 (prose), Annex A	F	10.0.0	10.1.0	-

History

Document history		
V10.0.0	August 2012	Publication
V10.1.0	October 2012	Publication