

# ETSI TS 136 101 V8.6.0 (2009-07)

---

*Technical Specification*

**LTE;  
Evolved Universal Terrestrial Radio Access (E-UTRA);  
User Equipment (UE) radio transmission and reception  
(3GPP TS 36.101 version 8.6.0 Release 8)**

---



---

**Reference**RTS/TSGR-0436101v860

---

---

**Keywords**LTE

---

**ETSI**

650 Route des Lucioles  
F-06921 Sophia Antipolis Cedex - FRANCE

---

Tel.: +33 4 92 94 42 00 Fax: +33 4 93 65 47 16

Siret N° 348 623 562 00017 - NAF 742 C  
Association à but non lucratif enregistrée à la  
Sous-Préfecture de Grasse (06) N° 7803/88

---

**Important notice**

---

Individual copies of the present document can be downloaded from:

<http://www.etsi.org>

The present document may be made available in more than one electronic version or in print. In any case of existing or perceived difference in contents between such versions, the reference version is the Portable Document Format (PDF). In case of dispute, the reference shall be the printing on ETSI printers of the PDF version kept on a specific network drive within ETSI Secretariat.

Users of the present document should be aware that the document may be subject to revision or change of status. Information on the current status of this and other ETSI documents is available at

<http://portal.etsi.org/tb/status/status.asp>

If you find errors in the present document, please send your comment to one of the following services:

[http://portal.etsi.org/chaicor/ETSI\\_support.asp](http://portal.etsi.org/chaicor/ETSI_support.asp)

---

**Copyright Notification**

---

No part may be reproduced except as authorized by written permission.  
The copyright and the foregoing restriction extend to reproduction in all media.

© European Telecommunications Standards Institute 2009.  
All rights reserved.

**DECT™**, **PLUGTESTS™**, **UMTS™**, **TIPHON™**, the TIPHON logo and the ETSI logo are Trade Marks of ETSI registered for the benefit of its Members.

**3GPP™** is a Trade Mark of ETSI registered for the benefit of its Members and of the 3GPP Organizational Partners.

**LTE™** is a Trade Mark of ETSI currently being registered

for the benefit of its Members and of the 3GPP Organizational Partners.

**GSM®** and the GSM logo are Trade Marks registered and owned by the GSM Association.

---

## Intellectual Property Rights

IPRs essential or potentially essential to the present document may have been declared to ETSI. The information pertaining to these essential IPRs, if any, is publicly available for **ETSI members and non-members**, and can be found in ETSI SR 000 314: "*Intellectual Property Rights (IPRs); Essential, or potentially Essential, IPRs notified to ETSI in respect of ETSI standards*", which is available from the ETSI Secretariat. Latest updates are available on the ETSI Web server (<http://webapp.etsi.org/IPR/home.asp>).

Pursuant to the ETSI IPR Policy, no investigation, including IPR searches, has been carried out by ETSI. No guarantee can be given as to the existence of other IPRs not referenced in ETSI SR 000 314 (or the updates on the ETSI Web server) which are, or may be, or may become, essential to the present document.

---

## Foreword

This Technical Specification (TS) has been produced by ETSI 3rd Generation Partnership Project (3GPP).

The present document may refer to technical specifications or reports using their 3GPP identities, UMTS identities or GSM identities. These should be interpreted as being references to the corresponding ETSI deliverables.

The cross reference between GSM, UMTS, 3GPP and ETSI identities can be found under <http://webapp.etsi.org/key/queryform.asp>.

# Contents

Intellectual Property Rights .....	2
Foreword.....	2
Foreword.....	9
1 Scope .....	10
2 References .....	10
3 Definitions, symbols and abbreviations .....	10
3.1 Definitions .....	10
3.2 Symbols.....	11
3.3 Abbreviations .....	12
4 General .....	13
4.1 Relationship between minimum requirements and test requirements .....	13
4.2 Applicability of minimum requirements .....	13
5 Operating bands and channel arrangement.....	13
5.1 General .....	13
5.2 Void.....	13
5.3 Void.....	13
5.4 Void.....	13
5.5 Operating bands.....	13
5.6 Channel bandwidth .....	14
5.6.1 Channel bandwidths per operating band .....	15
5.7 Channel arrangement.....	16
5.7.1 Channel spacing.....	16
5.7.2 Channel raster .....	16
5.7.3 Carrier frequency and EARFCN.....	17
5.7.4 TX–RX frequency separation.....	18
6 Transmitter characteristics .....	19
6.1 General .....	19
6.2 Transmit power .....	19
6.2.1 Void .....	19
6.2.2 UE Maximum Output Power .....	19
6.2.3 UE Maximum Output power for modulation / channel bandwidth.....	20
6.2.4 UE Maximum Output Power with additional requirements.....	20
6.2.5 Configured transmitted Power .....	21
6.3 Output power dynamics.....	21
6.3.1 (Void).....	21
6.3.2 Minimum output power .....	22
6.3.2.1 Minimum requirement .....	22
6.3.3 Transmit OFF power.....	22
6.3.3.1 Minimum requirement .....	22
6.3.4 ON/OFF time mask .....	22
6.3.4.1 General ON/OFF time mask.....	22
6.3.4.2 PRACH and SRS time mask .....	23
6.3.4.3 Slot / Sub frame boundary time mask .....	24
6.3.4.4 PUCCH / PUSCH / SRS time mask.....	24
6.3.5 Power Control.....	25
6.3.5.1 Absolute Power Tolerance .....	25
6.3.5.2 Relative Power tolerance.....	26
6.3.5.3 Aggregate power control tolerance .....	26
6.3.5.3.1 Minimum requirement.....	27
6.4 Void.....	27
6.5 Transmit signal quality .....	27
6.5.1 Frequency error.....	27

6.5.2	Transmit modulation.....	27
6.5.2.1	Error Vector Magnitude .....	27
6.5.2.1.1	Minimum requirement.....	28
6.5.2.2	IQ-component .....	28
6.5.2.2.1	Minimum requirements .....	28
6.5.2.3	In-band emissions .....	28
6.5.2.3.1	Minimum requirements .....	28
6.5.2.4	Spectrum flatness .....	29
6.5.2.4.1	Minimum requirements .....	29
6.6	Output RF spectrum emissions.....	30
6.6.1	Occupied bandwidth .....	31
6.6.2	Out of band emission .....	31
6.6.2.1	Spectrum emission mask.....	31
6.6.2.1.1	Minimum requirement.....	31
6.6.2.2	Additional Spectrum Emission Mask.....	31
6.6.2.2.1	Minimum requirement (network signalled value "NS_03").....	32
6.6.2.2.2	Minimum requirement (network signalled value "NS_04").....	32
6.6.2.2.3	Minimum requirement (network signalled value "NS_06" or 'NS_07') .....	33
6.6.2.3	Adjacent Channel Leakage Ratio .....	33
6.6.2.3.1	Minimum requirement E-UTRA .....	33
6.6.2.3.2	Minimum requirements UTRA .....	34
6.6.2.4	Additional ACLR requirements .....	34
6.6.2.4.1	Void.....	35
6.6.3	Spurious emissions .....	35
6.6.3.1	Minimum requirements .....	35
6.6.3.2	Spurious emission band UE co-existence .....	35
6.6.3.3	Additional spurious emissions .....	37
6.6.3.3.1	Minimum requirement (network signalled value "NS_05").....	37
6.6.3.3.2	Minimum requirement (network signalled value 'NS_07').....	38
6.7	Transmit intermodulation .....	38
6.7.1	Minimum requirement .....	38
7	Receiver characteristics.....	39
7.1	General .....	39
7.2	Diversity characteristics .....	39
7.3	Reference sensitivity power level.....	39
7.3.1	Minimum requirements (QPSK).....	39
7.3.2	Requirement for large transmission configurations .....	41
7.4	Maximum input level .....	42
7.4.1	Minimum requirements.....	42
7.5	Adjacent Channel Selectivity (ACS).....	42
7.5.1	Minimum requirements.....	42
7.6	Blocking characteristics .....	43
7.6.1	In-band blocking.....	44
7.6.1.1	Minimum requirements.....	44
7.6.2	Out-of-band blocking.....	45
7.6.2.1	Minimum requirements.....	45
7.6.3	Narrow band blocking .....	45
7.6.3.1	Minimum requirements .....	46
7.7	Spurious response.....	46
7.7.1	Minimum requirements.....	46
7.8	Intermodulation characteristics .....	47
7.8.1	Wide band intermodulation.....	47
7.8.1.1	Minimum requirements.....	47
7.8.2	Void .....	47
7.9	Spurious emissions .....	47
7.9.1	Minimum requirements.....	48
8.1	General .....	49
8.1.1	Dual-antenna receiver capability .....	49
8.1.1.1	Simultaneous unicast and MBMS operations.....	49
8.1.1.2	Dual-antenna receiver capability in idle mode.....	49
8.2	Demodulation of PDSCH (Cell-Specific Reference Symbols) .....	49

8.2.1	FDD (Fixed Reference Channel) .....	49
8.2.1.1	Single-antenna port performance .....	49
8.2.1.1.1	Minimum Requirement QPSK .....	50
8.2.1.1.2	Minimum Requirement 16QAM .....	50
8.2.1.1.3	Minimum Requirement 64QAM .....	51
8.2.1.1.4	Minimum Requirement 1 PRB allocation .....	52
8.2.1.2	Transmit diversity performance .....	53
8.2.1.3	Open-loop spatial multiplexing performance .....	54
8.2.1.4	Closed-loop spatial multiplexing performance .....	55
8.2.1.4.1	Minimum Requirement Single-Layer Spatial Multiplexing .....	55
8.2.1.4.2	Minimum Requirement Multi-Layer Spatial Multiplexing .....	56
8.2.1.5	MU-MIMO .....	57
8.2.1.6	[Control channel performance: D-BCH and PCH] .....	57
8.2.2	TDD (Fixed Reference Channel) .....	57
8.2.2.1	Single-antenna port performance .....	58
8.2.2.1.1	Minimum Requirement QPSK .....	58
8.2.2.1.2	Minimum Requirement 16QAM .....	59
8.2.2.1.3	Minimum Requirement 64QAM .....	60
8.2.2.1.4	Minimum Requirement 1 PRB allocation .....	61
8.2.2.2	Transmit diversity performance .....	63
8.2.2.3	Open-loop spatial multiplexing performance .....	63
8.2.2.4	Closed-loop spatial multiplexing performance .....	64
8.2.2.4.1	Minimum Requirement Single-Layer Spatial Multiplexing .....	64
8.2.2.4.2	Minimum Requirement Multi-Layer Spatial Multiplexing .....	65
8.2.2.5	MU-MIMO .....	66
8.2.2.6	[Control channel performance: D-BCH and PCH] .....	66
8.3	Demodulation of PDSCH (User-Specific Reference Symbols) .....	66
8.3.1	FDD .....	66
8.3.2	TDD .....	66
8.4	Demodulation of PDCCH/PCFICH .....	68
8.4.1	FDD .....	68
8.4.1.1	Single-antenna port performance .....	68
8.4.1.2	Transmit diversity performance .....	68
8.4.2	TDD .....	69
8.4.2.1	Single-antenna port performance .....	69
8.4.2.2	Transmit diversity performance .....	70
8.5	Demodulation of PHICH .....	70
8.5.1	FDD .....	71
8.5.1.1	Single-antenna port performance .....	71
8.5.1.2	Transmit diversity performance .....	71
8.5.2	TDD .....	72
8.5.2.1	Single-antenna port performance .....	72
8.5.2.2	Transmit diversity performance .....	73
8.6	Demodulation of PBCH .....	73
8.6.1	FDD .....	73
8.6.1.1	Single-antenna port performance .....	74
8.6.1.2	Transmit diversity performance .....	74
8.6.2	TDD .....	74
8.6.2.1	Single-antenna port performance .....	75
8.6.2.2	Transmit diversity performance .....	75
9	Reporting of Channel State Information .....	75
9.1	General .....	75
9.2	CQI reporting definition under AWGN conditions .....	75
9.2.1	Minimum requirement PUCCH 1-0 .....	76
9.2.1.1	FDD .....	76
9.2.1.2	TDD .....	76
9.2.2	Minimum requirement PUCCH 1-1 .....	77
9.2.2.1	FDD .....	77
9.2.2.2	TDD .....	78
9.3	CQI reporting under fading conditions .....	79
9.3.1	Frequency-selective scheduling mode .....	79

9.3.1.1	Minimum requirement PUSCH 3-0 .....	79
9.3.1.1.1	FDD .....	79
9.3.1.1.2	TDD .....	80
9.3.2	Frequency non-selective scheduling mode .....	81
9.3.2.1	Minimum requirement PUCCH 1-0 .....	81
9.3.2.1.1	FDD .....	81
9.3.2.1.2	TDD .....	82
9.4	Reporting of Precoding Matrix Indicator (PMI) .....	83
9.4.1	Single PMI .....	83
9.4.1.1	Minimum requirement PUSCH 3-1 .....	83
9.4.1.1.1	FDD .....	83
9.4.1.1.2	TDD .....	84
9.4.2	Multiple PMI .....	85
9.4.2.1	Minimum requirement PUSCH 1-2 .....	85
9.4.2.1.1	FDD .....	85
9.4.2.1.2	TDD .....	86
	.....	87
<b>Annex A (normative): Measurement channels .....</b>		<b>88</b>
A.1	General .....	88
A.2	UL reference measurement channels .....	88
A.2.1	General .....	88
A.2.1.1	Applicability and common parameters .....	88
A.2.1.2	Determination of payload size .....	88
A.2.2	Reference measurement channels for FDD .....	89
A.2.2.1	Full RB allocation .....	89
A.2.2.1.1	QPSK .....	89
A.2.2.1.2	16-QAM .....	90
A.2.2.1.3	64-QAM .....	90
A.2.2.2	Partial RB allocation .....	90
A.2.2.2.1	QPSK .....	90
A.2.2.2.2	16-QAM .....	92
A.2.2.2.3	64-QAM .....	94
A.2.3	Reference measurement channels for TDD .....	94
A.2.3.1	Full RB allocation .....	95
A.2.3.1.1	QPSK .....	95
A.2.3.1.2	16-QAM .....	95
A.2.3.1.3	64-QAM .....	95
A.2.3.2	Partial RB allocation .....	96
A.2.3.2.1	QPSK .....	96
A.2.3.2.2	16-QAM .....	99
A.2.3.2.3	64-QAM .....	101
A.3	DL reference measurement channels .....	102
A.3.1	General .....	102
A.3.2	Reference measurement channel for receiver characteristics .....	102
A.3.3	Reference measurement channels for PDSCH performance requirements (FDD) .....	109
A.3.3.1	Single-antenna transmission (Common Reference Symbols) .....	109
A.3.3.2	Multi-antenna transmission (Common Reference Symbols) .....	112
A.3.3.2.1	Two antenna ports .....	112
A.3.3.2.2	Four antenna ports .....	113
A.3.3.3	[RMC for UE-Specific Reference Symbols] .....	114
A.3.4	Reference measurement channels for PDSCH performance requirements (TDD) .....	114
A.3.4.1	Single-antenna transmission (Common Reference Symbols) .....	114
A.3.4.2	Multi-antenna transmission (Common Reference Signals) .....	118
A.3.4.2.1	Two antenna ports .....	118
A.3.4.2.2	Four antenna ports .....	119
A.3.4.3	[RMC for UE-Specific Reference Symbols] .....	120
A.3.5	Reference measurement channels for PDCCH/PCFICH performance requirements .....	121
A.3.5.1	FDD .....	121
A.3.5.2	TDD .....	121

A.4	CQI reference measurement channels .....	121
A.5	OFDMA Channel Noise Generator (OCNG) .....	123
A.5.1	OCNG Patterns for FDD .....	123
A.5.1.1	OCNG FDD pattern 1: 14 RB OCNG allocation in 3 MHz.....	123
A.5.1.2	OCNG FDD pattern 2: 49 RB OCNG allocation in 10 MHz.....	124
A.5.1.3	OCNG FDD pattern 3: 99 RB OCNG allocation in 20 MHz.....	124
A.5.1.4	OCNG FDD pattern 4: 49 RB OCNG allocation with MBSFN in 10 MHz .....	125
A.5.1.5	OCNG FDD patterns 5-9 for Maximum input level .....	125
A.5.2	OCNG Patterns for TDD.....	127
A.5.2.1	OCNG TDD pattern 1: 14 RB OCNG allocation in 3 MHz .....	127
A.5.2.2	OCNG TDD pattern 2: 49 RB OCNG allocation in 10 MHz .....	128
A.5.2.3	OCNG TDD pattern 3: 99 RB OCNG allocation in 20 MHz .....	129
A.5.2.4	OCNG TDD pattern 4: 49 RB OCNG allocation with MBSFN in 10 MHz .....	130
A.5.2.5	OCNG TDD patterns 5-9 for Maximum input level.....	131
<b>Annex B (normative): Propagation conditions.....</b>		<b>133</b>
B.1	Static propagation condition.....	133
B.2	Multi-path fading propagation conditions .....	133
B.2.1	Delay profiles .....	133
B.2.2	Combinations of channel model parameters .....	134
B.2.3	MIMO Channel Correlation Matrices .....	135
B.2.3.1	Definition of MIMO Correlation Matrices .....	135
B.2.3.2	MIMO Correlation Matrices at High, Medium and Low Level .....	136
B.2.4	Propagation conditions for CQI tests.....	139
B.3	High speed train scenario .....	139
<b>Annex C (normative): Downlink Physical Channels.....</b>		<b>141</b>
C.1	General .....	141
C.2	Set-up .....	141
C.3	Connection .....	141
C.3.1	Measurement of Receiver Characteristics .....	141
C.3.2	Measurement of Performance requirements.....	142
<b>Annex D (normative): Characteristics of the interfering signal .....</b>		<b>143</b>
D.1	General .....	143
D.2	Interference signals.....	143
<b>Annex E (normative): Environmental conditions .....</b>		<b>144</b>
E.1	General .....	144
E.2	Environmental .....	144
E.2.1	Temperature .....	144
E.2.2	Voltage .....	144
E.2.3	Vibration.....	145
<b>Annex F (normative): Transmit modulation.....</b>		<b>146</b>
F.1	Measurement Point.....	146
F.2	Basic Error Vector Magnitude measurement .....	146
F.3	Basic in-band emissions measurement.....	147
F.4	Modified signal under test.....	147
F.5	Window length .....	149
F.5.1	Timing offset.....	149
F.5.2	Window length .....	149



F.5.3	Window length for normal CP .....	149
F.5.4	Window length for Extended CP.....	150
F.5.4	Window length for PRACH .....	151
F.6	Averaged EVM .....	152
F.7	Spectrum Flatness .....	153
<b>Annex G (informative):</b>	<b>Change history .....</b>	<b>154</b>
History .....		158

---

# Foreword

This Technical Specification (TS) has been produced by the 3<sup>rd</sup> Generation Partnership Project (3GPP).

The contents of the present document are subject to continuing work within the TSG and may change following formal TSG approval. Should the TSG modify the contents of the present document, it will be re-released by the TSG with an identifying change of release date and an increase in version number as follows:

Version x.y.z

Where:

- x the first digit:
  - 1 presented to TSG for information;
  - 2 presented to TSG for approval;
  - 3 or greater indicates TSG approved document under change control.
- y the second digit is incremented for all changes of substance, i.e. technical enhancements, corrections, updates, etc.
- z the third digit is incremented when editorial only changes have been incorporated in the document.

---

# 1 Scope

. The present document establishes the minimum RF characteristics and minimum performance requirements for E-UTRA User Equipment (UE).

---

## 2 References

The following documents contain provisions which, through reference in this text, constitute provisions of the present document.

- References are either specific (identified by date of publication, edition number, version number, etc.) or non-specific.
- For a specific reference, subsequent revisions do not apply.
- For a non-specific reference, the latest version applies. In the case of a reference to a 3GPP document (including a GSM document), a non-specific reference implicitly refers to the latest version of that document *in the same Release as the present document*.

- [1] 3GPP TR 21.905: "Vocabulary for 3GPP Specifications".
- [2] ITU-R Recommendation SM.329-10, "Unwanted emissions in the spurious domain"
- [3] ITU-R Recommendation M.1545: "Measurement uncertainty as it applies to test limits for the terrestrial component of International Mobile Telecommunications-2000".
- [4] 3GPP TS 36.211: "Physical Channels and Modulation".
- [5] 3GPP TS 36.212: "Multiplexing and channel coding".
- [6] 3GPP TS 36.213: "Physical layer procedures".

---

## 3 Definitions, symbols and abbreviations

### 3.1 Definitions

For the purposes of the present document, the terms and definitions given in TR 21.905 [1] and the following apply. A term defined in the present document takes precedence over the definition of the same term, if any, in TR 21.905 [1].

**Channel edge:** The lowest and highest frequency of the carrier, separated by the channel bandwidth.

**Channel bandwidth:** The RF bandwidth supporting a single E-UTRA RF carrier with the transmission bandwidth configured in the uplink or downlink of a cell. The channel bandwidth is measured in MHz and is used as a reference for transmitter and receiver RF requirements.

**Maximum Output Power:** The mean power level per carrier of UE measured at the antenna connector in a specified reference condition.

**Mean power:** When applied to E-UTRA transmission this is the power measured in the operating system bandwidth of the carrier. The period of measurement shall be at least one subframe (1ms) unless otherwise stated.

**Occupied bandwidth:** The width of a frequency band such that, below the lower and above the upper frequency limits, the mean powers emitted are each equal to a specified percentage  $\beta/2$  of the total mean power of a given emission.

**Output power:** The mean power of one carrier of the UE, delivered to a load with resistance equal to the nominal load impedance of the transmitter.

**Reference bandwidth:** The bandwidth in which an emission level is specified.

**Transmission bandwidth:** Bandwidth of an instantaneous transmission from a UE or BS, measured in Resource Block units.

**Transmission bandwidth configuration:** The highest transmission bandwidth allowed for uplink or downlink in a given channel bandwidth, measured in Resource Block units.

## 3.2 Symbols

For the purposes of the present document, the following symbols apply:

$BW_{\text{Channel}}$	Channel bandwidth
$E_{RS}$	Transmitted energy per RE for reference symbols during the useful part of the symbol, i.e. excluding the cyclic prefix, (average power normalized to the subcarrier spacing) at the eNode B transmit antenna connector
$\hat{E}_s$	The received energy per RE during the useful part of the symbol, i.e. excluding the cyclic prefix, averaged across the allocated RB(s) (average power within the allocated RB(s), divided by the number of RE within this allocation, and normalized to the subcarrier spacing) at the UE antenna connector
F	Frequency
$F_{\text{Interferer (offset)}}$	Frequency offset of the interferer
$F_{\text{Interferer}}$	Frequency of the interferer
$F_C$	Frequency of the carrier centre frequency
$F_{\text{DL\_low}}$	The lowest frequency of the downlink operating band
$F_{\text{DL\_high}}$	The highest frequency of the downlink operating band
$F_{\text{UL\_low}}$	The lowest frequency of the uplink operating band
$F_{\text{UL\_high}}$	The highest frequency of the uplink operating band

**Editor's note : one of the two following definitions for  $I_o$  will be used (TBD)**

$I_o$	The power spectral density of the total input signal (power averaged over the useful part of the symbols within the transmission bandwidth configuration, divided by the total number of RE for this configuration and normalised to the subcarrier spacing) at the UE antenna connector, including the own-cell downlink signal
$I_o$	The power spectral density of the total input signal at the UE antenna connector (power averaged over the useful part of the symbols within a given bandwidth and normalised to the said bandwidth), including the own-cell downlink signal
$I_{or}$	The total transmitted power spectral density of the own-cell downlink signal (power averaged over the useful part of the symbols within the transmission bandwidth configuration, divided by the total number of RE for this configuration and normalised to the subcarrier spacing) at the eNode B transmit antenna connector
$\hat{I}_{or}$	The total received power spectral density of the own-cell downlink signal (power averaged over the useful part of the symbols within the transmission bandwidth configuration, divided by the total number of RE for this configuration and normalised to the subcarrier spacing) at the UE antenna connector
$I_{ot}$	The received power spectral density of the total noise and interference for a certain RE (average power obtained within the RE and normalized to the subcarrier spacing) as measured at the UE antenna connector
$N_{cp}$	Cyclic prefix length
$N_{DL}$	Downlink EARFCN
$N_{oc}$	The power spectral density of a white noise source (average power per RE normalised to the subcarrier spacing), simulating interference from cells that are not defined in a test procedure, as measured at the UE antenna connector
$N_{\text{Offs-UL}}$	Offset used for calculating uplink EARFCN
$N_{\text{Offs-DL}}$	Offset used for calculating downlink EARFCN

$N_{otx}$	The power spectral density of a white noise source (average power per RE normalised to the subcarrier spacing) simulating eNode B transmitter impairments as measured at the eNode B transmit antenna connector
$N_{RB}$	Transmission bandwidth configuration, expressed in units of resource blocks
$N_{UL}$	Uplink EARFCN
$R_{av}$	Minimum average throughput per RB
$P_{Interferer}$	Modulated mean power of the interferer
$\Delta F_{OOB}$	$\Delta$ Frequency of Out Of Band emission

### 3.3 Abbreviations

For the purposes of the present document, the abbreviations given in TR 21.905 [1] and the following apply. An abbreviation defined in the present document takes precedence over the definition of the same abbreviation, if any, in TR 21.905 [1].

ACLR	Adjacent Channel Leakage Ratio
ACS	Adjacent Channel Selectivity
A-MPR	Additional Maximum Power Reduction
AWGN	Additive White Gaussian Noise
BS	Base Station
CW	Continuous Wave
DL	Downlink
EARFCN	E-UTRA Absolute Radio Frequency Channel Number
EPRE	Energy Per Resource Element
E-UTRA	Evolved UMTS Terrestrial Radio Access
EUTRAN	Evolved UMTS Terrestrial Radio Access Network
EVM	Error Vector Magnitude
FDD	Frequency Division Duplex
FRC	Fixed Reference Channel
HD-FDD	Half- Duplex FDD
MCS	Modulation and Coding Scheme
MOP	Maximum Output Power
MPR	Maximum Power Reduction
MSR	Maximum Sensitivity Reduction
OCNG	OFDMA Channel Noise Generator
OFDMA	Orthogonal Frequency Division Multiple Access
OOB	Out-of-band
PA	Power Amplifier
PSS	Primary Synchronization Signal
PSS_RA	PSS-to-RS EPRE ratio for the channel PSS
RE	Resource Element
REFSENS	Reference Sensitivity power level
r.m.s	Root Mean Square
SNR	Signal-to-Noise Ratio
SSS	Secondary Synchronization Signal
SSS_RA	SSS-to-RS EPRE ratio for the channel SSS
TDD	Time Division Duplex
UE	User Equipment
UL	Uplink
UMTS	Universal Mobile Telecommunications System
UTRA	UMTS Terrestrial Radio Access
UTRAN	UMTS Terrestrial Radio Access Network
xCH_RA	xCH-to-RS EPRE ratio for the channel xCH in all transmitted OFDM symbols not containing RS
xCH_RB	xCH-to-RS EPRE ratio for the channel xCH in all transmitted OFDM symbols containing RS

---

## 4 General

### 4.1 Relationship between minimum requirements and test requirements

The Minimum Requirements given in this specification make no allowance for measurement uncertainty. The test specification TS 36.xxx section y defines Test Tolerances. These Test Tolerances are individually calculated for each test. The Test Tolerances are used to relax the Minimum Requirements in this specification to create Test Requirements.

The measurement results returned by the Test System are compared - without any modification - against the Test Requirements as defined by the shared risk principle.

The Shared Risk principle is defined in ITU-R M.1545 [3].

### 4.2 Applicability of minimum requirements

In this specification the Minimum Requirements are specified as general requirements and additional requirements. Where the Requirement is specified as a general requirement, the requirement is mandated to be met in all scenarios

For specific scenarios for which an additional requirement is specified, in addition to meeting the general requirement, the UE is mandated to meet the additional requirements.

---

## 5 Operating bands and channel arrangement

### 5.1 General

The channel arrangements presented in this clause are based on the operating bands and channel bandwidths defined in the present release of specifications.

NOTE: Other operating bands and channel bandwidths may be considered in future releases.

### 5.2 Void

### 5.3 Void

### 5.4 Void

### 5.5 Operating bands

E-UTRA is designed to operate in the operating bands defined in Table 5.5-1.

**Table 5.5-1 E-UTRA operating bands**

E-UTRA Operating Band	Uplink (UL) operating band BS receive UE transmit	Downlink (DL) operating band BS transmit UE receive	Duplex Mode
	$F_{UL\_low}$ – $F_{UL\_high}$	$F_{DL\_low}$ – $F_{DL\_high}$	
1	1920 MHz – 1980 MHz	2110 MHz – 2170 MHz	FDD
2	1850 MHz – 1910 MHz	1930 MHz – 1990 MHz	FDD
3	1710 MHz – 1785 MHz	1805 MHz – 1880 MHz	FDD
4	1710 MHz – 1755 MHz	2110 MHz – 2155 MHz	FDD
5	824 MHz – 849 MHz	869 MHz – 894MHz	FDD
6	830 MHz – 840 MHz	875 MHz – 885 MHz	FDD
7	2500 MHz – 2570 MHz	2620 MHz – 2690 MHz	FDD
8	880 MHz – 915 MHz	925 MHz – 960 MHz	FDD
9	1749.9 MHz – 1784.9 MHz	1844.9 MHz – 1879.9 MHz	FDD
10	1710 MHz – 1770 MHz	2110 MHz – 2170 MHz	FDD
11	1427.9 MHz – 1452.9 MHz	1475.9 MHz – 1500.9 MHz	FDD
12	698 MHz – 716 MHz	728 MHz – 746 MHz	FDD
13	777 MHz – 787 MHz	746 MHz – 756 MHz	FDD
14	788 MHz – 798 MHz	758 MHz – 768 MHz	FDD
17	704 MHz – 716 MHz	734 MHz – 746 MHz	FDD
...			
33	1900 MHz – 1920 MHz	1900 MHz – 1920 MHz	TDD
34	2010 MHz – 2025 MHz	2010 MHz – 2025 MHz	TDD
35	1850 MHz – 1910 MHz	1850 MHz – 1910 MHz	TDD
36	1930 MHz – 1990 MHz	1930 MHz – 1990 MHz	TDD
37	1910 MHz – 1930 MHz	1910 MHz – 1930 MHz	TDD
38	2570 MHz – 2620 MHz	2570 MHz – 2620 MHz	TDD
39	1880 MHz – 1920 MHz	1880 MHz – 1920 MHz	TDD
40	2300 MHz – 2400 MHz	2300 MHz – 2400 MHz	TDD

## 5.6 Channel bandwidth

Requirements in present document are specified for the channel bandwidths listed in Table 5.6-1.

**Table 5.6-1 Transmission bandwidth configuration  $N_{RB}$  in E-UTRA channel bandwidths**

Channel bandwidth $BW_{Channel}$ [MHz]	1.4	3	5	10	15	20
Transmission bandwidth configuration $N_{RB}$	6	15	25	50	75	100

Figure 5.6-1 shows the relation between the Channel bandwidth ( $BW_{Channel}$ ) and the Transmission bandwidth configuration ( $N_{RB}$ ). The channel edges are defined as the lowest and highest frequencies of the carrier separated by the channel bandwidth, i.e. at  $F_C \pm BW_{Channel}/2$ .

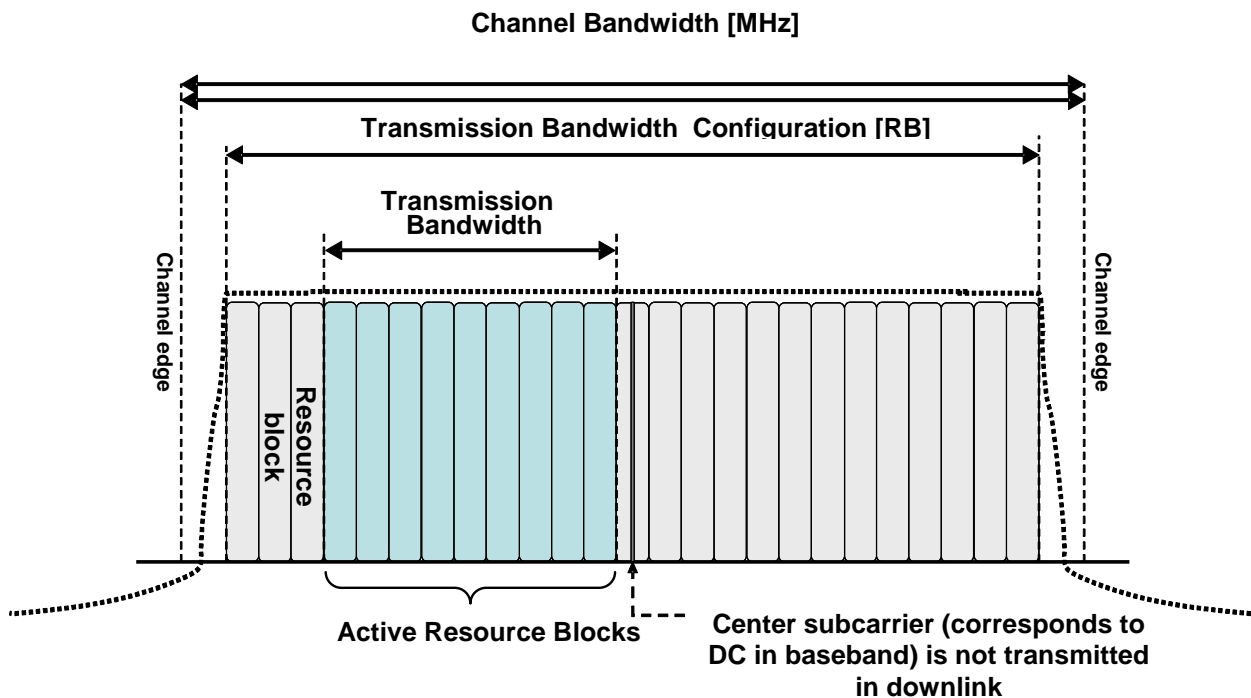

Figure 5.6-1 Definition of Channel Bandwidth and Transmission Bandwidth Configuration for one E-UTRA carrier

5.6.1 Channel bandwidths per operating band

- a) The requirements in this specification apply to the combination of channel bandwidths and operating bands shown in Table 5.6.1-1. The transmission bandwidth configuration in Table 5.6.1-1 shall be supported for each of the specified channel bandwidths. The same (symmetrical) channel bandwidth is specified for both the TX and RX path.



**Table 5.6.1-1: E-UTRA channel bandwidth**

E-UTRA band / channel bandwidth						
E-UTRA Band	1.4 MHz	3 MHz	5 MHz	10 MHz	15 MHz	20 MHz
1			Yes	Yes	Yes	Yes
2	Yes	Yes	Yes	Yes	Yes <sup>[1]</sup>	Yes <sup>[1]</sup>
3	Yes	Yes	Yes	Yes	Yes <sup>[1]</sup>	Yes <sup>[1]</sup>
4	Yes	Yes	Yes	Yes	Yes	Yes
5	Yes	Yes	Yes	Yes <sup>[1]</sup>		
6			Yes	Yes <sup>[1]</sup>		
7			Yes	Yes	Yes	Yes <sup>[1]</sup>
8	Yes	Yes	Yes	Yes <sup>[1]</sup>		
9			Yes	Yes	Yes <sup>[1]</sup>	Yes <sup>[1]</sup>
10			Yes	Yes	Yes	Yes
11			Yes	Yes <sup>[1]</sup>	Yes <sup>[1]</sup>	Yes <sup>[1]</sup>
12	Yes	Yes	Yes <sup>[1]</sup>	Yes <sup>[1]</sup>		
13			Yes <sup>[1]</sup>	Yes <sup>[1]</sup>		
14			Yes <sup>[1]</sup>	Yes <sup>[1]</sup>		
...						
17			Yes <sup>[1]</sup>	Yes <sup>[1]</sup>		
...						
33			Yes	Yes	Yes	Yes
34			Yes	Yes	Yes	
35	Yes	Yes	Yes	Yes	Yes	Yes
36	Yes	Yes	Yes	Yes	Yes	Yes
37			Yes	Yes	Yes	Yes
38			Yes	Yes	Yes	Yes
39			Yes	Yes	Yes	Yes
40				Yes	Yes	Yes

**NOTE 1: bandwidth for which a relaxation of the specified UE receiver sensitivity requirement (Clause 7.3) is allowed.**

- b) The use of different (asymmetrical) channel bandwidth for the TX and RX is not precluded and is intended to form part of a later release.

## 5.7 Channel arrangement

### 5.7.1 Channel spacing

The spacing between carriers will depend on the deployment scenario, the size of the frequency block available and the channel bandwidths. The nominal channel spacing between two adjacent E-UTRA carriers is defined as following:

$$\text{Nominal Channel spacing} = (\text{BW}_{\text{Channel}(1)} + \text{BW}_{\text{Channel}(2)})/2$$

where  $\text{BW}_{\text{Channel}(1)}$  and  $\text{BW}_{\text{Channel}(2)}$  are the channel bandwidths of the two respective E-UTRA carriers. The channel spacing can be adjusted to optimize performance in a particular deployment scenario.

### 5.7.2 Channel raster

The channel raster is 100 kHz for all bands, which means that the carrier centre frequency must be an integer multiple of 100 kHz.

### 5.7.3 Carrier frequency and EARFCN

The carrier frequency in the uplink and downlink is designated by the E-UTRA Absolute Radio Frequency Channel Number (EARFCN) in the range 0 - 65535. The relation between EARFCN and the carrier frequency in MHz for the downlink is given by the following equation, where  $F_{DL\_low}$  and  $N_{Offs-DL}$  are given in table 5.7.3-1 and  $N_{DL}$  is the downlink EARFCN.

$$F_{DL} = F_{DL\_low} + 0.1(N_{DL} - N_{Offs-DL})$$

The relation between EARFCN and the carrier frequency in MHz for the uplink is given by the following equation where  $F_{UL\_low}$  and  $N_{Offs-UL}$  are given in table 5.7.3-1 and  $N_{UL}$  is the uplink EARFCN.

$$F_{UL} = F_{UL\_low} + 0.1(N_{UL} - N_{Offs-UL})$$

**Table 5.7.3-1 E-UTRA channel numbers**

E-UTRA Operating Band	Downlink			Uplink		
	$F_{DL\_low}$ (MHz)	$N_{Offs-DL}$	Range of $N_{DL}$	$F_{UL\_low}$ (MHz)	$N_{Offs-UL}$	Range of $N_{UL}$
1	2110	0	0 – 599	1920	18000	18000 – 18599
2	1930	600	600 – 1199	1850	18600	18600 – 19199
3	1805	1200	1200 – 1949	1710	19200	19200 – 19949
4	2110	1950	1950 – 2399	1710	19950	19950 – 20399
5	869	2400	2400 – 2649	824	20400	20400 – 20649
6	875	2650	2650 – 2749	830	20650	20650 – 20749
7	2620	2750	2750 – 3449	2500	20750	20750 – 21449
8	925	3450	3450 – 3799	880	21450	21450 – 21799
9	1844.9	3800	3800 – 4149	1749.9	21800	21800 – 22149
10	2110	4150	4150 – 4749	1710	22150	22150 – 22749
11	1475.9	4750	4750 – 4999	1427.9	22750	22750 – 22999
12	728	5000	5000 - 5179	698	23000	23000 - 23179
13	746	5180	5180 – 5279	777	23180	23180 – 23279
14	758	5280	5280 – 5379	788	23280	23280 – 23379
...						
17	734	5730	5730 – 5849	704	23730	23730 - 23849
...						
33	1900	36000	36000 – 36199	1900	36000	36000 – 36199
34	2010	36200	36200 – 36349	2010	36200	36200 – 36349
35	1850	36350	36350 – 36949	1850	36350	36350 – 36949
36	1930	36950	36950 – 37549	1930	36950	36950 – 37549
37	1910	37550	37550 – 37749	1910	37550	37550 – 37749
38	2570	37750	37750 – 38249	2570	37750	37750 – 38249
39	1880	38250	38250-38649	1880	38250	38250-38649
40	2300	38650	38650-39649	2300	38650	38650-39649

NOTE: The channel numbers that designate carrier frequencies so close to the operating band edges that the carrier extends beyond the operating band edge shall not be used. This implies that the first 7, 15, 25, 50, 75 and 100 channel numbers at the lower operating band edge and the last 6, 14, 24, 49, 74 and 99 channel numbers at the upper operating band edge shall not be used for channel bandwidths of 1.4, 3, 5, 10, 15 and 20 MHz respectively.

## 5.7.4 TX–RX frequency separation

a) The default E-UTRA TX channel (carrier centre frequency) to RX channel (carrier centre frequency) separation is specified in Table 5.7.4-1 for the TX and RX channel bandwidths defined in Table 5.6.1-1

**Table 5.7.4-1: Default UE TX-RX frequency separation**

Frequency Band	TX - RX carrier centre frequency separation
1	190 MHz
2	80 MHz.
3	95 MHz.
4	400 MHz
5	45 MHz
6	45 MHz
7	120 MHz
8	45 MHz
9	95 MHz
10	400 MHz
11	48 MHz
12	30 MHz
13	-31 MHz
14	-30 MHz
17	30 MHz

b) The use of other TX channel to RX channel carrier centre frequency separation is not precluded and is intended to form part of a later release.

## 6 Transmitter characteristics

### 6.1 General

Unless otherwise stated, the transmitter characteristics are specified at the antenna connector of the UE with a single transmit antenna. For UE with integral antenna only, a reference antenna with a gain of 0 dBi is assumed.

### 6.2 Transmit power

#### 6.2.1 Void

#### 6.2.2 UE Maximum Output Power

The following UE Power Classes define the maximum output power. The power is the broadband transmit power of the UE, i.e. the power in the channel bandwidth (clause 5.6) of the radio access mode. The period of measurement shall be at least one sub frame (1ms).

**Table 6.2.2-1: UE Power Class**

EUTRA band	Class 1 (dBm)	Tolerance (dB)	Class 2 (dBm)	Tolerance (dB)	Class 3 (dBm)	Tolerance (dB)	Class 4 (dBm)	Tolerance (dB)
1					23	$\pm 2$		
2					23	$\pm 2^2$		
3					23	$\pm 2^2$		
4					23	$\pm 2$		
5					23	$\pm 2$		
6					23	$\pm 2$		
7					23	$\pm 2^2$		
8					23	$\pm 2^2$		
9					23	$\pm 2$		
10					23	$\pm 2$		
11					23	$\pm 2^2$		
12					23	$\pm 2^2$		
13					23	$\pm 2$		
14					23	$\pm 2$		
17					23	$\pm 2$		
...								
33					23	$\pm 2$		
34					23	$\pm 2$		
35					23	$\pm 2$		
36					23	$\pm 2$		
37					23	$\pm 2$		
38					23	$\pm 2$		
39					23	$\pm 2$		
40					23	$\pm 2$		
Note 1:	The above tolerances are applicable for UE(s) that support up to 4 E-UTRA operating bands. For UE(s) that support 5 or more E-UTRA bands the maximum output power is expected to decrease with each additional band and is FFS							
Note 2:	For transmission configurations (Figure 5.6-1) confined within FUL_low and FUL_low + 4 MHz or FUL_high – 4 MHz and FUL_high, the maximum output power requirement is relaxed by reducing the lower tolerance limit by 1.5 dB							

### 6.2.3 UE Maximum Output power for modulation / channel bandwidth

For UE Power Class 3, the allowed Maximum Power Reduction (MPR) for the maximum output power in Table 6.2.2-1 due to higher order modulation and transmit bandwidth configuration (resource blocks) is specified in Table 6.2.3-1.

**Table 6.2.3-1: Maximum Power Reduction (MPR) for Power Class 3**

Modulation	Channel bandwidth / Transmission bandwidth configuration (RB)						MPR (dB)
	.4 MHz	1.0 MHz	3.0 MHz	10 MHz	15 MHz	20 MHz	
QPSK	> 5	> 4	> 8	> 12	> 16	> 18	≤ 1
16 QAM	≤ 5	≤ 4	≤ 8	≤ 12	≤ 16	≤ 18	≤ 1
16 QAM	> 5	> 4	> 8	> 12	> 16	> 18	≤ 2

### 6.2.4 UE Maximum Output Power with additional requirements

Additional ACLR and spectrum emission requirements can be signalled by the network to indicate that the UE shall meet also additional requirements in a specific deployment scenario. To meet these additional requirements the concept of Additional Maximum Power Reduction A-MPR is introduced for the output power in Table 6.2.2-1. Unless stated otherwise, an A-MPR of 0 dB shall be used.

For UE Power Class 3 the specific requirements and identified sub-clauses are specified in Table 6.2.4-1 along with the allowed A-MPR values that may be used to meet these requirements. The allowed A-MPR values specified below in Table 6.2.4-1 and 6.2.4-2 are in addition to the allowed MPR requirements specified in clause 6.2.3.

**Table 6.2.4-1: Additional Maximum Power Reduction (A-MPR) / Spectrum Emission requirements**

Network Signalling value	Requirements (sub-clause)	E-UTRA Band	Channel bandwidth (MHz)	Resources Blocks	A-MPR (dB)
NS_01	NA	NA	NA	NA	NA
NS_03	6.6.2.2.1	2, 4,10, 35, 36	3	>5	≤ 1
	6.6.2.2.1	2, 4,10, 35,36	5	>6	≤ 1
	6.6.2.2.1	2, 4,10, 35,36	10	>6	≤ 1
	6.6.2.2.1	2, 4,10,35,36	15	>8	≤ 1
	6.6.2.2.1	2, 4,10,35, 36	20	>10	≤ 1
NS_04	6.6.2.2.2	TBD	TBD	TBD	
NS_05	6.6.3.3.1	1	10,15,20	≥ 50 for QPSK	≤ 1
NS_06	6.6.2.2.3	12, 13, 14, 17	1.4, 3, 5, 10	n/a	n/a
NS_07	6.6.2.2.3 6.6.3.3.2	13	10	Table 6.2.4-2	Table 6.2.4-2
..					
NS_32	-	-	-	-	-

**Table 6.2.4-2: A-MPR for 'NS07'**

	Region A		Region B		Region C
RB_start <sup>1</sup>	0 - 12		13 – 18	19 – 42	43 – 49
L_CRB <sup>2</sup> [RBs]	6-8	1 to 5 and 9-50	≥8	≥18	≤2
A-MPR [dB]	8	12	12	6	3
Note 1 RB_start indicates the lowest RB index of transmitted resource blocks 2 L_CRB is the length of a contiguous resource block allocation 3 For intra-subframe frequency hopping between two regions, notes 1 and 2 apply on a per slot basis. 4 For intra-subframe frequency hopping between two regions, the larger A-MPR value of the two regions may be applied for both slots in the subframe.					

## 6.2.5 Configured transmitted Power

$P_{\text{CMAX}}$  is the configured UE transmitted power defined as follows;

$$P_{\text{CMAX}} = \text{MIN} \{P_{\text{EMAX}}, P_{\text{UMAX}}\}$$

Where

- $P_{\text{EMAX}}$  is the maximum allowed power configured by higher layers and defined in [TS36.331]
- $P_{\text{UMAX}}$  is the maximum UE power for the UE power class specified in section 6.2.2 modified by section 6.2.3 and section 6.2.4. When a transmission configuration is confined within  $\text{FUL}_{\text{low}}$  and  $\text{FUL}_{\text{low}} + \Delta_{\text{TC}}$  or  $\text{FUL}_{\text{high}} - \Delta_{\text{TC}}$  and  $\text{FUL}_{\text{high}}$ , the configured transmitted power as specified in Table 6.2.5-1 is relaxed by reducing the lower limit by [1.5] dB.

The UE shall not exceed  $P_{\text{CMAX}}$  beyond the tolerances defined in sub-clause 6.2.5-1

**Table 6.2.5-1: PCMAX tolerance**

$P_{\text{CMAX}}$ (dBm)	Tolerance (dB)	
	(Normal)	(Extreme)
23	± 2.0	[± 2.0]
22	± 2.5	[TBD]
21	± 3.0	[TBD]
20	± 3.5	[TBD]
19	± 4.0	[TBD]
18	± 4.5	[TBD]
$13 \leq P_{\text{CMAX}} < 18$	± 5.0	[TBD]
$8 \leq P_{\text{CMAX}} < 13$	± 6.0	[TBD]
$-40 \leq P_{\text{CMAX}} < 8$	± 7.0	[TBD]

## 6.3 Output power dynamics

### 6.3.1 (Void)

## 6.3.2 Minimum output power

The minimum controlled output power of the UE is defined as the broadband transmit power of the UE, i.e. the power in the channel bandwidth for all transmit bandwidth configurations (resource blocks), when the power is set to a minimum value.

### 6.3.2.1 Minimum requirement

The minimum output power is defined as the mean power in one sub-frame (1ms). The minimum output power shall not exceed the values specified in Table 6.3.2.1-1.

**Table 6.3.2.1-1: Minimum output power**

	Channel bandwidth / Minimum output power / measurement bandwidth					
	1.4 MHz	3 MHz	5 MHz	10 MHz	15 MHz	20 MHz
Minimum output power	-40 dBm					
Measurement bandwidth	1.4 MHz	3 MHz	5 MHz	10 MHz	15 MHz	20 MHz

## 6.3.3 Transmit OFF power

Transmit OFF power is defined as the mean power when the transmitter is OFF. The transmitter is considered to be OFF when the UE is not allowed to transmit or during periods when the UE is not transmitting a sub-frame. During measurements gaps, the UE is not considered to be OFF.

### 6.3.3.1 Minimum requirement

The transmit OFF power is defined as the mean power in a duration of at least one sub-frame (1ms) excluding any transient periods. The transmit OFF power shall not exceed the values specified in Table 6.3.3.1-1.

**Table 6.3.3.1-1: Transmit OFF power**

	Channel bandwidth / Minimum output power / measurement bandwidth					
	1.4 MHz	3 MHz	5 MHz	10 MHz	15 MHz	20 MHz
Transmit OFF power	-50 dBm					
Measurement bandwidth	1.4 MHz	3 MHz	5 MHz	10 MHz	15 MHz	20 MHz

## 6.3.4 ON/OFF time mask

### 6.3.4.1 General ON/OFF time mask

The General ON/OFF time mask defines the observation period between Transmit OFF and ON power and between Transmit ON and OFF power. ON/OFF scenarios include; the beginning or end of DTX, measurement gap, contiguous, and non contiguous transmission

The OFF power measurement period is defined in a duration of at least one sub-frame excluding any transient periods. The ON power measurement period is defined as the mean power over one sub-frame excluding any transient period.

There are no additional requirements on UE transmit power beyond that which is required in clause 6.2.2 and clause 6.6.2.3

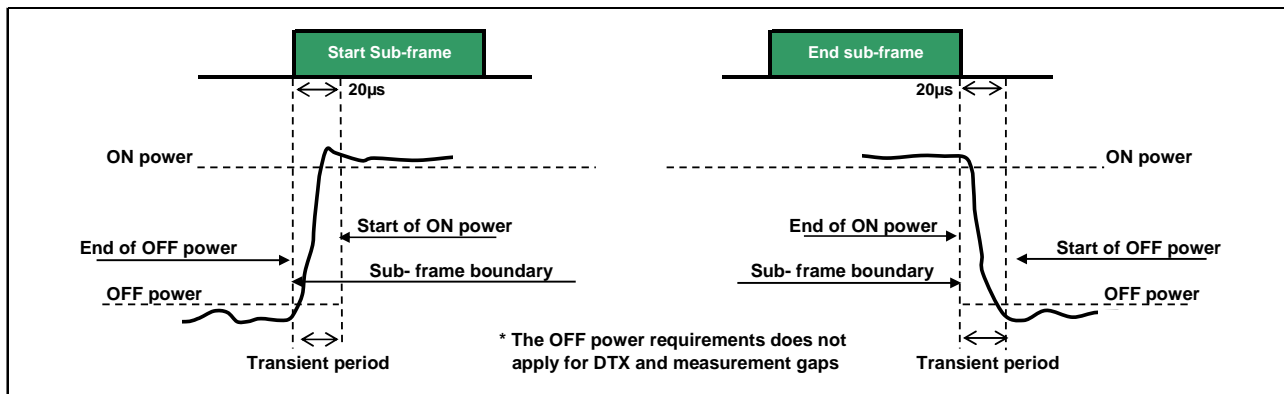

Figure 6.3.4.1-1: General ON/OFF time mask

6.3.4.2 PRACH and SRS time mask

In the case a single SRS transmission, the ON measurement period is defined as the mean power over the entire symbol duration excluding any transient period.

For the PRACH Power / Time mask defines the observation period for PRACH transmissions. The PRACH ON power is specified as the mean power over the PRACH measurement period excluding any transient periods. The measurement period for different PRACH preamble format is specified in Table 6.3.4.2-1.

There are no additional requirements on UE transmit power beyond that which is required in clause 6.2.2 and clause 6.6.2.3

Table 6.3.4.2-1: PRACH ON power measurement period

PRACH preamble format	Measurement period (ms)
0	0.9031
1	1.4844
2	1.8031
3	2.2844
4	0.1479

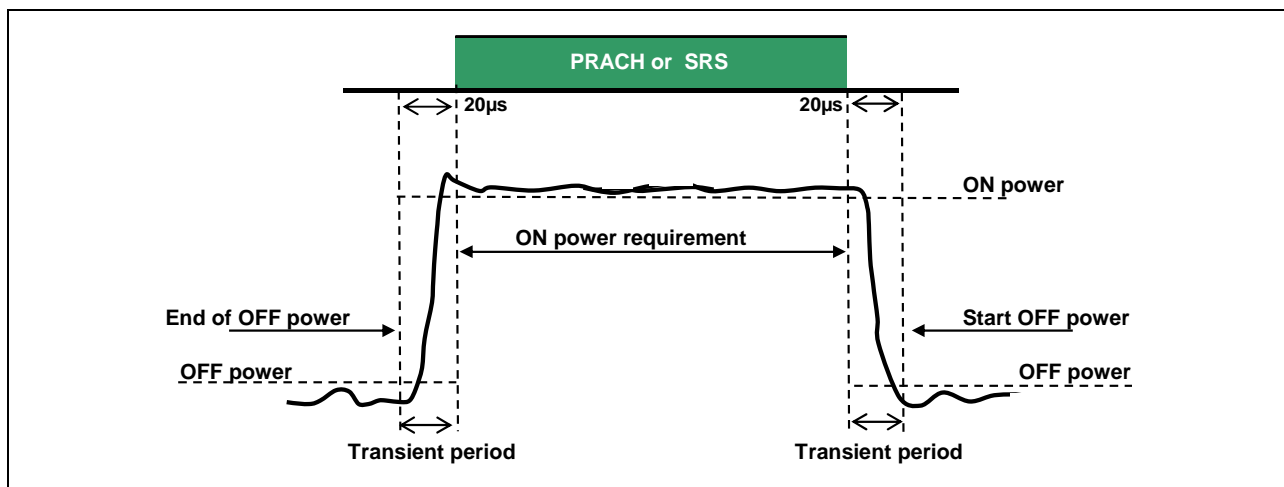

Figure 6.3.4.2-1: PRACH and SRS ON/OFF time mask



### 6.3.4.3 Slot / Sub frame boundary time mask

The sub frame boundary time mask defines the observation period between the previous/subsequent sub-frame and the (reference) sub-frame. A transient period at a slot boundary within a sub-frame is only allowed in the case of Intra-sub frame frequency hopping. For the cases when the subframe contains SRS the time masks in subclause 6.3.4.4 apply.

There are no additional requirements on UE transmit power beyond that which is required in clause 6.2.2 and clause 6.6.2.3

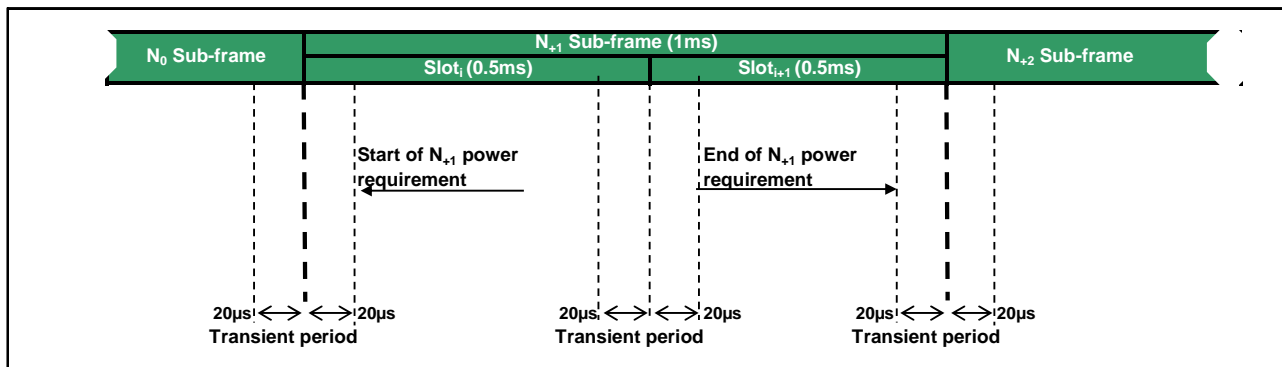

Figure 6.3.4.3-1: Transmission power template

### 6.3.4.4 PUCCH / PUSCH / SRS time mask

The PUCCH/PUSCH/SRS time mask defines the observation period between sounding reference symbol (SRS) and an adjacent PUSCH/PUCCH symbol and subsequent sub-frame.

There are no additional requirements on UE transmit power beyond that which is required in clause 6.2.2 and clause 6.6.2.3

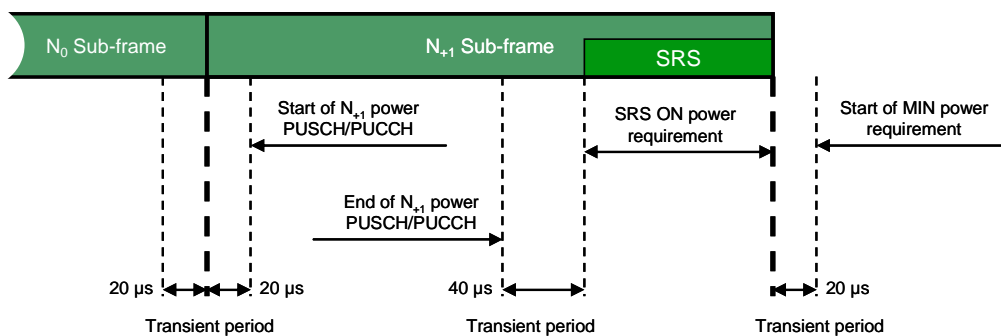

Figure 6.3.4.4-1: PUCCH / PUSCH/SRS time mask when there is no transmission after SRS

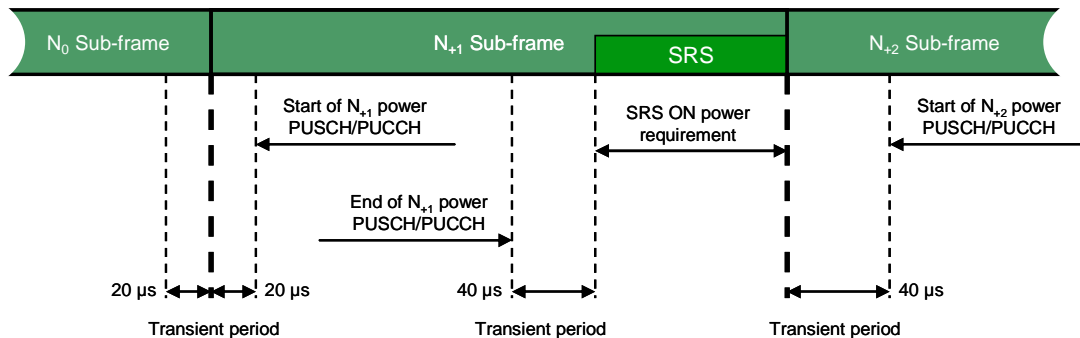

Figure 6.3.4.4-2: PUCCH/PUSCH/SRS time mask when there is a transmission after SRS

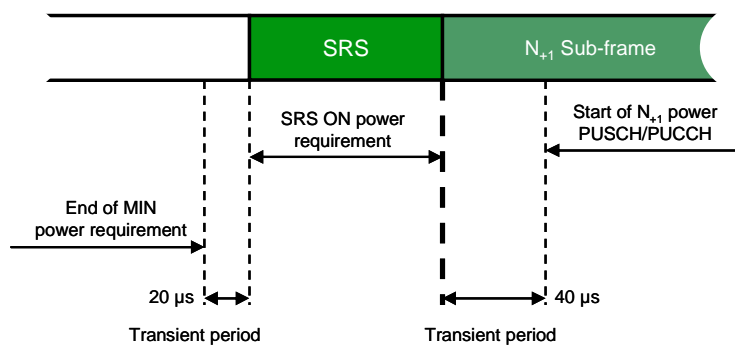

Figure 6.3.4.4-3 SRS time mask when there is a transmission after SRS

## 6.3.5 Power Control

### 6.3.5.1 Absolute Power Tolerance

Absolute power tolerance is the ability of the UE transmitter to set its initial output power to a specific value for the first sub-frame at the start of a contiguous transmission or non-contiguous transmission with a transmission gap larger than 20ms. This tolerance includes the channel estimation error (the absolute RSRP accuracy requirement specified in clause 9.1 of TS 36.133)

In the case of a PRACH transmission, the absolute tolerance is specified for the first preamble. The absolute power tolerance includes the channel estimation error (the absolute RSRP accuracy requirement specified in clause 9.1 of TS 36.133).

#### 6.3.5.1.1 Minimum requirements

The minimum requirement for absolute power tolerance is given in Table 6.3.5.1.1-1 over the power range bounded by the Maximum output power as defined in sub-clause 6.2.2 and the Minimum output power as defined in sub-clause 6.3.2.

When the transmission bandwidth is confined within  $FUL_{low}$  and  $FUL_{low} + \Delta_{TC}$  or it is confined within  $FUL_{high} - \Delta_{TC}$  and  $FUL_{high}$ , the absolute power tolerance as specified in Table 6.3.5.1.1-1 is relaxed by reducing the lower limit by [1.5] dB

**Table 6.3.5.1.1-1: Absolute power tolerance**

Conditions	Tolerance
Normal	$\pm 9.0$ dB
Extreme	$\pm 12.0$ dB

### 6.3.5.2 Relative Power tolerance

Relative power tolerance is the ability of the UE transmitter to set its output power relatively to the power of the most recently transmitted sub-frame if the transmission gap between these sub-frames has been  $\leq 20$  ms.

In the case of a PRACH transmission, the relative tolerance is the ability of the UE transmitter to set its output power relatively to the power of the most recently transmitted preamble. The measurement period for the PRACH preamble is specified in Table 6.3.4.2-1

#### 6.3.5.2.1 Minimum requirements

The UE shall meet the requirements specified in Table 6.3.5.2.1-1

To account for RF Power amplifier mode changes TBD exceptions are allowed. For these exceptions the power tolerance limit is a maximum of  $[\pm 6.0$  dB] in Table 6.3.5.2.1-1

**Table 6.3.5.2.1-1 Relative Power Tolerance for Transmission (normal conditions)**

power step size (Up or down) $\Delta P$ [dB]	PUSCH/ PUCCH [dB]	SRS [dB]	PRACH [dB]
$\Delta P < 2$	$\pm 2.5$	$\pm[2.5 + 0.5]$	$\pm 2.5$
$2 \leq \Delta P < 3$	$\pm 3.0$	$\pm[3.0 + 1.0]$	$\pm 3.0$
$3 \leq \Delta P < 4$	$\pm 3.5$	$\pm[3.5 + 1.5]$	$\pm 3.5$
$4 \leq \Delta P < 10$	$\pm 4.0$	$\pm[4.0 + 2.0]$	$\pm 4.0$
$10 \leq \Delta P < 15$	$\pm 5.0$	$\pm[5.0 + 3.0]$	$\pm 5.0$
$15 \leq \Delta P$	$\pm 6.0$	$\pm[6.0 + 3.0]$	$\pm 6.0$
Note For extreme conditions an additional $\pm 2.0$ dB relaxation is allowed for PUSCH/PUCCH/SRS/PRACH allocations			

When the transmission bandwidth is confined within  $FUL_{low}$  and  $FUL_{low} + \Delta_{TC}$  or it is confined within  $FUL_{high} - \Delta_{TC}$  and  $FUL_{high}$ , the relative power tolerance as specified in Table 6.3.5.2.1-1 is relaxed by reducing the lower limit by  $[1.5]$  dB.

For a sub-frame excluding a SRS symbol, the power change is defined as the relative power difference between the mean power of the original (reference) sub-frame and the mean power of the target subframe, not including the transient duration. The mean power of successive sub-frames shall be calculated according to Figure 6.3.4.3-1

For a sub-frame including a SRS symbol, the power change is defined as the relative power difference between the mean power of the transmission preceding or succeeding the SRS symbol and the mean power of the target SRS symbol duration period not including the transient duration. The mean power of successive SRS symbols shall be calculated according to Figure 6.3.4.4-1 to Figure 6.3.4.4-3.

### 6.3.5.3 Aggregate power control tolerance

Aggregate power control tolerance is the ability of a UE to maintain its power in non-contiguous transmission within 21 ms in response to 0 dB TPC commands with respect to the first UE transmission, when the power control parameters specified in TS 36.213 are constant.

### 6.3.5.3.1 Minimum requirement

The UE shall meet the requirements specified in Table 6.3.5.3.1-1 for aggregate power control over the power range bounded by the minimum output power as defined in subclause 6.3.2 and the maximum output power as defined in subclause 6.2.2.

**Table 6.3.5.3.1-1: Aggregate Power Control Tolerance**

<i>TPC command</i>	<i>UL channel</i>	<i>Aggregate power tolerance within 21 ms</i>
<i>0 dB</i>	<i>PUCCH</i>	<i>±2.5 dB</i>
<i>0 dB</i>	<i>PUSCH</i>	<i>±3.5 dB</i>
<i>Note:</i>		
1. <i>The UE transmission gap is 4 ms. TPC command is transmitted via PDCCH 4 subframes preceding each PUCCH/PUSCH transmission.</i>		

## 6.4 Void

## 6.5 Transmit signal quality

### 6.5.1 Frequency error

The UE modulated carrier frequency shall be accurate to within  $\pm 0.1$  PPM observed over a period of one time slot (0.5 ms) compared to the carrier frequency received from the E-UTRA Node B

### 6.5.2 Transmit modulation

Transmit modulation defines the modulation quality for expected in-channel RF transmissions from the UE. This transmit modulation limit is specified in terms of; an Error Vector Magnitude (EVM) for the allocated resources blocks (RB), an I/Q component and an in-band emissions for the non-allocated RB.

All the parameters defined in clause 6.5.2 are defined using the measurement methodology specified in Annex F.

#### 6.5.2.1 Error Vector Magnitude

The Error Vector Magnitude is a measure of the difference between the reference waveform and the measured waveform. This difference is called the error vector. Before calculating the EVM the measured waveform is corrected by the sample timing offset and RF frequency offset. Then the IQ origin offset shall be removed from the measured waveform before calculating the EVM.

The measured waveform is further modified by selecting the absolute phase and absolute amplitude of the Tx chain. The EVM result is defined after the front-end IDFT as the square root of the ratio of the mean error vector power to the mean reference power expressed as a %.

The basic EVM measurement interval in the time domain is one preamble sequence for the PRACH and is one slot for the PUCCH and PUSCH in the time domain. When the PUSCH or PUCCH transmission slot is shortened due to multiplexing with SRS, the EVM measurement interval is reduced by one symbol, accordingly. The PUSCH or PUCCH EVM measurement interval is also reduced when the mean power between slots is expected to change. In the case of PUSCH transmission, the measurement interval is reduced by a time interval equal to the sum of 5  $\mu$ s and the applicable exclusion period defined in subclause 6.3.4, adjacent to the boundary where the power change is expected to occur. The PUSCH exclusion period is applied to the signal obtained after the front-end IDFT. In the case of PUCCH transmission with power change, the PUCCH EVM measurement interval is reduced by one symbol adjacent to the boundary where the power change is expected to occur.

### 6.5.2.1.1 Minimum requirement

The RMS average of the basic EVM measurements for 10 sub-frames excluding any transient period for the average EVM case, and 60 sub-frames excluding any transient period for the reference signal EVM case, for the different modulations schemes shall not exceed the values specified in Table 6.5.2.1.1-1 for the parameters defined in Table 6.5.2.1.1-2. For EVM evaluation purposes, [all PRACH preamble formats 0-4 and] all PUCCH formats 1, 1a, 1b, 2, 2a and 2b are considered to have the same EVM requirement as QPSK modulated.

**Table 6.5.2.1.1-1: Minimum requirements for Error Vector Magnitude**

Parameter	Unit	Average EVM Level	Reference Signal EVM Level
QPSK or BPSK	%	17.5	[17.5]
16QAM	%	12.5	[12.5]

**Table 6.5.2.1.1-2: Parameters for Error Vector Magnitude**

Parameter	Unit	Level
UE Output Power	dBm	$\geq -40$
Operating conditions		Normal conditions

### 6.5.2.2 IQ-component

The IQ origin offset is the phase and amplitude of an additive sinusoid waveform that has the same frequency as the reference waveform carrier frequency. The measurement interval is one slot in the time domain.

#### 6.5.2.2.1 Minimum requirements

The relative carrier leakage power (IQ origin offset power) shall not exceed the values specified in Table 6.5.2.2.1-1.

**Table 6.5.2.2.1-1: Minimum requirements for Relative Carrier Leakage Power**

LO Leakage	Parameters	Relative Limit (dBc)
	Output power $>0$ dBm	-25
	$-30$ dBm $\leq$ Output power $\leq 0$ dBm	-20
	$-40$ dBm $\leq$ Output power $< -30$ dBm	-10

### 6.5.2.3 In-band emissions

The in-band emission is defined as the average across 12 sub-carrier and as a function of the RB offset from the edge of the allocated UL transmission bandwidth. The in-band emission is measured as the ratio of the UE output power in a non-allocated RB to the UE output power in an allocated RB.

The basic in-band emissions measurement interval is defined over one slot in the time domain. When the PUSCH or PUCCH transmission slot is shortened due to multiplexing with SRS, the in-band emissions measurement interval is reduced by one SC-FDMA symbol, accordingly.

#### 6.5.2.3.1 Minimum requirements

The relative in-band emission shall not exceed the values specified in Table 6.5.2.3.1-1.

Table 6.5.2.3.1-1: Minimum requirements for in-band emissions

Parameter Description	Unit	Limit (Note 1)	Applicable Frequencies
General	<b>dB</b>	$\max \left\{ -30, -25 - 10 \cdot \log_{10} (N_{RB} / L_{CRBs}), 20 \cdot \log_{10} EVM - 3 - 5 \cdot (\Delta_{RB} - 1) / L_{CRBs}, -57 \text{ dBm} / 180 \text{ kHz} - P_{RB} \right\}$	<b>Any non-allocated (Note 2)</b>
IQ Image	<b>dB</b>	<b>-25</b>	<b>Image frequencies (Notes 2, 3)</b>
DC	<b>dBc</b>	<b>-25</b>	<b>LO frequency (Notes 4, 5)</b>
		<b>-20</b>	
		<b>-10</b>	

**Note 1:** The minimum requirement is calculated from any of the listed requirements, whichever is the highest power.

**Note 2:** The measurement bandwidth is 1 RB and the limit is expressed as a ratio of measured power in one non-allocated RB to the measured average power per allocated RB, where the averaging is done across all allocated RBs.

**Note 3:** The applicable frequencies for this limit are those that are enclosed in the reflection of the allocated bandwidth, based on symmetry with respect to the centre carrier frequency, but excluding any allocated RBs.

**Note 4:** The measurement bandwidth is 1 RB and the limit is expressed as a ratio of measured power in one non-allocated RB to the measured total power in all allocated RBs.

**Note 5:** The applicable frequencies for this limit are those that are enclosed in the RBs containing the DC frequency if  $N_{RB}$  is odd, or in the two RBs immediately adjacent to the DC frequency if  $N_{RB}$  is even, but excluding any allocated RB.

**Note 6:**  $L_{CRBs}$  is the Transmission Bandwidth (see Figure 5.6-1).

**Note 7:**  $N_{RB}$  is the Transmission Bandwidth Configuration (see Figure 5.6-1).

**Note 8:**  $EVM$  is the limit specified in Table 6.5.2.1.1-1 for the modulation format used in the allocated RBs.

**Note 9:**  $\Delta_{RB}$  is the starting frequency offset between the allocated RB and the measured non-allocated RB (e.g.  $\Delta_{RB} = 1$  or  $\Delta_{RB} = -1$  for the first adjacent RB outside of the allocated bandwidth).

**Note 10:**  $P_{RB}$  is the transmitted power per 180 kHz in allocated RBs, measured in dBm.

## 6.5.2.4 Spectrum flatness

The spectrum flatness is defined as a relative power variation across the subcarriers of all RB of the allocated UL block. The spectrum flatness is measured as a dB value comparing the output power of a subcarrier and the average power per subcarrier. The measurement interval is one slot (0.5 ms).

### 6.5.2.4.1 Minimum requirements

The spectrum flatness shall not exceed the values specified in Table 6.5.2.4.1-1 for normal conditions and Table 6.5.2.4.1-2 for extreme conditions.

Table 6.5.2.4.1-1: Minimum requirements for spectrum flatness (normal conditions)

Spectrum Flatness	Relative Limit (dB)
If $F_{UL\_measurement} - F_{UL\_low} \geq 3\text{MHz}$ and If $F_{UL\_high} - F_{UL\_measurement} \geq 3\text{ MHz}$	+2/-2
If $F_{UL\_measurement} - F_{UL\_low} < 3\text{ MHz}$ or If $F_{UL\_high} - F_{UL\_measurement} < 3\text{ MHz}$	+3/-5
Note 1 $F_{UL\_low}$ and $F_{UL\_high}$ refers to each E-UTRA frequency band specified in Table 5.5-1 2 $F_{UL\_measurement}$ refers to the frequency of the subcarrier being evaluated	

Table 6.5.2.4.1-2: Minimum requirements for spectrum flatness (extreme conditions)

Spectrum Flatness	Relative Limit (dB)
If $F_{UL\_measurement} - F_{UL\_low} \geq 5\text{MHz}$ and If $F_{UL\_high} - F_{UL\_measurement} \geq 5\text{ MHz}$	+2/-2
If $F_{UL\_measurement} - F_{UL\_low} < 5\text{ MHz}$ and If $F_{UL\_high} - F_{UL\_measurement} < 5\text{ MHz}$	+4/-8
Note 1 $F_{UL\_low}$ and $F_{UL\_high}$ refers to each E-UTRA frequency band specified in Table 5.5-1 2 $F_{UL\_measurement}$ refers to the frequency of the subcarrier being evaluated	

## 6.6 Output RF spectrum emissions

The output UE transmitter spectrum consists of the three components; the emission within the occupied bandwidth (channel bandwidth), the Out Of Band (OOB) emissions and the far out spurious emission domain.

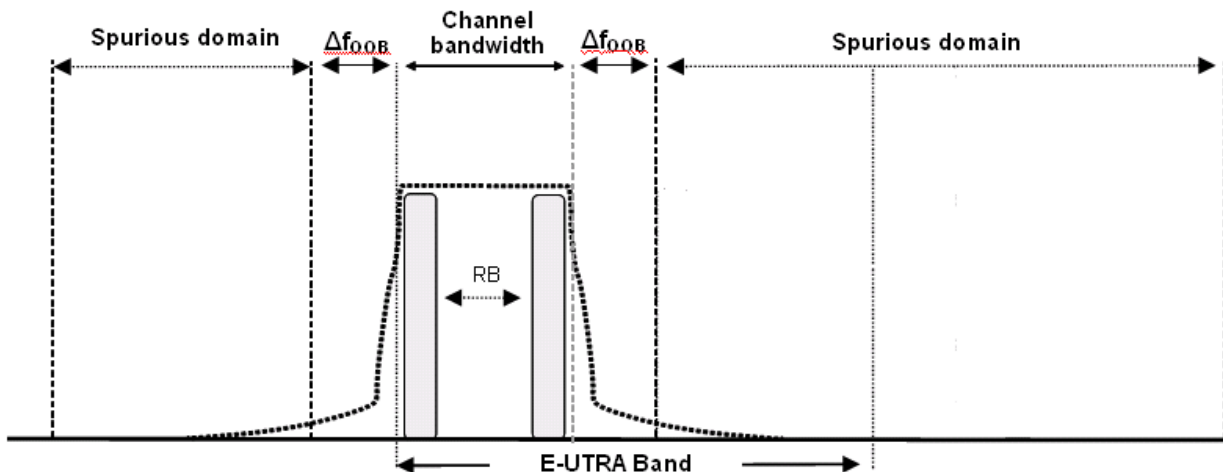

Figure 6.6-1: Transmitter RF spectrum

### 6.6.1 Occupied bandwidth

Occupied bandwidth is defined as the bandwidth containing 99 % of the total integrated mean power of the transmitted spectrum on the assigned channel. The occupied bandwidth for all transmission bandwidth configurations (Resources Blocks) shall be less than the channel bandwidth specified in Table 6.6.1-1

**Table 6.6.1-1: Occupied channel bandwidth**

	Occupied channel bandwidth / channel bandwidth					
	1.4 MHz	3 MHz	5 MHz	10 MHz	15 MHz	20 MHz
Channel bandwidth (MHz)	1.4	3	5	10	15	20

### 6.6.2 Out of band emission

The Out of band emissions are unwanted emissions immediately outside the assigned channel bandwidth resulting from the modulation process and non-linearity in the transmitter but excluding spurious emissions. This out of band emission limit is specified in terms of a spectrum emission mask and an Adjacent Channel Leakage power Ratio.

#### 6.6.2.1 Spectrum emission mask

The spectrum emission mask of the UE applies to frequencies ( $\Delta f_{OOB}$ ) starting from the  $\pm$  edge of the assigned E-UTRA channel bandwidth. For frequencies greater than ( $\Delta f_{OOB}$ ) as specified in Table 6.6.2.1.1-1 the spurious requirements in clause 6.6.3 are applicable.

##### 6.6.2.1.1 Minimum requirement

The power of any UE emission shall not exceed the levels specified in Table 6.6.2.1.1-1 for the specified channel bandwidth.

**Table 6.6.2.1.1-1: General E-UTRA spectrum emission mask**

Spectrum emission limit (dBm)/ Channel bandwidth							
$\Delta f_{OOB}$ (MHz)	1.4 MHz	3.0 MHz	5 MHz	10 MHz	15 MHz	20 MHz	Measurement bandwidth
$\pm 0-1$	-10	-13	-15	-18	-20	-21	30 kHz
$\pm 1-2.5$	-10	-10	-10	-10	-10	-10	1 MHz
$\pm 2.5-2.8$	-25	-10	-10	-10	-10	-10	1 MHz
$\pm 2.8-5$		-10	-10	-10	-10	-10	1 MHz
$\pm 5-6$		-25	-13	-13	-13	-13	1 MHz
$\pm 6-10$			-25	-13	-13	-13	1 MHz
$\pm 10-15$				-25	-13	-13	1 MHz
$\pm 15-20$					-25	-13	1 MHz
$\pm 20-25$						-25	1 MHz

Note: As a general rule, the resolution bandwidth of the measuring equipment should be equal to the measurement bandwidth. However, to improve measurement accuracy, sensitivity and efficiency, the resolution bandwidth may be smaller than the measurement bandwidth. When the resolution bandwidth is smaller than the measurement bandwidth, the result should be integrated over the measurement bandwidth in order to obtain the equivalent noise bandwidth of the measurement bandwidth.

#### 6.6.2.2 Additional Spectrum Emission Mask

This requirement is specified in terms of an "additional spectrum emission" requirement.



### 6.6.2.2.1 Minimum requirement (network signalled value "NS\_03")

Additional spectrum emission requirements are signalled by the network to indicate that the UE shall meet an additional requirement for a specific deployment scenario as part of the cell handover/broadcast message.

When "NS\_03" is indicated in the cell, the power of any UE emission shall not exceed the levels specified in Table 6.6.2.2.1-1.

**Table 6.6.2.2.1-1: Additional requirements**

$\Delta f_{\text{OOB}}$ (MHz)	Spectrum emission limit (dBm)/ Channel bandwidth						
	1.4 MHz	3.0 MHz	5 MHz	10 MHz	15 MHz	20 MHz	Measurement bandwidth
$\pm 0-1$	-10	-13	-15	-18	-20	-21	30 kHz
$\pm 1-2.5$	-13	-13	-13	-13	-13	-13	1 MHz
$\pm 2.5-5$	-25	-13	-13	-13	-13	-13	1 MHz
$\pm 5-6$		-25	-13	-13	-13	-13	1 MHz
$\pm 6-10$			-25	-13	-13	-13	1 MHz
$\pm 10-15$				-25	-13	-13	1 MHz
$\pm 15-20$					-25	-13	1 MHz
$\pm 20-25$						-25	1 MHz

Note: As a general rule, the resolution bandwidth of the measuring equipment should be equal to the measurement bandwidth. However, to improve measurement accuracy, sensitivity and efficiency, the resolution bandwidth may be smaller than the measurement bandwidth. When the resolution bandwidth is smaller than the measurement bandwidth, the result should be integrated over the measurement bandwidth in order to obtain the equivalent noise bandwidth of the measurement bandwidth.

### 6.6.2.2.2 Minimum requirement (network signalled value "NS\_04")

Additional spectrum emission requirements are signalled by the network to indicate that the UE shall meet an additional requirement for a specific deployment scenario as part of the cell handover/broadcast message.

When "NS\_04" is indicated in the cell, the power of any UE emission shall not exceed the levels specified in Table 6.6.2.2.2-1.

**Table 6.6.2.2.2-1: Additional requirements**

$\Delta f_{\text{OOB}}$ (MHz)	Spectrum emission limit (dBm)/ Channel bandwidth						
	1.4 MHz	3.0 MHz	5 MHz	10 MHz	15 MHz	20 MHz	Measurement bandwidth
$\pm 0-1$	-10	-13	-15	-18	-20	-21	30 kHz
$\pm 1-2.5$	-13	-13	-13	-13	-13	-13	1 MHz
$\pm 2.5-5$	-25	-13	-13	-13	-13	-13	1 MHz
$\pm 5-6$		-25	-25	-25	-25	-25	1 MHz
$\pm 6-10$			-25	-25	-25	-25	1 MHz
$\pm 10-15$				-25	-25	-25	1 MHz
$\pm 15-20$					-25	-25	1 MHz
$\pm 20-25$						-25	1 MHz

Note: As a general rule, the resolution bandwidth of the measuring equipment should be equal to the measurement bandwidth. However, to improve measurement accuracy, sensitivity and efficiency, the resolution bandwidth may be smaller than the measurement bandwidth. When the resolution bandwidth is smaller than the measurement bandwidth, the result should be integrated over the measurement bandwidth in order to obtain the equivalent noise bandwidth of the measurement bandwidth.

6.6.2.2.3 Minimum requirement (network signalled value "NS\_06" or 'NS\_07')

Additional spectrum emission requirements are signalled by the network to indicate that the UE shall meet an additional requirement for a specific deployment scenario as part of the cell handover/broadcast message.

When "NS\_06" or 'NS\_07' is indicated in the cell, the power of any UE emission shall not exceed the levels specified in Table 6.6.2.2.3-1.

**Table 6.6.2.2.3-1: Additional requirements**

$\Delta f_{OOB}$ (MHz)	Spectrum emission limit (dBm)/ Channel bandwidth				
	1.4 MHz	3.0 MHz	5 MHz	10 MHz	Measurement bandwidth
$\pm 0-0.1$	-13	-13	-15	-18	30 kHz
$\pm 0.1-1$	-13	-13	-13	-13	100 kHz
$\pm 1-2.5$	-13	-13	-13	-13	1 MHz
$\pm 2.5-5$	-25	-13	-13	-13	1 MHz
$\pm 5-6$		-25	-13	-13	1 MHz
$\pm 6-10$			-25	-13	1 MHz
$\pm 10-15$				-25	1 MHz

Note: As a general rule, the resolution bandwidth of the measuring equipment should be equal to the measurement bandwidth. However, to improve measurement accuracy, sensitivity and efficiency, the resolution bandwidth may be smaller than the measurement bandwidth. When the resolution bandwidth is smaller than the measurement bandwidth, the result should be integrated over the measurement bandwidth in order to obtain the equivalent noise bandwidth of the measurement bandwidth.

6.6.2.3 Adjacent Channel Leakage Ratio

Adjacent Channel Leakage power Ratio (ACLR) is the ratio of the filtered mean power centred on the assigned channel frequency to the filtered mean power centred on an adjacent channel frequency. ACLR requirements are specified for two scenarios for an adjacent E-UTRA and /or UTRA channel as shown in Figure 6.6.2.3 -1.

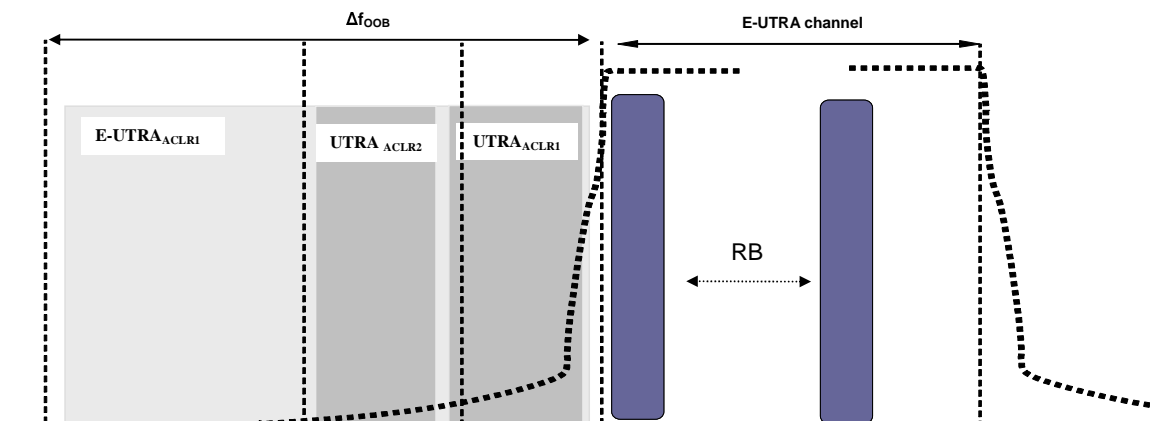

**Figure 6.6.2.3-1: Adjacent Channel Leakage requirements**

6.6.2.3.1 Minimum requirement E-UTRA

E-UTRA Adjacent Channel Leakage power Ratio (E-UTRA<sub>ACLR</sub>) is the ratio of the filtered mean power centred on the assigned channel frequency to the filtered mean power centred on an adjacent channel frequency at nominal channel spacing. The assigned E-UTRA channel power and adjacent E-UTRA channel power are measured with rectangular filters with measurement bandwidths specified in Table 6.6.2.3.1-1. If the measured adjacent channel power is greater than -50dBm then the E-UTRA<sub>ACLR</sub> shall be higher than the value specified in Table 6.6.2.3.1-1.

**Table 6.6.2.3.1-1: General requirements for E-UTRA<sub>ACLR</sub>**

	Channel bandwidth / E-UTRA <sub>ACLR1</sub> / measurement bandwidth					
	4 Hz	0 Hz	5 MHz	10 MHz	15 MHz	20 MHz
E-UTRA <sub>ACLR1</sub>	dB	dB	0 dB	0 dB	0 dB	0 dB
UTRA channel Measurement bandwidth	MHz	MHz	MHz	MHz	5 MHz	MHz

6.6.2.3.2 Minimum requirements UTRA

UTRA Adjacent Channel Leakage power Ratio (UTRA<sub>ACLR</sub>) is the ratio of the filtered mean power centred on the assigned E-UTRA channel frequency to the filtered mean power centred on an adjacent(s) UTRA channel frequency.

UTRA Adjacent Channel Leakage power Ratio is specified for both the first UTRA adjacent channel (UTRA<sub>ACLR1</sub>) and the 2<sup>nd</sup> UTRA adjacent channel (UTRA<sub>ACLR2</sub>). The UTRA channel power is measured with a RRC bandwidth filter with roll-off factor  $\alpha = 0.22$ . The assigned E-UTRA channel power is measured with a rectangular filter with measurement bandwidth specified in Table 6.6.2.3.2-1. If the measured UTRA channel power is greater than  $-50\text{dBm}$  then the UTRA<sub>ACLR</sub> shall be higher than the value specified in Table 6.6.2.3.2-1.

**Table 6.6.2.3.2-1: Additional requirements**

	Channel bandwidth / UTRA <sub>ACLR1/2</sub> / measurement bandwidth					
	4 Hz	0 Hz	5 MHz	10 MHz	15 MHz	20 MHz
UTRA <sub>ACLR1</sub>	dB	dB	33 dB	33 dB	33 dB	33 dB
nt channel centre frequency offset (in MHz)			$+BW_{\text{UTRA}}/2$	$BW_{\text{UTRA}}/2$	$+BW_{\text{UTRA}}/2$	$0+BW_{\text{UTRA}}/2$
UTRA <sub>ACLR2</sub>			36 dB	36 dB	36 dB	36 dB
nt channel centre frequency offset (in MHz)			$3 \cdot BW_{\text{UTRA}}/2$	$BW_{\text{UTRA}}/2$	$3 \cdot BW_{\text{UTRA}}/2$	$+3 \cdot BW_{\text{UTRA}}/2$
UTRA channel Measurement bandwidth			1.5 MHz	0 MHz	3.5 MHz	18 MHz
5MHz channel Measurement bandwidth*			3.84 MHz	3.84 MHz	3.84 MHz	3.84 MHz
1.6MHz channel measurement bandwidth**			1.28 MHz	1.28MHz	1.28MHz	1.28MHz
* Note: Applicable for E-UTRA FDD co-existence with UTRA FDD in paired spectrum.						
** Note: Applicable for E-UTRA TDD co-existence with UTRA TDD in unpaired spectrum.						

6.6.2.4 Additional ACLR requirements

This requirement is specified in terms of an additional UTRA<sub>ACLR2</sub> requirement.

6.6.2.4.1 Void

6.6.3 Spurious emissions

Spurious emissions are emissions which are caused by unwanted transmitter effects such as harmonics emission, parasitic emissions, intermodulation products and frequency conversion products, but exclude out of band emissions. The spurious emission limits are specified in terms of general requirements inline with SM.329 [2] and E-UTRA operating band requirement to address UE co-existence.

Unless otherwise stated, the spurious emission limits apply for the frequency ranges that are more than  $\Delta f_{\text{OOB}}$  (MHz) in Table 6.6.3.1-1 from the edge of the channel bandwidth.

6.6.3.1 Minimum requirements

Table 6.6.3.1-1: Boundary between E-UTRA  $\Delta f_{\text{OOB}}$  and spurious emission domain

Channel bandwidth	4 MHz	5 MHz	6 MHz	7 MHz	8 MHz	9 MHz
$\Delta f_{\text{OOB}}$ (MHz)	0	0	0	0	0	0

The spurious emission limits in Table 6.6.3.1-2 apply for all transmitter band configurations (RB) and channel bandwidths.

Table 6.6.3.1-2: Spurious emissions limits

Frequency Range	Minimum Level	Measurement Bandwidth
$150 \text{ kHz} \leq f < 30 \text{ MHz}$	-36 dBm	1 kHz
$30 \text{ MHz} \leq f < 100 \text{ MHz}$	-36 dBm	10 kHz
$100 \text{ MHz} \leq f < 12.75 \text{ GHz}$	-30 dBm	1 MHz

6.6.3.2 Spurious emission band UE co-existence

This clause specifies the requirements for the specified E-UTRA band

Table 6.6.3.2-1: Requirements

E-UTRA Band	Spurious emission						
	Protected band	Frequency range (MHz)			Level (dBm)	Bandwidth (MHz)	Comment
1	E-UTRA Band 1, 3, 7, 8, 9, 11, 34, 38, 40	FDL_low	-	FDL_high	-50	1	
	Frequency range	860	-	895	-50	1	
	Frequency range	1884.5	-	1919.6	-41	0.3	Note <sup>6</sup> , Note <sup>7</sup>
		1884.5	-	1915.7			Note <sup>6</sup> , Note <sup>8</sup>
	E-UTRA band 33	1900	-	1920	-50	1	Note <sup>3</sup>
E-UTRA band 39	1880	-	1920	-50	1	Note <sup>3</sup>	

2	E-UTRA Band 2, 4, 5, 10, 12, 13, 14, 17	FDL_low	-	FDL_high	-50	1	
3	E-UTRA Band 1, 3, 7, 8, 9, 11, 33, 34, 38	FDL_low	-	FDL_high	-50	1	
4	E-UTRA Band 2, 4, 5, 10, 12, 13, 14, 17	FDL_low	-	FDL_high	-50	1	
5	E-UTRA Band 2, 4, 5, 10, 12, 13, 14, 17	FDL_low	-	FDL_high	-50	1	
6	E-UTRA Band 1, 9, 11, 34	FDL_low	-	FDL_high	-50	1	
	Frequency range	860	-	875	-37	1	
	Frequency range	875	-	895	-50	1	
	Frequency range	1884.5	-	1919.6			Note <sup>7</sup>
	Frequency range	1884.5	-	1915.7	-41	0.3	Note <sup>8</sup>
7	E-UTRA Band 1, 3, 7, 8, 33, 34	FDL_low	-	FDL_high	-50	1	
	E-UTRA Band 38	2570	-	2620	-50	1	Note <sup>3</sup>
8	E-UTRA Band 1, 8, 7, 33, 34, 38, 39, 40	FDL_low	-	FDL_high	-50	1	
	E-UTRA band 3	1805	-	1830	-50	1	Note <sup>4</sup>
	E-UTRA band 3	1805	-	1880	-36	0.1	Note <sup>2,4</sup>
	E-UTRA band 3	1830	-	1880	-50	1	Note <sup>4</sup>
	E-UTRA band 7	2640	-	2690	-50	1	Note <sup>4</sup>
	E-UTRA band 7	2640	-	2690	-36	0.1	Note <sup>2,4</sup>
9	E-UTRA Band 1, 9, 11, 34	FDL_low	-	FDL_high	-50	1	
	Frequency range	860	-	895	-50	1	
	Frequency range	1884.5	-	1919.6			Note <sup>7</sup>
	Frequency range	1884.5	-	1915.7	-41	0.3	Note <sup>8</sup>
10	E-UTRA Band 2, 4, 5, 10, 12, 13, 14, 17	FDL_low	-	FDL_high	-50	1	
11	E-UTRA Band 1, 9, 11, 34	FDL_low	-	FDL_high	-50	1	
	Frequency range	860	-	895	-50	1	
	Frequency range	1884.5	-	1919.6			Note <sup>7</sup>
	Frequency range	1884.5	-	1915.7	-41	0.3	Note <sup>8</sup>
12	E-UTRA Band 2, 4, 5, 10, 12, 13, 14, 17	FDL_low	-	FDL_high	-50	1	
13	E-UTRA Band 2, 4, 5, 10, 12, 13, 14, 17	FDL_low	-	FDL_high	-50	1	
	Frequency range	763	-	775	-35	0.00625	
14	E-UTRA Band 2, 4, 5, 10, 12, 13, 14, 17	FDL_low	-	FDL_high	-50	1	
	Frequency range	763	-	775	-35	0.00625	
17	E-UTRA Band 2, 4, 5, 10, 12, 13, 14, 17	FDL_low	-	FDL_high	-50	1	
...							
33	E-UTRA Band 1, 3, 8, 34, 38, 39, 40	FDL_low	-	FDL_high	-50	1	Note <sup>5</sup>
34	E-UTRA Band 1, 3, 7, 8, 9, 11, 33, 38,39, 40	FDL_low	-	FDL_high	-50	1	Note <sup>5</sup>
	Frequency range	860	-	895	-50	1	

	Frequency range	1884.5	-	1919.6	-41	0.3	Note <sup>7</sup>
		1884.5	-	1915.7			Note <sup>8</sup>
35							
36							
37			-				
38	E-UTRA Band 1, 3, 33, 34	FDL_low	-	FDL_high	-50	1	
39	E-UTRA Band 34, 40	FDL_low	-	FDL_high	-50	1	
40	E-UTRA Band 1, 3, 33, 34, 39	FDL_low	-	FDL_high	-50	1	

## Note

- 1 FDL\_low and FDL\_high refer to each E-UTRA frequency band specified in Table 5.5-1
- 2 As exceptions, measurements with a level up to the applicable requirements defined in Table 6.6.3.1-2 are permitted for each assigned E-UTRA carrier used in the measurement due to 2nd or 3rd harmonic spurious emissions. An exception is allowed if there is at least one individual RE within the transmission bandwidth (see Figure 5.6-1) for which the 2nd or 3rd harmonic, i.e. the frequency equal to two or three times the frequency of that RE, is within the measurement bandwidth.
- 3 To meet these requirements some restriction will be needed for either the operating band or protected band
- 4 Requirements are specified in terms of E-UTRA sub-bands
- 5 For non synchronised TDD operation to meet these requirements some restriction will be needed for either the operating band or protected band
- 6 Applicable when NS\_05 in section 6.6.3.3.1 is signalled by the network.
- 7 Applicable when co-existence with PHS system operating in 1884.5-1919.6MHz.
- 8 Applicable when co-existence with PHS system operating in 1884.5-1915.7MHz.

### 6.6.3.3 Additional spurious emissions

These requirements are specified in terms of an additional spectrum emission requirement. Additional spurious emission requirements are signalled by the network to indicate that the UE shall meet an additional requirement for a specific deployment scenario as part of the cell handover/broadcast message.

#### 6.6.3.3.1 Minimum requirement (network signalled value "NS\_05")

When "NS\_05" is indicated in the cell, the power of any UE emission shall not exceed the levels specified in Table 6.6.3.3.1-1. This requirement also applies for the frequency ranges that are less than  $\Delta f_{\text{OOB}}$  (MHz) in Table 6.6.3.1-1 from the edge of the channel bandwidth.

Table 6.6.3.3.1-1: Additional requirements (PHS)

Frequency band (MHz)	Channel bandwidth / Spectrum emission limit (dBm)						Measurement bandwidth
	1.4 MHz	3.0 MHz	5 MHz	10 MHz	15 MHz	20 MHz	
$1884.5 \leq f \leq 1919.6^{*1}$	-41	-41	-41	-41	-41	-41	300 KHz
$1884.5 \leq f \leq 1915.7^{*2}$	-41	-41	-41	-41	-41	-41	300 KHz
Note 1. Applicable when the edge of the assigned E-UTRA UL channel bandwidth frequency is larger than or equal to the upper edge of PHS band (1919.6 MHz) + 4 MHz + the Channel BW assigned. Operations below this point are for further study. 2. Applicable when the edge of the assigned E-UTRA UL channel bandwidth frequency is larger than or equal to the upper edge of PHS band (1915.7 MHz) + 4 MHz + the Channel BW assigned. Operations below this point are for further study.							

#### 6.6.3.3.2 Minimum requirement (network signalled value 'NS\_07')

When 'NS 07' is indicated in the cell, the power of any UE emission shall not exceed the levels specified in Table 6.6.3.3.2-1.

Table 6.6.3.3.2-1: Additional requirements

Frequency band (MHz)	Channel bandwidth / Spectrum emission limit (dBm)	Measurement bandwidth
	10 MHz	
$763 \leq f \leq 775$	-57	6.25 kHz

## 6.7 Transmit intermodulation

The transmit intermodulation performance is a measure of the capability of the transmitter to inhibit the generation of signals in its non linear elements caused by presence of the wanted signal and an interfering signal reaching the transmitter via the antenna.

### 6.7.1 Minimum requirement

User Equipment(s) transmitting in close vicinity of each other can produce intermodulation products, which can fall into the UE, or eNode B receive band as an unwanted interfering signal. The UE intermodulation attenuation is defined by the ratio of the mean power of the wanted signal to the mean power of the intermodulation product when an interfering CW signal is added at a level below the wanted signal at each of the transmitter antenna port with the other antenna port(s) if any is terminated. Both the wanted signal power and the intermodulation product power are measured through E-UTRA rectangular filter with measurement bandwidth shown in Table 6.7.1-1.

The requirement of transmitting intermodulation is prescribed in Table 6.7.1-1.

Table 6.7.1-1: Transmit Intermodulation

BW Channel (UL)	5MHz		10MHz		15MHz		20MHz	
	5MHz	10MHz	10MHz	20MHz	15MHz	30MHz	20MHz	40MHz
Interference Signal Frequency Offset								
Interference CW Signal Level	-40dBc							
Intermodulation Product	-29dBc	-35dBc	-29dBc	-35dBc	-29dBc	-35dBc	-29dBc	-35dBc
Measurement bandwidth	4.5MHz	4.5MHz	9.0MHz	9.0MHz	13.5MHz	13.5MHz	18MHz	18MHz

## 7 Receiver characteristics

### 7.1 General

Unless otherwise stated the receiver characteristics are specified at the antenna connector(s) of the UE. For UE(s) with an integral antenna only, a reference antenna(s) with a gain of 0 dBi is assumed for each antenna port(s). UE with an integral antenna(s) may be taken into account by converting these power levels into field strength requirements, assuming a 0 dBi gain antenna. For UEs with more than one receiver antenna connector, identical interfering signals shall be applied to each receiver antenna port if more than one of these is used (diversity).

The levels of the test signal applied to each of the antenna connectors shall be as defined in the respective sections below.

All the parameters in clause 7 are defined using the DL reference measurement channel specified in Annex A.3.2 and using the set-up specified in Annex C.3.1

### 7.2 Diversity characteristics

The requirements in Section 7 assume that the receiver is equipped with two Rx port as a baseline. Requirements for 4 ports are FFS. With the exception of clause 7.9 all requirements shall be verified by using both (all) antenna ports simultaneously.

### 7.3 Reference sensitivity power level

The reference sensitivity power level REFSENS is the minimum mean power applied to both the UE antenna ports at which the throughput shall meet or exceed the requirements for the specified reference measurement channel.

#### 7.3.1 Minimum requirements (QPSK)

The throughput shall be  $\geq 95\%$  of the maximum throughput of the reference measurement channel as specified in Annex A.3.2 with parameters specified in Table 7.3.1-1 and table 7.3.1-2



**Table 7.3.1-1: Reference sensitivity QPSK  $P_{REFSENS}$**

Channel bandwidth							
E-UTRA Band	1.4 MHz (dBm)	3 MHz (dBm)	5 MHz (dBm)	10 MHz (dBm)	15 MHz (dBm)	20 MHz (dBm)	Duplex Mode
1	-	-	-100	-97	-95.2	-94	FDD
2	-103.2	-100.2	-98	-95	-93.2	-92	FDD
3	-102.2	-99.2	-97	-94	-92.2	-91	FDD
4	-105.2	-101.7	-100	-97	-95.2	-94	FDD
5	-103.2	-100.2	-98	-95			FDD
6	-	-	-100	-97			FDD
7	-	-	-98	-95	-93.2	-92	FDD
8	-102.2	-99.2	-97	-94			FDD
9	-	-	-99	-96	-94.2	-93	FDD
10	-	-	-100	-97	-95.2	-94	FDD
11	-	-	-98	-95	-93.2	-92	FDD
12	-102.2	-99.2	-97	-94			FDD
13	-102.2	-99.2	-97	-94			FDD
14							FDD
...							
17	-102.2	-99.2	-97	-94			FDD
...							
33	-	-	-100	-97	-95.2	-94	TDD
34	-	-	-100	-97	-95.2	-94	TDD
35	-106.2	-102.2	-100	-97	-95.2	-94	TDD
36	-106.2	-102.2	-100	-97	-95.2	-94	TDD
37	-	-	-100	-97	-95.2	-94	TDD
38	-	-	-100	-97			TDD
39	-	-	-100	-97	-95.2	-94	TDD
40	-	-	-100	-97	-95.2	-94	TDD
Note 1:	The transmitter shall be set to maximum output power level (Table 7.3.1-2)						
Note 2:	Reference measurement channel is A.3.2						
Note 3:	The signal power is specified per port						
Note 4:	For the UE which supports both Band 3 and Band 9 the reference sensitivity level of Band 3 + 0.5 dB is applicable for band 9						

Note 1: The relation to the received PSD is  $\langle \text{REF} \hat{I}_{or} \rangle = P_{REFSENS} (N_{sc}^{RB} N_{RB} \Delta f)^{-1}$  with  $N_{RB}$  is the maximum transmission configuration according to Table 5.6-1.

Table 7.3.1-2 specifies the minimum number of allocated uplink resource blocks for which the reference receive sensitivity requirement must be met.

Table 7.3.1-2: Maximum uplink configuration for reference sensitivity

E-UTRA Band / Channel bandwidth / NRB / Duplex mode							
E-UTRA Band	1.4 MHz	3 MHz	5 MHz	10 MHz	15 MHz	20 MHz	Duplex Mode
1	-	-	25	50	75	100	FDD
2	6	15	25	50	50 <sup>1</sup>	50 <sup>1</sup>	FDD
3	6	15	25	50	50 <sup>1</sup>	50 <sup>1</sup>	FDD
4	6	15	25	50	75	100	FDD
5	6	15	25	25 <sup>1</sup>	-	-	FDD
6	-	-	25	25 <sup>1</sup>	-	-	FDD
7	-	-	25	50	75 <sup>1</sup>	75 <sup>1</sup>	FDD
8	6	15	25	25 <sup>1</sup>	-	-	FDD
9	-	-	25	50	50 <sup>1</sup>	50 <sup>1</sup>	FDD
10	-	-	25	50	75	100	FDD
11	-	-	25	25 <sup>1</sup>	25 <sup>1</sup>	25 <sup>1</sup>	FDD
12	6	15	20 <sup>1</sup>	20 <sup>1</sup>			FDD
13	6	15	20 <sup>1</sup>	20 <sup>1</sup>			FDD
14							FDD
...							
17	6	15	20 <sup>1</sup>	20 <sup>1</sup>			FDD
...							
33	-	-	25	50	75	100	TDD
34	-	-	25	50	75	-	TDD
35	6	15	25	50	75	100	TDD
36	6	15	25	50	75	100	TDD
37	-	-	25	50	75	100	TDD
38	-	-	25	50	-	-	TDD
39			25	50	75	100	TDD
40				50	75	100	TDD
Note 1:	Maximum number of UL resources blocks allocated is less than the total resources blocks supported by the channel bandwidth						

### 7.3.2 Requirement for large transmission configurations

For some combinations of bandwidths and operating bands, a certain relaxation of the UE performance is allowed when the transmission configuration is larger than that in Table 7.3.1-2. Table 7.3.2-1 specifies the allowed maximum sensitivity degradation (MSD) when the UL resource block allocation is the total resource blocks (Table 5.6-1) supported by the channel bandwidth.

**Table 7.3.2-1: Maximum Sensitivity Degradation**

E-UTRA Band	Channel bandwidth						Duplex Mode
	1.4 MHz (dB)	3 MHz (dB)	5 MHz (dB)	10 MHz (dB)	15 MHz (dB)	20 MHz (dB)	
1			n/a	n/a	n/a	n/a	FDD
2	n/a	n/a	n/a	n/a	TBD	TBD	FDD
3	n/a	n/a	n/a	n/a	TBD	TBD	FDD
4	n/a	n/a	n/a	n/a	n/a	n/a	FDD
5	n/a	n/a	n/a	TBD			FDD
6			n/a	TBD			FDD
7			n/a	n/a	TBD	TBD	FDD
8	n/a	n/a	n/a	TBD			FDD
9			n/a	n/a	TBD	TBD	FDD
10			n/a	n/a	n/a	n/a	FDD
11			n/a	TBD	TBD	TBD	FDD
12			TBD	TBD			FDD
13	n/a	n/a	TBD	TBD			FDD
14							FDD
17			TBD	TBD			FDD

Note:  
 1. The transmitter shall be set to maximum output power level with MPR applied and with the maximum transmission configuration (Table 5.5-1) allocated

## 7.4 Maximum input level

This is defined as the maximum mean power received at the UE antenna port, at which the specified relative throughput shall meet or exceed the minimum requirements for the specified reference measurement channel.

### 7.4.1 Minimum requirements

The throughput shall be  $\geq 95\%$  of the maximum throughput of the reference measurement channels as specified in Annex A.3.2 with parameters specified in Table 7.4.1.

**Table 7.4.1-1: Maximum input level**

Rx Parameter	its	Channel bandwidth				
		MHz	Hz	Hz	Hz	Hz
Signal mean power		-25				

Note:  
 1. The transmitter shall be set to 4dB below the supported maximum output power.  
 2. Reference measurement channel is Annex A.3.2: 64QAM, R=3/4 variant.

## 7.5 Adjacent Channel Selectivity (ACS)

### 7.5.1 Minimum requirements

Adjacent Channel Selectivity (ACS) is a measure of a receiver's ability to receive a E-UTRA signal at its assigned channel frequency in the presence of an adjacent channel signal at a given frequency offset from the centre frequency of

the assigned channel. ACS is the ratio of the receive filter attenuation on the assigned channel frequency to the receive filter attenuation on the adjacent channel(s).

The UE shall fulfil the minimum requirement specified in Table 7.5.1-1 for all values of an adjacent channel interferer up to -25 dBm. However it is not possible to directly measure the ACS, instead the lower and upper range of test parameters are chosen in Table 7.5.1-2 and Table 7.5.1-3 where the throughput shall be ≥ 95% of the maximum throughput of the reference measurement channels as specified in Annex A.3.2.

**Table 7.5.1-1: Adjacent channel selectivity**

Parameter	Units	Channel bandwidth					
		1.4 MHz	3 MHz	5 MHz	5 MHz	5 MHz	7 MHz
ACS	dB	-30	-30	-30	-30	-30	-37

**Table 7.5.1-2: Test parameters for Adjacent channel selectivity, Case 1**

Parameter	Units	Channel bandwidth					
		1.4 MHz	3 MHz	5 MHz	5 MHz	5 MHz	7 MHz
Signal mean power	dBm	REFSENS + 14 dB					
Interferer mean power	dBm	S +45.5dB	S +45.5dB	S +45.5dB*	S +45.5dB	S +42.5dB	S +39.5dB
Frequency offset	Hz	±1.4	±3	±5	±5	±5	±5
Frequency offset	Hz	+0.0025	-0.0075	-0.0025	-0.0075	0.0125	+0.0025
<ol style="list-style-type: none"> <li>The transmitter shall be set to 4dB below the supported maximum output power.</li> <li>The interferer consists of the Reference measurement channel specified in Annex A.3.2 with set-up according to Annex C.3.1</li> </ol>							

**Table 7.5.1-3: Test parameters for Adjacent channel selectivity, Case 2**

Parameter	Units	Channel bandwidth					
		1.4 MHz	3 MHz	5 MHz	5 MHz	5 MHz	7 MHz
Signal mean power	dBm	-56.5	-56.5	-56.5	-56.5	-53.5	-50.5
Interferer mean power	dBm	-25					
Frequency offset	Hz	±1.4	±3	±5	±5	±5	±5
Frequency offset	Hz	+0.0025	-0.0075	-0.0025	-0.0075	0.0125	+0.0025
<ol style="list-style-type: none"> <li>The transmitter shall be set to 24dB below the supported maximum output power.</li> <li>The interferer consists of the Reference measurement channel specified in Annex 3.2 with set-up according to Annex C.3.1</li> </ol>							

## 7.6 Blocking characteristics

The blocking characteristic is a measure of the receiver's ability to receive a wanted signal at its assigned channel frequency in the presence of an unwanted interferer on frequencies other than those of the spurious response or the adjacent channels, without this unwanted input signal causing a degradation of the performance of the receiver beyond a

specified limit. The blocking performance shall apply at all frequencies except those at which a spurious response occur.

### 7.6.1 In-band blocking

In-band blocking is defined for an unwanted interfering signal falling into the UE receive band or into the first 15 MHz below or above the UE receive band at which the relative throughput shall meet or exceed the minimum requirement for the specified measurement channels..

#### 7.6.1.1 Minimum requirements

The throughput shall be  $\geq 95\%$  of the maximum throughput of the reference measurement channels as specified in Annex A.3.2 with parameters specified in Tables 7.6.1.1-1 and 7.6.1.1-2.

**Table 7.6.1.1-1: In band blocking parameters**

Parameter	Units	Channel bandwidth					
		1.4 MHz	3 MHz	5 MHz	5 MHz	7 MHz	9 MHz
Signal mean power		REFSENS + channel bandwidth specific value below					
		6	6	6	6	7	9
		1.4	3	5	5	5	5
$F_{\text{offset, case 1}}$	MHz	2.1+0.0125	4.5+0.0075	7.5+0.0125	7.5+0.0025	7.5+0.0075	7.5+0.0125
$F_{\text{offset, case 2}}$	MHz	3.5+0.0075	7.5+0.0075	12.5+0.0075	12.5+0.0125	12.5+0.0025	12.5+0.0075

Note 1: The transmitter shall be set to 4dB below the supported maximum output power.  
 Note 2: The interferer consists of the Reference measurement channel specified in Annex A.3.2 with set-up according to Annex C.3.1

**Table 7.6.1.1-2: In-band blocking**

E-UTRA band	Parameter	Units	Case 1	Case 2	Case 3
	$P_{\text{Interferer}}$	dBm	-56	-44	-30
	$F_{\text{Interferer}}$ (Offset)	MHz	$\pm BW/2 - F_{\text{offset, case 1}}$ & $\pm BW/2 + F_{\text{offset, case 1}}$	$\leq -BW/2 - F_{\text{offset, case 2}}$ & $\geq +BW/2 + F_{\text{offset, case 2}}$	$-BW/2 - 9 \text{ MHz}$ & $-BW/2 - 15 \text{ MHz}$
1, 2, 3, 4, 5, 6, 7, 8, 9, 10, 11, 12, 13, 33, 34, 35, 36, 37, 38, 39, 40	$F_{\text{Interferer}}$	MHz	(Note 2)	$F_{\text{DL\_low}} -15$ to $F_{\text{DL\_high}} +15$	
17	$F_{\text{Interferer}}$	MHz	(Note 2)	$F_{\text{DL\_low}} -9.0$ to $F_{\text{DL\_high}} +15$	$F_{\text{DL\_low}} -15$ and $F_{\text{DL\_low}} -9.0$ (Note 3)

**Note**

- 1 For certain bands, the unwanted modulated interfering signal may not fall inside the UE receive band, but within the first 15 MHz below or above the UE receive band.
- 2 For each carrier frequency the requirement is valid for two frequencies:
  - a. the carrier frequency  $-BW/2 - F_{\text{offset, case 1}}$  and
  - b. the carrier frequency  $+ BW/2 + F_{\text{offset, case 1}}$ .
- 3  $F_{\text{interferer}}$  range values for unwanted modulated interfering signal are interferer center frequencies.
- 4 Case 3 only applies to assigned UE channel bandwidth of 5 MHz.

## 7.6.2 Out-of-band blocking

Out-of-band band blocking is defined for an unwanted CW interfering signal falling more than 15 MHz below or above the UE receive band. For the first 15 MHz below or above the UE receive band the appropriate in-band blocking or adjacent channel selectivity in sub-clause 7.5.1 and sub-clause 7.6.1 shall be applied.

### 7.6.2.1 Minimum requirements

. The throughput shall be  $\geq 95\%$  of the maximum throughput of the reference measurement channels as specified in Annex A.3.2 with parameters specified in Tables 7.6.2.1-1 and 7.6.2.1-2.

For Table 7.6.2.1-2 in frequency range 1, 2 and 3, up to  $\max(24, 6 \cdot \lceil N_{RB} / 6 \rceil)$  exceptions are allowed for spurious response frequencies in each assigned frequency channel when measured using a 1MHz step size, where  $N_{RB}$  is the number of resource blocks in the downlink transmission bandwidth configuration (see Figure 5.4.2-1). For these exceptions the requirements of clause 7.7 Spurious response are applicable.

For Table 7.6.2.1-2 in frequency range 4, up to  $\max(8, \lceil (N_{RB} + 2 \cdot L_{CRBs}) / 8 \rceil)$  exceptions are allowed for spurious response frequencies in each assigned frequency channel when measured using a 1MHz step size, where  $N_{RB}$  is the number of resource blocks in the downlink transmission bandwidth configurations (see Figure 5.4.2-1) and  $L_{CRBs}$  is the number of resource blocks allocated in the uplink. For these exceptions the requirements of clause 7.7 spurious response are applicable.

**Table 7.6.2.1-1: Out-of-band blocking parameters**

Rx Parameter	its	Channel bandwidth					
		1Hz	Hz	Hz	1Hz	1Hz	1Hz
Signal mean power		FSSENS + channel bandwidth specific value below					
		6	6	6	6	7	9
Note 1: The transmitter shall be set to 4dB below the supported maximum output power. Note 2: Reference measurement channel is specified in Annex A.3.2.							

**Table 7.6.2.1-2: Out of band blocking**

band	er	its	Frequency			
			range 1	range 2	range 3	range 4
		m	-44	-30	-15	-15
5 10,11,12, 13, 17, 33,34, 35, 36, 37, 38, 39, 40	CW)		F <sub>DL_low</sub> -15 to F <sub>DL_low</sub> -60	F <sub>DL_low</sub> -60 to F <sub>DL_low</sub> -85	F <sub>DL_low</sub> -85 to 1 MHz	-
			F <sub>DL_high</sub> +15 to 60	F <sub>DL_high</sub> +60 to 85	F <sub>DL_high</sub> +85 to +12750 MHz	-
5, 12, 17		Hz	-	-	-	F <sub>UL_low</sub> - F <sub>UL_high</sub>

## 7.6.3 Narrow band blocking

This requirement is measure of a receiver's ability to receive a E-UTRA signal at its assigned channel frequency in the presence of an unwanted narrow band CW interferer at a frequency, which is less than the nominal channel spacing.

### 7.6.3.1 Minimum requirements

. The relative throughput shall be  $\geq 95\%$  of the maximum throughput of the reference measurement channels as specified in Annex A.3.2 with parameters specified in Table 7.6.3.1-1

**Table 7.6.3.1-1: Narrow-band blocking**

Parameter	Unit	Channel Bandwidth					
		1.4 MHz	3 MHz	5 MHz	10 MHz	15 MHz	20 MHz
$P_w$	dBm	$P_{REFSENS}$ + channel-bandwidth specific value below					
		22	18	16	13	14	16
$P_{UW}$ (CW)	dBm	-55	-55	-55	-55	-55	-55
$F_{UW}$ (offset for $\Delta f = 15$ kHz)	MHz	0.9075	1.7025	2.7075	5.2125	7.7025	10.2075
$F_{UW}$ (offset for $\Delta f = 7.5$ kHz)	MHz						
Note 1: The transmitter shall be set a 4 dB below the supported maximum power.							
Note 2: Reference measurement channel is specified in Annex A.3.2.							

## 7.7 Spurious response

Spurious response is a measure of the receiver's ability to receive a wanted signal on its assigned channel frequency without exceeding a given degradation due to the presence of an unwanted CW interfering signal at any other frequency at which a response is obtained i.e. for which the out of band blocking limit as specified in sub-clause 7.6.2 is not met.

### 7.7.1 Minimum requirements

The throughput shall be  $\geq 95\%$  of the maximum throughput of the reference measurement channels as specified in Annex A.3.2 with parameters specified in Tables 7.7.1-1 and 7.7.1-2.

**Table 7.7.1-1: Spurious response parameters**

Parameter	Unit	Channel bandwidth					
		1.4 MHz	3 MHz	5 MHz	10 MHz	15 MHz	20 MHz
Signal mean power		$P_{REFSENS}$ + channel bandwidth specific value below					
		6	5	5	6	7	9
1. The transmitter shall be set to 4dB below the supported maximum output power. 2. Reference measurement channel is specified in Annex A.3.2.							

**Table 7.7.1-2: Spurious Response**

Parameter	Unit	Level
$P_{Interferer}$ (CW)	dBm	-44
$F_{Interferer}$	MHz	Spurious response frequencies

## 7.8 Intermodulation characteristics

Intermodulation response rejection is a measure of the capability of the receiver to receive a wanted signal on its assigned channel frequency in the presence of two or more interfering signals which have a specific frequency relationship to the wanted signal.

### 7.8.1 Wide band intermodulation

The wide band intermodulation requirement is defined following the same principles using modulated E-UTRA carrier and CW signal as interferer.

#### 7.8.1.1 Minimum requirements

The throughput shall be  $\geq 95\%$  of the maximum throughput of the reference measurement channels as specified in Annex A.3.2 with parameters specified in Table 7.8.1.1 for the specified wanted signal mean power in the presence of two interfering signals

**Table 7.8.1.1-1: Wide band intermodulation**

Parameter	Units	Channel bandwidth					
		4 MHz	5 MHz	6 MHz	7 MHz	8 MHz	9 MHz
Signal mean power		REFSENS + channel bandwidth specific value below					
		12	8	6	6	7	9
		-46					
		-46					
		1.4	3	5			
		-BW/2 -2.1 / +BW/2 + 2.1	-BW/2 -4.5 / +BW/2 + 4.5	-BW/2 - 7.5 / +BW/2 + 7.5			
		$2 \cdot F_{\text{Interferer 1}}$					
<p>Note:</p> <p>1 The transmitter shall be set to 4dB below the supported maximum output power.</p> <p>2 Reference measurement channel is specified in Annex Annex A.3.2.</p> <p>3 The modulated interferer consists of the Reference measurement channel specified in Annex A.3.2 with set-up according to Annex C.3.1The interfering modulated signal is 5MHz E-UTRA signal as described in Annex D for channel bandwidth <math>\geq 5\text{MHz}</math></p>							

### 7.8.2 Void

## 7.9 Spurious emissions

The spurious emissions power is the power of emissions generated or amplified in a receiver that appear at the UE antenna connector.



## 7.9.1 Minimum requirements

The power of any narrow band CW spurious emission shall not exceed the maximum level specified in Table 7.9.1-1

**Table 7.9.1-1: General receiver spurious emission requirements**

Frequency Band	Measurement Bandwidth	Maximum level	Note
$30\text{MHz} \leq f < 1\text{GHz}$	100 kHz	-57 dBm	
$1\text{GHz} \leq f \leq 12.75\text{GHz}$	1 MHz	-47 dBm	

## 8 Performance requirement

This clause contains performance requirements for the physical channels specified in [TS 36.211]. The performance requirements for the UE in this clause are specified for the measurement channels specified in Annex A.3, the propagation conditions in Annex B and the downlink channels in Annex C.3.2.

### 8.1 General

#### 8.1.1 Dual-antenna receiver capability

The performance requirements are based on UE(s) that utilize a dual-antenna receiver.

##### 8.1.1.1 Simultaneous unicast and MBMS operations

##### 8.1.1.2 Dual-antenna receiver capability in idle mode

### 8.2 Demodulation of PDSCH (Cell-Specific Reference Symbols)

#### 8.2.1 FDD (Fixed Reference Channel)

The parameters specified in Table 8.2.1-1 are valid for all FDD tests unless otherwise stated.

**Table 8.2.1-1: Common Test Parameters (FDD)**

Parameter	Unit	Value
Inter-TTI Distance		1
Number of HARQ processes	Processes	8
Maximum number of HARQ transmission		4
Redundancy version coding sequence		{0,1,2,3} for QPSK and 16QAM {0,0,1,2} for 64QAM
Number of OFDM symbols for PDCCH	OFDM symbols	4 for 1.4 MHz bandwidth, 3 for 3 MHz and 5 MHz bandwidths, 2 for 10 MHz, 15 MHz and 20 MHz bandwidths
Cyclic Prefix		Normal
Note:		

For all test cases, the SNR is defined as

$$SNR = \frac{\hat{E}_s^{(1)} + \hat{E}_s^{(2)}}{N_{oc}^{(1)} + N_{oc}^{(2)}}$$

where the superscript indicates the receiver antenna connector. The SNR requirement applies for the UE categories given for each test.

##### 8.2.1.1 Single-antenna port performance

The single-antenna performance in a given multi-path fading environments is determined by the SNR for which a certain relative information bit throughput of the reference measurement channels in Annex A.3.2 is achieved. The

purpose of these tests is to verify the single-antenna performance with different channel models and MCS. The QPSK and 64QAM cases are also used to verify the performance for all bandwidths specified in Table 5.6.1-1.

8.2.1.1.1 Minimum Requirement QPSK

The requirements are specified in Table 8.2.1.1.1-2, with the addition of the parameters in Table 8.2.1.1.1-1 and the downlink physical channel setup according to table [in Annex C.3.2].

**Table 8.2.1.1.1-1: Test Parameters for Testing QPSK**

Parameter		Unit	Test [1.1-1.4,2.1]
Downlink power allocation	$\rho_A$	dB	0
	$\rho_B$	dB	0 (Note 1)
$N_{oc}$ at antenna port		dBm/15kHz	-98
Note 1: $P_B = 0$			

**Table 8.2.1.1.1-2: Minimum performance QPSK (FRC)**

Test number	Bandwidth	Reference Channel	Propagation Condition	Correlation Matrix and Antenna Configuration	Reference value		UE Category
					Fraction of Maximum Throughput (%)	SNR (dB)	
[1.1]	10 MHz	[R.2 FDD]	EVA5	1x2 Low	70	-1.0	
[1.2]	10 MHz	[R.2 FDD]	ETU70	1x2 Low	70	-0.4	
[1.3]	10 MHz	[R.2 FDD]	ETU300	1x2 Low	70	0.0	
[1.4]	10 MHz	[R.2 FDD]	HST	1x2 Low	70	-2.4	
[2.1]	1.4 MHz	[R.4 FDD]	EVA5	1x2 Low	70	-0.5	

8.2.1.1.2 Minimum Requirement 16QAM

The requirements are specified in Table 8.2.1.1.2-1, with the addition of the parameters in Table 8.2.1.1.2-2 and the downlink physical channel setup according to table [in Annex C.3.2].

**Table 8.2.1.1.2-1: Test Parameters for Testing 16QAM**

Parameter		Unit	Test [1.5-1.7]
Downlink power allocation	$\rho_A$	dB	0
	$\rho_B$	dB	0 (Note 1)
$N_{oc}$ at antenna port		dBm/15kHz	-98
Note 1: $P_B = 0$			

Table 8.2.1.1.2-2: Minimum performance 16QAM (FRC)

Test number	Bandwidth	Reference Channel	Propagation Condition	Correlation Matrix and Antenna Configuration	Reference value		UE Category
					Fraction of Maximum Throughput (%)	SNR (dB)	
[1.5]	10 MHz	[R.3 FDD]	EVA5	1x2 Low	70	6.7	
[1.6]	10 MHz	[R.3 FDD]	ETU70	1x2 Low	30	1.4	
[1.7]	10 MHz	[R.3 FDD]	ETU300	1x2 High	70	9.4	

### 8.2.1.1.3 Minimum Requirement 64QAM

The requirements are specified in Table 8.2.1.1.3-2, with the addition of the parameters in Table 8.2.1.1.3-1 and the downlink physical channel setup according to table [in Annex C.3.2].

**Table 8.2.1.1.3-1: Test Parameters for Testing 64QAM**

Parameter		Unit	Test [1.8-1.10,2.2-2.5]
Downlink power allocation	$\rho_A$	dB	0
	$\rho_B$	dB	0 (Note 1)
$N_{oc}$ at antenna port		dBm/15kHz	-98
Note 1: $P_B = 0$			

**Table 8.2.1.1.3-2: Minimum performance 64QAM (FRC)**

Test number	Bandwidth	Reference Channel	Propagation Condition	Correlation Matrix and Antenna Configuration	Reference value		UE Category
					Fraction of Maximum Throughput (%)	SNR (dB)	
[2.2]	3 MHz	[R.5 FDD]	EVA5	1x2 Low	70	17.6	
[2.3]	5 MHz	[R.6 FDD]	EVA5	1x2 Low	70	17.4	
[1.8]	10 MHz	[R.7 FDD]	EVA5	1x2 Low	70	17.7	
[1.9]	10 MHz	[R.7 FDD]	ETU70	1x2 Low	70	19.0	
[1.10]	10 MHz	[R.7 FDD]	EVA5	1x2 High	70	19.1	
[2.4]	15 MHz	[R.8 FDD]	EVA5	1x2 Low	70	17.7	
[2.5]	20 MHz	[R.9 FDD]	EVA5	1x2 Low	70	17.6	

**8.2.1.1.4 Minimum Requirement 1 PRB allocation**

The requirements are specified in Table 8.2.1.1.4-2, with the addition of the parameters in Table 8.2.1.1.4-1 and the downlink physical channel setup according to table [in Annex C.3.2]. The purpose of these tests is to verify the single-antenna performance with a single PRB allocated at the lower band edge.

**Table 8.2.1.1.4-1: Test Parameters for Testing 1 PRB allocation**

Parameter		Unit	Test [3.1-3.3]	Test [3.4]
Downlink power allocation	$\rho_A$	dB	0	0
	$\rho_B$	dB	0 (Note 1)	0 (Note 1)
$N_{oc}$ at antenna port		dBm/15kHz	TBD	TBD
Cell ID			0	0
Symbols for unused PRBs			OCNG (Note 2)	-
Symbols for MBSFN portion of MBSFN subframes (Note 3)			-	OCNG (Note 4)
<p>Note 1: <math>P_B = 0</math></p> <p>Note 2: Each unused physical resource block (PRB) is assigned to an individual virtual UE. The data for each virtual UE shall be uncorrelated with data from other virtual UEs over the period of any measurement. The data shall be QPSK modulated.</p> <p>Note 3: The MBSFN portion of an MBSFN subframe comprises the whole MBSFN subframe except the first two symbols in the first slot.</p> <p>Note 4: The MBSFN portion of the MBSFN subframes shall contain QPSK modulated data. Cell-specific reference signals are not inserted in the MBSFN portion of the MBSFN subframes, QPSK modulated MBSFN data is used instead.</p>				

**Table 8.2.1.1.4-2: Minimum performance 1PRB (FRC)**

Test number	Bandwidth and MCS	Reference Channel	OCNG Pattern	Propagation Condition	Correlation Matrix and Antenna Configuration	Reference value Fraction of Maximum Throughput (%)	SNR (dB)	UE Category
3.1	3 MHz 16QAM 1/2	R.0 FDD	OP.1 FDD	ETU70	1x2 Low	30	1.9	
3.2	10 MHz 16QAM 1/2	R.1 FDD	OP.2 FDD	ETU70	1x2 Low	30	1.9	
3.3	20 MHz 16QAM 1/2	R.1 FDD	OP.3 FDD	ETU70	1x2 Low	30	1.9	
3.4	10 MHz 16QAM 1/2	R.29 FDD	OP.4 FDD	ETU70	1x2 Low	30	2.0	

### 8.2.1.2 Transmit diversity performance

The requirements are specified in Table 8.2.1.2-2, with the addition of the parameters in Table 8.2.1.2-1 and the downlink physical channel setup according to table [in Annex C.3.2]. The purpose is to verify the performance of transmit diversity (SFBC) with 2 and 4 transmitter antennas.

**Table 8.2.1.2-1: Test Parameters for Transmit diversity Performance (FRC)**

Parameter		Unit	Test [7.1-7-3]
Downlink power allocation	$\rho_A$	dB	-3
	$\rho_B$	dB	-3 (Note 1)
$N_{oc}$ at antenna port		dBm/15kHz	-98
Note 1: $P_B = 1$			

**Table 8.2.1.2-2: Minimum performance Transmit Diversity (FRC)**

Test	Bandwidth and MCS	Reference Channel	Propagation Condition	Correlation Matrix and Antenna Configuration	Reference value		UE Category
					Fraction of Maximum Throughput (%)	SNR (dB)	
[7.1]	10 MHz 16QAM 1/2	[R.11 FDD]	EVA5	2x2 Medium	70	6.8	
[7.2]	10 MHz QPSK 1/3	[R.10 FDD]	HST	2x2 Low	70	-2.3	
[7.3]	1.4 MHz QPSK 1/3	[R.12 FDD]	EPA5	4x2 Medium	70	0.2	

**8.2.1.3 Open-loop spatial multiplexing performance**

The requirements are specified in Table 8.2.1.3-2, with the addition of the parameters in Table 8.2.1.3-1 and the downlink physical channel setup according to table [in Annex C.3.2]. The purpose is to verify the performance of large delay CDD with 2 and 4 transmitter antennas.

**Table 8.2.1.3-1: Test Parameters for Large Delay CDD (FRC)**

Parameter		Unit	Test [6.1]	Test [6.2]	
Downlink power allocation	$\rho_A$	dB	-3	-6	
	$\rho_B$	dB	-3 (Note 1)	-6 (Note 1)	
$N_{oc}$ at antenna port		dBm/15kHz	-98	-98	
Note 1: $P_B = 1$					

Table 8.2.1.3-2: Minimum performance Large Delay CDD (FRC)

Test	Bandwidth and MCS	Reference Channel	Propagation Condition	Correlation Matrix and Antenna Configuration	Reference value		UE Category
					Fraction of Maximum Throughput (%)	SNR (dB)	
[6.1]	10 MHz 16QAM 1/2	[R.11 FDD]	EVA70	2x2 Low	70	13.0	
[6.2]	10 MHz 16QAM 1/2	[R.14 FDD]	EVA70	4x2 Low	70	14.3	

#### 8.2.1.4 Closed-loop spatial multiplexing performance

##### 8.2.1.4.1 Minimum Requirement Single-Layer Spatial Multiplexing

The requirements are specified in Table 8.2.1.4.1-2, with the addition of the parameters in Table 8.2.1.4.1-1 and the downlink physical channel setup according to table [in Annex C.3.2]. The purpose of these tests is to verify the closed loop rank-one performance with wideband and frequency selective precoding.



**Table 8.2.1.4.1-1: Test Parameters for Single-Layer Spatial Multiplexing (FRC)**

Parameter		Unit	Test [4.1]	Test [4.2]	Test [4.3]
Downlink power allocation	$\rho_A$	dB	-3	-3	-6
	$\rho_B$	dB	-3 (Note 1)	-3 (Note 1)	-6 (Note 1)
$N_{oc}$ at antenna port		dBm/15kHz	-98	-98	-98
Precoding granularity		PRB	6	50	6
PMI delay (Note 2)		ms	8	8	8
Reporting interval		ms	TBD	TBD	TBD
Reporting mode			PUSCH 1-2	PUSCH 3-1	PUSCH 1-2
Note 1: $P_B = 1$ Note 2: If the UE reports in an available uplink reporting instance at subframe SF#n based on PMI estimation at a downlink SF not later than SF#(n-4), this reported PMI cannot be applied at the eNB downlink before SF#(n+4)					

**Table 8.2.1.4.1-2: Minimum performance Single-Layer Spatial Multiplexing (FRC)**

Test	Bandwidth	Reference Channel	Propagation Condition	Correlation Matrix and Antenna Configuration	Reference value		UE Category
					Fraction of Maximum Throughput (%)	SNR (dB)	
[4.1]	10 MHz QPSK 1/3	[R.10 FDD]	EVA5	2x2 Low	70	-2.5	
[4.2]	10 MHz QPSK 1/3	[R.10 FDD]	EPA5	2x2 High	70	-2.8	
[4.3]	10 MHz QPSK 1/3	[R.13 FDD]	EVA5	4x2 Low	70	-3.4	

**8.2.1.4.2 Minimum Requirement Multi-Layer Spatial Multiplexing**

The requirements are specified in Table 8.2.1.4.2-2, with the addition of the parameters in Table 8.2.1.4.2-1 and the downlink physical channel setup according to table [in Annex C.3.2]. The purpose of these tests is to verify the closed loop rank-two performance with wideband and frequency selective precoding.

**Table 8.2.1.4.2-1: Test Parameters for Multi-Layer Spatial Multiplexing (FRC)**

Parameter		Unit	Test [5.1]	Test [5.2]	Test [5.3]
Downlink power allocation	$\rho_A$	dB	-3	-3	-6
	$\rho_B$	dB	-3 (Note 1)	-3 (Note 1)	-6 (Note 1)
$N_{oc}$ at antenna port		dBm/15kHz	-98	-98	-98
Precoding granularity		PRB	50	50	6
PMI delay (Note 2)		ms	8	8	8
Reporting interval		ms	TBD	TBD	TBD
Reporting mode			PUSCH 1-2	PUSCH 3-1	PUSCH 1-2
Note 1: $P_B = 1$ Note 2: If the UE reports in an available uplink reporting instance at subframe SF#n based on PMI estimation at a downlink SF not later than SF#(n-4), this reported PMI cannot be applied at the eNB downlink before SF#(n+4)					

**Table 8.2.1.4.2-2: Minimum performance Multi-Layer Spatial Multiplexing (FRC)**

Test	Bandwidth and MCS	Reference Channel	Propagation Condition	Correlation Matrix and Antenna Configuration	Reference value		UE Category
					Fraction of Maximum Throughput (%)	SNR (dB)	
[5.1]	10 MHz 16QAM 1/2	[R.11 FDD]	EVA5	2x2 Low	70	12.9	
[5.2]	10 MHz 16QAM 1/2	[R.11 FDD]	ETU70	2x2 Low	70	14.3	
[5.3]	10 MHz 16 Q A M 1/ 2	[R.14 FDD]	EVA5	4x2 Low	70	10.5	

8.2.1.5 MU-MIMO

8.2.1.6 [Control channel performance: D-BCH and PCH]

8.2.2 TDD (Fixed Reference Channel)

The parameters specified in Table 8.2.2-1 are valid for all TDD tests unless otherwise stated.

**Table 8.2.2-1: Common Test Parameters (TDD)**

Parameter		Value
Uplink downlink configuration (Note 1)		1
Special subframe configuration (Note 2)		4
Cyclic prefix		Normal
Inter-TTI Distance		1
Number of HARQ processes	Processes	7
Maximum number of HARQ transmission		4
Redundancy version coding sequence		{0,1,2,3} for QPSK and 16QAM {0,0,1,2} for 64QAM
Number of OFDM symbols for PDCCH	OFDM symbols	4 for 1.4 MHz bandwidth, 3 for 3 MHz and 5 MHz bandwidths, 2 for 10 MHz, 15 MHz and 20 MHz bandwidths
Cyclic Prefix		Normal
Note 1: as specified in Table 4.2-2 in [TS 36.211]		
Note 2: as specified in Table 4.2-1 in [TS 36.211]		

### 8.2.2.1 Single-antenna port performance

The single-antenna performance in a given multi-path fading environments is determined by the SNR for which a certain relative information bit throughput of the reference measurement channels in Annex A.3.2 is achieved. The purpose of these tests is to verify the single-antenna performance with different channel models and MCS. The QPSK and 64QAM cases are also used to verify the performance for all bandwidths specified in Table 5.6.1-1.

#### 8.2.2.1.1 Minimum Requirement QPSK

The requirements are specified in Table 8.2.2.1.1-2, with the addition of the parameters in Table 8.2.2.1.1-1 and the downlink physical channel setup according to table [in Annex C.3.2].

**Table 8.2.2.1.1-1: Test Parameters for Testing QPSK**

Parameter	Unit	Test [1.1-1.4,2.1]
Downlink power allocation	$\rho_A$	dB
	$\rho_B$	dB
$N_{oc}$ at antenna port	dBm/15kHz	-98
Note 1: $P_B = 0$		

**Table 8.2.2.1.1-2: Minimum performance QPSK (FRC)**

Test number	Bandwidth	Reference Channel	Propagation Condition	Correlation Matrix and Antenna Configuration	Reference value		UE Category
					Fraction of Maximum Throughput (%)	SNR (dB)	
[1.1]	10 MHz	[R.2 TDD]	EVA5	1x2 Low	70	-1.2	
[1.2]	10 MHz	[R.2 TDD]	ETU70	1x2 Low	70	-0.6	
[1.3]	10 MHz	[R.2 TDD]	ETU300	1x2 Low	70	-0.2	
[1.4]	10 MHz	[R.2 TDD]	HST	1x2 Low	70	-2.6	
[2.1]	1.4 MHz	[R.4 TDD]	EVA5	1x2 Low	70	-0.5	

**8.2.2.1.2 Minimum Requirement 16QAM**

The requirements are specified in Table 8.2.2.1.2-1, with the addition of the parameters in Table 8.2.2.1.2-2 and the downlink physical channel setup according to table [in Annex C.3.2].

**Table 8.2.2.1.2-1: Test Parameters for Testing 16QAM**

Parameter	Unit	Test [1.5-1.7]
Downlink power allocation	$\rho_A$	dB
	$\rho_B$	dB
$N_{oc}$ at antenna port	dBm/15kHz	-98
Note 1: $P_B = 0$		

Table 8.2.2.1.2-2: Minimum performance 16QAM (FRC)

Test number	Bandwidth	Reference Channel	Propagation Condition	Correlation Matrix and Antenna Configuration	Reference value		UE Category
					Fraction of Maximum Throughput (%)	SNR (dB)	
[1.5]	10 MHz	[R.3 TDD]	EVA5	1x2 Low	70	6.7	
[1.6]	10 MHz	[R.3 TDD]	ETU70	1x2 Low	30	1.4	
[1.7]	10 MHz	[R.3 TDD]	ETU300	1x2 High	70	9.3	

8.2.2.1.3 Minimum Requirement 64QAM

The requirements are specified in Table 8.2.2.1.3-2, with the addition of the parameters in Table 8.2.2.1.3-1 and the downlink physical channel setup according to table [in Annex C.3.2].

**Table 8.2.2.1.3-1: Test Parameters for Testing 64QAM**

Parameter		Unit	Test [1.8-1.10,2.2-2.5]
Downlink power allocation	$\rho_A$	dB	0
	$\rho_B$	dB	0 (Note 1)
$N_{oc}$ at antenna port		dBm/15kHz	-98
Note 1: $P_B = 0$			

**Table 8.2.2.1.3-2: Minimum performance 64QAM (FRC)**

Test number	Bandwidth	Reference Channel	Propagation Condition	Correlation Matrix and Antenna Configuration	Reference value		UE Category
					Fraction of Maximum Throughput (%)	SNR (dB)	
[2.2]	3 MHz	[R.5 TDD]	EVA5	1x2 Low	70	17.6	
[2.3]	5 MHz	[R.6 TDD]	EVA5	1x2 Low	70	17.6	
[1.8]	10 MHz	[R.7 TDD]	EVA5	1x2 Low	70	17.6	
[1.9]	10 MHz	[R.7 TDD]	ETU70	1x2 Low	70	19.1	
[1.10]	10 MHz	[R.7 TDD]	EVA5	1x2 High	70	19.1	
[2.4]	15 MHz	[R.8 TDD]	EVA5	1x2 Low	70	17.8	
[2.5]	20 MHz	[R.9 TDD]	EVA5	1x2 Low	70	17.7	

**8.2.2.1.4 Minimum Requirement 1 PRB allocation**

The requirements are specified in Table 8.2.2.1.4-2, with the addition of the parameters in Table 8.2.2.1.1.4-1 and the downlink physical channel setup according to table [in Annex C.3.2]. The purpose of these tests is to verify the single-antenna performance with a single PRB allocated at the lower band edge.

**Table 8.2.2.1.4-1: Test Parameters for Testing 1 PRB allocation**

Parameter		Unit	Test [3.1-3.3]	Test [3.4]
Downlink power allocation	$\rho_A$	dB	0	0
	$\rho_B$	dB	0 (Note 1)	0 (Note 1)
$N_{oc}$ at antenna port		dBm/15kHz	-98	-98
Cell ID			0	0
Symbols for unused PRBs			OCNG (Note 2)	OCNG (Note 2)
Symbols for MBSFN portion of MBSFN subframes (Note 3)			-	OCNG (Note 4)
<p>Note 1: <math>P_B = 0</math></p> <p>Note 2: Each unused physical resource block (PRB) is assigned to an individual virtual UE. The data for each virtual UE shall be uncorrelated with data from other virtual UEs over the period of any measurement. The data shall be QPSK modulated.</p> <p>Note 3: The MBSFN portion of an MBSFN subframe comprises the whole MBSFN subframe except the first two symbols in the first slot.</p> <p>Note 4: The MBSFN portion of the MBSFN subframes shall contain QPSK modulated data. Cell-specific reference signals are not inserted in the MBSFN portion of the MBSFN subframes, QPSK modulated MBSFN data is used instead.</p>				

**Table 8.2.2.1.4-2: Minimum performance 1PRB (FRC)**

Test	Bandwidth and MCS	Reference Channel	OCNG	Propagation Condition	Correlation Matrix and Antenna Configuration	Reference value		UE
						Fraction of Maximum Throughput (%)	SNR	
[3.1]	3 MHz 16QAM 1/2	[R.0 TDD]	OP.1	ETU70	1x2 Low	30	2.1	
[3.2]	10 MHz 16QAM 1/2	[R.1 TDD]	OP.2	ETU70	1x2 Low	30	2.0	
[3.3]	20 MHz 16QAM 1/2	[R.1 TDD]	OP.3	ETU70	1x2 Low	30	2.1	
[3.4]	10 MHz 16QAM 1/2	[R.29 TDD]	OP.4	ETU70	1x2 Low	30	2.0	

### 8.2.2.2 Transmit diversity performance

The requirements are specified in Table 8.2.2.2-2, with the addition of the parameters in Table 8.2.2.2-1 and the downlink physical channel setup according to table [in Annex C.3.2]. The purpose is to verify the performance of transmit diversity (SFBC) with 2 and 4 transmitter antennas.

**Table 8.2.2.2-1: Test Parameters for Transmit diversity Performance (FRC)**

Parameter		Unit	Test [7.1-7-3]
Downlink power allocation	$\rho_A$	dB	-3
	$\rho_B$	dB	-3 (Note 1)
$N_{oc}$ at antenna port		dBm/15kHz	-98
Note 1: $P_B = 1$			

**Table 8.2.2.2-2: Minimum performance Transmit Diversity (FRC)**

Test number	Bandwidth and MCS	Reference Channel	Propagation Condition	Correlation Matrix and Antenna Configuration	Reference value		UE Category
					Fraction of Maximum Throughput (%)	SNR (dB)	
[7.1]	10 MHz 16QAM 1/2	[R.11 TDD]	EVA5	2x2 Medium	70	6.8	
[7.2]	10 MHz QPSK 1/3	[R.10 TDD]	HST	2x2 Low	70	-2.3	
[7.3]	1.4 MHz QPSK 1/3	[R.12 TDD]	EPA5	4x2 Medium	70	-0.2	

### 8.2.2.3 Open-loop spatial multiplexing performance

The requirements are specified in Table 8.2.2.3-2, with the addition of the parameters in Table 8.2.2.3-1 and the downlink physical channel setup according to table [in Annex C.3.2]. The purpose is to verify the performance of large delay CDD with 2 and 4 transmitter antennas.

**Table 8.2.2.3-1: Test Parameters for Large Delay CDD (FRC)**

Parameter	Unit	Test [6.1]	Test [6.2]	
Downlink power allocation	$\rho_A$	dB	-3	-6
	$\rho_B$	dB	-3 (Note 1)	-6 (Note 1)
$N_{oc}$ at antenna port	dBm/15kHz	-98	-98	
Note 1: $P_B = 1$				



Table 8.2.2.3-2: Minimum performance Large Delay CDD (FRC)

Test	Bandwidth and MCS	Reference Channel	Propagation Condition	Correlation Matrix and Antenna Configuration	Reference value		UE Category
					Fraction of Maximum Throughput (%)	SNR (dB)	
[6.1]	10 MHz 16QAM 1/2	[R.11 TDD]	EVA70	2x2 Low	70	13.1	
[6.2]	10 MHz 16QAM 1/2	[R.14 TDD]	EVA70	4x2 Low	70	14.2	

## 8.2.2.4 Closed-loop spatial multiplexing performance

### 8.2.2.4.1 Minimum Requirement Single-Layer Spatial Multiplexing

The requirements are specified in Table 8.2.2.4.1-2, with the addition of the parameters in Table 8.2.2.4.1-1 and the downlink physical channel setup according to table [in Annex C.3.2]. The purpose of these tests is to verify the closed loop rank-one performance with wideband and frequency selective precoding.

**Table 8.2.2.4.1-1: Test Parameters for Single-Layer Spatial Multiplexing (FRC)**

Parameter		Unit	Test [4.1]	Test [4.2]	Test [4.3]
Downlink power allocation	$\rho_A$	dB	-3	-3	-6
	$\rho_B$	dB	-3 (Note 1)	-3 (Note 1)	-6 (Note 1)
$N_{oc}$ at antenna port		dBm/15kHz	-98	-98	-98
Precoding granularity		PRB	6	50	6
Minimum PMI delay (Note 2)		ms	8	8	8
Reporting interval		ms	TBD	TBD	TBD
Reporting mode			PUSCH 1-2	PUSCH 3-1	PUSCH 1-2
Note 1: $P_B = 1$ Note 2: If the UE reports in an available uplink reporting instance at subframe SF#n based on PMI estimation at a downlink SF not later than SF#(n-4), this reported PMI cannot be applied at the eNB downlink before SF#(n+4)					

**Table 8.2.2.4.1-2: Minimum performance Single-Layer Spatial Multiplexing (FRC)**

Test	Bandwidth and MCS	Reference Channel	Propagation Condition	Correlation Matrix and Antenna Configuration	Reference value		UE Category
					Fraction of Maximum Throughput (%)	SNR (dB)	
[4.1]	10 MHz QPSK 1/3	[R.10 TDD]	EVA5	2x2 Low	70	-3.1	
[4.2]	10 MHz QPSK 1/3	[R.10 TDD]	EPA5	2x2 High	70	-3.3	
[4.3]	10 MHz QPSK 1/3	[R.13 TDD]	EVA5	4x2 Low	70	-3.7	

**8.2.2.4.2 Minimum Requirement Multi-Layer Spatial Multiplexing**

The requirements are specified in Table 8.2.2.4.2-2, with the addition of the parameters in Table 8.2.2.4.2-1 and the downlink physical channel setup according to table [in Annex C.3.2]. The purpose of these tests is to verify the closed loop rank-two performance with wideband and frequency selective precoding.

**Table 8.2.2.4.2-1: Test Parameters for Multi-Layer Spatial Multiplexing (FRC)**

Parameter	Unit	Test [5.1]	Test [5.2]	Test [5.3]	
Downlink power allocation	$\rho_A$	dB	-3	-3	-6
	$\rho_B$	dB	-3 (Note 1)	-3 (Note 1)	-6 (Note 1)
$N_{oc}$ at antenna port	dBm/15kHz	-98	-98	-98	
Precoding granularity	PRB	50	50	6	
PMI delay (Note 2)	ms	8	8	8	
Reporting interval	ms	TBD	TBD	TBD	
Reporting mode		PUSCH 1-2	PUSCH 3-1	PUSCH 1-2	
Note 1: $P_B = 1$ Note 2: If the UE reports in an available uplink reporting instance at subframe SF#n based on PMI estimation at a downlink SF not later than SF#(n-4), this reported PMI cannot be applied at the eNB downlink before SF#(n+4)					

**Table 8.2.2.4.2-2: Minimum performance Multi-Layer Spatial Multiplexing (FRC)**

Test	Bandwidth	Reference Channel	Propagation Condition	Correlation Matrix and Antenna Configuration	Reference value		UE Category
					Fraction of Maximum Throughput (%)	SNR (dB)	
[5.1]	10 MHz 16QAM 1/2	[R.11 TDD]	EVA5	2x2 Low	70	12.8	
[5.2]	10 MHz 16QAM 1/2	[R.11 TDD]	ETU70	2x2 Low	70	13.9	
[5.3]	10 MHz 16QAM 1/2	[R.14 TDD]	EVA5	4x2 Low	70	10.7	

8.2.2.5 MU-MIMO

8.2.2.6 [Control channel performance: D-BCH and PCH]

8.3 Demodulation of PDSCH (User-Specific Reference Symbols)

8.3.1 FDD

[TBD]

8.3.2 TDD

The parameters specified in Table 8.3.2-1 are valid for TDD unless otherwise stated.

**Table 8.3.2-1: Common Test Parameters for DRS**

Parameter	Unit	Value
Uplink downlink configuration (Note 1)		1
Special subframe configuration (Note 2)		4
Cyclic prefix		Normal
Inter-TTI Distance		1
Number of HARQ processes	Processes	7
Maximum number of HARQ transmission		4
Redundancy version coding sequence		{0,1,2,3} for QPSK and 16QAM {0,0,1,2} for 64QAM
Number of OFDM symbols for PDCCH	OFDM symbols	2
Precoder update granularity		Frequency domain: 1 PRB Time domain: 1 ms
Propagation conditions		As specified in section B.2.X.X
Note 1: as specified in Table 4.2-2 in [TS 36.211]		
Note 2: as specified in Table 4.2-1 in [TS 36.211]		

The requirements are specified in Table 8.3.2-3, with the addition of the parameters in Table 8.3.2-2 and the downlink physical channel setup according to table [in Annex C.3.2]. The purpose is to verify the demodulation performance using user-specific reference signals with full RB or single RB allocation.

**Table 8.3.2-2: Test Parameters for Testing DRS**

parameter	Unit	Test [11.1]	Test [11.2]	Test [11.3]	Test [11.4]	
Downlink power allocation	$\rho_A$	dB	0	0	0	0
	$\rho_B$	dB	0 (Note 1)	0 (Note 1)	0 (Note 1)	0 (Note 1)
$N_{oc}$ at antenna port	dBm/15kHz	TBD	TBD	TBD	TBD	
Number of allocated resource blocks	PRB	50	50	50	1 (Note 2)	
Note 1: $P_B = 0$						
Note 2: Zeros shall be inserted for unused PRBs						

**Table 8.3.2-3: Minimum performance DRS (FRC)**

Test number	Bandwidth and MCS	Reference Channel	Propagation Condition	Correlation Matrix and Antenna Configuration	Reference value		UE Category
					Fraction of Maximum Throughput (%)	SNR (dB)	
[11.1]	10 MHz QPSK 1/3	[R.25 TDD]	EPA5	1x2 Low	70	-0.8	
[11.2]	10 MHz 16QAM 1/2	[R.26 TDD]	EPA5	1x2 Low	70	7.0	
[11.3]	10 MHz 64QAM 3/4	[R.27 TDD]	EPA5	1x2 Low	70	17.0	
[11.4]	10 MHz 16QAM 1/2	[R.28 TDD]	EPA5	1x2 Low	30	1.7	

## 8.4 Demodulation of PDCCH/PCFICH

The receiver characteristics of the PDCCH/PCFICH are determined by the probability of miss-detection of the Downlink Scheduling Grant (Pm-dsg). PDCCH and PCFICH are tested jointly, i.e. a miss detection of PCFICH implies a miss detection of PDCCH.

### 8.4.1 FDD

**Table 8.4.1-1: Test Parameters for PDCCH/PCFICH**

Parameter		Unit	Test [8.1]	Test [8.2,8.3]	
Number of PDCCH symbols		symbols	2	2	
Number of PHICH groups ( $N_g$ )			1	1	
PHICH duration			Normal	Normal	
Cell ID			0	0	
Downlink power allocation	PCFICH_RA PDCCH_RA PHICH_RA	dB	0	-3	
	PCFICH_RB PDCCH_RB PHICH_RB	dB	0	-3	
$N_{oc}$ at antenna port		dBm/15kHz	-98	-98	
Cyclic prefix			Normal	Normal	

#### 8.4.1.1 Single-antenna port performance

For the parameters specified in Table 8.4.1-1 the average probability of a missed downlink scheduling grant (Pm-dsg) shall be below the specified value in Table 8.4.1.1-1 [The downlink physical setup is in accordance with Annex C.3.2.]

**Table 8.4.1.1-1: Minimum performance PDCCH/PCFICH**

Test	Bandwidth	Aggregation level	Reference Channel	Propagation Condition	Antenna configuration and correlation Matrix	Reference value	
						Pm-dsg (%)	SNR (dB)
[8.1]	10 MHz	8 CCE	[R.15 FDD]	ETU70	1x2 Low	1	-1.7

#### 8.4.1.2 Transmit diversity performance

For the parameters specified in Table 8.4.1-1 the average probability of a missed downlink scheduling grant (Pm-dsg) shall be below the specified value in Table 8.4.1.2-1 [The downlink physical setup is in accordance with Annex C.3.2.]

**Table 8.4.1.2-1: Minimum performance PDCCH/PCFICH**

Test	Bandwidth	Aggregation level	Reference Channel	Propagation Condition	Antenna configuration and correlation Matrix	Reference value	
						Pm-dsg (%)	SNR (dB)
[8.2]	1.4 MHz	2 CCE	[R.16 FDD]	EPA5	2 x 2 Low	1	4.3
[8.3]	10 MHz	4 CCE	[R.17 FDD]	EVA5	4 x 2 Medium	1	0.9

### 8.4.2 TDD

**Table 8.4.2-1: Test Parameters for PDCCH/PCFICH**

Parameter		Unit	Test [8.1]	Test [8.2,8.3]	
Uplink downlink configuration (Note 1)			1	1	
Special subframe configuration (Note 2)			4	4	
Number of PDCCH symbols		symbols	2	2	
Number of PHICH groups ( $N_g$ )			1	1	
PHICH duration			Normal	Normal	
Cell ID			0	0	
Downlink power allocation	PCFICH_RA PDCCH_RA PHICH_RA	dB	0	-3	
	PDFICH_RB PDCCH_RB PDCCH_RB	dB	0	-3	
$N_{oc}$ at antenna port		dBm/15kHz	-98	-98	
Cyclic prefix			Normal	Normal	
Note 1: as specified in Table 4.2-2 in [TS 36.211]					
Note 2: as specified in Table 4.2-1 in [TS 36.211]					

#### 8.4.2.1 Single-antenna port performance

For the parameters specified in Table 8.4.2-1 the average probability of a missed downlink scheduling grant (Pm-dsg) shall be below the specified value in Table 8.4.2.1-1 [The downlink physical setup is in accordance with Annex C.3.2.]

Table 8.4.2.1-1: Minimum performance PDCCH/PCFICH

Test	Bandwidth	Aggregation level	Reference Channel	Propagation Condition	Antenna configuration and correlation Matrix	Reference value	
						Pm-dsg (%)	SNR (dB)
[8.1]	10 MHz	8 CCE	[R.15 TDD]	ETU70	1x2 Low	1	-1.6

### 8.4.2.2 Transmit diversity performance

For the parameters specified in Table 8.4.2-1 the average probability of a missed downlink scheduling grant (Pm-dsg) shall be below the specified value in Table 8.4.2.2-1 [The downlink physical setup is in accordance with Annex C.3.2.]

Table 8.4.2.2-1: Minimum performance PDCCH/PCFICH

Test	Bandwidth	Aggregation level	Reference Channel	Propagation Condition	Antenna configuration and correlation Matrix	Reference value	
						Pm-dsg (%)	SNR (dB)
[8.2]	1.4 MHz	2 CCE	[R.16 TDD]	EPA5	2 x 2 Low	1	4.2
[8.3]	10 MHz	4 CCE	[R.17 TDD]	EVA5	4 x 2 Medium	1	1.2

## 8.5 Demodulation of PHICH

The receiver characteristics of the PHICH are determined by the probability of miss-detecting an ACK for a NACK (Pm-an). It is assumed that there is no bias applied to the detection of ACK and NACK (zero-threshold detection).

### 8.5.1 FDD

**Table 8.5.1-1: Test Parameters for PHICH**

Parameter		Unit	Test [10.1]	Test [10.2,10.3]
Downlink power allocation	PHICH_RA	dB	0	-3
	PHICH_RB	dB		
	PCFICH_RA	dB		
	PCFICH_RB	dB	0	-3
	PDCCH_RA	dB		
	PDCCH_RB	dB		
PHICH duration			Normal	Normal
Number of PHICH groups (Note 1)			Ng = 1	Ng = 1
PDCCH content			All PDCCH resources shall be occupied by non-zero data	
$N_{oc}$ at antenna port		dBm/15kHz	-98	-98
Cyclic prefix			Normal	Normal
Note 1: according to Clause 6.9 in [TS 36.211]				

#### 8.5.1.1 Single-antenna port performance

For the parameters specified in Table 8.5.1-1 the average probability of a miss-detecting ACK for NACK ( $P_{m-an}$ ) shall be below the specified value in Table 8.5.1.1-1 [The downlink physical setup is in accordance with Annex C.3.2.]

**Table 8.5.1.1-1: Minimum performance PHICH**

Test	Bandwidth	Reference	Propagation	Antenna configuration and correlation Matrix	Reference value	
					$P_{m-an}$ (%)	SNR (dB)
[9.1]	10 MHz	[R.18]	ETU70	1 x 2 Low	0.1	5.5
[9.4]	10 MHz	[R.24]	ETU70	1 x 2 Low	0.1	0.6

#### 8.5.1.2 Transmit diversity performance

For the parameters specified in Table 8.5.1-1 the average probability of a miss-detecting ACK for NACK ( $P_{m-an}$ ) shall be below the specified value in Table 8.5.1.2-1 [The downlink physical setup is in accordance with Annex C.3.2.]



Table 8.5.1.2-1: Minimum performance PHICH

Test	Bandwidth	Reference Channel	Propagation Condition	Antenna configuration and correlation Matrix	Reference value	
					Pm-an (%)	SNR (dB)
[9.2]	1.4 MHz	[R.19]	EPA5	2 x 2 Low	0.1	5.6
[9.3]	10 MHz	[R.20]	EVA5	4 x 2 Medium	0.1	6.0

## 8.5.2 TDD

Table 8.5.2-1: Test Parameters for PHICH

Parameter	Unit	Test [10.1]	Test [10.2,10.3]	
Uplink downlink configuration (Note 1)		1	1	
Special subframe configuration (Note 2)		4	4	
Downlink power allocation	PHICH_RA	0	-3	
	PHICH_RB			
	PCFICH_RA			
	PCFICH_RB	0	-3	
	PDCCH_RA			
	PDCCH_RB			
PHICH duration		Normal	Normal	
Number of PHICH groups (Note 3)		Ng = 1	Ng = 1	
PDCCH content		All PDCCH resources shall be occupied by non-zero data		
$N_{oc}$ at antenna port	dBm/15kHz	-98	-98	
Cyclic prefix		Normal	Normal	
Note 1:	as specified in Table 4.2-2 in [TS 36.211]			
Note 2:	as specified in Table 4.2-1 in [TS 36.211]			
Note 3:	according to Clause 6.9 in [TS 36.211]			

### 8.5.2.1 Single-antenna port performance

For the parameters specified in Table 8.5.2-1 the average probability of a miss-detecting ACK for NACK (Pm-an) shall be below the specified value in Table 8.5.2.1-1 [The downlink physical setup is in accordance with Annex C.3.2.]

**Table 8.5.2.1-1: Minimum performance PHICH**

Test	Bandwidth	Reference Channel	Propagation Condition	Antenna configuration and correlation Matrix	Reference value	
					Pm-an (%)	SNR (dB)
[9.1]	10 MHz	[R.18]	ETU70	1 x 2 Low	0.1	5.8
[9.4]	10 MHz	[R.24]	ETU70	1 x 2 Low	0.1	1.3

### 8.5.2.2 Transmit diversity performance

For the parameters specified in Table 8.5.2-1 the average probability of a miss-detecting ACK for NACK (Pm-an) shall be below the specified value in Table 8.5.2.2-1 [The downlink physical setup is in accordance with Annex C.3.2.]

**Table 8.5.2.2-1: Minimum performance PHICH**

Test	Bandwidth	Reference Channel	Propagation Condition	Antenna configuration and correlation Matrix	Reference value	
					Pm-an (%)	SNR (dB)
[9.2]	1.4 MHz	[R.19]	EPA5	2 x 2 Low	0.1	5.3
[9.3]	10 MHz	[R.20]	EVA5	4 x 2 Medium	0.1	6.1

## 8.6 Demodulation of PBCH

The receiver characteristics of the PBCH are determined by the probability of miss-detection of the PBCH (Pm-bch).

### 8.6.1 FDD

**Table 8.6.1-1: Test Parameters for PBCH**

Parameter		Unit	Test [10.1]	Test [10.2,10.3]	
Downlink power allocation	PBCH_RA	dB	0	-3	
	PBCH_RB	dB	0	-3	
$N_{oc}$ at antenna port		dBm/15kHz			
Cyclic prefix			Normal	Normal	
Note 1: as specified in Table 4.2-2 in [TS 36.211]					
Note 2: as specified in Table 4.2-1 in [TS 36.211]					

### 8.6.1.1 Single-antenna port performance

For the parameters specified in Table 8.6.1-1 the average probability of a miss-detecting PBCH (Pm-bch) shall be below the specified value in Table 8.6.1.1-1 [The downlink physical setup is in accordance with Annex C.3.2.]

**Table 8.6.1.1-1: Minimum performance PBCH**

Test	Bandwidth	Reference Channel	Propagation Condition	Antenna configuration and correlation Matrix	Reference value	
					Pm-bch (%)	SNR (dB)
[10.1]	1.4 MHz	[R.21]	ETU70	1 x 2 Low	1	-6.1

### 8.6.1.2 Transmit diversity performance

For the parameters specified in Table 8.6.1-1 the average probability of a miss-detected PBCH (Pm-bch) shall be below the specified value in Table 8.6.1.2-1 [The downlink physical setup is in accordance with Annex C.3.2.]

**Table 8.6.1.2-1: Minimum performance PBCH**

Test	Bandwidth	Reference Channel	Propagation Condition	Antenna configuration and correlation Matrix	Reference value	
					Pm-bch (%)	SNR (dB)
[10.2]	1.4 MHz	[R.22]	EPA5	2 x 2 Low	1	-4.8
[10.3]	1.4 MHz	[R.23]	EVA5	4 x 2 Medium	1	-3.5

## 8.6.2 TDD

**Table 8.6.2-1: Test Parameters for PBCH**

Parameter		Unit	Test [10.1]	Test [10.2,10.3]	
Uplink downlink configuration (Note 1)			1	1	
Special subframe configuration (Note 2)			4	4	
Downlink power allocation	PBCH_RA	dB	0	-3	
	PBCH_RB	dB	0	-3	
$N_{oc}$ at antenna port		dBm/15kHz			
Cyclic prefix			Normal	Normal	
Note 1: as specified in Table 4.2-2 in [TS 36.211]					
Note 2: as specified in Table 4.2-1 in [TS 36.211]					

### 8.6.2.1 Single-antenna port performance

For the parameters specified in Table 8.6.2-1 the average probability of a miss-detected PBCH (Pm-bch) shall be below the specified value in Table 8.6.2.1-1 [The downlink physical setup is in accordance with Annex C.3.2.]

**Table 8.6.2.1-1: Minimum performance PBCH**

Test	Bandwidth	Reference Channel	Propagation Condition	Antenna configuration and correlation Matrix	Reference value	
					Pm-bch (%)	SNR (dB)
[10.1]	1.4 MHz	[R.21]	ETU70	1 x 2 Low	1	-6.4

### 8.6.2.2 Transmit diversity performance

For the parameters specified in Table 8.6.2-1 the average probability of a miss-detected PBCH (Pm-bch) shall be below the specified value in Table 8.6.2.2-1 [The downlink physical setup is in accordance with Annex C.3.2.]

**Table 8.6.2.2-1: Minimum performance PBCH**

Test	Bandwidth	Reference Channel	Propagation Condition	Antenna configuration and correlation Matrix	Reference value	
					Pm-bch (%)	SNR (dB)
[10.2]	1.4 MHz	[R.22]	EPA5	2 x 2 Low	1	-4.8
[10.3]	1.4 MHz	[R.23]	EVA5	4 x 2 Medium	1	-4.1

## 9 Reporting of Channel State Information

### 9.1 General

This section includes requirements for the reporting of channel state information (CSI).

### 9.2 CQI reporting definition under AWGN conditions

The reporting accuracy of the channel quality indicator (CQI) under frequency non-selective conditions is determined by the reporting variance and the BLER performance using the transport format indicated by the reported CQI median. The purpose is to verify that the reported CQI values are in accordance with the CQI definition given in [TS 36.211].

## 9.2.1 Minimum requirement PUCCH 1-0

### 9.2.1.1 FDD

For the parameters specified in Table 9.2.1.1-1, and using the downlink physical channels specified in tables C.3.2-1 and C.3.2-2, the reported CQI value according to Table A.4-2 shall be in the range of  $\pm 1$  of the reported median more than 90% of the time. If the PDSCH BLER using the transport format indicated by median CQI is less than or equal to 0.1, the BLER using the transport format indicated by the (median CQI + 1) shall be greater than 0.1. If the PDSCH BLER using the transport format indicated by the median CQI is greater than 0.1, the BLER using transport format indicated by (median CQI – 1) shall be less than or equal to 0.1.

**Table 9.2.1.1-1: PUCCH 1-0 static test (FDD)**

Parameter	Unit	Test 1	Test 2
Bandwidth	MHz	10	
PDSCH transmission mode		1	
Downlink power allocation	$\rho_A$	dB	
	$\rho_B$	dB	
Propagation condition and antenna configuration		AWGN (1 x 2)	
SNR	dB	[0]	[6]
$N_{oc}^{(j)}$	dB[mW/15kHz]	-98	-98
$\hat{I}_{or}^{(j)}$	dB[mW/15kHz]	[-98]	[-92]
Max number of HARQ transmissions		1	
PUCCH Format		[Format 2]	
PUCCH Report Type		4	
Reporting periodicity	ms	$N_P = 5$ ms	
<i>cqi-pmi-ConfigurationIndex</i>		5	
NOTE 1: Reference measurement channel according to Clause A.4			

### 9.2.1.2 TDD

For the parameters specified in Table 9.2.1.2-1, and using the downlink physical channels specified in tables C.3.2-1 and C.3.2-2, the reported CQI value according to Table A.4-2 shall be in the range of  $\pm 1$  of the reported median more than 90% of the time. If the PDSCH BLER using the transport format indicated by median CQI is less than or equal to 0.1, the BLER using the transport format indicated by the (median CQI + 1) shall be greater than 0.1. If the PDSCH BLER using the transport format indicated by the median CQI is greater than 0.1, the BLER using transport format indicated by (median CQI – 1) shall be less than or equal to 0.1.

Table 9.2.1.2-1: PUCCH 1-0 static test (TDD)

Parameter		Unit	Test 1	Test 2
Bandwidth		MHz		10
PDSCH transmission mode				1
Uplink downlink configuration				1
Special subframe configuration				4
Downlink power allocation	$\rho_A$	dB		0
	$\rho_B$	dB		0
Propagation condition and antenna configuration			AWGN (1 x 2)	
SNR		dB	[0]	[6]
$N_{oc}^{(j)}$		dB[mW/15kHz]	-98	-98
$\hat{I}_{or}^{(j)}$		dB[mW/15kHz]	[-98]	[-92]
Max number of HARQ transmissions				1
PUCCH Format				[Format 2]
PUCCH Report Type				4
Reporting periodicity		ms		[ $N_p = 5$ ]
<i>cqi-pmi-ConfigurationIndex</i>				4
Note 1: Reference measurement channel according to Clause A.4				

## 9.2.2 Minimum requirement PUCCH 1-1

The minimum requirements for dual codeword transmission are defined in terms of a reporting spread of the wideband spatial differential CQI between codeword #0 and codeword #1, and their BLER performance using the transport format indicated by the reported CQI median of codeword #0 and codeword #1. The precoding used at the transmitter is a fixed precoding matrix specified by the bitmap parameter *codebookSubsetRestriction*. The propagation condition assumed for the minimum performance requirement is defined in subclause B.1.

### 9.2.2.1 FDD

For the parameters specified in table 9.2.2.1-1, and using the downlink physical channels specified in tables C.3.2-1 and C.3.2-2, the reported offset level of the wideband spatial differential CQI for codeword #1 (Table 7.2.2 in [TS 36.213]) shall be used to determine the wideband CQI index for codeword #1 as

$$\text{wideband CQI}_1 = \text{wideband CQI}_0 - \text{Codeword 1 offset level}$$

The wideband CQI<sub>1</sub> shall be within the set {median CQI<sub>1</sub> -1, median CQI<sub>1</sub> +1} for more than 90% of the time, where the resulting wideband values CQI<sub>1</sub> shall be used to determine the median CQI values for codeword #1. For both codewords #0 and #1, the PDSCH BLER using the transport format indicated by the respective median CQI<sub>0</sub> - 1 and median CQI<sub>1</sub> - 1 shall be less than or equal to 0.1. Furthermore, for both codewords #0 and #1, the PDSCH BLER using the transport format indicated by the respective median CQI<sub>0</sub> + 1 and median CQI<sub>1</sub> + 1 shall be greater than or equal to 0.1.

Table 9.2.2.1-1: PUCCH 1-1 static test (FDD)

Parameter	Unit	Test 1	Test 2
Bandwidth	MHz		10
PDSCH transmission mode			4
Downlink power allocation	$\rho_A$	dB	-3
	$\rho_B$	dB	-3
Propagation condition and antenna configuration		Clause B.1 (2 x 2)	
CodeBookSubsetRestriction bitmap		010000	
SNR	dB	[10]	[16]
$N_{oc}^{(j)}$	dB[mW/15kHz]	-98	-98
$\hat{I}_{or}^{(j)}$	dB[mW/15kHz]	[-88]	[-82]
Max number of HARQ transmissions		1	
PUCCH Format		[Format 2]	
PUCCH Report Type		2	
Reporting periodicity	ms	$N_p = 5$	
<i>cqi-pmi-ConfigurationIndex</i>		5	
<i>ri-ConfigurationInd</i>		[966 ( $M_{RI} = \text{OFF}$ )]	
Note 1: Reference measurement channel according to Clause A.4			

### 9.2.2.2 TDD

For the parameters specified in table 9.2.2.2-1, and using the downlink physical channels specified in tables C.3.2-1 and C.3.2-2, the reported offset level of the wideband spatial differential CQI for codeword #1 (Table 7.2.2 in [TS 36.213]) shall be used to determine the wideband CQI index for codeword #1 as

$$\text{wideband CQI}_1 = \text{wideband CQI}_0 - \text{Codeword 1 offset level}$$

The wideband  $\text{CQI}_1$  shall be within the set  $\{\text{median CQI}_1 - 1, \text{median CQI}_1 + 1\}$  for more than 90% of the time, where the resulting wideband values  $\text{CQI}_1$  shall be used to determine the median CQI values for codeword #1. For both codewords #0 and #1, the PDSCH BLER using the transport format indicated by the respective median  $\text{CQI}_0 - 1$  and median  $\text{CQI}_1 - 1$  shall be less than or equal to 0.1. Furthermore, for both codewords #0 and #1, the PDSCH BLER using the transport format indicated by the respective median  $\text{CQI}_0 + 1$  and median  $\text{CQI}_1 + 1$  shall be greater than or equal to 0.1.

Table 9.2.2.2-1: PUCCH 1-1 static test (TDD)

Parameter		Unit	Test 1	Test 2
Bandwidth		MHz		10
PDSCH transmission mode				4
Uplink downlink configuration				1
Special subframe configuration				4
Downlink power allocation	$\rho_A$	dB		-3
	$\rho_B$	dB		-3
Propagation condition and antenna configuration			Clause B.1 (2 x 2)	
CodeBookSubsetRestriction bitmap			010000	
SNR		dB	[10]	[16]
$N_{oc}^{(j)}$		dB[mW/15kHz]	-98	-98
$\hat{I}_{or}^{(j)}$		dB[mW/15kHz]	[-88]	[-82]
Max number of HARQ transmissions			1	
PUCCH Format			[Format 2]	
PUCCH Report Type			2	
Reporting periodicity		ms	$N_P = 5$	
<i>cqi-pmi-ConfigurationIndex</i>			4	
<i>ri-ConfigurationInd</i>			[966 ( $M_{RI} = \text{OFF}$ )]	
Note 1: Reference measurement channel according to Clause A.4				
NOTE: Reference measurement channel as per TS 36.213 Section 7.2.3				

## 9.3 CQI reporting under fading conditions

### 9.3.1 Frequency-selective scheduling mode

The accuracy of sub-band channel quality indicator (CQI) reporting under frequency selective fading conditions is determined by a double-sided percentile of the reported differential CQI offset level 0 per sub-band, and the relative increase of the throughput obtained when transmitting on any one of the sub-bands with the highest reported differential CQI offset level the corresponding transport format compared to the case for which a fixed format is transmitted on any sub-band in set  $S$  [36.213]. The purpose is to verify that preferred sub-bands can be used for frequently-selective scheduling.

#### 9.3.1.1 Minimum requirement PUSCH 3-0

##### 9.3.1.1.1 FDD

For the parameters specified in Table 9.3.1.1.1-1, [and using the downlink physical channels specified in Annex C,] the minimum requirements are specified in Table 9.3.1.1.1-2 and by the following

- a sub-band differential CQI offset level of 0 shall be reported at least  $\alpha\%$  of the time but less than  $\beta\%$  for each sub-band;
- the ratio of the throughput obtained when transmitting on any one of the sub-bands with the highest differential CQI offset level the corresponding TBS and that obtained when transmitting the TBS indicated by the reported wideband CQI median on a randomly selected sub-band in set  $S$  shall be  $\geq \gamma$ ;
- [BLER requirement]

[Editors note: use of requirement(c) is TBD]



The requirements only apply for sub-bands of full size and the random scheduling across the sub-bands is done by selecting a new sub-band in each TTI for FDD, each available downlink transmission instance for TDD. The transport block size TBS(wideband CQI median) is that resulting from the code rate which is closest to that indicated by the wideband CQI median and the  $N_{PRB}$  entry in Table 7.1.7.2.1-1 [TS 36.213] that corresponds to the sub-band size.

**Table 9.3.1.1.1-1 Sub-band test for single antenna transmission (FDD)**

Parameter	Unit	Test 1	Test 2
Bandwidth	MHz	10 MHz	
Transmission mode		1 (port 0)	
SNR	dB	[9]	[14]
$N_{oc}^{(j)}$	dB[mW/15kHz]	[-98]	[-98]
$\hat{I}_{or}^{(j)}$	dB[mW/15kHz]	[-89]	[-84]
Propagation channel		[Clause B.2.4 with $\tau_d = 0.45 \mu s$ , $a = 1$ , $f_D = 5$ Hz]	
Correlation		[Full]	
Reporting interval	ms	[5]	
CQI delay	ms	8	
Reporting mode		PUSCH 3-0	
Max number of HARQ transmissions		[1]	
Note 1: If the UE reports in an available uplink reporting instance at subframe SF#n based on CQI estimation at a downlink subframe not later than SF#(n-4), this reported subband or wideband CQI cannot be applied at the eNB downlink before SF#(n+4)			

**Table 9.3.1.1.1-2 Minimum requirement (FDD)**

	Test 1	Test 2	
$\alpha$ [%]	TBD	TBD	
$\beta$ [%]	TBD	TBD	
$\gamma$	TBD	TBD	

### 9.3.1.1.2 TDD

For the parameters specified in Table 9.3.1.1.2-1, [and using the downlink physical channels specified in Annex C,] the minimum requirements are specified in Table 9.3.1.1.2-2 and by the following

- a sub-band differential CQI offset level of 0 shall be reported at least  $\alpha$ % of the time but less than  $\beta$ % for each sub-band;
- the ratio of the throughput obtained when transmitting on any one of the sub-bands with the highest differential CQI offset level the corresponding TBS and that obtained when transmitting the TBS indicated by the reported wideband CQI median on a randomly selected sub-band in set  $S$  shall be  $\geq \gamma$ ;
- [BLER requirement]

[Editors note: details of additional requirements (c) is TBD]

The requirements only apply for sub-bands of full size and the random scheduling across the sub-bands is done by selecting a new sub-band in each TTI for FDD, each available downlink transmission instance for TDD. The transport block size TBS (wideband CQI median) is that resulting from the code rate which is closest to that indicated by the wideband CQI median and the  $N_{PRB}$  entry in Table 7.1.7.2.1-1 [TS 36.213] that corresponds to the sub-band size.

**Table 9.3.1.1.2-1 Sub-band test for single antenna transmission (TDD)**

Parameter	Unit	Test 1	Test 2
Bandwidth	MHz	10 MHz	
Transmission mode		1 (port 0)	
Uplink downlink configuration		1	
Special subframe configuration		4	
SNR	dB	[9]	[14]
$N_{oc}^{(j)}$	dB[mW/15kHz]	[-98]	[-98]
$\hat{I}_{or}^{(j)}$	dB[mW/15kHz]	[-89]	[-84]
Propagation channel		[Clause B.2.4 with $\tau_d = 0.45 \mu s$ , $a = 1$ , $f_D = 5$ Hz]	
Correlation		[Full]	
Reporting interval	ms	[5]	
Minimum CQI delay	ms	8	
Reporting mode		PUSCH 3-0	
Max number of HARQ transmissions		[1]	
Note 1: If the UE reports in an available uplink reporting instance at subframe SF#n based on CQI estimation at a downlink subframe not later than SF#(n-4), this reported subband or wideband CQI cannot be applied at the eNB downlink before SF#(n+4)			

**Table 9.3.1.1.2-2 Minimum requirement (TDD)**

	Test 1	Test 2	
$\alpha$ [%]	TBD	TBD	
$\beta$ [%]	TBD	TBD	
$\gamma$	TBD	TBD	

## 9.3.2 Frequency non-selective scheduling mode

The reporting accuracy of the channel quality indicator (CQI) under frequency non-selective fading conditions is determined by a double-sided percentile of the reported CQI, and the relative increase of the throughput obtained when the transport format transmitted is that indicated by the reported CQI compared to the case for which a fixed transport format configured according to the reported median CQI is transmitted. In addition, the reporting accuracy is determined by a minimum BLER using the transport formats indicated by the reported CQI. The purpose is to verify that the UE is tracking the channel variations and selecting the largest transport format possible according to the prevailing channel state for frequently non-selective scheduling.

### 9.3.2.1 Minimum requirement PUCCH 1-0

#### 9.3.2.1.1 FDD

For the parameters specified in Table 9.3.2.1.1-1, [and using the downlink physical channels specified in Annex C,] the minimum requirements are specified in Table 9.3.2.1.1-2 and by the following

- a CQI index not in the set {median CQI -1, median CQI +1} shall be reported at least  $\alpha$ % of the time;
- the ratio of the throughput obtained when transmitting the transport format indicated by each reported wideband CQI index and that obtained when transmitting a fixed transport format configured according to the wideband CQI median shall be  $\geq \gamma$ ;
- when transmitting the transport format indicated by each reported wideband CQI index, the average BLER for the indicated transport formats shall be greater or equal to TBD

The transport block size TBS(wideband CQI median) is that resulting from the code rate which is closest to that indicated by the wideband CQI median and the  $N_{PRB}$  entry in Table 7.1.7.2.1-1 [36.213] that corresponds to the maximum transmission configuration (Table 5.6-1).

**Table 9.3.2.1.1-1 Fading test for single antenna (FDD)**

Parameter	Unit	Test 1	Test 2
Bandwidth	MHz	10 MHz	
Transmission mode		1 (port 0)	
SNR	dB	6	12
$N_{oc}^{(j)}$	dB[mW/15kHz]	-98	-98
$\hat{I}_{or}^{(j)}$	dB[mW/15kHz]	-92	-86
Propagation channel		EPA5	
Correlation		High	
Reporting mode		PUCCH 1-0	
Reporting periodicity	ms	[ $N_p = 2$ ]	
CQI delay	ms	8	
PUCCH Format		[Format 2]	
PUCCH Report Type		4	
<i>cqi-pmi-ConfigurationIndex</i>		[1]	
Max number of HARQ transmissions		1	
Note 1: If the UE reports in an available uplink reporting instance at subframe SF#n based on CQI estimation at a downlink SF not later than SF#(n-4), this reported wideband CQI cannot be applied at the eNB downlink before SF#(n+4)			

**Table 9.3.2.1.1-2 Minimum requirement (FDD)**

	Test 1	Test 2	
$\alpha$ [%]	[20]	[20]	
$\gamma$	TBD	TBD	

### 9.3.2.1.2 TDD

For the parameters specified in Table 9.3.2.1.2-1, [and using the downlink physical channels specified in Annex C,] the minimum requirements are specified in Table 9.3.2.1.2-2 and by the following

- a CQI index not in the set {median CQI -1, median CQI +1} shall be reported at least  $\alpha$ % of the time;
- the ratio of the throughput obtained when transmitting the transport format indicated by each reported wideband CQI index and that obtained when transmitting a fixed transport format configured according to the wideband CQI median shall be  $\geq \gamma$ ;
- when transmitting the transport format indicated by each reported wideband CQI index, the average BLER for the indicated transport formats shall be greater or equal to TBD

The transport block size TBS(wideband CQI median) is that resulting from the code rate which is closest to that indicated by the wideband CQI median and the  $N_{PRB}$  entry in Table 7.1.7.2.1-1 [36.213] that corresponds to the maximum transmission configuration (Table 5.6-1).

**Table 9.3.2.1.2-1 Fading test for single antenna (TDD)**

Parameter	Unit	Test 1	Test 2
Bandwidth	MHz	10 MHz	
Transmission mode		1 (port 0)	
Uplink downlink configuration		1	
Special subframe configuration		4	
SNR	dB	6	12
$N_{oc}^{(j)}$	dB[mW/15kHz]	-98	-98
$\hat{I}_{or}^{(j)}$	dB[mW/15kHz]	-92	-86
Propagation channel		EPA5	
Correlation		High	
Reporting mode		PUCCH 1-0	
Reporting periodicity	ms	[ $N_p = 1$ ]	
Minimum CQI delay	ms	8	
PUCCH Format		[Format 2]	
PUCCH Report Type		4	
<i>cqi-pmi-ConfigurationIndex</i>		[0]	
Max number of HARQ transmissions		1	
Note 1: If the UE reports in an available uplink reporting instance at subframe SF#n based on CQI estimation at a downlink SF not later than SF#(n-4), this reported wideband CQI cannot be applied at the eNB downlink before SF#(n+4)			

**Table 9.3.2.1.2-2 Minimum requirement (TDD)**

	Test 1	Test 2	
$\alpha$ [%]	[20]	[20]	
$\gamma$	TBD	TBD	

## 9.4 Reporting of Precoding Matrix Indicator (PMI)

The minimum performance requirements of PMI reporting are defined based on the precoding gain, expressed as the relative increase in throughput when the transmitter is configured according to the UE reports compared to the case when the transmitter is using random precoding, respectively. Transmission mode [6] is used with a fixed transport format (FRC) configured. The requirements are specified in terms of the ratio

$$\gamma = \frac{t_{ue}}{t_{rnd}}$$

where  $t_{rnd}$  is 60% of the maximum throughput obtained at  $SNR_{rnd}$  using random precoding, and  $t_{ue}$  the throughput measured at  $SNR_{rnd}$  with precoders configured according to the UE reports.

### 9.4.1 Single PMI

#### 9.4.1.1 Minimum requirement PUSCH 3-1

##### 9.4.1.1.1 FDD

For the parameters specified in Table 9.4.1.1.1-1, [and using the downlink physical channels specified in Annex C,] the minimum requirements are specified in Table 9.4.1.1.1-2.

**Table 9.4.1.1.1-1 PMI test for single-layer (FDD)**

Parameter	Unit	Test 1	Test 2
Bandwidth	MHz	10	
Transmission mode		6	
Propagation channel		EVA5	
Precoding granularity		50	
Correlation and antenna configuration		Low 2 x 2	
$N_{oc}^{(j)}$	dB[mW/15kHz]	-98	
Reporting mode		PUSCH 3-1	
Reporting interval	ms	[1]	
PMI delay (Note 2)	ms	8	
Measurement channel		[R.2 FDD]	
Max number of HARQ transmissions		4	
Note 1: For random precoder selection, the precoder shall be updated in each TTI (1 ms granularity) Note 2: If the UE reports in an available uplink reporting instance at subframe SF#n based on PMI estimation at a downlink SF not later than SF#(n-4), this reported PMI cannot be applied at the eNB downlink before SF#(n+4).			

**Table 9.4.1.1.1-2 Minimum requirement (FDD)**

	Test 1	Test 2
$\gamma$	[1.1]	

#### 9.4.1.1.2 TDD

For the parameters specified in Table 9.4.1.1.2-1, [and using the downlink physical channels specified in Annex C,] the minimum requirements are specified in 9.4.1.1.2-2.

**Table 9.4.1.1.2-1 PMI test for single-layer (TDD)**

Parameter	Unit	Test 1	Test 2
Bandwidth	MHz	10	
Transmission mode		6	
Uplink downlink configuration		1	
Special subframe configuration		4	
Propagation channel		EVA5	
Precoding granularity		50	
Correlation and antenna configuration		Low 2 x 2	
$N_{oc}^{(j)}$	dB[mW/15kHz]	-98	
Reporting mode		PUSCH 3-1	
Reporting interval	ms	[1]	
Minimum PMI delay (Note 2)	ms	8	
Measurement channel		[R.2 TDD]	
Max number of HARQ transmissions		4	
Note 1: For random precoder selection, the precoder shall be updated in each available downlink transmission instance Note 2: If the UE reports in an available uplink reporting instance at subframe SF#n based on PMI estimation at a downlink SF not later than SF#(n-4), this reported PMI cannot be applied at the eNB downlink before SF#(n+4)			

**Table 9.4.1.1.2-2 Minimum requirement (TDD)**

	Test 1	Test 2
$\gamma$	[1.1]	

## 9.4.2 Multiple PMI

### 9.4.2.1 Minimum requirement PUSCH 1-2

#### 9.4.2.1.1 FDD

For the parameters specified in Table 9.4.2.1.1-1, [and using the downlink physical channels specified in Annex C,] the minimum requirements are specified in 9.4.2.1.1-2.

**Table 9.4.2.1.1-1 PMI test for single-layer (FDD)**

Parameter	Unit	Test 1	Test 2
Bandwidth	MHz	20	
Transmission mode		6	
Propagation channel		EPA5	
Precoding granularity		8	
Correlation and antenna configuration		Low 2 x 2	
$N_{oc}^{(j)}$	dB[mW/15kHz]	-98	
Reporting mode		PUSCH 1-2	
Reporting interval	ms	[1]	
PMI delay	ms	8	
Measurement channel		[16QAM 1/2]	
Max number of HARQ transmissions		4	
Note 1: For random precoder selection, the precoders shall be updated in each TTI (1 ms granularity) Note 2: If the UE reports in an available uplink reporting instance at subframe SF#n based on PMI estimation at a downlink SF not later than SF#(n-4), this reported PMI cannot be applied at the eNB downlink before SF#(n+4)			

**Table 9.4.2.1.1-2 Minimum requirement (FDD)**

	Test 1	Test 2
$\gamma$	[1.2]	

#### 9.4.2.1.2 TDD

For the parameters specified in Table 9.4.2.1.2-1, [and using the downlink physical channels specified in Annex C,] the minimum requirements are specified in 9.4.2.1.2-2.

**Table 9.4.2.1.2-1 PMI test for single-layer (TDD)**

Parameter	Unit	Test 1	Test 2
Bandwidth	MHz	20	
Transmission mode		6	
Uplink downlink configuration		1	
Special subframe configuration		4	
Propagation channel		EPA5	
Precoding granularity		8	
Correlation and antenna configuration		Low 2 x 2	
$N_{oc}^{(j)}$	dB[mW/15kHz]	-98	
Reporting mode		PUSCH 1-2	
Reporting interval	ms	[1]	
Minimum PMI delay	ms	8	
Measurement channel		[16QAM 1/2]	
Max number of HARQ transmissions		4	
Note 1:	For random precoder selection, the precoders shall be updated in each available downlink transmission instance		
Note 2:	If the UE reports in an available uplink reporting instance at subframe SF#n based on PMI estimation at a downlink SF not later than SF#(n-4), this reported PMI cannot be applied at the eNB downlink before SF#(n+4)		

**Table 9.4.2.1.2-2 Minimum requirement (TDD)**

	Test 1	Test 2
$\gamma$	[1.2]	



---

## Annex A (normative): Measurement channels

### A.1 General

---

## A.2 UL reference measurement channels

### A.2.1 General

#### A.2.1.1 Applicability and common parameters

The following sections define the UL signal applicable to the Transmitter Characteristics (clause 6) and for the Receiver Characteristics (clause 7) where the UL signal is relevant.

The Reference channels in this section assume transmission of PUSCH and Demodulation Reference signal only. The following conditions apply:

- 1 HARQ transmission
- Cyclic Prefix normal
- PUSCH hopping off
- Link adaptation off
- Demodulation Reference signal as per TS 36.211 [4] subclause 5.5.2.1.2.

Where ACK/NACK is transmitted, it is assumed to be multiplexed on PUSCH as per TS 36.212 [5] subclause 5.2.2.6.

- ACK/NACK 1 bit
- ACK/NACK mapping adjacent to Demodulation Reference symbol
- ACK/NACK resources punctured into data
- Max number of resources for ACK/NACK: 4 SC-FDMA symbols per subframe
- No CQI transmitted, no RI transmitted

#### A.2.1.2 Determination of payload size

The algorithm for determining the payload size  $A$  is as follows; given a desired coding rate  $R$  and radio block allocation  $N_{RB}$

1. Calculate the number of channel bits  $N_{ch}$  that can be transmitted during the first transmission of a given sub-frame.
2. Find  $A$  such that the resulting coding rate is as close to  $R$  as possible, that is,

$$\min |R - (A + 24) / N_{ch}|,$$

subject to

- a)  $A$  is a valid TB size according to section 7.1.7 of TS 36.213 [6] assuming an allocation of  $N_{RB}$  resource blocks.
- b) Segmentation is not included in this formula, but should be considered in the TBS calculation.
- c) For RMC-s, which at the nominal target coding rate do not cover all the possible UE categories for the given modulation, reduce the target coding rate gradually (within the same modulation), until the maximal possible number of UE categories is covered.

3. If there is more than one  $A$  that minimises the equation above, then the larger value is chosen per default.

## A.2.2 Reference measurement channels for FDD

### A.2.2.1 Full RB allocation

#### A.2.2.1.1 QPSK

**Table A.2.2.1.1-1 Reference Channels for QPSK with full RB allocation**

Parameter	Unit	Value					
<b>Channel bandwidth</b>	MHz	1.4	3	5	10	15	20
<b>Allocated resource blocks</b>		<b>6</b>	<b>15</b>	<b>25</b>	<b>50</b>	<b>75</b>	<b>100</b>
<b>DFT-OFDM Symbols per subframe</b>		<b>12</b>	<b>12</b>	<b>12</b>	<b>12</b>	<b>12</b>	<b>12</b>
<b>Modulation</b>		<b>QPS</b>	<b>QPS</b>	<b>QPS</b>	<b>QPS</b>	<b>QPS</b>	<b>QPS</b>
		<b>K</b>	<b>K</b>	<b>K</b>	<b>K</b>	<b>K</b>	<b>K</b>
<b>Target Coding rate</b>		<b>1/3</b>	<b>1/3</b>	<b>1/3</b>	<b>1/3</b>	<b>1/5</b>	<b>1/6</b>
<b>Payload size</b>	Bits	<b>600</b>	<b>1544</b>	<b>2216</b>	<b>5160</b>	<b>4392</b>	<b>4584</b>
<b>Transport block CRC</b>	Bits	<b>24</b>	<b>24</b>	<b>24</b>	<b>24</b>	<b>24</b>	<b>24</b>
<b>Number of code blocks - C</b>		<b>1</b>	<b>1</b>	<b>1</b>	<b>1</b>	<b>1</b>	<b>1</b>
<b>Code block CRC size</b>	Bits	<b>0</b>	<b>0</b>	<b>0</b>	<b>0</b>	<b>0</b>	<b>0</b>
<b>Total number of bits per sub-frame</b>	Bits	<b>1728</b>	<b>4320</b>	<b>7200</b>	<b>14400</b>	<b>21600</b>	<b>28800</b>
<b>Total symbols per sub-frame</b>		<b>864</b>	<b>2160</b>	<b>3600</b>	<b>7200</b>	<b>10800</b>	<b>14400</b>
<b>UE Category</b>		<b>1-5</b>	<b>1-5</b>	<b>1-5</b>	<b>1-5</b>	<b>1-5</b>	<b>1-5</b>

## A.2.2.1.2 16-QAM

Table A.2.2.1.2-1 Reference Channels for 16-QAM with full RB allocation

Parameter	Unit	Value					
Channel bandwidth	MHz	1.4	3	5	10	15	20
Allocated resource blocks		6	15	25	50	75	100
DFT-OFDM Symbols per subframe		12	12	12	12	12	12
Modulation		16QAM	16QAM	16QAM	16QAM	16QAM	16QAM
Target Coding rate		3/4	1/2	1/3	3/4	1/2	1/3
Payload size	Bits	2600	4264	4968	21384	21384	19848
Transport block CRC	Bits	24	24	24	24	24	24
Number of code blocks - C		1	1	1	4	4	4
Code block CRC size	Bits	0	0	0	24	24	24
Total number of bits per sub-frame	Bits	3456	8640	14400	28800	43200	57600
Total symbols per sub-frame		864	2160	3600	7200	10800	14400
UE Category		1-5	1-5	1-5	2-5	2-5	2-5

## A.2.2.1.3 64-QAM

[FFS]

## A.2.2.2 Partial RB allocation

For each channel bandwidth, various partial RB allocations are specified. The number of allocated RBs is chosen according to values specified in the Tx and Rx requirements. The single allocated RB case is included.

The allocated RBs are contiguous and start from one end of the channel bandwidth. A single allocated RB is at one end of the channel bandwidth.

## A.2.2.2.1 QPSK

Table A.2.2.2.1-1 Reference Channels for 1.4MHz QPSK with partial RB allocation

Parameter	Unit	Value	Value
Channel bandwidth	MHz	1.4	1.4
Allocated resource blocks		1	5
DFT-OFDM Symbols per subframe		12	12
Modulation		QPSK	QPSK
Target Coding rate		1/3	1/3
Payload size	Bits	72	424
Transport block CRC	Bits	24	24
Number of code blocks - C		1	1
Code block CRC size	Bits	0	0
Total number of bits per sub-frame	Bits	288	1440
Total symbols per sub-frame		144	720
UE Category		1-5	1-5

Table A.2.2.2.1-2 Reference Channels for 3MHz QPSK with partial RB allocation

Parameter	Unit	Value	Value
Channel bandwidth	MHz	3	3
Allocated resource blocks		1	4
DFT-OFDM Symbols per subframe		12	12
Modulation		QPSK	QPSK
Target Coding rate		1/3	1/3
Payload size	Bits	72	392
Transport block CRC	Bits	24	24
Number of code blocks – C		1	1
Code block CRC size	Bits	0	0
Total number of bits per sub-frame	Bits	288	1152
Total symbols per sub-frame		144	576
UE Category		1-5	1-5

Table A.2.2.2.1-3 Reference Channels for 5MHz QPSK with partial RB allocation

Parameter	Unit	Value	Value	Value
Channel bandwidth	MHz	5	5	5
Allocated resource blocks		1	8	20
DFT-OFDM Symbols per subframe		12	12	12
Modulation		QPSK	QPSK	QPSK
Target Coding rate		1/3	1/3	1/3
Payload size	Bits	72	808	1736
Transport block CRC	Bits	24	24	24
Number of code blocks - C		1	1	1
Code block CRC size	Bits	0	0	0
Total number of bits per sub-frame	Bits	288	2304	5760
Total symbols per sub-frame		144	1152	2880
UE Category		1-5	1-5	1-5

Table A.2.2.2.1-4 Reference Channels for 10MHz QPSK with partial RB allocation

Parameter	Unit	Value	Value	Value	Value
Channel bandwidth	MHz	10	10	10	10
Allocated resource blocks		1	12	20	25
DFT-OFDM Symbols per subframe		12	12	12	12
Modulation		QPSK	QPSK	QPSK	QPSK
Target Coding rate		1/3	1/3	1/3	1/3
Payload size	Bits	72	1224	1736	2216
Transport block CRC	Bits	24	24	24	24
Number of code blocks - C		1	1	1	1
Code block CRC size	Bits	0	0	0	0
Total number of bits per sub-frame	Bits	288	3456	5760	7200
Total symbols per sub-frame		144	1728	2880	3600
UE Category		1-5	1-5	1-5	1-5

Table A.2.2.2.1-5 Reference Channels for 15MHz QPSK with partial RB allocation

Parameter	Unit	Value	Value	Value
Channel bandwidth	MHz	15	15	15
Allocated resource blocks		1	16	50
DFT-OFDM Symbols per subframe		12	12	12
Modulation		QPSK	QPSK	QPSK
Target Coding rate		1/3	1/3	1/3
Payload size	Bits	72	1384	5160
Transport block CRC	Bits	24	24	24
Number of code blocks - C		1	1	1
Code block CRC size	Bits	0	0	0
Total number of bits per sub-frame	Bits	288	4608	14400
Total symbols per sub-frame		144	2304	7200
UE Category		1-5	1-5	1-5

Table A.2.2.2.1-6 Reference Channels for 20MHz QPSK with partial RB allocation

Parameter	Unit	Value	Value	Value	Value	Value
Channel bandwidth	MHz	20	20	20	20	20
Allocated resource blocks		1	18	25	50	75
DFT-OFDM Symbols per subframe		12	12	12	12	12
Modulation		QPSK	QPSK	QPSK	QPSK	QPSK
Target Coding rate		1/3	1/3	1/3	1/3	1/5
Payload size	Bits	72	1864	2216	5160	4392
Transport block CRC	Bits	24	24	24	24	24
Number of code blocks - C		1	1	1	1	1
Code block CRC size	Bits	0	0	0	0	0
Total number of bits per sub-frame	Bits	288	5184	7200	14400	21600
Total symbols per sub-frame		144	2592	3600	7200	10800
UE Category		1-5	1-5	1-5	1-5	1-5

## A.2.2.2.2 16-QAM

Table A.2.2.2.2-1 Reference Channels for 1.4MHz 16-QAM with partial RB allocation

Parameter	Unit	Value	Value
Channel bandwidth	MHz	1.4	1.4
Allocated resource blocks		1	5
DFT-OFDM Symbols per subframe		12	12
Modulation		16QAM	16QAM
Target Coding rate		3/4	3/4
Payload size	Bits	408	2152
Transport block CRC	Bits	24	24
Number of code blocks - C		1	1
Code block CRC size	Bits	0	0
Total number of bits per sub-frame	Bits	576	2880
Total symbols per sub-frame		144	720
UE Category		1-5	1-5

Table A.2.2.2.2-2 Reference Channels for 3MHz 16-QAM with partial RB allocation

Parameter	Unit	Value	Value
Channel bandwidth	MHz	3	3
Allocated resource blocks		1	4
DFT-OFDM Symbols per subframe		12	12
Modulation		16QAM	16QAM
Target Coding rate		3/4	3/4
Payload size	Bits	408	1736
Transport block CRC	Bits	24	24
Number of code blocks – C		1	1
Code block CRC size	Bits	0	0
Total number of bits per sub-frame	Bits	576	2304
Total symbols per sub-frame		144	576
UE Category		1-5	1-5

Table A.2.2.2.2-3 Reference Channels for 5MHz 16-QAM with partial RB allocation

Parameter	Unit	Value	Value
Channel bandwidth	MHz	5	5
Allocated resource blocks		1	8
DFT-OFDM Symbols per subframe		12	12
Modulation		16QAM	16QAM
Target Coding rate		3/4	3/4
Payload size	Bits	408	3496
Transport block CRC	Bits	24	24
Number of code blocks - C		1	1
Code block CRC size	Bits	0	0
Total number of bits per sub-frame	Bits	576	4608
Total symbols per sub-frame		144	1152
UE Category		1-5	1-5

Table A.2.2.2.2-4 Reference Channels for 10MHz 16-QAM with partial RB allocation

Parameter	Unit	Value	Value
Channel bandwidth	MHz	10	10
Allocated resource blocks		1	12
DFT-OFDM Symbols per subframe		12	12
Modulation		16QAM	16QAM
Target Coding rate		3/4	3/4
Payload size	Bits	408	5160
Transport block CRC	Bits	24	24
Number of code blocks - C		1	1
Code block CRC size	Bits	0	0
Total number of bits per sub-frame	Bits	576	6912
Total symbols per sub-frame		144	1728
UE Category		1-5	1-5

Table A.2.2.2.2-5 Reference Channels for 15MHz 16-QAM with partial RB allocation

Parameter	Unit	Value	Value
Channel bandwidth	MHz	15	15
Allocated resource blocks		1	16
DFT-OFDM Symbols per subframe		12	12
Modulation		16QAM	16QAM
Target Coding rate		3/4	1/2
Payload size	Bits	408	4584
Transport block CRC	Bits	24	24
Number of code blocks - C		1	1
Code block CRC size	Bits	0	0
Total number of bits per sub-frame	Bits	576	9216
Total symbols per sub-frame		144	2304
UE Category		1-5	1-5

Table A.2.2.2.2-6 Reference Channels for 20MHz 16-QAM with partial RB allocation

Parameter	Unit	Value	Value
Channel bandwidth	MHz	20	20
Allocated resource blocks		1	18
DFT-OFDM Symbols per subframe		12	12
Modulation		16QAM	16QAM
Target Coding rate		3/4	1/2
Payload size	Bits	408	5160
Transport block CRC	Bits	24	24
Number of code blocks - C		1	1
Code block CRC size	Bits	0	0
Total number of bits per sub-frame	Bits	576	10368
Total symbols per sub-frame		144	2592
UE Category		1-5	1-5

### A.2.2.2.3 64-QAM

[FFS]

## A.2.3 Reference measurement channels for TDD

For TDD, the measurement channel is based on DL/UL configuration ratio of 2DL:2UL.

## A.2.3.1 Full RB allocation

## A.2.3.1.1 QPSK

Table A.2.3.1.1-1 Reference Channels for QPSK with full RB allocation

Parameter	Unit	Value					
Channel bandwidth	MHz	1.4	3	5	10	15	20
Allocated resource blocks		6	15	25	50	75	100
Uplink-Downlink Configuration		1	1	1	1	1	1
DFT-OFDM Symbols per subframe		12	12	12	12	12	12
Modulation		QPS	QPS	QPS	QPS	QPS	QPS
		K	K	K	K	K	K
Target Coding rate		1/3	1/3	1/3	1/3	1/5	1/6
Payload size							
For Sub-Frame 2,3,7,8	Bits	600	1544	2216	5160	4392	4584
Transport block CRC	Bits	24	24	24	24	24	24
Number of code blocks - C		1	1	1	1	1	1
Code block CRC size	Bits	0	0	0	0	0	0
Total number of bits per sub-frame							
For Sub-Frame 2,3,7,8	Bits	1728	4320	7200	14400	21600	28800
Total symbols per sub-frame							
For Sub-Frame 2,3,7,8		864	2160	3600	7200	10800	14400
UE Category		1-5	1-5	1-5	1-5	1-5	1-5

## A.2.3.1.2 16-QAM

Table A.2.3.1.2-1 Reference Channels for 16-QAM with full RB allocation

Parameter	Unit	Value					
Channel bandwidth	MHz	1.4	3	5	10	15	20
Allocated resource blocks		6	15	25	50	75	100
Uplink-Downlink Configuration		1	1	1	1	1	1
DFT-OFDM Symbols per subframe		12	12	12	12	12	12
Modulation		16QAM	16QAM	16QAM	16QAM	16QAM	16QAM
Target Coding rate		3/4	1/2	1/3	3/4	1/2	1/3
Payload size							
For Sub-Frame 2,3,7,8	Bits	1736	4264	4968	21384	21384	19848
Transport block CRC	Bits	24	24	24	24	24	24
Number of code blocks - C		1	1	1	4	4	4
Code block CRC size	Bits	0	0	0	24	24	24
Total number of bits per sub-frame							
For Sub-Frame 2,3,7,8	Bits	3456	8640	14400	28800	43200	57600
Total symbols per sub-frame							
For Sub-Frame 2,3,7,8		864	2160	3600	7200	10800	14400
UE Category		1-5	1-5	1-5	2-5	2-5	2-5

## A.2.3.1.3 64-QAM

[FFS]



## A.2.3.2 Partial RB allocation

For each channel bandwidth, various partial RB allocations are specified. The number of allocated RBs is chosen according to values specified in the Tx and Rx requirements. The single allocated RB case is included.

The allocated RBs are contiguous and start from one end of the channel bandwidth. A single allocated RB is at one end of the channel bandwidth.

### A.2.3.2.1 QPSK

**Table A.2.3.2.1-1 Reference Channels for 1.4MHz QPSK with partial RB allocation**

Parameter	Unit	Value	Value
Channel bandwidth	MHz	1.4	1.4
Allocated resource blocks		1	5
Uplink-Downlink Configuration		1	1
DFT-OFDM Symbols per subframe		12	12
Modulation		QPSK	QPSK
Target Coding rate		1/3	1/3
Payload size			
For Sub-Frame 2,3,7,8	Bits	72	424
Transport block CRC	Bits	24	24
Number of code blocks - C		1	1
Code block CRC size	Bits	0	0
Total number of bits per sub-frame			
For Sub-Frame 2,3,7,8	Bits	288	1440
Total symbols per sub-frame			
For Sub-Frame 2,3,7,8		144	720
UE Category		1-5	1-5

**Table A.2.3.2.1-2 Reference Channels for 3MHz QPSK with partial RB allocation**

Parameter	Unit	Value	Value
Channel bandwidth	MHz	3	3
Allocated resource blocks		1	4
Uplink-Downlink Configuration		1	1
DFT-OFDM Symbols per subframe		12	12
Modulation		QPSK	QPSK
Target Coding rate		1/3	1/3
Payload size			
For Sub-Frame 2,3,7,8	Bits	72	392
Transport block CRC	Bits	24	24
Number of code blocks – C		1	1
Code block CRC size	Bits	0	0
Total number of bits per sub-frame			
For Sub-Frame 2,3,7,8	Bits	288	1152
Total symbols per sub-frame			
For Sub-Frame 2,3,7,8		144	576
UE Category		1-5	1-5

Table A.2.3.2.1-3 Reference Channels for 5MHz QPSK with partial RB allocation

Parameter	Unit	Value	Value	Value
Channel bandwidth	MHz	5	5	5
Allocated resource blocks		1	8	20
Uplink-Downlink Configuration		1	1	1
DFT-OFDM Symbols per subframe		12	12	12
Modulation		QPSK	QPSK	QPSK
Target Coding rate		1/3	1/3	1/3
Payload size				
For Sub-Frame 2,3,7,8	Bits	72	808	1736
Transport block CRC	Bits	24	24	24
Number of code blocks - C		1	1	1
Code block CRC size	Bits	0	0	0
Total number of bits per sub-frame	Bits			
For Sub-Frame 2,3,7,8		288	2304	5760
Total symbols per sub-frame				
For Sub-Frame 2,3,7,8		144	1152	2880
UE Category		1-5	1-5	1-5

Table A.2.3.2.1-4 Reference Channels for 10MHz QPSK with partial RB allocation

Parameter	Unit	Value	Value	Value	Value
Channel bandwidth	MHz	10	10	10	10
Allocated resource blocks		1	12	20	25
Uplink-Downlink Configuration		1	1	1	1
DFT-OFDM Symbols per subframe		12	12	12	12
Modulation		QPSK	QPSK	QPSK	QPSK
Target Coding rate		1/3	1/3	1/3	1/3
Payload size					
For Sub-Frame 2,3,7,8	Bits	72	1224	1736	2216
Transport block CRC	Bits	24	24	24	24
Number of code blocks - C		1	1	1	1
Code block CRC size	Bits	0	0	0	0
Total number of bits per sub-frame					
For Sub-Frame 2,3,7,8	Bits	288	3456	5760	7200
Total symbols per sub-frame					
For Sub-Frame 2,3,7,8		144	1728	2880	3600
UE Category		1-5	1-5	1-5	1-5

Table A.2.3.2.1-5 Reference Channels for 15MHz QPSK with partial RB allocation

Parameter	Unit	Value	Value	Value
Channel bandwidth	MHz	15	15	15
Allocated resource blocks		1	16	50
Uplink-Downlink Configuration		1	1	1
DFT-OFDM Symbols per subframe		12	12	12
Modulation		QPSK	QPSK	QPSK
Target Coding rate		1/3	1/3	1/3
Payload size				
For Sub-Frame 2,3,7,8	Bits	72	1384	5160
Transport block CRC	Bits	24	24	24
Number of code blocks - C		1	1	1
Code block CRC size	Bits	0	0	0
Total number of bits per sub-frame				
For Sub-Frame 2,3,7,8	Bits	288	4608	14400
Total symbols per sub-frame				
For Sub-Frame 2,3,7,8		144	2304	7200
UE Category		1-5	1-5	1-5

Table A.2.3.2.1-6 Reference Channels for 20MHz QPSK with partial RB allocation

Parameter	Unit	Value	Value	Value	Value	Value
Channel bandwidth	MHz	20	20	20	20	20
Allocated resource blocks		1	18	25	50	75
Uplink-Downlink Configuration		1	1	1	1	1
DFT-OFDM Symbols per subframe		12	12	12	12	12
Modulation		QPSK	QPSK	QPSK	QPSK	QPSK
Target Coding rate		1/3	1/3	1/3	1/3	1/5
Payload size						
For Sub-Frame 2,3,7,8	Bits	72	1864	2216	5160	4392
Transport block CRC	Bits	24	24	24	24	24
Number of code blocks - C		1	1	1	1	1
Code block CRC size	Bits	0	0	0	0	0
Total number of bits per sub-frame						
For Sub-Frame 2,3,7,8	Bits	288	5184	7200	14400	21600
Total symbols per sub-frame						
For Sub-Frame 2,3,7,8		144	2592	3600	7200	10800
UE Category		1-5	1-5	1-5	1-5	1-5

## A.2.3.2.2 16-QAM

Table A.2.3.2.2-1 Reference Channels for 1.4MHz 16-QAM with partial RB allocation

Parameter	Unit	Value	Value
Channel bandwidth	MHz	1.4	1.4
Allocated resource blocks		1	5
Uplink-Downlink Configuration		1	1
DFT-OFDM Symbols per subframe		12	12
Modulation		16QAM	16QAM
Target Coding rate		3/4	3/4
Payload size			
For Sub-Frame 2,3,7,8	Bits	408	2152
Transport block CRC	Bits	24	24
Number of code blocks - C		1	1
Code block CRC size	Bits	0	0
Total number of bits per sub-frame			
For Sub-Frame 2,3,7,8	Bits	576	2880
Total symbols per sub-frame			
For Sub-Frame 2,3,7,8		144	720
UE Category		1-5	1-5

Table A.2.3.2.2-2 Reference Channels for 3MHz 16-QAM with partial RB allocation

Parameter	Unit	Value	Value
Channel bandwidth	MHz	3	3
Allocated resource blocks		1	4
Uplink-Downlink Configuration		1	1
DFT-OFDM Symbols per subframe		12	12
Modulation		16QAM	16QAM
Target Coding rate		3/4	3/4
Payload size			
For Sub-Frame 2,3,7,8	Bits	408	1736
Transport block CRC	Bits	24	24
Number of code blocks – C		1	1
Code block CRC size	Bits	0	0
Total number of bits per sub-frame			
For Sub-Frame 2,3,7,8	Bits	576	2304
Total symbols per sub-frame			
For Sub-Frame 2,3,7,8		144	576
UE Category		1-5	1-5

Table A.2.3.2.2-3 Reference Channels for 5MHz 16-QAM with partial RB allocation

Parameter	Unit	Value	Value
Channel bandwidth	MHz	5	5
Allocated resource blocks		1	8
Uplink-Downlink Configuration		1	1
DFT-OFDM Symbols per subframe		12	12
Modulation		16QAM	16QAM
Target Coding rate		3/4	3/4
Payload size			
For Sub-Frame 2,3,7,8	Bits	408	3496
Transport block CRC	Bits	24	24
Number of code blocks - C		1	1
Code block CRC size	Bits	0	0
Total number of bits per sub-frame			
For Sub-Frame 2,3,7,8	Bits	576	4608
Total symbols per sub-frame			
For Sub-Frame 2,3,7,8		144	1152
UE Category		1-5	1-5

Table A.2.3.2.2-4 Reference Channels for 10MHz 16-QAM with partial RB allocation

Parameter	Unit	Value	Value
Channel bandwidth	MHz	10	10
Allocated resource blocks		1	12
Uplink-Downlink Configuration		1	1
DFT-OFDM Symbols per subframe		12	12
Modulation		16QAM	16QAM
Target Coding rate		3/4	3/4
Payload size			
For Sub-Frame 2,3,7,8	Bits	408	5160
Transport block CRC	Bits	24	24
Number of code blocks - C		1	1
Code block CRC size	Bits	0	0
Total number of bits per sub-frame			
For Sub-Frame 2,3,7,8	Bits	576	6912
Total symbols per sub-frame			
For Sub-Frame 2,3,7,8		144	1728

Table A.2.3.2.2-5 Reference Channels for 15MHz 16-QAM with partial RB allocation

Parameter	Unit	Value	Value
Channel bandwidth	MHz	15	15
Allocated resource blocks		1	16
Uplink-Downlink Configuration		1	1
DFT-OFDM Symbols per subframe		12	12
Modulation		16QAM	16QAM
Target Coding rate		3/4	1/2
Payload size			
For Sub-Frame 2,3,7,8	Bits	408	4584
Transport block CRC	Bits	24	24
Number of code blocks - C		1	1
Code block CRC size	Bits	0	0
Total number of bits per sub-frame			
For Sub-Frame 2,3,7,8	Bits	576	9216
Total symbols per sub-frame			
For Sub-Frame 2,3,7,8		144	2304
UE Category		1-5	1-5

Table A.2.3.2.2-6 Reference Channels for 20MHz 16-QAM with partial RB allocation

Parameter	Unit	Value	Value
Channel bandwidth	MHz	20	20
Allocated resource blocks		1	18
Uplink-Downlink Configuration		1	1
DFT-OFDM Symbols per subframe		12	12
Modulation		16QAM	16QAM
Target Coding rate		3/4	1/2
Payload size			
For Sub-Frame 2,3,7,8	Bits	408	5160
Transport block CRC	Bits	24	24
Number of code blocks - C		1	1
Code block CRC size	Bits	0	0
Total number of bits per sub-frame			
For Sub-Frame 2,3,7,8	Bits	576	10368
Total symbols per sub-frame			
For Sub-Frame 2,3,7,8		144	2592
UE Category		1-5	1-5

## A.2.3.2.3 64-QAM

[FFS]

## A.3 DL reference measurement channels

### A.3.1 General

The number of available channel bits varies across the sub-frames due to PBCH and PSS/SSS overhead. The payload size per sub-frame is varied in order to keep the code rate constant throughout a frame.

No user data is scheduled on subframes #5 in order to facilitate the transmission of system information blocks (SIB).

The algorithm for determining the payload size  $A$  is as follows; given a desired coding rate  $R$  and radio block allocation  $N_{RB}$

1. Calculate the number of channel bits  $N_{ch}$  that can be transmitted during the first transmission of a given sub-frame.
2. Find  $A$  such that the resulting coding rate is as close to  $R$  as possible, that is,

$$\min |R - (A + 24) / N_{ch}|,$$

subject to

- a)  $A$  is a valid TB size according to section 7.1.7 of TS 36.213 [6] assuming an allocation of  $N_{RB}$  resource blocks.
  - b) Segmentation is not included in this formula, but should be considered in the TBS calculation.
3. If there is more than one  $A$  that minimizes the equation above, then the larger value is chosen per default.
  4. For TDD, the measurement channel is based on DL/UL configuration ratio of 2DL+DwPTS (12 OFDM symbol):  
2UL

### A.3.2 Reference measurement channel for receiver characteristics

Tables A.3.2-1 and A.3.2-2 are applicable for measurements on the Receiver Characteristics (clause 7) with the exception of sub-clause 7.4 (Maximum input level).

Tables A.3.2-3 and A.3.2-4 are applicable for sub-clause 7.4 (Maximum input level).

Tables A.3.2-1 and A.3.2-2 also apply for the modulated interferer used in Clauses 7.5, 7.6 and 7.8 with test specific bandwidths.

Table A.3.2-1 Fixed Reference Channel for Receiver Requirements (FDD)

Parameter	Unit	Value					
		1.4	3	5	10	15	20
Channel bandwidth	MHz	1.4	3	5	10	15	20
Allocated resource blocks		6	15	25	50	75	100
Subcarriers per resource block		12	12	12	12	12	12
Allocated subframes per Radio Frame		10	10	10	10	10	10
Modulation		QPSK	QPSK	QPSK	QPSK	QPSK	QPSK
Target Coding Rate		1/3	1/3	1/3	1/3	1/3	1/3
Number of HARQ Processes	Processes	8	8	8	8	8	8
Maximum number of HARQ transmissions		1	1	1	1	1	1
Information Bit Payload per Sub-Frame							
For Sub-Frames 1,2,3,4,6,7,8,9	Bits	408	1320	2216	4392	6712	8760
For Sub-Frame 5	Bits	n/a	n/a	n/a	n/a	n/a	n/a
For Sub-Frame 0	Bits	152	872	1800	4392	6712	8760
Transport block CRC	Bits	24	24	24	24	24	24
Number of Code Blocks per Sub-Frame (see Note 4)		1	1	1	1	2	2
Binary Channel Bits Per Sub-Frame							
For Sub-Frames 1,2,3,4,6,7,8,9	Bits	1368	3780	6300	13800	20700	27600
For Sub-Frame 5	Bits	n/a	n/a	n/a	n/a	n/a	n/a
For Sub-Frame 0	Bits	528	2940	5460	12960	19860	26760
Max. Throughput averaged over 1 frame	kbps	341.6	1143.2	1952.8	3952.8	6040.8	7884.8
UE Category		1-5	1-5	1-5	1-5	1-5	1-5
Note 1: 2 symbols allocated to PDCCH for 20 MHz, 15 MHz and 10MHz channel BW. 3 symbols allocated to PDCCH for 5 MHz and 3 MHz. 4 symbols allocated to PDCCH for 1.4 MHz							
Note 2: Reference signal, Synchronization signals and PBCH allocated as per TS 36.211 [4]							
Note 3: The RLC should be configured to Unacknowledged Mode							
Note 4: If more than one Code Block is present, an additional CRC sequence of L = 24 Bits is attached to each Code Block (otherwise L = 0 Bit)							

Table A.3.2-2 Fixed Reference Channel for Receiver Requirements (TDD)

Parameter	Unit	Value					
		1.4	3	5	10	15	20
Channel Bandwidth	MHz	1.4	3	5	10	15	20
Allocated resource blocks		6	15	25	50	75	100
Uplink-Downlink Configuration		1	1	1	1	1	1
Allocated subframes per Radio Frame (D+S)		4	4+2	4+2	4+2	4+2	4+2
Number of HARQ Processes	Processes	7	7	7	7	7	7
Maximum number of HARQ transmission		1	1	1	1	1	1
Modulation		QPSK	QPSK	QPSK	QPSK	QPSK	QPSK
Target coding rate		1/3	1/3	1/3	1/3	1/3	1/3
Information Bit Payload per Sub-Frame	Bits						
For Sub-Frame 4, 9		408	1320	2216	4392	6712	8760
For Sub-Frame 1, 6		n/a	968	1544	3240	4968	6712
For Sub-Frame 5		n/a	n/a	n/a	n/a	n/a	n/a
For Sub-Frame 0		208	1064	1800	4392	6712	8760
Transport block CRC	Bits	24	24	24	24	24	24
Number of Code Blocks per Sub-Frame (see Note 5)							
For Sub-Frame 4, 9		1	1	1	1	2	2
For Sub-Frame 1, 6		n/a	1	1	1	1	2
For Sub-Frame 5		n/a	n/a	n/a	n/a	n/a	n/a
For Sub-Frame 0		1	1	1	1	2	2
Binary Channel Bits Per Sub-Frame	Bits						
For Sub-Frame 4, 9		1368	3780	6300	13800	20700	27600
For Sub-Frame 1, 6		n/a	3276	5556	11256	16956	22656
For Sub-Frame 5		n/a	n/a	n/a	n/a	n/a	n/a
For Sub-Frame 0		672	3084	5604	13104	20004	26904
Max. Throughput averaged over 1frame	kbps	102.4	564	932	1965.6	3007.2	3970.4
UE Category		1-5	1-5	1-5	1-5	1-5	1-5



- Note 1: For normal subframes(0,4,5,9), 2 symbols allocated to PDCCH for 20 MHz, 15 MHz and 10 MHz channel BW; 3 symbols allocated to PDCCH for 5 MHz and 3 MHz; 4 symbols allocated to PDCCH for 1.4 MHz. For special subframe (1&6), only 2 OFDM symbols are allocated to PDCCH for all BWs.
- Note 2: For 1.4MHz, no data shall be scheduled on special subframes(1&6) to avoid problems with insufficient PDCCH performance
- Note 3: Reference signal, Synchronization signals and PBCH allocated as per TS 36.211 [4]
- Note 4: The RLC should be configured to Unacknowledged Mode
- Note 5: If more than one Code Block is present, an additional CRC sequence of L = 24 Bits is attached to each Code Block (otherwise L = 0 Bit).

Table A.3.2-3 Fixed Reference Channel for Maximum input level for UE Categories 3-5 (FDD)

Parameter	Unit	Value					
		1.4	3	5	10	15	20
Channel bandwidth	MHz	1.4	3	5	10	15	20
Allocated resource blocks		6	15	25	50	75	100
Subcarriers per resource block		12	12	12	12	12	12
Allocated subframes per Radio Frame		10	10	10	10	10	10
Modulation		64QAM	64QAM	64QAM	64QAM	64QAM	64QAM
Target Coding Rate		3/4	3/4	3/4	3/4	3/4	3/4
Number of HARQ Processes	Processes	8	8	8	8	8	8
Maximum number of HARQ transmissions		1	1	1	1	1	1
Information Bit Payload per Sub-Frame							
For Sub-Frames 1,2,3,4,6,7,8,9	Bits	2984	8504	14112	30576	46888	61664
For Sub-Frame 5	Bits	n/a	n/a	n/a	n/a	n/a	n/a
For Sub-Frame 0	Bits	n/a	6456	12576	28336	45352	61664
Transport block CRC	Bits	24	24	24	24	24	24
Number of Code Blocks per Sub-Frame (see Note 4)		1	2	3	5	8	11
Binary Channel Bits Per Sub-Frame							
For Sub-Frames 1,2,3,4,6,7,8,9	Bits	4104	11340	18900	41400	62100	82800
For Sub-Frame 5	Bits	n/a	n/a	n/a	n/a	n/a	n/a
For Sub-Frame 0	Bits	n/a	8820	16380	38880	59580	80280
Max. Throughput averaged over 1 frame	kbps	2387.2	7448.8	12547	27294	42046	55498
Note 1:	2 symbols allocated to PDCCH for 20 MHz, 15 MHz and 10 MHz channel BW. 3 symbols allocated to PDCCH for 5 MHz and 3 MHz. 4 symbols allocated to PDCCH for 1.4 MHz						
Note 2:	Reference signal, Synchronization signals and PBCH allocated as per TS 36.211 [4]						
Note 3:	The RLC should be configured to Unacknowledged Mode						
Note 4:	If more than one Code Block is present, an additional CRC sequence of L = 24 Bits is attached to each Code Block (otherwise L = 0 Bit)						

Table A.3.2-3a Fixed Reference Channel for Maximum input level for UE Category 1 (FDD)

Parameter	Unit	Value					
		1.4	3	5	10	15	20
Channel bandwidth	MHz	1.4	3	5	10	15	20
Allocated resource blocks (see Note 5)		6	15	16 (Note 5)	16 (Note 5)	16 (Note 5)	16 (Note 5)
Subcarriers per resource block		12	12	12	12	12	12
Allocated subframes per Radio Frame		10	10	10	10	10	10
Modulation		64QAM	64QAM	64QAM	64QAM	64QAM	64QAM
Target Coding Rate		3/4	3/4	3/4	3/4	3/4	3/4
Number of HARQ Processes	Processes	8	8	8	8	8	8
Maximum number of HARQ transmissions		1	1	1	1	1	1
Information Bit Payload							
For Sub-Frames 1,2,3,4,6,7,8,9	Bits	2984	8504	10296	10296	10296	10296
For Sub-Frame 5	Bits	n/a	n/a	n/a	n/a	n/a	n/a
For Sub-Frame 0	Bits	n/a	6456	7480	9912	9912	9912
Transport block CRC	Bits	24	24	24	24	24	24
Number of Code Blocks per Sub-Frame (see Note 4)		1	2	2	2	2	2
Binary Channel Bits Per Sub-Frame							
For Sub-Frames 1,2,3,4,6,7,8,9	Bits	4104	11340	13824	13824	13824	13824
For Sub-Frame 5	Bits	n/a	n/a	n/a	n/a	n/a	n/a
For Sub-Frame 0	Bits	n/a	8820	10008	13248	13248	13248
Max. Throughput averaged over 1 frame	kbps	2387.2	7448.8	8984.8	9228	9228	9228
Note 1:	2 symbols allocated to PDCCH for 20 MHz, 15 MHz and 10 MHz channel BW. 3 symbols allocated to PDCCH for 5 MHz and 3 MHz. 4 symbols allocated to PDCCH for 1.4 MHz						
Note 2:	Reference signal, Synchronization signals and PBCH allocated as per TS 36.211 [4]						
Note 3:	The RLC should be configured to Unacknowledged Mode						
Note 4:	If more than one Code Block is present, an additional CRC sequence of L = 24 Bits is attached to each Code Block (otherwise L = 0 Bit)						
Note 5:	In case of partial allocation, the unallocated RB-s are filled with OCNG (Annex A.5). The total signal mean power and the power density over the channel bandwidth configuration i.e. for data (allocated RB-s) and OCNG (unallocated RB-s) remain the same as for full allocation.						

Table A.3.2-3b Fixed Reference Channel for Maximum input level for UE Category 2 (FDD)

Parameter	Unit	Value					
		1.4	3	5	10	15	20
Channel bandwidth	MHz	1.4	3	5	10	15	20
Allocated resource blocks (see Note 5)		6	15	25	50	75	80 (Note 5)
Subcarriers per resource block		12	12	12	12	12	12
Allocated subframes per Radio Frame		10	10	10	10	10	10
Modulation		64QAM	64QAM	64QAM	64QAM	64QAM	64QAM
Target Coding Rate		3/4	3/4	3/4	3/4	3/4	3/4
Number of HARQ Processes	Processes	8	8	8	8	8	8
Maximum number of HARQ transmissions		1	1	1	1	1	1
Information Bit Payload							
For Sub-Frames 1,2,3,4,6,7,8,9	Bits	2984	8504	14112	30576	46888	51024
For Sub-Frame 5	Bits	n/a	n/a	n/a	n/a	n/a	n/a
For Sub-Frame 0	Bits	n/a	6456	12576	28336	45352	48936
Transport block CRC	Bits	24	24	24	24	24	24
Number of Code Blocks per Sub-Frame (see Note 4)		1	2	3	5	8	9
Binary Channel Bits Per Sub-Frame							
For Sub-Frames 1,2,3,4,6,7,8,9	Bits	4104	11340	18900	41400	62100	69120
For Sub-Frame 5	Bits	n/a	n/a	n/a	n/a	n/a	n/a
For Sub-Frame 0	Bits	n/a	8820	16380	38880	59580	64152
Max. Throughput averaged over 1 frame	kbps	2387.2	7448.8	12547	27294	42046	4571,3
Note 1:	2 symbols allocated to PDCCH for 20 MHz, 15 MHz and 10 MHz channel BW. 3 symbols allocated to PDCCH for 5 MHz and 3 MHz. 4 symbols allocated to PDCCH for 1.4 MHz						
Note 2:	Reference signal, Synchronization signals and PBCH allocated as per TS 36.211 [4]						
Note 3:	The RLC should be configured to Unacknowledged Mode						
Note 4:	If more than one Code Block is present, an additional CRC sequence of L = 24 Bits is attached to each Code Block (otherwise L = 0 Bit)						

Note 5: In case of partial allocation, the unallocated RB-s are filled with OCNG (Annex A.5). The total signal mean power and the power density over the channel bandwidth configuration i.e. for data (allocated RB-s) and OCNG (unallocated RB-s) remain the same as for full allocation.

**Table A.3.2-4 Fixed Reference Channel for Maximum input level for UE Categories 3-5 (TDD)**

Parameter	Unit	Value					
		1.4	3	5	10	15	20
Channel bandwidth	MHz	1.4	3	5	10	15	20
Allocated resource blocks		6	15	25	50	75	100
Subcarriers per resource block		12	12	12	12	12	12
Uplink-Downlink Configuration		1	1	1	1	1	1
Allocated subframes per Radio Frame		4	4+2	4+2	4+2	4+2	4+2
Modulation		64QAM	64QAM	64QAM	64QAM	64QAM	64QAM
Target Coding Rate		3/4	3/4	3/4	3/4	3/4	3/4
Number of HARQ Processes	Processes	7	7	7	7	7	7
Maximum number of HARQ transmissions		1	1	1	1	1	1
Information Bit Payload per Sub-Frame							
For Sub-Frames 4,9	Bits	2984	8504	14112	30576	46888	61664
For Sub-Frames 1,6	Bits	n/a	6968	11448	23688	35160	46888
For Sub-Frame 5	Bits	n/a	n/a	n/a	n/a	n/a	n/a
For Sub-Frame 0	Bits	n/a	6968	12576	30576	45352	61664
Transport block CRC	Bits	24	24	24	24	24	24
Number of Code Blocks per Sub-Frame (see Note 5)							
For Sub-Frames 4,9		1	2	3	5	8	11
For Sub-Frames 1,6		n/a	2	3	5	7	9
For Sub-Frame 5		n/a	n/a	n/a	n/a	n/a	n/a
For Sub-Frame 0		n/a	2	3	5	8	11
Binary Channel Bits per Sub-Frame							
For Sub-Frames 4,9	Bits	4104	11340	18900	41400	62100	82800
For Sub-Frames 1,6		n/a	9828	16668	33768	50868	67968
For Sub-Frame 5	Bits	n/a	n/a	n/a	n/a	n/a	n/a
For Sub-Frame 0	Bits	n/a	9252	16380	39312	60012	80712
Max. Throughput averaged over 1 frame	kbps	596.8	3791.2	6369.6	13910	20945	27877
Note 1:	For normal subframes(0,4,5,9), 2 symbols allocated to PDCCH for 20 MHz, 15 MHz and 10 MHz channel BW; 3 symbols allocated to PDCCH for 5 MHz and 3 MHz; 4 symbols allocated to PDCCH for 1.4 MHz. For special subframe (1&6), only 2 OFDM symbols are allocated to PDCCH for all BWs.						
Note 2:	For 1.4MHz, no data shall be scheduled on special subframes(1&6) to avoid problems with insufficient PDCCH performance						
Note 3:	Reference signal, Synchronization signals and PBCH allocated as per TS 36.211 [4]						
Note 4:	The RLC should be configured to Unacknowledged Mode						
Note 5:	If more than one Code Block is present, an additional CRC sequence of L = 24 Bits is attached to each Code Block (otherwise L = 0 Bit).						

Table A.3.2-4a Fixed Reference Channel for Maximum input level for UE Category 1 (TDD)

Parameter	Unit	Value					
		1.4	3	5	10	15	20
Channel bandwidth	MHz	1.4	3	5	10	15	20
Allocated resource blocks (see Note 6)		6	15	16 (Note 6)	16 (Note 6)	16 (Note 6)	16 (Note 6)
Subcarriers per resource block		12	12	12	12	12	12
Uplink-Downlink Configuration		1	1	1	1	1	1
Allocated subframes per Radio Frame		4	4+2	4+2	4+2	4+2	4+2
Modulation		64QAM	64QAM	64QAM	64QAM	64QAM	64QAM
Target Coding Rate		3/4	3/4	3/4	3/4	3/4	3/4
Number of HARQ Processes	Processes	7	7	7	7	7	7
Maximum number of HARQ transmissions		1	1	1	1	1	1
Information Bit Payload per Sub-Frame							
For Sub-Frames 4,9	Bits	2984	8504	10296	10296	10296	10296
For Sub-Frames 1,6	Bits	n/a	6968	7480	7480	7480	7480
For Sub-Frame 5	Bits	n/a	n/a	n/a	n/a	n/a	n/a
For Sub-Frame 0	Bits	n/a	6968	7480	9912	9912	9912
Transport block CRC	Bits	24	24	24	24	24	24
Number of Code Blocks per Sub-Frame (see Note 5)							
For Sub-Frames 4,9		1	2	2	2	2	2
For Sub-Frames 1,6		n/a	2	2	2	2	2
For Sub-Frame 5		n/a	n/a	n/a	n/a	n/a	n/a
For Sub-Frame 0		n/a	2	2	2	2	2
Binary Channel Bits per Sub-Frame							
For Sub-Frames 4,9	Bits	4104	11340	13824	13824	13824	13824
For Sub-Frames 1,6		n/a	9828	10512	10944	10944	10944
For Sub-Frame 5	Bits	n/a	n/a	n/a	n/a	n/a	n/a
For Sub-Frame 0	Bits	n/a	9252	10008	13248	13248	13248
Max. Throughput averaged over 1 frame	kbps	596.8	3791.2	4303.2	4546.4	4546.4	4546.4
Note 1:	For normal subframes(0,4,5,9), 2 symbols allocated to PDCCH for 20 MHz, 15 MHz and 10 MHz channel BW; 3 symbols allocated to PDCCH for 5 MHz and 3 MHz; 4 symbols allocated to PDCCH for 1.4 MHz. For special subframe (1&6), only 2 OFDM symbols are allocated to PDCCH for all BWs.						
Note 2:	For 1.4MHz, no data shall be scheduled on special subframes(1&6) to avoid problems with insufficient PDCCH performance						
Note 3:	Reference signal, Synchronization signals and PBCH allocated as per TS 36.211 [4]						
Note 4:	The RLC should be configured to Unacknowledged Mode						
Note 5:	If more than one Code Block is present, an additional CRC sequence of L = 24 Bits is attached to each Code Block (otherwise L = 0 Bit)						
Note 6:	In case of partial allocation, the unallocated RB-s are filled with OCNB (Annex A.5). The total signal mean power and the power density over the channel bandwidth configuration i.e. for data (allocated RB-s) and OCNB (unallocated RB-s) remain the same as for full allocation.						

Table A.3.2-4b Fixed Reference Channel for Maximum input level for UE Category 2 (TDD)

Parameter	Unit	Value					
		1.4	3	5	10	15	20
Channel bandwidth	MHz	1.4	3	5	10	15	20
Allocated resource blocks (see Note 6)		6	15	25	50	75	80 (Note 6)
Subcarriers per resource block		12	12	12	12	12	12
Uplink-Downlink Configuration		1	1	1	1	1	1
Allocated subframes per Radio Frame		4	4+2	4+2	4+2	4+2	4+2
Modulation		64QAM	64QAM	64QAM	64QAM	64QAM	64QAM
Target Coding Rate		3/4	3/4	3/4	3/4	3/4	3/4
Number of HARQ Processes	Processes	7	7	7	7	7	7
Maximum number of HARQ transmissions		1	1	1	1	1	1
Information Bit Payload per Sub-Frame							
For Sub-Frames 4,9	Bits	2984	8504	14112	30576	46888	51024
For Sub-Frames 1,6	Bits	n/a	6968	11448	23688	35160	37888
For Sub-Frame 5	Bits	n/a	n/a	n/a	n/a	n/a	n/a
For Sub-Frame 0	Bits	n/a	6968	12576	30576	45352	48936
Transport block CRC	Bits	24	24	24	24	24	24
Number of Code Blocks per Sub-Frame							

(see Note 5)							
For Sub-Frames 4,9		1	2	3	5	8	9
For Sub-Frames 1,6		n/a	2	3	5	7	7
For Sub-Frame 5		n/a	n/a	n/a	n/a	n/a	n/a
For Sub-Frame 0		n/a	2	3	5	8	8
Binary Channel Bits per Sub-Frame							
For Sub-Frames 4,9	Bits	4104	11340	18900	41400	62100	69120
For Sub-Frames 1,6		n/a	9828	16668	33768	50868	54288
For Sub-Frame 5	Bits	n/a	n/a	n/a	n/a	n/a	n/a
For Sub-Frame 0	Bits	n/a	9252	16380	39312	60012	64152
Max. Throughput averaged over 1 frame	kbps	596.8	3791.2	6369.6	13910	20945	22676
Note 1:	For normal subframes(0,4,5,9), 2 symbols allocated to PDCCH for 20 MHz, 15 MHz and 10 MHz channel BW; 3 symbols allocated to PDCCH for 5 MHz and 3 MHz; 4 symbols allocated to PDCCH for 1.4 MHz. For special subframe (1&6), only 2 OFDM symbols are allocated to PDCCH for all BWs.						
Note 2:	For 1.4MHz, no data shall be scheduled on special subframes(1&6) to avoid problems with insufficient PDCCH performance						
Note 3:	Reference signal, Synchronization signals and PBCH allocated as per TS 36.211 [4]						
Note 4:	The RLC should be configured to Unacknowledged Mode						
Note 5:	If more than one Code Block is present, an additional CRC sequence of L = 24 Bits is attached to each Code Block (otherwise L = 0 Bit)						
Note 5:	In case of partial allocation, the unallocated RB-s are filled with OCNG (Annex A.5). The total signal mean power and the power density over the channel bandwidth configuration i.e. for data (allocated RB-s) and OCNG (unallocated RB-s) remain the same as for full allocation.						

## A.3.3 Reference measurement channels for PDSCH performance requirements (FDD)

### A.3.3.1 Single-antenna transmission (Common Reference Symbols)

**Table A.3.3.1-1: Fixed Reference Channel QPSK R=1/3**

Parameter	Unit	Value					
		[R.4 FDD]			[R.2 FDD]		
Reference channel							
Channel bandwidth	MHz	1.4	3	5	10	15	20
Allocated resource blocks		6			50		
Allocated subframes per Radio Frame		10			10		
Modulation		QPSK			QPSK		
Target Coding Rate		1/3			1/3		
Information Bit Payload							
For Sub-Frames 1,2,3,4,6,7,8,9	Bits	408			4392		
For Sub-Frame 5	Bits	n/a			n/a		
For Sub-Frame 0	Bits	152			4392		
Number of Code Blocks per Sub-Frame (see Note 3)		1			1		
Binary Channel Bits Per Sub-Frame							
For Sub-Frames 1,2,3,4,6,7,8,9	Bits	1368			13800		
For Sub-Frame 5	Bits	n/a			n/a		
For Sub-Frame 0	Bits	528			12960		
Max. Throughput averaged over 1 frame	Mbps	0.342			3.953		
UE Category		1-5			1-5		
Note 1: 2 symbols allocated to PDCCH for 20 MHz, 15 MHz and 10 MHz channel BW; 3 symbols allocated to PDCCH for 5 MHz and 3 MHz; 4 symbols allocated to PDCCH for 1.4 MHz Note 2: Reference signal, synchronization signals and PBCH allocated as per TS 36.211 [4] Note 3: If more than one Code Block is present, an additional CRC sequence of L = 24 Bits is attached to each Code Block (otherwise L = 0 Bit)							

**Table A.3.3.1-2: Fixed Reference Channel 16QAM R=1/2**

Parameter	Unit	Value					
		[R.3 FDD]			[R.3 FDD]		
Reference channel							
Channel bandwidth	MHz	1.4	3	5	10	15	20
Allocated resource blocks					50		
Allocated subframes per Radio Frame					10		
Modulation					16QAM		
Target Coding Rate					1/2		
Information Bit Payload							
For Sub-Frames 1,2,3,4,6,7,8,9	Bits				14112		
For Sub-Frame 5	Bits				n/a		
For Sub-Frame 0	Bits				12960		
Number of Code Blocks per Sub-Frame (see Note 3)					3		
Binary Channel Bits Per Sub-Frame							
For Sub-Frames 1,2,3,4,6,7,8,9	Bits				27600		
For Sub-Frame 5	Bits				n/a		
For Sub-Frame 0	Bits				25920		
Max. Throughput averaged over 1 frame	Mbps				12.586		
UE Category					2-5		
Note 1: 2 symbols allocated to PDCCH for 20 MHz, 15 MHz and 10 MHz channel BW; 3 symbols allocated to PDCCH for 5 MHz and 3 MHz; 4 symbols allocated to PDCCH for 1.4 MHz Note 2: Reference signal, synchronization signals and PBCH allocated as per TS 36.211 [4] Note 3: If more than one Code Block is present, an additional CRC sequence of L = 24 Bits is attached to each Code Block (otherwise L = 0 Bit)							

Table A.3.3.1-3: Fixed Reference Channel 64QAM R=3/4

Parameter	Unit	Value					
			[R.5 FDD]	[R.6 FDD]	[R.7 FDD]	[R.8 FDD]	[R.9 FDD]
Reference channel							
Channel bandwidth	MHz	1.4	3	5	10	15	20
Allocated resource blocks			15	25	50	75	100
Allocated subframes per Radio Frame			10	10	10	10	10
Modulation		64QAM	64QAM	64QAM	64QAM	64QAM	64QAM
Target Coding Rate		3/4	3/4	3/4	3/4	3/4	3/4
Information Bit Payload							
For Sub-Frames 1,2,3,4,6,7,8,9	Bits		8504	14112	30576	46888	61664
For Sub-Frame 5	Bits		n/a	n/a	n/a	n/a	n/a
For Sub-Frame 0	Bits		6456	12576	28336	45352	61664
Number of Code Blocks per Sub-Frame (see Note 3)			2	3	5	8	11
Binary Channel Bits Per Sub-Frame							
For Sub-Frames 1,2,3,4,6,7,8,9	Bits		11340	18900	41400	62100	82800
For Sub-Frame 5	Bits		n/a	n/a	n/a	n/a	n/a
For Sub-Frame 0	Bits		8820	16380	38880	59580	80280
Max. Throughput averaged over 1 frame	Mbps		7.449	12.547	27.294	42.046	55.498
UE Category			1-5	2-5	2-5	2-5	3-5
Note 1: 2 symbols allocated to PDCCH for 20 MHz, 15 MHz and 10 MHz channel BW; 3 symbols allocated to PDCCH for 5 MHz and 3 MHz; 4 symbols allocated to PDCCH for 1.4 MHz							
Note 2: Reference signal, synchronization signals and PBCH allocated as per TS 36.211 [4]							
Note 3: If more than one Code Block is present, an additional CRC sequence of L = 24 Bits is attached to each Code Block (otherwise L = 0 Bit)							

Table A.3.3.1-4: Fixed Reference Channel Single PRB (Channel Edge)

Parameter	Unit	Value					
			[R.0 FDD]		[R.1 FDD]		
Reference channel							
Channel bandwidth	MHz	1.4	3	5	10/20	15	20
Allocated resource blocks			1		1		
Allocated subframes per Radio Frame			10		10		
Modulation			16QAM		16QAM		
Target Coding Rate			1/2		1/2		
Information Bit Payload							
For Sub-Frames 1,2,3,4,6,7,8,9	Bits		224		256		
For Sub-Frame 5	Bits		n/a		n/a		
For Sub-Frame 0	Bits		224		256		
Number of Code Blocks per Sub-Frame (see Note 3)			1		1		
Binary Channel Bits Per Sub-Frame							
For Sub-Frames 1,2,3,4,6,7,8,9	Bits		504		552		
For Sub-Frame 5	Bits		n/a		n/a		
For Sub-Frame 0	Bits		504		552		
Max. Throughput averaged over 1 frame	Mbps		0.202		0.230		
UE Category			1-5		1-5		
Note 1: 2 symbols allocated to PDCCH for 20 MHz, 15 MHz and 10 MHz channel BW; 3 symbols allocated to PDCCH for 5 MHz and 3 MHz; 4 symbols allocated to PDCCH for 1.4 MHz							
Note 2: Reference signal, synchronization signals and PBCH allocated as per TS 36.211 [4]							
Note 3: If more than one Code Block is present, an additional CRC sequence of L = 24 Bits is attached to each Code Block (otherwise L = 0 Bit)							

Table A.3.3.1-5: Fixed Reference Channel Single PRB (MBSFN Configuration)

Parameter	Unit	Value
Reference channel		R.29 FDD (MBSFN)
Channel bandwidth	MHz	10
Allocated resource blocks		1
MBSFN Configuration		TBD
Allocated subframes per Radio Frame		4
Modulation		16QAM
Target Coding Rate		1/2
Information Bit Payload		
For Sub-Frames 4,9	Bits	256
For Sub-Frame 5	Bits	n/a
For Sub-Frame 0	Bits	256
For Sub-Frame 1,2,3,6,7,8	Bits	0 (MBSFN)
Number of Code Blocks per Sub-Frame (see Note 3)		1
Binary Channel Bits Per Sub-Frame		
For Sub-Frames 4,9	Bits	552
For Sub-Frame 5	Bits	n/a
For Sub-Frame 0	Bits	552
For Sub-Frame 1,2,3,6,7,8	Bits	0 (MBSFN)
Max. Throughput averaged over 1 frame	kbps	76.8
UE Category		1-5

Note 1: 2 symbols allocated to PDCCH

Note 2: Reference signal, synchronization signals and PBCH allocated as per TS 36.211 [4]

Note 3: If more than one Code Block is present, an additional CRC sequence of L = 24 Bits is attached to each Code Block (otherwise L = 0 Bit)



## A.3.3.2 Multi-antenna transmission (Common Reference Symbols)

### A.3.3.2.1 Two antenna ports

**Table A.3.3.2.1-1: Fixed Reference Channel two antenna ports**

Parameter	Unit	Value			
		[R.10 FDD]	[R.11 FDD]		
Reference channel					
Channel bandwidth	MHz	10	10		
Allocated resource blocks		50	50		
Allocated subframes per Radio Frame		10	10		
Modulation		QPSK	16QAM		
Target Coding Rate		1/3	1/2		
Information Bit Payload					
For Sub-Frames 1,2,3,4,6,7,8,9	Bits	4392	12960		
For Sub-Frame 5	Bits	n/a	n/a		
For Sub-Frame 0	Bits	4392	12960		
Number of Code Blocks per Sub-Frame (see Note 3)		1	3		
Binary Channel Bits Per Sub-Frame					
For Sub-Frames 1,2,3,4,6,7,8,9	Bits	13200	26400		
For Sub-Frame 5	Bits	n/a	n/a		
For Sub-Frame 0	Bits	12384	24768		
Max. Throughput averaged over 1 frame	Mbps	3.953	11.664		
UE Category		1-5	2-5		
Note 1: 2 symbols allocated to PDCCH for 20 MHz, 15 MHz and 10 MHz channel BW; 3 symbols allocated to PDCCH for 5 MHz and 3 MHz; 4 symbols allocated to PDCCH for 1.4 MHz Note 2: Reference signal, synchronization signals and PBCH allocated as per TS 36.211 [4] Note 3: If more than one Code Block is present, an additional CRC sequence of L = 24 Bits is attached to each Code Block (otherwise L = 0 Bit)					

## A.3.3.2.2 Four antenna ports

Table A.3.3.2.2-1: Fixed Reference Channel four antenna ports

Parameter	Unit	Value		
		[R.12 FDD]	[R.13 FDD]	[R.14 FDD]
Reference channel				
Channel bandwidth	MHz	1.4	10	10
Allocated resource blocks		6	50	50
Allocated subframes per Radio Frame		10	10	10
Modulation		QPSK	QPSK	16QAM
Target Coding Rate		1/3	1/3	1/2
Information Bit Payload				
For Sub-Frames 1,2,3,4,6,7,8,9	Bits	408	4392	12960
For Sub-Frame 5	Bits	n/a	n/a	n/a
For Sub-Frame 0	Bits	152	3624	11448
Number of Code Blocks per Sub-Frame (see Note 3)				
For Sub-Frames 1,2,3,4,6,7,8,9		1	1	3
For Sub-Frame 5		n/a	n/a	n/a
For Sub-Frame 0		1	1	2
Binary Channel Bits Per Sub-Frame				
For Sub-Frames 1,2,3,4,6,7,8,9	Bits	1248	12800	25600
For Sub-Frame 5	Bits	n/a	n/a	n/a
For Sub-Frame 0	Bits	480	12032	24064
Max. Throughput averaged over 1 frame	Mbps	0.342	3.876	11.513
UE Category		1-5	1-5	2-5
Note 1:	2 symbols allocated to PDCCH for 20 MHz, 15 MHz and 10 MHz channel BW; 3 symbols allocated to PDCCH for 5 MHz and 3 MHz; 4 symbols allocated to PDCCH for 1.4 MHz			
Note 2:	Reference signal, synchronization signals and PBCH allocated as per TS 36.211 [4]			
Note 3:	If more than one Code Block is present, an additional CRC sequence of L = 24 Bits is attached to each Code Block (otherwise L = 0 Bit)			

## A.3.3.3 [RMC for UE-Specific Reference Symbols]

## A.3.4 Reference measurement channels for PDSCH performance requirements (TDD)

## A.3.4.1 Single-antenna transmission (Common Reference Symbols)

Table A.3.4.1-1: Fixed Reference Channel QPSK R=1/3

Parameter	Unit	Value					
		[R.4 TDD]				[R.2 TDD]	
Reference channel							
Channel bandwidth	MHz	1.4	3	5	10	15	20
Allocated resource blocks		6			50		
Uplink-Downlink Configuration (Note 3)		1			1		
Allocated subframes per Radio Frame (D+S)		4+2			4+2		
Modulation		QPSK			QPSK		
Target Coding Rate		1/3			1/3		
Information Bit Payload							
For Sub-Frames 4,9	Bits	408			4392		
For Sub-Frames 1,6	Bits	n/a			3240		
For Sub-Frame 5	Bits	n/a			n/a		
For Sub-Frame 0	Bits	208			4392		
Number of Code Blocks per Sub-Frame (see Note 5)		1			1		
Binary Channel Bits Per Sub-Frame							
For Sub-Frames 4,9	Bits	1368			13800		
For Sub-Frames 1,6	Bits	n/a			11256		
For Sub-Frame 5	Bits	n/a			n/a		
For Sub-Frame 0	Bits	672			13104		
Max. Throughput averaged over 1 frame	Mbps	0.102			1.966		
UE Category		1-5			1-5		
<p>Note 1: 2 symbols allocated to PDCCH for 20 MHz, 15 MHz and 10 MHz channel BW; 3 symbols allocated to PDCCH for 5 MHz and 3 MHz; 4 symbols allocated to PDCCH for 1.4 MHz. For subframe 1&amp;6, only 2 OFDM symbols are allocated to PDCCH.</p> <p>Note 2: For BW=1.4 MHz, the information bit payloads of special subframes are set to zero (no scheduling) to avoid problems with insufficient PDCCH performance at the test point.</p> <p>Note 3: Reference signal, synchronization signals and PBCH allocated as per TS 36.211 [4]</p> <p>Note 4: as per Table 4.2-2 in TS 36.211 [4]</p> <p>Note 5: If more than one Code Block is present, an additional CRC sequence of L = 24 Bits is attached to each Code Block (otherwise L = 0 Bit)</p>							

Table A.3.4.1-2: Fixed Reference Channel 16QAM R=1/2

Parameter	Unit	Value					
						[R.3 TDD]	
Reference channel							
Channel bandwidth	MHz	1.4	3	5	10	15	20
Allocated resource blocks					50		
Uplink-Downlink Configuration (Note 3)					1		
Allocated subframes per Radio Frame (D+S)					4+2		
Modulation					16QAM		
Target Coding Rate					1/2		
Information Bit Payload							
For Sub-Frames 4,9	Bits				14112		
For Sub-Frames 1,6	Bits				11448		
For Sub-Frame 5	Bits				n/a		
For Sub-Frame 0	Bits				12960		
Number of Code Blocks per Sub-Frame (see Note 4)							
For Sub-Frames 4,9					3		

For Sub-Frames 1,6					2		
For Sub-Frame 5					n/a		
For Sub-Frame 0					3		
Binary Channel Bits Per Sub-Frame							
For Sub-Frames 4,9	Bits				27600		
For Sub-Frames 1,6	Bits				22512		
For Sub-Frame 5	Bits				n/a		
For Sub-Frame 0	Bits				26208		
Max. Throughput averaged over 1 frame	Mbps				6.408		
UE Category					2-5		
<p>Note 1: 2 symbols allocated to PDCCH for 20 MHz, 15 MHz and 10 MHz channel BW; 3 symbols allocated to PDCCH for 5 MHz and 3 MHz; 4 symbols allocated to PDCCH for 1.4 MHz. For subframe 1&amp;6, only 2 OFDM symbols are allocated to PDCCH.</p> <p>Note 2: Reference signal, synchronization signals and PBCH allocated as per TS 36.211 [4]</p> <p>Note 3: as per Table 4.2-2 in TS 36.211 [4]</p> <p>Note 4: If more than one Code Block is present, an additional CRC sequence of L = 24 Bits is attached to each Code Block (otherwise L = 0 Bit)</p>							

Table A.3.4.1-3: Fixed Reference Channel 64QAM R=3/4

Parameter	Unit	Value					
		[R.5]	[R.6]	[R.7]	[R.8]	[R.9]	
Reference channel							
Channel bandwidth	MHz	1.4	3	5	10	15	20
Allocated resource blocks			15	25	50	75	100
Uplink-Downlink Configuration (Note 3)			1	1	1	1	1
Allocated subframes per Radio Frame (D+S)			4+2	4+2	4+2	4+2	4+2
Modulation		64QAM	64QAM	64QAM	64QAM	64QAM	64QAM
Target Coding Rate			3/4	3/4	3/4	3/4	3/4
Information Bit Payload							
For Sub-Frames 4,9	Bits		8504	14112	30576	46888	61664
For Sub-Frames 1,6	Bits		6968	11448	23688	35160	46888
For Sub-Frame 5	Bits		n/a	n/a	n/a	n/a	n/a
For Sub-Frame 0	Bits		6968	12576	30576	45352	61664
Number of Code Blocks per Sub-Frame (see Note 4)							
For Sub-Frames 4,9			2	3	5	8	11
For Sub-Frames 1,6			2	2	4	6	8
For Sub-Frame 5			n/a	n/a	n/a	n/a	n/a
For Sub-Frame 0			2	3	5	8	11
Binary Channel Bits Per Sub-Frame							
For Sub-Frames 4,9	Bits		11340	18900	41400	62100	82800
For Sub-Frames 1,6	Bits		9828	16668	33768	50868	67968
For Sub-Frame 5	Bits		n/a	n/a	n/a	n/a	n/a
For Sub-Frame 0	Bits		9252	16812	39312	60012	80712
Max. Throughput averaged over 1 frame	Mbps		3.791	6.370	13.910	20.945	27.877
UE Category			1-5	2-5	2-5	2-5	3-5
<p>Note 1: 2 symbols allocated to PDCCH for 20 MHz, 15 MHz and 10 MHz channel BW; 3 symbols allocated to PDCCH for 5 MHz and 3 MHz; 4 symbols allocated to PDCCH for 1.4 MHz. For subframe 1&amp;6, only 2 OFDM symbols are allocated to PDCCH.</p> <p>Note 2: Reference signal, synchronization signals and PBCH allocated as per TS 36.211 [4]</p> <p>Note 3: as per Table 4.2-2 TS 36.211 [4]</p> <p>Note 4: If more than one Code Block is present, an additional CRC sequence of L = 24 Bits is attached to each Code</p>							

Block (otherwise L = 0 Bit)

Table A.3.4.1-4: Fixed Reference Channel Single PRB

Parameter	Unit	Value					
			[R.0 TDD]		[R.1 TDD]		
Reference channel							
Channel bandwidth	MHz	1.4	3	5	10/20	15	20
Allocated resource blocks			1		1		
Uplink-Downlink Configuration (Note 3)			1		1		
Allocated subframes per Radio Frame (D+S)			4+2		4+2		
Modulation			16QAM		16QAM		
Target Coding Rate			1/2		1/2		
Information Bit Payload							
For Sub-Frames 4,9	Bits		224		256		
For Sub-Frames 1,6	Bits		208		208		
For Sub-Frame 5	Bits		n/a		n/a		
For Sub-Frame 0	Bits		224		256		
Number of Code Blocks per Sub-Frame (see Note 4)			1		1		
Binary Channel Bits Per Sub-Frame							
For Sub-Frames 4,9	Bits		504		552		
For Sub-Frames 1,6	Bits		456		456		
For Sub-Frame 5	Bits		n/a		n/a		
For Sub-Frame 0	Bits		504		552		
Max. Throughput averaged over 1 frame	Mbps		0.109		0.118		
UE Category			1-5		1-5		
Note 1:	2 symbols allocated to PDCCH for 20 MHz, 15 MHz and 10 MHz channel BW; 3 symbols allocated to PDCCH for 5 MHz and 3 MHz; 4 symbols allocated to PDCCH for 1.4 MHz. For subframe 1&6, only 2 OFDM symbols are allocated to PDCCH.						
Note 2:	Reference signal, synchronization signals and PBCH allocated as per TS 36.211 [4]						
Note 3:	as per Table 4.2-2 in TS 36.211 [4]						
Note 4:	If more than one Code Block is present, an additional CRC sequence of L = 24 Bits is attached to each Code Block (otherwise L = 0 Bit)						

**Table A.3.4.1-5: Fixed Reference Channel Single PRB (MBSFN Configuration)**

Parameter	Unit	Value
Reference channel		[R.29 TDD] (MBSFN)
Channel bandwidth	MHz	10
Allocated resource blocks		1
MBSFN Configuration		[TBD]
Uplink-Downlink Configuration (Note 3)		1
Allocated subframes per Radio Frame (D+S)		2+2
Modulation		16QAM
Target Coding Rate		1/2
Information Bit Payload		
For Sub-Frames 4,9	Bits	0 (MBSFN)
For Sub-Frames 1,6	Bits	208
For Sub-Frame 5	Bits	n/a
For Sub-Frame 0	Bits	256
Number of Code Blocks per Sub-Frame (see Note 4)		1
Binary Channel Bits Per Sub-Frame		
For Sub-Frames 4,9	Bits	0 (MBSFN)
For Sub-Frames 1,6	Bits	456
For Sub-Frame 5	Bits	n/a
For Sub-Frame 0	Bits	552
Max. Throughput averaged over 1 frame	kbps	67.2
UE Category		1-5
Note 1:	2 symbols allocated to PDCCH	
Note 2:	Reference signal, synchronization signals and PBCH allocated as per TS 36.211 [4]	
Note 3:	as per Table 4.2-2 in TS 36.211 [4]	
Note 4:	If more than one Code Block is present, an additional CRC sequence of L = 24 Bits is attached to each Code Block (otherwise L = 0 Bit)	

## A.3.4.2 Multi-antenna transmission (Common Reference Signals)

### A.3.4.2.1 Two antenna ports

**Table A.3.4.2.1-1: Fixed Reference Channel two antenna ports**

Parameter	Unit	Value			
		[R.10 TDD]	[R.11 TDD]		
Reference channel					
Channel bandwidth	MHz	10	10		
Allocated resource blocks		50	50		
Uplink-Downlink Configuration (Note 3)		1	1		
Allocated subframes per Radio Frame (D+S)		4+2	4+2		
Modulation		QPSK	16QAM		
Target Coding Rate		1/3	1/2		
Information Bit Payload					
For Sub-Frames 4,9	Bits	4392	12960		
For Sub-Frames 1,6		3240	9528		
For Sub-Frame 5	Bits	n/a	n/a		
For Sub-Frame 0	Bits	4392	12960		
Number of Code Blocks per Sub-Frame (see Note 4)					
For Sub-Frames 4,9		1	3		
For Sub-Frames 1,6		1	2		
For Sub-Frame 5		n/a	n/a		
For Sub-Frame 0		1	3		
Binary Channel Bits Per Sub-Frame					
For Sub-Frames 4,9	Bits	13200	26400		
For Sub-Frames 1,6		10656	21312		
For Sub-Frame 5	Bits	n/a	n/a		
For Sub-Frame 0	Bits	12528	25056		
Max. Throughput averaged over 1 frame	Mbps	1.966	5.794		
UE Category		1-5	2-5		
Note 1:	2 symbols allocated to PDCCH for 20 MHz, 15 MHz and 10 MHz channel BW; 3 symbols allocated to PDCCH for 5 MHz and 3 MHz; 4 symbols allocated to PDCCH for 1.4 MHz. For subframe 1&6, only 2 OFDM symbols are allocated to PDCCH.				
Note 2:	Reference signal, synchronization signals and PBCH allocated as per TS 36.211 [4]				
Note 3:	as per Table 4.2-2 in TS 36.211 [4]				
Note 4:	If more than one Code Block is present, an additional CRC sequence of L = 24 Bits is attached to each Code Block (otherwise L = 0 Bit)				

## A.3.4.2.2 Four antenna ports

Table A.3.4.2.2-1: Fixed Reference Channel four antenna ports

Parameter	Unit	Value		
		[R.12 TDD]	[R.13 TDD]	[R.14 TDD]
Reference channel				
Channel bandwidth	MHz	1.4	10	10
Allocated resource blocks		6	50	50
Uplink-Downlink Configuration (Note 4)		1	1	1
Allocated subframes per Radio Frame (D+S)		4+2	4+2	4+2
Modulation		QPSK	QPSK	16QAM
Target Coding Rate		1/3	1/3	1/2
Information Bit Payload				
For Sub-Frames 4,9	Bits	408	4392	12960
For Sub-Frames 1,6	Bits	n/a	3240	9528
For Sub-Frame 5	Bits	n/a	n/a	n/a
For Sub-Frame 0	Bits	208	4392	11448
Number of Code Blocks per Sub-Frame (see Note 5)				
For Sub-Frames 4,9		1	1	3
For Sub-Frames 1,6		n/a	1	2
For Sub-Frame 5		n/a	n/a	n/a
For Sub-Frame 0		1	1	2
Binary Channel Bits Per Sub-Frame				
For Sub-Frames 4,9	Bits	1248	12800	25600
For Sub-Frames 1,6		n/a	10256	20512
For Sub-Frame 5	Bits	n/a	n/a	n/a
For Sub-Frame 0	Bits	624	12176	24352
Max. Throughput averaged over 1 frame	Mbps	0.102	1.966	5.642
UE Category		1-5	1-5	2-5
Note 1:	2 symbols allocated to PDCCH for 20 MHz, 15 MHz and 10 MHz channel BW; 3 symbols allocated to PDCCH for 5 MHz and 3 MHz; 4 symbols allocated to PDCCH for 1.4 MHz. For subframe 1&6, only 2 OFDM symbols are allocated to PDCCH.			
Note 2:	For BW=1.4 MHz, the information bit payloads of special subframes are set to zero (no scheduling) to avoid problems with insufficient PDCCH performance at the test point.			
Note 3:	Reference signal, synchronization signals and PBCH allocated as per TS 36.211 [4]			
Note 4:	as per Table 4.2-2 in TS 36.211 [4]			
Note 5:	If more than one Code Block is present, an additional CRC sequence of L = 24 Bits is attached to each Code Block (otherwise L = 0 Bit)			



## A.3.4.3 [RMC for UE-Specific Reference Symbols]

Table A.3.4.3-1: Fixed Reference Channel for UE-specific reference symbols

Parameter	Unit	Value			
		[R.25 TDD]	[R.26 TDD]	[R.27 TDD]	[R.28 TDD]
Reference channel					
Channel bandwidth	MHz	10	10	10	10
Allocated resource blocks		50 <sup>4</sup>	50 <sup>4</sup>	50 <sup>4</sup>	1
Uplink-Downlink Configuration (Note 3)		1	1	1	1
Allocated subframes per Radio Frame (D+S)		4+2	4+2	4+2	4+2
Modulation		QPSK	16QAM	64QAM	16QAM
Target Coding Rate		1/3	1/2	3/4	1/2
Information Bit Payload					
For Sub-Frames 4,9	Bits	4392	12960	28336	224
For Sub-Frames 1,6	Bits	3240	9528	22920	176
For Sub-Frame 5	Bits	n/a	n/a	n/a	n/a
For Sub-Frame 0	Bits	2984	9528	22152	224
Number of Code Blocks per Sub-Frame (see Note 5)					
For Sub-Frames 4,9		1	3	5	1
For Sub-Frames 1,6		1	2	4	1
For Sub-Frame 5		n/a	n/a	n/a	n/a
For Sub-Frame 0		1	2	4	1
Binary Channel Bits Per Sub-Frame					
For Sub-Frames 4,9	Bits	12600	25200	37800	504
For Sub-Frames 1,6	Bits	10356	20712	31068	420
For Sub-Frame 5	Bits	n/a	n/a	n/a	n/a
For Sub-Frame 0	Bits	10332	20664	30996	504
Max. Throughput averaged over 1 frame	Mbps	1.825	5.450	12.466	0.102
UE Category		1-5	2-5	2-5	1-5
Note 1:	2 symbols allocated to PDCCH for 20 MHz, 15 MHz and 10 MHz channel BW; 3 symbols allocated to PDCCH for 5 MHz and 3 MHz; 4 symbols allocated to PDCCH for 1.4 MHz. For subframe 1&6, only 2 OFDM symbols are allocated to PDCCH.				
Note 2:	Reference signal, synchronization signals and PBCH allocated as per TS 36.211 [4]				
Note 3:	as per Table 4.2-2 in TS 36.211 [4]				
Note 4:	For R.25, R.26 and R.27, 50 resource blocks are allocated in sub-frames 1–9 and 41 resource blocks (RB0–RB20 and RB30–RB49) are allocated in sub-frame 0.				
Note 5:	If more than one Code Block is present, an additional CRC sequence of L = 24 Bits is attached to each Code Block (otherwise L = 0 Bit)				

## A.3.5 Reference measurement channels for PDCCH/PCFICH performance requirements

### A.3.5.1 FDD

Table A.3.5.1-1: Reference Channel FDD

<i>Parameter</i>	<i>Unit</i>	<i>Value</i>		
		<i>[R.15 FDD]</i>	<i>[R.16 FDD]</i>	<i>[R.17 FDD]</i>
<i>Reference channel</i>				
<i>Number of transmitter antennas</i>		1	2	4
<i>Channel bandwidth</i>	<i>MHz</i>	10	1.4	10
<i>Number of OFDM symbols for PDCCH</i>	<i>symbols</i>	2	2	2
<i>Aggregation level</i>	<i>CCE</i>	8	2	4
<i>DCI Format</i>		<i>Format 1</i>	<i>Format 1</i>	<i>Format 2</i>
<i>Cell ID</i>		0	0	0
<i>Payload (without CRC)</i>	<i>Bits</i>	31	32+1	46

### A.3.5.2 TDD

Table A.3.5.1-1: Reference Channel TDD

<i>Parameter</i>	<i>Unit</i>	<i>Value</i>		
		<i>[R.15 TDD]</i>	<i>[R.16 TDD]</i>	<i>[R.17 TDD]</i>
<i>Reference channel</i>				
<i>Number of transmitter antennas</i>		1	2	4
<i>Channel bandwidth</i>	<i>MHz</i>	10	1.4	10
<i>Number of OFDM symbols for PDCCH</i>	<i>symbols</i>	2	2	2
<i>Aggregation level</i>	<i>CCE</i>	8	2	4
<i>DCI Format</i>		<i>Format 1</i>	<i>Format 1</i>	<i>Format 2</i>
<i>Cell ID</i>		0	0	0
<i>Payload (without CRC)</i>	<i>Bits</i>	34	35	49

---

## A.4 CQI reference measurement channels

This section defines the DL signal applicable to the reporting of channel quality information (clause 9.2).

The reference channel in Table A.4-1 complies with the CQI definition specified in Sec. 7.2.3 of [6]. Table A.4-2 specifies the transport format corresponding to each CQI.

Table A.4-1: Reference channel for CQI requirements (FDD)

Parameter	Unit	Value					
		1.4	3	5	10	15	20
Channel bandwidth	MHz	1.4	3	5	10	15	20
Allocated resource blocks		6	15	25	50	75	100
Subcarriers per resource block		12	12	12	12	12	12
Allocated subframes per Radio Frame		8	8	8	8	8	8
Modulation					Table A.4-3		
Target coding rate					Table A.4-3		
Number of HARQ Processes	Processes	8	8	8	8	8	8
Maximum number of HARQ transmissions		1	1	1	1	1	1
Note 1: 3 symbols allocated to PDCCH Note 2: Only subframes 1,2,3,4,6,7,8, and 9 are allocated to avoid PBCH and synchronization signal overhead Note 3: The RLC should be configured to Unacknowledged Mode							

Table A.4-2: Reference channel for CQI requirements (TDD)

Parameter	Unit	Value					
		1.4	3	5	10	15	20
Channel bandwidth	MHz	1.4	3	5	10	15	20
Allocated resource blocks		6	15	25	50	75	100
Subcarriers per resource block		12	12	12	12	12	12
Allocated subframes per Radio Frame		4	4	4	4	4	4
Modulation					Table A.4-3		
Target coding rate					Table A.4-3		
Number of HARQ Processes	Processes	10	10	10	10	10	10
Maximum number of HARQ transmissions		1	1	1	1	1	1
Note 1: 3 symbols allocated to PDCCH Note 2: UL-DL configuration 2 is used and only subframes 3, 4, 8, and 9 are allocated to avoid PBCH and synchronization signal overhead Note 3: The RLC should be configured to Unacknowledged Mode							

Table A.4-3: Transport format corresponding to each CQI index for  $N_{RB}=50$ 

CQI index	Modulation	Target code rate	Imcs	Information Bit Payload (Subframes 1,2,3,4,6,7,8,9)	Binary Channel Bits Per Sub-Frame (Subframes 1,2,3,4,6,7,8,9)	Actual Code rate
0	out of range	out of range	DTX	-	12600	-
1	QPSK	0.0762	0	1384	12600	0.1117
2	QPSK	0.1172	0	1384	12600	0.1117
3	QPSK	0.1885	2	2216	12600	0.1778
4	QPSK	0.3008	4	3624	12600	0.2895
5	QPSK	0.4385	6	5160	12600	0.4114
6	QPSK	0.5879	8	6968	12600	0.5549
7	16QAM	0.3691	11	8760	25200	0.3486
8	16QAM	0.4785	13	11448	25200	0.4552
9	16QAM	0.6016	16	15264	25200	0.6067
10	64QAM	0.4551	18	16416	37800	0.4349
11	64QAM	0.5537	21	21384	37800	0.5663
12	64QAM	0.6504	23	25456	37800	0.6741
13	64QAM	0.7539	25	28336	37800	0.7503
14	64QAM	0.8525	27	31704	37800	0.8394
15	64QAM	0.9258	28	36696	37800	0.9714

## A.5 OFDMA Channel Noise Generator (OCNG)

### A.5.1 OCNG Patterns for FDD

#### A.5.1.1 OCNG FDD pattern 1: 14 RB OCNG allocation in 3 MHz

**Table A.5.1.1-1: OP.1 FDD: OCNG FDD Pattern 1**

Allocation $n_{PRB}$	Relative power level $\gamma_{PRB}$ [dB]									PDSCH Data
	Subframe									
CP length	0			5			1 – 4, 6 – 9			Note 2
	Control region OFDM symbols									
	1	2	3	1	2	3	1	2	3	
1 – 14	N	0	0	0	0	0	0	0	0	Note 1

**Note 1:** These physical resource blocks are assigned to an arbitrary number of virtual UEs with one PDSCH per virtual UE; the data transmitted over the OCNG PDSCHs shall be uncorrelated pseudo random data, which is QPSK modulated.

**Note 2:** The control region consists of PCFICH, PHICH and PDCCH. Number of OFDM symbols belonging to the control region may vary between subframes.

**Note 3:** If two or more transmit antennas are used in the test, the OCNG shall be transmitted to the virtual users by all the transmit antennas according to transmission mode 2. The transmit power shall be equally split between all the transmit antennas used in the test. The antenna transmission modes are specified in section 7.1 in 3GPP TS 36.213.

**N:** Normal

### A.5.1.2 OCNG FDD pattern 2: 49 RB OCNG allocation in 10 MHz

**Table A.5.1.2-1: OP.2 FDD: OCNG FDD Pattern 2**

Allocation	Relative power level $\gamma_{PRB}$ [dB]						PDSCH Data
$n_{PRB}$	CP length	Subframe					
		0		5		1 – 4, 6 – 9	
		Control region OFDM symbols <sup>Note 2</sup>					
		1	2	1	2	1	2
1 – 49	N	0	0	0	0	0	Note 1

**Note 1:** These physical resource blocks are assigned to an arbitrary number of virtual UEs with one PDSCH per virtual UE; the data transmitted over the OCNG PDSCHs shall be uncorrelated pseudo random data, which is QPSK modulated.

**Note 2:** The control region consists of PCFICH, PHICH and PDCCH. Number of OFDM symbols belonging to the control region may vary between subframes.

**Note 3:** If two or more transmit antennas are used in the test, the OCNG shall be transmitted to the virtual users by all the transmit antennas according to transmission mode 2. The transmit power shall be equally split between all the transmit antennas used in the test. The antenna transmission modes are specified in section 7.1 in 3GPP TS 36.213.

N: Normal

### A.5.1.3 OCNG FDD pattern 3: 99 RB OCNG allocation in 20 MHz

**Table A.5.1.3-1: OP.3 FDD: OCNG FDD Pattern 3**

Allocation	Relative power level $\gamma_{PRB}$ [dB]						PDSCH Data
$n_{PRB}$	CP length	Subframe					
		0		5		1 – 4, 6 – 9	
		Control region OFDM symbols <sup>Note 2</sup>					
		1	2	1	2	1	2
1 – 99	N	0	0	0	0	0	Note 1

**Note 1:** These physical resource blocks are assigned to an arbitrary number of virtual UEs with one PDSCH per virtual UE; the data transmitted over the OCNG PDSCHs shall be uncorrelated pseudo random data, which is QPSK modulated.

**Note 2:** The control region consists of PCFICH, PHICH and PDCCH. Number of OFDM symbols belonging to the control region may vary between subframes.

**Note 3:** If two or more transmit antennas are used in the test, the OCNG shall be transmitted to the virtual users by all the transmit antennas according to transmission mode 2. The transmit power shall be equally split between all the transmit antennas used in the test. The antenna transmission modes are specified in section 7.1 in 3GPP TS 36.213.

N: Normal

### A.5.1.4 OCNG FDD pattern 4: 49 RB OCNG allocation with MBSFN in 10 MHz

**Table A.5.1.4-1: OP.4 FDD: OCNG FDD Pattern 4**

Allocation $n_{PRB}$	CP length	Relative power level $\gamma_{PRB}$ [dB]				PDSCH Data	PMCH Data
		Subframe					
		0	5	4, 9	1 – 3, 6 – 8		
		Control region OFDM symbols <sup>Note 2</sup>					
		1	2	1	2		
1 – 49	N	0	0	0	N/A	Note 1	N/A
0 – 49	N	N/A	N/A	N/A	0	N/A	Note 3

**Note 1:** These physical resource blocks are assigned to an arbitrary number of virtual UEs with one PDSCH per virtual UE; the data transmitted over the OCNG PDSCHs shall be uncorrelated pseudo random data, which is QPSK modulated.

**Note 2:** The control region consists of PCFICH, PHICH and PDCCH. Number of OFDM symbols belonging to the control region may vary between subframes.

**Note 3:** Each physical resource block (PRB) is assigned to MBSFN transmission. The data in each PRB shall be uncorrelated with data in other PRBs over the period of any measurement. The MBSFN data shall be QPSK modulated. PMCH subframes shall contain cell-specific Reference Signals only in the first symbol of the first time slot. The parameter  $\gamma_{PRB}$  is used to scale the power of PMCH.

**Note 4:** If two or more transmit antennas are used in the test, the OCNG shall be transmitted to the virtual users by all the transmit antennas according to transmission mode 2. The transmit power shall be equally split between all the transmit antennas used in the test. The antenna transmission modes are specified in section 7.1 in 3GPP TS 36.213.

**N:** Normal  
**N/A:** Not Applicable

### A.5.1.5 OCNG FDD patterns 5-9 for Maximum input level

**Table A.5.1.5-1: OP.5-9 FDD: OCNG FDD Patterns 5-9 for Maximum input level**

Allocation	Relative power level $\gamma_{PRB}$ [dB]									PDSCH Data	
$n_{PRB}$	CP length	Subframe									
		0			5			1 – 4, 6 – 9			
		Control region OFDM symbols <sup>Note 2</sup>									
		1	2	3	1	2	3	1	2	3	
Table A.5.1.x-2	N	0			N/A			0		Note 1	

**Note 1:** These physical resource blocks are assigned to an arbitrary number of virtual UEs with one PDSCH per virtual UE; the data transmitted over the OCNG PDSCHs shall be uncorrelated pseudo random data, which is QPSK modulated.

**Note 2:** The control region consists of PCFICH, PHICH and PDCCH. Number of OFDM symbols belonging to the control region may vary between subframes.

N: Normal

**Table A.5.1.5-2: OP.5-9 FDD: Allocation parameters for OCNG FDD Patterns 5-9 for Maximum input level**

OCNG FDD Pattern	Fixed Reference Channel for Maximum input level for:	Allocation $n_{PRB}$
OP.5 FDD	UE Category 1 (FDD), Channel BW 5 MHz	16-24
OP.6 FDD	UE Category 1 (FDD), Channel BW 10 MHz	16-49
OP.7 FDD	UE Category 1 (FDD), Channel BW 15 MHz	16-74
OP.8 FDD	UE Category 1 (FDD), Channel BW 20 MHz	16-99
OP.9 FDD	UE Category 2 (FDD), Channel BW 20 MHz	80-99

## A.5.2 OCNG Patterns for TDD

### A.5.2.1 OCNG TDD pattern 1: 14 RB OCNG allocation in 3 MHz

**Table A.5.2.1-1: OP.1 TDD: OCNG TDD Pattern 1 for 5ms downlink-to-uplink switch-point periodicity**

Allocation $n_{PRB}$	CP length	Relative power level $\gamma_{PRB}$ [dB]										PDSCH Data	
		Subframe											
		0			5			4, 9 <sup>Note 2</sup>			1, 6		
		Control region OFDM symbols <sup>Note 3</sup>											
		1	2	3	1	2	3	1	2	3	1	2	
1 – 14	N	0			0			0			Table A.5.2.1-2		Note 1

**Note 1:** These physical resource blocks are assigned to an arbitrary number of virtual UEs with one PDSCH per virtual UE; the data transmitted over the OCNG PDSCHs shall be uncorrelated pseudo random data, which is QPSK modulated.

**Note 2:** Subframes available for DL transmission depends on the Uplink-Downlink configuration in Table 4.2-2 in 3GPP TS 36.211.

**Note 3:** The control region consists of PCFICH, PHICH and PDCCH. Number of OFDM symbols belonging to the control region may vary between subframes.

**Note 4:** If two or more transmit antennas are used in the test, the OCNG shall be transmitted to the virtual users by all the transmit antennas according to transmission mode 2. The transmit power shall be equally split between all the transmit antennas used in the test. The antenna transmission modes are specified in section 7.1 in 3GPP TS 36.213.

N: Normal

**Table A.5.2.1-2: OP.1 TDD: OCNG TDD Pattern 1 for special subframe configuration with 5ms downlink-to-uplink switch-point periodicity**

Allocation $n_{PRB}$	CP length	Relative power level $\gamma_{PRB}$ [dB]																	
		Special subframe configuration																	
		0		1		2		3		4		5		6		7		8	
		Control region OFDM symbols																	
		1	2	1	2	1	2	1	2	1	2	1	2	1	2	1	2	1	2
1 – 14	N	0		0		0		0		0		0		0		0		0	

**Note 1:** Special subframe configurations are defined in Table 4.2-1 in 3GPP TS 36.211.



### A.5.2.2 OCNG TDD pattern 2: 49 RB OCNG allocation in 10 MHz

**Table A.5.2.2-1: OP.2 TDD: OCNG TDD Pattern 2 for 5ms downlink-to-uplink switch-point periodicity**

Allocation		Relative power level $\gamma_{PRB}$ [dB]								PDSCH Data
$n_{PRB}$	CP length	Subframe								
		0		5		4, 9 <sup>Note 2</sup>		1, 6		
		Control region OFDM symbols <sup>Note 3</sup>								
		1	2	1	2	1	2	1	2	
1 – 49	N	0		0		0		Table A.5.2.2-2		Note 1

**Note 1:** These physical resource blocks are assigned to an arbitrary number of virtual UEs with one PDSCH per virtual UE; the data transmitted over the OCNG PDSCHs shall be uncorrelated pseudo random data, which is QPSK modulated.

**Note 2:** Subframes available for DL transmission depends on the Uplink-Downlink configuration in Table 4.2-2 in 3GPP TS 36.211.

**Note 3:** The control region consists of PCFICH, PHICH and PDCCH. Number of OFDM symbols belonging to the control region may vary between subframes.

**Note 4:** If two or more transmit antennas are used in the test, the OCNG shall be transmitted to the virtual users by all the transmit antennas according to transmission mode 2. The transmit power shall be equally split between all the transmit antennas used in the test. The antenna transmission modes are specified in section 7.1 in 3GPP TS 36.213.

N: Normal

**Table A.5.2.2-2: OP.2 TDD: OCNG TDD Pattern 2 for special subframe configuration with 5ms downlink-to-uplink switch-point periodicity**

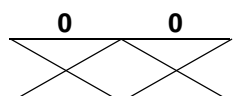
Allocation		Relative power level $\gamma_{PRB}$ [dB]																		
$n_{PRB}$	CP length	Special subframe configuration																		
		0	1	2	3	4	5	6	7	8										
		Control region OFDM symbols																		
		1	2	1	2	1	2	1	2	1	2	1	2	1	2	1	2			
1 – 49	N	0		0		0		0		0		0		0		0		0	0	

**Note 1:** Special subframe configurations are defined in Table 4.2-1 in 3GPP TS 36.211.

### A.5.2.3 OCNG TDD pattern 3: 99 RB OCNG allocation in 20 MHz

**Table A.5.2.3-1: OP.3 TDD: OCNG TDD Pattern 3 for 5ms downlink-to-uplink switch-point periodicity**

Allocation		Relative power level $\gamma_{PRB}$ [dB]								PDSCH Data
$n_{PRB}$	CP length	Subframe								
		0		5		4, 9 <sup>Note 2</sup>		1, 6		
		Control region OFDM symbols <sup>Note 3</sup>								
		1	2	1	2	1	2	1	2	
1 – 99	N	0		0		0		Table A.5.2.3-2		Note 1

**Note 1:** These physical resource blocks are assigned to an arbitrary number of virtual UEs with one PDSCH per virtual UE; the data transmitted over the OCNG PDSCHs shall be uncorrelated pseudo random data, which is QPSK modulated.

**Note 2:** Subframes available for DL transmission depends on the Uplink-Downlink configuration in Table 4.2-2 in 3GPP TS 36.211.

**Note 3:** The control region consists of PCFICH, PHICH and PDCCH. Number of OFDM symbols belonging to the control region may vary between subframes.

**Note 4:** If two or more transmit antennas are used in the test, the OCNG shall be transmitted to the virtual users by all the transmit antennas according to transmission mode 2. The transmit power shall be equally split between all the transmit antennas used in the test. The antenna transmission modes are specified in section 7.1 in 3GPP TS 36.213.

N: Normal

**Table A.5.2.3-2: OP.3 TDD: OCNG TDD Pattern 3 for special subframe configuration with 5ms downlink-to-uplink switch-point periodicity**

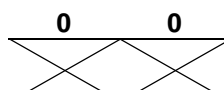
Allocation		Relative power level $\gamma_{PRB}$ [dB]														
$n_{PRB}$	CP length	Special subframe configuration														
		0	1	2	3	4	5	6	7	8						
		Control region OFDM symbols														
		1	2	1	2	1	2	1	2	1	2	1	2	1	2	
1 – 99	N	0		0		0		0		0		0		0		

**Note 1:** Special subframe configurations are defined in Table 4.2-1 in 3GPP TS 36.211.

### A.5.2.4 OCNG TDD pattern 4: 49 RB OCNG allocation with MBSFN in 10 MHz

**Table A.5.2.4-1: OP.4 TDD: OCNG TDD Pattern 4 for 5ms downlink-to-uplink switch-point periodicity**

Allocation $n_{PRB}$	CP length	Relative power level $\gamma_{PRB}$ [dB]								PDSCH Data	PMCH Data	
		Subframe										
		0		5		4, 9 <sup>Note 2</sup>		1, 6				
		Control region OFDM symbols <sup>Note 3</sup>										
		1	2	1	2	1	2	1	2			
1 – 49	N	0		0		N/A				Table A.5.2.4-2	Note 1	N/A
0 – 49	N	N/A		N/A		0		N/A		N/A	Note 4	

**Note 1:** These physical resource blocks are assigned to an arbitrary number of virtual UEs with one PDSCH per virtual UE; the data transmitted over the OCNG PDSCHs shall be uncorrelated pseudo random data, which is QPSK modulated.

**Note 2:** Subframes available for DL transmission depends on the Uplink-Downlink configuration in Table 4.2-2 in 3GPP TS 36.211.

**Note 3:** The control region consists of PCFICH, PHICH and PDCCH. Number of OFDM symbols belonging to the control region may vary between subframes.

**Note 4:** Each physical resource block (PRB) is assigned to MBSFN transmission. The data in each PRB shall be uncorrelated with data in other PRBs over the period of any measurement. The MBSFN data shall be QPSK modulated. PMCH symbols shall not contain cell-specific Reference Signals

**Note 5:** If two or more transmit antennas are used in the test, the OCNG shall be transmitted to the virtual users by all the transmit antennas according to transmission mode 2. The transmit power shall be equally split between all the transmit antennas used in the test. The antenna transmission modes are specified in section 7.1 in 3GPP TS 36.213.

N: Normal  
N/A: Not Applicable

**Table A.5.2.4-2: OP.4 TDD: OCNG TDD Pattern 4 for special subframe configuration with 5ms downlink-to-uplink switch-point periodicity**

Allocation $n_{PRB}$	CP length	Relative power level $\gamma_{PRB}$ [dB]																	
		Special subframe configuration																	
		0	1	2	3	4	5	6	7	8	Control region OFDM symbols								
		1	2	1	2	1	2	1	2	1	2	1	2	1	2	1	2		
1 – 49	N	0		0		0		0		0		0		0		0		0	0

**Note 1:** Special subframe configurations are defined in Table 4.2-1 in 3GPP TS 36.211 [16].

### A.5.2.5 OCNG TDD patterns 5-9 for Maximum input level

Table A.5.2.5-1: OP.5-9 TDD: OCNG TDD Patterns 5-9 for Maximum input level

Allocation		Relative power level $\gamma_{PRB}$ [dB]												PDSCH Data
$n_{PRB}$	CP length	Subframe												
		0			5			4, 9 <sup>Note 2</sup>			1, 6			
		Control region OFDM symbols <sup>Note 3</sup>												
		1	2	3	1	2	3	1	2	3	1	2		
Table A.5.2.x-3	N	0			N/A			0			Table A.5.2.x-2			Note 1

Note 1: These physical resource blocks are assigned to an arbitrary number of virtual UEs with one PDSCH per virtual UE; the data transmitted over the OCNG PDSCHs shall be uncorrelated pseudo random data, which is QPSK modulated.

Note 2: Subframes available for DL transmission depends on the Uplink-Downlink configuration in Table 4.2-2 in 3GPP TS 36.211.

Note 3: The control region consists of PCFICH, PHICH and PDCCH. Number of OFDM symbols belonging to the control region may vary between subframes.

N: Normal

Table A.5.2.5-2: OP.5-9 TDD: Special subframe configuration with 5ms downlink-to-uplink switch-point periodicity for OCNG TDD Patterns 5-9 for Maximum input level

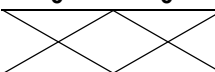
Allocation		Relative power level $\gamma_{PRB}$ [dB]																			
$n_{PRB}$	CP length	Special subframe configuration																			
		0	1	2	3	4	5	6	7	8	Control region OFDM symbols										
		1	2	1	2	1	2	1	2	1	2	1	2	1	2	1	2	1	2	1	2
Table A.5.2.x-3	N	0	0	0	0	0	0	0	0	0	0	0	0	0	0	0	0	0	0		

Note 1: Special subframe configurations are defined in Table 4.2-1 in 3GPP TS 36.211.

**Table A.5.2.5-3: OP.5-9 TDD: Allocation parameters for OCNG TDD Patterns 5-9 for Maximum input level**

<b>OCNG TDD Pattern</b>	<b>Fixed Reference Channel for Maximum input level for:</b>	<b>Allocation <math>n_{PRB}</math></b>
OP.5 TDD	UE Category 1 (TDD), Channel BW 5 MHz	16-24
OP.6 TDD	UE Category 1 (TDD), Channel BW 10 MHz	16-49
OP.7 TDD	UE Category 1 (TDD), Channel BW 15 MHz	16-74
OP.8 TDD	UE Category 1 (TDD), Channel BW 20 MHz	16-99
OP.9 TDD	UE Category 2 (TDD), Channel BW 20 MHz	80-99

---

## Annex B (normative): Propagation conditions

---

### B.1 Static propagation condition

For 2 port transmission the channel matrix is defined in the frequency domain by

$$\mathbf{H} = \begin{pmatrix} 1 & j \\ 1 & -j \end{pmatrix}.$$

---

### B.2 Multi-path fading propagation conditions

The multipath propagation conditions consist of several parts:

- A delay profile in the form of a "tapped delay-line", characterized by a number of taps at fixed positions on a sampling grid. The profile can be further characterized by the r.m.s. delay spread and the maximum delay spanned by the taps.
- A combination of channel model parameters that include the Delay profile and the Doppler spectrum, that is characterized by a classical spectrum shape and a maximum Doppler frequency
- A set of correlation matrices defining the correlation between the UE and eNodeB antennas in case of multi-antenna systems.
- Additional multi-path models used for CQI (Channel Quality Indication) tests

#### B.2.1 Delay profiles

The delay profiles are selected to be representative of low, medium and high delay spread environments. The resulting model parameters are defined in Table B.2.1-1 and the tapped delay line models are defined in Tables B.2.1-2, B.2.1-3 and B.2.1-4.

**Table B.2.1-1 Delay profiles for E-UTRA channel models**

Model	Number of channel taps	Delay spread (r.m.s.)	Maximum excess tap delay (span)
Extended Pedestrian A (EPA)	7	45 ns	410 ns
Extended Vehicular A model (EVA)	9	357 ns	2510 ns
Extended Typical Urban model (ETU)	9	991 ns	5000 ns

**Table B.2.1-2 Extended Pedestrian A model (EPA)**

Excess tap delay [ns]	Relative power [dB]
0	0.0
30	-1.0
70	-2.0
90	-3.0
110	-8.0
190	-17.2
410	-20.8

**Table B.2.1-3 Extended Vehicular A model (EVA)**

Excess tap delay [ns]	Relative power [dB]
0	0.0
30	-1.5
150	-1.4
310	-3.6
370	-0.6
710	-9.1
1090	-7.0
1730	-12.0
2510	-16.9

**Table B.2.1-4 Extended Typical Urban model (ETU)**

Excess tap delay [ns]	Relative power [dB]
0	-1.0
50	-1.0
120	-1.0
200	0.0
230	0.0
500	0.0
1600	-3.0
2300	-5.0
5000	-7.0

## B.2.2 Combinations of channel model parameters

Table B.2.2-1 shows propagation conditions that are used for the performance measurements in multi-path fading environment for low, medium and high Doppler frequencies

**Table B.2.2-1 Channel model parameters**

Model	Maximum Doppler frequency
EPA 5Hz	5 Hz
EVA 5Hz	5 Hz
EVA 70Hz	70 Hz
ETU 70Hz	70 Hz
ETU 300Hz	300 Hz

## B.2.3 MIMO Channel Correlation Matrices

### B.2.3.1 Definition of MIMO Correlation Matrices

Table B.2.3.1-1 defines the correlation matrix for the eNodeB

**Table B.2.3.1-1 eNodeB correlation matrix**

	One antenna	Two antennas	Four antennas
<b>eNode B Correlation</b>	$R_{eNB} = 1$	$R_{eNB} = \begin{pmatrix} 1 & \alpha \\ \alpha^* & 1 \end{pmatrix}$	$R_{eNB} = \begin{pmatrix} 1 & \alpha^{1/9} & \alpha^{4/9} & \alpha \\ \alpha^{1/9*} & 1 & \alpha^{1/9} & \alpha^{4/9} \\ \alpha^{4/9*} & \alpha^{1/9*} & 1 & \alpha^{1/9} \\ \alpha^* & \alpha^{4/9*} & \alpha^{1/9*} & 1 \end{pmatrix}$

Table B.2.3.1-2 defines the correlation matrix for the UE:

**Table B.2.3.1-2 UE correlation matrix**

	One antenna	Two antennas	Four antennas
<b>UE Correlation</b>	$R_{UE} = 1$	$R_{UE} = \begin{pmatrix} 1 & \beta \\ \beta^* & 1 \end{pmatrix}$	$R_{UE} = \begin{pmatrix} 1 & \beta^{1/9} & \beta^{4/9} & \beta \\ \beta^{1/9*} & 1 & \beta^{1/9} & \beta^{4/9} \\ \beta^{4/9*} & \beta^{1/9*} & 1 & \beta^{1/9} \\ \beta^* & \beta^{4/9*} & \beta^{1/9*} & 1 \end{pmatrix}$

Table B.2.3.1-3 defines the channel spatial correlation matrix  $R_{spat}$ . The parameters,  $\alpha$  and  $\beta$  in Table B.2.3.1-3 defines the spatial correlation between the antennas at the eNodeB and UE.



**Table B.2.3.1-3:  $R_{spat}$  correlation matrices**

<b>1x2 case</b>	$R_{spat} = R_{UE} = \begin{bmatrix} 1 & \beta \\ \beta^* & 1 \end{bmatrix}$
<b>2x2 case</b>	$R_{spat} = R_{eNB} \otimes R_{UE} = \begin{bmatrix} 1 & \alpha \\ \alpha^* & 1 \end{bmatrix} \otimes \begin{bmatrix} 1 & \beta \\ \beta^* & 1 \end{bmatrix} = \begin{bmatrix} 1 & \beta & \alpha & \alpha\beta \\ \beta^* & 1 & \alpha\beta^* & \alpha \\ \alpha^* & \alpha^*\beta & 1 & \beta \\ \alpha^*\beta^* & \alpha^* & \beta^* & 1 \end{bmatrix}$
<b>4x2 case</b>	$R_{spat} = R_{eNB} \otimes R_{UE} = \begin{bmatrix} 1 & \alpha^{1/9} & \alpha^{4/9} & \alpha \\ \alpha^{1/9*} & 1 & \alpha^{1/9} & \alpha^{4/9} \\ \alpha^{4/9*} & \alpha^{1/9*} & 1 & \alpha^{1/9} \\ \alpha^* & \alpha^{4/9*} & \alpha^{1/9*} & 1 \end{bmatrix} \otimes \begin{bmatrix} 1 & \beta \\ \beta^* & 1 \end{bmatrix}$
<b>4x4 case</b>	$R_{spat} = R_{eNB} \otimes R_{UE} = \begin{bmatrix} 1 & \alpha^{1/9} & \alpha^{4/9} & \alpha \\ \alpha^{1/9*} & 1 & \alpha^{1/9} & \alpha^{4/9} \\ \alpha^{4/9*} & \alpha^{1/9*} & 1 & \alpha^{1/9} \\ \alpha^* & \alpha^{4/9*} & \alpha^{1/9*} & 1 \end{bmatrix} \otimes \begin{bmatrix} 1 & \beta^{1/9} & \beta^{4/9} & \beta \\ \beta^{1/9*} & 1 & \beta^{1/9} & \beta^{4/9} \\ \beta^{4/9*} & \beta^{1/9*} & 1 & \beta^{1/9} \\ \beta^* & \beta^{4/9*} & \beta^{1/9*} & 1 \end{bmatrix}$

For cases with more antennas at either eNodeB or UE or both, the channel spatial correlation matrix can still be expressed as the Kronecker product of  $R_{eNB}$  and  $R_{UE}$  according to  $R_{spat} = R_{eNB} \otimes R_{UE}$ .

### B.2.3.2 MIMO Correlation Matrices at High, Medium and Low Level

The  $\alpha$  and  $\beta$  for different correlation types are given in Table B.2.3.2-1.

**Table B.2.3.2-1**

Low correlation		Medium Correlation		High Correlation	
$\alpha$	$\beta$	$\alpha$	$\beta$	$\alpha$	$\beta$
0	0	0.3	0.9	0.9	0.9

The correlation matrices for high, medium and low correlation are defined in Table B.2.3.1-2, B.2.3.2-3 and B.2.3.2-4, as below.

The values in Table B.2.3.2-2 have been adjusted for the 4x2 and 4x4 high correlation cases to insure the correlation matrix is positive semi-definite after round-off to 4 digit precision. This is done using the equation:

$$\mathbf{R}_{high} = [\mathbf{R}_{spatial} + a\mathbf{I}_n] / (1 + a)$$

Where the value 'a' is a scaling factor such that the smallest value is used to obtain a positive semi-definite result. For the 4x2 high correlation case, a=0.00010. For the 4x4 high correlation case, a=0.00012.

The same method is used to adjust the 4x4 medium correlation matrix in Table B.2.3.2-3 to insure the correlation matrix is positive semi-definite after round-off to 4 digit precision with a = 0.00012.

**Table B.2.3.2-2: MIMO correlation matrices for high correlation**

<b>1x2</b>	$R_{high} = \begin{pmatrix} 1 & 0.9 \\ 0.9 & 1 \end{pmatrix}$
<b>2x2</b>	$R_{high} = \begin{pmatrix} 1 & 0.9 & 0.9 & 0.81 \\ 0.9 & 1 & 0.81 & 0.9 \\ 0.9 & 0.81 & 1 & 0.9 \\ 0.81 & 0.9 & 0.9 & 1 \end{pmatrix}$
<b>4x2</b>	$R_{high} = \begin{bmatrix} 1.0000 & 0.8999 & 0.9883 & 0.8894 & 0.9542 & 0.8587 & 0.8999 & 0.8099 \\ 0.8999 & 1.0000 & 0.8894 & 0.9883 & 0.8587 & 0.9542 & 0.8099 & 0.8999 \\ 0.9883 & 0.8894 & 1.0000 & 0.8999 & 0.9883 & 0.8894 & 0.9542 & 0.8587 \\ 0.8894 & 0.9883 & 0.8999 & 1.0000 & 0.8894 & 0.9883 & 0.8587 & 0.9542 \\ 0.9542 & 0.8587 & 0.9883 & 0.8894 & 1.0000 & 0.8999 & 0.9883 & 0.8894 \\ 0.8587 & 0.9542 & 0.8894 & 0.9883 & 0.8999 & 1.0000 & 0.8894 & 0.9883 \\ 0.8999 & 0.8099 & 0.9542 & 0.8587 & 0.9883 & 0.8894 & 1.0000 & 0.8999 \\ 0.8099 & 0.8999 & 0.8587 & 0.9542 & 0.8894 & 0.9883 & 0.8999 & 1.0000 \end{bmatrix}$
<b>4x4</b>	$R_{high} = \begin{bmatrix} 1.0000 & 0.9882 & 0.9541 & 0.8999 & 0.9882 & 0.9767 & 0.9430 & 0.8894 & 0.9541 & 0.9430 & 0.9105 & 0.8587 & 0.8999 & 0.8894 & 0.8587 & 0.8099 \\ 0.9882 & 1.0000 & 0.9882 & 0.9541 & 0.9767 & 0.9882 & 0.9767 & 0.9430 & 0.9430 & 0.9541 & 0.9430 & 0.9105 & 0.8894 & 0.8999 & 0.8894 & 0.8587 \\ 0.9541 & 0.9882 & 1.0000 & 0.9882 & 0.9430 & 0.9767 & 0.9882 & 0.9767 & 0.9105 & 0.9430 & 0.9541 & 0.9430 & 0.8587 & 0.8894 & 0.8999 & 0.8894 \\ 0.8999 & 0.9541 & 0.9882 & 1.0000 & 0.8894 & 0.9430 & 0.9767 & 0.9882 & 0.8587 & 0.9105 & 0.9430 & 0.9541 & 0.8099 & 0.8587 & 0.8894 & 0.8999 \\ 0.9882 & 0.9767 & 0.9430 & 0.8894 & 1.0000 & 0.9882 & 0.9541 & 0.8999 & 0.9882 & 0.9767 & 0.9430 & 0.8894 & 0.9541 & 0.9430 & 0.9105 & 0.8587 \\ 0.9767 & 0.9882 & 0.9767 & 0.9430 & 0.9882 & 1.0000 & 0.9882 & 0.9541 & 0.9767 & 0.9882 & 0.9767 & 0.9430 & 0.9430 & 0.9541 & 0.9430 & 0.9105 \\ 0.9430 & 0.9767 & 0.9882 & 0.9767 & 0.9541 & 0.9882 & 1.0000 & 0.9882 & 0.9430 & 0.9767 & 0.9882 & 0.9767 & 0.9105 & 0.9430 & 0.9541 & 0.9430 \\ 0.8894 & 0.9430 & 0.9767 & 0.9882 & 0.8999 & 0.9541 & 0.9882 & 1.0000 & 0.8894 & 0.9430 & 0.9767 & 0.9882 & 0.8587 & 0.9105 & 0.9430 & 0.9541 \\ 0.9541 & 0.9430 & 0.9105 & 0.8587 & 0.9882 & 0.9767 & 0.9430 & 0.8894 & 1.0000 & 0.9882 & 0.9541 & 0.8999 & 0.9882 & 0.9767 & 0.9430 & 0.8894 \\ 0.9430 & 0.9541 & 0.9430 & 0.9105 & 0.9767 & 0.9882 & 0.9767 & 0.9430 & 0.9882 & 1.0000 & 0.9882 & 0.9541 & 0.9767 & 0.9882 & 0.9767 & 0.9430 \\ 0.9105 & 0.9430 & 0.9541 & 0.9430 & 0.9430 & 0.9767 & 0.9882 & 0.9767 & 0.9541 & 0.9882 & 1.0000 & 0.9882 & 0.9430 & 0.9767 & 0.9882 & 0.9767 \\ 0.8587 & 0.9105 & 0.9430 & 0.9541 & 0.8894 & 0.9430 & 0.9767 & 0.9882 & 0.8999 & 0.9541 & 0.9882 & 1.0000 & 0.8894 & 0.9430 & 0.9767 & 0.9882 \\ 0.8999 & 0.8894 & 0.8587 & 0.8099 & 0.9541 & 0.9430 & 0.9105 & 0.8587 & 0.9882 & 0.9767 & 0.9430 & 0.8894 & 1.0000 & 0.9882 & 0.9541 & 0.8999 \\ 0.8894 & 0.8999 & 0.8894 & 0.8587 & 0.9430 & 0.9541 & 0.9430 & 0.9105 & 0.9767 & 0.9882 & 0.9767 & 0.9430 & 0.9882 & 1.0000 & 0.9882 & 0.9541 \\ 0.8587 & 0.8894 & 0.8999 & 0.8894 & 0.9105 & 0.9430 & 0.9541 & 0.9430 & 0.9430 & 0.9767 & 0.9882 & 0.9767 & 0.9541 & 0.9882 & 1.0000 & 0.9882 \\ 0.8099 & 0.8587 & 0.8894 & 0.8999 & 0.8587 & 0.9105 & 0.9430 & 0.9541 & 0.8894 & 0.9430 & 0.9767 & 0.9882 & 0.8999 & 0.9541 & 0.9882 & 1.0000 \end{bmatrix}$

**Table B.2.3.2-3: MIMO correlation matrices for medium correlation**

	N/A
	$R_{medium} = \begin{pmatrix} 1 & 0.9 & 0.3 & 0.27 \\ 0.9 & 1 & 0.27 & 0.3 \\ 0.3 & 0.27 & 1 & 0.9 \\ 0.27 & 0.3 & 0.9 & 1 \end{pmatrix}$
	$R_{medium} = \begin{pmatrix} 1.0000 & 0.9000 & 0.8748 & 0.7873 & 0.5856 & 0.5271 & 0.3000 & 0.2700 \\ 0.9000 & 1.0000 & 0.7873 & 0.8748 & 0.5271 & 0.5856 & 0.2700 & 0.3000 \\ 0.8748 & 0.7873 & 1.0000 & 0.9000 & 0.8748 & 0.7873 & 0.5856 & 0.5271 \\ 0.7873 & 0.8748 & 0.9000 & 1.0000 & 0.7873 & 0.8748 & 0.5271 & 0.5856 \\ 0.5856 & 0.5271 & 0.8748 & 0.7873 & 1.0000 & 0.9000 & 0.8748 & 0.7873 \\ 0.5271 & 0.5856 & 0.7873 & 0.8748 & 0.9000 & 1.0000 & 0.7873 & 0.8748 \\ 0.3000 & 0.2700 & 0.5856 & 0.5271 & 0.8748 & 0.7873 & 1.0000 & 0.9000 \\ 0.2700 & 0.3000 & 0.5271 & 0.5856 & 0.7873 & 0.8748 & 0.9000 & 1.0000 \end{pmatrix}$
	$R_{medium} = \begin{pmatrix} 1.0000 & 0.9882 & 0.9541 & 0.8999 & 0.8747 & 0.8645 & 0.8347 & 0.7872 & 0.5855 & 0.5787 & 0.5588 & 0.5270 & 0.3000 & 0.2965 & 0.2862 & 0.2700 \\ 0.9882 & 1.0000 & 0.9882 & 0.9541 & 0.8645 & 0.8747 & 0.8645 & 0.8347 & 0.5787 & 0.5855 & 0.5787 & 0.5588 & 0.2965 & 0.3000 & 0.2965 & 0.2862 \\ 0.9541 & 0.9882 & 1.0000 & 0.9882 & 0.8347 & 0.8645 & 0.8747 & 0.8645 & 0.5588 & 0.5787 & 0.5855 & 0.5787 & 0.2862 & 0.2965 & 0.3000 & 0.2965 \\ 0.8999 & 0.9541 & 0.9882 & 1.0000 & 0.7872 & 0.8347 & 0.8645 & 0.8747 & 0.5270 & 0.5588 & 0.5787 & 0.5855 & 0.2700 & 0.2862 & 0.2965 & 0.3000 \\ 0.8747 & 0.8645 & 0.8347 & 0.7872 & 1.0000 & 0.9882 & 0.9541 & 0.8999 & 0.8747 & 0.8645 & 0.8347 & 0.7872 & 0.5855 & 0.5787 & 0.5588 & 0.5270 \\ 0.8645 & 0.8747 & 0.8645 & 0.8347 & 0.9882 & 1.0000 & 0.9882 & 0.9541 & 0.8645 & 0.8747 & 0.8645 & 0.8347 & 0.5787 & 0.5855 & 0.5787 & 0.5588 \\ 0.8347 & 0.8645 & 0.8747 & 0.8645 & 0.9541 & 0.9882 & 1.0000 & 0.9882 & 0.8347 & 0.8645 & 0.8747 & 0.8645 & 0.5588 & 0.5787 & 0.5855 & 0.5787 \\ 0.7872 & 0.8347 & 0.8645 & 0.8747 & 0.8999 & 0.9541 & 0.9882 & 1.0000 & 0.7872 & 0.8347 & 0.8645 & 0.8747 & 0.5270 & 0.5588 & 0.5787 & 0.5855 \\ 0.5855 & 0.5787 & 0.5588 & 0.5270 & 0.8747 & 0.8645 & 0.8347 & 0.7872 & 1.0000 & 0.9882 & 0.9541 & 0.8999 & 0.8747 & 0.8645 & 0.8347 & 0.7872 \\ 0.5787 & 0.5855 & 0.5787 & 0.5588 & 0.8645 & 0.8747 & 0.8645 & 0.8347 & 0.9882 & 1.0000 & 0.9882 & 0.9541 & 0.8645 & 0.8747 & 0.8645 & 0.8347 \\ 0.5588 & 0.5787 & 0.5855 & 0.5787 & 0.8347 & 0.8645 & 0.8747 & 0.8645 & 0.9541 & 0.9882 & 1.0000 & 0.9882 & 0.8347 & 0.8645 & 0.8747 & 0.8645 \\ 0.5270 & 0.5588 & 0.5787 & 0.5855 & 0.7872 & 0.8347 & 0.8645 & 0.8747 & 0.8999 & 0.9541 & 0.9882 & 1.0000 & 0.7872 & 0.8347 & 0.8645 & 0.8747 \\ 0.3000 & 0.2965 & 0.2862 & 0.2700 & 0.5855 & 0.5787 & 0.5588 & 0.5270 & 0.8747 & 0.8645 & 0.8347 & 0.7872 & 1.0000 & 0.9882 & 0.9541 & 0.8999 \\ 0.2965 & 0.3000 & 0.2965 & 0.2862 & 0.5787 & 0.5855 & 0.5787 & 0.5588 & 0.8645 & 0.8747 & 0.8645 & 0.8347 & 0.9882 & 1.0000 & 0.9882 & 0.9541 \\ 0.2862 & 0.2965 & 0.3000 & 0.2965 & 0.5588 & 0.5787 & 0.5855 & 0.5787 & 0.8347 & 0.8645 & 0.8747 & 0.8645 & 0.9541 & 0.9882 & 1.0000 & 0.9882 \\ 0.2700 & 0.2862 & 0.2965 & 0.3000 & 0.5270 & 0.5588 & 0.5787 & 0.5855 & 0.7872 & 0.8347 & 0.8645 & 0.8747 & 0.8999 & 0.9541 & 0.9882 & 1.0000 \end{pmatrix}$

**Table B.2.3.2-4: MIMO correlation matrices for low correlation**

<b>1x2 case</b>	$R_{low} = \mathbf{I}_2$
<b>2x2 case</b>	$R_{low} = \mathbf{I}_4$
<b>4x2 case</b>	$R_{low} = \mathbf{I}_8$
<b>4x4 case</b>	$R_{low} = \mathbf{I}_{16}$

In Table B.2.3.2-4,  $\mathbf{I}_d$  is the  $d \times d$  identity matrix.

## B.2.4 Propagation conditions for CQI tests

[For Channel Quality Indication (CQI) tests, the following additional multi-path profile is used:

$$h(t, \tau) = \delta(\tau) + a \exp(-i2\pi f_D t) \delta(\tau - \tau_d),$$

in continuous time  $(t, \tau)$  representation, with  $\tau_d$  the delay,  $a$  a constant and  $f_D$  the Doppler frequency. ]

---

## B.3 High speed train scenario

The high speed train condition for the test of the baseband performance is a non fading propagation channel with one tap. Doppler shift is given by

$$f_s(t) = f_d \cos \theta(t) \quad (\text{B.3.1})$$

where  $f_s(t)$  is the Doppler shift and  $f_d$  is the maximum Doppler frequency. The cosine of angle  $\theta(t)$  is given by

$$\cos \theta(t) = \frac{D_s/2 - vt}{\sqrt{D_{\min}^2 + (D_s/2 - vt)^2}}, \quad 0 \leq t \leq D_s/v \quad (\text{B.3.2})$$

$$\cos \theta(t) = \frac{-1.5D_s + vt}{\sqrt{D_{\min}^2 + (-1.5D_s + vt)^2}}, \quad D_s/v < t \leq 2D_s/v \quad (\text{B.3.3})$$

$$\cos \theta(t) = \cos \theta(t \bmod (2D_s/v)), \quad t > 2D_s/v \quad (\text{B.3.4})$$

where  $D_s/2$  is the initial distance of the train from eNodeB, and  $D_{\min}$  is eNodeB Railway track distance, both in meters;  $v$  is the velocity of the train in m/s,  $t$  is time in seconds.

Doppler shift and cosine angle are given by equation B.3.1 and B.3.2-B.3.4 respectively, where the required input parameters listed in table B.3-1 and the resulting Doppler shift shown in Figure B.3-1 are applied for all frequency bands.

**Table B.3-1: High speed train scenario**

Parameter	Value
$D_s$	300 m
$D_{\min}$	2 m
$v$	300 km/h
$f_d$	750 Hz

NOTE 1: Parameters for HST conditions in table B.3-1 including  $f_d$  and Doppler shift trajectories presented on figure B.3-1 were derived for Band 7.

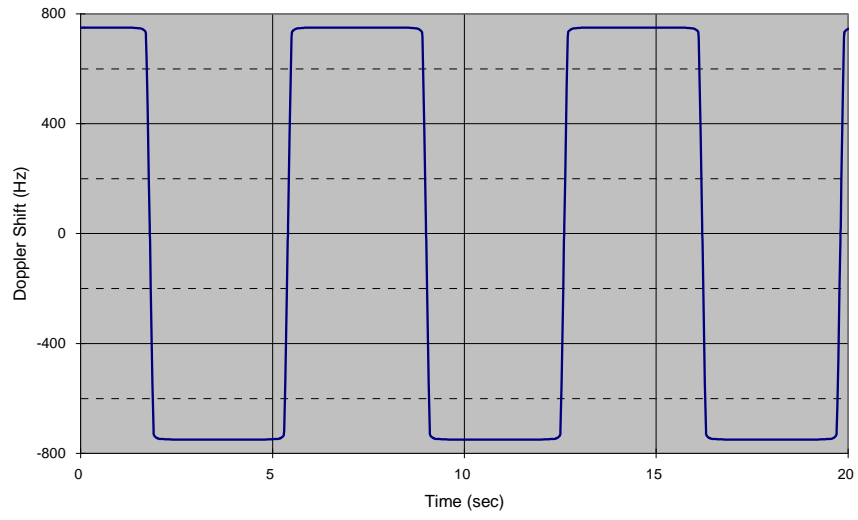

Figure B.3-1: Doppler shift trajectory

## Annex C (normative): Downlink Physical Channels

### C.1 General

This annex specifies the downlink physical channels that are needed for setting a connection and channels that are needed during a connection.

### C.2 Set-up

Table C.2-1 describes the downlink Physical Channels that are required for connection set up.

**Table C.2-1: Downlink Physical Channels required for connection set-up**

Physical Channel
PBCH
SSS
PSS
PCFICH
PDCCH
PHICH
PDSCH

### C.3 Connection

The following clauses, describes the downlink Physical Channels that are transmitted during a connection i.e., when measurements are done.

#### C.3.1 Measurement of Receiver Characteristics

Table C.3.1-1 is applicable for measurements on the Receiver Characteristics (clause 7).

**Table C.3.1-1: Downlink Physical Channels transmitted during a connection (FDD and TDD)**

Physical Channel	EPRE Ratio	
<i>PBCH</i>	<i>PBCH_RA = 0 dB</i>	
	<i>PBCH_RB = 0 dB</i>	
<i>PSS</i>	<i>PSS_RA = 0 dB</i>	
<i>SSS</i>	<i>SSS_RA = 0 dB</i>	
<i>PCFICH</i>	<i>PCFICH_RB = 0 dB</i>	
<i>PDCCH</i>	<i>PDCCH_RA = 0 dB</i>	
	<i>PDCCH_RB = 0 dB</i>	
<i>PDSCH</i>	<i>PDSCH_RA = 0 dB</i>	
	<i>PDSCH_RB = 0 dB</i>	

NOTE 1: No boosting is applied.

**Table C.3.1-2: Power allocation for OFDM symbols and reference signals**

<b>Parameter</b>	<b>Unit</b>	<b>Value</b>	<b>Note</b>
Transmitted power spectral density $I_{or}$	dBm/15 kHz	Test specific	1. $I_{or}$ shall be kept constant throughout all OFDM symbols
Cell-specific reference signal power ratio $E_{RS} / I_{or}$		0 dB	

## C.3.2 Measurement of Performance requirements

Table C.3.2-1 is applicable for measurements in which uniform RS-to-EPRE boosting for all downlink physical channels.

**Table C.3.2-1: Downlink Physical Channels transmitted during a connection (FDD and TDD)**

<b>Physical Channel</b>	<b>EPRE Ratio</b>	
PBCH	PBCH_RA = $\rho_A$	
	PBCH_RB = $\rho_B$	
PSS	PSS_RA = $\rho_A$	
SSS	SSS_RA = $\rho_A$	
PCFICH	PCFICH_RB = $\rho_B$	
PDCCH	PDCCH_RA = $\rho_A$	
	PDCCH_RB = $\rho_B$	
PDSCH	PDSCH_RA = $\rho_A$	
	PDSCH_RB = $\rho_B$	

NOTE 1:  $\rho_A = \rho_B = 0$  dB means no RS boosting.

**Table C.3.2-2: Power allocation for OFDM symbols and reference signals**

<b>Parameter</b>	<b>Unit</b>	<b>Value</b>	<b>Note</b>
Total transmitted power spectral density $I_{or}$	dBm/15 kHz	Test specific	1. $I_{or}$ shall be kept constant throughout all OFDM symbols
Cell-specific reference signal power ratio $E_{RS} / I_{or}$		Test specific	1. Applies for antenna port $p$

# Annex D (normative): Characteristics of the interfering signal

## D.1 General

When the channel band width is wider or equal to 5MHz, a modulated 5MHz full band width E-UTRA down link signal and CW signal are used as interfering signals when RF performance requirements for E-UTRA UE receiver are defined. For channel band widths below 5MHz, the band width of modulated interferer should be equal to band width of the received signal.

## D.2 Interference signals

Table D.2-1 describes the modulated interferer for different channel band width options.

**Table D.2-1: Description of modulated E-UTRA interferer**

	Channel bandwidth					
	MHz	Hz	MHz	MHz	MHz	MHz
RB	6	5	5	0	5	00
Interferer	MHz	Hz	MHz	MHz	MHz	MHz



## Annex E (normative): Environmental conditions

### E.1 General

This normative annex specifies the environmental requirements of the UE. Within these limits the requirements of the present documents shall be fulfilled.

### E.2 Environmental

The requirements in this clause apply to all types of UE(s).

#### E.2.1 Temperature

The UE shall fulfil all the requirements in the full temperature range of:

**Table E.2.1-1**

+15°C to +35°C	for normal conditions (with relative humidity of 25 % to 75 %)
-10°C to +55°C	for extreme conditions (see IEC publications 68-2-1 and 68-2-2)

Outside this temperature range the UE, if powered on, shall not make ineffective use of the radio frequency spectrum. In no case shall the UE exceed the transmitted levels as defined in clause 6.2 for extreme operation.

#### E.2.2 Voltage

The UE shall fulfil all the requirements in the full voltage range, i.e. the voltage range between the extreme voltages.

The manufacturer shall declare the lower and higher extreme voltages and the approximate shutdown voltage. For the equipment that can be operated from one or more of the power sources listed below, the lower extreme voltage shall not be higher, and the higher extreme voltage shall not be lower than that specified below.

**Table E.2.2-1**

Power source	Lower extreme voltage	Higher extreme voltage	Normal conditions voltage
AC mains	0,9 * nominal	1,1 * nominal	nominal
Regulated lead acid battery	0,9 * nominal	1,3 * nominal	1,1 * nominal
Non regulated batteries:			
Leclanché	0,85 * nominal	Nominal	Nominal
Lithium	0,95 * nominal	1,1 * Nominal	1,1 * Nominal
Mercury/nickel & cadmium	0,90 * nominal		Nominal

Outside this voltage range the UE if powered on, shall not make ineffective use of the radio frequency spectrum. In no case shall the UE exceed the transmitted levels as defined in clause 6.2 for extreme operation. In particular, the UE shall inhibit all RF transmissions when the power supply voltage is below the manufacturer declared shutdown voltage.

## E.2.3 Vibration

The UE shall fulfil all the requirements when vibrated at the following frequency/amplitudes.

**Table E.2.3-1**

<b>Frequency</b>	<b>ASD (Acceleration Spectral Density) random vibration</b>
5 Hz to 20 Hz	0,96 m <sup>2</sup> /s <sup>3</sup>
20 Hz to 500 Hz	0,96 m <sup>2</sup> /s <sup>3</sup> at 20 Hz, thereafter -3 dB/Octave

Outside the specified frequency range the UE, if powered on, shall not make ineffective use of the radio frequency spectrum. In no case shall the UE exceed the transmitted levels as defined in TS 36.101 for extreme operation.

# Annex F (normative): Transmit modulation

## F.1 Measurement Point

Figure F.1-1 shows the measurement point for the unwanted emission falling into non-allocated RB(s) and the EVM for the allocated RB(s).

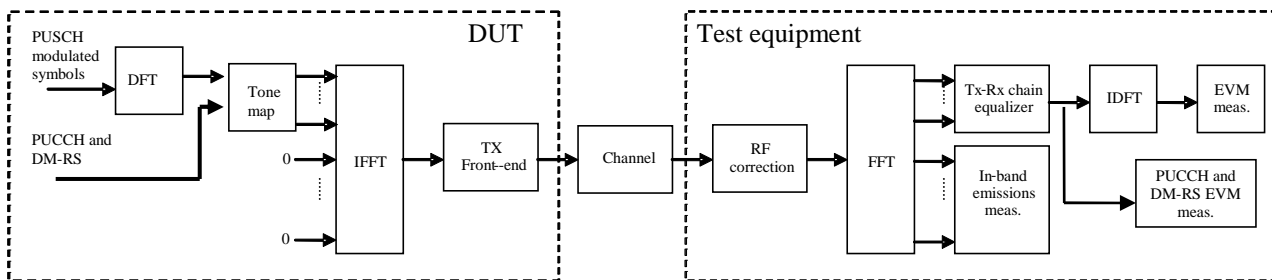

Figure F.1-1: EVM measurement points

## F.2 Basic Error Vector Magnitude measurement

The EVM is the difference between the ideal waveform and the measured waveform for the allocated RB(s)

$$EVM = \sqrt{\frac{\sum_{v \in T_m} |z'(v) - i(v)|^2}{|T_m| \cdot P_0}}$$

where

$T_m$  is a set of  $|T_m|$  modulation symbols with the considered modulation scheme being active within the measurement period,

$z'(v)$  are the samples of the signal evaluated for the EVM,

$i(v)$  is the ideal signal reconstructed by the measurement equipment, and

$P_0$  is the average power of the ideal signal. For normalized modulation symbols  $P_0$  is equal to 1.

The basic EVM measurement interval is defined over one slot in the time domain for PUCCH and PUSCH and over one preamble sequence for the PRACH.

## F.3 Basic in-band emissions measurement

The in-band emissions are a measure of the interference falling into the non-allocated resources blocks. The in-band emission requirement is evaluated for PUCCH and PUSCH transmissions. The in-band emission requirement is not evaluated for PRACH transmissions.

For the non-allocated RBs below the allocated frequency block the in-band emissions would be measured as follows

$$Emissions_{absolute}(\Delta_{RB}) = \frac{1}{|T_s|} \sum_{t \in T_s} \sum_{\substack{\min(f_{\max}, c-12 \cdot \Delta_{RB} + 11) \\ \max(f_{\min}, c-12 \cdot \Delta_{RB})}} |Y(t, f)|^2,$$

where

$T_s$  is a set of  $|T_s|$  SC-FDMA symbols with the considered modulation scheme being active within the measurement period,

$\Delta_{RB}$  is the starting frequency offset between the allocated RB and the measured non-allocated RB (e.g.  $\Delta_{RB} = 1$  or  $\Delta_{RB} = -1$  for the first adjacent RB),

$f_{\min}$  (resp.  $f_{\max}$ ) is the lower (resp. upper) edge of the UL system BW,

$c$  is the lower edge of the allocated BW, and

$Y(t, f)$  is the frequency domain signal evaluated for in-band emissions as defined in the subsection (ii)

The relative in-band emissions are, given by

$$Emissions_{relative}(\Delta_{RB}) = \frac{Emissions_{absolute}(\Delta_{RB})}{\frac{1}{|T_s| \cdot N_{RB}} \sum_{t \in T_s} \sum_c^{c+12 \cdot N_{RB} - 1} |Y(t, f)|^2}$$

where

$N_{RB}$  is the number of allocated RBs

The basic in-band emissions measurement interval is defined over one slot in the time domain. When the PUSCH or PUCCH transmission slot is shortened due to multiplexing with SRS, the in-band emissions measurement interval is reduced by one SC-FDMA symbol, accordingly.

In the evaluation of in-band emissions, the timing is set according to  $\Delta \tilde{t} = \Delta \tilde{c}$ , where sample time offsets  $\Delta \tilde{t}$  and  $\Delta \tilde{c}$  are defined in subclause F.4.

## F.4 Modified signal under test

Implicit in the definition of EVM is an assumption that the receiver is able to compensate a number of transmitter impairments.

The PUSCH data or PRACH signal under test is modified and, in the case of PUSCH data signal, decoded according to::

$$Z'(t, f) = IDFT \left\{ \frac{FFT \left\{ z(v - \Delta \tilde{t}) \cdot e^{-j2\pi \Delta \tilde{t} v} \right\} e^{j2\pi f \Delta \tilde{t}}}{\tilde{a}(t, f) \cdot e^{j\tilde{\varphi}(t, f)}} \right\}$$

where

$z(v)$  is the time domain samples of the signal under test.

The PUCCH or PUSCH demodulation reference signal or PUCCH data signal under test is equalised and, in the case of PUCCH data signal decoded according to:

$$Z'(t, f) = \frac{FFT\{z(v - \Delta\tilde{t}) \cdot e^{-j2\pi\Delta\tilde{f}v}\} e^{j2\pi f\Delta\tilde{t}}}{\tilde{a}(t, f) \cdot e^{j\tilde{\varphi}(t, f)}}$$

where

$z(v)$  is the time domain samples of the signal under test.

To minimize the error, the signal under test should be modified with respect to a set of parameters following the procedure explained below.

Notation:

$\Delta\tilde{t}$  is the sample timing difference between the FFT processing window in relation to nominal timing of the ideal signal.

$\Delta\tilde{f}$  is the RF frequency offset.

$\tilde{\varphi}(t, f)$  is the phase response of the TX chain.

$\tilde{a}(t, f)$  is the amplitude response of the TX chain.

In the following  $\Delta\tilde{c}$  represents the middle sample of the EVM window of length  $W$  (defined in the next subsections) or the last sample of the first window half if  $W$  is even.

The EVM analyser shall

- detect the start of each slot and estimate  $\Delta\tilde{t}$  and  $\Delta\tilde{f}$ ,
- determine  $\Delta\tilde{c}$  so that the EVM window of length  $W$  is centred
  - on the time interval determined by the measured cyclic prefix minus 16 samples of the considered OFDM symbol for symbol 0 for normal CP, i.e. the first 16 samples of the CP should not be taken into account for this step. In the determination of the number of excluded samples, a sampling rate of 30.72MHz was assumed. If a different sampling rate is used, the number of excluded samples is scaled linearly.
  - on the measured cyclic prefix of the considered OFDM symbol for symbol 1 to 6 for normal CP and for symbol 0 to 5 for extended CP.
  - on the measured preamble cyclic prefix for the PRACH

To determine the other parameters a sample timing offset equal to  $\Delta\tilde{c}$  is corrected from the signal under test. The EVM analyser shall then

- correct the RF frequency offset  $\Delta\tilde{f}$  for each time slot, and
- apply an FFT of appropriate size. The chosen FFT size shall ensure that in the case of an ideal signal under test, there is no measured inter-subcarrier interference.

The IQ origin offset shall be removed from the evaluated signal before calculating the EVM and the in-band emissions; however, the removed relative IQ origin offset power (relative carrier leakage power) also has to satisfy the applicable requirement.

At this stage the allocated RBs shall be separated from the non-allocated RBs. In the case of PUCCH and PUSCH EVM, the signal on the non-allocated RB(s),  $Y(t, f)$ , is used to evaluate the in-band emissions.

Moreover, the following procedure applies only to the signal on the allocated RB(s).

- In the case of PUCCH and PUSCH, the UL EVM analyzer shall estimate the TX chain equalizer coefficients  $\tilde{a}(t, f)$  and  $\tilde{\varphi}(t, f)$  used by the ZF equalizer for all subcarriers by time averaging at each signal subcarrier of the amplitude and phase of the reference and data symbols. The time-averaging length is 1 slot. This process creates an average amplitude and phase for each signal subcarrier used by the ZF equalizer. The knowledge of data modulation symbols may be required in this step because the determination of symbols by demodulation is not reliable before signal equalization.
- In the case of PRACH, the UL EVM analyzer shall estimate the TX chain coefficients  $\tilde{a}(t)$  and  $\tilde{\varphi}(t)$  used for phase and amplitude correction and are selected so as to minimize the resulting EVM. The TX chain coefficients are not dependent on frequency, i.e.  $\tilde{a}(t, f) = \tilde{a}(t)$  and  $\tilde{\varphi}(t, f) = \tilde{\varphi}(t)$ . The TX chain coefficients are chosen independently for each preamble transmission and for each  $\Delta\tilde{t}$ .

At this stage estimates of  $\Delta\tilde{f}$ ,  $\tilde{a}(t, f)$ ,  $\tilde{\varphi}(t, f)$  and  $\Delta\tilde{c}$  are available.  $\Delta\tilde{t}$  is one of the extremities of the window  $W$ , i.e.  $\Delta\tilde{t}$  can be  $\Delta\tilde{c} + \alpha - \left\lfloor \frac{W}{2} \right\rfloor$  or  $\Delta\tilde{c} + \left\lfloor \frac{W}{2} \right\rfloor$ , where  $\alpha = 0$  if  $W$  is odd and  $\alpha = 1$  if  $W$  is even. The EVM analyser shall then

- calculate  $\text{EVM}_l$  with  $\Delta\tilde{t}$  set to  $\Delta\tilde{c} + \alpha - \left\lfloor \frac{W}{2} \right\rfloor$ ,
- calculate  $\text{EVM}_h$  with  $\Delta\tilde{t}$  set to  $\Delta\tilde{c} + \left\lfloor \frac{W}{2} \right\rfloor$ .

## F.5 Window length

### F.5.1 Timing offset

As a result of using a cyclic prefix, there is a range of  $\Delta\tilde{t}$ , which, at least in the case of perfect Tx signal quality, would give close to minimum error vector magnitude. As a first order approximation, that range should be equal to the length of the cyclic prefix. Any time domain windowing or FIR pulse shaping applied by the transmitter reduces the  $\Delta\tilde{t}$  range within which the error vector is close to its minimum.

### F.5.2 Window length

The window length  $W$  affects the measured EVM, and is expressed as a function of the configured cyclic prefix length. In the case where equalization is present, as with frequency domain EVM computation, the effect of FIR is reduced. This is because the equalization can correct most of the linear distortion introduced by the FIR. However, the time domain windowing effect can't be removed.

### F.5.3 Window length for normal CP

The table below specifies the EVM window length at channel bandwidths 1.4, 3, 5, 10, 15, 20 MHz, for normal CP. The nominal window length for 3 MHz is rounded down one sample to allow the window to be centered on the symbol.

Table F.5.3-1 EVM window length for normal CP

Channel Bandwidth MHz	Cyclic prefix length <sup>1</sup> $N_{cp}$ for symbol 0	Cyclic prefix length <sup>1</sup> $N_{cp}$ for symbols 1 to 6	Nominal FFT size	Cyclic prefix for symbols 1 to 6 in FFT samples	EVM	Ratio of $W$ to CP for symbols 1 to 6
1.4	160	144	128	9	[5]	[55.6]
3			256	18	[12]	[66.7]
5			512	36	[32]	[88.9]
10			1024	72	[66]	[91.7]
15			1536	108	[102]	[94.4]
20			2048	144	[136]	[94.4]
<p>Note 1: The unit is number of samples, sampling rate of 30.72MHz is assumed.</p> <p>Note 2: These percentages are informative and apply to symbols 1 through 6. Symbol 0 has a longer CP and therefore a lower percentage.</p>						

### F.5.4 Window length for Extended CP

The table below specifies the EVM window length at channel bandwidths 1.4, 3, 5, 10, 15, 20 MHz, for extended CP. The nominal window lengths for 3 MHz and 15 MHz are rounded down one sample to allow the window to be centered on the symbol.

Table F.5.4-1 EVM window length for extended CP

Channel Bandwidth MHz	Cyclic prefix length $N_c$	Nominal	Cyclic	EVM	Ratio
1.4	512	128	32	[28]	[87.5]
3		256	64	[58]	[90.6]
5		512	128	[124]	[96.9]
10		1024	256	[250]	[97.4]
15		1536	384	[374]	[97.4]
20		2048	512	[504]	[98.4]
Note 1: The unit is number of samples, sampling rate of 30.72MHz is assumed. Note 2: These percentages are informative					

### F.5.4 Window length for PRACH

The table below specifies the EVM window length for PRACH preamble formats 0-4.



Table F.5.5-1 EVM window length for PRACH

Preamble format	Cyclic prefix length <sup>1</sup> $N_{cp}$	Nominal FFT size <sup>2</sup>	EVM window length W in FFT samples	Ratio of W to CP*
0	3168	24576	[TBD]	[TBD]
1	21024	24576	[TBD]	[TBD]
2	6240	49152	[TBD]	[TBD]
3	21024	49152	[TBD]	[TBD]
4	448	4096	[TBD]	[TBD]
Note 1: The unit is number of samples, sampling rate of 30.72MHz is assumed Note 2: The use of other FFT sizes is possible as long as appropriate scaling of the window length is applied Note 3: These percentages are informative				

## F.6 Averaged EVM

The general EVM is averaged over basic EVM measurements for 20 slots in the time domain.

$$\overline{EVM} = \sqrt{\frac{1}{20} \sum_{i=1}^{20} EVM_i^2}$$

The EVM requirements shall be tested against the maximum of the RMS average at the window W extremities of the EVM measurements:

Thus  $\overline{EVM}_l$  is calculated using  $\Delta\tilde{t} = \Delta\tilde{t}_l$  in the expressions above and  $\overline{EVM}_h$  is calculated using  $\Delta\tilde{t} = \Delta\tilde{t}_h$ .

Thus we get:

$$EVM = \max(\overline{EVM}_l, \overline{EVM}_h)$$

The calculation of the EVM for the demodulation reference signal,  $EVM_{DMRS}$ , follows the same procedure as calculating the general EVM, with the exception that the modulation symbol set  $T_m$  defined in clause F.2 is restricted to symbols containing uplink demodulation reference signals.

The basic  $EVM_{DMRS}$  measurements are first averaged over 20 slots in the time domain to obtain an intermediate average  $\overline{EVM}_{DMRS}$ .

$$\overline{EVM}_{DMRS} = \sqrt{\frac{1}{20} \sum_{i=1}^{20} EVM_{DMRS,i}^2}$$

In the determination of each  $EVM_{DMRS,i}$ , the timing is set to  $\Delta\tilde{t} = \Delta\tilde{t}_l$  if  $\overline{EVM}_l > \overline{EVM}_h$ , and it is set to  $\Delta\tilde{t} = \Delta\tilde{t}_h$  otherwise, where  $\overline{EVM}_l$  and  $\overline{EVM}_h$  are the general average EVM values calculated in the same 20 slots

over which the intermediate average  $\overline{EVM}_{DMRS}$  is calculated. Note that in some cases, the general average EVM may be calculated only for the purpose of timing selection for the demodulation reference signal EVM.

Then the results are further averaged to get the EVM for the demodulation reference signal,  $EVM_{DMRS}$ ,

$$EVM_{DMRS} = \sqrt{\frac{1}{6} \sum_{j=1}^6 \overline{EVM}_{DMRS,j}^2}$$

The PRACH EVM,  $EVM_{PRACH}$ , is averaged over two preamble sequence measurements for preamble formats 0, 1, 2, 3, and it is averaged over 10 preamble sequence measurements for preamble format 4.

The EVM requirements shall be tested against the maximum of the RMS average at the window  $W$  extremities of the EVM measurements:

Thus  $\overline{EVM}_{PRACH,l}$  is calculated using  $\Delta\tilde{t} = \Delta\tilde{t}_l$  and  $\overline{EVM}_{PRACH,h}$  is calculated using  $\Delta\tilde{t} = \Delta\tilde{t}_h$ .

Thus we get:

$$EVM_{PRACH} = \max(\overline{EVM}_{PRACH,l}, \overline{EVM}_{PRACH,h})$$

---

## F.7 Spectrum Flatness

The data for the subcarrier output power shall be taken from the equaliser estimation step.

## Annex G (informative): Change history

**Table G.1: Change History**

Date	TSG#	TSG Doc.	CR	Subject	Old	New
11-2007	R4#45	R4-72206		TS36.101V0.1.0 approved by RAN4	-	
12-2007	RP#38	RP-070979		Approved version at TSG RAN #38	1.0.0	8.0.0
03-2008	RP#39	RP-080123	3	TS36.101 - Combined updates of E-UTRA UE requirements	8.0.0	8.1.0
05-2008	RP#40	RP-080325	4	TS36.101 - Combined updates of E-UTRA UE requirements	8.1.0	8.2.0
09-2008	RP#41	RP-080638	5r1	Addition of Ref Sens figures for 1.4MHz and 3MHz Channel bandwidths	8.2.0	8.3.0
09-2008	RP#41	RP-080638	7r1	Transmitter intermodulation requirements	8.2.0	8.3.0
09-2008	RP#41	RP-080638	10	CR for clarification of additional spurious emission requirement	8.2.0	8.3.0
09-2008	RP#41	RP-080638	15	Correction of In-band Blocking Requirement	8.2.0	8.3.0
09-2008	RP#41	RP-080638	18r1	TS36.101: CR for section 6: NS_06	8.2.0	8.3.0
09-2008	RP#41	RP-080638	19r1	TS36.101: CR for section 6: Tx modulation	8.2.0	8.3.0
09-2008	RP#41	RP-080638	20r1	TS36.101: CR for UE minimum power	8.2.0	8.3.0
09-2008	RP#41	RP-080638	21r1	TS36.101: CR for UE OFF power	8.2.0	8.3.0
09-2008	RP#41	RP-080638	24r1	TS36.101: CR for section 7: Band 13 Rx sensitivity	8.2.0	8.3.0
09-2008	RP#41	RP-080638	26	UE EVM Windowing	8.2.0	8.3.0
09-2008	RP#41	RP-080638	29	Absolute ACLR limit	8.2.0	8.3.0
09-2008	RP#41	RP-080731	23r2	TS36.101: CR for section 6: UE to UE co-existence	8.2.0	8.3.0
09-2008	RP#41	RP-080731	30	Removal of [ ] for UE Ref Sens figures	8.2.0	8.3.0
09-2008	RP#41	RP-080731	31	Correction of PA, PB definition to align with RAN1 specification	8.2.0	8.3.0
09-2008	RP#41	RP-080731	37r2	UE Spurious emission band UE co-existence	8.2.0	8.3.0
09-2008	RP#41	RP-080731	44	Definition of specified bandwidths	8.2.0	8.3.0
09-2008	RP#41	RP-080731	48r3	Addition of Band 17	8.2.0	8.3.0
09-2008	RP#41	RP-080731	50	Alignment of the UE ACS requirement	8.2.0	8.3.0
09-2008	RP#41	RP-080731	52r1	Frequency range for Band 12	8.2.0	8.3.0
09-2008	RP#41	RP-080731	54r1	Absolute power tolerance for LTE UE power control	8.2.0	8.3.0
09-2008	RP#41	RP-080731	55	TS36.101 section 6: Tx modulation	8.2.0	8.3.0
09-2008	RP#41	RP-080732	6r2	DL FRC definition for UE Receiver tests	8.2.0	8.3.0
09-2008	RP#41	RP-080732	46	Additional UE demodulation test cases	8.2.0	8.3.0
09-2008	RP#41	RP-080732	47	Updated descriptions of FRC	8.2.0	8.3.0
09-2008	RP#41	RP-080732	49	Definition of UE transmission gap	8.2.0	8.3.0
09-2008	RP#41	RP-080732	51	Clarification on High Speed train model in 36.101	8.2.0	8.3.0
09-2008	RP#41	RP-080732	53	Update of symbol and definitions	8.2.0	8.3.0
09-2008	RP#41	RP-080743	56	Addition of MIMO (4x2) and (4x4) Correlation Matrices	8.2.0	8.3.0
12-2008	RP#42	RP-080908	94r2	CR TX RX channel frequency separation	8.3.0	8.4.0
12-2008	RP#42	RP-080909	105r1	UE Maximum output power for Band 13	8.3.0	8.4.0
12-2008	RP#42	RP-080909	60	UL EVM equalizer definition	8.3.0	8.4.0
12-2008	RP#42	RP-080909	63	Correction of UE spurious emissions	8.3.0	8.4.0
12-2008	RP#42	RP-080909	66	Clarification for UE additional spurious emissions	8.3.0	8.4.0
12-2008	RP#42	RP-080909	72	Introducing ACLR requirement for coexistence with UTRA 1.6MHz channel from 36.803	8.3.0	8.4.0
12-2008	RP#42	RP-080909	75	Removal of [ ] from Section 6 transmitter characteristics	8.3.0	8.4.0
12-2008	RP#42	RP-080909	81	Clarification for PHS band protection	8.3.0	8.4.0
12-2008	RP#42	RP-080909	101	Alignment for the measurement interval for transmit signal quality	8.3.0	8.4.0
12-2008	RP#42	RP-080909	98r1	Maximum power	8.3.0	8.4.0
12-2008	RP#42	RP-080909	57r1	CR UE spectrum flatness	8.3.0	8.4.0
12-2008	RP#42	RP-080909	71r1	UE in-band emission	8.3.0	8.4.0
12-2008	RP#42	RP-080909	58r1	CR Number of TX exceptions	8.3.0	8.4.0
12-2008	RP#42	RP-080951	99r2	CR UE output power dynamic	8.3.0	8.4.0
12-2008	RP#42	RP-080951	79r1	LTE UE transmitter intermodulation	8.3.0	8.4.0
12-2008	RP#42	RP-080910	91	Update of Clause 8	8.3.0	8.4.0
12-2008	RP#42	RP-080950	106r1	Structure of Clause 9 including CSI requirements for PUCCH mode 1-0	8.3.0	8.4.0
12-2008	RP#42	RP-080911	59	CR UE ACS test frequency offset	8.3.0	8.4.0
12-2008	RP#42	RP-080911	65	Correction of spurious response parameters	8.3.0	8.4.0
12-2008	RP#42	RP-080911	80	Removal of LTE UE narrowband intermodulation	8.3.0	8.4.0
12-2008	RP#42	RP-080911	90r1	Introduction of Maximum Sensitivity Degradation	8.3.0	8.4.0
12-2008	RP#42	RP-080911	103	Removal of [ ] from Section 7 Receiver characteristic	8.3.0	8.4.0
12-2008	RP#42	RP-080912	62	Alignment of TB size n Ref Meas channel for RX characteristics	8.3.0	8.4.0

12-2008	RP#42	RP-080912	78	TDD Reference Measurement channel for RX characteristics	8.3.0	8.4.0
12-2008	RP#42	RP-080912	73r1	Addition of 64QAM DL reference measurement channel	8.3.0	8.4.0
12-2008	RP#42	RP-080912	74r1	Addition of UL Reference Measurement Channels	8.3.0	8.4.0
12-2008	RP#42	RP-080912	104	Reference measurement channels for PDSCH performance requirements (TDD)	8.3.0	8.4.0
12-2008	RP#42	RP-080913	68	MIMO Correlation Matrix Corrections	8.3.0	8.4.0
12-2008	RP#42	RP-080915	67	Correction to the figure with the Transmission Bandwidth configuration	8.3.0	8.4.0
12-2008	RP#42	RP-080916	77	Modification to EARFCN	8.3.0	8.4.0
12-2008	RP#42	RP-080917	85r1	New Clause 5 outline	8.3.0	8.4.0
12-2008	RP#42	RP-080919	102	Introduction of Bands 12 and 17 in 36.101	8.3.0	8.4.0
12-2008	RP#42	RP-080927	84r1	Clarification of HST propagation conditions	8.3.0	8.4.0
03-2009	RP#43	RP-090170	156r2	A-MPR table for NS_07	8.4.0	8.5.0
03-2009	RP#43	RP-090170	170	Corrections of references (References to tables and figures)	8.4.0	8.5.0
03-2009	RP#43	RP-090170	108	Removal of [ ] from Transmitter Intermodulation	8.4.0	8.5.0
03-2009	RP#43	RP-090170	155	E-UTRA ACLR for below 5 MHz bandwidths	8.4.0	8.5.0
03-2009	RP#43	RP-090170	116	Clarification of PHS band including the future plan	8.4.0	8.5.0
03-2009	RP#43	RP-090170	119	Spectrum emission mask for 1.4 MHz and 3 MHz bandwidths	8.4.0	8.5.0
03-2009	RP#43	RP-090170	120	Removal of 'Out-of-synchronization handling of output power' heading	8.4.0	8.5.0
03-2009	RP#43	RP-090170	126	UE uplink power control	8.4.0	8.5.0
03-2009	RP#43	RP-090170	128	Transmission BW Configuration	8.4.0	8.5.0
03-2009	RP#43	RP-090170	130	Spectrum flatness	8.4.0	8.5.0
03-2009	RP#43	RP-090170	132r2	PUCCH EVM	8.4.0	8.5.0
03-2009	RP#43	RP-090170	134	UL DM-RS EVM	8.4.0	8.5.0
03-2009	RP#43	RP-090170	140	Removal of ACLR2bis requirements	8.4.0	8.5.0
03-2009	RP#43	RP-090171	113	In-band blocking	8.4.0	8.5.0
03-2009	RP#43	RP-090171	127	In-band blocking and sensitivity requirement for band 17	8.4.0	8.5.0
03-2009	RP#43	RP-090171	137r1	Wide band intermodulation	8.4.0	8.5.0
03-2009	RP#43	RP-090171	141	Correction of reference sensitivity power level of Band 9	8.4.0	8.5.0
03-2009	RP#43	RP-090172	109	AWGN level for UE DL demodulation performance tests	8.4.0	8.5.0
03-2009	RP#43	RP-090172	124	Update of Clause 8: additional test cases	8.4.0	8.5.0
03-2009	RP#43	RP-090172	139r1	Performance requirement structure for TDD PDSCH	8.4.0	8.5.0
03-2009	RP#43	RP-090172	142r1	Performance requirements and reference measurement channels for TDD PDSCH demodulation with UE-specific reference symbols	8.4.0	8.5.0
03-2009	RP#43	RP-090172	145	Number of information bits in DwPTS	8.4.0	8.5.0
03-2009	RP#43	RP-090172	160r1	MBSFN-Unicast demodulation test case	8.4.0	8.5.0
03-2009	RP#43	RP-090172	163r1	MBSFN-Unicast demodulation test case for TDD	8.4.0	8.5.0
03-2009	RP#43	RP-090173	162	Clarification of EARFCN for 36.101	8.4.0	8.5.0
03-2009	RP#43	RP-090369	110	Correction to UL Reference Measurement Channel	8.4.0	8.5.0
03-2009	RP#43	RP-090369	114	Addition of MIMO (4x4, medium) Correlation Matrix	8.4.0	8.5.0
03-2009	RP#43	RP-090369	121	Correction of 36.101 DL RMC table notes	8.4.0	8.5.0
03-2009	RP#43	RP-090369	125	Update of Clause 9	8.4.0	8.5.0
03-2009	RP#43	RP-090369	138r1	Clarification on OCNG	8.4.0	8.5.0
03-2009	RP#43	RP-090369	161	CQI reference measurement channels	8.4.0	8.5.0
03-2009	RP#43	RP-090369	164	PUCCH 1-1 Static Test Case	8.4.0	8.5.0
03-2009	RP#43	RP-090369	111	Reference Measurement Channel for TDD	8.4.0	8.5.0
03-2009	RP#44			Editorial correction in Table 6.2.4-1	8.5.0	8.5.1
05-2009	RP#44	RP-090540	167	Boundary between E-UTRA fOOB and spurious emission domain for 1.4 MHz and 3 MHz bandwidths. (Technically Endorsed CR in R4-50bis - R4-091205)	8.5.1	8.6.0
05-2009	RP#44	RP-090540	168	EARFCN correction for TDD DL bands. (Technically Endorsed CR in R4-50bis - R4-091206)	8.5.1	8.6.0
05-2009	RP#44	RP-090540	169	Editorial correction to in-band blocking table. (Technically Endorsed CR in R4-50bis - R4-091238)	8.5.1	8.6.0

05-2009	RP#44	RP-090540	171	CR PRACH EVM. (Technically Endorsed CR in R4-50bis - R4-091308)	8.5.1	8.6.0
05-2009	RP#44	RP-090540	172	CR EVM correction. (Technically Endorsed CR in R4-50bis - R4-091309)	8.5.1	8.6.0
05-2009	RP#44	RP-090540	177	CR power control accuracy. (Technically Endorsed CR in R4-50bis - R4-091418)	8.5.1	8.6.0
05-2009	RP#44	RP-090540	179	Correction of SRS requirements. (Technically Endorsed CR in R4-50bis - R4-091426)	8.5.1	8.6.0
05-2009	RP#44	RP-090540	186	Clarification for EVM. (Technically Endorsed CR in R4-50bis - R4-091512)	8.5.1	8.6.0
05-2009	RP#44	RP-090540	187	Removal of [ ] from band 17 Refsens values and ACS offset frequencies	8.5.1	8.6.0
05-2009	RP#44	RP-090540	191	Completion of band17 requirements	8.5.1	8.6.0
05-2009	RP#44	RP-090540	192	Removal of 1.4 MHz and 3 MHz bandwidths from bands 13, 14 and 17.	8.5.1	8.6.0
05-2009	RP#44	RP-090540	223	CR: 64 QAM EVM	8.5.1	8.6.0
05-2009	RP#44	RP-090540	201	CR In-band emissions	8.5.1	8.6.0
05-2009	RP#44	RP-090540	203	CR EVM exclusion period	8.5.1	8.6.0
05-2009	RP#44	RP-090540	204	CR In-band emissions timing	8.5.1	8.6.0
05-2009	RP#44	RP-090540	206	CR Minimum Rx exceptions	8.5.1	8.6.0
05-2009	RP#44	RP-090540	207	CR UL DM-RS EVM	8.5.1	8.6.0
05-2009	RP#44	RP-090540	218r1	A-MPR table for NS_07	8.5.1	8.6.0
05-2009	RP#44	RP-090540	205r1	CR In-band emissions in shortened subframes	8.5.1	8.6.0
05-2009	RP#44	RP-090540	200r1	CR PUCCH EVM	8.5.1	8.6.0
05-2009	RP#44	RP-090540	178r2	No additional emission mask indication. (Technically Endorsed CR in R4-50bis - R4-091421)	8.5.1	8.6.0
05-2009	RP#44	RP-090540	220r1	Spectrum emission requirements for band 13	8.5.1	8.6.0
05-2009	RP#44	RP-090540	197r2	CR on aggregate power tolerance	8.5.1	8.6.0
05-2009	RP#44	RP-090540	196r2	CR: Rx IP2 performance	8.5.1	8.6.0
05-2009	RP#44	RP-090541	198r1	Maximum output power relaxation	8.5.1	8.6.0
05-2009	RP#44	RP-090542	166	Update of performance requirement for TDD PDSCH with MBSFN configuration. (Technically Endorsed CR in R4-50bis - R4-091180)	8.5.1	8.6.0
05-2009	RP#44	RP-090542	175	Adding AWGN levels for some TDD DL performance requirements. (Technically Endorsed CR in R4-50bis - R4-091406)	8.5.1	8.6.0
05-2009	RP#44	RP-090542	182	OCNG Patterns for Single Resource Block FRC Requirements. (Technically Endorsed CR in R4-50bis - R4-091504)	8.5.1	8.6.0
05-2009	RP#44	RP-090542	170r1	Update of Clause 8: PHICH and PMI delay. (Technically Endorsed CR in R4-50bis - R4-091275)	8.5.1	8.6.0
05-2009	RP#44	RP-090543	183	Requirements for frequency-selective fading test. (Technically Endorsed CR in R4-50bis - R4-091505)	8.5.1	8.6.0

05-2009	RP#44	RP-090543	199	CQI requirements under AWGN conditions	8.5.1	8.6.0
05-2009	RP#44	RP-090543	188r1	Adaptation of UL-RMC-s for supporting more UE categories	8.5.1	8.6.0
05-2009	RP#44	RP-090543	193r1	Correction of the LTE UE downlink reference measurement channels	8.5.1	8.6.0
05-2009	RP#44	RP-090543	184r1	Requirements for frequency non-selective fading tests. (Technically Endorsed CR in R4-50bis - R4-091506)	8.5.1	8.6.0
05-2009	RP#44	RP-090543	185r1	Requirements for PMI reporting. (Technically Endorsed CR in R4-50bis - R4-091510)	8.5.1	8.6.0
05-2009	RP#44	RP-090543	221r1	Correction to DL RMC-s for Maximum input level for supporting more UE-Categories	8.5.1	8.6.0
05-2009	RP#44	RP-090543	216	Addition of 15 MHz and 20 MHz bandwidths into band 38	8.5.1	8.6.0

---

## History

<b>Document history</b>		
V8.2.0	November 2008	Publication
V8.3.0	November 2008	Publication
V8.4.0	January 2009	Publication
V8.5.1	April 2009	Publication
V8.6.0	July 2009	Publication